

OLYMPUS®

DIGITAL VOICE
RECORDER

WS-320M

WS-310M

WS-300M

INSTRUCTIONS

EN INSTRUCTIONS

FR MODE D'EMPLOI

ES INSTRUCCIONES

Thank you for purchasing an Olympus
Digital Voice Recorder.

Please read these instructions for information
about using the product correctly and safely.
Keep the instructions handy for future reference.

To ensure successful recordings, we recommend that
you test the record function and volume before use.

EN

Table of Contents

Table of Contents	2
Safe and Proper Usage	4
General Precautions	4

1 Getting Started

Main Features	6
Identification of Parts	8
Inserting Battery	10
Power Supply	11
Setting Time/Date (Time&Date)	12
Switching Between the Voice Recorder and Music Player	14

2 When Using the Recorder as a Voice Recorder

Recording	15
Using the Variable Control Voice Actuator (VCVA)	18
Recording Modes (Rec Mode)	20
Microphone Sensitivity (Mic Sense)	21
Recording from External Microphone or Other Devices	22

Playing	24
Continuous Playback (All Play)	28
Repeat Playback	29
Auto Backspace Review (Back Space)	31
Index Marks	32
Locking Files (Lock)	34
LCD Display Information	36
Menu List (VOICE mode)	38

3 Using the Recorder on Your PC

Saving Files in Your PC	40
Operating Environment	41
Connecting to Your PC	42

4 Using the Recorder as a Music Player

Using the Recorder as a Music Player ...	44
Using Windows Media Player	44
Window Names	45
Copying Music from CD	47
Transferring Music File to the Recorder	48
About the Music Folders	51

Music Playback	53
Selecting Play Mode (Play Mode)	58
Repeat Playback (Repeat)	59
Random Playback (Random)	60
Increasing the WOW Effect (WOW)	61
Selecting Equalizer (EQ)	63
Moving the Tracks (Move)	66
Menu List (MUSIC mode)	68

5 Feature Common to the Voice Recorder and Music Player

Erasing	70
Hold	73
Menu Setting Method	74
System Sounds (Beep)	76
Backlight (Backlight)	77
LCD Contrast Adjustment (Contrast)	78
Formatting the Recorder (Format)	79

6 Other Practical Use Methods

Using as External Memory of the Computer	81
---	----

7 Other Information

Alarm Message List	82
Troubleshooting	83
Accessories (optional)	84
Specifications	85
Technical Assistance and Support	87

1

2

3

4

5

6

7

Safe and Proper Usage

Before using your new recorder, read this manual carefully to ensure that you know how to operate it safely and correctly. Keep this manual in an easily accessible location for future reference.

- The warning symbols indicate important safety related information. To protect yourself and others from personal injury or damage to property, it is essential that you always read the warnings and information provided.

General Precautions

- **Do not leave the recorder in hot, humid locations such as inside a closed automobile under direct sunlight or on the beach in the summer.**
- **Do not store the recorder in places exposed to excessive moisture or dust.**
- **Do not use organic solvents such as alcohol and lacquer thinner to clean the unit.**
- **Do not place the recorder on top of or near electric appliances such as TVs or refrigerators.**
- **Avoid recording or playing back near cellular phones or other wireless equipment, as they may cause interference and noise. If you experience noise, move to another place, or move the recorder further away from such equipment.**
- **Avoid sand or dirt. These can cause irreparable damage.**
- **Avoid strong vibrations or shocks.**
- **Do not disassemble, repair or modify the unit yourself.**

- Do not operate the unit while operating a vehicle (such as a bicycle, motorcycle, or car).
- Keep the unit out of the reach of children.

<Warning regarding data loss>

Recorded content in memory may be destroyed or erased by operating mistakes, unit malfunction, or during repair work.

It is recommended to back up and save important content to other media such as a computer hard disk.

Battery

Warning

- Battery should never be exposed to flame, heated, short-circuited or disassembled.
- Do not attempt to recharge alkaline, lithium or any other non-rechargeable battery.
- Never use any battery with a torn or cracked outer cover.
- Keep battery out of the reach of children.
- If you notice anything unusual when using this product such as abnormal noise, heat, smoke, or a burning odor.
 - ① remove the battery immediately while being careful not to be injured.
 - ② call your dealer or local Olympus representative for service.

Main Features

This product is equipped with the following features.

- Dual function recorder as a Digital Voice Recorder and a Digital Music Player. (☞ P.15,44)
- Connecting this recorder directly to the USB port links up with your PC. The data can be transferred or saved without USB cable or driver software. (☞ P.42)
- This USB storage class support recorder can be utilized as external memory to read and save the data. (☞ P.81)
 - By connecting the computer with the USB, pictures, text data, etc. can be saved, and utilized to carry data.
- It has a backlight full-dot display (LCD display screen). (☞ P.9)

Main Features of the Digital Voice Recorder

- The recorder stores highly compressed WMA format voice messages in integrated flash memory. (☞ P.15)
- By using the built-in stereo microphone, a stereo recording mode, which is ST HQ (Stereo High Quality), and 3 types of monaural recording modes, which are HQ (High Quality), SP (Standard Playback), and LP (Long Playback) can be selected. (☞ P.20)

Recording time

• WS-320M (1 GB)*1

ST HQ mode:	35 hours 25 minutes
HQ mode:	70 hours 50 minutes
SP mode:	139 hours 30 minutes
LP mode:	277 hours 20 minutes

• WS-310M (512 MB)*1

ST HQ mode:	17 hours 40 minutes
HQ mode:	35 hours 20 minutes
SP mode:	69 hours 30 minutes
LP mode:	138 hours 15 minutes

• WS-300M (256 MB)*1

ST HQ mode:	8 hours 45 minutes
HQ mode:	17 hours 30 minutes
SP mode:	34 hours 35 minutes
LP mode:	68 hours 45 minutes

- The five folders can hold 199 files each, for the maximum of 995 recordings. (P.15)
- It has a built-in Variable Control Voice Actuator (VCVA) function. (P.18)
- You can insert or delete index marks.*2 (P.32)
- The playback speed can be controlled as preferred. (P.25)

Main Features of the Digital Music Player

- You can play back music files in WMA and MP3 format. (P.53)

Playback time

WS-320M (1 GB):	13 hours 20minutes to 45hours 20 minutes
-----------------	---

WS-310M (512 MB):	6 hours 40minutes to 22hours 40 minutes
-------------------	--

WS-300M (256 MB):	3 hours 20minutes to 11hours 20 minutes
-------------------	--

- Has built-in WOW. (P.61)
- You can change the playback equalizer settings. (P.63)

*1 Available recording time may be shorter if many short recordings are made. (The displayed available recording time and recorded time are approximate indications.)

*2 For WMA files, these functions are only available for files recorded with this recorder or the IC recorders from Olympus.

IBM and PC/AT are the trademarks or registered trademarks of International Business Machines Corporation.

Microsoft, Windows and Windows Media are registered trademarks of Microsoft Corporation.

WOW, SRS and  symbol are trademarks of SRS Labs, Inc.

WOW technology is incorporated under license from SRS Labs, Inc.

MPEG Layer-3 audio coding technology licensed from Fraunhofer IIS and Thomson.

Other product and brand names mentioned herein may be the trademarks or registered trademarks of their respective owners.



Identification of Parts

1

Identification of Parts

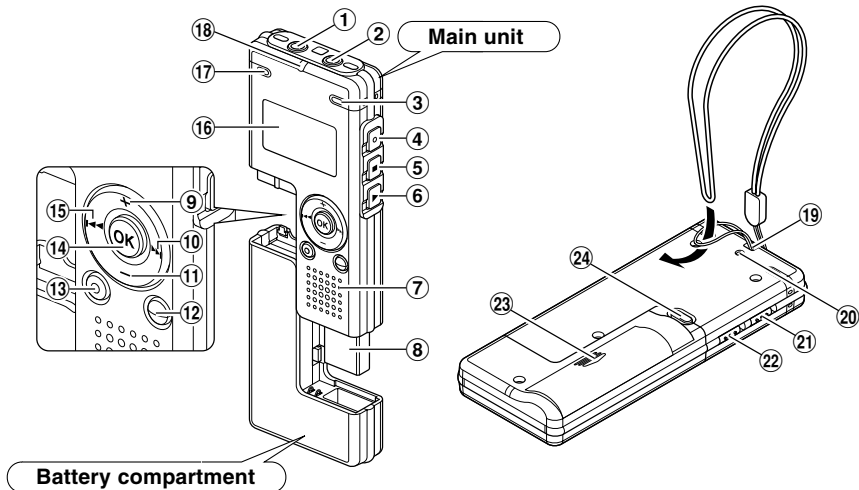

- ① EAR (Earphone) jack
- ② MIC (Microphone) jack
- ③ Built-in stereo microphone (R)
- ④ REC (Record) button
- ⑤ STOP button
- ⑥ PLAY button
- ⑦ Built-in speaker
- ⑧ USB terminal
- ⑨ VOL (+) button
- ⑩ ►►| button
- ⑪ VOL (-) button
- ⑫ FOLDER/INDEX button
- ⑬ ERASE button
- ⑭ OK button
- ⑮ ◀◀ button
- ⑯ Display (LCD panel)
- ⑰ Built-in stereo microphone (L)
- ⑱ Record/Play indicator light
- ⑲ Strap hole
- ⑳ USB access indicator light
- ㉑ HOLD switch
- ㉒ Mode (VOICE/MUSIC) switch
- ㉓ Battery cover
- ㉔ RELEASE (Release) button

8

Display (LCD Panel)

VOICE mode display

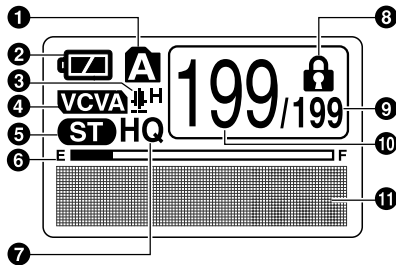

The display appears when recording.

MUSIC mode display

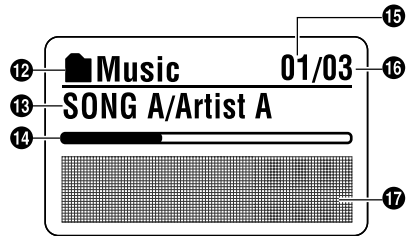

The display appears when indicating a file.

- ① Folder indicator
- ② Battery indicator
- ③ Microphone sensitivity indicator
- ④ VCVA (Variable Control Voice Actuator) indicator
- ⑤ Stereo indicator
- ⑥ Memory remaining indicator (E/F bar)
- ⑦ Record mode indicator
- ⑧ Erase lock indicator
- ⑨ Total number of recorded files in the folder

- ⑩ Current file number
- ⑪ Character information display
- ⑫ Folder name indicator
- ⑬ Title and artist name indicator
- ⑭ Play position bar indicator
- ⑮ Current music file number
- ⑯ Total number of recorded music files in the folder
- ⑰ Character information display

Inserting Battery

1

Inserting Battery

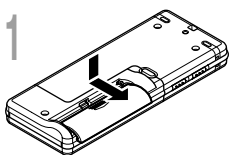

1 Lightly press down on the arrow and slide the battery cover open.

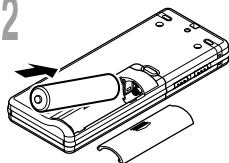

2 Insert size-AAA alkaline battery, observing the correct polarity.

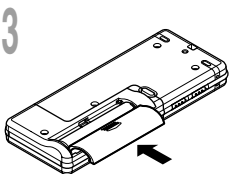

3 Close the battery cover completely.

Replacing the Battery

The battery indicator on the display changes as the battery loses power.



When  appears on the display, replace the battery as soon as possible.

When the battery is too weak, the recorder shuts down and “Battery Low” appears on the display. AAA alkaline battery is recommended.

Ni-MH Rechargeable Battery

An optional Ni-MH rechargeable battery from Olympus can be used for the recorder (P.84).

Notes

- Be sure to stop the recorder before replacing the battery. Unloading the battery while the recorder is in use may corrupt the file. If you are recording into a file and the battery runs out, you will lose your currently recorded file because the file header will not be able to close. It is crucial to change the battery once you see only one hash mark in the battery indicator.
- If it takes longer than 1 hour to replace the dead battery, you may have to reset the time when you load a fresh battery (P.12).
- Remove the battery if you are not going to use the recorder for an extended period of time.

Power Supply

When the recorder is not used, setting it to HOLD turns off the recorder, suppressing the consumption of the battery to a minimum. Even if the power is turned off, the existing data, settings of each mode, and clock setting will be maintained. To turn the power on, cancel the HOLD switch.

1

Power Supply

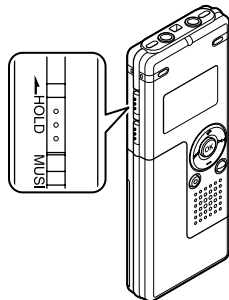

Turning Off the Power

Move the **HOLD** switch to the **HOLD** position while the recorder is not in operation.

After "Hold" is displayed, flashing for 2 seconds, the display will turn off.

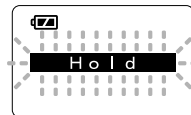

Turning On the Power

Release the **HOLD** switch of the recorder.

Standby Mode and Display Shut Off

If the recorder is stopped/not used for over 5 minutes after it is turned on, it goes into standby (power-save) mode, and the display shuts off. To exit standby mode and turn on the display, press any button.



Setting Time/Date (Time&Date)

1

Setting Time/Date (Time&Date)

If you set the date and time beforehand, the information when the file is recorded is automatically stored for each file. Setting the date and time beforehand enables easier file management.

The hour indicator will flash automatically when you load a battery before using the recorder for the first time, or after the recorder hasn't been used for a long time. Proceed from step 1.

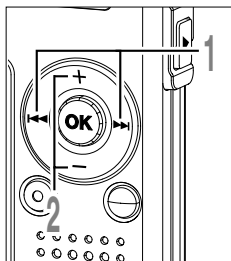

1 Press the ►► or ◄◄ button to select the item to set.

Select the item from "hour", "minute", "year", "month" and "day" with a flashing point.

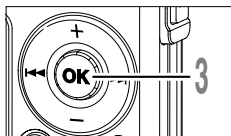
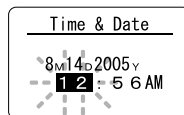

2 Press the + or - button to set.

Follow the same steps by pressing the ►► or ◄◄ button to select the next item, and press the + or - button to set.

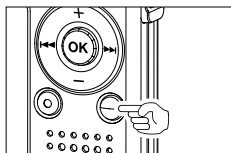
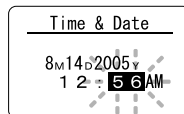

3 Press the OK button to complete the setup screen.

The clock will start from the set date and time. Press the OK button according to the time signal.

- You can choose between 12 and 24 hour display by pressing the FOLDER/INDEX button while setting the hour and minute.

Example: 5:45 P.M.

5:45 PM ↔ 17:45

(Initial setting)

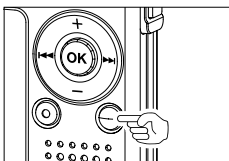

- You can choose the order of the year, month, day by pressing the FOLDER/INDEX button while setting them.

Example: August 14, 2005

8M 14D 2005Y → 14D 8M 2005Y → 2005Y 8M 14D
(Initial setting)

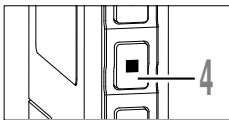

4 Press the STOP button to close the menu.

Note

- If you press the OK button during the setup operation, the recorder will save the items that were set to that point.

Changing the Time/Date

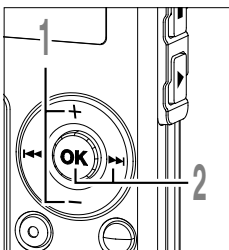

1 Press the + or - button in the sub menu screen, and select the "Time&Date".

See P.38, 68, 75 regarding the sub menu.

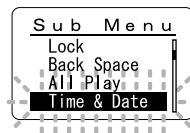

2 Press the OK or ►►► button.

The Time/Date screen appears. The hour indicator flashes, indicating the start of the Time/Date setup process.

Follow the same steps starting at step 1 in "Setting Time/Date" (P.12).

Switching Between the Voice Recorder and Music Player

1

Switching Between the Voice Recorder and Music Player

This device can be used as a voice recorder or as a music player.

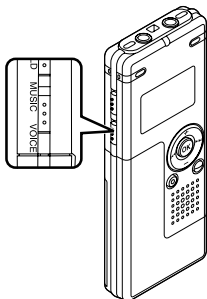

Using the mode switch, choose between **VOICE** and **MUSIC** option.

VOICE: For recording or playing back voice files.

MUSIC: For listening to music files.

Meaning of icons in this manual



Set the mode switch to **VOICE** before operating the recorder.



Set the mode switch to **MUSIC** before operating the recorder.



Convenient features that can be used with both the Voice Recorder and Music Player.



Recording

The recorder provides five folders, **A**, **B**, **C**, **D** and **E**, and each message recorded in a folder is saved as a Windows Media Audio (WMA) file. These five folders can be selectively used to distinguish the kind of recording; for example, Folder **A** might be used to store private information, while Folder **B** might be dedicated to holding business information. Up to 199 messages can be recorded per folder.

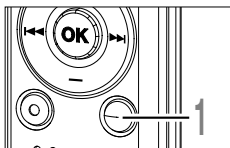

1 Press the **FOLDER** button to choose a folder.

- a Current folder
- b Current file number
- c Total number of recorded files in the folder

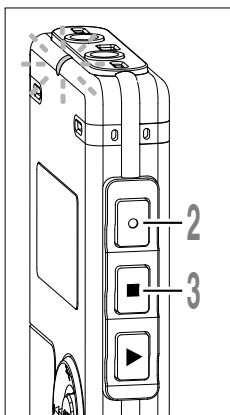
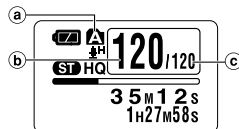

2 Press the **REC** button to start recording.

The record/play indicator light glows red. Turn the built-in stereo microphone in the direction to be recorded. The display changes depending on the recording mode (see P.20).

- d Current recording mode
- e Recording time
- f Memory remaining indicator (E/F bar)
(The bar indicates remaining memory)
- g Level meter (varies according to the sound volume being recorded)

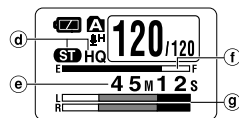

Display in the stereo recording mode

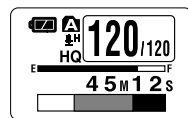

Display in the monaural recording mode

3 Press the **STOP** button to stop recording.

You can change the display patterns (see P.36). The displays indicated in this manual are default.

Notes

- To ensure recording from the beginning, start speaking after you see the red record/play indicator light on.
- A beep will sound when remaining recording time reaches 60 seconds, 30 seconds, and 10 seconds while recording.
- When remaining recording time is less than 60 seconds, the record/play indicator light starts flashing in red. When the recording time is decreasing to 30 or 10 seconds, the light flashes faster.
- “Memory Full” or “Folder Full” will be displayed when the memory or folder capacity is full. Delete any unnecessary files before recording any further (P.70).

Pause

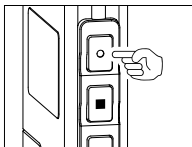

Press the **REC** button while recording.

➔ “Rec Pause” will flash on the display.

- The recorder will time out after 1 hour when left in “Rec Pause”.

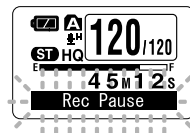

Resume Recording

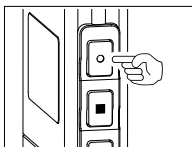

Press the **REC** button again.

➔ Recording will resume at the point of interruption.

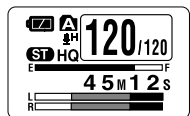

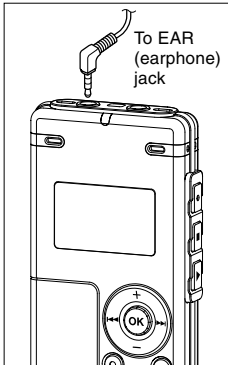

Listening While Audio is Recorded (Recording Monitor)

If you start recording after inserting the earphone into the EAR jack on the recorder, you can hear the sound being recorded. The sound volume on the recording monitor can be adjusted by pressing the VOL (+) or VOL (-) button.

Connect the earphone to the EAR jack on the recorder

- After recording is started, you can hear the sound being recorded through the earphone. If the earphone is connected, no sound will come from the speaker.

Notes

- Recording level cannot be controlled using the volume button.
- When using the earphones, do NOT set the volume too high. Listening at very high volume may lead to hearing loss.



Using the Variable Control Voice Actuator (VCVA)

2

Using the Variable Control Voice Actuator (VCVA)

When the microphone senses that sounds have reached a preset threshold volume level, the built-in Variable Control Voice Actuator (VCVA) starts recording automatically, and stops when the volume drops below the threshold level.

The VCVA feature extends recording time and conserves memory by stopping recording during silent periods, which helps the playback to be more efficient.

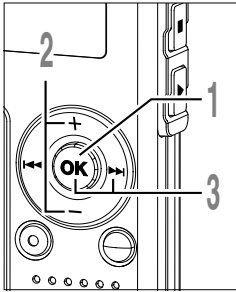

- 1 Press and hold the OK button for 1 second or longer.**

The menu opens (see P.38, 74).

- 2 Press the + or - button to choose "VCVA".**

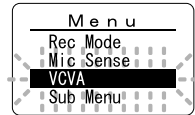

- 3 Press the OK or >>> button.**

The VCVA setup process begins.

- 4 Press the + or - button to choose between "On" and "Off".**

On: Will start recording in VCVA mode.
Off: Will resume recording in normal mode.

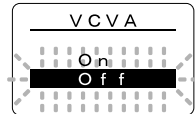

- 5 Press the OK or <<< button to complete the setup screen.**

- 6 Press the STOP or <<< button to close the menu.**

When "On" is selected, a VCVA indication will be displayed on the screen.



- a VCVA (Variable Control Voice Actuator) indicator**

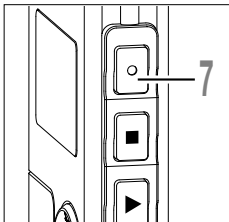

7 Press the REC button to start recording.

When the sound volume is lower than the preset threshold sound level, recording automatically stops after 1 sec approximately, and "Standby" flashes on the display. The record/play indicator light glows red when recording starts and flashes when recording pauses.

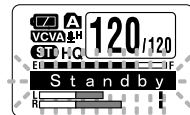

Adjust the Start/Stop Actuation Level

Press the ►► or ◀◀ button to adjust the pause sound level during recording.

The VCVA level can be set to any of 15 different values. The higher the value, the more sensitive the recorder to sounds. At the highest value, even the faintest sound will activate recording.

The VCVA pause sound level can be adjusted according to the ambient (background) noise.

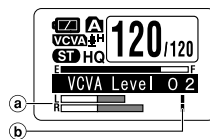

- a) **Level meter** (varies according to the sound volume being recorded)
- b) **Start level** (moves to the right/left according to the set level)

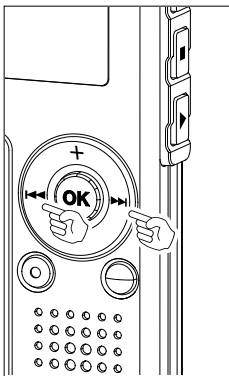

Notes

- The start/stop actuation level also varies depending on the selected microphone sensitivity mode (☞ P.21).
- If the starting level is not adjusted within 2 seconds, the display will return to the previous.
- If the surrounding noise is loud, the starting sensitivity of the VCVA can be adjusted according to the recording situation.
- To ensure successful recordings, prior testing and adjustment of the start/stop actuation level is recommended.



Recording Modes (Rec Mode)

The recording mode can be chosen from ST HQ (stereo high quality sound recording), HQ (high quality sound recording), SP (standard recording), and LP (long-term recording).

2

Recording Modes (Rec Mode)

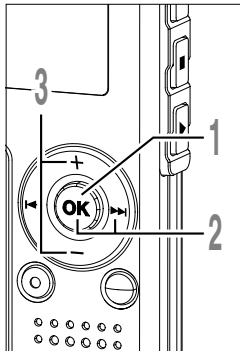

1 Press and hold the OK button for 1 second or longer.

“Rec Mode” will be displayed on the screen (see P.38, 74).

2 Press the OK or ►►► button.

The recording mode setup process begins.

3 Press the + or – button to choose from “ST HQ”, “HQ”, “SP” and “LP”.

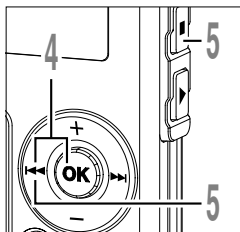
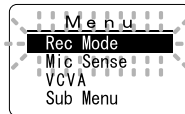

4 Press the OK or ◀◀◀ button to complete the setup screen.

5 Press the STOP or ◀◀◀ button to close the menu.

a Record mode indicator

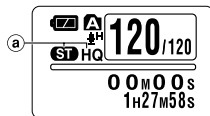
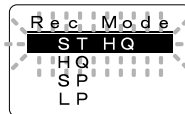

Notes

- When a meeting and lecture is to be recorded clearly, set other than LP mode to record.
- When the monaural microphone is inserted into the microphone jack in ST HQ mode, the sound will be recorded only in the L channel.



Microphone Sensitivity (Mic Sense)

Microphone sensitivity is adjustable to meet recording needs.

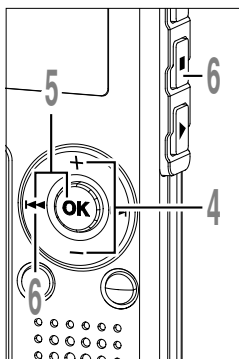
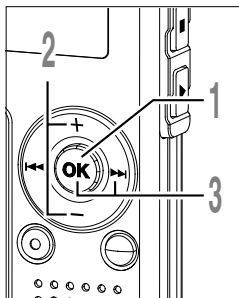

- 1 Press and hold the OK button for 1 second or longer.**

The menu opens (see P.38,74).

- 2 Press the + or - button to choose “Mic Sense”.**

- 3 Press the OK or ►► button.**

The microphone sensitivity setup process begins.

- 4 Press the + or - button to choose between “Conf” and “Dict”.**

Conf: High-sensitivity mode that records sounds in all directions.

Dict: Low-sensitivity mode suited for dictation.

- 5 Press the OK or ◀◀ button to complete the setup screen.**

- 6 Press the STOP or ◀◀ button to close the menu.**

a Microphone sensitivity display

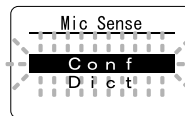
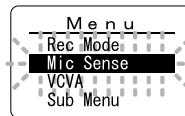

2

Microphone Sensitivity (Mic Sense)

Notes

- When the speaker's voice is to be recorded clearly, set to Dict (dictation) mode and move the built-in stereo microphone close to the speaker's mouth (5 to 10 cm / 2 to 4 inches) and record.
- If the ambient (background) noise is too loud to get a clear recording even in Dict (dictation) mode, we recommend that you use an ME12 single directional microphone (sold separately).



Recording from External Microphone or Other Devices

The external microphone and other devices can be connected and the sound can be recorded. Connect as follows by the device to be used.

2

Recording from External Microphone or Other Devices

To MIC
(microphone)
jack

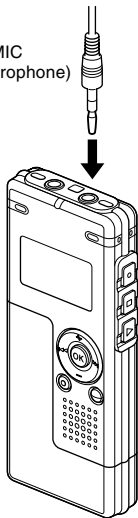

Recording with External Microphone

Connect the external microphone to the microphone jack of the recorder.

When the external microphone is connected to the microphone jack of the recorder, the built-in microphone will not operate.

Applicable External Microphones (optional)

- **Noise-cancellation monaural microphone: ME12 (Dictation microphone)**

This microphone is used to record your own voice while minimizing surrounding noise and suits for voice recognition.

- **Tie clip microphone: ME15 (monaural)**

Small concealing microphone with a tie-clip.

- **Telephone pickup: TP7 (monaural)**

Earphone type microphone can be plugged into your ear while phoning. The voice or conversation over the phone can be clearly recorded.

- **Stereo microphone: ME51S**

The high fidelity of the recording, which only stereo can perform. Furthermore, it gives clear sound quality with less noise. Stereo recording is possible only when it is set to ST HQ mode.

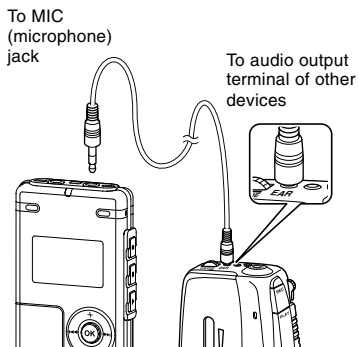

Recording the Sound of Other Devices with This Recorder

The sound can be recorded when connecting to the audio output terminal (earphone jack) of the other device, and the microphone jack of the recorder with the connecting cord (optional KA333)(^{REG} P.84) for dubbing.



Recording the Sound of This Recorder with Other Devices

The sound of this recorder can be recorded to other devices when connected to the audio input terminal (microphone jack) of other devices and the earphone jack of this recorder, with the connecting cord (optional KA333) for dubbing.

Notes

- The input level cannot be adjusted on this recorder. When you connect the recorder to an external device, execute a test recording and adjust the output level of the external device.
- A microphone with plug-in power, which receives the power supply from this recorder, can be used.
- Please do not insert/remove the cord to/from the jack of this recorder while recording.
- When the external stereo microphone is inserted while set in HQ, SP, and LP modes, it enables recording only with the L channel microphone.
- When the monaural microphone is inserted into the microphone jack in ST HQ mode, the sound will be recorded only in the L channel.



Playing

2

Playing

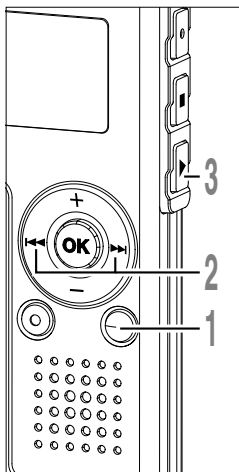

1 Press the FOLDER button to choose a folder.

2 Press the ►► or ◀◀ button to choose the file that you want to play.

If you keep pressing the ►► or ◀◀ button in stop mode, the recorder continuously skips to the beginnings of files.

3 Press the PLAY button to start playback.

The record/play indicator light glows green.

- a Play position bar indicator
- b Current playback time
- c Total recording time of the file being played

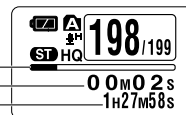
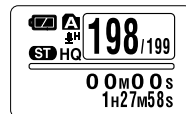

4 Press the + or - button to select the proper sound volume.

The display shows the volume level. You can choose between 0 and 30.

- d Volume level meter

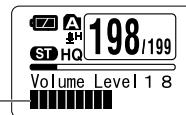

5 Press the STOP button at any point you want to stop the playback.

Resume playback by pressing PLAY button again.

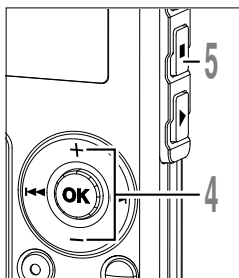

You can change the display patterns (P.36). The displays indicated in this manual are default.

Changing Playing Speed (Slow Playback/Fast Playback)

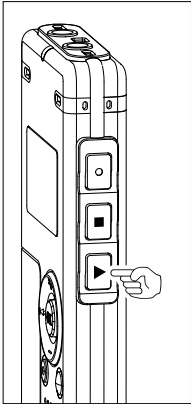

Press the **PLAY** button once while playing a file.

➔ You can change the playing speed.

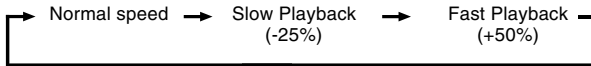
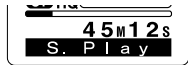

- As in normal playback, operations such as playback stop, file cueing, and index mark (P.32) insertion are possible in slow playback and fast playback.
- When the slow playback mode is selected, the "S.Play" appears and, for the fast playback mode, "F.Play" appears on the display while the recorder is playing back.
- The recorder stops playing when you press the STOP button while playing back in the slow/fast mode, or when it reaches to the end of the file. If you press the STOP button once and start playback again, the recorder will play back files in normal speed as well.
- During fast playback/slow playback, it will be played back in monaural even though the file was recorded in ST HQ mode.

Forwarding and Rewinding

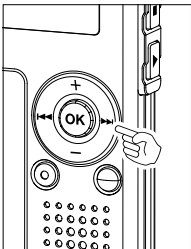

Fast Forward

Press and hold the ►►I button while playing a file.

➔ When you release the ►►I button, the recorder will resume normal playback.

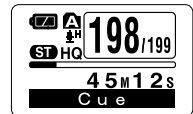

- When the index mark is shown in the middle of a file, it will stop temporarily in the position of the index mark.
- The recorder stops when it reaches the end of the file. Continue pressing the ►►I button to proceed with the cue from the beginning of the next file.

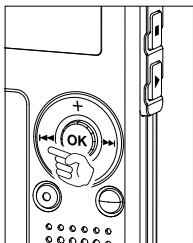

Rewind

Press and hold the **◀◀** button while playing a file.

➔ When you release the **◀◀** button, the recorder will resume normal playback.

- When the index mark is shown in the middle of a file, it will stop temporarily in the position of the index mark.
- The recorder stops when it reaches the beginning of the file. Continue pressing the **◀◀** button to proceed with the review from the end of the previous file.



Locating the Beginning of the File

Press the **▶▶|** button during playback, slow playback, or fast playback.

➔ The next file is cued and playback starts at the original speed.



Press the **◀◀** button during playback, slow playback, or fast playback.

➔ The file being played is cued and playback starts at the original speed.*



Press the **◀◀** button 2 times during playback, slow playback or fast playback.

➔ The previous file is cued, and playback starts at the original speed.*

- When the index mark is shown in the middle of a file, playback starts at the position of the index mark.

* If the previous playback is set (Ⓜ P.31), the recorder will playback in reverse skip for the set time.



When Playing Back or Fast Forwarding to the End of the Last File

When it reaches to the end of the last file, "End" will flash for 5 seconds, and stops at the starting position of the last file. While "End" is flashing, the following operation can be executed.

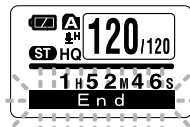

- If you press the ◀◀ button, the recorder will start playback in reverse skip returning to whichever closer, the starting position of the last file or the index mark. When the previous playback is set to "On", it will be played in reverse skip only for the set time of the previous playback.
- If you press and hold the ◀◀ button, the recorder will start fast rewind from the end of the last file, and start playback from the point the button is released.
- If you press the ▶▶ button, the recorder will skip to the starting position of the head file and stop.
- If you press and hold the ▶▶ button, the recorder will skip to the starting position of the head file, and stop at the position the button is released.

Playback Through Earphone

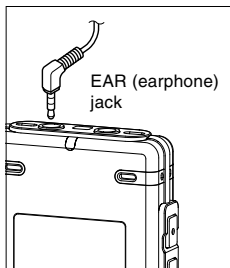

An earphone can be connected to the EAR jack of the recorder for listening.

- ➔ When the earphone is used, the recorder speaker will be switched-off.

Notes

- To avoid irritation to the ear, insert the earphone after turning down the volume level.
- When you listen with the earphone during playback, do not raise the volume too much. It may cause hearing impairment and decrease in hearing ability.



Continuous Playback (All Play)

This function allows you to listen to all your recordings of one folder in one go without any stop between the files.

2

Continuous Playback (All Play)

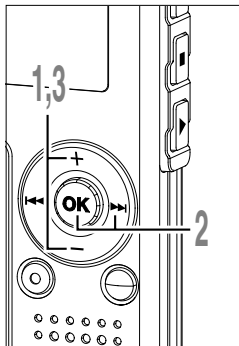

1 Press the + or – button in the sub menu screen, and select the “All Play”.

See P.38, 75 regarding the sub menu.

2 Press the OK or ►► button.

The continuous playback setup process begins.

3 Press the + or – button to choose between “On” and “Off”.

On: Continuous playback.

Off: Returns to playback with stop between single files.

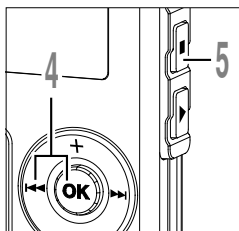
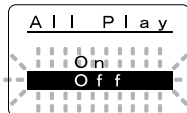
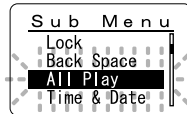

4 Press the OK or ◀◀ button to complete the setup screen.

5 Press the STOP button to close the menu.

Note

- After playback of last file in the folder, “End” appears on the screen and playback stops automatically.



Repeat Playback

This function enables repeated playback of part of the file being played.

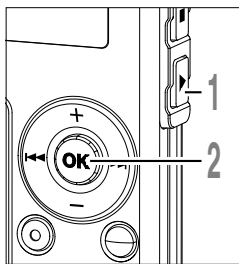

1 Choose the file for Repeat Playback, and press the **PLAY** button.

File playback begins.

2 Press and hold the **OK** button for 1 second or longer.

“↶ Start?” will flash on the display.

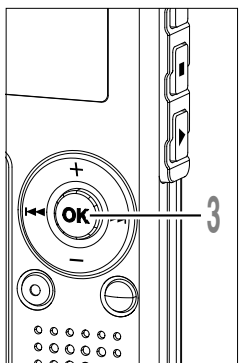
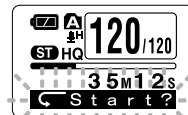

3 Press the **OK** button briefly at the point you want to start Repeat Playback.

“↶ End?” will flash on the display.

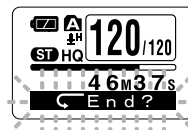

Even while “↶ Start?” and “↶ End?” are flashing, changing the playback speed (P.25), fast forward and rewind (P.25) can be executed the same as during normal playback, and it can be advanced quickly to the start or end position.

When it reaches to the end of the file while “↶ End?” is flashing, the point will become the end position, and repeat playback will start.

2

Repeat Playback

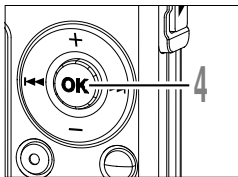

4 Press the **OK** button briefly again at the position you want repeat playback to end.

The recorder repeatedly plays back the section between the start and the end positions until you cancel repeat playback.



The playback speed (P.25) can be set during repeat playback as well as normal playback. If an index mark (P.32) is inserted or deleted during repeat playback, repeat playback will be cancelled and return to the normal playback.

Cancel the Continuous Playback Function



Press the **OK** button.

- Pressing the OK button will release repeat playback and continue playback.

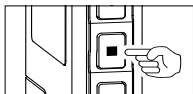

Press the **STOP** button.

- Pressing the STOP button will release repeat playback and stop playback.



Press the **▶▶** button.

- Pressing the ▶▶ button will release repeat playback and fast forward and cue to the beginning of the next file.



Press the **◀◀** button.

- Pressing the ◀◀ button will release repeat playback and rewind and reverse to the beginning of the current file.



Auto Backspace Review (Back Space)

To ease the reviewing of a voice file you can set an auto backspace for either 1 or 2 seconds, so you will listen to the last phrase repeatedly.

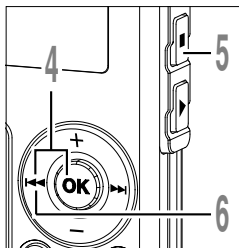
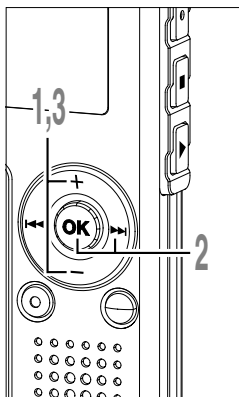

- 1 Press the + or - button in the sub menu screen, and select the “Back Space”.**

See P.38, 75 regarding the sub menu.

- 2 Press the OK or >>> button.**

The auto backspace review setup process begins.

- 3 Press the + or - button to choose from “Off”, “1 Sec” and “2 Sec”.**

Off: Perform normal cueing.

1 Sec: Start playback from 1 second before.

2 Sec: Start playback from 2 seconds before.

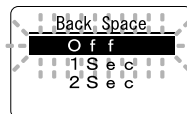
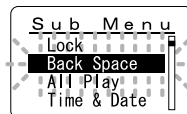

- 4 Press the OK or <<< button to complete the setup screen.**

- 5 Press the STOP button to close the menu.**

- 6 Press the <<< button while the file is being replayed.**

Playback starts at the set point of seconds before.

Note

- If “1 Sec” or “2 Sec” is set at the previous playback, and even though the <<< button is pressed, it does not reverse skip to the cue or the index mark position. Reverse skip is executed for only the set time (1 or 2 seconds).



Index Marks

Index marks can be placed in a file during recording or playback to provide a quick and easy way of keeping track of important sections in the file.

2

Index Marks

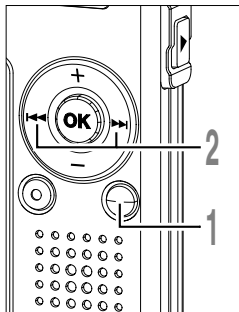

Setting an Index Mark

- 1 Press the **INDEX** button during recording or playback to set an index mark.

An index number appears on the display.

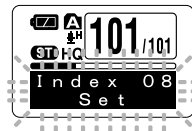

Locating an Index Mark

- 2 Hold the **▶▶** or **◀◀** button while playing a file.

The recorder stops for 1 second when it reaches the index mark.

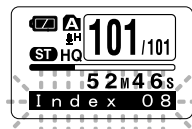

Clearing an Index Mark

- 3 Locate the index mark you want to clear.

- 4 Press the **ERASE** button while the index number appears for approximately 2 seconds on the display.

The index mark is erased.



Notes

- Up to 16 index marks can be set in a file. Attempting to set more index marks will cause “Index Full” to appear on the display.
- Index marks cannot be set or cleared in a locked file (☞ P.34).
- The index marks can only be placed in WMA files recorded with OLYMPUS recorder .
- If the **I◀** button is pressed in the set status of “1 Sec” or “2 Sec” in the previous playback, it will reverse skip for only the set time.



Locking Files (Lock)

Locking a file keeps important data from being accidentally erased.
Locked files are not erased when you choose to erase all files from a folder (P.71).

2

Locking Files (Lock)

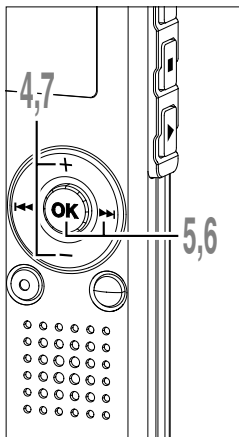
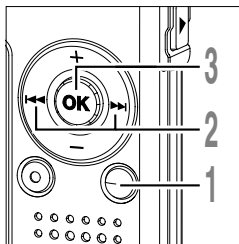

1 Press the **FOLDER** button to choose a folder.

2 Press the **▶▶** or **◀◀** button to choose the file you want to lock.

3 Press and hold the **OK** button for **1 second or longer**.
The menu opens (P.38,74).

4 Press the **+** or **-** button to choose “Sub Menu”.

5 Press the **OK** or **▶▶** button.
“Lock” will be displayed on the screen.

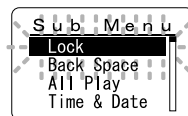

6 Press the **OK** or **▶▶** button.
The file locking setup process begins.

7 Press the **+** or **-** button to choose between “On” and “Off”.

On: Locks the file and prevents it from being erased.

Off: Unlocks the file and allows it to be erased.

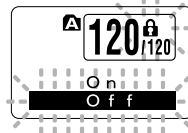

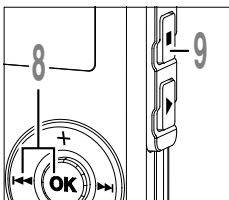

8 Press the **OK** or **←←** button to complete the setup screen.

9 Press the **STOP** button to close the menu.

^a Erase lock indicator

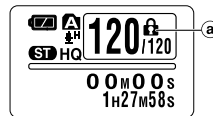

2

Locking Files (Lock)



LCD Display Information

You can select an option for the display of the recorder. This helps review and confirm different recorder settings and file information.

While in Stop or Playback Mode

2

LCD Display Information

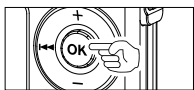

Press the OK button.

Each time the OK button is pressed, the recorder will display ① to ③ repeatedly. If there is no file, remaining recording time will be displayed.

① File length

(Count up indicator)

Indicates the length of the file and playback elapsed time with the bar and counting up.

② File length

(Count down indicator)

Indicates the length of the file and the remaining playback time with the bar and counting down.

③ Time stamp

Shows the time that the file was recorded.

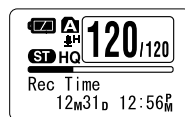
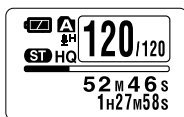
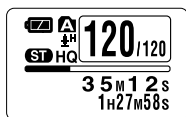

While in Stop Mode

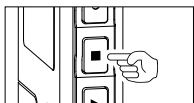

Press and hold the STOP button.

While the STOP button is being pressed down, ① and ② will be alternately displayed every second and will return to the previous display when the STOP button is released.

① Memory remaining

(Remaining time indicator)

Displays the remaining time available for recording with the numbers and remaining memory E/F bar.

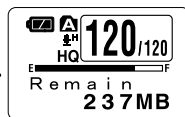
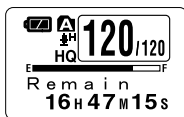

② Memory remaining

(Remaining memory indicator)

Displays the remaining memory available for recording with the numbers and remaining memory E/F bar.

While in Record Mode



Press the OK button.

Each time the OK button is pressed, ① and ② will be alternately displayed.

① Recording level meter

(Count up indicator)

Displays the audio input level with the meter at the bottom, remaining memory with the E / F bar and recording elapsed time with the counter.

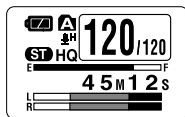

Display in the stereo recording mode

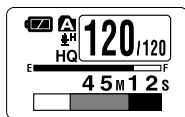

Display in the monoaural recording mode

② Recording level meter

(Count down indicator)

Displays the audio input level with the meter at the bottom, remaining memory with the E / F bar and remaining recording time with the count down.

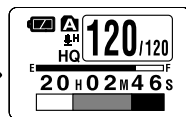
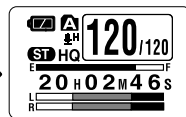

While in Recording in VCVA Mode



Press the OK button.

Each time the OK button is pressed, ① and ② will be alternately displayed.

① VCVA recording level meter

(Count up indicator)

Displays the audio input level and start level with the meter at the bottom, remaining memory with the E / F bar and recording elapsed time with the counter.

(Displays in "Standby" if it has not reached to the VCVA start level).



Display in the stereo recording mode

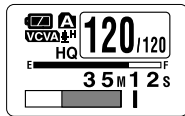

Display in the monoaural recording mode

② VCVA recording level meter

(Count down indicator)

Displays the audio input level and start level with the meter at the bottom, remaining memory with the E / F bar and remaining recording time with the count down.

(Displays in "Standby" if it has not reached to the VCVA start level).

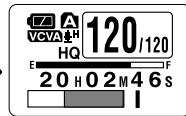
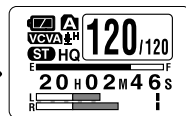



Menu List (VOICE Mode)

Menu

2

Menu List (VOICE Mode)

Press and hold the **OK** button for 1 second or longer.

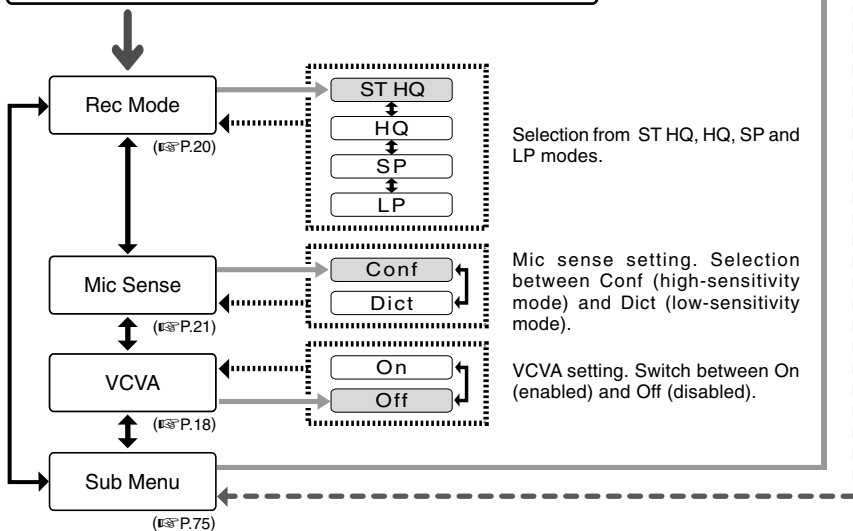

↕ : Press the **+** or **-** button.

→ : Press the **OK** or **▶▶|** button.

←..... : Press the **OK** or **◀◀|** button.

←- - : Press the **◀◀|** button.

← : Press the **OK** button.

←- : Press and hold the **OK** button for 1 second or longer.

▭ : Initial setting.

Notes

- If you press either of the STOP, REC or PLAY button during the setting, the previously set items will be applied and enters into the stop mode.
- The recorder will stop if you leave it idle for 3 minutes during a menu setup operation, when a selected item is not applied.

Sub Menu

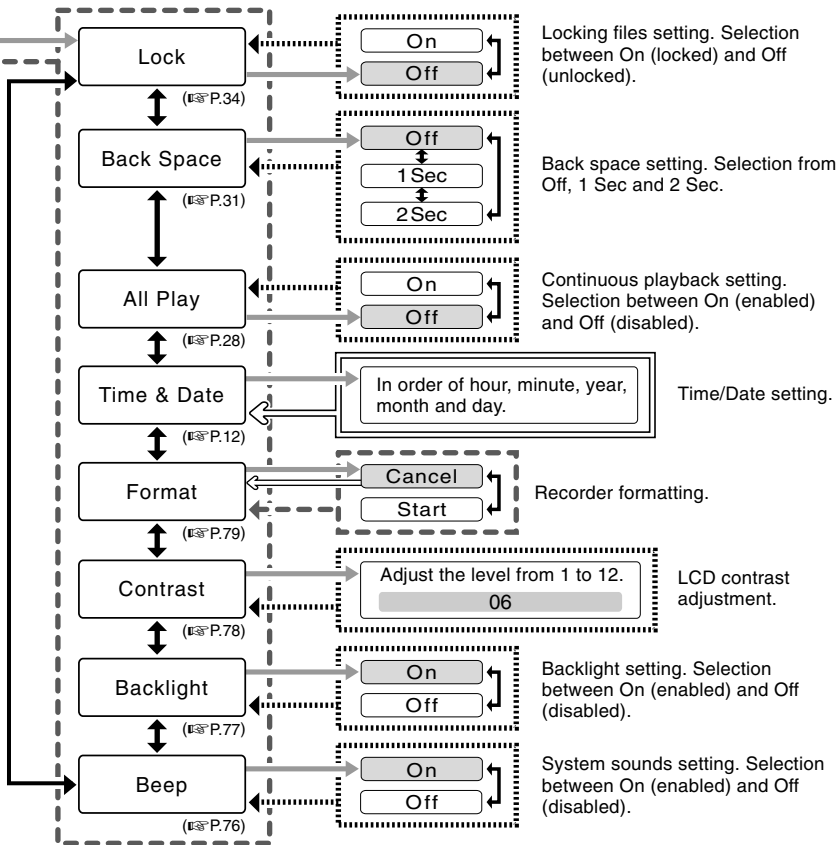

Saving Files in Your PC

By being connected to a PC, the recorder enables you to do the following:

- You can save (back-up) the files stored in the recorder on your PC. Also, you can transfer the files from your PC to the recorder.
- Playback voice files on your PC.

The voice file recorded by this recorder can be played on your PC using the Windows Media Player or the simplified playback software, DSS Player - Lite, which can be downloaded for free from the website of the Olympus. Using the DSS Player – Lite enables you to search the index marks that are marked on the voice files. Also, using the Windows Media Player, the stored WMA or MP3 files on your PC can be transferred and played back on this recorder.

OLYMPUS homepage : <http://www.olympus.com/>

Precautions on Using the Recorder Connected to a PC

- **When you are downloading a file from the recorder or uploading a file to the recorder, do not remove the USB connector even if the screen is indicating you can. Data is still being transferred while the record/play indicator light and USB access indicator light are blinking in red. When removing the USB connector, be sure to follow the description in P.43. If the USB connector is removed before the drive is stopped, data may not be successfully transferred.**
- **On a PC, do not format the drive of the recorder. Initialization is not successfully achieved on a PC. For initialization, follow the instructions in the Sub Menu screen of the recorder (P.79).**
- **Never make an operation such as deleting, moving or changing the name of this recorder's 5 voice folders (DSS_FLDA to DSS_FLDE), music folders (Music) or management files in each folder using the file management tool such as "Explorer". The order of files may be changed or files may become unrecognizable.**

Operating Environment

- **Data can be written or uploaded to the recorder even though the attribute of the recorder drive is shown as read only by the operating system of the PC.**
- **As the noise may cause adverse effects on electronics devices nearby the recorder, unplug the external microphone and earphone when you connect the recorder to a PC.**

PC:

IBM PC/AT compatible PC

Operating System:

Microsoft Windows Me/ 2000
Professional/XP Professional, Home Edition

USB port:

One free port

Others:

Internet environment when accessing to the music information site.

.....
Note

- USB ports are not supported on PCs running Windows 95, 98 or that have been upgraded from Windows 95, 98 to any other OS.

Connecting to Your PC

Connecting to Your PC

3

Connecting to Your PC

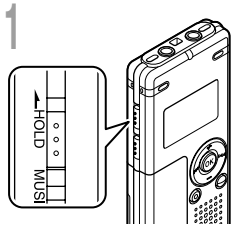

- 1** Slide the **HOLD** switch to the hold side, turn the recorder off.
The display will turn off.

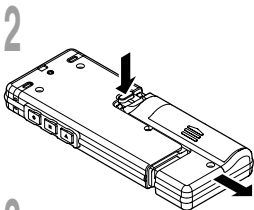

- 2** Detach the battery compartment pressing the **RELEASE** button of the rear side.

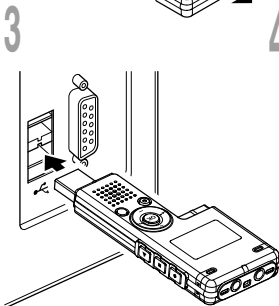

- 3** Connect the recorder's **USB** terminal to a PC **USB** port or **USB** hub.

"Remote" is displayed on recorder if the USB is connected.

Launch My computer, in the window, the recorder will appear as a removable disk.



- 4** Transfer the audio files to your computer.

The 5 folders of this recorder are displayed as "DSS_FLDA", "DSS_FLDB", "DSS_FLDC", "DSS_FLDD" and "DSS_FLDE", and the recorded voice files are saved in WMA format in these files.

You can copy them to any folder on your computer.

While transmitting data, "Busy" is displayed, and the record/play indicator light and USB access indicator light flashes red.

If you double-click on the file, Windows Media Player will be launched and playback will start.



Note

- If you are using Windows 2000, Windows Media Player must be installed on the PC.

Disconnecting to Your PC

- 1 Click the  on the task bar located at the lower-right corner of the screen. Click [Safely Remove Hardware].

It will read [Stop USB Disk-Drive] for Windows Me. The drive letter will differ depending on the computer being used.



- 2 When the safe to remove hardware window appears, click [OK].
- 3 Make sure that the display is turned off, disconnect the USB.

Notes

- NEVER disconnect the USB while the record/play indicator light and USB access indicator light are flashing in red. If you do so, the data may be destroyed.
- Refer to the user's manual for your PC regarding the USB port or USB hub on your PC.
- Be sure to push the USB connector all the way in. Otherwise, the recorder may not operate properly.
- Use the supplied USB extension cable depending on situations.

Using the Recorder as a Music Player

The recorder supports music files in WMA and MP3 formats, which can be transferred from the PC to the corresponding music folder of the recorder.

Using Windows Media Player

By using Windows Media Player, music files from music CDs can be converted (ripped) (P.47) and music files that you have bought from any music distribution sites can be easily transferred to the recorder (P.48).

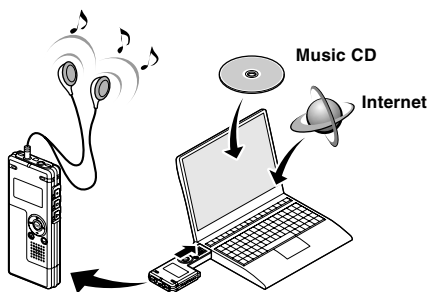

Copyright and Copyright Protection Feature (DRM)

By the Copyright Act, any voice/music files and music CDs downloaded from the Internet without the copyright holder's permission may not be reproduced, distributed, publicized/re-publicized on the Internet, or converted into WMA or MP3 files for the purpose of commercial business or sale.

A WMA file may be provided with DRM (Digital Right Management) for copyright protection. DRM limits the file to copy or distribute music files that are converted (ripped) from a music CD or downloaded from music distribution services. To transfer a WMA file with DRM to the recorder, you need to use appropriate methods such as Windows Media Player. Copying the music files with DRM purchased from online music distribution service to a portable device such as this recorder may be restricted.

Note

- This recorder is compatible with Microsoft Corporation PD-DRM, but not with JANUS.

Window Names

Windows Media Player 10

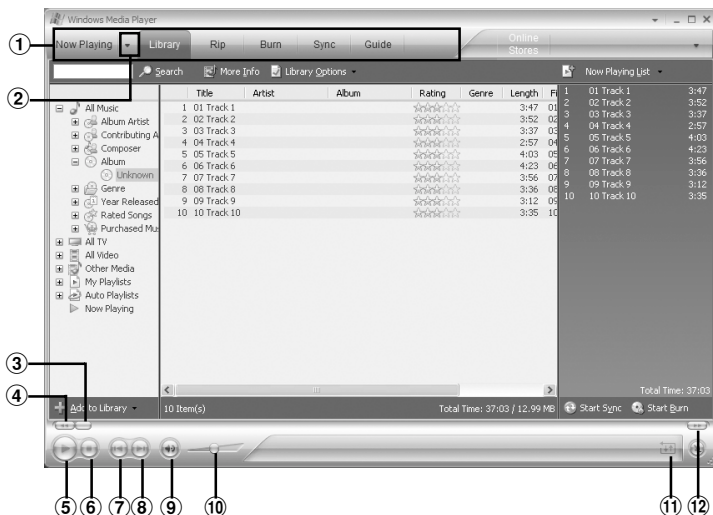

① Features taskbar

② Quick Access
Panel button

③ Seek slider

④ Rewind button

⑤ Play button

⑥ Stop button

⑦ Previous button

⑧ Next button

⑨ Mute button

⑩ Volume slider

⑪ Shuffle/Repeat button

⑫ Fast Forward button

Windows Media Player 9

4
Window Names

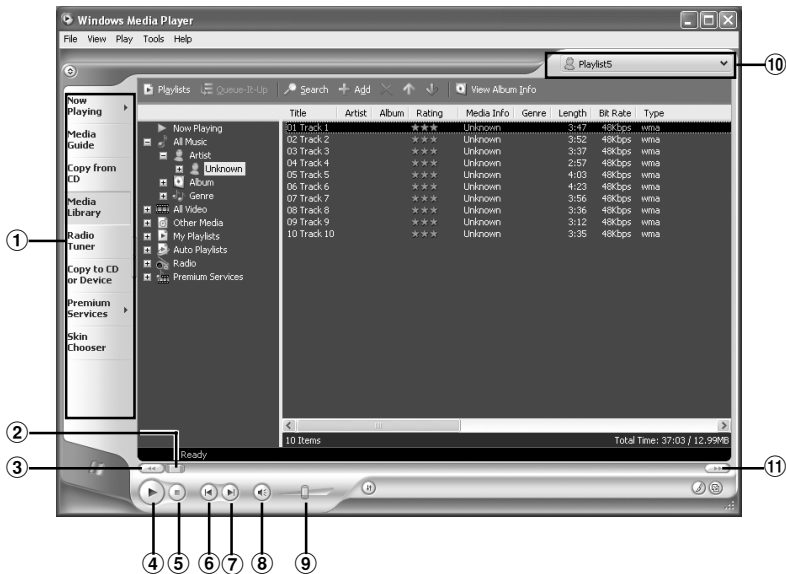

① Features taskbar

② Seek slider

③ Rewind button

④ Play button

⑤ Stop button

⑥ Previous button

⑦ Next button

⑧ Mute button

⑨ Volume slider

⑩ Quick Access box

⑪ Fast Forward button

Copying Music from CD

1 Insert CD into the CD-ROM drive and start Windows Media Player.

2 From the Features taskbar, click the [Rip] menu.

For Windows Media Player 9

From the Features taskbar, click the [Copy from CD] menu.

3 Click the [View Album Info].

If Internet connectivity is available, CD information is searched.

4 Put a check mark on the music file that you want to copy.

5 Click the [Rip Music].

For Windows Media Player 9

Click the [Copy Music].

Files copied to a PC are stored in WMA format. Music files copied are categorized by artist, album, genre, etc. and added to the play list.

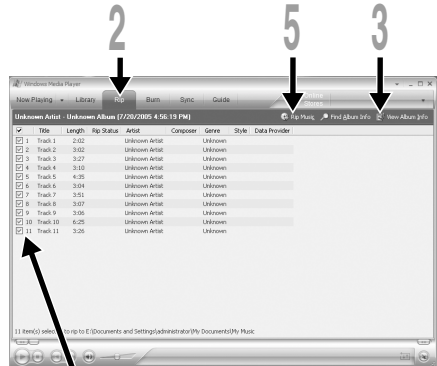

Windows Media Player 10

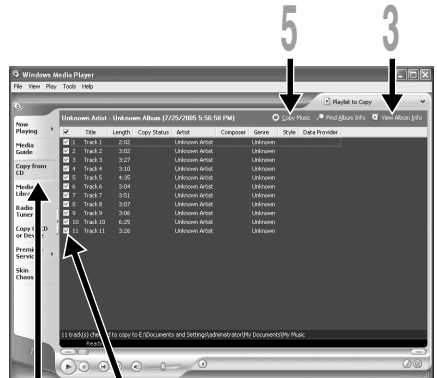

Windows Media Player 9

4

Copying Music from CD

Transferring Music File to the Recorder

You can transfer the music files saved in your PC to this recorder. For how to copy the music files from the CD to your PC, see “Copying Music from CD” (P.47).

Windows Media Player 10

4

Transferring Music File to the Recorder

1 Connect the recorder to a PC and start Windows Media Player.

2 From the Features taskbar, click the [Sync].

3 From the pull down menu on the left side window, select the play list to be transferred to the recorder and put the check marks on the music file that you want to transfer. The order of music pieces can be changed by Drag & Drop of the music file in the play list displayed.

4 From the pull down menu on the right side window, select the drive corresponding to the recorder. The recorder is recognized as a Removable Disk.

5 Click  on the upper right corner and set the synchronization options.

Click on the [Create folder hierarchy on device]* to check.*

The folder with artist name or album name is automatically created. This will make you find the file you want to listen to more easily.

* If [Create folder hierarchy on device] is checked by default, click to uncheck the box once, and click it again to check.

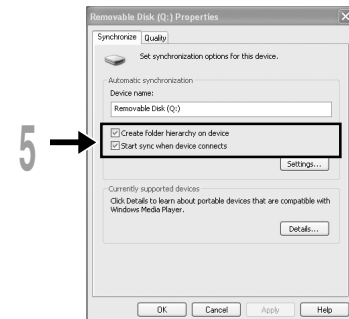
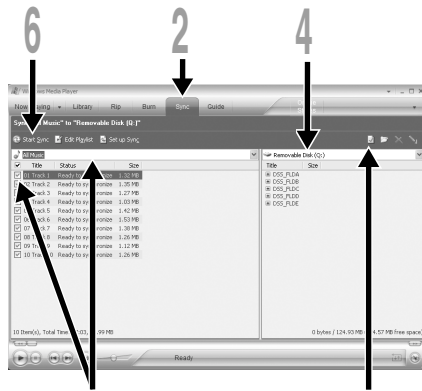

6 Click the [Start Sync].

The file is transferred to the recorder. The music file transferred to the recorder is displayed in Item on Device.

After transferring a language-learning file to the music folder, if you further transfer or copy the file to your desired voice folder (DSS_FLDA to DSS_FLDE) using a software like “Explorer”, you can use the functions such as partial repeat, fast playback, slow playback, and previous playback.

Windows Media Player 9

1 Connect the recorder to a PC and start Windows Media Player.

2 From the Features taskbar, click the [Copy to CD or Device] menu.

3 Select the play list to be transferred to the recorder and put the check marks on the music file that you want to transfer.

The order of music pieces can be changed by Drag & Drop of the music file in the play list displayed.

4 From Item on Device, select the drive corresponding to the recorder.

The recorder is recognized as a removable disk.

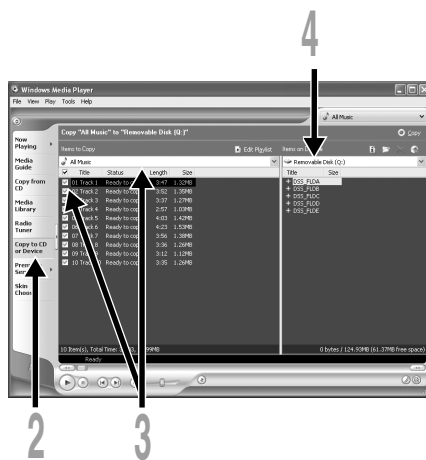

4

Transferring Music File to the Recorder

5 Select the destination folder.

To transfer to “Root” folder

The empty column part of the item on the device (Root of the drive) is selected.

To transfer to “Music” folder

Select the “Music” folder. Creating the “Artist name” folder or “Album name” folder beforehand will make the file management easier (The folders can be created in up to 2 layers in the “Music” folder.) (P.51).

To transfer to the voice folder

Select a folder from DSS_FLDA to DSS_FLDE. (Functions such as partial repeat, fast playback, slow playback and auto backspace review, available. They are useful for learning languages.)

6 Click the [Copy].

The file is transferred to the recorder. The music file transferred to the recorder is displayed in Item on the window.

Notes

- Copying the music files with DRM purchased online music distribution service to a portable device such as this recorder may be restricted.
- Refer to the online help of Windows Media Player for details.
- If the music files are transferred to the recorder until it reaches to the maximum memory, the message “Cannot make the system file. Connect to PC and delete unnecessary file” may appear on this recorder’s display. In such a case, erase the files to make free space (hundreds of KB to dozens of MB depending on the music file sizes) for the management file. (The more capacity for the management file will be necessary as the number of the music files increases.)





About the Music Folders

This recorder can save the music files (WMA, MP3 files) transferred from the PC in the 2 music folders, the original “Root” folder and its subsidiary “Music” folder.

Also, this recorder can create the folders in up to 2 layers within the “Music” folder. It is convenient to manage the multiple albums with the same artist name. Up to 199 files can be saved in each folder.

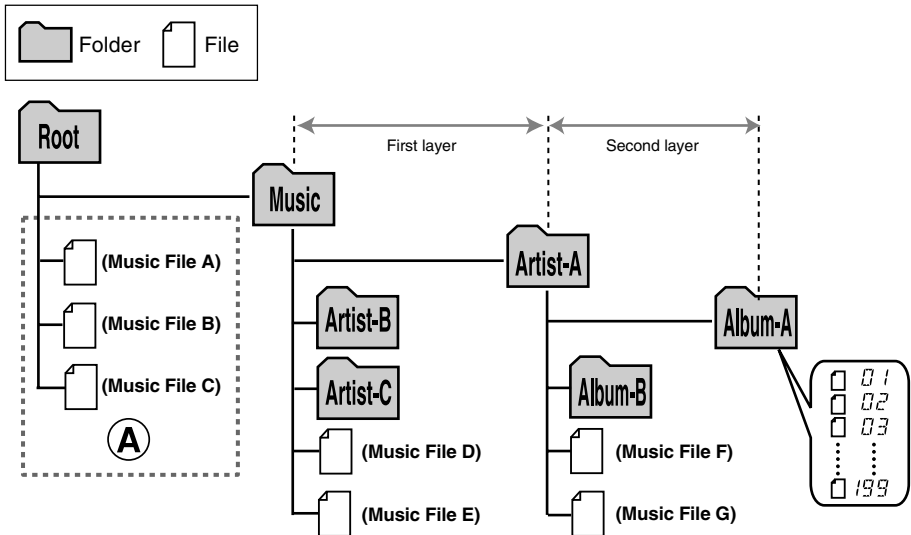

Notes

- Up to 128 folders including “Root” and “Music” folders can be operated on this recorder.
- When using Windows Media Player 10, click [Start Sync] instead of setting the synchronization options. All the files will be transferred to the part (A) above (P.48).

Selecting the Folders and Files

List display

The folders and files recorded in this recorder are displayed.

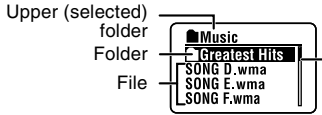

Scroll bar
(appears when the whole contents cannot be displayed)

File display

Information of the selected file is displayed.
Enters in playback standby mode.

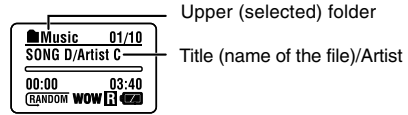

4

About the Music Folders

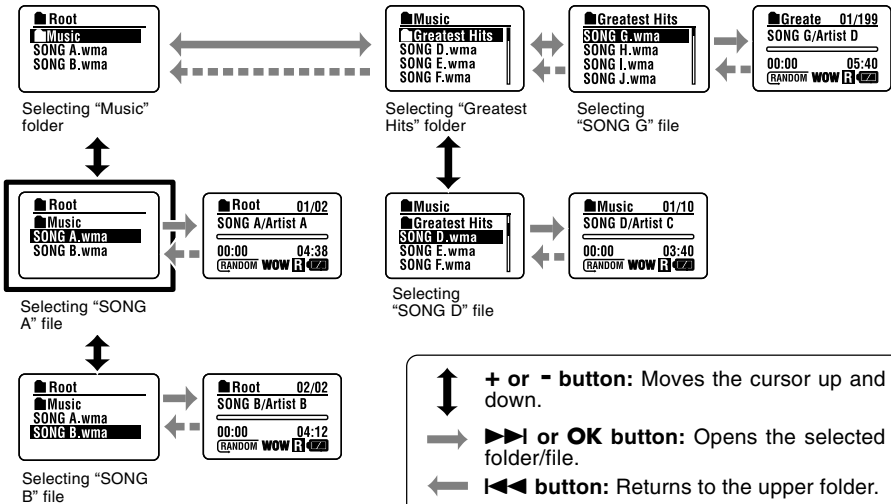



Music Playback

This recorder supports WMA and MP3 formats. To playback the music files using the music player, you need to transfer (copy) the corresponding music files from the PC to this recorder's folders for music (P.48).

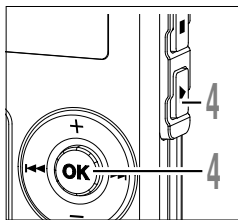
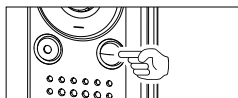
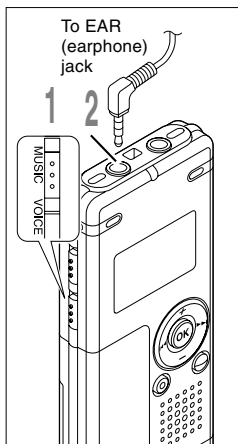

1 Set the Mode switch to **MUSIC**.

The folder list or file list is displayed.

2 Insert the stereo earphone into the **EAR (earphone) jack** of the recorder.

3 Select the music file that you want to play.

On the list display, place the cursor on the file you want to play, or change to the file display.

If you press and hold the ►► or ◀◀ button in the file display, the files within the current folder are cued continuously.

- a File being selected
- b Length of the file being selected

To return to the list display from the file display, or to return to the upper folder from the list display, press the FOLDER button.

4 Press the **PLAY** or **OK** button to start playback.

The title/artist name that cannot be displayed in one line is displayed scrolling to the left.

- c Play time of the file being played
- d Title and artist name of the file being played

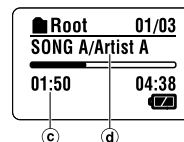
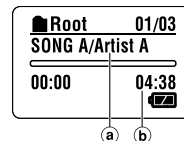
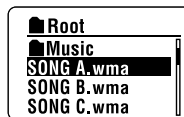

4

Music Playback

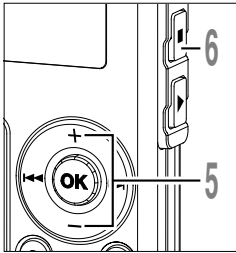

5 Press the + or - button to select the proper sound volume.

The display shows the volume level. You can choose between 0 and 30.

6 Press the STOP button at any point you want to stop the playback.

Resume playback by pressing PLAY or OK button again.

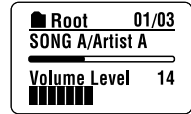

4

The next track will automatically start once the track being played is finished. Press and hold the STOP button while this recorder is in stop mode to display the remaining memory.



a Remaining memory indicator

When the Playback Reaches to the End of the Last File

When the playback reaches to the last file in the current folder, it returns to the starting position of the head file and stops. If you select "All" in "Play Mode" (P.58), all the files in this recorder can be played continuously.

Notes

- The proper bit rate for playback on the recorder is 5 kbps to 256 kbps for both the WMA and MP3 format.
- It is possible to play back MP3 files with different bit rates (converting the bit rate within one file); however, the displayed time may not be accurate.
- When using the earphones, do NOT set the volume too high. Listening at very high volume may lead to hearing loss.
- It is possible to listen to music without the earphones, using the internal speakers; however, the sound will be in mono, not stereo.
- Up to 40 characters per track can be used to list title and artist name.

Forwarding and Rewinding

Fast Forward

Press and hold the **▶▶|** button while playing a file.

➔ When you release the **▶▶|** button, the recorder will resume normal playback.

- The recorder stops when it reaches the end of the file. If you press and hold the **▶▶|** button, it continues fast forwarding within the playback range selected in the "Play Mode" (P.58). While "Random" (P.60) is set to "On", it continues fast forwarding of files randomly.

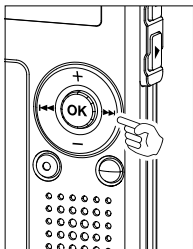
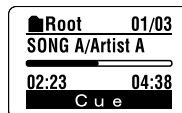

Rewind

Press and hold the **◀◀|** button while playing a file.

➔ When you release the **◀◀|** button, the recorder will resume normal playback.

- Once it reaches back to the starting position of the file, it stops. If you press and hold the **◀◀|** button, it continues rewinding within the playback range selected in the "Play Mode". While "Random" is set to "On", it continues the rewinding of files randomly.

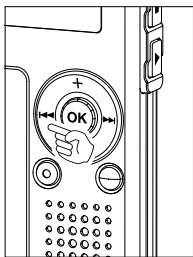
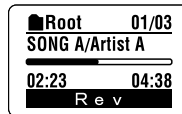

Skip a Music File While Playing It

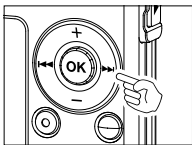

Press the ▶▶ button while playing a file.

- The recorder skips to the beginning of the next track and starts playing it.
- It cues within the playback range selected in "Play Mode" (P.58). If "Random" (P.60) is "On", it cues the next file randomly.

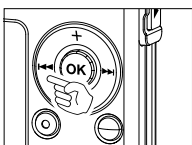

Press the ◀◀ button while playing a music file.

- The recorder skips to the beginning of the current track and starts playing it.

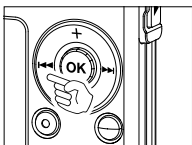

Press the ◀◀ button 2 times during playback.

- The previous file is cued, and playback starts at the original speed.
- If "Random" is "On", the files will be cued randomly.

When the Playback or Fast Forward Reaches to the End of the Last File

When the playback reaches to the end of the last file, it returns to the starting position of the head file and stops. If "Random" is "On", it returns to the starting position of the file that is randomly played and stops.

Menu Setting During Playback

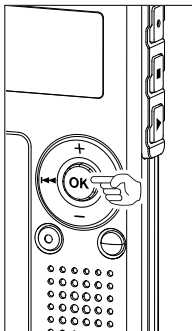

In music mode, the following functions relating playback are available. They can be set during playback.

Press the **OK** button while playing a file.

➤ You can enter the menu setting while continuing playback, and set the following relating playback. For how to set each menu, see the reference pages.

- During the setting, if you press the PLAY button or there is no operation made for 8 seconds, menu setting will be finished.

Play Mode:	Folder/All (P.58)
Repeat:	Off/On/Single (P.59)
Random:	On/Off (P.60)
WOW:	Functions (P.61)
EQ:	Functions (P.63)

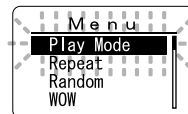



Selecting Play Mode (Play Mode)

You can set 2 kinds of play modes.

You can select either playing the tracks in a folder or playing all the tracks recorded in this recorder.

4

Selecting Play Mode (Play Mode)

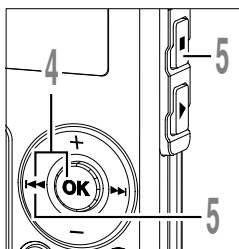
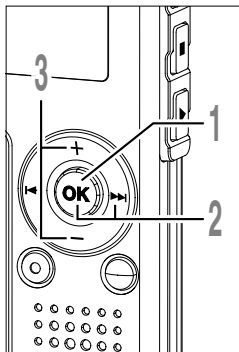

1 Press and hold the OK button for 1 second or longer.

“Play Mode” will be displayed on the screen (see P.68, 74).

2 Press the OK or ►► button.

The play mode setup process begins.

3 Press the + or – button to choose between “Folder” and “All”.

Folder: Plays the music files within the folder.

All: Plays all the music files recorded in the recorder.

4 Press the OK or ◀◀ button to complete the setup screen.

If you select “All”, “ALL” will appear on the display.

a Play mode indicator

5 Press the STOP or ◀◀ button to close the menu.

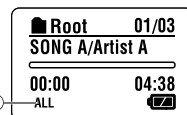
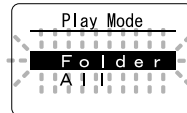
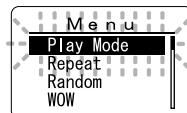

Notes

- If no operation is made for 3 minutes during the setting, it will return to the stop status.
- If “All” is selected, it plays the files within the folder, then starts playing the files in the next folder.



Repeat Playback (Repeat)

You can set the repeat playback of the music files within the range set in "Play Mode" (P.58).

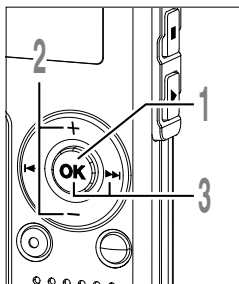

1 Press and hold the OK button for 1 second or longer.

The menu opens (P.68, 74).

2 Press the + or - button to choose "Repeat".

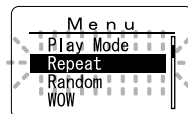

3 Press the OK or ►►► button.

The repeat setup process begins.

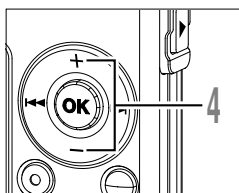

4 Press the + or - button to choose from "On", "Off" and "Single".

On: Repeats playback of the music files within the range set in "Play Mode".

Off: Cancels the setting.

Single: Repeats playback of the selected one file.

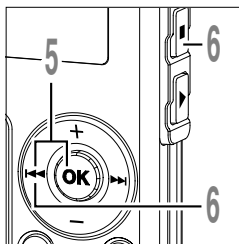
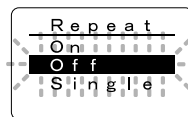

5 Press the OK or ◀◀◀ button to complete the setup screen.

An icon appears on the display according to the setting.

a Repeat playback indicator

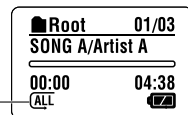

6 Press the STOP or ◀◀◀ button to close the menu.

4

Repeat Playback (Repeat)

Notes

- If no operation is made for 3 minutes during the setting, it will return to the stop status.
- If both "Repeat" and "Random" are set to "On", it repeats playback randomly.



Random Playback (Random)

You can set the random playback of the music files within the range set in “Play Mode” (P.58).

4

Random Playback (Random)

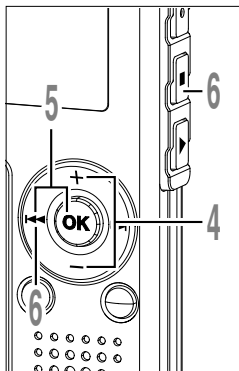
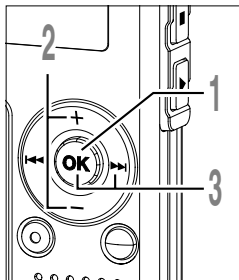

1 Press and hold the OK button for 1 second or longer.

The menu opens (P.68, 74).

2 Press the + or – button to choose “Random”.

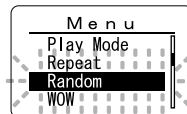

3 Press the OK or ►►► button.
The random setup process begins.

4 Press the + or – button to choose between “On” and “Off”.

On: Plays the music files within the range set in “Play Mode” randomly.

Off: Cancels the setting.



5 Press the OK or ◀◀◀ button to complete the setup screen.

An icon appears on the display according to the setting.

a Random playback indicator

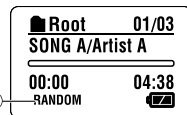

6 Press the STOP or ◀◀◀ button to close the menu.

Notes

- If no operation is made for 3 minutes during the setting, it will return to the stop status.
- If “All” is selected in “Play Mode”, all files in a folder are randomly played, then another folder will be randomly selected, and the files in the folder will be randomly played.
- If both “Repeat” and “Random” are set to “On”, it repeats playback randomly.



Increasing the WOW Effect (WOW)

The recorder has WOW, an audio processing technology that increases sound clarity and bass quality. The level of the surround effect (SRS 3D) and the bass effect (TruBass) may be individually adjusted through three levels of processing or turned off.

Surround effect (SRS 3D): Increases the sound-expansion effect and sound clarity.

Bass effect (TruBass): Enriches the low sounds.

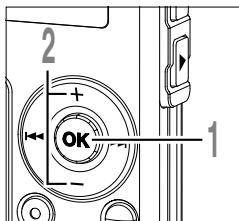

- 1 Press and hold the OK button for 1 second or longer.**

The menu opens (see P.68, 74).

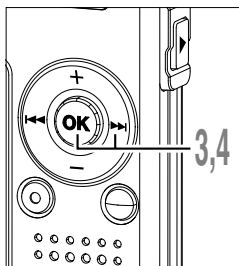

- 2 Press the + or - button to choose "WOW".**

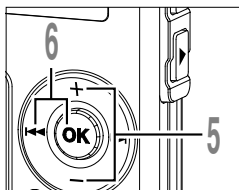
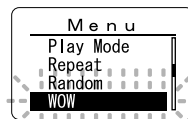

- 3 Press the OK or >>>I button.**
"SRS 3D" will be displayed on the screen.

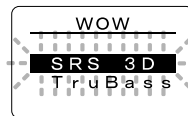

- 4 Press the OK or >>>I button again.**
The surround effect setup process begins (SRS 3D).

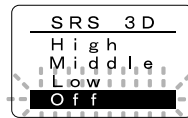

- 5 Press the + or - button to select the surround level.**

- 6 Press the OK or <<<I button to save your setting.**

Returns to the "SRS 3D" or "TruBass" selection display.

4

Increasing the WOW Effect (WOW)

Increasing the WOW Effect (WOW)

4

Increasing the WOW Effect (WOW)

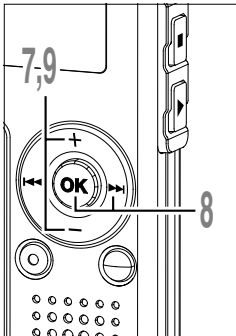

7 Press the **+** or **-** button to choose “TruBass”.

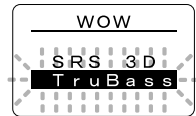

8 Press the **OK** or **▶▶** button.
The bass effect setup process begins (TruBass).

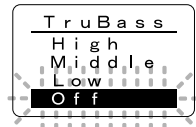

9 Press the **+** or **-** button to select the bass effect level.

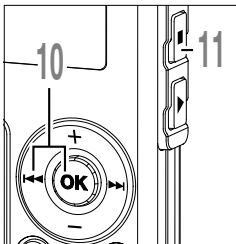

10 Press the **OK** or **◀◀** button to save your setting.
Returns to the “SRS 3D” or “TruBass” selection display.

11 Press the **STOP** button to close the menu.

a WOW indicator

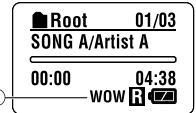

Notes

- If no operation is made for 3 minutes during the setting, it will return to the stop status.
- Both the surround effect and bass effect are Off as the WOW default settings.
- “WOW” will be displayed on the screen if the surround effect or the bass effect is set.
- The WOW effect will be weakened if the bit rate for any music file is less than 32 kbps.
- Depending on the song, the WOW effect will be heightened, and may sound like noise. If this happens, adjust the WOW effect.



Selecting Equalizer (EQ)

If you change the equalizer setting, you can enjoy the music with your favorite sound quality.

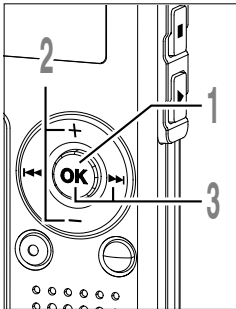

- 1 Press and hold the OK button for 1 second or longer.**

The menu opens (P.68, 74).

- 2 Press the + or - button to choose "EQ".**

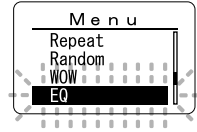

- 3 Press the OK or ►►► button.**
The equalizer setup process begins.

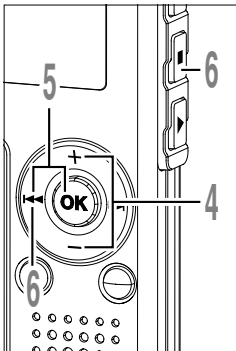

- 4 Press the + or - button to select the desired equalizer characteristics.**

Flat ↔ Rock ↔ Pop ↔ Jazz ↔ User

If you select "User", repeat the procedures from step 5 in P.64.

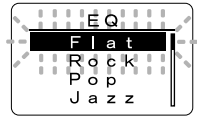

- 5 Press the OK or ◀◀◀ button to complete the setup screen.**

- 6 Press the STOP or ◀◀◀ button to close the menu.**

a Equalizer indicator

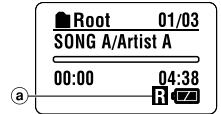

4

Selecting Equalizer (EQ)

Notes

- If no operation is made for 3 minutes during the setting, it will return to the stop status.
- The equalizer default setting is Flat.

When Changing the User Equalizer

You can customize your own equalizer by changing the User settings.

4

Selecting Equalizer (EQ)

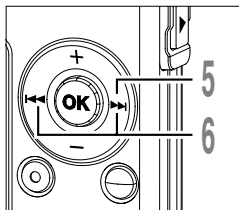
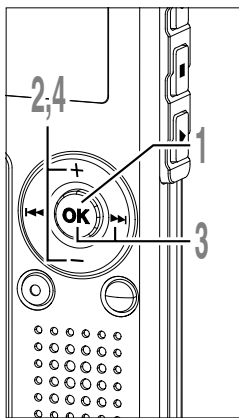

- 1 Press and hold the **OK** button for 1 second or longer.**

The menu opens (see P.68, 74).

- 2 Press the **+** or **-** button to choose "EQ".**

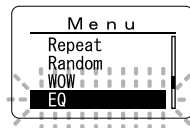

- 3 Press the **OK** or **▶▶** button.**

The equalizer setup process begins.

- 4 Press the **+** or **-** button to choose "User".**

The user setup process begins.

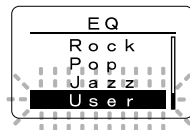

- 5 Press the **▶▶** button.**

Select the frequency band.

- 6 Press the **▶▶** or **◀◀** button to select the frequency band.**

60Hz ↔ 250Hz ↔ 1kHz ↔ 4kHz ↔ 12kHz ↔
Low tone ↔ High tone

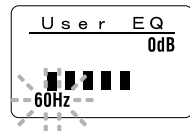

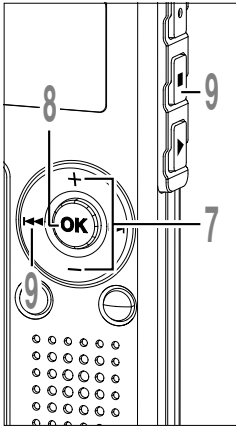

7 Press the + or - button to select the equalizer level.

You can select the equalizer level from -10dB to 10dB in 1dB increments. The higher the decibel value, the louder the sound. The default setting is 0dB.

To change the settings again, press the ►► or ◄◄ button and repeat the procedure from step 6.

8 Press the OK button to complete the setup screen.

9 Press the STOP or ◄◄ button to close menu.

(a) User equalizer indicator

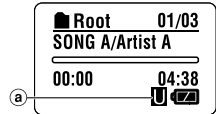
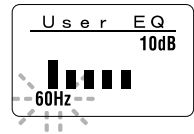

Notes

- If no operation is made for 3 minutes during the setting, it will return to the stop status.
- Your equalizer settings will be retained in memory even when you change the battery.



Moving the Tracks (Move)

You can change the playback order of music files on the recorder.
Select the folder (file) of the tracks that you want to move beforehand.

4

Moving the Tracks (Move)

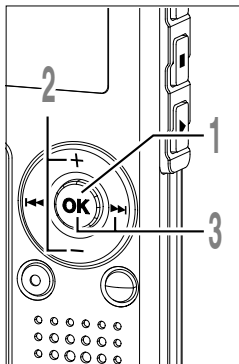

- 1 Press and hold the OK button for 1 second or longer.**

The menu opens (see P.68, 74).

- 2 Press the + or - button to choose "Move".**

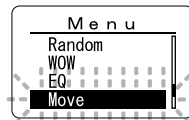

- 3 Press the OK or ►► button.**

Lists up the files in the current folder.

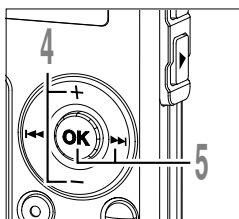
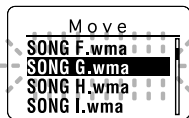

- 4 Press the + or - button to choose the file.**

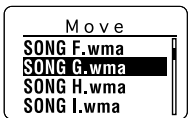

- 5 Press the OK or ►► button.**

The cursor flashes and the target file to move is fixed.

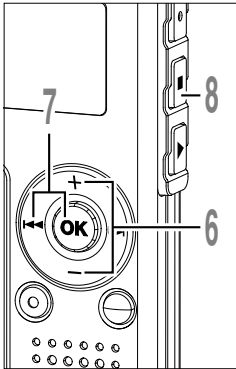

6 Press the **+** or **-** button to select the place to move.

7 Press the **OK** or **◀◀** button.
If there are more files you want to move, repeat the procedures from step 4 to step 7.

8 Press the **STOP** button to close the menu.
If you press and hold the OK button for 1 second or longer, moving will be completed and it returns to the "Move" display.

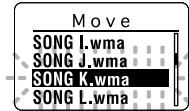

Note

- If no operation is made for 3 minutes during the setting, it will return to the stop status.



Menu List (MUSIC mode)

Menu

Press and hold the **OK** button for 1 second or longer.

Play Mode

Folder

All

Playback mode range setting.
Selection between Folder and All.

Repeat

On

Off

Single

Repeat mode setting. Selection
from On (enabled), Off (disabled)
and Single (single repeat).

Random

On

Off

Random mode setting. Selection
between On (enabled) and Off
(disabled).

WOW

SRS 3D

TruBass

Off

High

Low

Middle

WOW mode setting. Selection
between Off, High, Low, and
Middle.

EQ

Flat

Rock

Pop

User

Jazz

(P.63)

Register your equalizer setting.

Move

Replace music files.

While selecting the corresponding
file to move, pressing the **Left**
button will revert the display.

Sub Menu

(P.75)

4

Menu List (MUSIC mode)

Sub Menu

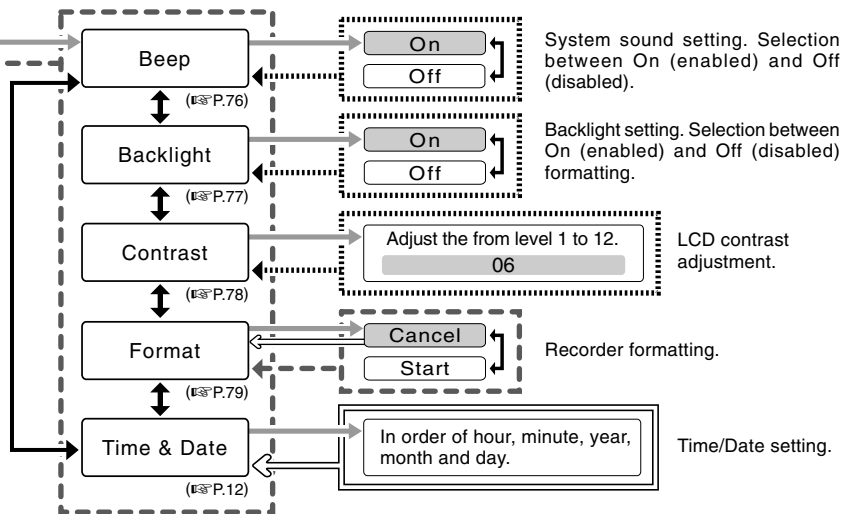

- ↕ : Press the + or - button.
- : Press the OK or ►► button.
- ⇒ : Press the ►►► button.
- ◀..... : Press the OK or ◀◀ button.
- ◀- - : Press the ◀◀ button.

- ← : Press the OK button.
- ← : Press and hold the OK button for 1 second or longer.
- ◻ : Initial setting.

Notes

- The above is the menu chart of this recorder when it enters into the menu from stop status. During playback of music files, displaying the menu by pressing the OK button shortly will set each of the following items; "Play Mode", "Repeat", "Random", "WOW" and "EQ". If the PLAY button is pressed during the setting or no operation is made for 8 seconds, it will return to the playback display.
- If you press the STOP, REC or the PLAY button, during a menu setup operation, the recorder will stop and apply the items that were set to that point.
- The recorder will stop if you leave it idle for 3 minutes during a menu setup operation, when a selected item is not applied.

Download from [Www.Somanuals.com](http://www.Somanuals.com). All Manuals Search And Download.



Erasing

Erasing One File at a Time

A selected file can be erased from a folder.

5 Erasing

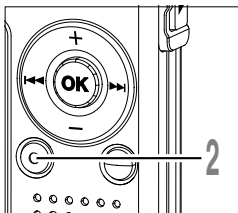

1 Select the file you want to delete.

In the stop status, display the file or place the cursor on the file in the list display.

2 Press the **ERASE** button.

The “Cancel” indicator flashes.

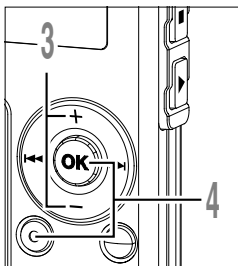
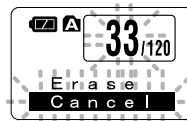

3 Press the **+** or **-** button to choose “Erase”.

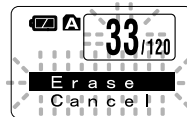

4 Press the **ERASE** or **OK** button.

The display changes to “File Erase!” and erasing will start.

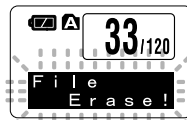

“Erase Done” is displayed when the file is erased. File numbers will be reassigned automatically.



Erase All Files from a Folder

All files in a folder can be erased simultaneously.

The locked files (P.34) and the files set to read-only on the PC will not be erased.

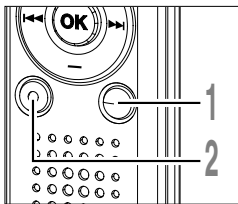

1 Select the folder in which you want to erase all files.

2 Press the **ERASE** button for 3 seconds or longer.

The "Cancel" indicator flashes.

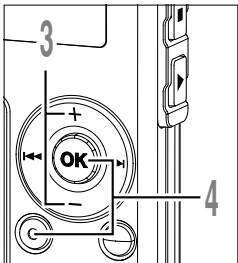

3 Press the **+** or **-** button to choose "All Erase".

4 Press the **ERASE** or **OK** button.

The display changes to "All Erase!" and erasing will start.

"Erase Done" is displayed when the files are erased. The locked files and read-only files are reassigned the file numbers in ascending order, starting from "1".

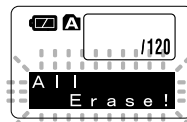
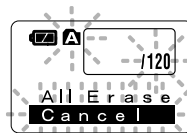

5

Erasing

Notes

- An erased file cannot be restored.
- The locked files and the files that are set to read-only will not be erased (see P.34).
- If the ERASE button or the OK button is not pressed within 8 seconds after the erase mode display flashes, the recorder will return to the stop status.
- Completion of erasing may take about over 10 seconds. Never do anything during this period because data may be corrupted.



Hold

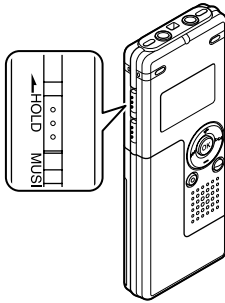

Setting the **HOLD** switch to the **HOLD** position.

If you set the recorder to HOLD status by sliding the HOLD switch in the direction of the arrow, the current conditions will be preserved, and all buttons and switches except the HOLD switch will be disabled. This feature is useful when the recorder has to be carried in a bag or pocket.

Remember to reset the HOLD switch when using the recorder.

Notes

- If you switch to the Hold mode during stop status, the display will be turned off. Pressing any button during this status will make the clock display flash for 2 seconds, but will not operate the recorder.
- If HOLD is applied during playback (recording), operation is disabled with the playback (recording) state unchanged. (When playback has ended and the recording has ended due the remaining memory being used up, it will be in the stop state.)



Menu Setting Method

Each item of the menu list (P.38, 68) can be set by the following method.

Menu Setting

5

Menu Setting Method

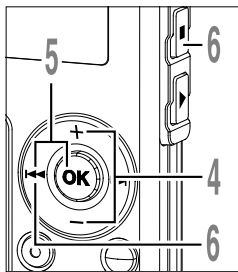
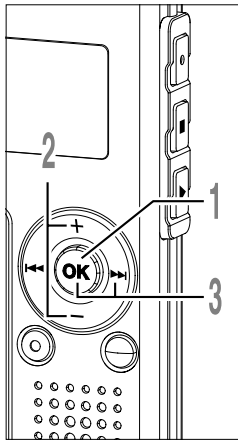

- 1 Press and hold the OK button for 1 second or longer.**

The menu opens (P.38, 68).

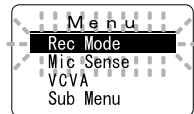

- 2 Press the + or - button to move to the item to be set.**

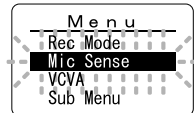

- 3 Press the OK or >>> button.**

Moves to the setting of the selected item. When Sub Menu is selected, move to the item of the sub menu (P.38, 68, 75).

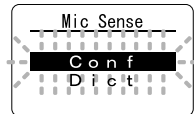

Press the <<< button to return to the previous page.

- 4 Press the + or - button to change the setting.**

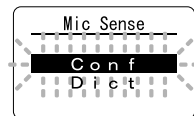

- 5 Press the OK or <<< button to complete the setup screen.**

- 6 Press the STOP or <<< button to close the menu.**

Sub Menu Setting

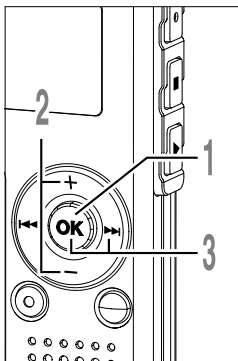

- 1 Press and hold the OK button for 1 second or longer.**

The menu opens (see P.38, 68, 74).

- 2 Press the + or - button to choose "Sub Menu".**

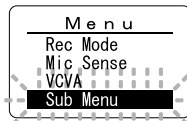

- 3 Press the OK or >>> button.**

The sub menu opens.

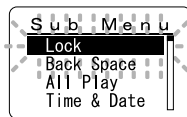

- 4 Press the + or - button to move to the item to be set.**

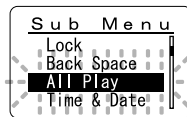

- 5 Press the OK or >>> button.**

Moves to the setting of the selected item.

Press the <<< button to return to the previous page.

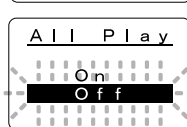

- 6 Press the + or - button to change the setting.**

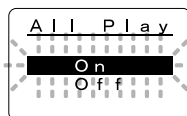

- 7 Press the OK or <<< button to complete the setup screen.**

- 8 Press the STOP button to close the menu.**

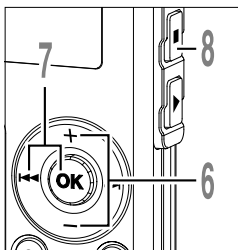
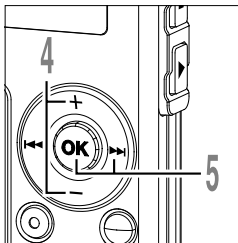



System Sounds (Beep)

The recorder beeps to alert you to button operations or warn you of errors. System sounds may be turned off.

5

System Sounds (Beep)

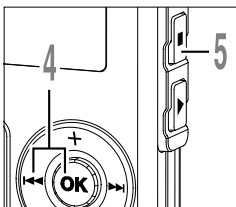
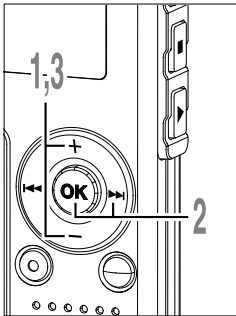

- 1 Press the **+** or **-** button in the sub menu screen, and select the **“Beep”**.

See P.38, 68, 75 regarding the sub menu.

- 2 Press the **OK** or **▶▶** button.
The system sound setup process begins.

- 3 Press the **+** or **-** button to choose between **“On”** and **“Off”**.

- 4 Press the **OK** or **◀◀** button to complete the setup screen.

- 5 Press the **STOP** button to close the menu.

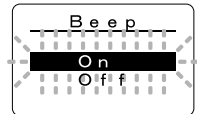
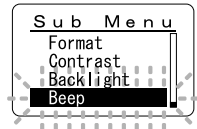



Backlight (Backlight)

The recorder display backlight is On by default. The display will remain lit for about 10 seconds when a button on the recorder is pressed.

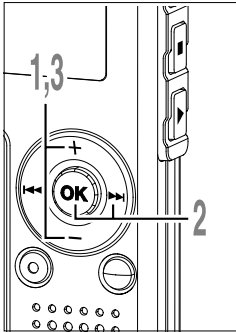

- 1 Press the + or – button in the sub menu screen, and select the “Backlight”.**

See P.38, 68, 75 regarding the sub menu.

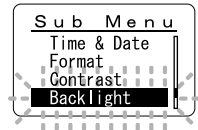

- 2 Press the OK or ►► button.**
The backlight setup process begins.

- 3 Press the + or – button to choose between “On” and “Off”.**

On: Backlight is enabled.

Off: Backlight is disabled.

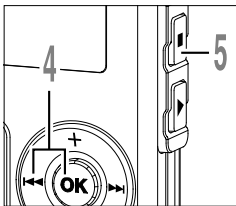
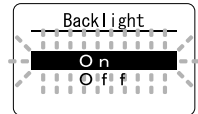

- 4 Press the OK or ◀◀ button to complete the setup screen.**

- 5 Press the STOP button to close the menu.**

5

Backlight (Backlight)



LCD Contrast Adjustment (Contrast)

Display contrast can be adjusted in 12 levels.

5

LCD Contrast Adjustment (Contrast)

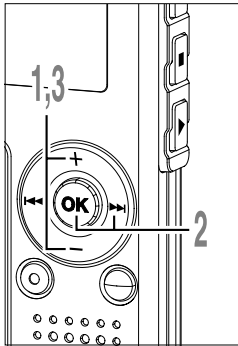

- 1 Press the **+** or **-** button in the sub menu screen, and select the **“Contrast”**.

See P.38, 68, 75 regarding the sub menu.

- 2 Press the **OK** or **▶▶▶** button.

The LCD display contrast setup process begins.

- 3 Press the **+** or **-** button to set the contrast level.

You can adjust the LCD display contrast level from 1 to 12.

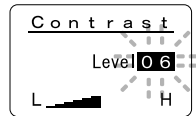
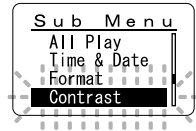

- 4 Press the **OK** or **◀◀◀** button to complete the setup screen.

- 5 Press the **STOP** button to close the menu.

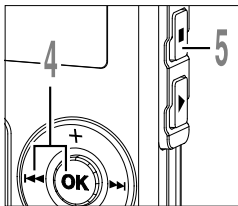



Formatting the Recorder (Format)

If you format the recorder, all function settings will return to their defaults*. All files** stored in the recorder will be deleted.

If you have important files that you want to save, connect the recorder to a computer and transfer those files from the recorder to the computer before formatting the device.

* Date and time settings will not be cleared, so you won't need to set them again.

** Locked files will also be deleted.

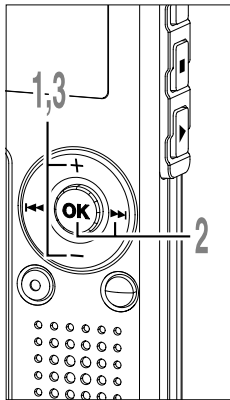

- 1 Press the + or - button in the sub menu screen, and select the "Format".**

See P.38, 68, 75 regarding the sub menu.

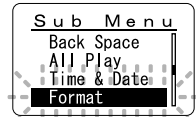

- 2 Press the OK or ►► button.**

The "Cancel" indicator flashes.

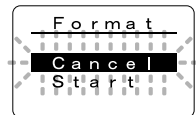

- 3 Press the + or - button to choose "Start".**

The "Start" indicator flashes.

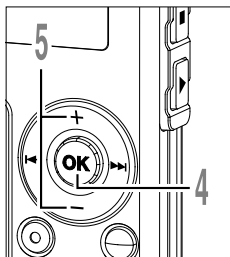
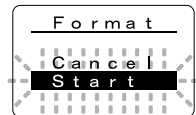

- 4 Press the OK button.**
- After "Data Will Be Cleared" flashes for 2 seconds, "Cancel" flashes.

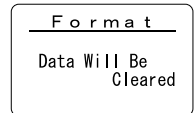

- 5 Press the + or - button again to choose "Start".**

The "Start" indicator flashes.

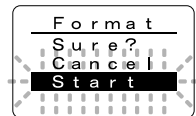

5

Formatting the Recorder (Format)

Formatting the Recorder (Format)

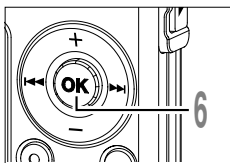

- 6 Press the OK button.**
Formatting begins and an indicator flashes on the display.

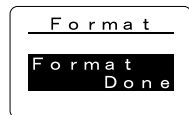
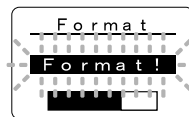

“Format Done” displays when formatting ends.

Notes

5

Formatting the Recorder (Format)

- While formatting, do not remove the battery. It may take about 10 seconds or more for the erasing to end.
- Never format the recorder from a PC.
- After formatting, the first file name is 0001.
- Once the recorder is formatted, the music files with DRM may not be transferred to the recorder again.
- When the recorder is formatted, all the saved data, including locked files and read-only files, are erased.

Using as External Memory of the Computer

With the recorder connected to your PC, you can download data from the memory to your PC and upload data stored on your PC to the memory.

Example: Copying Data from PC to Recorder using Explorer, etc.

1 Start Windows.

2 Connect the recorder to your PC.
For the connection procedure, refer to “Connecting to Your PC ” (P.42).

3 Open the Explorer window.
The recorder will appear as a removable drive icon.

4 Copy the data.
While the data is being written or copied, the record/play indicator light and USB access indicator light on the recorder will flash in red.

.....
Note

- NEVER disconnect the USB while the record/play indicator light and USB access indicator light are flashing in red. Otherwise data may be damaged.

Alarm Message List

Message	Meaning	Explanation	Action
Battery Low	Low battery power	Battery power is getting low.	Replace with new battery (☞ P.10).
File Protected	Erase-locked	Tried to delete a locked file.	Unlock the file (☞ P.34).
Index Full	Index full	The file is full of index marks (maximum of 16 marks).	Erase index marks that are no longer required (☞ P.32).
Index Can't Be Entered	File not supporting index	Tried to incorporate WMA file index marks into the music files or the files not recorded with the recorder.	You can incorporate index marks into the voice files recorded with the recorder or IC recorders from Olympus only.
Folder Full	Folder full	The folder is full of files (maximum of 199 files).	Erase unnecessary files (☞ P.70).
Memory Error	Error in the internal flash memory	Error in the internal memory.	This is a malfunction, so go to the store where you purchased the recorder or an Olympus service station for repair (☞ P.87).
Licence Mismatch	Illegally copied file	The music files copied illegally.	Delete the file (☞ P.70).
Memory Full	Zero remaining memory	No remaining internal memory.	Erase unnecessary files (☞ P.70).
No File	No file	No files were found in the folder.	Select another folder.
Format Error	Formatting error	There was an error while formatting the recorder's memory.	Reformat the memory (☞ P.79).
Read Only File	This file is read-only	Tried to erase the file that is set to read-only on the PC.	Cancel the read-only setting of the file on the PC.

Troubleshooting

Symptom	Probable cause	Action
Nothing appears on the display	The battery is not loaded properly.	Verify polarity is correct.
	The battery is dead.	Replace with new battery (☞ P.10).
	The recorder is in HOLD mode.	Release the recorder from HOLD (☞ P.11, 73).
Won't start	The recorder is in HOLD mode.	Release the recorder from HOLD (☞ P.11,73).
	The battery is dead.	Replace with new battery (☞ P.10).
Unable to record	Low remaining internal flash memory.	Erase unnecessary files (☞ P.70).
	The maximum number of files has been reached.	Check another folder.
	MUSIC mode is active.	Switch to VOICE mode (☞ P.14).
No playback tone heard	The earphone is connected.	Unplug the earphones to use the internal speaker.
	The VOL(+ or -) button is set to 0.	Adjust the VOL(+ or -) button (☞ P.24).
Unable to erase	The file is locked.	Unlock the file (☞ P.34).
	The file is read-only.	Cancel the read-only setting of the file on the PC.
Noise heard during playback	The recorder was shaken during recording.	—
	The recorder was placed near a cell phone or fluorescent light while recording or during playback.	Move the recorder.
Recording level too low	The microphone sensitivity is too low.	Set the microphone sensitivity to "Conf" mode and try again (☞ P.21).
Unable to set index marks	The maximum number of index marks (16) has been reached.	Erase unnecessary index marks (☞ P.32).
	The file is locked.	Unlock the file (☞ P.34).
	The file is read-only.	Cancel the read-only setting of the file on the PC.
Cannot find the downloaded file	The destination folder for downloading was other than the Root folder or Music folder.	Copy the music file into the Root folder or Music folder.
	VOICE mode is active.	Switch to MUSIC mode (☞ P.14).
Cannot find the recorded voice	MUSIC mode is active.	Switch to VOICE mode (☞ P.14).
	Wrong folder.	Switch to the right folder.

Accessories (optional)

Stereo microphone: ME51S

The high fidelity of the recording, which only stereo can perform. Furthermore, it gives clear sound quality with less noise.

Noise-cancellation monaural microphone: ME12

(Dictation microphone)

Used to get crisp recordings of your own voice by reducing the effects of ambient noise. This is useful microphone and suits for voice recognition.

Ni-MH rechargeable battery and charger set: BC400 (Europe only)

BC400 comes with an Ni-MH rechargeable battery charger(BU-400) and 4 Ni-MH rechargeable batteries (BR401) as a pack. This charger can quick charge Olympus AA or AAA Ni-MH rechargeable batteries.

Ni-MH rechargeable battery: BR401

High-efficiency rechargeable long life batteries.

Tie clip microphone: ME15

(Monaural)

Small concealing microphone with a tie-clip.

Telephone pickup: TP7

Earphone type microphone can be plugged into your ear while phoning. The voice or conversation over the phone can be clearly recorded.

Connecting cord: KA333

Connecting cord which has stereo mini-plugs ($\phi 3.5$) with resistance at both ends. Use to connect from the earphone jack output of the recorder to the microphone input jack when recording.

Converting plug adapters (PA331/PA231) which convert to the monaural mini plug ($\phi 3.5$) or monaural mini mini plug ($\phi 2.5$) are also enclosed.

Specifications

For the Digital Voice Recorder

Recording format

WMA (Windows Media Audio)

Input level -70 dBv

Sampling frequency

ST HQ mode: 44.1 kHz

HQ mode: 44.1 kHz

SP mode: 22 kHz

LP mode: 8 kHz

Overall frequency response

ST HQ mode: 100Hz to 15 kHz

HQ mode: 100Hz to 12 kHz

SP mode: 100Hz to 5 kHz

LP mode: 100Hz to 3 kHz

Recording time

WS-320M (1 GB)

ST HQ mode: Approx. 35 hours 25 minutes

HQ mode: Approx. 70 hours 50 minutes

SP mode: Approx. 139 hours 30 minutes

LP mode: Approx. 277 hours 20 minutes

WS-310M (512 MB)

ST HQ mode: Approx. 17 hours 40 minutes

HQ mode: Approx. 35 hours 20 minutes

SP mode: Approx. 69 hours 30 minutes

LP mode: Approx. 138 hours 15 minutes

WS-300M (256 MB)

ST HQ mode: Approx. 8 hours 45 minutes

HQ mode: Approx. 17 hours 30 minutes

SP mode: Approx. 34 hours 35 minutes

LP mode: Approx. 68 hours 45 minutes

Alkaline battery life

Recording:

Approx. 11 hours (Stereo)

Approx. 15 hours (Monaural)

Playback:

Approx. 7 hours (Stereo)

Approx. 7 hours (Monaural)

Ni-MH rechargeable battery life

Recording:

Approx. 9 hours (Stereo)

Approx. 12 hours (Monaural)

Playback:

Approx. 6 hours (Stereo)

Approx. 6 hours (Monaural)

For the Digital Music Player

Compatible data format

WMA, MP3 format

Sampling frequency

44.1 kHz

Frequency band

20kHz to 20kHz

Playback time

WS-320M (1 GB)

Approx. 13 hours 20 minutes to 45 hours 20 minutes

WS-310M (512 MB)

Approx. 6 hours 40 minutes to 22 hours 40 minutes

WS-300M (256 MB)

Approx. 3 hours 20 minutes to 11 hours 20 minutes

(Time may vary depending on the bit rate of the music data.)

Maximum headphone output

5mW + 5mW (at load of 22 Ω)

Alkaline battery life

WMA: Approx. 14 hours

MP3: Approx. 16 hours

Ni-MH rechargeable battery life

WMA: Approx. 11 hours

MP3: Approx. 12 hours

Common Specifications

Recording medium

Built-in NAND FLASH memory
1 GB (WS-320M)
512 MB (WS-310M)
256 MB (WS-300M)

Speaker

Built-in \varnothing 18 mm round dynamic speaker

MIC jack

\varnothing 3.5, impedance 2k Ω

EAR jack

\varnothing 3.5, impedance 8 Ω or more

Maximum working output (3 V DC)

70 mW or more (8 Ω speaker)

Input power requirement

Rated voltage: 1.5 V
Batteries: AAA battery (LR03 , R03 or ZR03) or Ni-MH rechargeable battery

External dimensions

94.8 x 38.2 x 11 mm
(without protrusions)

Weight

46 g (including alkaline battery)

* Specifications and design are subject to change without notice.

* Battery life is measured by Olympus. It varies greatly according to the type of batteries used and the conditions of use.

Technical Assistance And Support

The following is contact information for technical support for Olympus recorders and software only.

- ◆ Technical Hotline Number in the U.S. and Canada
1-888-553-4448

- ◆ User Support E-mail address in the U.S. and Canada
distec@olympus.com

- ◆ Technical Hotline Number in Europe
Toll free number
00800 67 10 83 00

available for Austria, Belgium, Denmark, Finland, France, Germany, Italy, Luxemburg, Netherlands, Norway, Portugal, Spain, Sweden, Switzerland, United Kingdom

Charged numbers for the Rest of Europe
+49 180 567 1083
+49 40 23773 899

- ◆ User Support E-mail address in Europe
dss.support@olympus-europa.com

Free Manuals Download Website

<http://myh66.com>

<http://usermanuals.us>

<http://www.somanuals.com>

<http://www.4manuals.cc>

<http://www.manual-lib.com>

<http://www.404manual.com>

<http://www.luxmanual.com>

<http://aubethermostatmanual.com>

Golf course search by state

<http://golfingnear.com>

Email search by domain

<http://emailbydomain.com>

Auto manuals search

<http://auto.somanuals.com>

TV manuals search

<http://tv.somanuals.com>