

DIGITAL VOICE RECORDER DW-90 INSTRUCTIONS

Please read these instructions for information about using the product correctly and safely.
Keep the instructions handy for future reference.

To ensure successful recordings, we recommend that you test the record function and volume before use.

OLYMPUS OPTICAL CO., LTD.
San-Ei Building, 22-2, Nishi Shinjuku 1-chome, Shinjuku-ku, Tokyo, Japan. Tel. 03-3340-2211

OLYMPUS AMERICA INC.
Two Corporate Center Drive, Melville, NY 11747-3157, U.S.A. Tel. 1-800-622-6372

OLYMPUS OPTICAL CO (EUROPA) GMBH.
(Premises/Goods delivery) Wendenstrasse 14-18, 20097 Hamburg, Germany. Tel. 040-237730
(Letters) Postfach 10 49 08, 20034 Hamburg, Germany.

OLYMPUS OPTICAL CO. (U.K.) LTD.
2-8 Honduras Street, London EC1Y 0TX, United Kingdom, Tel. 020-7253-2772
http://www.olympus.com

Declaration of Conformity

Model Number: DW-90
Trade Name: DIGITAL VOICE RECORDER
Responsible Party: OLYMPUS AMERICA INC.
Address: 2 Corporate Center Drive, Melville, NY 11747-3157, U.S.A.
Telephone Number: 800-622-6372

This device Complies with Part 15 of the FCC Rules. Operation is subject to the following two conditions: (1) This device may not cause harmful interference, and (2) this device must accept any interference received, including interference that may cause undesired operation.



FOR HOME OR OFFICE USE

Canadian RFI

This digital apparatus does not exceed the Class B limits for radio noise emissions from digital apparatus as set out in the Radio Interference Regulations of the Canadian Department of Communications.

Cet appareil numérique ne dépasse pas les limites de Catégorie B pour les émissions de bruit radio émanant d'appareils numériques, tel que prévu dans les Règlements sur l'Interférence Radio du Département Canadien des Communications.

“CE” mark indicates that this product complies with the European requirements for safety, health, environment and customer protection.

L'indication “CE” signifie que ce produit est conforme aux exigences concernant la sécurité, la santé, l'environnement et la protection du consommateur.

Das „CE“ Zeichen bestätigt die Übereinstimmung mit den Europäischen Bestimmungen für Betriebssicherheit und Umweltschutz.

Il marchio “CE” indica che questo prodotto è conforme alle norme della comunità europea per quanto riguarda la sicurezza, la salute, l'ambiente e la protezione del consumatore.

La marca “CE” indica que este producto se encuentra de conformidad con las exigencias europeas sobre seguridad, salud, medio ambiente y protección al consumidor.

Main Features

- The DW-90 has three recording modes: HQ (High Quality) mode, SP (Standard Playback) mode, and LP (Long Playback) mode.
- The Variable Control Voice Actuator (VCVA) reduces memory usage by pausing recording when it senses silence.
- Recorded sound files can be stored in three separate folders (up to 100 files per folder).
- Back lighting to illuminate the LCD panel allows you to read the display in the dark.
- The USB cable and Digital Wave Player-Software allow you to record sound files directly on PC.
- The high-quality directional microphone helps you clearly record from a sound source aimed at with the microphone.

Identification of Parts

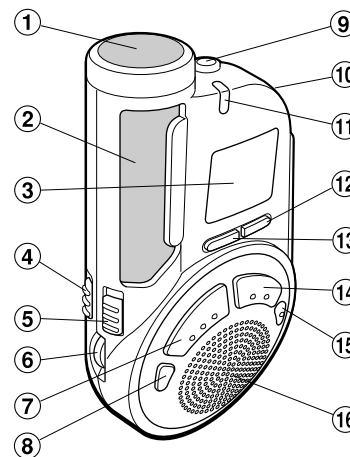

- 1 microphone (front)
- 2 microphone (side)
- 3 Display (LCD panel)
- 4 HOLD switch
- 5 MICSENS (Microphone sensitivity) switch
- 6 VOLUME control
- 7 REC (Record) button
- 8 ERASE button
- 9 Earphone jack
- 10 Microphone stand hole
- 11 Recording lamp
- 12 DISPLAY button
- 13 REC MODE button
- 14 STOP button
- 15 MENU/FOLDER button
- 16 Built-in speaker

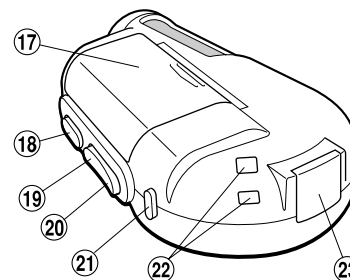

- 17 Battery cover
- 18 PLAY/▶ button
- 19 ▶▶ (Fast Forward) /+ button
- 20 ◀◀ (Rewind) /- button
- 21 Rubber foot
- 22 Strap holes
- 23 PC (USB) terminal

Display (LCD Panel)

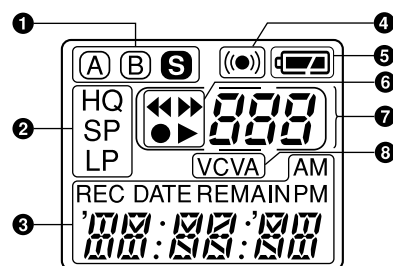

- 1 Folder indicator
- 2 Recording mode indicator
- 3 Current time/date, recording time/date (REC DATE), elapsed recording time, remaining recording time (REMAIN), menu display, etc.
- 4 Alarm indicator
- 5 Battery indicator
- 6 ◀◀ Rewind indicator, ▶▶ Fast Forward indicator, ● Record indicator, ▶ Play indicator
- 7 File number indicator
- 8 VCVA (Variable Control Voice Actuator) indicator

Standby Mode and Display Shut Off

If the recorder is stopped or paused for 60 minutes or longer during recording or playing, it goes into Standby (power-save) mode, and the display shuts off. To exit Standby mode and turn on the display, press any button.

Inserting Batteries

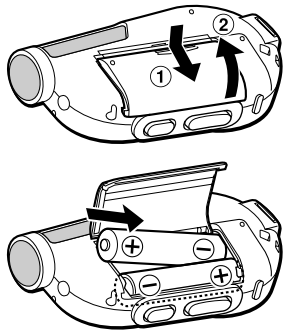

- 1 Holding the battery compartment cover pressed slightly toward the recorder, slide the cover until it unlocks, then open the cover.
- 2 Insert two size-AAA alkaline batteries, observing the correct polarity.
- 3 Close the battery cover completely.

Replacing Batteries

When appears on the display, replace the batteries as soon as possible. Size-AAA alkaline batteries are recommended. When the batteries are depleted, appears on the display, and the recorder shuts off. It is recommended to set the HOLD switch to the HOLD position before you replace batteries to maintain the current settings (time/date, etc.). For your convenience, the recorder also logs the current settings in nonvolatile memory at hourly intervals.

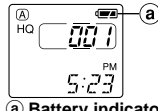

a Battery indicator

Setting Time/Date

If you have set the time and date, information as to when a sound file was recorded is stored automatically with that file. The time and date should be set to ease sound file management tasks.

The setting of the time and date is necessary for the management of the files in folder S (see "Notes on the Folders" for details), for the alarm playback function, and for the schedule alarm playback function.

When you install batteries for the first time or each time you replace the batteries, the hour indication will flash. In such a case, be sure to set the time and date by following steps 4 through 6 described below.

- 1 Press and hold the MENU/FOLDER button for 1 second or longer.
- 2 Press the or button to select the Time/Date Setup screen. "TIME" flashes on the display.
- 3 Press the PLAY button. The hour indicator flashes.
- 4 Press the or button to set the hour.
- 5 Press the PLAY button to accept the hour. The minute indicator flashes. Repeat steps 4 and 5 to continue to set the minute, year, month and date in the same way.
- 6 After setting the date, press the STOP button. This completes the time/date setup procedure.

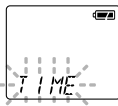

You can switch the time indication between the 12-hour system and the 24-hour system by pressing the DISPLAY button while you are setting the hour or minute. (Example: 5:23 P.M.)

5:23 PM
↔ 17:23
(Initial setting)

You can change the order of the date indication by pressing the DISPLAY button while you are setting the year, month, or day. (Example: February 14, 2001)

2.1401 → 14.201 → 01.2.14
(Initial setting)

Each time you press the DISPLAY button while the recorder is stopped, the display changes as follows (with folder A or B selected):
Time → Remaining recording time → Date → Time . . .
The selected indication appears on the display each time the recorder is stopped.

Notes

- If you leave the recorder untouched for 3 minutes or longer before pressing the STOP button in step 6, Setup mode will be canceled, and any time/date settings you made will be canceled.
- If you press the STOP button during setup, time/date setup is canceled.
- You can set the time and date on the recorder by connecting it to your PC (see "Other functions of Olympus Digital Wave Player" for details).

Notes on the Folders

The recorder has three folders: A, B, and S.

- Folders A and B
Each recorded message stored in a folder is saved as a Wave file. These folders can be selectively used to distinguish the kind of recording. Up to 100 files can be stored per folder.
- Folder S
In folder S, files are nested in date subfolders,* making it useful for storing a certain day's schedule for future reference. Up to 15 files can be stored in a single date subfolder, and up to 100 files altogether can be recorded in folder S.
* There is one subfolder for each day of the year.

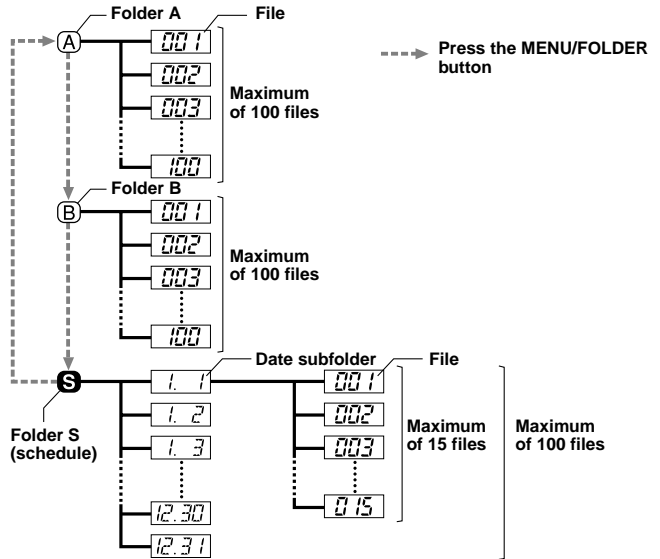

To change folders

Press the MENU/FOLDER button while the recorder is stopped.

Each time you press the MENU/FOLDER button, the display changes as follows:
A → B → S → A . . .

To change date subfolders in folder S, select folder S first, and then press the or button to select the date subfolder.

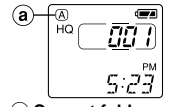

a Current folder

Recording

- 1 Press the MENU/FOLDER button to select the desired folder (A, B, or S). When you select folder S, the current date subfolder appears on the display. If you select folder A or B, go to the step 3.
- 2 If you select folder S, press the or button to select the desired date subfolder.
- 3 Set the recording mode (see "Recording Modes").
- 4 Set the microphone sensitivity (see "Microphone Sensitivity").
- 5 Press the REC button to start recording. The recording lamp lights, and recording starts. Each time you press the DISPLAY button, the display switches between current recording time and remaining recording time.
- 6 To stop recording, press the STOP button.

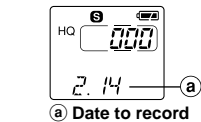

a Date to record

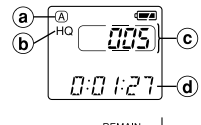

a Folder
b Current recording mode
c Current file number
d Recording time*
e Remaining recording time

* When the remaining recording time becomes 5 minutes or less, the display changes to remaining recording time automatically.

Notes

- Even if you press the DISPLAY button, the display will not change to current recording time if the remaining recording time is 5 minutes or less.
- When the remaining recording time becomes 1 minute or less, the recording lamp flashes.
- If "FULL" appears on the display, you cannot record in the selected folder. In such a case, erase unnecessary files (see "Erasing from folder A or B" or "Erasing from folder S").
- There is one subfolder for each day of the year.

To Pause Recording

To pause

Press the REC button during recording. ➡ "PAUSE" on the display and the recording lamp will flash.

To resume recording

Press the REC button again. ➡ Recording will resume at the point of interruption.

Note

The recorder will enter Stop mode if it has been left paused for 10 minutes or longer.

To check the remaining recording time

Press the DISPLAY button while the recorder is stopped.

To check the total number of files recorded in the folder

Press and hold the STOP button while the recorder is stopped. The total number of files recorded in the folder appears on the display.

* In the case of folder S, the number of the date subfolder is not included.

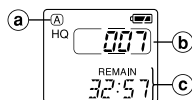

- a Current folder
- b Total number of files recorded in the current folder*
- c Remaining recording time

Playing Back

1 Press the MENU/FOLDER button to select the desired folder (A, B, or S).

2 Press the ►►/◄◄ or ◄◄/►► button to select the file to play back.

If you select folder S, select the desired date subfolder.*

* When you select the desired date subfolder, it is useful to press and hold the ►►/◄◄ or ◄◄/►► button for **1 second or longer**. The recorder locates the next date subfolder that contains recorded files.

3 Press the PLAY button to start playback.

The playing time** appears on the display.

** Each time you press the DISPLAY button during playback, the display changes as follows:

Playing time → Remaining playing time → Recording date of the file → Recording time of the file → Playing time . . .

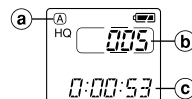

- a Current folder
- b Current file number
- c Playing time**

4 Use the VOLUME control to adjust the volume to your liking.

Note

When you play back a file in the date subfolder without choosing a specified file, the recorder will play back all the files in the selected date subfolder from filename "001." When you play back a file immediately after recording the file, only the most recently recorded file will be played back.

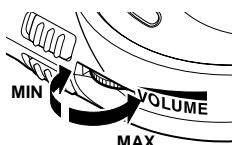

Canceling Playback

To stop

Press the STOP button. ➡ The recorder returns to the beginning of the file being played.

To pause

Press the PLAY button. ➡ "PAUSE" flashes on the display.

To resume playback

Press the PLAY button again. ➡ Playback will resume at the point of interruption.

Note

The recorder will enter Stop mode if it has been left paused for 10 minutes or longer.

Playback Functions

	Operation	How to cancel
Fast Playback (F-PLAY)	Press and hold the PLAY button for 1 second or longer while playing a file.	If you press and hold the PLAY button for 1 second or longer again, the recorder will resume normal playback.
Fast Forward (►►)	Press and hold the ►► button while playing a file.	When you release the ►► button, the recorder will resume normal playback.
Rewind (◄◄)	Press and hold the ◄◄ button while playing a file.	When you release the ◄◄ button, the recorder will resume normal playback.

- Fast playback is approximately 30% faster than normal playback.
- When fast playback of a file is over, the recorder will play back the next file at normal speed. If you once press the STOP button and start playback again, the recorder will play back files in normal speed as well.
- No sound is heard from the built-in speaker during fast forwarding or rewinding.
- The end of the file is located by pressing and holding the ►► button during fast forwarding. The recorder will pause at the end of the file. If you do not release the ►► button, the recorder will continue fast forward.
- The beginning of the file is located by pressing and holding the ◄◄ button during rewinding. The recorder will pause at the beginning of the file. If you do not release the ◄◄ button, the recorder will continue rewinding.

Locating the beginning of the file

Press the ►►/◄◄ or ◄◄/►► button in Stop mode,* playback, fast playback, or playback pause.

Each time you press the ►►/◄◄ or ◄◄/►► button, the recorder will locate the beginning of the next or previous file.

* When folder S is selected, you cannot locate the beginning of the file in Stop mode.

Notes

- Even if you press the ►►/◄◄ or ◄◄/►► button during playback or fast playback, the recorder will continue playback in the same playback mode.
- When you select folder A or B, you can locate the beginning of each file continuously by pressing and holding the ►►/◄◄ or ◄◄/►► button while in Stop mode. During operation, "SKIP" flashes on the display.

Erasing from Folder A or B

Erasing One File at a Time

1 Press the MENU/FOLDER button to select folder A or B.

2 Press the ►►/◄◄ or ◄◄/►► button to select the file to be erased.

3 Press the ERASE button.

The file number flashes, then alternatively "ERASE" and "YES" appear on the display for 8 seconds.

4 Press the ERASE button again.

The file is erased.

Sequential file numbers are reassigned automatically.

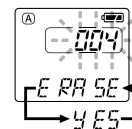

Notes

- You can erase a file while in playback or playback pause.
- If you leave the recorder untouched for 8 seconds or longer before you press the ERASE button in step 4, Erase mode will be canceled, and the recorder will enter Stop mode.

Erase All Files from a Folder

1 Press the MENU/FOLDER button to select the folder from which you want to erase all files.

2 Press and hold the ERASE button for 2 seconds or longer.

The folder name and "ALL" flash, then alternatively "ERASE" and "YES" appear on the display for 8 seconds.

3 Press the ERASE button again.

All files in the selected folder are erased simultaneously.

Note

If you leave the recorder untouched for 8 seconds or longer before you press the ERASE button in step 3, Erase mode will be canceled, and the recorder will enter Stop mode.

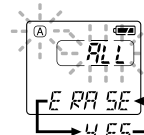

Erasing from Folder S

Erasing One File at a Time in a Date Subfolder

1 Press the MENU/FOLDER button and select folder S.

2 Press the ►►/◄◄ or ◄◄/►► button to select the date subfolder.

3 Press the PLAY button.

The recorder starts to playback all the files in the selected date subfolder.

4 During playback, press the ►►/◄◄ or ◄◄/►► button to select the file to be erased.

5 Press the STOP button.

6 Press the ERASE button.

The file number flashes, then alternatively "ERASE" and "YES" appear on the display for 8 seconds.

7 Press the ERASE button again.

The file is erased.

Sequential file numbers are reassigned automatically.

Note

If you leave the recorder untouched for 8 seconds or longer before you press the ERASE button in step 7, Erase mode will be canceled, and the recorder will enter Stop mode.

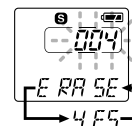

Erase All Files in a Date Subfolder

- 1 Press the MENU/FOLDER button to select folder S.
- 2 Press the ►►/+/ or ◀◀/– button to select the date subfolder to be erased.
- 3 Press and hold the ERASE button for 2 seconds or longer.
“ALL” flashes, then alternatively the date of the selected subfolder and “YES” appear on the display for 8 seconds.
- 4 Press the ERASE button again.
All files in the date subfolder are erased.

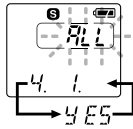

Note
If you leave the recorder untouched for 8 seconds or longer before you press the ERASE button in step 4, Erase mode will be canceled, and the recorder will enter Stop mode.

Erase All Files in the S Folder

- 1 Press the MENU/FOLDER button to select folder S.
- 2 Press and hold the ERASE button for 4 seconds or longer.
“S” and “ALL” flash, then alternatively “ERASE” and “YES” appear on the display for 8 seconds.
- 3 Press the ERASE button again.
All files in folder S are erased.

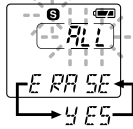

Note
If you leave the recorder untouched for 8 seconds or longer before you press the ERASE button in step 3, Erase mode will be canceled, and the recorder will enter Stop mode.

Recording Modes

You can select from among three recording modes: HQ (High Quality) mode, SP (Standard Playback) mode and LP (Long Playback) mode.

- HQ mode: approximately 22 minutes (Maximum recording times)
- SP mode: approximately 33 minutes
- LP mode: approximately 90 minutes

* The recording time available may be shorter than specified if a large number of short recordings are made. (Use the remaining time and recorded time only as references.)

Press the REC MODE button in Stop mode.

Each time you press the REC MODE button, the recording mode changes as follows:

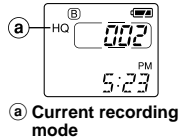
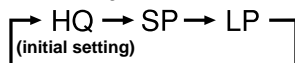

Note
Choose HQ or SP mode for recording meetings or lectures with crisp clarity.

Microphone Sensitivity

Microphone sensitivity is adjustable to meet your recording needs.

Using the MICSSENS switch, choose between the NORMAL and LECTURE positions.

- NORMAL:** Normal-sensitivity Omnidirectional mode for dictation.
- LECTURE:** High-sensitivity Unidirectional mode for meetings or lectures.

- Notes**
- Be sure to choose HQ or SP recording mode if you set the MICSSENS switch to the LECTURE position to use the characteristics of the unidirectional microphone to the fullest.
 - Do NOT touch the microphone grill while recording. Doing so may cause noise, and the performance of the microphone may deteriorate.
 - Be sure to keep the front microphone oriented toward the speaker during recording.
 - To ensure successful recording, make a test recording to choose appropriate microphone sensitivity before recording.

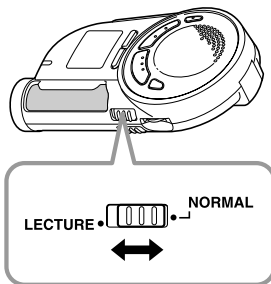

Moving Files Between Folders (MOVE)

You can move a file recorded in folder A or B to the other. The moved file is added at the end of the order in the destination folder.

- 1 Choose the file you want to transfer and press the PLAY button to play it.*
* You can move the file during playback pause as well.
- 2 Press and hold the MENU/FOLDER button for 1 second or longer while the file is playing.
Playback stops, and “MOVE” flashes on the display. The file is moved.
The destination folder and the number of the moved file appear on the display, and moving is completed.

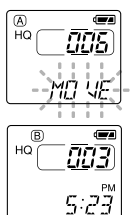

Notes

- You cannot move files between folder S and the other folders.
- If the destination folder is full (100 files), “FULL” appears on the display, and you cannot move the file to that folder.

Entering Options Mode

- 1 Press and hold the MENU/FOLDER button for 1 second or longer in Stop mode to enter Options mode.
- 2 Each time you press the ►►/+/ or ◀◀/– button, the displayed setting item changes in the following order:



To close the menu, press the STOP button.

Using the Variable Control Voice Actuator (VCVA)

When the microphone senses that sounds have reached a preset volume, the built-in Variable Control Voice Actuator (VCVA) starts recording automatically, and stops it when the volume drops. Particularly helpful for extended recording, the VCVA not only conserves memory by turning off recording during silent periods, but also makes playback more efficient and convenient.

- 1 Press and hold the MENU/FOLDER button for 1 second or longer.
The menu opens, and “VCVA” appears on the display.
- 2 Press the PLAY button.
- 3 Press the ►►/+/ or ◀◀/– button to select between “On” and “OFF.”
On: The VCVA is activated.
OFF: The VCVA is canceled.
- 4 Press the STOP button to close the menu.
- 5 Press the REC button to start recording.

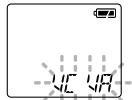

Notes

- When the VCVA senses sound louder than its start/stop actuation level setting, recording starts automatically. When it senses silence for 1 second or longer, recording pauses automatically, and the recorder enters Standby mode.
- When recording is in progress, the recording lamp is lit. When the recorder is in Standby mode, “VCVA” flashes on the display, and the recording lamp flashes.

Alarm Playback Function (ALARM)

The alarm playback function can be set to play a selected file at a preset time. Up to 20 alarms can be set.

- 1 Choose the file to be played when the alarm sounds.
- 2 Press and hold the MENU/FOLDER button for 1 second or longer.
- 3 Press the ►►/+/ or ◀◀/– button to select the Alarm Playback Setup screen.
“ALARM” flashes on the display.
- 4 Press the PLAY button.
The month indicator flashes.
- 5 Press the ►►/+/ or ◀◀/– button to set the month.
- 6 Press the PLAY button to register your month setting.
Continue to set the date, hour, and minute.
- 7 Set the minute and press the STOP button.

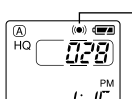
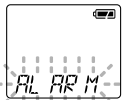

An alarm will sound at the scheduled time for 5 minutes. Press any button other than the DISPLAY or REC MODE button while the alarm is sounding to play back the file you associate with the alarm. Press the STOP button to stop file alarm playback.

Notes

- The alarm tone stop automatically if no button is pressed within 5 minutes after the alarm starts. The file is not played back in this case.
- After alarm playback is over, the alarm playback function is canceled automatically.
- You cannot set the alarm playback function for more than 20 files. Also, if no files are recorded in the selected folder, you cannot set the alarm playback function.

To cancel a set alarm playback

- 1 Repeat steps 1 to 4 in “Alarm Playback Function.”
The month indicator flashes.
- 2 Press the ►►/+/ or ◀◀/– button to select the month of the alarm you want to cancel.
- 3 Press the PLAY button to register this month setting for alarm cancellation.
Continue to select the date, hour and minute of the desired alarm cancellation.
When you set the minute, “On” flashes on the display.
- 4 Press the ►►/+/ or ◀◀/– button to select “OFF.”
A set alarm playback is canceled.
- 5 Press the STOP button to close the menu.

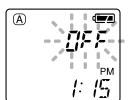

Schedule Alarm Playback Function

This is useful for reviewing your daily appointments and reminders.

- 1 Press and hold the MENU/FOLDER button for **1 second or longer**.
- 2 Press the ►►/◄◄ or ◄◄/►► button to select the Schedule Alarm Playback Setup screen.
"S" and "ALARM" flash on the display.
- 3 Press the PLAY button.
- 4 Press the ►►/◄◄ or ◄◄/►► button to select "On."
- 5 Press the PLAY button.
The hour indicator flashes.
- 6 Press the ►►/◄◄ or ◄◄/►► button to select the hour.
- 7 Press the PLAY button to register the hour.
Continue to set the minute.
- 8 Set the minute and press the STOP button.

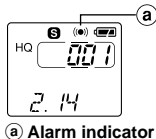
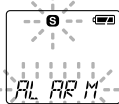

Notes

- The alarm tone stops automatically if no button is pressed within 5 minutes after the alarm starts. The files recorded for the current date are not played back in this case.
- Schedule alarm playback occurs every day unless it is set to OFF.
- Even if no file is recorded in the day's date subfolder, the beeps will sound. In such a case, no sound is heard even if you press some button while the alarm is sounding.

To cancel schedule alarm playback

- 1 Repeat steps 1 to 3 in "Schedule Alarm Playback Function."
"On" flashes on the display.
- 2 Press the ►►/◄◄ or ◄◄/►► button to select "OFF."
Schedule alarm playback is canceled.
- 3 Press the STOP button to close the menu.

System Sounds

The recorder beeps to alert you to button operations or warn you of errors. If you wish to disable the system sounds, proceed as follows:

- 1 Press and hold the MENU/FOLDER button for **1 second or longer**.
- 2 Press the ►►/◄◄ or ◄◄/►► button to open the System Sound Setup screen.
On the display, "bEEP" flashes.
- 3 Press the PLAY button.
- 4 Press the ►►/◄◄ or ◄◄/►► button to choose between "On" and "OFF."
On: System sounds are enabled.
OFF: System sounds are disabled.
- 5 Press the STOP button to close the menu.

Note

If the alarm playback function or the schedule alarm playback function has been set, the alarm will sound at the scheduled time even if the system sounds are disabled.

Using the Microphone Stand

When you place the recorder on a desk, etc. during recording, attach the supplied microphone stand to reduce unwanted vibration in the recorder.

Attach the microphone stand

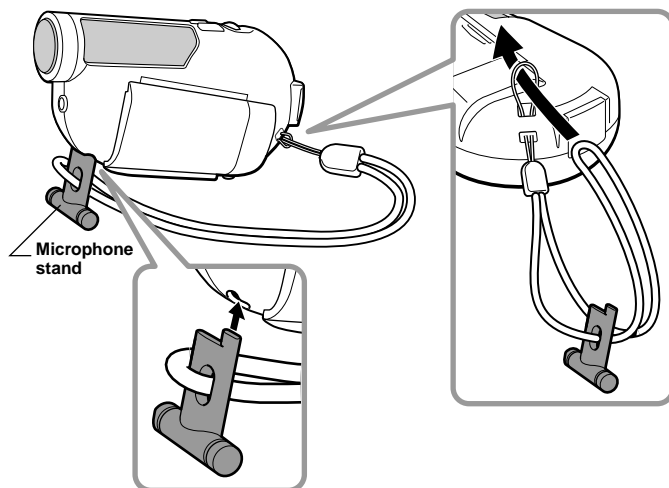

Hold

Set the HOLD switch to the HOLD position. All operation buttons are disabled. This feature is useful when the recorder has to be carried in a handbag or pocket. **Remember to reset the HOLD switch before attempting to use the recorder.**

Notes

- The recorder functions as follows with the HOLD switch set to the HOLD position:
 - If the recorder is stopped, the display goes dark.
 - If the recorder is playing, the display goes dark when playback of the current file has completed.
 - If the recorder is recording, the display goes dark when the recorder stops recording automatically upon running out of free memory.
- When the display is dark because the HOLD switch is set to the HOLD position, you can make the clock flash for 2 seconds by pressing any button.
- You can operate the following button and control while the HOLD switch is set to the HOLD position:
 - MICSENSE switch for selecting the microphone sensitivity
 - VOLUME control for adjusting the volume
- The alarm will sound at the scheduled time even if the recorder is set to HOLD. The recorder will then begin to play the file associated with the alarm once you press any button.

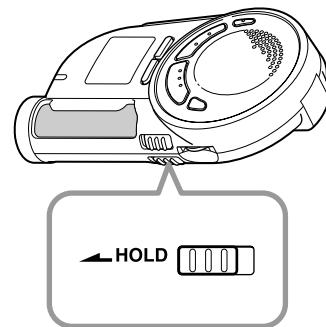

Resetting the Recorder (CLEAR)

This also resets the current time and other settings to their initial status.

- 1 Holding STOP button pressed, press and hold the ERASE button for **2 seconds or longer**.
"CLEAR" and "YES" appear alternately on the display for 8 seconds.
- 2 Press and hold the ERASE button again within **4 seconds**.
All files in all folders are erased, and the recorder is reset to its default settings.

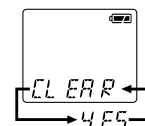

Note

If you leave the recorder untouched for 8 seconds or longer before you press the ERASE button in Step 2, Clear mode will be canceled, and the recorder will enter Stop mode.

Using the recorder with a PC

With the supplied Olympus Digital Wave Player software, you can download files to your computer.

Functions provided by Olympus Digital Wave Player are summarized below:

- PC storage and management of voice recordings made with the recorder.
- Playback of files.
- Recording of sound files directly on a PC using the recorder with a USB terminal connector.

Notes

- Olympus Digital Wave Player is software for use exclusively with the DW-90, not to be used with other recorders.
- You cannot send files from the PC to the recorder and cannot overwrite files in the recorder with Olympus Digital Wave Player.
- Olympus Digital Wave Player does not support speech-recognition software.
- Olympus Digital Wave Player does not support Apple Macintosh computers.
- In this manual the user is assumed to be familiar with Microsoft Windows software. For details on operation of the PC, refer to the operating instructions for your PC.

Operating Environment

Operating system:	Microsoft Windows 98/Me/2000Professional (hereinafter referred to as Windows 2000)
PC:	IBM PC/AT-compatible machine
CPU:	Intel Pentium 166 MHz or more
RAM:	32MB or more
Hard-disk space:	25MB (additional space required to store sound files)
Sound card:	Creative Labs Sound Blaster 16 or any 100% compatible sound card
Display:	800 × 600 pixels min., 256 colors min.
CD-ROM drive:	2× CD-ROM
USB port or Serial port:	At least one free port
Audio output jack:	Earphone or speaker output(s)

Note

USB support is not available under the following environments, even for PCs equipped with a USB port:
Windows 98/Me/2000 upgraded from Windows 95

Uninstalling Olympus Digital Wave Player

To uninstall Olympus Digital Wave Player, follow the procedure below.

- 1 Click on the Windows [Start] button.
- 2 Point to [Programs], select [Olympus Digital Wave Player], and then click on [Uninstall Digital Wave Player].

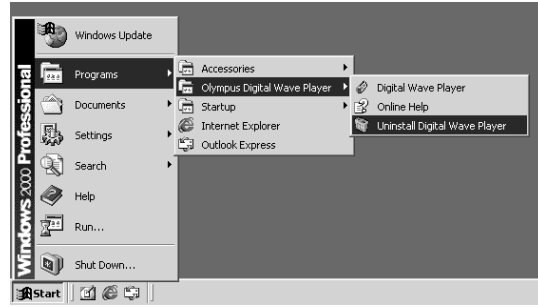

- 3 Follow the on-screen instructions to uninstall Olympus Digital Wave Player.

Using Online Help

This manual explains how to install Olympus Digital Wave Player and connect the hardware.

For more detailed instructions, view the Online Help after the software has been installed.

To open Online Help

Click on [Help] in Olympus Digital Wave Player's main window, then click on [Open Help]. You can also press the [F1] key to open the Help window.

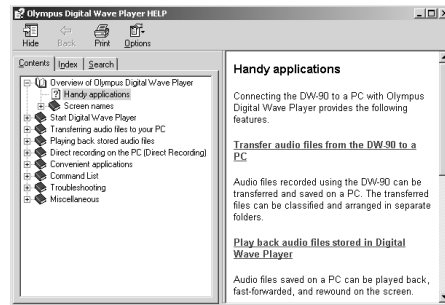

Installing Olympus Digital Wave Player

You must first install Olympus Digital Wave Player on your PC.

Notes

- Do NOT connect the recorder and the PC before installation of Olympus Digital Wave Player.
- Be sure to close any open applications before you start installation of Olympus Digital Wave Player.

- 1 Set the Olympus Digital Wave Player CD-ROM in the CD-ROM drive. The installation program will start automatically.*



* If the setup program does not start automatically, double-click the CD-ROM icon in the Explorer window and double-click on the "setup.exe" icon.

- 2 Install Olympus Digital Wave Player by following the instructions displayed in the setup windows.

- 3 After completion of setup, remove the CD-ROM. The  icon appears in the task tray on the desktop.



Starting Olympus Digital Wave Player

When you connect the recorder to your PC with the supplied USB cable, Olympus Digital Wave Player starts, and the main window appears automatically.

Note

Before making connections, make sure that the recorder is stopped.

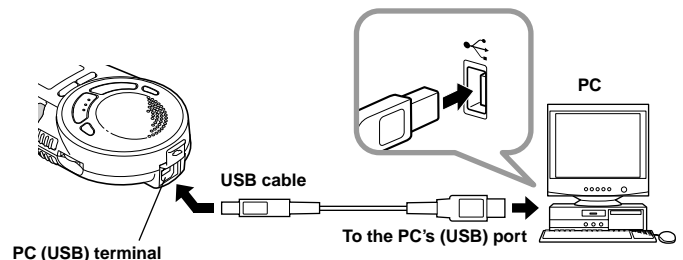

Main Window of Olympus Digital Wave Player

Schedule folder

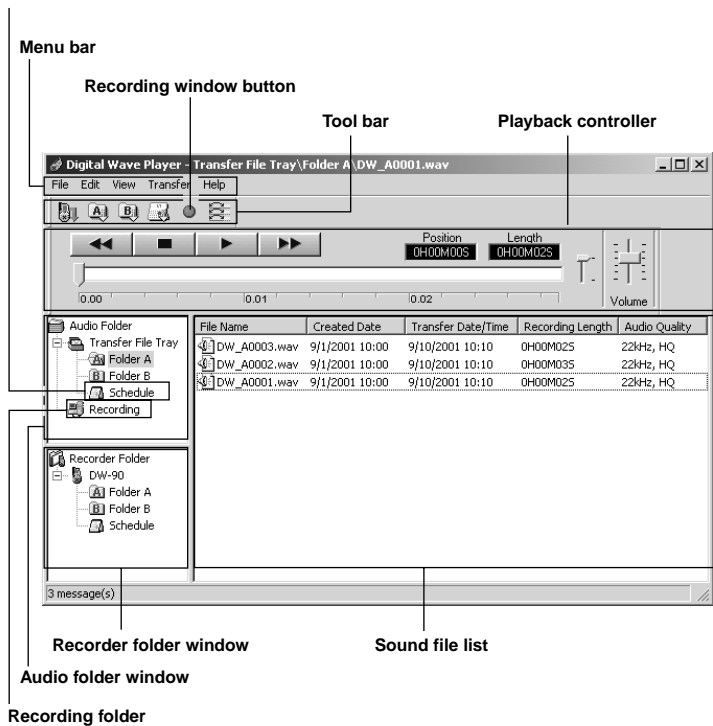

Recording folder

To use Olympus Digital Wave Player without connecting the recorder to the PC, or if Olympus Digital Wave Player does not start automatically when you connect the recorder to the PC, click on the [Start] button, point to [Programs], select [Olympus Digital Wave Player] then click on [Digital Wave Player].

To exit Olympus Digital Wave Player, click on the button on the window, or click on [File], and then click on [Exit Digital Wave Player].

Notes

- When you start Olympus Digital Wave Player for the first time by connecting the recorder to the PC after installation, it may take a few minutes to start.
- You cannot operate the buttons and controls on the recorder except for microphone-sensitivity switch while the recorder is connected to the PC.
- Do NOT use any USB cable other than the one supplied.
- Do NOT disconnect the USB cable before file transfer or recording is completed.

Using Olympus Digital Wave Player

For more detailed instructions, refer to Online Help.

Transferring Recorded Files to the PC

Before transferring recorded files to the PC, make sure the recorder is connected to the PC properly.

Olympus Digital Wave Player provides the following two methods for transferring files to the PC.

Transferring all folders

Press . ➔ All files in the recorder are transferred to the PC's folders whose names are the same as the folder names in the recorder.

Transferring a selected folder

Press . ➔ All files in the selected folder in the recorder are transferred to the PC's folder whose name is the same as the folder name in the recorder.

Note

Folders A, B, and schedule folder have been prepared on the PC in advance. The date subfolders for each date are automatically created together with the schedule folder transfer.

When you transfer files, the filenames change as follows.

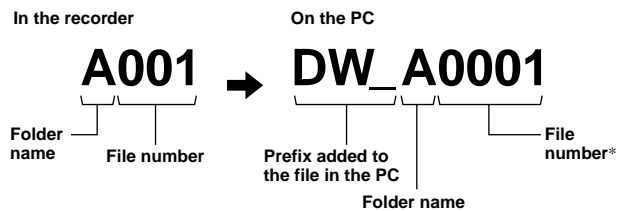

* The file number of the transferred file is renumbered automatically and will differ from the original file on the recorder.

Notes

- You cannot transfer one file at a time.
- Transfer time may vary depending on the recording mode of a file and PC's performance.
- You cannot upload files from the PC to the recorder.
- You cannot transfer a file that has the same recording time and date as a file already in the corresponding folder on the PC.
- To transfer files, 20MB or more of the hard-disk space is necessary to assure stable performance of the PC.

Playing the Files on the PC

Any file transferred from the recorder or recorded directly to the PC can be played back on the PC.

1 Click on the desired folder in the audio folder window.

2 Click on the desired file on the file list.

3 Click on the **PLAY** button to play back the file.

You can also perform other operations, such as fast-forwarding, rewinding, etc., with the buttons and controls on the playback controller panel.

Note

You cannot play back the files stored on the recorder by Olympus Digital Wave Player on the PC.

Playback Controller

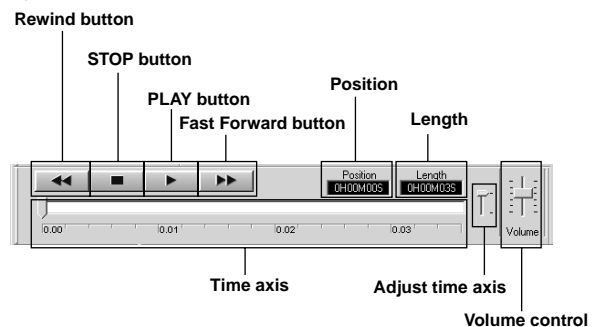

Recording on a PC with the recorder as the microphone (Direct recording)

The files are recorder directly on the PC and not on the recorder.

Before recording, make sure the recorder is connected to the PC properly.

1 Click on the button in the main window to display the recording window.

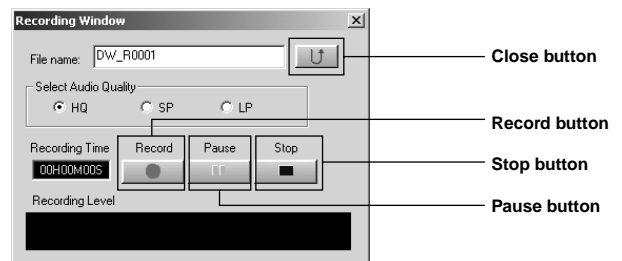

2 Click on the (Record) button to start recording.

The MICSSENS switch is adjustable to meet your recording needs.

3 Click on the (Stop) button to stop recording.

If you press the button, the recording window changes to the main window.

The recorded files are stored in the recording folder in the audio folder window.

To pause recording, click on the (pause) button during recording.

Notes

- To perform direct recording, 20MB or more of the hard-disk space is necessary to assure stable performance of the PC.
- The recorded files are stored as .wav files. Before recording, make sure that the free memory of the PC is sufficient for recording a .wav file. (See "File Format.")

Other Functions of Olympus Digital Wave Player

Intro Scan of the first 5 seconds of each file

All files in the selected folder are played back in turn.

1 Click on the desired file on the file list.

2 Click on the button on the tool bar. Playback starts.

3 Click on the **STOP** button.

4 Click on the **PLAY** button. To stop the playback, click on the STOP button.

Creating Subfolders

You can create subfolders under the audio folders to organize files.



Note

You cannot create subfolders under the schedule folder or the date subfolders contained in it.

- 1 Click on the desired folder under which to create subfolders.
- 2 Click on [Edit], then Click on [Create New Folder].
- 3 Enter a name for the new subfolder, and then Click on [OK].

Your new subfolder appears in the window.

You can move files by dragging and dropping files from a file list to other folder in the audio or recorder folder window.

Setting the Time/Date Using the PC

You can set the time and date of the recorder by uploading the connected PC's time/date.

- 1 Connect the recorder to the PC, click on [Transfer] on the menu bar, and then click on [Transfer Options].

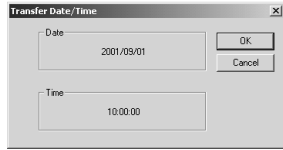

- 2 Click on [OK].

The time and date on the PC are transferred to the recorder.

File Format

The files transferred to the PC or recorded directly on a PC are stored as .wav files. Such filenames use the .wav extension.

Measure of size of file and time for transfer (5 minutes of recording with the recorder)

	Size of file	*Time for transfer
HQ mode	Approx. 3.2MB	Approx. 1 minute
SP mode	Approx. 1.6MB	Approx. 30 seconds
LP mode	Approx. 1.2MB	Approx. 15 seconds

* Transfer time may vary depending on the performance and configuration of your PC.

For Safe And Correct Usage

Read this manual carefully to ensure that you know how to operate it safely and correctly. Keep this manual in an easily accessible location for future reference.

- The warning symbols indicate important safety related information. To protect yourself and others from personal injury or damage to property, it is essential that you always heed the warnings and information provided.

General Precautions

- Do not leave the recorder in hot, humid locations such as inside a closed automobile under direct sunlight or on the beach in the summer.
- Do not store the recorder in places exposed to excessive moisture or dust.
- Do not use organic solvents such as alcohol and lacquer thinner to clean the unit.
- Do not place the recorder on top of or near electric appliances such as TVs or refrigerators.
- Avoid sand or dirt. These can cause irreparable damage.
- Avoid strong vibrations or shocks.
- Do not disassemble, repair or modify the unit yourself.
- Do not operate the unit while operating a vehicle (such as a bicycle, motorcycle, or go-cart).
- Keep the unit out of the reach of children.

Batteries

⚠ Warning

- Batteries should never be exposed to flame, heated, short-circuited or disassembled.
- Do not attempt to recharge alkaline, lithium or any other non-rechargeable batteries.
- Never use any battery with a torn or cracked outer cover.
- Keep batteries out of the reach of children.
- If you notice anything unusual when using this product such as abnormal noise, heat, smoke, or a burning odor:

- ① remove the batteries immediately while being careful not to burn yourself, and;
- ② call your dealer or local Olympus representative for assistance.

Troubleshooting

Q1 Nothing happens when a button is pressed.

- A1
- The HOLD button may be set to HOLD.
 - The batteries may be depleted.
 - The batteries may be inserted incorrectly.
 - The battery cover may not be closed tightly.

Q2 No sound is heard.

- A2
- The volume may be set to the minimum level.
 - The earphone plug may be plugged into the recorder.

Q3 Recording is not possible.

- A3
- The remaining recording time in the selected folder may have reached "0m00s".
 - The number of recorded files in the selected folder may have reached 100.
 - The number of files of the same date in folder S may have reached 15.

Q4 The playback speed is too fast.

- A4
- The recorder may be set to Fast Playback.

Q5 The remaining recording time seems too short.

- A5
- Are there files stored in other date subfolders?

Q6 You cannot move the file.

- A6
- The number of recorded files in the destination folder may have reached 100.

Q7 No sound is heard from the PC.

- A7
- Make sure that the sound volume of the PC is not muted.

Technical Assistance And Support

The following are for only technical questions and support about Olympus Digital Wave Player.

- ◆ Technical Hotline Number in the U.S. and Canada
1-888-553-4448

- ◆ User Support E-mail address in the U.S. and Canada
distec@olympus.com

- ◆ Technical Hotline Number in Europe

Toll free number
00800 67 10 83 00

available for Austria, Belgium, Denmark, France, Germany, Netherlands, Norway, Sweden, Switzerland, United Kingdom

Charged numbers

+49 180 567 1083

available for Finland, Italy, Luxemburg, Portugal, Spain and Czech Republic

+49 40 23773 899

available for Greece, Croatia, Hungary and the rest of Europe

- ◆ User Support E-mail address in Europe

dss.support@olympus-europa.com

Specifications

Recording medium:

Recording time:

Built-in flash memory

HQ mode: Approx. 22 min.

SP mode: Approx. 33 min.

LP mode: Approx. 90 min.

Speaker:

Built-in ø 28 mm round dynamic speaker

Maximum power:

120 mW

Earphone jack:

ø 3.5 mm diameter, impedance 8 Ω

Power supply:

Two AAA (LR03 or R03) batteries

Continuous battery use time:

About 19 hours (use of alkaline batteries, measured value for continuous recording according to the specifications of our company)

Dimensions:

81(L) × 47.5(W) × 22.5(T) mm

Weight:

65 g including batteries

* The continuous battery use time may be reduced according to the battery type and the use conditions.

* Your recorded contents are for your personal use or pleasure only. It is prohibited to record copyrighted material without permission of the copyright holders according to copyright law.

* Specifications and design are subject to change without notice for improvement of performance.

Accessories (Optional)

Earphone : E99

Connecting cord (Earphone jack ↔ Microphone jack) : KA232*

Connecting cord (Mini miniplug → Miniplug) : PA3

Accessories marked* should be used in combination with the PA3 plug adapter.

Microsoft and Windows are registered trademarks of Microsoft Corporation.

Intel and Pentium are registered trademarks of Intel Corporation.

Macintosh and Apple are registered trademarks of Apple Computer, Inc.

Other product and brand names mentioned herein may be the trademarks or

registered trademarks of their respective owners.

Free Manuals Download Website

<http://myh66.com>

<http://usermanuals.us>

<http://www.somanuals.com>

<http://www.4manuals.cc>

<http://www.manual-lib.com>

<http://www.404manual.com>

<http://www.luxmanual.com>

<http://aubethermostatmanual.com>

Golf course search by state

<http://golfingnear.com>

Email search by domain

<http://emailbydomain.com>

Auto manuals search

<http://auto.somanuals.com>

TV manuals search

<http://tv.somanuals.com>