

**OLYMPUS**

**DIGITAL VOICE  
RECORDER**

**WS-823**

**WS-822**

**WS-821**

**USER MANUAL**

Getting started

1

Recording

2

Playback

3

FM radio

4

Menu

5

Use with a PC

6

Other information

7

Register your product on  
[www.olympus-consumer.com/  
register](http://www.olympus-consumer.com/register) and get additional  
benefits from Olympus!

Thank you for purchasing an Olympus digital voice recorder.  
Please read these instructions for information about using the product  
correctly and safely.

Keep the instructions handy for future reference.

---

To ensure successful recording, we recommend that you test the record  
function and volume before use.

**EN**

Download from [Www.Somanuals.com](http://Www.Somanuals.com). All Manuals Search And Download.

# Table of contents

<b>Names of parts</b> .....	4
Recorder.....	4
Display .....	5

## 1 Getting started

<b>Setup</b> .....	8
Inserting the battery.....	9
Turn the power ON.....	9
Setting the inserted battery .....	10
Setting the date/time.....	10
<b>Charging the battery</b> .....	11
Charging the battery by connecting to a PC's USB connector .....	11
Charging the battery by connecting to an AC adapter with a USB connection (model AS14; optional).....	13
<b>Batteries</b> .....	15
<b>Inserting/removing a microSD card</b> .....	17
Inserting a microSD card.....	17
Removing a microSD card.....	18
<b>Preventing accidental operation</b> .....	19
Setting HOLD mode.....	19
Releasing HOLD mode .....	19
<b>Turning the power OFF</b> .....	20
Turning the power OFF .....	20
<b>[Home] screen operations</b> .....	21
Selecting the mode.....	21
<b>Folders</b> .....	23
Folders for voice recordings.....	23
Folders for music playback.....	23
<b>Selecting folders and files</b> .....	24

## 2 Recording

<b>Recording</b> .....	26
Basic recording procedure.....	26
Pausing/resuming recording .....	28
Quickly checking a recording .....	28
Monitoring while recording.....	29
<b>Recording with an external microphone</b> .....	30
Recording with an external microphone .....	30
<b>Recording from another connected device</b> .....	31
Recording audio from another device with this recorder.....	31
Recording audio from this recorder with another device.....	31
<b>Changing the recording scene [Rec Scene]</b> .....	32
Changing the recording scene.....	32

## 3 Playback

<b>Playback</b> .....	34
Basic playback procedure.....	34
Playback through the earphones.....	35
Fast-forwarding.....	36
Rewinding .....	36
Skipping to the beginning of a file .....	37
Changing the playback speed/tone (voice changer*) .....	38
ABC repeat playback .....	40
<b>Index marks/temp marks</b> .....	43
Writing an index mark/temp mark.....	43
Erasing an index mark/temp mark.....	43
<b>Calendar Search function</b> .....	44
Using the Calendar Search function to search for a file.....	44
<b>Selecting preset playback settings template [Play Scene]</b> .....	45
Selecting a preset playback settings template .....	45
<b>Erasing files/folders</b> .....	46
Erasing files.....	46
Erasing a folder .....	47

## 4 FM radio

### (WS-823 model only)

<b>Before using the FM radio function</b> .....	48
<b>Presetting radio stations automatically</b> .....	49
Presetting a local radio station [By scanning] .....	49
<b>Listening to FM radio</b> .....	51
Listening to FM radio .....	51
Selecting the reception mode.....	52
<b>Adding preset radio stations</b> .....	53
Adding a radio station received manually as a preset station [Set manually].....	53
<b>Deleting preset radio stations</b> .....	55
Deleting an unneeded preset radio station.....	55
<b>Recording FM radio</b> .....	56
Recording FM radio.....	56

## 5 Menu

<b>Setting menu items</b> .....	58
Basic operation .....	58
<b>File menu [File Menu]</b> .....	61
Extracting the speaking portions of files of spoken-word content [Voice Detect] .....	61

# Table of contents

Preventing accidental file erasure [File Lock].....	61
Sorting files [Sort by].....	61
Moving/copying files [Move/Copy].....	62
Dividing files [File Divide].....	62
Displaying file or folder information [Property].....	62
<b>Recording menu [Rec Menu].....</b>	<b>63</b>
Selecting the recording sensitivity [Rec Level].....	63
Setting the recording mode [Rec Mode].....	64
Selecting microphone directivity [Zoom Mic].....	64
Reducing noise during recording [Low Cut Filter].....	65
Voice-activated recording function [VCVA].....	65
Voice sync recording function [V-Sync. Rec].....	67
<b>Playback menu [Play Menu].....</b>	<b>69</b>
Skipping non-voice portions during playback [Voice Playback].....	69
Alternating repeatedly between normal and muted playback [Shadowing].....	69
Reducing noise during playback [Noise Cancel].....	70
Adjusting low volume portions during playback [Voice Balancer].....	70
Emphasizing voice more clearly [Voice Filter].....	71
Selecting playback modes [Play Mode].....	71
Changing music sound quality [Equalizer].....	73
Setting a skip space [Skip Space].....	73
Setting a preset playback settings template [Play Scene].....	74
<b>LCD/Sound menu [LCD/Sound Menu].....</b>	<b>75</b>
Setting the backlight [Backlight].....	75
Adjusting the contrast [Contrast].....	75
Setting the LED indicator light [LED].....	75
Turning beeping sound ON/OFF [Beep].....	75
Changing the display language [Language].....	76
Selecting the speaker output [Speaker].....	76
<b>Device menu [Device Menu].....</b>	<b>77</b>
Selecting the recording media [Memory Select].....	77
Setting power save mode [Power Save].....	77
Setting the battery in use [Battery].....	77
Setting the date/time [Time & Date].....	78
Setting the USB connection [USB Settings].....	79
Restoring the default settings [Reset Settings].....	79
Formatting a recording media [Format].....	80
Checking recording media information [Memory Info.].....	80
Checking voice recorder information [System Info.].....	80
<b>FM menu [FM Menu].....</b>	<b>81</b>
Selecting the recording sound quality [Rec Mode].....	81
Presetting a radio station [Set stations].....	81
Setting scanning sensitivity [Scan Level].....	81
Selecting the FM radio output [Output].....	81
<b>Extracting the speaking portions of files of spoken-word content [Voice Detect].....</b>	<b>82</b>
Extracting the speaking portions of files of spoken-word content [Voice Detect].....	82
<b>Moving/copying files [Move/Copy].....</b>	<b>84</b>
Moving/copying files [Move/Copy].....	84
<b>Dividing files [File Divide].....</b>	<b>87</b>
Dividing a file [File Divide].....	87
<b>Setting the USB connection [USB Settings].....</b>	<b>89</b>
Setting the USB connection [USB Settings].....	89
<b>Formatting recording media [Format].....</b>	<b>91</b>
Formatting a recording media [Format].....	91

<b>6 Use with a PC</b>	
<b>PC operating environment.....</b>	<b>93</b>
<b>PC connection/disconnection.....</b>	<b>95</b>
Connecting the voice recorder to a PC.....	95
Disconnecting the voice recorder from a PC.....	96
<b>Loading a file to a PC.....</b>	<b>97</b>
<b>Usage as external memory of the PC.....</b>	<b>98</b>

  

<b>7 Other information</b>	
<b>Alarm message list.....</b>	<b>99</b>
<b>Troubleshooting.....</b>	<b>101</b>
<b>Recorder care.....</b>	<b>104</b>
<b>Accessories (optional).....</b>	<b>105</b>
<b>Copyright and trademark information.....</b>	<b>106</b>
<b>Safety precautions.....</b>	<b>107</b>
<b>Specifications.....</b>	<b>111</b>

# Names of parts

## Recorder

Names of parts

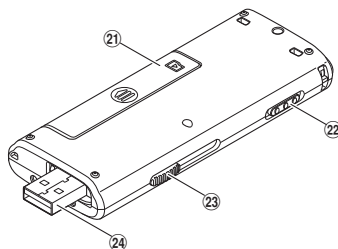
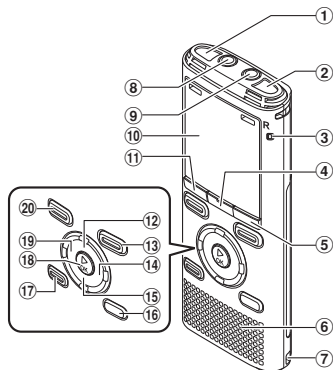

- ① Built-in stereo microphone (L)
- ② Built-in stereo microphone (R)
- ③ LED indicator light (LED)
- ④ MENU/SCENE button
- ⑤ F2 button
- ⑥ Built-in speaker
- ⑦ Strap hole
- ⑧ EAR (earphone) jack
- ⑨ MIC (microphone) jack
- ⑩ Display
- ⑪ F1 button
- ⑫ + button
- ⑬ REC (record) (●) button

- ⑭ ►► button
- ⑮ – button
- ⑯ LIST button
- ⑰ ERASE button
- ⑱ ►OK button
- ⑲ ◀◀ button
- ⑳ STOP (■) button
- ㉑ Battery/card cover
- ㉒ POWER/HOLD switch
- ㉓ USB connector slide lever
- ㉔ USB connector/USB connector cover (retractable)

## Display

### ■ [Recorder] mode

Folder list display

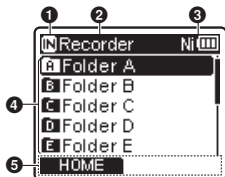

File list display

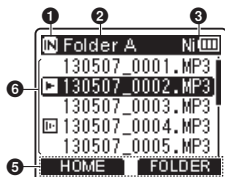

File display

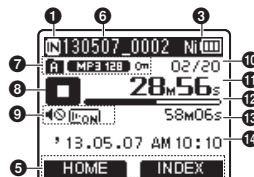

#### 1 Recording media indicator

: Internal memory

: microSD card

#### 2 Current folder name

#### 3 Battery indicator

#### 4 Folder name

#### 5 Function button guide display

#### 6 File name

: Playback indicator

: Voice Detect\*

#### 7 Folder indicator, recording format indicator and file lock indicator

#### 8 Voice recorder status indicator

: Recording indicator

: Recording pause indicator

: Stop indicator

: Playback indicator

: Fast forward indicator

: Fast rewind indicator

: Fast playback indicator

: Slow playback indicator

: Modified tone playback indicator\*  
(High)

: Modified tone playback indicator\*  
(Low)

#### 9 Speaker muting indicator (Muting) and voice playback indicator\* (Voice Detect)

#### 10 Current file number in folder/Total number of recorded files in folder

#### 11 Elapsed recording time or playback time

#### 12 Remaining memory bar indicator or playback position bar indicator

#### 13 Possible recording time remaining or file length

#### 14 Level meter or recording date/time

\*WS-823 and WS-822 models only

# Names of parts

## Display

### ■ [Music] mode

#### List display ①

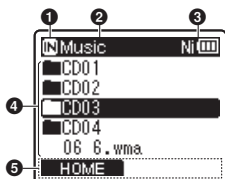

When folder contains files and folders

#### List display ②

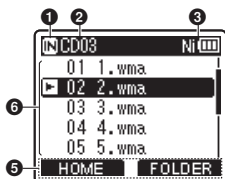

When folder contains only files

#### File display

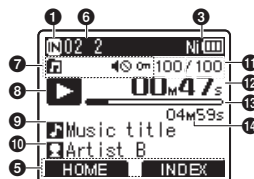

#### ① Recording media indicator

: Internal memory

: microSD card

#### ② Current folder name

#### ③ Battery indicator

#### ④ Folder name or file name

#### ⑤ Function button guide display

#### ⑥ File name

Playback indicator

#### ⑦ Folder indicator, speaker muting indicator () and file lock ()

#### ⑧ Voice recorder status indicator

: Playback indicator

: Stop indicator

: Fast forward indicator

: Fast rewind indicator

: Fast playback indicator

: Slow playback indicator

: Modified tone playback indicator\* (High)

: Modified tone playback indicator\* (Low)

#### ⑨ Music title

#### ⑩ Artist name

#### ⑪ Current file number in folder/Total number of recorded files in folder

#### ⑫ Elapsed playback time

#### ⑬ Playback position bar indicator

#### ⑭ File length

\* WS-823 and WS-822 models only

## Display

### ■ [FM Radio] mode

**!** WS-823 model only

#### Radio reception display

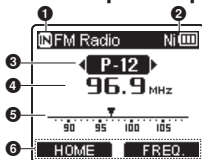

#### Radio recording display

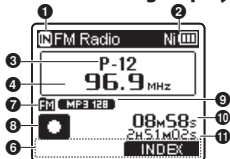

- 1 Recording media indicator
- 2 Battery indicator
- 3 Preset number being received
- 4 Radio frequency being received
- 5 Radio frequency bar indicator
- 6 Function button guide display
- 7 Folder indicator
- 8 Voice recorder status indicator

: Recording indicator

: Recording pause indicator

### 9 Recording format indicator

### 10 Elapsed recording time

### 11 Possible recording time

#### TIP

- Pressing and holding the **STOP** () button while the voice recorder is in stop mode displays the [Time & date] and [Remain] (amount of possible recording time remaining) settings. If the current date/time is set incorrectly, see "Setting the date/time [Time & Date]" (≡P.78).

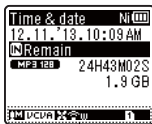

Indicator display area

#### — Meanings of indicators shown in indicator display area (same for all modes)

- : Rec Level
- : VCVA
- : V-Sync. Rec
- : Equalizer
- : Low Cut Filter
- : Zoom Mic<sup>1</sup>
- : Noise Cancel
- : Voice Balancer<sup>2</sup>  
Voice Filter<sup>3</sup>
- : Play Mode

\*1 WS-823 model only

\*2 WS-823 and WS-822 models only

\*3 WS-821 model only

# Getting started

## Setup

1

After unpacking the voice recorder, follow the steps below to have it ready for use.

Getting started **1**

### Insert the battery

Getting started **2**

### Turn the power ON

Getting started **3**

### Select the battery setting

Select the battery setting to match the inserted battery. Select the setting for a nickel-metal hydride rechargeable battery or the setting for an alkaline battery.

Getting started **4**

### Setting the date/time

Set the voice recorder's clock for use with file management.

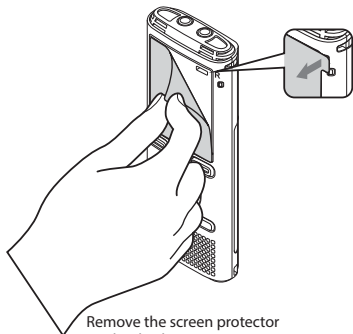

Remove the screen protector on the display.



## Inserting the battery

Before using the voice recorder, insert the battery in the battery compartment of the voice recorder.

- 1 Slide open the battery/card cover while lightly pressing down on it.

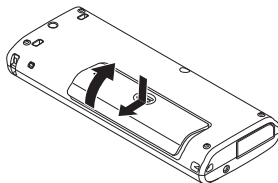

- 2 Insert a AAA battery, making sure its positive and negative terminals are placed correctly. Slide the battery/card cover completely closed.

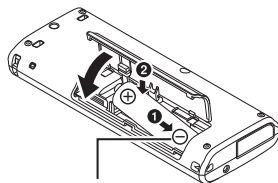

Insert the battery's negative terminal first

## Turn the power ON

- 1 While the voice recorder is turned off, slide the **POWER/HOLD** switch in the direction of the arrow.

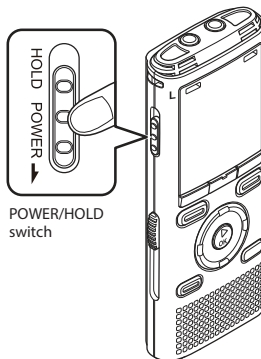

## Setting the inserted battery

- 1 Press the +/– button to select the type of battery you inserted.



[Ni-MH]

Select if you inserted an Olympus nickel-metal hydride rechargeable battery (model BR404).

[Alkaline]

Select if you inserted an alkaline battery.

- 2 Press the ►OK button to finalize the setting.

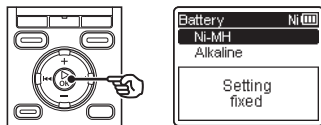

### NOTE

- See “**Setting the date/time**” if a time display with a blinking cursor on the hour appears in the display after setting the battery.

## Setting the date/time

- 1 Press the ►► or ◀◀ button to select the item to set.

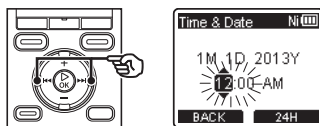

- 2 Press the +/– button to change the number.

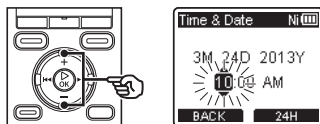

- To change the setting of another item, press the ►► or ◀◀ button to move the blinking cursor, then press the + or – button to change the number.

- 3 Press the ►OK button to finalize the setting.

### TIP

- You can press the ►OK button during the setting procedure to set the items entered so far and start the clock.
- You can change the clock display format. See “**Setting the date/time [Time & Date]**” (P.78) for the procedure.

# Charging the battery

## Charging the battery by connecting to a PC's USB connector

**!** WS-823 and WS-822 models only

### NOTE

- Before connecting the USB connector, release HOLD mode (P.19).

- 1 Start the PC.
- 2 Slide the USB connector slide lever in the direction of the arrow.

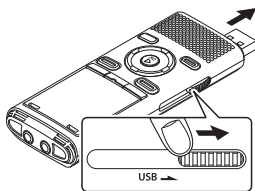

- The USB connector extends out. The USB connector cover is stored inside the voice recorder.

- 3 After making sure the voice recorder is stopped, connect the USB connector to a USB port on a PC.

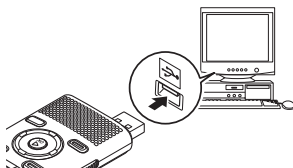

- 4 Press the ►OK button to start charging the battery.

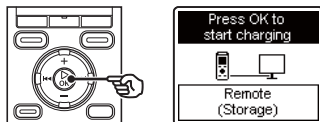

- When [Battery] (P.77) is set to [Ni-MH], [Press OK to start charging] appears on the display. Press the ►OK button while this message is blinking.

# Charging the battery

1

Charging the battery

- 5** Charging has finished when the battery indicator changes to .

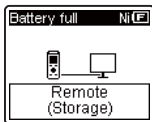

Charging time: About 3 hours\*

\* Approximate time needed to fully charge a completely flat battery at room temperature.

Battery charging time will depend on the amount of remaining power and the state of the battery.

## NOTE

- Never attempt to charge an alkaline battery, lithium battery or other primary cell battery. Fluid leakage or overheating may cause the recorder to malfunction.

# Charging the battery

## Charging the battery by connecting to an AC adapter with a USB connection (model A514; optional)

1

Charging the battery

**!** WS-823 and WS-822 models only

### NOTE

- Before connecting the AC adapter, select **[AC Adapter]** for the USB connection setting (☞ P.89).
- Before connecting the AC adapter, release HOLD mode (☞ P.19).

- 1 Connect the voice recorder to the USB connector on the AC adapter.**

To USB connector of AC adapter (model A514)

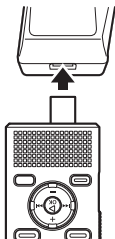

- 2 Connect the AC adapter to an AC power outlet.**

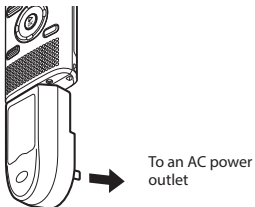

- 3 Press the ►OK button to start charging.**



Press OK to start charging

- When **[Battery]** (☞ P.77) is set to **[Ni-MH]**, **[Press OK to start charging]** appears on the display. Press the ►OK button while this message is blinking.

# Charging the battery

1

Charging the battery

## 4 Charging is finished when [Battery full] appears.

When charged with the power turned off

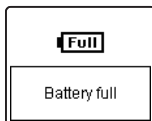

Displayed when the battery is fully charged

When charged with the power turned on

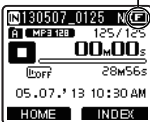

### NOTE

- Use only the Olympus USB connecting AC adapter model provided (A514).

### NOTE

- The power of the PC must be ON to charge the battery using the USB connector.  
You cannot charge the battery when the power of the PC is OFF, or the PC is in standby, sleep or auto power OFF mode.
- Do not use a USB hub when charging the battery by connecting to the PC.
- Before charging the battery, insert the rechargeable battery provided and set **[Battery]** to **[Ni-MH]**.
- You cannot charge the battery if **[C]**<sup>\*1</sup> or **[H]**<sup>\*2</sup> is blinking. Charge the battery in an ambient temperature of between 5 and 35°C (41 and 95°F).
  - \*1 **[C]** Ambient temperature is too low.
  - \*2 **[H]** Ambient temperature is too high
- If battery life has become noticeably short on a full charge, replace the battery with a new one.
- Insert the USB connector securely all the way. Operation will not be normal if the connection is not made properly.
- Use the USB extension cable provided if needed (only for WS-823 model).
- Use only a compatible Olympus USB extension cable. Operation is not guaranteed if another manufacturer's cable is used. Only use the Olympus USB extension cable with the voice recorder and never use if a product from another manufacturer is used.
- To charge the battery with **[USB Settings]** set to **[Composite]**, set **[USB Connection]** to **[Optional]** before connecting the USB cable.  
When you select **[AC Adapter]** for the **[USB Connection]** you can charge the battery (P.89).

EN

14

## Rechargeable batteries

Read the information below carefully when using a nickel-metal hydride rechargeable battery (model BR404).

### ■ Discharging

Rechargeable batteries discharge naturally when not in use. Be sure to charge the battery before use.

### ■ Operating temperature

Rechargeable batteries are chemical-based products. Their performance can vary even when used within the recommended operating temperature range. This variation is normal.

### ■ Recommended temperature ranges

When powering voice recorder: 0 to 42°C (32 to 107.6°F)

When being charged: 5 to 35°C (41 to 95°F)

During long-term storage: -20 to 30°C (-4 to 86°F)

Use of a rechargeable battery outside the temperature ranges above may result in drops in battery performance or life. When not using the voice recorder for an extended period, remove the rechargeable battery before storage to prevent fluid leakage or rust.



## NOTE

- Due to the nature of nickel-metal hydride rechargeable batteries, new batteries and batteries not used for an extended period (one month or more) may not charge completely. The battery should become fully charged after charging and discharging the battery up to three times.
- Always dispose rechargeable batteries in the legally prescribed manner. Before disposing rechargeable batteries that are not fully discharged, take steps to prevent shorting such as insulating their terminals with tape.

## Battery indicator

As the battery loses its remaining charge, the battery indicator on the display changes as follows:



-  indicates there is little remaining battery charge. Charge the battery or replace it with a fresh one. When the battery has run out,  and **[Battery low]** appear, and operation stops.

#### Battery precautions

- The voice recorder does not support manganese batteries.
- Always turn power off before replacing the battery. Files may be damaged if the battery is removed while the voice recorder is recording or performing an operation such as erasing a file.
- You may need to reset the date/time if the battery is removed from the voice recorder for over one minute, or if the battery is quickly removed and replaced. See “**Setting the date/time [Time & Date]**” (☞ P.78) for the procedure.
- When not using the voice recorder for an extended period, always remove the battery before storage.
- When replacing the battery, use an AAA alkaline dry cell battery or an Olympus nickel-metal hydride rechargeable battery (model BR404).
- When buying rechargeable batteries, always select model BR404 nickel-metal hydride rechargeable batteries. Operation is not guaranteed. If a battery from another manufacturer is used.
- Even if the battery indicator is , playback with the built-in speaker at some volumes may result in a drop in battery output voltage, causing the voice recorder to reset. Lower the volume in this case.
- The continuous battery usage time is reduced when using a microSD card (☞ P.113).
- The continuous battery usage time will vary depending on the performance of the battery in use (☞ P.113).
- The continuous battery usage time of a nickel-metal hydride rechargeable battery that has been used repeatedly will be reduced due to battery degradation (☞ P.113).
- The **[Battery]** screen appears automatically after you have replaced the battery. You can also use a menu operation to display this screen and set the battery (☞ P.77).



# Inserting/removing a microSD card

The voice recorder has its own internal memory, and also supports standard microSD cards (microSD, microSDHC) sold separately.

## Inserting a microSD card

- 1 While the voice recorder is in stop mode, open the battery/card cover.**

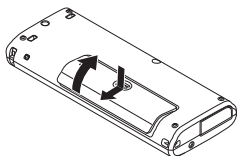

- The microSD card slot is inside the battery/card cover.

- 2 Insert a microSD card, making sure it is placed correctly as shown.**

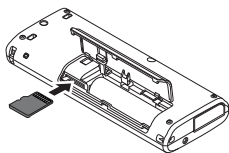

- Insert the microSD card straight, avoiding crooked insertion.
- Inserting a microSD card the wrong way or crookedly could damage its contact surface or cause it to jam in the slot.
- A microSD card not inserted fully (until it clicks into place) might not record data.

- 3 Close the battery/card cover.**

- The recording media selection screen appears after a microSD card has been inserted.

- 4 To record onto the microSD card, press the +/- button and select [Yes].**

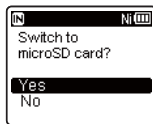

- 5 Press the ►OK button to finalize the setting.**

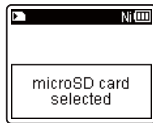

### TIP

- You can also select the internal memory as the recording media (☞ P.77).

### NOTE

- The voice recorder may not be able to recognize a microSD card formatted (initialized) for a PC or other device. Before using a microSD card, always initialize it on the voice recorder (☞ P.91).

# Inserting/removing a microSD card

## Removing a microSD card

1

- 1 While the voice recorder is in stop mode, open the battery/card cover.

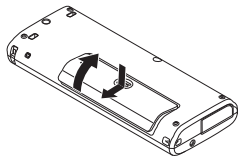

- 2 Release the microSD card by pressing it inward, then letting it slowly return.

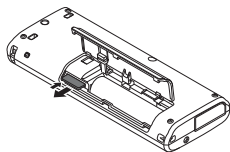

- The microSD card moves outward and stops. Pull the microSD card out with your fingertips.
- **[Internal memory selected]** is displayed after removing a microSD card if **[Memory Select]** was set to **[microSD card]**.

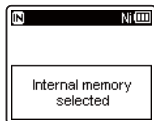

### NOTE

- microSD cards may pop out forcefully on removal if you flick or release your finger too quickly after pressing the card in.
- Depending on the card's manufacturer and type, some microSD cards and microSDHC cards may not be fully compatible with the voice recorder and not be recognized properly.
- For microSD card compatibility under Olympus verification, please contact our customer support at:

<http://www.olympusamerica.com>

Note that our customer support will provide information on microSD card manufacturers and card types for which Olympus has verified operation, but will not guarantee it's performance. Also note that some cards may no longer be recognized correctly by the voice recorder in case card manufacturer changes card specifications.

- Read the operating instructions provided with the card when using a microSD card.
- If a microSD card is not recognized by the voice recorder, try removing and reinserting the card to have the voice recorder attempt recognition again.
- Processing speed may be low for some microSD card types. Processing performance may also be reduced by writing or deleting data repeatedly from a microSD card. In this case, reinitialize the card (P.91).

- 3 Close the battery/card cover.

# Preventing accidental operation

Setting the voice recorder to HOLD mode maintains the current operation and disables button operations. HOLD mode is a handy feature for preventing unintentional operation from accidental button presses when the voice recorder is carried in a bag or pocket. It is also useful for preventing the voice recorder being accidentally stopped during recording.

## Setting HOLD mode

- 1 Slide the **POWER/HOLD** switch to the **[HOLD]** position.

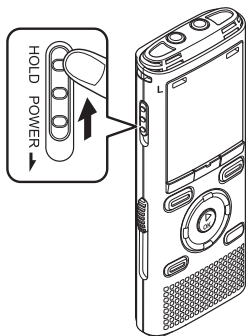

## Releasing HOLD mode

- 1 Slide the **POWER/HOLD** switch to position **A** shown below.

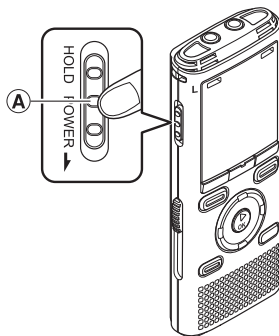

- **[Hold]** appears in the display, and the recorder enters HOLD mode.

### NOTE

- When any button is pressed during HOLD mode, **[Hold]** appears in the display for 2 seconds. No other operation is performed.
- Setting HOLD mode during voice recorder playback (or recording) continues the playback (or recording) operation and prevents any other operation from being performed (the voice recorder stops when playback ends, or recording stops when there is no more available memory).

# Turning the power OFF

## Turning the power OFF

1

Existing data, mode settings and the clock setting are saved when the power is turned OFF.

- 1 Slide the **POWER/HOLD** switch in the direction of the arrow for at least half a second.

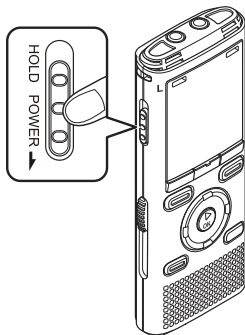

- The playback stop position at power OFF is stored in memory.

### TIP

- Turning the power OFF whenever the voice recorder is not in use minimizes battery consumption.

### Power Save mode

When the voice recorder has been stopped for at least 10 minutes (default setting) after power ON, the display disappears and the voice recorder automatically enters the Power Save mode (P.77).

- Pressing any button releases the Power Save mode.

# [Home] screen operations

## Selecting the mode

In addition to its recording function, the voice recorder also provides music player and FM radio\* functions. Choose the application you want by selecting one of the voice recorder's modes.

\* WS-823 model only

- 1 Press the F1 (HOME) button to display the [Home] screen.**

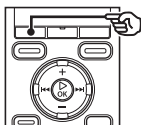

For WS-823 model



For WS-822 and  
WS-821 models

- 2 Press the +/-, >>> or <<<, button to select the desired mode.**

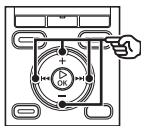

- In WS-822 and WS-821 models, you can only use the >>> or <<< button to select modes.

- 3 Press the ► OK button.**

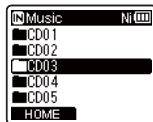

# [Home] screen operations

1

[Home] screen operations

## When [Recorder] is selected

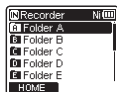

The voice recorder enters **[Recorder]** mode. Audio can be recorded with the built-in microphone.

Files recorded with the microphone or from the FM radio\* can also be played back (☞ P.26, P.34).

## When [Music] is selected

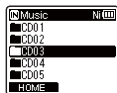

The voice recorder enters **[Music]** mode. In this mode you can play music files transferred to the voice recorder (☞ P.34).

## When [Calendar Search] is selected



The voice recorder enters **[Calendar Search]** mode. In this mode you can search for files by specifying the recording date (☞ P.44).

## When [FM Radio]\* is selected

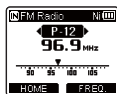

The voice recorder enters **[FM Radio]** mode. In this mode you can listen to FM radio (☞ P.48, P.51).

\* WS-823 model only

# Folders

In addition to its own internal memory, the voice recorder can also use microSD cards as a data recording media. Sound files, music files and content files stored on either media are saved in folders arranged in a tree structure. You can specify any playback sequence for the music files in the **[Recorder]** and **[Music]** folder (see P.61).

## Folders for voice recordings

Sound files recorded by the voice recorder are saved in the folders labeled **[Folder A]** to **[Folder E]** in the **[Recorder]** folder.

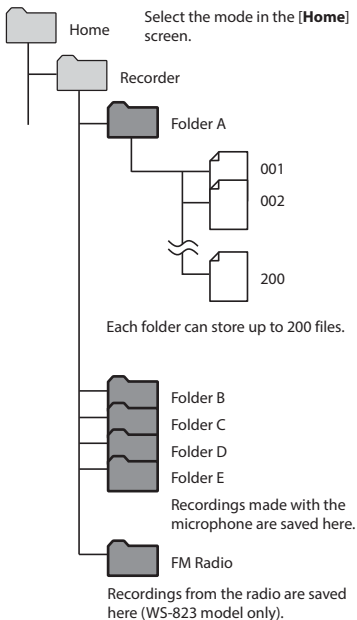

Files and folders placed directly within the **[Recorder]** folder (not within one of the sub-folders) are not displayed by the voice recorder.

## Folders for music playback

When music files created using Windows Media Player are transferred to the voice recorder, folders are created automatically for them within the folder for music playback, using the hierarchical structure shown below.

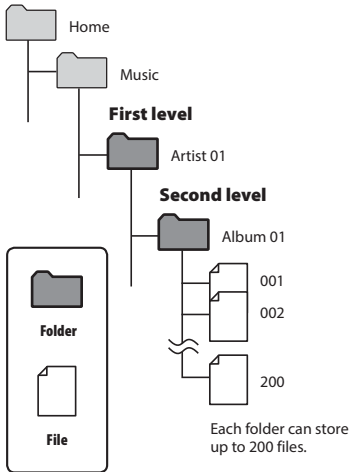

Up to 300\* folders can be created within the **[Music]** folder (including a **[Music]** folder itself).

\* Up to 130 folders for WS-821 model.

The voice recorder can only recognize two folder sublevels.

# Selecting folders and files

You can select a different folder while the voice recorder is in stopped or playing a file. See **"Folders"** (P.23) for a description of the voice recorder's hierarchical folder structure.

1

Selecting folders and files

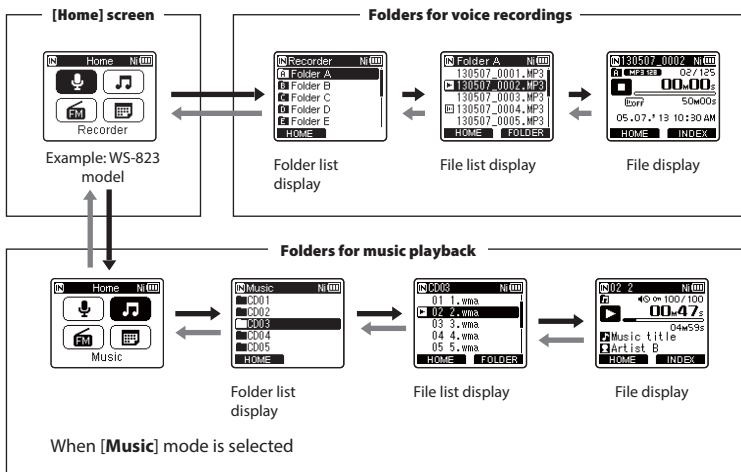

## → Forward: ► OK button

Each press of the ► OK button opens the currently selected folder or file in the list, moving forward to the next (lower) level in the folder hierarchy. When a list is displayed, you can perform the same function by pressing the ►► I button.

## ← Back: LIST button

Each press of the LIST button moves back to the previous (higher) level in the folder hierarchy. When a list is displayed, you can perform the same function by pressing the I◀◀ button.

## TIP

- When navigating through a folder hierarchy, you can press and hold the LIST button to return to the file display.



# Selecting folders and files

---

## **+/- button**

Used to select a folder or file.

## **[Home] screen**

Used to select the voice recorder mode  
(☞ P.21).

## **List display**

Displays the folders and files recorded in  
the voice recorder.

Pressing the **F2 (FOLDER)** button changes  
the display to the list display of the next  
folder.

## **File display**

Displays the information of the selected file.

# Recording

## Recording

The voice recorder has five folders (F01 to F05) in which recorded files can be saved. These folders provide a handy way to sort recordings into separate categories (such as business and leisure).

2

Recording

### Basic recording procedure

**1 Press the +/-, |◀◀ or ▶▶| button in the [Home] screen and select [Recorder], then press the ▶OK button (see P.21).**

**2 Select the folder to save the recording in (see P.24).**

- Each new voice recording file is saved in the selected folder.

**3 Point the built-in microphone in the direction of the sound to record.**

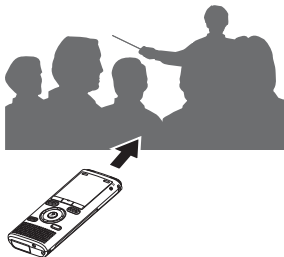

**4 Press the REC (●) button to start recording.**

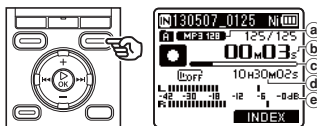

- a Rec Mode
- b Elapsed recording time
- c Remaining memory bar indicator
- d Remaining possible recording time
- e Level meter (changes according to recording volume and recording function setting)

- The LED indicator light lights, and [●] appears in the display.

**5 Press the STOP (■) button when you want to stop recording.**

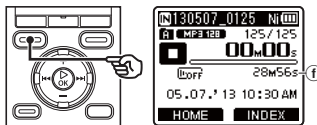

- f File length

- [■] appears in the display.

EN

26

Sound files recorded with the voice recorder are automatically given a file name in the format below.

**131001\_0001.WMA**

①

②

③

### ① Date recorded

Indicates the year, month and day the recording was made.

### ② File number

Appended file numbers are consecutive regardless of whether the recording media has been switched.

### ③ Extension

A file extension indicating the recording format the file was recorded in by the voice recorder.

- Linear PCM format: **“.WAV”**\*
- MP3 format: **“.MP3”**
- WMA format: **“.WMA”**

\* WS-823 and WS-822 models only

## TIP

- **[Rec Mode]** must be set with the voice recorder stopped (P.81).
- Pressing the **REC (●)** button while **[Recorder]** is selected on the **[Home]** screen will allow you to start recording. The recorded file will be saved to **[Folder A]**.

### WS-823 model only

- You can record radio broadcasts by selecting **[FM Radio]** mode (P.56).
- You can adjust the recording level manually to match your application (P.63).

## NOTE

- To prevent the beginning of the recording being cut off, start recording after the LED indicator light has lit or mode indicator has appeared in the display.
- When the remaining possible recording time is 60 seconds, the LED indicator light starts flashing. It flashes more rapidly as the remaining time decreases (at the 30- and 10-second points).
- When **[Folder full]** appears, no more recording can be done. To record more, you will need to select a different folder or delete unneeded files (P.46).
- If **[Memory full]** appears, the voice recorder has no more available memory space. You will need to delete unneeded files to record more (P.46).
- When using a microSD card in the voice recorder, be sure the desired recording media setting (**[Internal memory]** or **[microSD card]**) has been selected (P.77).
- If a folder other than folders **[A]** to **[E]** is selected when the **REC (●)** button is pressed, the blinking message **[Cannot record in this folder]** appears. Redo the recording operation after selecting one of folders **[A]** to **[E]**.
- It's recommended to initialize the recording media before making an important recording.
- Processing performance may be reduced when data has been repeatedly written to or deleted from the recording media. Please initialize the recording media in this case (P.91).

## Recording linear PCM format files of over 2 GB

### ! WS-823 and WS-822 models only

When recording a linear PCM format file, recording will continue even after the file size exceeds 2 GB.

- The data is divided and saved in separate files of up to 2 GB. The files are processed as multiple files during playback.
- After recording 200 files which exceed 2GB recording stops.

## Pausing/resuming recording

### 1 Press the REC (●) button during recording.

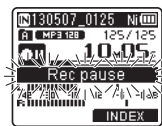

- Recording pauses, and the [●] indicator appears in the display along with the blinking message **[Rec pause]**.
- Recording is stopped automatically after being paused for at least 60 minutes.

### 2 Press the REC (●) button again while recording is paused.

- Recording resumes from the position it was paused at.

## Quickly checking a recording

### 1 Press the ►OK button during recording.

- [▶] appears in the display.
- Recording ends, and the file just recorded is played.

#### WS-823 model only

- When this operation is done while recording in **[FM Radio]** mode, **[Recorder]** mode is automatically selected and the file just recorded will be played.

## Monitoring while recording

You can monitor the recording as you are making it by listening on the earphone plugged into the voice recorder's **EAR** jack. Use the +/- button to adjust the recording monitor volume.

### 1 Connect the earphones to the voice recorder's EAR jack.



- Changing the volume will not affect the recording level.

#### NOTE

- To avoid unpleasantly loud sound, set the volume to **[00]** before plugging in the earphone.
- To prevent feedback, do not place the earphone near the microphone while recording.

## Recording settings

Various recording settings are available, letting you tailor recording to different recording conditions.

<b>[Rec Level]</b> ( <small>ESP</small> P.63)	Sets the recording sensitivity.
<b>[Rec Mode]</b> <sup>*1</sup> ( <small>ESP</small> P.64)	Sets the recording sound quality.
<b>[Zoom Mic]</b> <sup>*2</sup> ( <small>ESP</small> P.64)	Sets the built-in stereo microphone's directivity.
<b>[Low Cut Filter]</b> ( <small>ESP</small> P.65)	Reduces humming sounds from equipment such as air-conditioners or projectors.
<b>[VCVA]</b> ( <small>ESP</small> P.65)	Sets the trigger level for voice-activated recording (VCVA).
<b>[V-Sync. Rec]</b> ( <small>ESP</small> P.67)	Sets the trigger level for voice-synchronized recording.
<b>[Rec Scene]</b> ( <small>ESP</small> P.32)	Used to select one of multiple preregistered templates of recording settings. When selected, each template enters several settings tailored to a particular recording location or condition all in a single operation.

\*1 When **[FM Radio]** mode is set, **[Rec Mode]** is fixed at one of the settings below (WS-823 model only).

- **[MP3 256 kbps]**
- **[MP3 128 kbps]**

\*2 WS-823 model only

# Recording with an external microphone

## Recording with an external microphone

You can record audio input using an external microphone or other device connected to the voice recorder's microphone jack. Do not plug or unplug devices into voice recorder jacks while recording.

2

Recording with an external microphone

### 1 Connect an external microphone to the voice recorder's MIC jack.



#### NOTE

- Connecting an external microphone to the voice recorder's **MIC** jack disables the built-in microphone.
- Microphones with plug-in power supplies can be used.
- When [**Rec Mode**] is set to stereo, recording with an external mono microphone records on the left channel only (☞ P.64).
- When [**Rec Mode**] is set to mono, only the input from the left channel microphone is recorded when using an external stereo microphone (☞ P.64).

### 2 Start recording.

- See "**Recording**" (☞ P.26) for descriptions of recording operations.

#### TIP

- See "**Accessories (optional)**" (☞ P.105) for the compatible external microphones.

# Recording from another connected device

## Recording audio from another device with this recorder

Audio can be recorded when you have connected the audio output terminal (earphone jack) of another device and the **MIC** jack of the recorder using the connecting cord KA333 (optional) for dubbing.

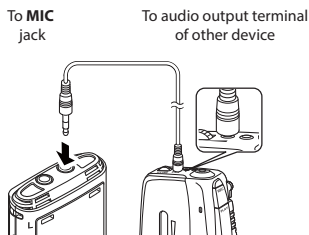

### NOTE

- When recording from a connected external device, perform a test recording and adjust the output level of the connected device as needed.

## Recording audio from this recorder with another device

Audio from this recorder can be recorded to another device by connecting the audio input terminal (microphone jack) of the other device and the **EAR** jack of this recorder using the connecting cord KA333 (optional).

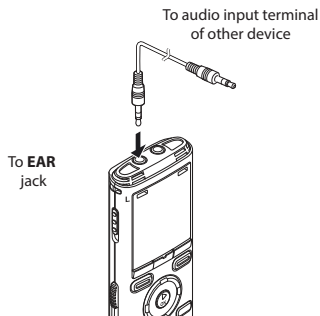

### NOTE

- Adjusting playback sound quality settings on the voice recorder affects the audio output signals output from the **EAR** jack (see P.69 to P.73).

# Changing the recording scene [Rec Scene]

## Changing the recording scene

The voice recorder has preregistered templates of optimum settings tailored to various recording applications such as lectures and dictation. When selecting one of these templates you can enter several settings recommended for your recording application all in a single operation.

2

Changing the recording scene [Rec Scene]

- 1 While the voice recorder is in stop mode, press and hold the **MENU/SCENE** button.

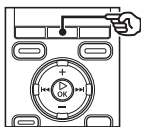

- 2 Press the **▶OK** button.

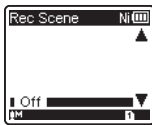

- 3 Press the **+/-** button to select the desired recording application.

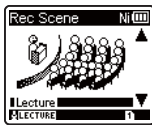

### TIP

- You can press the **▶▶** button to display the settings of the selected template. Press the **◀◀** button to return to the **[Rec Scene]** screen.

- 4 Press the **▶OK** button to finalize the setting.
- 5 Press the **STOP (■)** button to exit the selection screen.

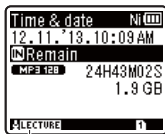

Rec Scene

- Press and hold the **STOP (■)** button when the recorder is stopped to check setting indicators meanings.

### NOTE

- Recording menu settings cannot be changed when a **[Rec Scene]** selection has been made. To use these functions, you must select **[Off]** for the **[Rec Scene]** setting.



# Changing the recording scene [Rec Scene]

## Preregistered [Rec Scene] settings

### [Lecture]

[Rec Level]	[High]
[Rec Mode]	[MP3 128 kbps]
[Zoom Mic]*	[+6]
[Low Cut Filter]	[On]
[VCVA]	[Off]
[V-Sync. Rec]	[Off]

### [Conference]

[Rec Level]	[Middle]
[Rec Mode]	[MP3 128 kbps]
[Zoom Mic]*	[Off]
[Low Cut Filter]	[On]
[VCVA]	[Off]
[V-Sync. Rec]	[Off]

### [Meeting]

[Rec Level]	[Middle]
[Rec Mode]	[MP3 128 kbps]
[Zoom Mic]*	[Off]
[Low Cut Filter]	[Off]
[VCVA]	[Off]
[V-Sync. Rec]	[Off]

### [Dictation]

[Rec Level]	[Low]
[Rec Mode]	[MP3 128 kbps]
[Zoom Mic]*	[Off]
[Low Cut Filter]	[On]
[VCVA]	[Off]
[V-Sync. Rec]	[Off]

### [DNS]

[Rec Level]	[Low]
[Rec Mode]	[MP3 128 kbps]
[Zoom Mic]*	[Off]
[Low Cut Filter]	[Off]
[VCVA]	[Off]
[V-Sync. Rec]	[Off]

\* WS-823 model only

# Playback

## Playback

In addition to files recorded by the voice recorder, you can also play files in WAV\*, MP3 and WMA format transferred from a PC.

\* WS-823 and WS-822 models only

### Basic playback procedure

3



Playback

#### 1 Select the file to play from the folder containing it (see P.24).

##### TIP

- Files are saved in the locations below.

**Files recorded with the built-in microphone:**

[Recorder] folders (folders  to 

**Files recorded from the radio:**  
[Recorder] folder ([FM Radio]\* folder)

**Music files transferred from a PC:**  
[Music] folder

\* WS-823 model only

#### 2 Press the ► OK button to start playback.



- Recording media indicator, file name and folder indicator
  - Elapsed playback time
  - Playback position bar indicator
  - File length
  - Recording date/time
-  appears in the display.

#### 3 Press the +/– button to adjust the volume to the desired level.



- The volume can be adjusted to a setting between [00] to [30]. The higher the number, the louder the volume.

#### 4 Press the STOP (■) button to stop playback.

-  appears in the display.
- The file being played stops right away. The resume function automatically stores the playback stop position in memory. The position is retained even if the power is turned OFF. The next time the power is turned ON, playback can be resumed from the stop position stored in the memory.

EN

34

## Playback settings

You can select various file playback methods tailored to different applications and tastes.

<b>[Voice Playback]</b> <sup>1*3</sup> ( <small>ESP</small> P.69)	Only plays voice portions of a recorded audio file.
<b>[Shadowing]</b> ( <small>ESP</small> P.69)	Plays segments of files, alternating repeatedly between playback and silence.
<b>[Noise Cancel]</b> <sup>2</sup> ( <small>ESP</small> P.70)	A setting that makes recorded voices more discernable when muffled by projector noise or similar sounds.
<b>[Voice Balancer]</b> <sup>1*3</sup> ( <small>ESP</small> P.70)	Compensates low-volume portions of recorded audio files during playback.
<b>[Voice Filter]</b> <sup>2*3</sup> ( <small>ESP</small> P.71)	Cuts low- and high-frequency components, emphasizing voices for greater clarity.
<b>[Play Mode]</b> ( <small>ESP</small> P.71)	Selecting from among three playback modes.
<b>[Equalizer]</b> <sup>4</sup> ( <small>ESP</small> P.73)	Adjusts the quality of sound as desired.
<b>[Skip Space]</b> ( <small>ESP</small> P.73)	A handy function for quickly moving the playback position, and playing short segments repeatedly.
<b>[Play Scene]</b> ( <small>ESP</small> P.74)	Selecting a package of settings recommended for your recording application in a single operation. Improves operability.

\*1 WS-823 and WS-822 models only

\*2 WS-821 model only

\*3 Function active only in **[Recorder]** mode.

\*4 Function active only in **[Music]** mode.

## Playback through the earphones

You can connect the earphones to the voice recorder's **EAR** jack and listen to playback through them.

### 1 Connect the earphones to the voice recorder's EAR jack.



### 2 Press the ►OK button to start playback.

#### TIP

- There will be no sound from the speaker when the earphones are connected.

#### NOTE

- To avoid unpleasantly loud sound, set the volume to **[00]** before plugging in the earphone.
- Avoid excessive volume when listening to playback through the earphones. It may cause hearing damage or loss.

## Fast-forwarding

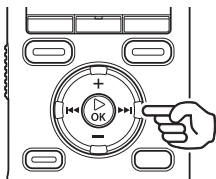

Fast-forwarding while the voice recorder is in stop mode

- 1 With the voice recorder stopped, press and hold the **▶▶|** button.
  - **[+]** appears in the display.
  - Fast-forwarding stops when you release the **▶▶|** button. Press the **▶OK** button to start playback from the current position.

### Fast-forwarding during playback

- 1 Press and hold the **▶▶|** button during playback.
  - Playback starts from the current position when you release the **▶▶|** button.
  - If an index mark or temp mark in the file is reached, fast-forwarding stops at the mark (☞ P.43).
  - Fast-forwarding stops when the end of the file is reached. Press and hold the **▶▶|** button again to fast-forward from the beginning of the next file.

## Rewinding

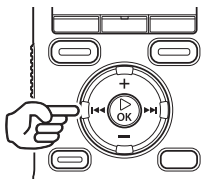

Rewinding while the voice recorder is in stop mode

- 1 With the voice recorder stopped, press and hold the **◀◀** button.
  - **[+]** appears in the display.
  - Rewinding stops when you release the **◀◀** button. Press the **▶OK** button to start playback from the current position.

### Rewinding during playback

- 1 Press and hold the **◀◀** button during playback.
  - Playback starts from the current position when you release the **◀◀** button.
  - If an index mark or temp mark in the file is reached, rewinding stops at the mark (☞ P.43).
  - Rewinding stops when the beginning of the file is reached. Press and hold the **◀◀** button again to rewind from the end of the previous file.

## Skipping to the beginning of a file

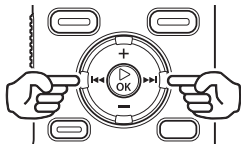

### Skipping to the beginning of the next file

- 1 Press the **▶▶|** button while the voice recorder is in stop mode, or during playback.

### Skipping to the beginning of the current file

- 1 Press the **|◀◀** button while the voice recorder is in stop mode, or during playback.

### Skipping to the beginning of the previous file

- 1 Press the **|◀◀** button when the playback position is the beginning of the file.
  - To skip to the beginning of the previous file during playback, press the **|◀◀** button twice consecutively.

## NOTE

- If an index mark or temp mark is reached when skipping to the beginning of a file during playback, playback starts from the position of the mark. When skipping to the beginning of a file while the voice recorder is in stop mode, the mark is ignored (E38 P.43).
- If a setting other than **[File Skip]** is set for **[Skip Space]**, playback starts after the set amount of time has been skipped backwards or forwards. Playback does not skip to the beginning of the file.

## Music files

If a music file transferred to the voice recorder is unplayable, check that its sampling rate, bit count and bit rate values are within the supported ranges. The sampling rate, bit count and bit rate combinations supported for music file playback by the voice recorder are shown below.

File format	Sampling rate	Bit count/ bit rate
WAV format*	44.1 kHz	16 bits
MP3 format	<b>MPEG 1 Layer 3:</b> 32 kHz, 44.1 kHz, 48 kHz <b>MPEG 2 Layer 3:</b> 16 kHz, 22.05 kHz, 24 kHz	8 to 320 kbps
WMA format	8 kHz, 11 kHz, 16 kHz, 22 kHz, 32 kHz, 44.1 kHz, 48 kHz	5 to 320 kbps

\* WS-823 and WS-822 models only

- MP3 files with variable bit rates (bit rates converted variably in a single file) may not play normally.
- Linear PCM-format WAV files are the only WAV files the voice recorder can play. Playback of other WAV files is not supported.
- Even if the file formats is compatible for playback on this recorder, the recorder does not support every encoder.

## Changing the playback speed/tone (voice changer\*)

You can change the playback speed and audio tone\*. Changing the playback speed is handy for speeding up conference presentations, or for slowing down parts difficult to discern when learning a language.

\* WS-823 and WS-822 models only

### 1 Press the ► OK button during playback.



### 2 Press the +/-, ►► or ◀◀ button.

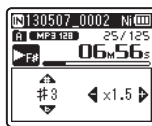
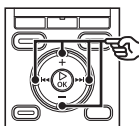

►► or ◀◀ button:

Adjust the playback speed.

+/- button:

Adjust the audio tone\* (voice changer).

\* WS-823 and WS-822 models only

## 3 Press the ►OK button.

Playback speed/  
tone indicator

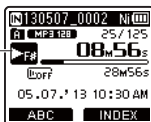

## Fast playback restrictions

Depending on their sampling frequency and bit rate, some files may not play normally. In this case, you will need to reduce the playback speed.

### TIP

- When speech is still difficult to discern after changing the playback speed, changing the tone may help.
- When the speed/tone changing function and [Play Scene] function have both been selected, the [Play Scene] setting takes precedence. The [Play Scene] settings cannot be changed (P.74).
- When changing the playback speed/tone, playback operations such as stopping playback, skipping to the beginning of a file, and writing index marks/temp marks are the same as during standard playback.

### NOTE

- Altered playback speed/tone settings are retained even after power OFF.
- Changing the playback speed and tone will make the battery deplete more quickly.
- The function below cannot be used when changing the playback speed/tone.
  - [Noise Cancel] (P.70)

## ABC repeat playback

The voice recorder has a function that lets you repeat the playback of a portion (segment) of the file being played. In addition to the A-B repeat function available from previous models, the segment to repeat can be changed during repeat playback. There is also a shadowing playback function handy for language learning that can be used during ABC repeat playback. The **[Shadowing]** setting must be set to **[On]** before you can use the shadowing playback function (see P.69).

3

Playback

### ABC repeat playback

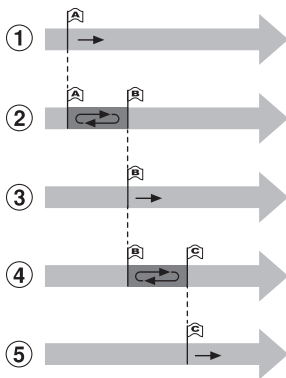

- 1 Select the starting point for repeat playback (A) during playback.
- 2 When the ending point (B) is selected, repeat playback starts.
- 3 When the starting point for repeat playback (A) is canceled during repeat playback, the ending point of the segment (B) becomes the new starting point and playback continues.
- 4 When the ending point (C) is selected, repeat playback starts again.

- 5 These steps can be repeated to re-specify a new segment to be played back repeatedly up to the end of the file.

- 1 Select a file for ABC repeat playback, and start playback.
- 2 Press the F1 (ABC) button when playback reaches the desired start position for ABC repeat playback.

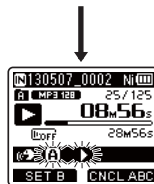
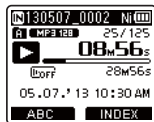
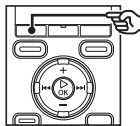

- If **[Shadowing]** has been set, the or indicator appears.



## ABC repeat playback

### TIP

- You can change the playback speed (☞ P.38), and fast-forward/rewind (☞ P.36) when the [A] indicator is blinking.
- If playback reaches the end of the file when the [A] indicator is blinking, the end of the file is treated as the segment end position, and repeat playback starts.

- 3 Press the F1 (SET B) button again when playback reaches the desired end position for ABC repeat playback.**

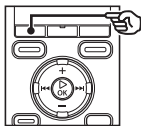

- Segment A-B is set, and ABC repeat playback starts.
- If [Shadowing] has been set, the repeat segment is played with the volume muted or lowered after it has been played at the usual volume. These operations are repeated until canceled.

### Stopping ABC repeat playback:

☞ Go to Step 6

### Specifying new starting/ending points:

☞ Go to Step 4

### Specifying new starting/ending points

- 4 Press the F1 (CANCEL A) button during ABC repeat playback.**

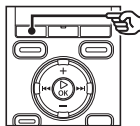

- Segment A-B is canceled. [B] becomes the new start position, and playback continues.
- You can change the playback speed (☞ P.38), and fast-forward/rewind (☞ P.36).
- The shadowing playback function is disabled.

## ABC repeat playback

- 5 Press the **F1 (SET C)** button at the desired end position for ABC repeat playback.



- Segment B-C is set, and ABC repeat playback starts.
- The shadowing playback function is enabled.

### TIP

- You can repeat Steps 4 and 5 as needed to change the repeat segment as desired.

- 6 Press the **STOP (■)** button.

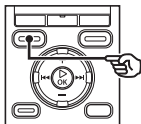

- Playback stops. The playback segment specified for this function is retained.

### NOTE

- You cannot change the end position of a repeat playback segment to a position before the start position.
- You cannot write index marks or temp marks during ABC repeat playback (P.43).

## Canceling ABC repeat playback

- 1 Press the **F2 (CNCL ABC)** button.



- If pressed when ABC repeat playback is stopped, cancels ABC repeat playback.
- If pressed during ABC repeat playback, cancels the playback segment setting for the function, and continues standard playback.

### NOTE

- If you change the file or switch to different display screen, ABC repeat playback is canceled.

# Index marks/temp marks

Writing an index mark or temp mark in a file enables you to quickly access desired position in the file with the same operations used for fast-forwarding, rewinding or skipping to the start of a file. Index marks can only be written in files created with Olympus voice recorders. For files created with other devices, you can temporarily store desired positions in the memory using temp marks.

## Writing an index mark/temp mark

- 1 When the desired position has been reached press the **F2 (INDEX)** button to write an index mark or temp mark.

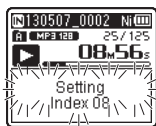

### NOTE

- Temp marks are temporary markings. They are automatically erased when you select a different file, transfer the file to a PC, or move the file on a PC.
- You can write up to 99 index marks/temp marks in a single file. The message [**No more can be set**] appears if you attempt to write more than 99 marks.
- You cannot write or erase index marks/temp marks in files that have been locked by the file lock function (P.61).

## Erasing an index mark/temp mark

- 1 Select a file that contains index mark/temp mark you want to erase and start playback.
- 2 Use the **▶▶▶** or **◀◀◀** button to select the index mark/temp mark you want to erase.

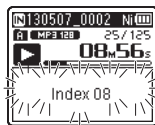

- 3 When the number of the index mark/temp mark to erase is being shown (for about 2 seconds) in the display, press the **ERASE** button.
  - Any subsequent index marks/temp marks in the file are automatically renumbered.

# Calendar Search function

## Using the Calendar Search function to search for a file

You can search for voice files by specifying a recording date. If you have forgotten in which folder a file has been saved, this feature lets you access it quickly by entering its recording date.

**1 Press the F1 (HOME) button to display the [Home] screen.**

**2 Press the +/-, ►►► or ◀◀◀ button to select [Calendar Search].**

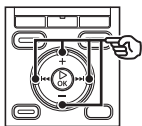

• On WS-822 or WS-821 model, use the ►►► or ◀◀◀ button to select [Calendar Search].

**3 Press the ►OK button.**

**4 Press the +/-, ►►► or ◀◀◀ button to select the desired date.**

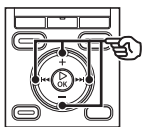

IN 2013.01.10 Ni (10)						
S	M	T	W	T	F	S
	1	2	3	4	5	
6	7	8	9	10	11	12
13	14	15	16	17	18	19
20	21	22	23	24	25	26
27	28	29	30	31		

- (a) Number of files saved (recorded) on selected date
- (b) Today's date
- (c) Date file was recorded
- (d) Selected date

• Dates on which files were saved are underlined.

►►► or ◀◀◀ button:

Move to the previous/next date. Press and hold to skip to the next date on which a file was recorded.

+/- button:

Move to the previous/next week.

F1, F2 button:

Move to the previous/next month.

• Press the STOP (■) button to cancel the setting and return to the [Home] screen.

**5 Press the ►OK button.**



IN 2013.01.20 Ni (10)	
130120_0001.MP3	
130120_0002.MP3	
130120_0003.MP3	
130120_0004.MP3	
130120_0005.MP3	

**6 Press the +/- button to select the desired file.**

**7 Press the ►OK button to start playback.**

### NOTE

• You can only search for files saved in the folders for voice recording ([FM] to [E]) and [FM Radio]\* folders.

\* WS-823 model only

# Selecting preset playback settings template [Play Scene]

## Selecting a preset playback settings template

This voice recorder has 2 preregistered template [Transcription] and [Language study], with optimum settings tailored to such playback scenes. Selecting one of these templates lets you enter several settings recommended for your recording application all in a single operation. See “**Setting a preset playback settings template**” for how to set playback settings packages (P.74).

- 1 While the voice recorder is in stop mode or playing a file, press and hold the MENU/SCENE button.**

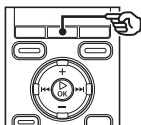

- If you pressed the **MENU/SCENE** button during playback, go to Step 4.

- 2 Press the +/- button to select [Play Scene].**

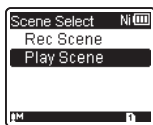
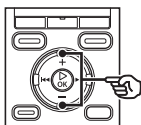

- 3 Press the ►OK button.**

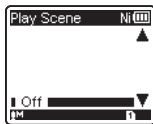

- 4 Press the +/- button to select the desired preset playback settings package.**

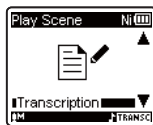

- 5 Press the ►OK button to finalize the setting.**

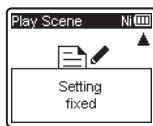

### TIP

- If you selected a preset playback settings template while the voice recorder is in stop mode, press the **STOP** (■) button to exit the menu screen.

# Erasing files/folders

This section describes how to erase a single unneeded file from a folder, erase all the files in the current folder at once, or erase a selected folder.

## Erasing files

- 1 Select the file you want to erase (see P.24).

- 2 When the file display screen appears, press the ERASE button while the voice recorder is in stop mode.

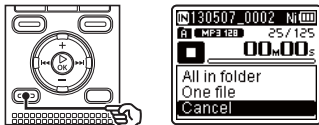

- The voice recorder returns to the stopped mode if no operation is performed for 8 seconds.

- 3 Press the +/– button to select [All in folder] or [One file].

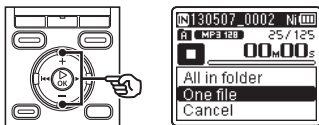

**[All in folder]:**

Erases all the files saved in the same folder as the selected file.

**[One file]:**

Erases only the selected file.

- 4 Press the ► OK button.

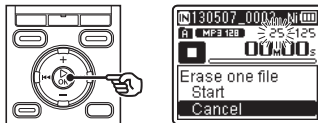

- 5 Press the + button to select [Start].

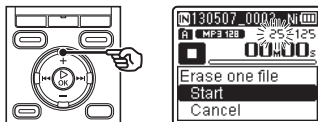

- 6 Press the ► OK button.

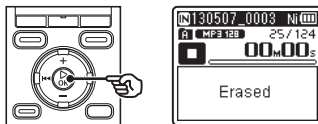

- **[Erasing!]** appears in the display, and the erasing process starts. **[Erased]** appears when the process has finished.

## Erasing a folder

- 1 Select the folder you want to erase (☞ P.24).
- 2 In the folder display screen, press the ERASE button while the voice recorder is in stop mode.

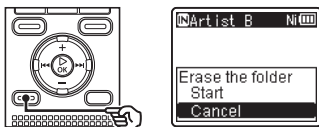

- The voice recorder returns to the stopped mode if no operation is performed for 8 seconds.

- 3 Press the + button to select [Start].

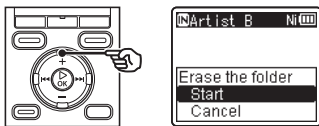

- 4 Press the ► OK button.

- [Erasing!] appears in the display, and the erasing process starts. [Erased] appears when the process has finished.

### NOTE

- Files cannot be restored after being erased, so please check carefully before erasing a file.
- When there is a microSD in the voice recorder, be sure to check whether the recording media being erased is [Internal memory] or [microSD card] (☞ P.77).
- Locked files and read-only files cannot be erased (☞ P.61).
- The voice recorder's default [Recorder] folders ([FolderA] to [FolderE], and [FM Radio]\* folder) and [Music] folder cannot be erased.  
\* WS-823 model only
- [Music] folder subfolders other than the [Music] can be erased.
- Files unrecognizable to the voice recorder will not be erased, nor will folders containing these files. The voice recorder must be connected to a PC to erase these files and folders.
- Before erasing a file or folder, charge or replace the battery to ensure it will not run out before the process has finished. Erasing processes can take over 10 seconds to complete. To prevent the risk of damage to data, never attempt to perform any of the following processes before an erasing process has finished:
  - ① Disconnecting the AC adapter
  - ② Removing the battery
  - ③ Removing the microSD card (if the recording media has been set to [microSD card]).

# FM radio (WS-823 model only)

## Before using the FM radio function

Radio signal reception quality varies substantially depending on where you are using the radio. Poor reception can often be improved by adjusting the antenna position or orientation, or moving to a more accessible location for the signal such as a near window.

### NOTE

- The supplied earphones function as an FM antenna. If the earphones are not connected, the message **[Insert earphone]** appears, and FM radio can not be received.

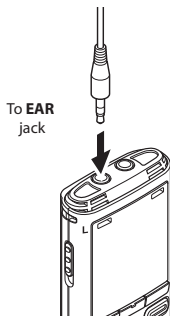

### NOTE

- FM radio cannot be received when you are beyond a radio station's broadcasting range or when the signal is blocked by mountains or other topographical obstructions.
- Even when within broadcasting range, you may not be able to receive radio broadcasts in locations prone to signal reception difficulty (such as within tunnels, underpasses, office buildings, apartment buildings and building shadows).
- Do not use a mobile phone, PC, TV or other electrical appliance near the voice recorder when using it to listen to the radio. Such product may cause noise.
- Using the voice recorder with a connected AC adapter (such as model A514) will generate noise. Always use batteries for the FM radio function.

### TIP

- You may not be able to receive FM radio when indoors or in the shadow of a building. Reception may be improved by moving near a window when indoors, or by moving out of building shadows.



# Presetting radio stations automatically

## Presetting a local radio station [By scanning]

Follow the steps below to preset the frequency of an FM radio station you can receive in your area.

- 1** Connect the earphones to the voice recorder's **EAR** jack.
- 2** Press the **F1 (HOME)** button to display the **[Home]** screen.
- 3** Press the **+/-**, **▶▶▶** or **◀◀◀** button to select **[FM Radio]**.

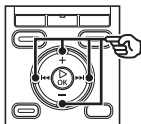

- 4** Press the **▶OK** button.
- 5** Press the **MENU/SCENE** button.

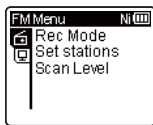
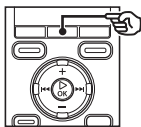

- 6** Press the **▶OK** button to move the cursor to the desired setting item.

- 7** Press the **+/-** button to select **[Set stations]**.

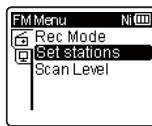

- 8** Press the **▶OK** button.



- 9** Press the **+/-** button to select **[By scanning]**.

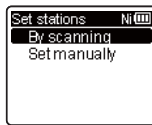

- 10** Press the **▶OK** button.

# Presetting radio stations automatically

## Presetting a local radio station [By scanning]

- 11** Press the +/- button to select [Start].

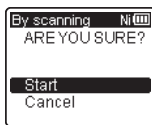
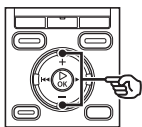

### TIP

- Preset numbers are sorted automatically by frequency.
- Up to 30 radio stations can be preset. The message [**Preset Full**] appears if you attempt to preset more than 30 stations.

- 12** Press the ► OK button.

- When [Set by scanning completed] appears, the operation is finished.

# Listening to FM radio

## Listening to FM radio

Follow the steps below to listen to stereo FM radio on the voice recorder.

- 1 Set FM radio mode by performing Steps 1 to 4 of the procedure given in "Presetting radio stations automatically" (P.49).**
- 2 Press the **▶▶** or **◀◀** button to select a radio station.**

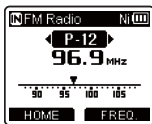

### TIP

- By selecting the frequency mode and manually adjusting the frequency, you may sometimes be able to receive a radio station that was not detected by the automatic preset operation (P.52).
- You can add a received radio station to the preset stations (P.53).
- To stop listening to FM radio, press the **F1 (HOME)** button to return to the **[Home]** screen.
- You can listen to the radio through the voice recorder's built-in speaker with the earphones still connected (P.81).

- 3 Press the **+/-** button to adjust the volume to the desired level.**

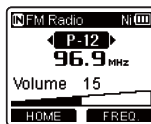

- The volume can be adjusted to a setting between **[00]** and **[30]**. The higher the number, the louder the volume.

### FM radio settings

The FM radio function includes features for automatically presetting radio stations, and for setting the scan sensitivity used during auto reception.

<b>[Set stations]</b> (P.49)	Used to search for local radio stations and preset received stations in a list.
<b>[Scan Level]</b> (P.81)	Sets the scan sensitivity during auto reception.
<b>[Output]</b> (P.81)	Used to select whether to listen to FM radio through the earphones or speaker.

# Listening to FM radio

4

Listening to FM radio

## Selecting the reception mode

Different reception modes can be selected to match different reception conditions. If the radio station you want to listen to has a signal too weak to be detected by the automatic preset process, you can select manual reception to adjust the radio frequency manually.

- 1 Set FM radio mode by performing Steps 1 to 4 of the procedure given in “Presetting radio stations automatically” (P.49).**

- 2 Press the F2 button to select the desired reception mode.**

### TIP

- When a radio station has been preset (P.49), the voice recorder switches between preset mode and frequency mode each time you press the **F2** button.
- You cannot select preset mode if no radio stations have been preset.

- 3 Press the ►► or ◀◀ button to change the reception mode.**

### Preset mode

- Pressing the ►► or ◀◀ button lets you select preset radio stations (by preset number).  
a) Preset number

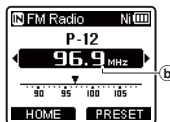
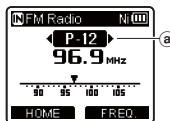

### Frequency mode (auto reception/manual reception)

- Press the ►► or ◀◀ button to adjust the FM radio frequency being received (manual reception).
- Press and hold the ►► or ◀◀ button to scan to the next radio station found (auto reception).  
b) Frequency being received
- When the frequency of a non-preset radio station is being received, pressing the **F2** button switches to the preset station nearest in frequency to the current frequency.
- Reducing the sensitivity used for scanning can sometimes enable reception of stations difficult to receive due to interference or other problems (P.81).

EN

52

# Adding preset radio stations

## Adding a radio station received manually as a preset station [Set manually]

Follow the steps below to add a radio station received in frequency mode as a preset radio station.

- 1** Set FM radio mode by performing Steps 1 to 4 of the procedure given in “Presetting radio stations automatically” (P.49).

- 2** Press the F2 button to set frequency mode.

- 3** Press the ►►► or ◀◀◀ button to select the radio station you want to preset.

- 4** Press the MENU/SCENE button.

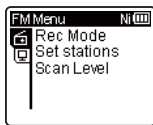
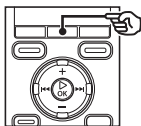

- 5** Press the ►OK button to move the cursor to the desired setting item.

- 6** Press the +/- button to select [Set stations].

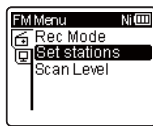

- 7** Press the ►OK button.

- 8** Press the +/- button to select [Set manually].

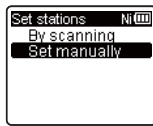

- 9** Press the ►OK button.

# Adding preset radio stations

## Adding a radio station received manually as a preset station [Set manually]

- 10** Press the +/- button to select [Save preset].

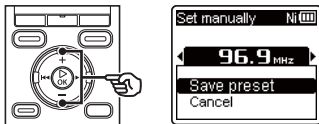

- 11** Press the ► OK button.

- When the message [Preset (number) saved] appears, the procedure is finished.

### TIP

- Up to 30 radio stations can be preset. The message [Preset Full] appears if you attempt to preset more than 30 stations.
- Preset numbers are sorted automatically by frequency.

# Deleting preset radio stations

## Deleting an unneeded preset radio station

- 1 Set FM radio mode by performing Steps 1 to 4 of the procedure given in "Presetting radio stations automatically" (P.49).
- 2 Press the F2 button to set preset mode.
- 3 Press the ►► or ◀◀ button to select the preset number of the radio station you want to delete.
- 4 Press the ERASE button.

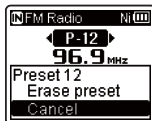
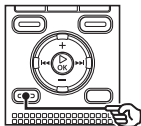

- 5 Press the +/- button to select [Erase preset].

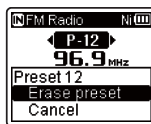

- 6 Press the ► OK button.

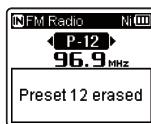

- When the message [Preset (number) erased] appears, the procedure is finished.

### TIP

- Preset numbers are sorted automatically by frequency.

# Recording FM radio

## Recording FM radio

Even when FM radio reception is clear, noise may enter after starting to record in certain reception environments. To avoid such a problem, perform a test recording beforehand. Try to record in a location with good radio reception.

### NOTE

- Recording is disabled when [Output] in the [FM Menu] menu is set to [Speaker]. Set this item to [Earphone] before starting recording (P.81).

4

Recording FM radio

- 1 Set FM radio mode by performing Steps 1 to 4 of the procedure given in "Presetting radio stations automatically" (P.49).**
- 2 Press the **▶▶** or **◀◀** button to select the radio station you want to record from.**

- 3 Press the REC (●) button to start recording.**

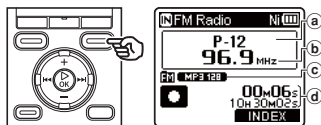

- Preset number being received
  - Radio frequency being received
  - Indicator of folder where file will be saved and Recording format indicator
  - Elapsed recording time and Possible recording time remaining
- The LED indicator light lights, and  appears in the display.

- 4 Press the STOP (■) button when you want to stop recording.**

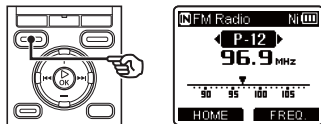

- The recorded file is saved automatically in the [FM Radio] subfolder in the [Recorder] folder.



# Recording FM radio

---

## Recording FM radio

### TIP

- Files recorded from FM radio have "FM" appended to the beginning of the file name assigned at the time of recording (see P.27).

FM130715\_0007.MP3

Date: 130715 (July 15, 2013)

### NOTE

- When recording FM radio, always connect the earphones to the **EAR** jack.

# Menu

## Setting menu items

### Basic operation

Menu items are arranged by tabs, letting you quickly set desired items by selecting a tab and then moving to the desired item within the tab. Follow the steps below to set a menu item.

- 1 During recording/playback or while the voice recorder is in stop mode, press the MENU/SCENE button.**

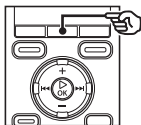

#### TIP

- Some menus contain items that can be set during recording/playback (P.60).

- 2 Press the +/- button to select the tab containing the item you want to set.**



- Moving the cursor from one tab to another switches the displayed menu screen.

- 3 Press the ►OK button to move the cursor to the desired setting item.**



- You can also use the ►► button to perform this operation.

- 4 Press the +/- button to select the desired setting item.**



# Setting menu items

## Basic operation

### 5 Press the ►OK button.

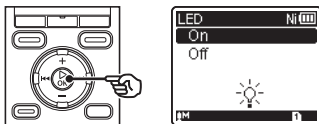

- The setting of the selected item is displayed.
- You can also use the ►► button to perform this operation.

### 6 Press the +/– button to change the setting.

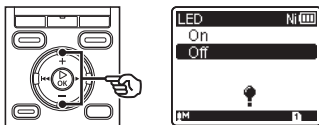

### 7 Press the ►OK button to finalize the setting.

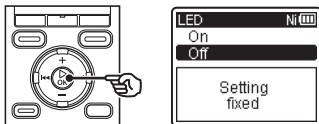

- A message indicating the setting has been entered appears.
- You can cancel the setting and return to the previous screen by pressing the ◀◀ button instead of the ►OK button.

### 8 Press the STOP (■) button to exit the menu screen.



- When the menu screen is displayed during recording or playback, press the **MENU/SCENE** button to return to the previous screen without ending recording/playback.

#### NOTE

- For menu settings done while the voice recorder is in stop mode, the voice recorder exits the menu and returns to the stopped mode if no operation is performed for 3 minutes. The selected setting item is not changed in this case.
- For menu settings done during recording/playback, the voice recorder exits the menu if no operation is performed for 8 seconds.

## Basic operation

### ■ Menu items that can be set during recording

- Rec Level
- Zoom Mic\*<sup>1</sup>
- Low Cut Filter
- VCVA
- Backlight
- LED

### ■ Menu items that can be set during Playback

- Property
- Noise Cancel\*<sup>2</sup>
- Voice Balancer\*<sup>2,3</sup>
- Voice Filter\*<sup>2,4</sup>
- Play Mode
- Equalizer\*<sup>5</sup>
- Skip Space
- Backlight
- LED

### ■ Menu items that can be set while listening to the radio (WS-823 model only)

- Rec Mode\*<sup>6</sup>
- Set stations\*<sup>6</sup>
- Scan Level\*<sup>6</sup>
- Backlight
- LED
- Output\*<sup>6</sup>

\*1 WS-823 model only

\*2 Function active only in [Recorder] mode.

\*3 WS-823 and WS-822 models only

\*4 WS-821 model only

\*5 Function active only in [Music] mode.

\*6 Cannot be selected while recording from the radio.

# File menu [File Menu]

## Extracting the speaking portions of files of spoken-word content [Voice Detect]

The [Voice Detect] function extracts the speaking portions of a file of spoken-word content recorded by the voice recorder. See “Extracting speaking portions of files of spoken-word content [Voice Detect]” (P.82) for more information.



**WS-823 and WS-822 models only**

## Preventing accidental file erasure [File Lock]

The file lock feature lets you lock important files to prevent them being accidentally erased. Once locked, a file is not erased even if the operation for erasing all the files in its folder is performed (P.46).

### 1 Select the file you want to lock (P.24).

[Lock]:  
File is locked.

[Unlock]:  
File lock is canceled.

## Sorting files [Sort by]

You can change the playback order of the files in a folder.

### 1 Press the +/– button to select [File name], [Date ascending] or [Date descending].

[File name]:  
Automatically sorts the files by file name.

[Date ascending]:  
Automatically sorts the files by date (recording date/time) from oldest to newest files.

[Date descending]:  
Automatically sorts the files by date (recording date/time) from newest to oldest files.

### 2 Press the +/– button to select [Recorder] or [Music].

[Recorder]:  
Sorts all the files in the [Recorder] folder (including the files in the [FM Radio]\* folder).

[Music]:  
Sorts all the files in the [Music] folder.  
\* WS-823 model only

#### NOTE

- When [File name] is selected, files are listed in order of file name based on the first 20 characters of each name.

# File menu [File Menu]

## Moving/copying files [Move/Copy]

Files saved in the internal memory or on a microSD card can be moved or copied within memory.

See “**Moving/copying files [Move/Copy]**” (P.84) for the procedure.



**WS-823 and WS-822 models only**

## Dividing files [File Divide]

Large files or files with long recording times can be divided for easier management and editing.

See “**Dividing a file [File Divide]**” (P.87) for the procedure.

## Displaying file or folder information [Property]

You can display the information of a file or folder from a menu screen.

### File information

#### 1 Press the +/- button to switch the screen.

Information is displayed for the items **[Name]**, **[Date]**, **[Size]**, **[Bit Rate]**<sup>\*1</sup>, **[Artist]**<sup>\*2</sup> and **[Album]**<sup>\*2</sup>.

\*1 If you selected a linear PCM-format file, the **[Bit Rate]** item displays the sampling frequency and bit count.

\*2 If the file has no tag information, **[UNKNOWN\_ARTIST]** and **[UNKNOWN\_ALBUM]** are displayed.

### Folder information

#### 1 Press the +/- button to switch the screen.

Information is displayed for the items **[Name]**, **[File]** (the number of files) and **[Folder]** (the number of folders).

The **[Folder]** item is not displayed in **[Recorder]** mode.

Displayed numbers of files do not include files in formats that are unrecognizable to the voice recorder.

# Recording menu [Rec Menu]

## Selecting the recording sensitivity [Rec Level]

You can change the recording level (sensitivity) as needed for your recording application.

### [High]:

The highest recording sensitivity. Suited to recording lectures, large conferences and other applications with distant or quiet sound sources.

### [Middle]:

Suited to recording discussions and small-group meetings.

### [Low]:

The lowest recording sensitivity. Suited to recording dictation.

### [Manual]\*:

Lets you set the recording sensitivity manually, to any of 30 levels.

\* WS-823 model only

## TIP

- To record the speaker's voice clearly, set **[Rec Level]** to **[Low]**, and place the voice recorder's built-in microphone near the speaker's mouth (5 to 10 cm away).

## NOTE

- When **[Rec Level]** is set to **[High]**, **[Middle]** or **[Low]**, the recording level is adjusted automatically. Excessively loud sound input may generate noise regardless of whether **[Rec Level]** is set to **[High]**, **[Middle]** or **[Low]**.

## Adjusting the recording level

### ! WS-823 model only

- 1 Adjust the recording level by pressing the **▶▶▶** or **◀◀◀** button during recording or when recording is paused.

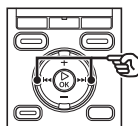

- Increasing the **[Rec Level]** number increases the recording level and extends the level meter indicator position.

## NOTE

- Setting the voice recorder to **[Manual]** disables the limiter function. If **[OV]** is displayed, the recorded audio will be distorted. Adjust the recording level so that **[OV]** is not displayed.

# Recording menu [Rec Menu]

## Setting the recording mode [Rec Mode]

You can prioritize sound quality or recording time. Select the recording mode that best matches your recording application.

[PCM 44.1 kHz]<sup>\*1</sup>

[MP3 256 kbps]<sup>\*1</sup>

[MP3 192 kbps]<sup>\*2</sup>

[MP3 128 kbps]

[WMA 32 kbps mono]<sup>\*3</sup>

[WMA 8 kbps mono]<sup>\*3</sup>

\*1 WS-823 and WS-822 models only

\*2 WS-821 model only

\*3 Mono recording

### TIP

- Sound quality increases as the recording rate value increases.
- Setting a higher recording rate increases file size. Check that you have enough remaining memory before recording.
- To record conferences and presentations clearly, it is recommended to set [Rec Mode] setting to [MP3 128kbps] or above.

### NOTE

- When [Rec Mode] is set to stereo, recording with a connected mono microphone records on the left channel only.

## Selecting microphone directivity [Zoom Mic]

The voice recorder's built-in stereo microphone provides directivity ranging from broad-coverage stereo recording to highly directional recording.

### ! WS-823 model only

- 1 Press the +/- button to adjust the built-in stereo microphone's directivity.

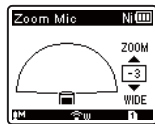

- The + button increases directivity.
- The - button enables recordings with broader-coverage stereo.
- Reducing directivity and broadening the sound pickup range gives recordings more of a stereo effect.
- The setting can be adjusted to between [-3] and [+6].



# Recording menu [Rec Menu]

## Selecting microphone directivity [Zoom Mic]

### Zoom mic function

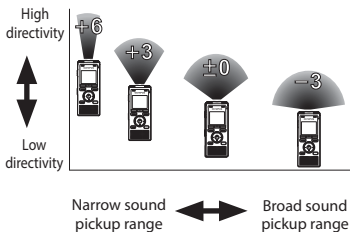

### NOTE

- The **[Zoom Mic]** function has been set so as to optimize its performance when it is used with the voice recorder's built-in stereo microphone. Note that normal recording may no longer be possible when using a separately purchased microphone or when recording from another device using a connecting cord.
- Using the **[Zoom Mic]** function will make the battery deplete more quickly.

## Reducing noise during recording [Low Cut Filter]

The voice recorder's low cut filter function lets you make recordings that reduce humming sounds from air-conditioners or low-frequency sounds from equipment such as projectors.

**[On]:**

Turns the low cut filter ON.

**[Off]:**

Turns the low cut filter OFF.

## Voice-activated recording function [VCVA]

The voice-activated recording function (VCVA) automatically starts recording when a sound louder than a preset voice activation level is detected, and automatically pauses recording when the sound volume level falls. Use this function to automatically omit unneeded quiet segments when recording (such as long silences during conferences), saving memory.

**[On]:**

Turns VCVA ON. You can adjust the voice activation level used for VCVA (P.66).

**[Off]:**

Turns VCVA OFF. Restores standard recording.

# Recording menu [Rec Menu]

## Adjusting the voice activation level for voice-activated recording

### 1 Press the REC (●) button to start recording.

- Recording pauses automatically about 1 second after the input sound becomes quieter than the set activation sensitivity.

The blinking message **[Standby]** appears in the display. The LED indicator light becomes lit when recording is activated and flashes when recording is paused.

### 2 Press the ►► or ◀◀ button to adjust the voice activation level.

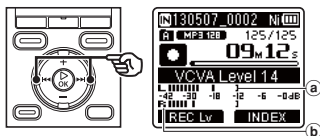

- a Voice activation level (moves left/right to match set level)
  - b Level meter (changes in proportion to recording sound volume)
- The setting can be adjusted to between **[01]** and **[23]**.

## TIP

- Increasing the setting number increases the VCVA activation sensitivity, enabling quieter sounds to activate the start of recording.
- Adjust the VCVA voice activation level to suit the recording conditions (to cope with high levels of surrounding noise or the like).
- To avoid recording mistake, it's recommended to perform a test recording beforehand to adjust the voice activation level.

### WS-823 model only:

- To change the recording level (☞ P.63) during VCVA recording in **[Manual]**, press the **F1** button. The voice recorder changes to recording level adjustment mode. Press the **F1** button again to return to voice activation level adjustment mode.

## NOTE

- The following function is disabled when using the **[VCVA]** function:
  - [V-Sync. Rec]** (☞ P.67)

# Recording menu [Rec Menu]

## Voice sync recording function [V-Sync. Rec]

The voice sync recording function automatically starts recording when a sound louder than a preset voice sync recording level (detection level) is detected, and automatically stops recording when the sound volume level decreases. When copying music from another device connected to the voice recorder, use the voice sync recording function to detect the silent intervals between music tracks and save each track as a separate file.

### [1 sec.], [2 sec.], [3 sec.], [5 sec.]:

Set the detection time. The voice recorder enters standby mode when the input (recording level) is below the preset level for at least the set detection time.

### [Off]:

Recording is done normally.

## Adjusting the voice sync level for voice sync recording

- 1 Press the **REC** (●) button to prepare for recording.
- 2 Press the **▶▶** or **◀◀** button to adjust the voice sync level.

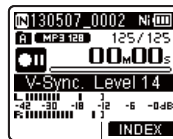

Voice sync level (moves left/right to match set level)

- The voice sync level can be adjusted to a setting between [01] and [23].
- Increasing the setting number increases the activation sensitivity, enabling quieter sounds to activate the start of recording.

### TIP

#### WS-823 model only

- To change the recording level (P.63) during voice sync level adjustment in [Manual], press the **F1** button. The voice recorder changes to recording level adjustment mode. Press the **F1** button again to return to voice sync level adjustment mode.

### 3 Press the REC (●) button again.

- The blinking message [**Standby**] appears in the display, and the LED indicator light flashes.
- Recording starts automatically if the input is louder than the voice sync level.

#### TIP

- The voice recorder automatically ends recording and returns to recording standby mode when the input sound has been below the voice sync level for at least the set detection time. Each time the voice recorder enters standby mode, the current file is closed. Recording continues in a new file the next time sound is detected.
- Press the **STOP** (■) button to end a voice sync recording session.

#### NOTE

- The following function is disabled when using the [**V-Sync. Rec**] function:
  - [**VCVA**] (Ⓜ P.65)

# Playback menu [Play Menu]

## Skipping non-voice portions during playback [Voice Playback]

The [Voice Playback] function lets you only play the speaking portions of a recorded file of spoken-word content.

### WS-823 and WS-822 models only

#### NOTE

- The speaking portions of the file must be extracted beforehand (☞ P.82).

#### [On]:

Automatically skips the non-voice portions of the file and plays only the speaking portions.

#### [Off]:

The voice playback function is disabled.

#### NOTE

- The [Voice Playback] function is only enabled in [Recorder] mode.

## Alternating repeatedly between normal and muted playback [Shadowing]

The voice recorder's shadowing playback function plays a repeat segment set for the ABC repeat playback function (☞ P.40) first at normal volume (for listening practice when learning a foreign language), and then a second time at muted or low volume (for speaking practice).

These two operations are repeated in alternation. This function is handy for use in language learning.

#### [Silent]:

Plays the repeat segment with the volume muted (silent) after playing it once at normal volume.

#### [Small volume]:

Plays the repeat segment at low volume after playing it once at normal volume.

#### [Off]:

Disables the shadowing playback function.

#### NOTE

- Shadowing playback only works with ABC repeat playback (☞ P.40).

# Playback menu [Play Menu]

## Reducing noise during playback [Noise Cancel]

Use the **[Noise Cancel]** function to reduce noise when a recorded voice is difficult to discern.

### [High][Low]:

Reduces surrounding noise, producing higher sound-quality playback.

### [Off]:

The noise cancel function is disabled.

### NOTE

- **[Noise Cancel]** is only enabled in **[Recorder]** mode.
- Using the **[Noise Cancel]** function will make the battery deplete more quickly.
- The following function is disabled when using the **[Noise Cancel]** function:
  - Modified speed/tone\* during playback (P.38)

\* WS-823 and WS-822 models only

## Adjusting low volume portions during playback [Voice Balancer]

The **[Voice Balancer]** function adjusts low-volume portions of recorded audio files to make them louder.

Use it to make quiet parts of conversations or other recorded audio louder and clearer. The function can be used on files saved in the audio recording folders ([A] to [E]).



### WS-823 and WS-822 models only

### [On]:

Adjusts low-volume portions of audio files during playback, making them louder.

### [Off]:

The voice balancer function is disabled.

### NOTE

- **[Voice Balancer]** is only enabled in **[Recorder]** mode.
- Using the **[Voice Balancer]** function will make the battery deplete more quickly.
- When the **[Voice Balancer]** function and **[Play Scene]** function have both been selected, the **[Play Scene]** setting takes precedence. The **[Play Scene]** settings cannot be changed (P.74).

# Playback menu [Play Menu]

## Emphasizing voice more clearly [Voice Filter]

During normal playback or fast/slow playback, the voice filter function cuts low- and high-frequency range tone and emphasizes voices, making them more clearly audible.

### WS-821 model only

- [On]: Turns on the voice filter function.  
[Off]: Turns the voice filter function OFF.

#### NOTE

- [Voice Filter] is only enabled in [Recorder] mode.
- Using the [Voice Filter] function will make the battery deplete more quickly.
- When the [Voice Filter] function and [Play Scene] function have both been selected, the [Play Scene] setting takes precedence. The [Play Scene] settings cannot be changed (P.74).

## Selecting playback modes [Play Mode]

Several playback modes are available for different listening styles.

- 1 Press the +/– button to select [Recorder] or [Music].

---

### When [Recorder] was selected

---

- 2 Press the +/– button to select [File] or [Folder].

- [File]: Stops playback after the current file has been played.  
[Folder]: Plays all the files in the current folder consecutively, stopping playback after the last file in the folder is played.

---

### When [Music] was selected

---

- 2 Press the +/– button to select [Playback range], [Repeat] or [Random].

- [Playback range]: Lets you specify a range of files for playback.  
[Repeat]: Repeatedly plays the files in the set range.  
[Random]: Plays the files in the set range at random.

# Playback menu [Play Menu]

## 3 Press the +/- button to select a setting.

**When [Playback range] was selected:**  
[File], [Folder], [All]:

Specify the range of files for playback.

**When [Repeat] or [Random] was selected:**

[On]:

The files in the specified playback range are played repeatedly or at random.

[Off]:

Cancels repeat playback and random playback.

### NOTE

- When [Playback range] is set to [File], [End] blinks in the display for 2 seconds after the last file in the folder has been played, then playback stops at the start position of the last file.
- When [Playback range] is set to [Folder], [End] blinks in the display for 2 seconds after the last file in the folder has been played, then playback stops at the start position of the first file in the folder.
- When [Playback range] is set to [All], after the last file in the current folder has been played, the first file in the next folder is being played. When playback reaches the end of the last file in the voice recorder, [End] blinks in the display for 2 seconds, then playback stops at the start position of the first file in the voice recorder.



# Playback menu [Play Menu]

## Changing music sound quality [Equalizer]

The voice recorder's equalizer settings can be changed to change music sound quality as desired.

### When [User] was selected

- 1 Press the **▶▶▶** button.
- 2 Press the **▶▶▶** or **◀◀◀** button to select a frequency band.
  - You can set different levels for the [60 Hz], [250 Hz], [1 kHz], [4 kHz] and [12 kHz] frequency bands.
- 3 Press the **+/-** button to set a level.
  - Levels can be set to values between [-6] and [+6], in 1 dB increments.
  - Increasing a level setting emphasizes the corresponding frequency band.
  - To change another frequency band, repeat Steps 2 and 3.

### NOTE

- [Equalizer] is only enabled in [Music] mode.

## Setting a skip space [Skip Space]

The [Skip Space] function lets you skip a preset amount forward (forward skip) or backward (reverse skip) in a file during playback. It is handy for quickly moving the playback position, or for repeated playback of a short segment.

- 1 Press the **+/-** button to select [Forward Skip] or [Reverse Skip].

### [Forward Skip]:

Starts playback after moving the playback position forward by the set amount.

### [Reverse Skip]:

Starts playback after moving the playback position backward by the set amount.

- 2 Press the **+/-** button to select a setting.

### When [Forward Skip] was selected:

[File Skip], [10 sec. Skip], [30 sec. Skip], [1 min. Skip], [5 min. Skip], [10 min. Skip]

### When [Reverse Skip] was selected:

[File Skip], [1 sec. Skip] to [3 sec. Skip], [5 sec. Skip], [10 sec. Skip], [30 sec. Skip], [1 min. Skip], [5 min. Skip]

# Playback menu [Play Menu]

## NOTE

- Forward/reverse skip operations over a skip space that contains an index mark/temp mark or the starting position of a file will stop at that mark or at the start position.

## Forward/reverse skip playback

- Press the ►OK button to start playback.
- Press the ►►| or |◄◄ button during playback.
  - Playback starts after skipping forward or backward by the set amount.

## Setting a preset playback settings template [Play Scene]

The voice recorder has 2 preregistered templates, [Transcription] and [Language study], with optimum settings tailored to such playback scenes. With one single step you can select one of these templates to enter several settings recommended for your recording application.

### [Transcription]:

Is a handy setting when creating a written record by transcribing an audio file of spoken-word content such as a conference or interview recording. Changes the operations assigned to the voice recorder's buttons to operations tailored to transcription.

Download from [Www.Somanuals.com](http://Www.Somanuals.com). All Manuals Search And Download.

### [Transcription]

[STOP (■)]	[Auto Back (3 sec)]
[►►  (CUE)]	[x3.5 Play Back] <sup>*1</sup> [x2.0 Play Back] <sup>*2</sup>
[ ◄◄ (REV)]	[Reviewing]
[►►  (SKIP)]	[10 sec. Skip]
[ ◄◄ (SKIP)]	[3 sec. Skip]
[Voice Balancer] <sup>*1</sup> [(Voice Filter)] <sup>*2</sup>	[On]

### [Language study]:

Changes the operations assigned to the voice recorder's buttons to operations tailored to language learning.

### [Language study]

[STOP (■)]	[Stop]
[►►  (CUE)]	[x2.5 Play Back] <sup>*1</sup> [x2.0 Play Back] <sup>*2</sup>
[ ◄◄ (REV)]	[Reviewing]
[►►  (SKIP)]	[10 sec. Skip]
[ ◄◄ (SKIP)]	[3 sec. Skip]
[Voice Balancer] <sup>*1</sup> [(Voice Filter)] <sup>*2</sup>	[Off]

\*1 WS-823 and WS-822 models only

\*2 WS-821 model only

### TIP

- You can press the ►►| button to display the selected template setting. Press the |◄◄ button to return to the [Play Scene] screen.

# LCD/Sound menu [LCD/Sound Menu]

## Setting the backlight [Backlight]

The display backlights are switched on for a preset amount of time when a button operation is performed.

**[5 sec.]**, **[10 sec.]**, **[30 sec.]**, **[1 min.]**:

Set the amount of time that the backlight stays lit.

**[Off]**:

Disables the backlight.

## Setting the LED indicator light [LED]

You can set the LED indicator light to not become lit.

**[On]**:

LED indicator light is switched on.

**[Off]**:

LED indicator light stays off.

## Adjusting the contrast [Contrast]

You can adjust the contrast of the display to 12 different levels.

- The setting can be adjusted to between **[01]** to **[12]**.

## Turning beeping sound ON/OFF [Beep]

The voice recorder makes beeping sounds when buttons are pressed, or to warn in case of operation errors. You can select whether the voice recorder makes these beeping sounds.

**[On]**:

Enables beeping sounds.

**[Off]**:

Disables beeping sounds.

# LCD/Sound menu [LCD/Sound Menu]

## Changing the display language [Language]

You can select the language used in the voice recorder's displays.

- [English], [Español], [Français].

### TIP

- The language selections vary depending on where the voice recorder was purchased.

## Selecting the speaker output [Speaker]

You can set the built-in speaker to be ON or OFF when the earphones are not connected. When set to [Off], sound will not be output from the speaker even if the earphones are accidentally disconnected. Use this setting to prevent possible embarrassment on public transport.

### [On]:

The voice recorder's playback sound is output from the earphones when the earphones are connected, or from the built-in speaker when the earphones are not connected.

### [Off]:

The voice recorder's playback sound is not output from the built-in speaker even if the earphones are disconnected.

### NOTE

#### WS-823 model only

- The setting for this function only applies to file playback. To set how speaker output is handled when listening to FM radio, see the description of the [Output] item in the [FM Menu] menu (P.81).

# Device menu [Device Menu]

## Selecting the recording media [Memory Select]

When there is a microSD card in the voice recorder, you can select whether to record on the internal memory or on the microSD card (see P.17).

### [Internal memory]:

Records on the internal memory on the voice recorder.

### [microSD card]:

Records on the microSD card.

## Setting power save mode [Power Save]

The voice recorder turns OFF automatically when a preset amount of time has elapsed with the voice recorder stopped after power ON.

### [5 min.], [10 min.], [30 min.], [1 hr.]:

Select the desired amount of time.

### [Off]:

Disables power save mode. Note that leaving the voice recorder ON will quickly deplete the battery.

## Setting the battery in use [Battery]

Set the battery type to match the battery you are using.

### [Ni-MH] :

Select this setting when using an Olympus Ni-MH rechargeable battery (model BR404).

### [Alkaline] :

Select this setting when using an alkaline dry cell battery.

# Device menu [Device Menu]

## Setting the date/time

### [Time & Date]

Set the date and time beforehand to enable easier management of recorded files.

If the current date and time are not correct, set them using the procedure below.

- 1 Press the **▶▶▶** or **◀◀◀** button to select the desired setting item.

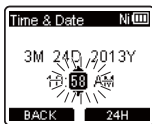

- 2 Press the **+/-** button to change the number.

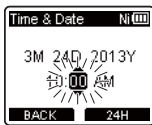
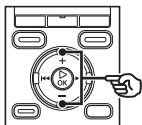

- To change the setting of another item, press the **▶▶▶** or **◀◀◀** button to move the blinking cursor, then press the **+** or **-** button to change the number.

- 3 Press the **▶ OK** button to finalize the setting.

## TIP

- When setting the hour or minute, each time you press the **F2** button the display changes between the AM/PM and 24-hour clock formats.

### Example: 10:38 PM

10:38 PM (default format) ↔ 22:38

- When setting the year, month or date, each time you press the **F2** button the display order used for the date changes.

### Example: March 24, 2013

3M 24D 2013Y  
(default format)



24D 3M 2013Y



2013Y 3M 24D

## NOTE

- Even if the voice recorder is not used for a long period of time, when the battery is used up, the date and time must be re-entered.

## Setting the USB connection [USB Settings]

The [PC] setting lets you connect the voice recorder to a PC to transfer files. The [AC Adapter] setting lets you connect the voice recorder to a USB-connection AC adapter (model A514; optional) to charge the rechargeable battery. You can change the USB class setting as required by different USB applications.

See “Setting the USB connection [USB Settings]” (☞ P.89) for the procedure.

## Restoring the default settings [Reset Settings]

The [Reset Settings] function restores all the voice recorder's functions to their initial (factory default) settings. Time setting and file number will remain the same.

### 1 Press the + button to select [Start].

#### Rec Menu:

Rec Level: Middle  
Rec Mode: MP3 128 kbps  
Zoom Mic<sup>\*1</sup>: Off  
Low Cut Filter: Off  
VCVA: Off  
V-Sync Rec: Off  
Rec Scene: Off

#### Play Menu:

Voice Playback<sup>\*2\*3</sup>: Off  
Shadowing: Off  
Noise Cancel<sup>\*3</sup>: Off  
Voice Balancer<sup>\*2\*3</sup>: Off  
Voice Filter<sup>\*3\*4</sup>: Off  
Play Mode:  
Recorder:  
Playback range / File  
Music:  
Playback range / Folder  
Repeat / Off  
Random / Off  
Equalizer<sup>\*5</sup>: Off  
Skip Space:  
Forward Skip: File Skip  
Reverse Skip: File Skip  
Play Scene: Off

## LCD/Sound Menu:

Backlight: 10 sec.  
Contrast: Level 06  
LED: On  
Beep: On  
Language: English  
Speaker: On

## Device Menu:

Memory Select: Internal memory  
Power Save: 10 min.  
Battery: Ni-MH<sup>\*2</sup>  
Alkaline<sup>\*4</sup>  
USB Settings:  
USB Connection: PC  
USB Class: Storage Class

## FM Menu<sup>\*1</sup>:

Rec Mode: MP3 128 kbps  
Scan level: High  
Output: Earphone

- \*1 WS-823 model only
- \*2 WS-823 and WS-822 models only
- \*3 Function active only in [Recorder] mode.
- \*4 WS-821 model only
- \*5 Function active only in [Music] mode.

## Formatting a recording media [Format]

Formatting a recording media erases all existing files saved on it. Be sure to transfer all important files to a PC before formatting.

See "**Formatting recording media [Format]**" (P.91) for the procedure.

## Checking recording media information [Memory Info.]

You can display the capacity and remaining memory space of the recording media from a menu screen.

### NOTE

- Some recording media memory capacity is used as a management area, so the actual usable capacity will always be slightly less than the displayed capacity.

## Checking voice recorder information [System Info.]

You can display voice recorder information from a menu screen.

- The voice recorder's [Model], [Version] (system version) and [Serial No.] information is displayed.



# FM menu [FM Menu]



**WS-823 model only**

## Selecting the recording sound quality [Rec Mode]

This setting cannot be changed while recording from FM radio.

[MP3 256 kbps]

[MP3 128 kbps]

## Presetting a radio station [Set stations]

You can preset radio stations to make them easier to select (P.49, P.53).

## Setting scanning sensitivity [Scan Level]

You can select the scan sensitivity used during auto reception. This setting cannot be changed while recording from the radio.

### [High]:

Scans for radio stations with high sensitivity. Use this setting under normal circumstances.

### [Low]:

Scans for radio stations with low sensitivity. Try using this setting when there are problems such as interference between radio stations.

## Selecting the FM radio output [Output]

You can select whether the sound of the FM radio is output from the earphones or built-in speaker. This setting cannot be changed while recording from the radio.

**[Earphone]:** Always outputs the radio sound from the earphones. The radio sound is not output from the built-in speaker if the earphones are disconnected.

**[Speaker]:** Always outputs the radio sound from the built-in speaker. The radio sound is not output from the earphones even if they are connected.

### NOTE

- The setting for this function only applies to the radio sound. To set how speaker output is handled for file playback, see the description of the **[Speaker]** item in the **[LCD/Sound Menu]** (P.76).

# Extracting the speaking portions of files of spoken-word content [Voice Detect]

## Extracting the speaking portions of files of spoken-word content [Voice Detect]

The [Voice Detect] function extracts the speaking portions of a file of spoken-word content recorded by the voice recorder.

**!** WS-823 and WS-822 models only

### NOTE

- The [Voice Detect] function can only be used in [Recorder] mode.

5

Extracting the speaking portions of files of spoken-word content [Voice Detect]

- 1 Select the folder containing the desired file (☞ P.24).
- 2 Press the MENU/SCENE button while the voice recorder is in stop mode.
- 3 Press the ►OK button to move the cursor into the list of setting items.
- 4 Press the ►OK button.
- 5 Press the +/- button to select the desired file in which you want to detect voice.

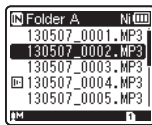

- 6 Press the ►OK button.

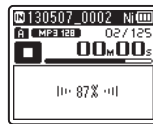

- The progress of the operation is shown as a percentage in the display.
- [Voice Detection completed] appears when the process has finished.

### TIP

- When the voice detection process has finished, the [Voice Playback] item in the [Play Menu] is set to [On] (☞ P.69).

EN

82

### Extracting the speaking portions of files of spoken-word content [Voice Detect]

#### NOTE

- The message **[No file]** appears if you select a folder that doesn't contain a saved file. You must select a folder containing a file before you can perform the process.
- The voice recorder may not be able to properly extract non-silent portions from files of non-spoken word content such as recorded musical performances.
- The voice recorder may not be able to properly extract speaking portions when they were low in volume when recorded (level meter readout of -12 dB or less), or due to surrounding noise.
- The time needed for the extraction process will increase in proportion to the size of the recorded file. Before starting extraction, it's recommended to charge or replace the battery to ensure it will not run out before the process has finished.

# Moving/copying files [Move/Copy]

## Moving/copying files [Move/Copy]

Files saved in the internal memory or on a microSD card can be moved or copied within memory.

**!** WS-823 and WS-822 models only

- 1** Before performing the move/copy operation, first select the folder containing the file you want to move or copy (P.24).
- 2** Press the MENU/SCENE button while the voice recorder is in stop mode.
- 3** Press the ►OK button to move the cursor into the list of setting items.
- 4** Press the +/- button to select [Move/Copy].
- 5** Press the ►OK button.

- 6** Press the +/- button to select the desired file movement/copying method.

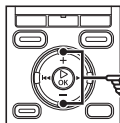

### [Move to memory]:

Moves one or more files saved in the internal memory or inserted microSD card to a different folder in the internal memory.

### [Copy to memory]:

Copies one or more files saved in the internal memory or inserted microSD card to a different folder in the internal memory.

### [Move to microSD]:

Moves one or more files saved in the internal memory or inserted microSD card to a different folder in the microSD card.

### [Copy to microSD]:

Copies one or more files saved in the internal memory or inserted microSD card to a different folder in the microSD card.

- 7** Press the ►OK button.

# Moving/copying files [Move/Copy]

## Moving/copying files [Move/Copy]

- 8 Press the +/- button to select the number of files to move or copy.**

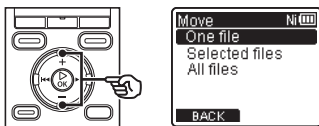

[One file]: Selects only the specified file

[Selected files]: Lets you select multiple files.

[All files]: Selects all the files in the folder.

- 9 Press the ►OK button to continue to the next setting.**



### When [One file] was selected

- ① Press the +/- button to select the file to move or copy, then press the ►OK button.

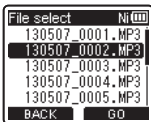

### When [Selected files] was selected

- ① Press the +/- button to select a file to move or copy, then press the ►OK button.

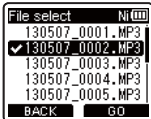

### TIP

- You can deselect a previously selected file by selecting it and pressing the ►OK button again.
- ② Repeat Step ① to select all the files you want to move or copy, then press the **F2** button.

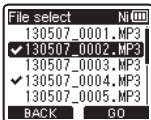

# Moving/copying files [Move/Copy]

## Moving/copying files [Move/Copy]

### When [All files] was selected

All the files in the current folder are selected automatically, and the display switches to the [Destination] screen.

- 10** Press the **+/-**, **▶▶** or **◀◀** button to select the folder to move or copy the files to.

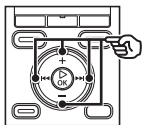

- 11** Press the **F2** button.

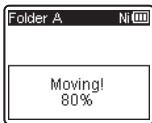
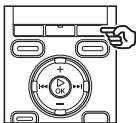

- The progress of the operation is shown as a percentage in the display.
- [File move completed] or [File copy completed] appears when the process has finished.

### TIP

- Locked files (P.61) remain locked after being moved or copied.

### NOTE

- Files cannot be copied if there is insufficient remaining memory.
- Files cannot be moved or copied if there are over 200 files.
- To prevent the risk of data damage, never remove the battery while moving or copying a file.
- Files cannot be moved or copied within the same folder.
- When a file moving or copying process is canceled before completion, the files that completed the process will have been moved or copied, and process is canceled for the other files.
- Files with DRM cannot be moved or copied.
- Files cannot be moved or copied directly within the [Recorder] folder. Instead, select one of the subfolders within the [Recorder] folder: Folders to [FM], or the [FM Radio]\* folder.

\* WS-823 model only

# Dividing files [File Divide]

## Dividing a file [File Divide]

Large files or files with long recording times can be divided for easier management and editing.

### NOTE

Only MP3-format and PCM-format\* files recorded on the voice recorder can be divided.

\* WS-823 and WS-822 models only

- 1 Play the file to divide, and stop playback at the desired division point.**
  - Press and hold the ►►I or I◀◀ button to fast-forward/rewind.
  - Writing an index mark/temp mark at the division point beforehand is handy.
- 2 Press the MENU/SCENE button while the voice recorder is in stop mode.**
- 3 Press the ►OK button to move the cursor into the list of setting items.**
- 4 Press the +/- button to select [File Divide].**
- 5 Press the ►OK button.**

- 6 Press the + button to select [Start].**

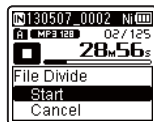
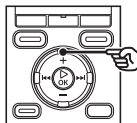

- 7 Press the ►OK button.**

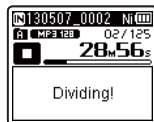

- [Dividing!] appears in the display, and the file dividing process starts.
  - [File divide completed] appears when the process has finished.
- 8 Press the STOP (■) button to exit the menu screen.**

# Dividing files [File Divide]

---

## Dividing a file [File Divide]

### TIP

- After dividing a file, the first half of the file is given the name "**File name\_1**" and the second half "**File name\_2**".

### NOTE

- **[File Divide]** can be performed only when the file list is displayed.
- Files cannot be divided if there are 200 files in the folder.
- Locked files (Ⓜ P.61) cannot be divided.
- It may not be possible to divide some MP3 or PCM files with extremely short recording times.
- To prevent the risk of data damage, never remove the battery while dividing a file.



# Setting the USB connection [USB Settings]

## Setting the USB connection [USB Settings]

The [PC] setting lets you connect the voice recorder to a PC to transfer files. The [AC Adapter] setting lets you connect the voice recorder to a USB-connection AC adapter (model A514; optional) to charge the rechargeable battery. You can change the USB class setting as required by different USB applications.

- 1** While the voice recorder is in stop mode, press and hold the MENU/ SCENE button.
- 2** Press the +/- button to select the [Device Menu] tab.
- 3** Press the ►OK button to move the cursor into the list of setting items.
- 4** Press the +/- button to select [USB Settings].
- 5** Press the ►OK button.

- 6** Press the +/- button to select [USB Connection] or [USB Class].

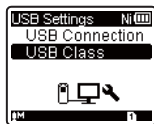
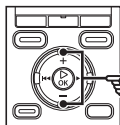

[USB Connection]:

Used to set connection to a PC.

[USB Class]:

Used to set the USB class.

- 7** Press the ►OK button.

When [USB Connection] was selected

➤ Go to Step 8

When [USB Class] was selected

➤ Go to Step 10

### TIP

- If the voice recorder is not recognized by the PC as an external memory device, select [Storage Class] for [USB Class].
- If [AC Adapter] is selected for [USB Connection], the voice recorder will not be recognized if connected to a PC.

# Setting the USB connection [USB Settings]

## Setting the USB connection [USB Settings]

### When [USB Connection] was selected

- 8** Press the +/– button to select a setting.

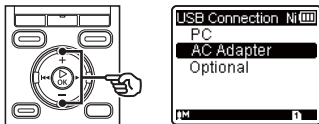

#### [PC]:

Select to connect the voice recorder to a PC. The voice recorder will be connected as a storage or composite device.

#### [AC Adapter]:

Select to charge the rechargeable battery from a PC, or to connect the voice recorder to an AC adapter (model A514; optional).

#### [Optional]:

Select to confirm the connection method whenever making a USB connection.

- 9** Press the ►OK button, and go to Step **12**.

### When [USB Class] was selected

- 10** Press the +/– button to select a setting.

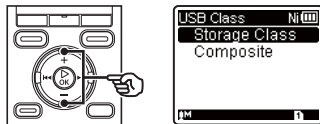

#### [Storage Class]:

Select to have the voice recorder recognized as an external memory device by a connected PC.

#### [Composite]:

Select to have the voice recorder recognized as an external memory device by a connected PC, and to use the voice recorder as a USB speaker/ microphone.

- 11** Press the ►OK button, and go to Step **12**.
- 12** Press the STOP (■) button to exit the menu screen.

# Formatting recording media [Format]

## Formatting a recording media [Format]

Formatting a recording media erases all existing files saved on it. Be sure to transfer all important files to a PC before formatting.

- 1 While the voice recorder is in stop mode, press and hold the MENU/ SCENE button.
- 2 Press the +/- button to select the [Device Menu] tab.
- 3 Press the ►OK button to move the cursor into the list of setting items.
- 4 Press the +/- button to select [Format].
- 5 Press the ►OK button.
- 6 Press the +/- button to select the recording media to be formatted.
- 7 Press the ►OK button.
- 8 Press the + button to select [Start].

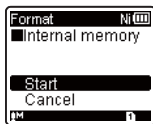

- 9 Press the ►OK button.

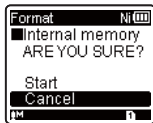

- 10 Press the + button to select [Start] again.

- 11 Press the ►OK button.

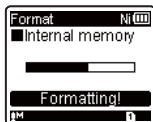

- [Formatting!] appears, and formatting starts.
- [Format done] appears when the process has finished.

### TIP

- To reset all the voice recorder's settings to their default values, use the [Reset Settings] operation (P.79).

## Formatting a recording media [Format]

### NOTE

- Never format the voice recorder from a PC.
- Formatting erases all the existing data, including locked files and read-only files.
- If there is a microSD card in the voice recorder, make sure [Internal memory] or [microSD card] has been correctly selected as the recording media to erase (P.77).
- Before formatting, charge or replace the battery to ensure it will not run out before the process has finished. The formatting process can sometimes take over 10 seconds to complete. To prevent the risk of damage to data, never attempt to perform any of the following processes before a formatting process has finished:
  - ① Disconnecting the USB-connection AC adapter
  - ② Removing the battery
  - ③ Removing the microSD card (if the recording media has been set to [microSD card])
- Even when formatting or erasing (P.46) is performed, only the file management information of the internal memory and/or microSD card is updated and the recorded data is not completely erased. When disposing of a microSD card, be sure to destroy the card, format the card and record silence until the recording time runs out, or perform a similar operation in order to prevent the leakage of personal information.

# Use with a PC

Connecting the voice recorder to a PC lets you:

- Play WMA-, MP3- and WAV\*-format language-learning content and music files loaded on a PC using Windows Media Player or iTunes.  
\* WS-823 and WS-822 models only
- As well as a voice recorder and music player, you can use this device as a PC's external memory device to save or read data from the PC (see P.98).

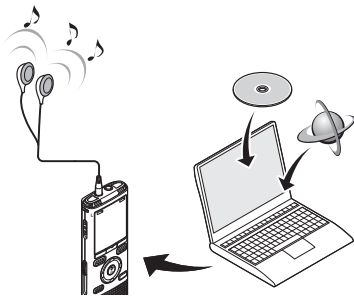

## PC operating environment

### Windows

#### Operating system

Microsoft Windows XP/Vista/7/8  
standard installation

#### PC

Windows PC with at least one available USB  
port

### Macintosh

#### Operating system

Mac OS X 10.5 to 10.8  
standard installation

#### PC

Apple Macintosh series PC with at least one  
available USB port

### NOTE

- The requirements shown are the operating environments needed for using a USB connection to save files recorded by the voice recorder on a PC.
- Even when the requirements for the operating environment are satisfied, updated versions, multiboot environments, self-modified PCs and other compatible machines will not be covered under the operational warranty.

## PC connection precautions

- When uploading or downloading a file to or from the voice recorder, data transfer will continue as long as the voice recorder's LED indicator light is flashing, even if the PC data communication screen disappears. Never disconnect the USB connector before data communication has finished. Always use the procedure on [P.96](#) to disconnect the USB connector. Data may not be transferred correctly if you disconnect the connector before the drive has stopped.
- Do not format (initialize) the voice recorder's drive from a PC. Formatting done from a PC will not be done correctly. Use the voice recorder's **[Format]** menu for formatting ([P.91](#)).
- Voice recorder folders or files that are moved or renamed in a Windows or Macintosh file management screen may be reordered or become unrecognizable.
- Note that it will still be possible to read and write data on the voice recorder after setting the attribute of the voice recorder's drive to 'Read only' on a PC.
- To prevent nearby electronic devices being affected by noise, disconnect the external microphone and earphones when connecting the voice recorder to a PC.

# PC connection/disconnection

## Connecting the voice recorder to a PC

- 1 Start the PC.
- 2 Slide the USB connector slide lever in the direction of the arrow.

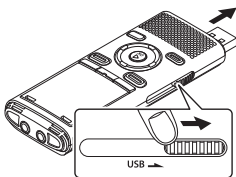

- The USB connector extends out. The USB connector cover is stored inside the voice recorder.

- 3 After making sure the voice recorder is in stop mode, connect its USB connector to a USB port on the PC.

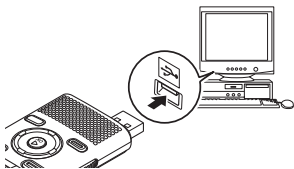

- **[Remote (Storage)]** appears in the voice recorder's display when the USB connector is connected.
- The voice recorder will not connect to the PC if **[AC Adapter]** was selected for the voice recorder's **[USB Connection]** setting. Select **[PC]** for the **[USB Connection]** setting (P.89).

### TIP

- Windows: The voice recorder is recognized and displayed in the **[My Computer]** folder with the model name as the drive name. If there is a microSD card in the voice recorder, it can be used as the **[Removable Disk]**.
- Macintosh: The voice recorder is recognized and displayed on the desktop with the model name as the drive name. If there is a microSD card in the voice recorder, **[Untitled]** is displayed.
- For information on the PC's USB port, see the PC's user manual.
- Use the USB extension cable provided if needed (only for WS-823 model).

### NOTE

- The voice recorder must not be in HOLD mode.
- Insert the USB connector securely all the way. Operation will not be normal if the connection is not made properly.
- Connecting the voice recorder through a USB hub may result in unstable operation. Do not use a USB hub if operation is unstable.
- Use only a compatible Olympus USB extension cable. Operation is not guaranteed if another manufacturer's cable is used. Only use the Olympus USB extension cable with the voice recorder and never use it with another manufacturer's products.

# PC connection/disconnection

## Disconnecting the voice recorder from a PC

### Windows

- 1 On the task bar at the bottom-right of the screen, click [  ] and select [Safely remove USB Mass Storage Device].

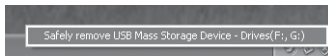

- The letter used to identify the drive will vary according to your PC.
- When the window indicating it is safe to remove hardware appears, close the window.

- 2 Check that the voice recorder's LED indicator light is off before disconnecting the voice recorder from the PC.

### Macintosh

- 1 Drag-and-drop the removable disk icon for the voice recorder shown on the desktop to the trash can icon.



- 2 Check that the voice recorder's LED indicator light is off before disconnecting the voice recorder from the PC.

### NOTE

- To prevent the risk of data damage, never disconnect the voice recorder from the USB port while the LED indicator light is flashing.



# Loading a file to a PC

The voice recorder's five audio recording folders are displayed on the PC as [FOLDER\_A], [FOLDER\_B], [FOLDER\_C], [FOLDER\_D] and [FOLDER\_E]. Recorded audio files are displayed within these folders (for WS-823 model only, recordings from FM radio are saved in a folder labeled [FLD\_FM]). You can copy voice recorder files to any folder on the PC.

## ■ Voice recorder drive name and folder names on the PC

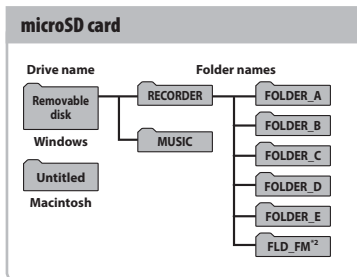
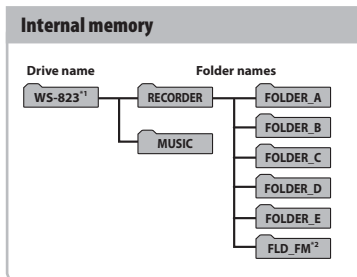

\*1 Recognized/displayed by voice recorder drive name

\*2 WS-823 model only

### NOTE

- To prevent the risk of data damage, never disconnect the voice recorder from the USB port while the LED indicator light is flashing.
- WMA-format files cannot be played in the standard Macintosh operating system.

# Usage as external memory of the PC

Connecting the voice recorder to a PC lets you transfer voice recorder data to save in the PC, and vice-versa.

## Windows

- 1 Connect the voice recorder to the PC (P.95).**
- 2 Open Windows Explorer.**
  - When you open [My Computer], the voice recorder is recognized and displayed with the model name as the drive name.
- 3 Click on the folder labeled with your voice recorder's model name.**
- 4 Copy the desired data to the PC.**
- 5 Disconnect the voice recorder from the PC (P.96).**

## Macintosh

- 1 Connect the voice recorder to the PC (P.95).**
  - When the voice recorder is connected to the Macintosh operating system, it is recognized and displayed on the desktop with the model name as the drive name.
- 2 Double-click the removable disk icon labeled with your voice recorder's model name.**
- 3 Copy the desired data to the PC.**
- 4 Disconnect the voice recorder from the PC (P.96).**

### NOTE

- During data communication, [Busy] appears in the voice recorder's display and the LED indicator light flashes. To prevent the risk of data damage, never disconnect the voice recorder from the USB port while the LED indicator light is flashing.

# Other information

## Alarm message list

Message	Meaning	Action required
<b>Battery low</b>	The remaining battery power is low.	Replace or charge the battery (☞ P.9, P.11).
<b>File locked</b>	An attempt was made to erase a locked file.	You must unlock the file before you can erase it (☞ P.61).
<b>Cannot record in this folder</b>	An attempt was made to record when not in <b>[Recorder]</b> mode.	Before recording, select <b>[Recorder]</b> mode and one of the folders from <b>[Folder A]</b> to <b>[Folder E]</b> (☞ P.21, P.24).
	<b>WS-823 model only</b>	
	An attempt was made to record in the <b>[FM Radio]</b> folder.	Before recording, select one of the folders from <b>[Folder A]</b> to <b>[Folder E]</b> (☞ P.23, P.24).
<b>No more can be set</b>	The maximum number of index marks (99) have been written in the file.	Erase unneeded index marks (☞ P.43).
	The maximum number of temp marks (99) have been written in the file.	Erase unneeded temp marks (☞ P.43).
<b>Folder full</b>	The maximum number of files (200) have been saved in the folder.	Erase unneeded files (☞ P.46).
<b>Memory error</b>	An internal memory error occurred.	Contact the Olympus Customer Support Center (☞ back cover).
<b>Card error</b>	The microSD card was not recognized correctly.	Remove and reinsert the microSD card (☞ P.17, P.18).
<b>Illegally copied file</b>	The music file was copied illegally.	Erase the music file (☞ P.46).
<b>Memory full</b>	There is no remaining memory.	Erase unneeded files (☞ P.46).

# Alarm message list

Message	Meaning	Action required
No file	There are no files in the folder.	Select another folder (☞ P.23, P.24).
Format error	A formatting problem occurred.	Format the memory again (☞ P.91).
Can't create the system file. Connect to PC and erase unnecessary file	The voice recorder is unable to create a management file due to low remaining memory.	Connect the voice recorder to a PC and erase unneeded files.
Cannot play this file	The file's format is not supported.	Select a file that can be played by the voice recorder (☞ P.38).
Select a file	No file has been selected.	You must select a file before you can perform the operation (☞ P.23, P.24).
Same folder can't be moved (copied)	An attempt was made to move (copy) a file to the same folder.	Select another folder.
Some files can't be moved (copied)	A file with the same name as a file being moved (copied) exists in the destination folder.	Select another file.
This file can't be divided.	An attempt was made to divide a file that is not an MP3- or WAV-format file recorded by the voice recorder.	Select another file.
Insert earphone	<b>WS-823 model only</b>	
	Earphones that function as an antenna for listening to FM radio are not inserted.	Select FM radio mode after inserting the earphone.

# Troubleshooting

Problem	Possible cause	Solution
<b>The display is blank.</b>	The battery is not inserted properly.	Check that the positive and negative terminals of the battery are placed correctly (☞ P.9).
	The remaining battery power is low.	Replace or charge the battery (☞ P.9, P.11).
	The power is OFF.	Turn the power ON (☞ P.9).
<b>Unable to operate the voice recorder</b>	The remaining battery power is low.	Replace or charge the battery (☞ P.9, P.11).
	The power is OFF.	Turn the power ON (☞ P.9).
	The voice recorder is in HOLD mode.	Release HOLD mode (☞ P.19).
<b>Unable to record</b>	There is no remaining memory.	Erase unneeded files (☞ P.46).
	The maximum number of recordable files has been reached.	Select another folder (☞ P.23, P.24).
	<b>WS-823 model only</b>	
	[Speaker] has been selected for [Output] in the [FM Menu].	Select [Earphone] for [Output] (☞ P.81).
<b>Playback is inaudible.</b>	The earphones are connected to the EAR jack.	To output the playback through the built-in speaker, disconnect the earphones.
	[Off] has been selected for [Speaker].	To output the playback through the built-in speaker, select [On] for [Speaker] (☞ P.76).
	The volume is set to [00].	Adjust the volume (☞ P.34).
<b>The recording is too quiet.</b>	A low recording level has been set.	Redo recording after setting the recording level to [High] or [Middle] (☞ P.63).
	The output level of the connected external device may be too low.	Adjust the output level of the external device.
	<b>WS-823 model only</b>	
	The recording level hasn't been adjusted.	Redo recording after adjusting the recording level (☞ P.63).

# Troubleshooting

Problem	Possible cause	Solution
<b>Audio file sound is distorted.</b>	<b>WS-823 model only</b>	
	The recording level hasn't been adjusted.	Redo recording after adjusting the recording level (☞ P.63).
	The voice recorder's recording level, or the output level of the connected external device may be too high.	If the problem continues after adjusting the voice recorder's recording level (☞ P.63), adjust the output level of the external device.
<b>An audio file is not recorded in stereo.</b>	The connected external microphone is a mono microphone.	Sound recorded by a connected external mono microphone is recorded on the left channel only.
	[ <b>Rec Mode</b> ] is set to a mono recording format.	Set [ <b>Rec Mode</b> ] to a stereo recording format (☞ P.64).
	<b>WS-823 model only</b>	
	A positive (+) value has been selected for [ <b>Zoom Mic</b> ].	Select [ <b>Off</b> ] for [ <b>Zoom Mic</b> ] (☞ P.64).
<b>Missing audio file</b>	The file was recorded in a different folder.	Select another folder (☞ P.23, P.24).
<b>Noise during playback</b>	Objects brushed against the voice recorder while recording.	_____
	The voice recorder was placed near a mobile phone or fluorescent light during recording or playback.	Redo the operation with the voice recorder in a different location.
<b>Non-voice portions are not skipped during playback.</b>	<b>WS-823 and WS-822 models only</b>	
	The [ <b>Voice Detect</b> ] process has not been performed.	Use the [ <b>Voice Detect</b> ] function to extract the speaking portions (☞ P.82).
	[ <b>Off</b> ] has been selected for [ <b>Voice Playback</b> ].	Select [ <b>On</b> ] for [ <b>Voice Playback</b> ] (☞ P.69).
<b>Unable to erase a file</b>	The file is locked.	You must unlock the file before you can erase it (☞ P.61).
	The file is a read-only file.	Unlock the file, or undo the read-only setting on a PC.
<b>Unable to erase a folder</b>	The folder contains a file that the voice recorder cannot recognize.	Connect the voice recorder to a PC to erase the folder (☞ P.95).

Problem	Possible cause	Solution
Noise when monitoring a recording	Feedback is being caused.	Connecting a speaker with a built-in amplifier may cause feedback during recording. Using the earphones to monitor recording is recommended.
		Adjust the recording setup such as by moving the earphones and microphone farther apart, or ensuring the microphone is not facing the earphones.
Unable to write index marks/temp marks	The maximum number of marks (99) has been reached.	Erase unneeded marks (☞ P.43).
	The file is locked.	Unlock the file (☞ P.61).
	The file is a read-only file.	Unlock the file, or undo the read-only setting on a PC.
Unable to listen to FM radio	<b>WS-823 model only</b>	
	The earphones are not connected to the EAR jack.	The earphones provided also function as an antenna. Connect the earphones when listening to the radio.
	[Earphone] has been selected for [Output].	To output the sound through the built-in speaker, select [Speaker] for [Output] (☞ P.81).
Unable to charge the battery	<b>WS-823 and WS-822 models only</b>	
	[Alkaline] has been selected for [Battery].	To use the rechargeable battery provided, select [Ni-MH] for [Battery]. Do not use the rechargeable battery at higher/lower temperatures than the recommended range (☞ P.10, P.15, P.77).
	The ►OK button was not pressed.	Press the ►OK button as directed in the confirmation screen shown when connecting the USB connector.
	[Composite] has been selected for [USB Class].	Select [Storage Class] for [USB Class] (☞ P.89).
The PC is unable to recognize the voice recorder.	[AC Adapter] has been selected for [USB Connection].	Select [PC] for [USB Connection] (☞ P.89).
Button operations are abnormal.	[Transcription] or [Language study] has been selected for [Play Scene].	Select [Off] for [Play Scene] (☞ P.45, P.74).

# Recorder care

---

## ● Exterior

- Wipe gently with a soft cloth. If the recorder is very dirty, soak the cloth in mild soapy water and wring well. Wipe the recorder with the damp cloth and then wipe it with a dry cloth.

## ● Monitor

- Wipe gently with a soft cloth.

### NOTE

- Do not use benzene, alcohol or other strong solvents, or chemical cleaning cloths.



# Accessories (optional)

Accessories for Olympus voice recorders can be purchased directly from the Online Shop on the Olympus website.

Availability of accessories differs depending on the country.

## **ME15SW stereo microphone**

Has a large-diameter built-in microphone for sensitive stereo recording.

## **ME30W two-channel microphone (omnidirectional)**

An omnidirectional microphone pair with a low-noise design ideal for recording in lecture halls or other large venues. The left and right microphones can be placed up to about 5 meters apart.

## **ME31 compact gun microphone (unidirectional)**

A directional gun microphone handy for outdoor recording of wild birds singing and other highly directional applications. The metal body provides a highly rigid body.

## **ME34 compact zoom microphone (unidirectional)**

Comes with an integrated tripod ideal for table placement when recording events from a distance, such as conferences or lectures.

## **ME33 boundary microphone**

A microphone for recording conferences that enables connection of up to three left- and three right-channel units. Cascade connection enables the left/right channel connections to be extended up to about 12 meters, to capture sound from a broad range.

## **ME52W mono microphone (unidirectional)**

Designed to record sound from a distance while minimizing the impact of surrounding noise.

Download from [Www.Somanuals.com](http://Www.Somanuals.com). All Manuals Search And Download.

## **ME15 mono tie clip microphone (omnidirectional)**

A small, unobtrusive microphone that comes with a tie-clip.

## **TP8 telephone pickup microphone**

An earphone microphone that can be worn in the ear during phone calls. Clearly captures voices and conversations during phone calls.

## **BR404 nickel-metal hydride AAA rechargeable battery**

A high-efficiency, long-lasting rechargeable battery.

## **A514 USB-connection AC adapter**

A USB-connected AC adapter that provides 5-volt DC output. (100-240 VAC, 50/60 Hz)

## **KA333 connecting cord**

A resistive connection cord with stereo mini-plugs (3.5 mm diameter) on both ends. Used to connect the earphone jack output to the line input when recording. Comes with plug adapters (PA331/PA231) that adapt to mono mini plugs (3.5 mm diameter) or mono mini plugs (2.5 mm diameter).

## **KP19 USB connection cable**

# Copyright and trademark information

- The information in this document is subject to change in future without prior notice. Contact Olympus Customer Support Center for the latest product names, model numbers and other information.
- Voice recorder displays and product illustrations shown in this manual may differ from the actual product. While every precaution has been taken to ensure the accuracy of the information in this manual, errors may occasionally arise. Any questions or concerns regarding doubtful information, or possible errors or omissions should be directed to the Olympus Customer Support Center.
- Olympus Corporation and Olympus Imaging Corp. are the copyright holders of this manual. Copyright law prohibits unauthorized reproduction of this manual, or unauthorized distribution of reproductions thereof.
- Note that Olympus will assume no liability in the event of damages, lost earnings, or any claims from third parties resulting from improper use of the product.

## Trademarks and registered trademarks

- IBM and PC/AT are trademarks or registered trademarks of International Business Machines Corporation.
- Microsoft, Windows and Windows Media are registered trademarks of Microsoft Corporation.
- microSD and microSDHC are trademarks of the SD Card Association.
- Macintosh and iTunes are trademarks of Apple Inc.
- The product uses MP3 audio coding technology licensed from Fraunhofer IIS and Thomson.
- The product uses noise-canceling technology licensed from NEC Corporation.
- The product uses voice activity detection technology licensed from NTT Electronics Corporation.
- The product uses directivity control technology licensed from Kyoei Engineering Corporation.

All other brand or product names in this manual are the trademarks or registered trademarks of their respective owners.



# Safety precautions

Before using the voice recorder, read this manual to ensure correct and safe operation. After reading this manual, be sure to keep it on hand for ready reference whenever needed.

## Important safety precautions

- Important safety precautions in this manual are accompanied by the symbol and labels below. Always follow these precautions to prevent harming yourself or others, or causing damage to property.
- The meaning of each precaution type is given below.



### DANGER

A precaution about an imminent danger that is expected to result in death or serious injury if equipment is handed incorrectly.



### WARNING

A precaution about a situation that is expected to potentially result in death or serious injury if equipment is handled incorrectly.



### CAUTION

A precaution about a situation that is expected to potentially result in injury, or is expected to result only in property damage, if equipment is handled incorrectly.

## Voice recorder safety precautions



### WARNING

- **Do not use the voice recorder in an atmosphere that might contain flammable or explosive gases.**  
It may cause fire or explosion.
- **Do not attempt to disassemble, repair or modify the voice recorder.**  
It may cause electric shock or injury.
- **Do not operate the voice recorder while operating a vehicle (such as a bicycle, motorcycle or car).**  
It may cause traffic accidents.
- **Do not leave the voice recorder in a location accessible to an infant or child.**

Pay attention when using the voice recorder near an infant or child, taking care not to leave it unattended. Infants and children are unable to understand voice recorder safety precautions, and are at risk of accidents such as:

- Strangulation caused by accidental entanglement of the earphone cord around the neck.
- Operation errors resulting in injury or electric shock.

- **Use microSD/microSDHC memory cards only. Never place other types of cards in the voice recorder.**

If another card type is placed in the voice recorder by accident, do not try to pull it out by force. Contact an Olympus repair center or service center.

# Safety precautions

- **If the voice recorder is dropped in water or, if water, metal or combustible foreign matter gets inside:**

- ① Remove the battery immediately.
- ② Contact your place of purchase or an Olympus service center for repair. Continued use may result in fire or electric shock.

- **Do not use the voice recorder or use it only as directed in airplanes, hospitals or other locations where use of electronic devices is restricted.**
- **Stop using the voice recorder if you notice unusual odor, noise, or smoke coming from it.**

It may cause fire or burns. Remove the battery immediately, taking care not to burn yourself. Contact your place of purchase or an Olympus repair center or service center. (Do not touch the battery with bare hands when removing it. Remove the battery outdoors, and away from flammable objects.)

- **When carrying the voice recorder by its strap, take care to prevent it becoming caught on other items.**

## CAUTION

- **Do not raise the volume before performing an operation.**  
Hearing damage or loss may result.

## Batteries

### DANGER

- **Do not place the battery near ignition sources.**
- **Do not incinerate, heat or disassemble the battery. Do not short-circuit the battery's positive and negative electrodes.**

It may cause fire, ruptures, combustion or overheating.

- **Do not solder connections directly onto the battery. Do not deform, modify or disassemble the battery.**
- **Do not connect the battery's positive and negative terminals.**

It may cause overheating, electric shock or fire.

- **When carrying or storing the battery, always place it in the case and protect its terminals. Do not carry or store the battery together with precious metal items such as key rings.**

It may cause overheating, electric shock or fire.

- **Do not connect the battery directly to a power outlet or car cigarette lighter.**
- **Do not use or leave the battery in a hot location such as in direct sunlight, inside a vehicle on a hot day, or near a room heater.**

It may cause fire, burns or injuries from leaking, overheating or ruptures.

# Safety precautions

## WARNING

- **Do not touch or hold the battery with wet hands.**

It may cause electric shock or malfunctions.

- **Do not use a battery with a scratched or damaged case.**

It may cause ruptures or overheating.

- **Do not insert the battery with its positive/negative terminals in the opposite direction.**

It may cause leaking, overheating, combustion or ruptures.

- Do not use a battery with a torn casing seal (insulating covering).
- Always remove the battery when the voice recorder will not be used for an long period.
- When disposing used batteries, insulate their contacts with tape and discard them as general waste in the manner prescribed by the local authority.
- Remove the battery from the voice recorder as soon as the battery becomes unusable. It may cause leakage.

- **Battery fluid in the eyes may cause blindness. If battery fluid gets in eyes, do not rub the eyes. Instead, rinse them thoroughly with tap water or other clean water right away. Go to doctor immediately.**

- **Do not attempt to recharge alkaline, lithium or any other non-rechargeable batteries.**
- **Keep the battery out of the reach of infants and children.**

The battery could be swallowed by an infant or child. If swallowed, go to doctor immediately.

- **If you notice abnormal sound, heat, burning odor or smoke from the voice recorder during use:**

- ① Remove the battery immediately, taking care not to injure yourself.
- ② Have the voice recorder repaired by your place of purchase or an Olympus service center. Continued use may result in fire or burns.

- **Do not submerge the battery in freshwater or saltwater, or allow its terminals to become wet.**
- **Discontinue use of the battery if it develops a problem such as leaking, discoloration or deformation.**
- **Stop charging the rechargeable battery if charging has not finished after the specified amount of charging time.**
- **Battery fluid on clothing or skin may damage the skin, so rinse the battery fluid off right away with tap water or other clean water.**

## CAUTION

- **Do not throw the battery around, or subject it to strong shocks.**
- **Always charge the rechargeable battery before use when using it for the first time or if it has not been used for a long time.**
- **Rechargeable batteries have a limited life. When the recorders operating time becomes shorter after recharging under the specified condition, please consider that battery is expired and replace it with a new one.**

## Disposing the rechargeable battery

- **Recycling batteries helps saving resources. When disposing a used battery, always cover its terminals and observe local laws and regulations.**

## Operating precautions

- Do not leave the voice recorder in hot or humid locations such as in direct sunlight inside a vehicle, or on a beach during summer.
- Do not store the voice recorder in humid or dusty locations.
- If the voice recorder becomes wet or damp, wipe off the moisture right away with a dry cloth. Contact with salt water should be particularly avoided.
- Do not place the voice recorder on top of or near a TV, refrigerator or other electrical appliance.
- Prevent sand or mud from getting on the voice recorder. It may cause product not to be repairable.
- Do not subject the voice recorder to intense vibrations or shocks.
- Do not use the voice recorder in humid locations.
- Placing a magnetic card (such as a bank cash card) near the speaker or earphones may cause errors in the data stored on the magnetic card.

### <Radio reception precaution>

- Reception quality will vary greatly depending on where the radio is being used. If the reception is poor, try moving the voice recorder near a window and away from electric appliances such as mobile phones, TVs or fluorescent lights.

### <Data loss precautions>

- Recorded content in the internal memory and microSD card may be destroyed or lost due to reasons such as operating errors, device failure or repair.
- Also, when content is saved in the memory for long period of time or is used repeatedly, operations such as writing to, reading from, or erasing of contents may not be possible.
- Making a backup of important recorded information and saving it on a PC's hard disk or other recording media is recommended.
- Note that Olympus will assume no liability for damages or lost earnings resulting from recorded data damage or loss, regardless of the nature or cause thereof.

### <Recorded file precautions>

- Note that Olympus will assume no liability for recorded files being erased or becoming unplayable due to voice recorder or PC failure.
- Recording of copyrighted material is permitted when the recording is for your personal use only. Any other type of use without the permission of the copyright owner is prohibited by copyright law.

### <Voice recorder and microSD cards disposal precautions>

- Even when formatting (ⓘ P.91) or erasing (ⓘ P.46) are performed, only the file management information of the internal memory and/or microSD card is updated and the recorded data is not completely erased.

When disposing of the voice recorder or a microSD card, be sure to destroy it, format and record silence until the recording time runs out, or perform a similar operation in order to prevent the leakage of personal information.

# Specifications

## General items

### ■ Recording formats

Linear PCM (pulse-code modulation) format (WS-823 and WS-822 models only)  
MP3 (MPEG-1 Audio Layer 3) format  
WMA (Windows Media Audio) format

### ■ Sampling frequency

Linear PCM format

44.1 kHz/16 bits*1	44.1 kHz
--------------------	----------

MP3 format

256 kbps*1	44.1 kHz
192 kbps*2	44.1 kHz
128 kbps	44.1 kHz

WMA format

32 kbps	44.1 kHz
8 kbps	8 kHz

\*1 WS-823 and WS-822 models only

\*2 WS-821 model only

### ■ Maximum working output

150 mW (8 Ω speaker)

### ■ Maximum earphone output

≤ 150 mV (conforms to EN 50332-2)

### ■ Wide band characteristic earphone output

75 mV ≤ (conforms to EN 50332-2)

### ■ Recording media\*

Internal NAND flash memory

WS-823 model: 8 GB; WS-822 model:  
4 GB; WS-821 model: 2 GB

microSD card

(Supports card capacities ranging from  
2 to 32 GB.)

\* Some recording media memory  
capacity is used as a management  
area, so the actual usable capacity  
will always be slightly less than the  
displayed capacity.

### ■ Speaker

Built-in 18 mm diameter round dynamic  
speaker

### ■ MIC jack

3.5 mm diameter; Impedance: 2 kΩ

### ■ EAR jack

3.5 mm diameter; Impedance: 8 Ω  
minimum

### ■ Power source

Standard voltage: 1.5 V

Battery: One AAA dry cell battery (model  
LR03), or one Olympus nickel-metal  
hydride rechargeable battery

External power supply: USB-connection  
AC adapter (model A514; 5 VDC)

### ■ External dimensions

101 × 40.6 × 15.1 mm (Not including  
largest projection)

### ■ Weight

54 g (including battery)

### ■ Operating temperature

0 to 42°C (32 to 107.6°F)

### ■ Receivable radio frequency range

FM radio: 87.5 to 108.0 MHz

## Frequency response

### ■ When recording from MIC jack

Linear PCM format

44.1 kHz/16 bits*1	40 Hz to 21 kHz
--------------------	-----------------

MP3 format

256 kbps*1	40 Hz to 20 kHz
192 kbps*2	40 Hz to 19 kHz
128 kbps	40 Hz to 17 kHz

WMA format

32 kbps	40 Hz to 13 kHz
8 kbps	40 Hz to 3 kHz

\*1 WS-823 and WS-822 models only

\*2 WS-821 model only

### ■ When recording with built-in stereo microphone

70 Hz to 20 kHz (frequency response upper limit is set by recording mode during MP3/WMA-format recording)

### ■ During playback

20 Hz to 20 kHz



## Battery life

The figures below are guideline values.

### ■ When recording with built-in stereo microphone (using internal memory)

Recording mode		Alkaline dry cell battery	Nickel-metal hydride rechargeable battery
Linear PCM format	44.1 kHz/16 bits*	20 hours (approx.)	15 hours (approx.)
MP3 format	128 kbps	27 hours (approx.)	21 hours (approx.)
WMA format	32 kbps	32 hours (approx.)	24 hours (approx.)
	8 kbps	37 hours (approx.)	28 hours (approx.)

### ■ During audio file playback (all playback modes)

During speaker playback

Recording mode		Alkaline dry cell battery	Nickel-metal hydride rechargeable battery
Linear PCM format	44.1 kHz/16 bits*	19 hours (approx.)	15 hours (approx.)
MP3 format	128 kbps	21 hours (approx.)	17 hours (approx.)
WMA format	32 kbps	21 hours (approx.)	17 hours (approx.)
	8 kbps	24 hours (approx.)	20 hours (approx.)

During earphone playback

Recording mode		Alkaline dry cell battery	Nickel-metal hydride rechargeable battery
Linear PCM format	44.1 kHz/16 bits*	22 hours (approx.)	17 hours (approx.)
MP3 format	128 kbps	29 hours (approx.)	21 hours (approx.)
WMA format	32 kbps	30 hours (approx.)	22 hours (approx.)
	8 kbps	30 hours (approx.)	22 hours (approx.)

\* WS-823 and WS-822 models only

### ■ During FM radio mode (using internal memory; WS-823 model only)

During earphone playback

Voice recorder status	Alkaline dry cell battery	Nickel-metal hydride rechargeable battery
Receiving FM radio	12 hours (approx.)	11 hours (approx.)
Recording FM radio (MP3 format 128 kbps)	8 hours (approx.)	8 hours (approx.)

# Specifications

## NOTE

- The battery life figures shown here were determined using an Olympus test method. Actual battery life figures will vary greatly according to the battery used and usage conditions.
- Battery life will be shorter when using a nickel-metal hydride rechargeable battery that has been used repeatedly.
- Battery life will be shorter when using a microSD card.
- Changing the playback speed and tone, or using the **[Zoom Mic]**, **[Noise Cancel]**, **[Voice Balancer]** and **[Voice Filter]** functions may affect the battery life.

## Recording time

The figures below are guideline values.

### ■ Linear PCM format

Recording media		Recording mode
Internal memory	WS-823 model (8 GB)	44.1 kHz/16 bits 11 hours, 30 minutes (approx.)
	WS-822 model (4 GB)	5 hours, 45 minutes (approx.)
microSD card	32 GB	48 hours (approx.)
	16 GB	23 hours, 30 minutes (approx.)
	8 GB	11 hours, 30 minutes (approx.)

### ■ MP3 format

Recording media		Recording mode		
		256 kbps	192 kbps	128 kbps
Internal memory	WS-823 model (8 GB)	65 hours (approx.)	—	130 hours (approx.)
	WS-822 model (4 GB)	32 hours, 30 minutes (approx.)	—	65 hours (approx.)
	WS-821 model (2 GB)	—	21 hours, 30 minutes (approx.)	32 hours (approx.)
microSD card	32 GB	265 hours (approx.)	353 hours (approx.)	530 hours (approx.)
	16 GB	132 hours (approx.)	176 hours (approx.)	264 hours (approx.)
	8 GB	66 hours (approx.)	88 hours (approx.)	132 hours (approx.)

# Specifications

## ■ WMA format

Recording media		Recording mode	
		32 kbps	8 kbps
Internal memory	WS-823 model (8 GB)	505 hours (approx.)	1980 hours (approx.)
	WS-822 model (4 GB)	257 hours (approx.)	1000 hours (approx.)
	WS-821 model (2 GB)	126 hours (approx.)	493 hours (approx.)
microSD card	32 GB	2070 hours (approx.)	8100 hours (approx.)
	16 GB	1030 hours (approx.)	4030 hours (approx.)
	8 GB	515 hours (approx.)	2010 hours (approx.)

### NOTE

- Actual available recording times may be shorter than the figures shown here when making short recordings repeatedly (Equipment displays of available/elapsed recording times should be considered guideline values).
- Available recording time will also vary due to differences in the available memory capacity of different microSD cards.

# Specifications

## Maximum recording time per file

- The maximum file size is limited to about 4 GB in the WMA and MP3 formats, and to about 2 GB in the linear PCM (WAV) format.
- Regardless of the amount of remaining memory, the maximum recording time per file is restricted to the following values:

### ■ Linear PCM format

Recording mode	Recording time
44.1 kHz/16 bits <sup>*1</sup>	3 hours, 20 minutes (approx.)

### ■ MP3 format

Recording mode	Recording time
256 kbps <sup>*1</sup>	37 hours, 10 minutes (approx.)
192 kbps <sup>*2</sup>	49 hours, 30 minutes (approx.)
128 kbps	74 hours, 30 minutes (approx.)

### ■ WMA format

Recording mode	Recording time
32 kbps	26 hours, 40 minutes (approx.)
8 kbps	148 hours, 40 minutes (approx.)

\*1 WS-823 and WS-822 models only

\*2 WS-821 model only

## Number of music tracks (songs) that can be recorded

The figures below are guideline values.

WS-823 model (8 GB)	1,950 tracks (approx.)
WS-822 model (4 GB)	950 tracks (approx.)
WS-821 model (2 GB)	450 tracks (approx.)

(At 128 kbps, 4 minutes per track)

Note that voice recorder specifications and appearance are subject to change without prior notice for performance improvements or other upgrading.

## FCC Notice

- Radio and Television Interference
- Changes or modifications not expressly approved by the manufacturer may void the user's authority to operate this equipment. This equipment has been tested and found to comply with the limits for a Class B digital device, pursuant to Part 15 of the FCC Rules. These limits are designed to provide reasonable protection against harmful interference in a residential installation.
- This equipment generates, uses, and can radiate radio frequency energy and, if not installed and used in accordance with the instructions, may cause harmful interference to radio communications.
- However, there is no guarantee that interference will not occur in a particular installation. If this equipment does cause harmful interference to radio or television reception, which can be determined by turning the equipment off and on, the user is encouraged to try to correct the interference by one or more of the following measures:
  - Adjust or relocate the receiving antenna.
  - Increase the distance between the equipment and receiver.
  - Connect the equipment to an outlet on a circuit different from that to which the receiver is connected.
  - Consult your dealer or an experienced radio/TV technician for help. Only the OLYMPUS-supplied USB cable should be used to connect the equipment to USB enabled personal computers (PC).

Any unauthorized changes or modifications to this equipment would void the user's authority to operate it.

## For customers in North and South America

### ■ For customers in USA

#### Declaration of Conformity

**Model Number:** WS-823/WS-822/WS-821

**Trade Name:** DIGITAL VOICE RECORDER

**Responsible Party:** OLYMPUS IMAGING AMERICA INC.

**Address:** 3500 Corporate Parkway, P.O. Box 610, Center Valley, PA 18034-0610, U.S.A.

**Telephone Number:** 484-896-5000

#### Tested To Comply With FCC Standards

##### FOR HOME OR OFFICE USE

This device complies with Part 15 of the FCC rules. Operation is subject to the following two conditions:

- (1) This device may not cause harmful interference.
- (2) This device must accept any interference received, including interference that may cause undesired operation.

### ■ For customers in CANADA

CAN ICES-3 (B) / NMB-3 (B)

# OLYMPUS®

---

## OLYMPUS IMAGING CORP.

2951 Ishikawa-machi, Hachioji-shi, Tokyo 192-8507, Japan.

## OLYMPUS IMAGING AMERICA INC.

3500 Corporate Parkway, P.O. Box 610, Center Valley, PA 18034-0610, U.S.A.  
Tel. 484-896-5000

### Technical Support (USA):

24/7 online automated help:  
[http://www.olympusamerica.com/  
support](http://www.olympusamerica.com/support)  
Phone customer support:  
Tel.: 1-888-553-4448 (Toll-free)

Our phone customer support is available  
from 9 am to 9 pm (Monday to Friday) ET  
[http://www.olympusamerica.com/  
contactus](http://www.olympusamerica.com/contactus)  
Olympus software updates can be  
obtained at:  
<http://www.olympusamerica.com/digital>

## Free Manuals Download Website

<http://myh66.com>

<http://usermanuals.us>

<http://www.somanuals.com>

<http://www.4manuals.cc>

<http://www.manual-lib.com>

<http://www.404manual.com>

<http://www.luxmanual.com>

<http://aubethermostatmanual.com>

Golf course search by state

<http://golfingnear.com>

Email search by domain

<http://emailbydomain.com>

Auto manuals search

<http://auto.somanuals.com>

TV manuals search

<http://tv.somanuals.com>