

USER'S MANUAL

Digital Audio Player

MR-F30 Series

OLYMPUS

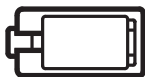

m:robe

Introduction

Thank you for purchasing the Olympus Digital Audio Player MR-F30 Series.

- The product information this USER'S MANUAL conveys is subject to change without notice. Contact an authorized Olympus service center with the product name and model number for the latest information.
- While every care has been taken in the preparation of this USER'S MANUAL, if you find any errors, omissions, or points which are unclear, please contact an authorized Olympus service center.
- The contents of this USER'S MANUAL may not be reproduced in whole or in part except for personal use. It may not be transferred without permission.
- Olympus accepts no responsibility for losses suffered by the customer or a third party as a result of improper use of this product.
- Olympus accepts no responsibility for any damage due to a loss of data resulting from malfunction of this product, repair by a third party not authorized by Olympus, or other reason.
- Illustrations in this USER'S MANUAL may not be the same as the actual product.

Trademarks/Fonts

- m:robe is a trademark of OLYMPUS CORPORATION.
- Windows is a registered trademark of Microsoft Corporation.
- All other company and product names are registered trademarks and/or trademarks of their respective owners.
- The screen fonts used by this product belong to Ricoh Corporation.
- “SRS,” “TruBass,” “WOW” and “**SRS (●)**” are trademarks or registered trademarks of SRS Labs, Inc. The technology of Trubass and WOW is incorporated under license from SRS Labs, Inc.
- MPEG Layer-3 audio coding technology is licensed from Fraunhofer IIS and Thomson Multimedia.

Copyright and copyright protection feature (DRM)

By the Copyright Act, any music files and music CDs downloaded from the Internet without the copyright holder's permission are not allowed to be reproduced, distributed, publicized/re-publicized on the Internet, or converted into MP3 or WMA files for the purpose of commercial business or sale.

A WMA file may be provided with DRM (Digital Right Management) for copyright protection. DRM limits the file to copy or distribute music files that are converted (ripped) from a music CD or downloaded from music distribution services.

About sample tracks incorporated into this product

The copyrights of the sample tracks are owned by the artists or their suppliers.

These sample materials must not be reproduced or used for profit and must not be transferred or resold to third parties.

Failure to comply with these limitations may result in penalties for infringement of copyrights.

Olympus accepts no responsibility in cases where these copyrights are violated.

Note about loosing data

Data stored in memory could be damaged or lost by operational mistakes, malfunctions, or repairs, etc. Be sure to back up your data, for example, on the hard disk of your PC. Olympus will not compensate for any loss or damage of data.

Main features

- With the 512 MB^{*1}/1 GB^{*2} built-in flash memory, you can transfer and store approximately 120^{*1}*/240^{*2}*/3 music tracks to enjoy anytime, anywhere.
- The organic EL display provides a clearer screen than existing LCD displays.
- You can play not only MP3 files but also WMA and OGG files.
- JPEG files can be viewed (Photo Viewer).
- Improved stereoscopic 3D surround and bass sounds provide deep and sonorous tones (SRS function).
- You can adjust the alarm and make FM recording reservations with the clock function.
- Playback can be started from the desired point within a file even if the playback time of the file is long (Bookmark).
- The adjustable pivoting display is convenient and versatile (LCD Pivot).
- A microphone is built-in for you to make your own recordings.
- Contents of CDs and cassette tapes, etc., can also be recorded (Direct Encoding).
- You can listen to and record FM radio programs.

*¹ MR-F32

*² MR-F33

*³ For typical 4-minute tracks recorded at 128 kbps in WMA format

● Table of contents

Introduction	2
Main features	5
Table of contents.	6

Read this first

Safety Precautions	9
Controls: location and function	16

Getting Started

Setting up your m:robe	18
Charging battery (using the USB cable).	18
Transferring music/photos to your m:robe	20
Disconnecting your m:robe from your PC	22
Connecting the earphones to your m:robe	23

Basic operations

Turning the power of your m:robe on/off.	24
Mode selection	25
Searching for a file	27
Deleting files	28
Basic operation of the menu	29
Using the HOLD switch	31

Listening to music

About the playback screen	32
Playing back music.	33

Using the playlist	34
Registering to the playlist	34
Playing back the playlist	35
Setting playback mode.	36
Selecting playback mode.	36
Setting StudyMode	38
Setting interval repeat (A-B)	39
Setting EQ/WOW	40
Selecting EQ	40
Setting WOW	41
Bookmarking music.	42
Deleting the registered information.	43

Recording

About the music recording screen	44
Recording voice.	45
Recording over Line-in connection.	47

Listening to FM radio

About the radio receiver screen.	50
Receiving a radio station	51
Changing the receiving mode	51
Setting frequencies	52
Storing frequencies	54
Deleting the stored frequency	56
Recording an FM radio program	57
FM recording reservation	58

Viewing photos

Displaying photos	60
Viewing images during music playback	61
Setting Avatar	62
Viewing images in Slide Show	63

Setting and adjusting

Setting your m:robe	64
-------------------------------	----



Additional information

Cleaning	69
Notes when you dispose of your m:robe	70
Troubleshooting	73
Rebooting your m:robe	75
Service and maintenance	76
Specifications	77
Menu list	79
Index	82
Before you contact us	85

Safety Precautions

Before using this product, read this first to ensure that you know how to operate it safely and correctly.

Various symbols are used to warn of hazards to yourself and others and prevent damage to property through misuse of this product. The symbols and their meanings are explained below.

 Danger	This symbol indicates that failure to observe the instructions will likely result in serious injury or possibly even death.
 Warning	This symbol indicates that failure to observe the instructions may result in serious injury or possibly even death.
 Caution	This symbol indicates that failure to observe the instructions may result in injury or damage to property.

Precautions when handling this product

Warning

- **Do not use in a place where there is running water.** Doing so may cause electric shock, fire, over heating or explosion. Take extra caution when using this product in rain, snow, at the seaside or a waterfront. Also, do not use in a bathroom or shower room.
- **Do not use or leave this product near a stove or fire.** Doing so may cause over heating, explosion or fire. Be especially careful during charging. Also, if the AC cord cover is damaged, fire or electric shock may result.

- **Do not use in the presence of flammable or explosive gas.** Do not use this product if there is the possibility of the presence of such gases in the air. Failure to do so could result in fire or explosion.
- **Keep out of the reach of children.** Do not let children use this product without adult supervision.
- **Avoid prolonged contact with the device while applying current.** The device becomes hot during charging. Prolonged contact with the device during use could result in minor burns.
- **Do not use or store this product for a long time in an environment where there is a lot of dust, dampness, oily smoke or steam.** This could result in fire or electric shock.
- **Stop using this product immediately when thunder has occurred.** Failure to do so may cause electric shock. Refrain from using.
- **Do not use while driving.** Doing so may cause injury or accident. Never watch the on screen display while driving.
- **Do not let any water or other foreign object get inside the device.** Should the device be dropped in water, or water gets into the internal parts, fire or electric shock may result. Turn the power off immediately and contact an authorized Olympus service center.
- **Should you notice an unusual smell, over heating, discoloration, distortion or smoke, stop using this product immediately.** Leaving as it is may cause fire, electric shock or burns. Contact an authorized Olympus service center.
- **Should you notice leakage or an unusual smell, keep this product away from fire.** Failure to do so may cause explosion or fire.
- **Do not attempt to disassemble or modify this product.** Such action could lead to electric shock or injury by high-voltage parts inside.



 **Caution**

- **Do not leave this product in places of high temperature, such as in a sun-heated car.** Doing so could result in battery leakage, deterioration of parts or fire.
- **Do not touch any leakage that has occurred.** Battery leakage, etc., may have occurred. Getting the liquid into your eyes or touching it may cause injury. In such a case, wash immediately with clean water and seek medical attention immediately.

Conditions for use of this product

- This product contains precision electronic parts. Avoid using or leaving this product for long periods of time in the following places as this could result in failure or malfunction.
 - places of high temperature and high humidity or where the temperature and humidity fluctuate greatly, such as in direct sunlight, on the beach in summer, in a car with the windows closed, or next to air conditioning equipment or a humidifier
 - places where there is a lot of sand, dust or dirt
 - near fire
 - near water
- Avoid dropping or hitting this product or subjecting it to severe vibration or impact.
- If the device is subjected to a sudden temperature change, for example by bringing it from a cold place into a warm room, condensation may form on the inside. Wait until the device is adjusted to the room temperature before using.
- Do not turn up the volume excessively. Loud sounds can cause hearing loss or injury.

About the organic EL display (OLED)

The latest high precision technology has gone into the making of the organic EL display of this product, but there are some pixels which are permanently lit or which do not light at all. Also, depending on the angle at which the screen is viewed, the colors and brightness may appear uneven. This is due to the structure of the organic EL display and is not a malfunction.

Information regarding the built-in battery

The built-in battery is exclusively for use with m:robe MR-F30 Series. Never use it in other equipment.

- **Discharging**

The built-in battery self-discharges while it is not in use. Be sure to charge it regularly before use. We recommend charging the built-in battery once every 6 months to maintain its performance if it is not to be used for an extended period of time.

- **Life of the built-in battery**

- The built-in battery is good for about 500 complete charges and discharges, depending on usage.
- The life of the built-in battery is limited. The built-in battery's charge becomes shorter after repeated use. If the built-in battery discharges soon after charging, it may be time to replace it. Please contact an authorized Olympus service center for assistance.

- **Operating temperature**

Built-in batteries are chemical products. The built-in battery's efficiency may vary, even when operating within the recommended temperature range, but this is not a malfunction.

- Recommended temperature: 5 °C to 35°C (during charging)

Using this product outside the above temperature range may result in reduced efficiency and shorter battery life.

- **Disposal**

This product has a built-in lithium polymer battery. Lithium polymer batteries are recyclable.









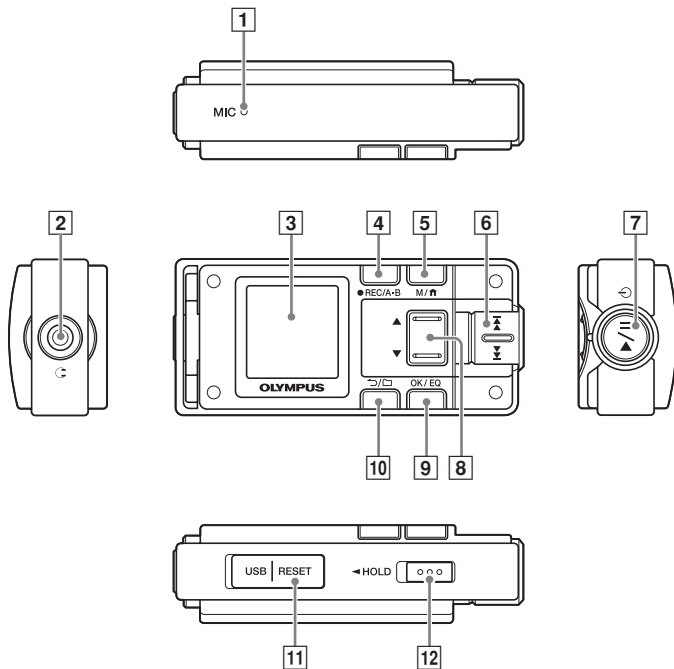

When you dispose of this product, return the built-in battery to a recycling location. For details on removing the built-in battery, refer to “Notes when you dispose of your m:robe” (👉 page 70).

Never disassemble this product except when disposing of it.

● Controls: location and function

Read this first



- 1** Microphone
- 2** Earphones jack
- 3** Organic EL display
- 4** ●REC/A•B button
Voice recording/music recording/FM radio recording
During playback: playing back repeatedly between A and B
- 5** M/  button
Displaying menu screen/mode select screen
Initializing StopWatch
- 6**   dial
During playback: Selecting the previous/next file
During Navigation search*: Searching for files in a folder
During FM receiving: Searching for frequencies
During menu operation*: Selecting the desired item
- 7**   button
Power on/off
Playing/pausing file
Pausing recording/StopWatch
- 8** ▲/▼ button
Volume adjusting
During Navigation search*: Searching for files in a folder
During menu operation*: Selecting the desired item
- 9** OK/EQ button
Changing playback mode
During music playback: Changing EQ/Bookmarking
During menu operation: Selecting/Entering setting item
- 10**   button
Starting/Canceling Navigation search
- 11** USB port/RESET button
- 12** HOLD switch
Locking buttons to prevent unintentional operation
- * You can use **8** ▲/▼ button instead of **6**   dial. In this USER'S MANUAL, the   dial is used.

● Setting up your m:robe

Operating system requirements

One of the following operating systems is required for m:robe operation:

- Windows 98SE*, Windows Me, Windows 2000 Professional, Windows XP Professional/Home Edition
 - Mac OS 9.x/X v10.x
- * The USB driver should be installed.

Charging battery (using the USB cable)

Connect the USB cable to your PC and your m:robe.
Charging starts.

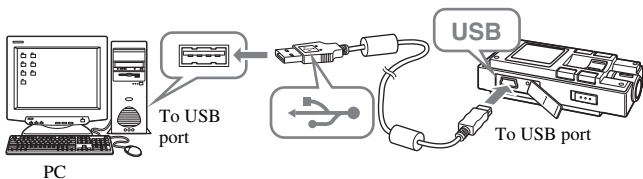

The following screen appears after charging completes.



After charging, perform the disconnect procedure. When the following screen appears, disconnect your m:robe from your PC.

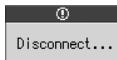

For details, refer to “Disconnecting your m:robe from your PC” (👉 page 22).

About the battery power indication

▣▣▣▣: Battery is fully charged.

▣▣▣/▣▣▣: Battery power is reduced.

▣: Battery power is exhausted. Charge the battery.

The following cases indicate the battery power is exhausted or nearly exhausted. Charge the battery.

- “Low Battery” appears on the screen.
- Your m:robe suddenly stops working, or does not work at all.
- The display does not light up even though you operate your m:robe.

Tips

- The battery is fully charged after approximately 3 hours.
- You can charge the battery while transferring files from your PC.

● Transferring music/photos to your m:robe

1 Connect the USB cable to your PC and your m:robe.

Your PC recognizes your m:robe as a removable disk.

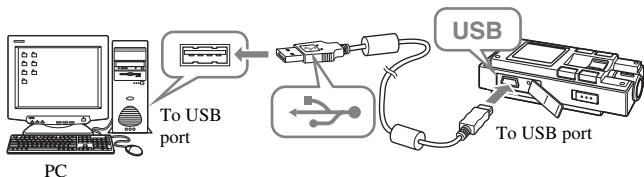

2 Transfer files from your PC to your m:robe.

Drag and drop the desired file to m:robe on the screen display of your PC.

File formats supported by m:robe

Music file

- WMA (including VBR)
- MP3 (including VBR)
- OGG

Image file

- JPEG



Notes

- Do not add, correct or delete, on your PC, the CONFIG folder and its files in your m:robe and change the name of folders or files. If you do, it may cause your m:robe to malfunction.
- Use the dedicated applications provided by music distributors (contents provider) when you transfer files under DRM protection.
- When you connect your m:robe to a USB hub or a USB port on the keyboard etc., m:robe may not be recognized. In this case, connect your m:robe directly to the USB port on your PC body.

Disconnecting your m:robe from your PC

For Windows Me/2000/XP users:

- 1 Click [Remove the hardware] icon on the system tray.
- 2 Click the displayed message.
- 3 [The USB storage device can now be safely removed from the system, remove the USB cable from computer.] appears. Click [OK].

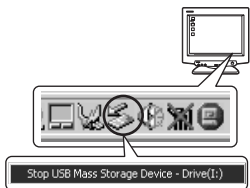

For Windows 98SE users:

- 1 Double-click [My Computer] icon, then right-click [Removable Disk] to open a pop-up menu.
- 2 Click [Eject] on the menu.

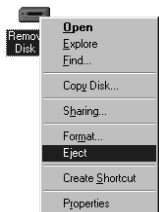

For Macintosh users:

Drag and drop [NO_NAME] icon to [trash box].
The icon to indicate the connection of your PC and m:robe disappears, and your m:robe is disconnected from your PC.



● Connecting the earphones to your m:robe

Connect the supplied earphones to your m:robe.

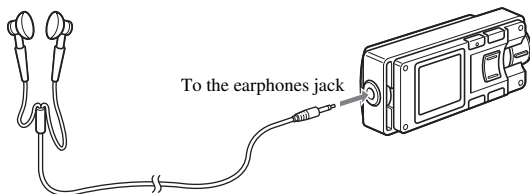

Notes

- Set the volume level to minimum before wearing earphones to avoid hurting your ears. For details on adjusting volume, refer to “To control volume” (👉 page 33).
- Do not raise the volume excessively. Loud sounds can cause hearing loss or damage.

Turning the power of your m:robe on/off

Turning on your m:robe

Press and hold the ►/|| button.

The power is turned on.

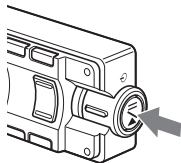

To turn off the power

Press and hold the ►/|| button.

⚠ Notes

- Before turning on your m:robe, make sure the HOLD switch is set to off. When the HOLD function is on (🔒 page 31), even if you press and hold the ►/|| button, “🔒” appears, and the power will not be turned on.
- Charge the battery before turning on your m:robe. If “Low Battery” appears or the display does not light up, charge the battery (🔌 page 18).

📄 Tip

“Auto PWR Off” or “Sleep Mode” can be set (🔧 page 67).

● Mode selection

There are 5 modes, and available functions and setting items differ depending on the selected mode.

1 Press and hold the M/🏠 button.

The mode select screen appears.

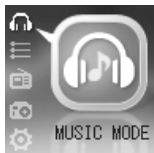

2 Push up/down the ◀◀/▶▶ dial to select the desired mode.

The mode changes in the following order: "MUSIC MODE" ↔ "PLAYLIST" ↔ "FM MODE" ↔ "PHOTO MODE" ↔ "SETTINGS" ↔ "MUSIC MODE."



3 Press the OK/EQ button.

The desired mode screen appears.



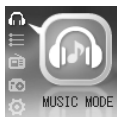

MUSIC MODE

Selecting playback mode/music playback/setting sound quality (👉 page 32)

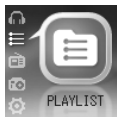

PLAYLIST

Playing back the desired track in the playlist easily (👉 page 34)



FM MODE

Receiving/recording radio program (👉 page 50)

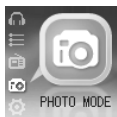
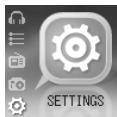

PHOTO MODE

Viewing photos/setting the display mode (👉 page 60)



SETTINGS

Setting the screen display/system/watch etc. (👉 page 64)

● Searching for a file

– Navigation search

- 1 Press the  button while the playback screen is displayed.

The Navigation search screen appears.

- 2 Push up/down the  dial to select the desired folder, then press the OK/EQ button.

You can go to the next sublevel of folder hierarchy.

- 3 Repeat step 2 to select the desired file, then press the  button.

Playback starts.

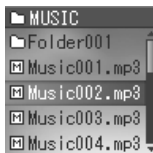

To go back to the previous level folder: Press the  button.





To finish Navigation search

Press and hold the  button.

Tips

- After selecting the desired music file in Navigation search, press and hold the OK/EQ button to register the file to the playlist. Press and hold the OK/EQ button to cancel.
- You can play back the created playlist in Navigation search or the PLAYLIST mode ( page 35).

Deleting files

- 1** Press the  button while the playback/receiving screen is displayed.
The Navigation search screen appears.
- 2** Push up/down the  dial to select the desired folder, then press the OK/EQ button.
- 3** Repeat step 2 to select a file you want to delete, then press the  button.
The editing menu appears.
- 4** Push up/down the  dial to select “Delete,” then press the OK/EQ button.
The selected file is deleted.

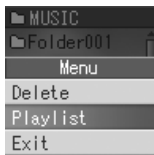

Basic operation of the menu

The items you can operate in the menu differ depending on the selected mode. For details on each menu item, refer to the “Menu list” (👉 page 79).

1 Select the desired mode.

For details, refer to “Mode selection” (👉 page 25).

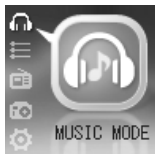

2 Press the M/🏠 button.

The main menu screen appears.



3 Push up/down the ⏪/⏩ dial to select a setting category, then press the OK/EQ button.

The sub menu screen appears.

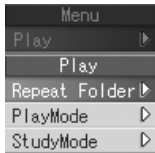

- 4** Push up/down the ◀◀/▶▶ dial to select the desired item, then press the OK/EQ button.

The setting menu screen appears.

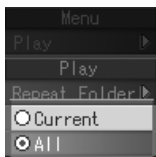

- 5** Push up/down the ◀◀/▶▶ dial to select the desired setting, then press the OK/EQ button.

To go back to the previous level screen: Press the ↶/📁 button.

 **Note**

After selecting the desired setting in step 5, press the OK/EQ button. If you go back to the previous level screen without doing so, your selection will not be set.

● Using the HOLD switch

– HOLD function

This is used to prevent unintentional operation when carrying your m:robe in a pocket or a bag.

Slide the HOLD switch in the direction of the arrow on your m:robe.

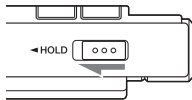

When the HOLD function is on, “” appears on the screen, and the buttons become inactive.

To set HOLD to off

Slide the HOLD switch in the reverse direction of the arrow.

About the playback screen

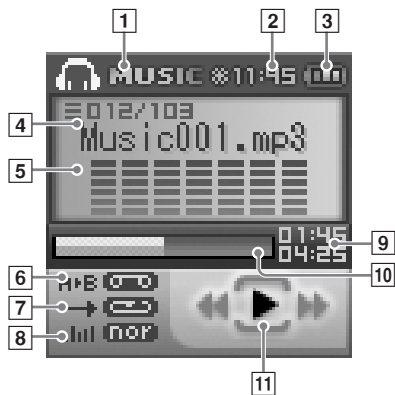





MUSIC MODE

- 1 Mode indication (MUSIC)
- 2 Time indication
- 3 Remaining battery power indication
- 4 Current play file number/Total number of playback files indication
- 5 Track name indication
- 6 Repeat play between A and B indication
- 7 Play mode indication
- 8 EQ indication
- 9 Elapsed time of track/Total playback time of track indication (⏮ page 65)
- 10 File progress indication
- 11 Playback condition indication (play/pause/fast-forward/fast-rewind)

Playing back music

To select the desired music file

Press the / button while the playback screen is displayed, then push up/down the  dial to select the desired music file ( page 27).

To play/pause music

Press the /|| button.

To control volume

Press the / button.

To search for the desired music file (Skip)

Push up/down the  dial to skip to the previous/next music file.

To search for the desired point of the music file (Search)

Push up/down and hold the  dial while playing back, then release your hold at the desired point.



Tip

The Skip function is available only when “StudyMode” is set to “Off” ( page 38).



Using the playlist

The desired track should be registered to the playlist before playback.

Registering to the playlist

- 1** Press the  button while the playback screen is displayed.

The Navigation search screen appears.

- 2** Push up/down the  dial to select a music file you want to register, then press the M/ button.

The editing menu appears.

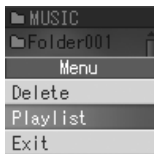

- 3** Push up/down the  dial to select “Playlist,” then press the OK/EQ button.

The file icon is changed from  to , then the file is added to the playlist.



To finish the editing menu

Select “Exit” in step 3, then press the OK/EQ button.

Tip



You can also register a music file to the playlist in the following way: select the desired music file in step 2, then press and hold the OK/EQ button.

Playing back the playlist

- 1** Press and hold the **M/↑** button while the playback screen is displayed.
The mode select screen appears.
- 2** Push up/down the **◀◀/▶▶** dial to select “PLAYLIST A screenshot of a device's playback screen. At the top, it says 'PLAYLIST *11:45'. Below that, it shows '012/103' and 'Music001.mp3'. There is a progress bar with '01:45' and '04:25' markers. At the bottom, there are playback controls: 'RMS COMP', a right arrow, a list icon, and a play/pause button.



To delete files in the playlist

Select a file you want to delete in step 3, then press the **OK/EQ** button. The icon of the selected file is changed from  to . Press the **OK/EQ** button again to cancel.

Setting playback mode

Selecting playback mode

Press the OK/EQ button in playback stop mode.

Playback mode changes in the following order: “Normal”→ “Intro”→ “Repeat”→ “Repeat All”→ “Random”→ “Random All”→ “Normal.”

 (Normal): Music files are played back in sequence.

 (Intro): Only the beginning part (10 sec) of the music is played back.

 (Repeat): The specified music file is played back repeatedly.

 (Repeat All): All the music files are played back repeatedly.

 (Random): Music files are played back in random order once.





 (Random All): Music files are played back repeatedly in random order.

Tips

- You can also select the desired playback mode in the following way: press the **M/⏮** button while the playback screen is displayed, then select “Play”→ “PlayMode”→ the desired playback mode.
- In playback mode, the files of the folder selected in “Repeat Folder” are played back ( page 37).

Setting Repeat Folder

You can select to play back the music files in just the current folder or in all folders.

- 1** Press the M/  button while the playback screen is displayed.
- 2** Push up/down the  dial to select “Play,” then press the OK/EQ button.
- 3** Push up/down the  dial to select “Repeat Folder,” then press the OK/EQ button.
The setting menu screen appears.
“Current”: Music files in the current folder are played back.
“All”: Music files in all the folders are played back.
- 4** Push up/down the  dial to select the desired setting, then press the OK/EQ button.

Setting StudyMode

You can fast-rewind/fast-forward and resume the currently playing file by pushing up/down the **⏮/⏭** dial.

- 1** Press the **M/⬆** button while the playback screen is displayed.
- 2** Push up/down the **⏮/⏭** dial to select “Play,” then press the OK/EQ button.
- 3** Push up/down the **⏮/⏭** dial to select “StudyMode,” then press the OK/EQ button.
- 4** Push up/down the **⏮/⏭** dial to select “On/Off,” then press the OK/EQ button.
- 5** Push up/down the **⏮/⏭** dial to select “On,” then press the OK/EQ button.
- 6** Push up/down the **⏮/⏭** dial to select “Step,” then press the OK/EQ button.
- 7** Push up/down the **⏮/⏭** dial to select the desired time (2sec/5sec/15sec/30sec/60sec), then press the OK/EQ button.

To cancel StudyMode

Select “Off” in step 5, then press the OK/EQ button.

Setting interval repeat (A-B)

A music file is repeated in the set interval.

- 1** Play back a music file, and press the ●REC/A•B button at the point where you want to start interval repeat (Repeat A).
- 2** Press the ●REC/A•B button at the point where interval repeat is finished (Repeat B).
The set interval is played back repeatedly.

To deactivate interval repeat

Press the ●REC/A•B button.



Tips

- If Repeat B (the point where interval repeat is finished) is not set, the set of Repeat A is canceled.
- Repeat B (the point where interval repeat is finished) can be set in 2 seconds after you set Repeat A (the point where interval repeat is started).







● Setting EQ/WOW

Selecting EQ

Press the OK/EQ button during playback.

EQ changes in the following order: “Normal”→ “Rock”→ “Jazz”→ “Classic”→ “Pop”→ “WOW”→ “User EQ1”→ “User EQ2”→ “Normal.”

Adjusting User EQ

- 1 Press the M/  button while the playback screen is displayed.
- 2 Push up/down the /  dial to select “EQ,” then press the OK/EQ button.
- 3 Push up/down the /  dial to select “User EQ1” or “User EQ2,” then press the OK/EQ button.
- 4 Push up/down the /  dial to adjust the level, then press the OK/EQ button.
- 5 Repeat step 4 to adjust the level of each frequency.

To finish adjusting User EQ

Press the /  button.

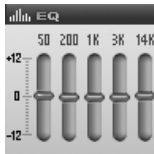

Setting WOW

You can enjoy natural stereophonic music (SRS) and sonorous bass sounds (Trubass).

- 1** Press the **M/⏮** button while the playback screen is displayed.
- 2** Push up/down the **⏮/⏭** dial to select “EQ,” then press the **OK/EQ** button.
- 3** Push up/down the **⏮/⏭** dial to select “WOW,” then press the **OK/EQ** button.
The setting menu screen appears.
“SRS”: Adjusts 3D surround sounds.
“Trubass”: Adjusts bass sounds.
“Adjust”: Sets for Earphone or Speaker.
- 4** Push up/down the **⏮/⏭** dial to select the desired item, then press the **OK/EQ** button.
- 5** Push up/down the **⏮/⏭** dial to select the desired level, then press the **OK/EQ** button.



Notes

- WOW setting may cause playback in loud sounds.
- EQ can be set only in **MUSIC MODE**  or **PLAYLIST** .

● **Bookmarking music**

Press and hold the OK/EQ button during playback of the desired music. A message is displayed, and the music is bookmarked.



Note

A Bookmark cannot be set when a track is not being played.

Playing back bookmarked music



Bookmarked music is playable in MUSIC MODE

- 1** Press and hold the OK/EQ button in playback stop mode.
- 2** Push up/down the dial to select the desired bookmark, then press the button.
Playback starts at the bookmarked point.



Deleting the registered information

You can delete registered bookmarks and playlist.

- 1** Press the **M/↑** button while the playback screen is displayed.
- 2** Push up/down the **⏮/⏭** dial to select “Delete,” then press the **OK/EQ** button.
- 3** Push up/down the **⏮/⏭** dial to select “Bookmark” or “Playlist,” then press the **OK/EQ** button.
The registered files are displayed.
- 4** Push up/down the **⏮/⏭** dial to select a file you want to delete, then press the **OK/EQ** button.
The icon of the selected file is changed from  or  to . To cancel, press the **OK/EQ** button again.



Note

Only the information of the bookmark or playlist is deleted, but the original file is not deleted.

About the music recording screen

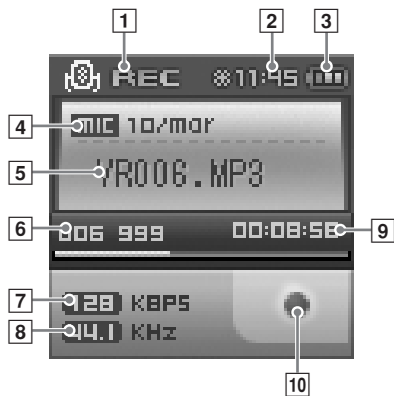

Recording mode

- 1 Mode indication (REC)
- 2 Time indication
- 3 Remaining battery power indication
- 4 Recording type indication (MIC/ LINE)
- 5 File name indication
- 6 Total number of recorded files/Total number of recordable files (999) indication
- 7 Bit rate indication
- 8 Sampling frequency indication
- 9 Recording progress time indication
- 10 Recording condition indication (in recording/recording pause)

● Recording voice

- 1** Press the M/⏏ button while the playback screen is displayed.
- 2** Push up/down the ◀◀/▶▶ dial to select “REC Source,” then press the OK/EQ button.
- 3** Push up/down the ◀◀/▶▶ dial to select “MIC In,” then press the OK/EQ button.
- 4** Press and hold the ●REC/A•B button in playback stop mode.
Recording starts.

To pause/resume recording

Press the ▶/|| button.

To stop recording

Press the ●REC/A•B button.

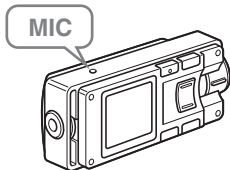

Listening to recorded voice files

While the playback screen is displayed, press the button to display the Navigation search screen, select “RECORD”→“VOICE”→ the desired voice file, then press the button.

Setting the sound quality

Press the button while the playback screen is displayed, then select “REC Quality”→ “Voice”→ the desired bit rate.

Deleting recorded voice files

Refer to “Deleting files” (page 28).

Notes

- If the memory is full, recording stops automatically, and the file is saved up to the point where recording stopped.
- The recording sound sensitivity depends on the distance to the sound source.
- You cannot record correctly if the battery power is not enough.

Tips

- You can listen to what you are recording with the earphones.
- The higher bit rate you set, the higher music quality will be provided, but the size is larger.
- The recorded files are named automatically, such as VR001.MP3, VR002.MP3..., and stored in the VOICE folder in MP3 format.

● Recording over Line-in connection

- 1 Connect the line-in cable to your m:robe and the external audio device.

To the audio (Line-out) jack of
an external audio device

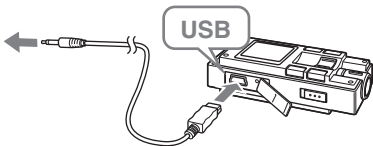

- 2 Press the **M/⏏** button while the playback screen is displayed.
- 3 Push up/down the **⏮/⏭** dial to select “REC Source,” then press the OK/EQ button.
- 4 Push up/down the **⏮/⏭** dial to select “Line In,” then press the OK/EQ button.
- 5 In playback stop mode, play the external audio device, then press and hold the **●REC/A•B** button.
Recording starts.

To pause/resume recording

Press the **▶/||** button.

To stop recording

Press the **●REC/A•B** button.

Listening to recorded files

While the playback screen is displayed, press the button to display the Navigation search screen, select “RECORD”→“LINE-IN”→the desired file, then press the button.

Setting the sound quality

Press the button while the playback screen is displayed, then select “REC Quality”→“Line In”→the desired bit rate.

Deleting recorded files

Refer to “Deleting files” (page 28).

Notes





- If the memory is full, recording stops automatically, and the file is saved up to the point where recording stopped.
- You cannot record correctly if the battery power is not enough.

Tips

- You can listen to what you are recording with the earphones.
- The higher bit rate you set, the higher music quality will be provided, but the size is larger.
- The recorded files are named automatically, such as AD001.MP3, AD002.MP3..., and stored in the LINE-IN folder in MP3 format.

Setting Auto Sync

When music is recorded, a new file is created at where no sound is recorded.

- 1** Press the M/  button while the playback screen is displayed.
- 2** Push up/down the  dial to select “REC Quality,” then press the OK/EQ button.
- 3** Push up/down the  dial to select “Auto Sync,” then press the OK/EQ button.
- 4** Push up/down the  dial to select “On,” then press the OK/EQ button.
“On”: Creates music files track by track.
“Off”: Creates one music file including all tracks.

To cancel Auto Sync

Select “Off” in step 4, then press the OK/EQ button.

About the radio receiver screen

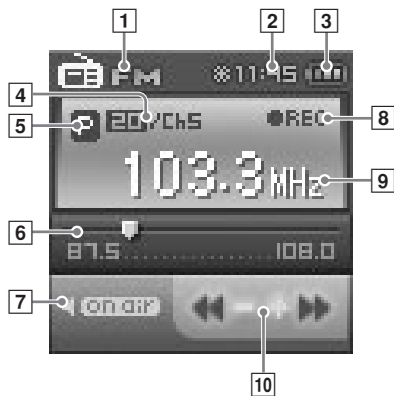



FM MODE

- 1 Mode indication (FM)
- 2 Time indication
- 3 Remaining battery power indication
- 4 Total number of stored frequencies/
Current selected preset number
indication
- 5 Preset (P)/Manual (M) mode indication
- 6 Frequency range indication
- 7 On air (On Air)/Mute (Mute)
indication
- 8 FM recording indication
- 9 Frequency indication
- 10 Direction of frequency search
indication

Receiving a radio station

- 1** Press and hold the M/ button.

The mode select screen appears.

- 2** Push up/down the /  dial to select “FM MODE ,” then press the OK/EQ button.





The FM receiving screen appears.

To mute the FM broadcast

Press the /  button.

Changing the receiving mode

You can switch from Manual mode to Preset mode and vice versa. Manual mode allows you to receive all available frequencies, and Preset mode allows you to search only your stored frequencies.

- 1** Press the M/ button while the receiving screen is displayed.
- 2** Push up/down the /  dial to select “Change Mode,” then press the OK/EQ button.
- 3** Push up/down the /  dial to select “Preset” or “Manual,” then press the OK/EQ button.

The receiving mode is changed.

Setting frequencies

Setting in Manual mode

Push up/down the **◀◀/▶▶** dial.

Frequencies are searched at the set intervals.

Push up/down and hold the **◀◀/▶▶** dial.

Searching stops when a receivable frequency is found.

Setting in Preset mode

Push up/down the **◀◀/▶▶** dial to search the registered channel.



Note

Only stored frequencies are received. For details on storing frequencies, refer to “Storing frequencies”

( page 54).

Setting the area

The FM radio frequency bands differ depending on the country or region.

- 1** Press the **M/↑** button while the receiving screen is displayed.
The FM menu screen appears.
- 2** Push up/down the **◀◀/▶▶** dial to select “Region,” then press the **OK/EQ** button.
- 3** Push up/down the **◀◀/▶▶** dial to select the desired area, “Korea,” “Japan” or “World,” then press the **OK/EQ** button.
 - “Korea”: Searches frequency every 0.1 MHz from 87.0 to 108.0 MHz.
 - “Japan”: Searches frequency every 0.05 MHz from 76.0 to 108.0 MHz.
 - “World”: Searches frequency every 0.05 MHz from 87.0 to 108.0 MHz.

Storing frequencies

Storing frequencies manually

- 1 Receive the desired frequency, then press the **M/↑** button.
- 2 Push up/down the **◀◀/▶▶** dial to select “Save Preset,” then press the **OK/EQ** button.
- 3 Push up/down the **◀◀/▶▶** dial to select the registry number (P1 to P20), then press the **OK/EQ** button.

The frequency is stored.



Tip

When “Change Mode” is set to “Manual,” the current frequency can be stored by pressing the **OK/EQ** button while receiving FM radio.

Storing frequencies automatically

- 1 Press the **M/↑** button while the receiving screen is displayed.
- 2 Push up/down the **◀◀/▶▶** dial to select “Auto Preset,” then press the **OK/EQ** button.
- 3 Push up/down the **◀◀/▶▶** dial to select “On,” then press the **OK/EQ** button.

The receivable frequency is stored automatically.



Note

If “Auto Preset” is set to “On,” frequency information previously registered will be deleted.



Tips

- While storing frequencies automatically, press the OK/EQ button to interrupt frequency searching.
- The mode is changed to preset mode when storing frequency is done.
- When you store a frequency automatically, be sure to connect the supplied earphones. The earphones cord works as an antenna.

Deleting the stored frequency

- 1** Press the M/⬆ button while the receiving screen is displayed.
- 2** Push up/down the ◀◀/▶▶ dial to select “Preset Delete,” then press the OK/EQ button.
- 3** Push up/down the ◀◀/▶▶ dial to select “Each,” then press the OK/EQ button.
- 4** Push up/down the ◀◀/▶▶ dial to select the registry number of frequency you want to delete, then press the OK/EQ button.

To delete all the stored frequencies

Select “All” in step 3, then press the OK/EQ button.

Recording an FM radio program

Receive the desired frequency, then press and hold the ●REC/A•B button.

To pause/resume recording

Press the ►/|| button.

To stop recording

Press the ●REC/A•B button.

Listening to recorded FM files

While the receiving screen is displayed, press the ↶/☐ button to display the Navigation search screen, select “RECORD”→“FM”→the desired FM file, then press the ►/|| button.

Setting the sound quality

Press the M/🏠 button while the receiving screen is displayed, then select “FM Recording”→“Quality”→the desired bit rate.

Deleting recorded FM files

Refer to “Deleting files” (👉 page 28).



Tips

- The higher bit rate you set, the higher music quality will be provided, but the size is larger.
- The recorded files are named automatically, such as FM001.MP3, FM002.MP3..., and stored in the FM folder in MP3 format.

● FM recording reservation

Set the desired time and frequency for the FM radio recording reservation.

- 1 Press the M/↑ button while the receiving screen is displayed.
- 2 Push up/down the ◀▶ dial to select “FM Recording,” then press the OK/EQ button.
- 3 Push up/down the ◀▶ dial to select “REC Booking,” then press the OK/EQ button.
- 4 Push up/down the ◀▶ dial to select “Setting,” then press the OK/EQ button.
The recording settings screen appears.
- 5 Push up/down the ◀▶ dial to select the desired setting, then press the OK/EQ button.
- 6 Repeat step 5 to set the recording start/stop time and frequencies.
- 7 After pressing the ↶/□ button, push up/down the ◀▶ dial to select “On/Off,” then press the OK/EQ button.
- 8 Push up/down the ◀▶ dial to select “On,” then press the OK/EQ button.

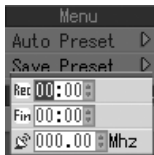

To cancel a recording reservation

Select “Off” in step 8, then press the OK/EQ button.



Note

The reservation setting is canceled after recording completes.

● Displaying photos

- 1** Press and hold the M/🏠 button.

The mode select screen appears.

- 2** Push up/down the ◀▶ dial to select “PHOTO MODE 📷,” then press the OK/EQ button.

The selecting photo screen appears.



- 3** Push up/down the ◀▶ dial to select the desired photo file, then press the OK/EQ button.

To view the previous/next photo: Push up/down the ◀▶ dial.

To view the photo information: Press the M/🏠 button.

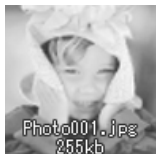





To finish displaying photos

Press the ⏪/📁 button.

Deleting photos

Select the photo you want to delete in step 3, then press the M/🏠 button. Push up/down the ◀▶ dial to select “Delete,” then press the OK/EQ button.

Viewing images during music playback

- 1** Press the M/ button while the selecting photo screen is displayed.
- 2** Push up/down the  dial to select “Real Photo,” then press the OK/EQ button.
- 3** Push up/down the  dial to select “On/Off,” then press the OK/EQ button.
- 4** Push up/down the  dial to select “On,” then press the OK/EQ button.

If you play back a music file, the set photos will be displayed.

To deactivate Real Photo

Select “Off” in step 4, then press the OK/EQ button.

Setting the photo display interval

Select “Interval” in step 3, then select the desired setting (2sec/5sec/10sec).

Setting the photo display mode

Select “Type” in step 3, then select the display mode (Normal/Repeat All/Random/Random All).

● Setting Avatar

The desired photo can be displayed on the m:robe start up screen.

- 1** Press the M/⬆ button while the selecting photo screen is displayed.
- 2** Push up/down the ◀◀/▶▶ dial to select “Avatar,” then press the OK/EQ button.
- 3** Push up/down the ◀◀/▶▶ dial to select “On,” then press the OK/EQ button.







To cancel avatar

Select “Off” in step 3.



⚠ Notes

- Only the files in the AVATAR folder, when you set Avatar to on, are displayed.
- Only JPEG files in less than 96×96 pixels can be displayed.
- Only image files named from avatar00.jpg, avatar01 to avatar16.jpg can be set to Avatar (a maximum of 17 files can be set).

Viewing images in Slide Show



- 1** Press the M/ button while the selecting photo screen is displayed.
- 2** Push up/down the /  dial to select “Slide Show,” then press the OK/EQ button.
- 3** Push up/down the /  dial to select “On/Off,” then press the OK/EQ button.
- 4** Push up/down the /  dial to select “On,” then press the OK/EQ button.

To finish Slide Show

Press the /  button to go back to the selecting photo screen, then press the M/ button to select “Slide Show”→ “On/Off”→ “Off,” and press the OK/EQ button.



Tip

You can go to the previous/next image file by pushing up/down the /  dial in Slide Show regardless of the set playing interval.

To set the photo display interval



Select “Interval” in step 3, then select the desired setting (2sec/5sec/10sec).

● Setting your m:robe

You can customize and adjust system setting, screen display, timer, watch, and operating system.

1 Press and hold the M/ button.

The mode select screen appears.

2 Push up/down the  dial to select “SETTINGS ,” then press the OK/EQ button.

3 Push up/down the  dial to select the desired item, then press the OK/EQ button.

The setting menu screen appears.

4 Push up/down the  dial to select the desired setting, then press the OK/EQ button.

To go back to the previous level screen: Press the  button.

Settings

Set the system functions.

Subjects	Explanations
Resume	When power is turned on, you can resume playback of the last file from the point where it was stopped before power was turned off.
Search Speed	Speed control to search file can be adjusted (×4/×8/×16).
Fade In	You can gradually increase the volume up to the set point.
Time	The time display of music playback can be selected. “Normal”: Displays elapsed playback time. “Remain”: Displays remaining playback time. “Total”: Displays both elapsed time and total playback time.
Language	The following languages can be selected for the menu screen: “한국어,” “ENGLISH,” “日本語,” “简体中文” and “繁體中文.”
Beep Sound	Beep sounds when a button is operated while playing back, searching, etc.
LCD Pivot	The information display can be adjusted depending on the direction of the display. “ON”: Pivots the displayed information 180°. “OFF”: Displays in the ordinary direction.

Display

Set the functions of the screen display.

Subjects	Explanations
Contrast	The screen brightness can be adjusted from “0” to “10.”
Screen Saver	If no button is pressed for a certain time, the screen saver is displayed to protect the screen. “On/Off”: Sets screen saver to on/off and the time that elapses before displaying the screen saver (1min/3min/5min/10min). “Type”: Sets the type of screen saver displayed on the screen. “Vertical”: Screen saver displays in vertical direction. “Horizontal”: Screen saver displays in horizontal direction. “Diagonal”: Screen saver displays in diagonal direction. “On_Off”: Screen saver fades in and out. “Moving”: Screen saver moves about on the screen. “Fade In_Out”: The density of screen saver gradually changes.
Scroll Speed	Scroll Speed of file name can be set from “1” to “5.”
Backlit Time	The light emitting time of organic EL (5sec/15sec/30sec/60sec/120sec) can be set.
Graphic EQ	The type of graphic equalization (Wave/Stereo Image/Pumping/Wave/Watch/File Info) can be selected.
Track Title	The information displayed as a music title (File Name/ID3 TAG) can be set.

Timer

Set the timer functions.

Subjects	Explanations
Auto PWR Off	The power can be set to turn off automatically when no button is pressed for a certain time (1min to 10min) in pause/stop mode.
Sleep Mode	When the set time (10min to 90min) elapses, the power will be turned off automatically.

Watch

Set the watch functions.

Subjects	Explanations
Watch	Watch is displayed, if there is no operation for a certain time. “On/Off”: Displays/hides the watch. “Setting”: Sets year, month, day and time.
Alarm	The alarm is turned on at the set time. “On/Off”: Turns on/off the alarm. “Setting”: Sets time and occurrence of alarm.
StopWatch	Press the ►/ button to start counting. Press the ►/ button again to stop counting. To reset, press the M/⬆ button.

System

Set the OS functions.

Subjects	Explanations
Information	You can view the OS version, memory capacity and available memory.
Reset	You can return all m:robe settings to the factory default status.
Format	You can delete stored files, etc, and format the flash memory.

Cleaning

Exterior

Wipe gently with a soft cloth. If the device is very dirty, wipe it using a cloth dampened with a diluted mild detergent and wrung tightly. If you used the device at the beach, clean it using a cloth dampened with fresh water and wrung tightly.

Organic EL display

Wipe any dust or dirt on the organic EL display gently with a soft cloth.



Note

Do not use strong solvents such as benzene or alcohol, or chemically treated cloths.

● Notes when you dispose of your m:robe

Remove the built-in battery when you dispose of this product. Never disassemble this product except when disposing of it.

Danger

- **Do not allow the +/- terminals of the built-in battery to come in contact with metal objects, or subject the built-in battery to strong shock.** Also, do not carry or store with a necklace or hairclip, etc. This may cause short-circuiting, resulting in overheating, explosion or fire.
- **Do not heat, disassemble or modify the built-in battery, expose it to water, or leave it in scorching heat.** Doing so may cause overheating, explosion or fire.
- **Do not pierce with a nail, beat with a hammer, throw or step on the built-in battery.** Doing so may cause overheating, explosion, fire or battery leakage.
- **Before disposing, tape the connector of the built-in battery with insulating tape.** Otherwise, short-circuiting may occur, and result in overheating explosion or fire.

Warning

- **Keep the built-in battery out of the reach of children.** Failure to do so may cause accident or injury.
- **When battery leakage has occurred and the liquid gets into your eyes, wash immediately with clean water and seek medical attention immediately.** Failure to do so may cause eye or skin injury.

How to remove the battery

- 1** Press and hold the ►/II button to turn off your m:robe if it is turned on.
- 2** Remove the four screws on the side of the organic EL display using a screwdriver.

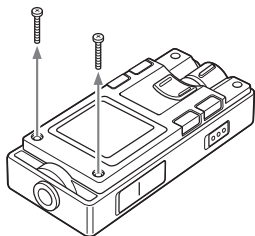

- 3** Turn over your m:robe, then remove the front cover.

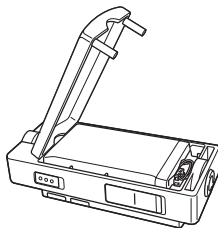

4 Remove the built-in battery from your m:robe.

Take out the battery, then disconnect the connector.

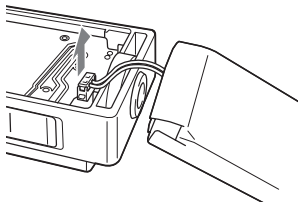

After taking out the battery, tape the cable to the battery body, making sure to cover the connector part, then put the battery in a plastic bag.

⚠ Notes

- Check that the battery is completely exhausted before removing it.
- Make sure that your m:robe is turned off before removing the battery.
- Do not reuse the battery once it has been removed.
- Take the removed built-in battery to a recycling location.
- When you dispose of this product, you should obey the local ordinance or rules of your municipality. For details, contact your local authority.

Troubleshooting

Before sending the product for repair, refer to the following checklist to resolve the problem. If the problem persists, contact an authorized Olympus service center.

In addition, be sure to back up the data in your m:robe before sending this product for repair or service. Writing to the memory or deleting data etc., may be necessary during the repair or service. Due to copyright restrictions, we cannot copy stored data for repair or service.

Restoring the data is not possible. We also recommend backing up your data often to prevent data loss problems.

Problem	Cause	Resolution
The power cannot be turned on.	The HOLD function is set to on.	Slide back the HOLD switch to release the HOLD function, then press the ►/ button (🔑 page 31).
The player turns off automatically.	“Auto PWR Off” or “Sleep Mode” is set.	Set the “Auto PWR Off” or “Sleep Mode” to “Off” or set the desired time (🔑 page 67).
	The “Auto PWR Off” or “Sleep Mode” is activated.	Press and hold the ►/ button to turn the power on (🔑 page 24).
The m:robe functions cannot be operated.	The HOLD function is set to on.	Slide back the HOLD switch to release the HOLD function (🔑 page 31).
The device becomes hot.	The temperature of the device increases after extended periods of operation.	This is not a malfunction.

Problem	Cause	Resolution
The battery discharges soon after charging.	The built-in battery is good for about 500 complete charges and discharges, depending on usage.	Contact an authorized Olympus service center for a replacement.
Nothing is on the display.	The battery is empty.	Charge the battery (👉 page 18).
The display is not clear.	The battery is empty.	Charge the battery (👉 page 18).
	The brightness setting is too low.	Adjust settings of the “Contrast” (👉 page 66).
The display is turned off.	The timer of the light emitting time of organic EL is activated.	Set the desired backlight time (👉 page 66).
There is no sound.	The volume is set to the minimum.	Adjust the volume (👉 page 33).
	The earphones are not connected properly.	Check if the earphones jack is connected properly (👉 page 23).
	“Mute (🔇 MUTE)” is set in FM MODE.	Press the ▶/ button to set on air (🔊 ON AIR) (👉 page 51).
You cannot find a file you transferred.	The file you transferred is saved in an unsupported format.	Check and correct the saving format, then transfer the file again (delete unrecognized files in your m:robe).

Rebooting your m:robe

If a problem persists after trying the suggested solution, rebooting your m:robe may solve the problem.

Push a pointed object, such as a pen, into the RESET button.

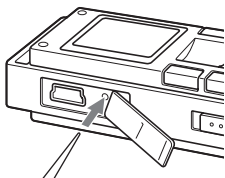

Tip

Rebooting your m:robe does not delete data.

● Service and maintenance

- The product will come with a Warranty card. Make sure that the dealer name and purchase date are written or stamped on the warranty. If any of the necessary information is missing, contact the dealer. Please read through the Warranty card and store it in a safe place.
- If you have a query about after-sale services for this product or encounter a failure, contact the dealer or an authorized Olympus service center. Within 1 year of the purchase date, we will repair the product free of charge if it becomes faulty, provided that the instructions in this USER'S MANUAL were observed.
- Maintenance parts for this product will be stored for about 5 years after production stops. Within this period, we can accept repair requests. Even after this period, repair may be possible. Contact the dealer or an authorized Olympus service center.
- Olympus will not compensate for any damage or loss (including cost when purchase/obtain audio files) incurred as a consequence of a failure of this product. Postage and packing costs are the responsibility of the sender.
- When sending this product to us for maintenance, pack the product with sufficient cushioning to avoid damage during transportation. Use a door-to-door package delivery service or registered parcel mail so that you have proof of sending the product.
- Ownership of removed parts during repair will belong to us.
- Stored data on the memory may be lost, and writing to the memory or deleting data, etc., may be necessary during repair or service. Be sure to back up your data before sending this product for repair or service. Olympus will take no responsibility for any loss due to changes of stored data.
- We cannot accept any request for the recovery/restoration of lost data.
Due to copyright restrictions, we cannot copy stored data for repair or service. Therefore, we may not be able to accept repair of service where restoring data is required.

Specifications

m:robe

Product name	DIGITAL AUDIO PLAYER
Model name	MR-F30
Built-in battery	Lithium-polymer rechargeable battery
Weight	Approx. 40 g (including battery)
Dimensions	33.5 mm × 73.5 mm × 21 mm (W×H×D, protruding parts excluded)
Display	OLED (organic EL display) 96 × 96 pixels, 260,000 colors
Storage	Built-in flash memory 512 MB (MR-F32)* ¹ 1 GB (MR-F33)* ¹
Supported file formats	Music file: Windows Media Audio (WMA) MPEG1/2/2.5, Audio Layer 3 (MP3) Ogg Vorbis (OGG) Photo file: Joint Photograph Experts Group (JPEG)
Encode format	MP3
Recording format	MP3
Number of storable tracks	Approx. 120 music tracks (MR-F32)* ² Approx. 240 music tracks (MR-F33)* ²
Continuous playback time	Approx. 15 hours (MP3)* ³

Bit rate	WMA: 32 to 192 kbps (including VBR) MP3: 16 to 320 kbps (including VBR) OGG: 16 to 256 kbps (Mono), 64 to 512 kbps (Stereo) (including VBR)
Operating conditions	Temperature: 5°C to 35°C Humidity: 30 to 90% (no condensation)
Charge time	Approx. 3 hours (using the dedicated USB cable)
USB port	USB2.0
Earphones jack	3.5 mm jack/stereo type

*¹ 1 GB = 1 billion bytes: the actual formatted capacity is somewhat less
(The actual capacity after formatting will be less than 512 MB/1 GB.)

*² For typical 4-minute tracks recorded at 128 kbps in WMA format

*³ When playing WMA/MP3/OGG formatted 128 kbps, 44.1 kHz audio data at room temperature (25°C), with the backlight turned off, and with the audio volume set to a medium level

This value is subject to the operating conditions, an ambient temperature, number of charging/discharging times, etc., and is for reference only and is not guaranteed.

Specifications and design are subject to change without notice.

Menu list



MUSIC MODE

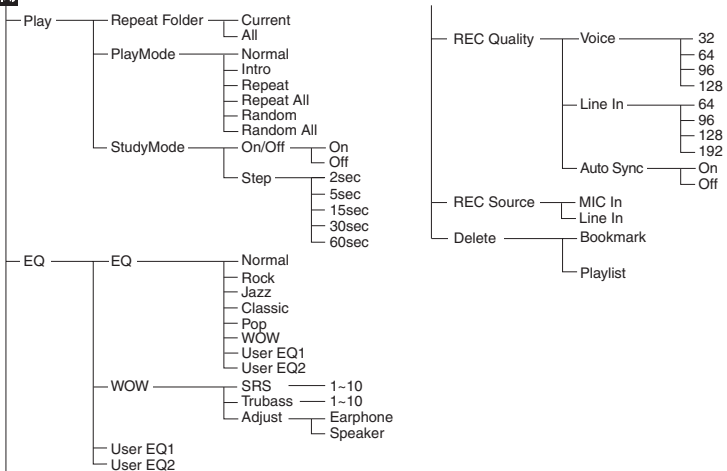

FM MODE

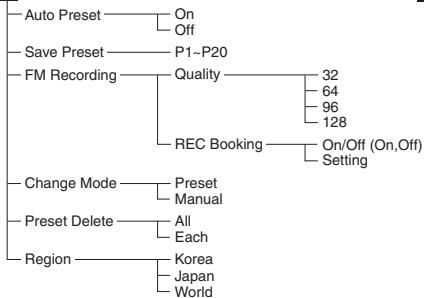
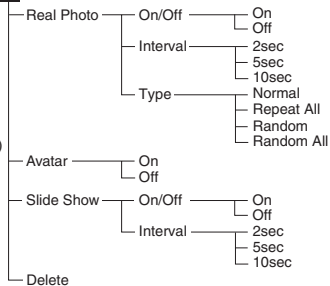
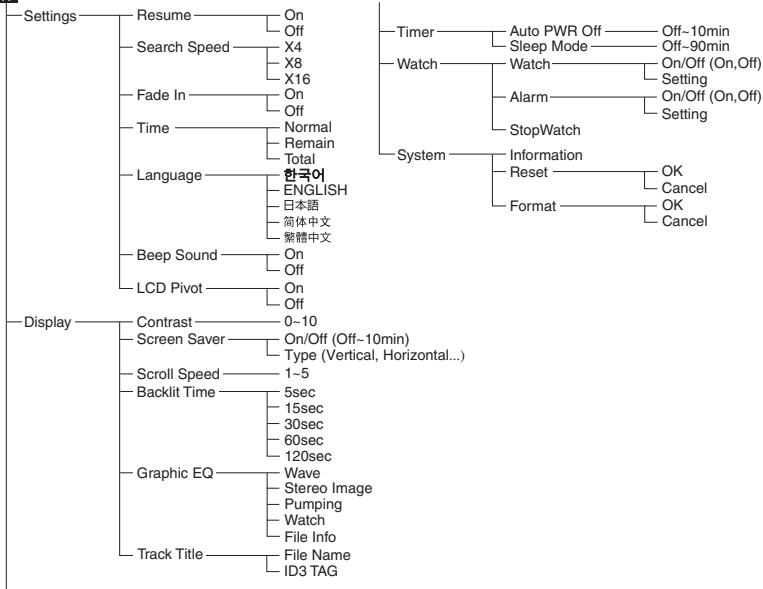

PHOTO MODE





SETTINGS



Index

A		E	
Alarm	67	Earphones	23
Area	53	EQ	40
Auto Preset	54	F	
Auto PWR Off	67	Fade In	65
Auto Sync	49	FM MODE	50
Avatar	62	FM recording	57
B		FM recording reservation	58
Backlit Time	66	Format	68
Battery	14, 71	G	
Beep Sound	65	Graphic EQ	66
Bit rate	46, 48, 57	H	
Bookmark	42	HOLD	31
C		I	
Contrast	66	Information	68
D		Interval repeat (A-B)	39
Delete		Intro	36
Bookmark	43	L	
Files	28	Language	65
Playlist	43	LCD Pivot	65
Stored frequencies	56		
Display setting	66		

M

Manual mode	52
Manual Preset	54
Menu list	79
Microphone	45
MUSIC MODE	32
Music Recording	47

N

Navigation search	27
-------------------------	----

O

Organic EL display (OLED)	13
OS setting	68

P

PHOTO MODE	60
Playback	
Music file	33, 35
Photo file	60
Recorded file	48
Voice file	46
PLAYLIST	34
PlayMode	36
Power	24
Preset mode	52

R

Random	36
Random All	36
Real Photo	61
Recording	
FM	57
Music	47
Voice	45
Repeat	36
Repeat All	36
Repeat Folder	37
Reset	68
RESET button	75
Resume	65

S

Screen Saver	66
Scroll Speed	66
Search Speed	65
SETTINGS	64
Settings	65
Sleep Mode	67
Slide Show	63
StopWatch	67
StudyMode	38
System setting	65

T	
Time	65
Timer setting	67
Track Title	66
U	
USB charging	18
V	
Voice recording	45
Volume	33
W	
Watch	67
Watch setting	67
WOW	41

● Before you contact us

- Confirm the following points before contacting us so that we can provide quick and accurate answers.
- Please fill out this check sheet if you want to contact us by fax or mail.
- Symptom, displayed messages, frequency, and other details of the problem:
PC-related problems are difficult to accurately identify. Please provide as much detail as possible.

- Name:
- Contact information: Postal code
Address (your residential address or office address)
Phone/Fax
E-mail
- Product name (model):
- Serial number (located on the side of the product):
- Purchase date:
* Please provide the following information if you are using the storage unit connected to a PC, or if you are using third party application software:
- Type of PC:
- Manufacturer, model, and other:
- Memory size and free hard disk space:
- Type of operating system and version:
- Settings on Control Panel/System/Device Manager:
- Other peripheral devices connected:
- Name and version of the application software related to your problem:
- Name and version of the OLYMPUS software product related to your problem:

OLYMPUS

<http://www.olympus.com/>

OLYMPUS IMAGING CORP.

Shinjuku Monolith, 3-1 Nishi-Shinjuku 2-chome, Shinjuku-ku, Tokyo, Japan

OLYMPUS KOREA CO., LTD.

9F, Hyundai Marines BD, 646-1, Yeoksam-Dong, Gangnam-Gu, Seoul, Korea

<http://www.olympus.co.kr>

Tel. 1544-3200

Free Manuals Download Website

<http://myh66.com>

<http://usermanuals.us>

<http://www.somanuals.com>

<http://www.4manuals.cc>

<http://www.manual-lib.com>

<http://www.404manual.com>

<http://www.luxmanual.com>

<http://aubethermostatmanual.com>

Golf course search by state

<http://golfingnear.com>

Email search by domain

<http://emailbydomain.com>

Auto manuals search

<http://auto.somanuals.com>

TV manuals search

<http://tv.somanuals.com>