

Eye-Trek

OLYMPUS®

FMD-250W

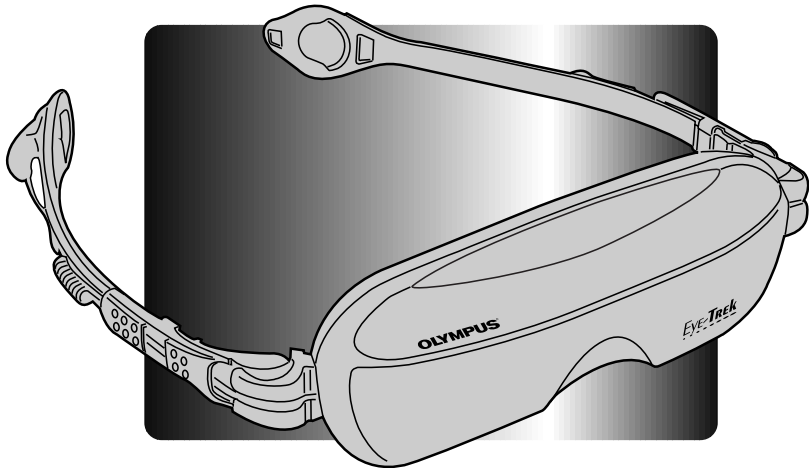

ENGLISH

FRANÇAIS

ESPAÑOL

INSTRUCTION MANUAL

Thank you very much for purchasing an OLYMPUS product.
Please keep this manual handy for future use.

MODE D'EMPLOI

Nous vous remercions pour l'achat d'un produit OLYMPUS.
Veuillez conserver ce manuel à portée de main pour un usage ultérieur.

MANUAL DE INSTRUCCION

Le agradecemos por la adquisición de un producto OLYMPUS.
Conserve este manual a mano para uso futuro.

SAFETY NOTICE



The exclamation point within an equilateral triangle is intended to alert the user to the presence of important operating and maintenance (servicing) instructions in the literature accompanying the product.

WARNING: TO REDUCE THE RISK OF FIRE OR ELECTRIC SHOCK, DO NOT EXPOSE THIS PRODUCT TO RAIN OR MOISTURE.

CAUTION: TO PREVENT ELECTRIC SHOCK, MATCH WIDE BLADE OF PLUG TO WIDE SLOT, FULLY INSERT.



WARNING: This is intended to alert the user to the possibility of serious injury or death if ignored.



CAUTION: This is intended to alert the user to the possibility of moderate injury or damage to the equipment.

SAFETY INSTRUCTIONS

- 1 Read Instructions** — All the safety and operating instructions should be read before the product is operated.
- 2 Retain Instructions** — The instruction manual should be retained for future reference.
- 3 Heed Warnings** — All warnings on the product and in the operating instructions should be adhered to.
- 4 Follow Instructions** — All operating and use instructions should be followed.
- 5 Cleaning** — Unplug this product from the wall outlet before cleaning. Do not use liquid cleaners or aerosol cleaners. Use a damp cloth for cleaning.
- 6 Attachments** — Do not use attachments that are not recommended by the product manufacturer as they may cause hazards.
- 7 Water and Moisture** — Do not use this product near water – for example, near a bath tub, wash bowl, kitchen sink, or laundry tub; in a wet basement; or near a swimming pool; and the like.
- 8 Accessories** — Do not place this product on an unstable cart, stand, tripod, bracket, or table. The product may fall, causing serious injury to a child or adult, and serious damage to the product.
- 9 Power Sources** — This product should be operated only from the type of power source indicated on the marking label. If you are not sure of the type of power supply to your home, consult your product dealer or local power company.
- 10 Grounding or Polarization** — This product may be equipped with a polarized alternating-current line plug (a plug having one blade wider than the other). This plug will fit into the power outlet only one way. This is a safety feature. If you are unable to insert the plug fully into the outlet, try reversing the plug. If the plug should still fail to fit, contact your electrician to replace your obsolete outlet. Do not defeat the safety purpose of the polarized plug.
- 11 Power-Cord Protection** — Power-supply cords should be routed so that they are not likely to be walked on or pinched by items placed upon or against them, paying particular attention to cords at plugs, convenience receptacles, and the point where they exit from the product.
- 12 Lightning** — For added protection for this product during a lightning storm, or when it is left unattended and unused for long periods of time, unplug it from the wall outlet and disconnect the antenna or cable system. This will prevent damage to the product due to lightning and power-line surges.
- 13 Overloading** — Do not overload wall outlets, extension cords, or integral convenience receptacles as this can result in a risk of fire or electric shock.
- 14 Object and Liquid Entry** — Never push objects of any kind into this product through openings as they may touch dangerous voltage points or short-out parts that could result in a fire or electric shock. Never spill liquid of any kind on the product.
- 15 Servicing** — Do not attempt to service this product yourself as opening or removing covers may expose you to dangerous voltage or other hazards. Refer all servicing to qualified service personnel.

- 16 Damage Requiring Service** — Unplug this product from the wall outlet and refer servicing to qualified service personnel under the following conditions:
- (a) When the power-supply cord or plug is damaged,
 - (b) If liquid has been spilled, or objects have fallen into the product,
 - (c) If the product has been exposed to rain or water,
 - (d) If the product does not operate normally by following the operating instructions. Adjust only those controls that are covered by the operating instructions as improper adjustment of other controls may result in damage and will often require extensive work by a qualified technician to restore the product to its normal operation,
 - (e) If the product has been dropped or damaged in any way, and
 - (f) When the product exhibits a distinct change in performance – this indicates a need for service.
- 17 Replacement Parts** — When replacement parts are required, be sure the service technician has used replacement parts specified by the manufacturer or have the same characteristics as the original part. Unauthorized substitutions may result in fire, electric shock, or other hazards.
- 18 Safety Check** — Upon completion of any service or repairs to this product, ask the service technician to perform safety checks to determine that the product is in proper operating condition.
- 19 Wall or Ceiling Mounting** — The product should be mounted to a wall or ceiling only as recommended by the manufacturer.
- 20 Heat** — The product should be situated away from heat sources such as radiators, heat registers, stoves, or other products (including amplifiers) that produce heat.

FCC NOTICE

This equipment has been tested and found to comply with the limits for a Class B digital device, pursuant to Part 15 of the FCC Rules. These limits are designed to provide reasonable protection against harmful interference in a residential installation. This equipment generates, uses, and can radiate radio frequency energy and, if not installed and used in accordance with the instructions, may cause harmful interference to radio communications. However, there is no guarantee that interference will not occur in a particular installation. If this equipment does cause harmful interference to radio or television reception, which can be determined by turning the equipment off and on, the user is encouraged to try to correct the interference by one or more of the following measures;

- Reorient or relocate the receiving antenna.
- Increase the separation between the equipment and the receiver.
- Connect the equipment into an outlet on a circuit different from that to which the receiver is connected.
- Consult the dealer or an experienced radio or television technician for help.

FCC Warning: Changes or modifications not expressly approved by the party responsible for compliance could void the user's authority to operate the equipment.

INDUSTRY CANADA RADIO FREQUENCY INTERFERENCE NOTICE

This Class B digital apparatus meets all requirements of the Canadian Interference-Causing Equipment Regulations.



WARNING

Some people should not use this product:



Prohibited

Children under 16 years of age

This product may interfere with development of their eyes and visual system. Password protection is provided to prevent children under 16 from using this display unit.

Anyone who has ever experienced convulsive or epileptic fits or loss of consciousness from light flashes or oscillations.

This product could cause the same symptoms for those people.

Anyone who cannot see the whole image clearly, or who wears glasses that make it hard to see the whole screen clearly, or who has an eye movement disorder or visual field disorder.

Under those conditions, using this product for a long time could damage their eyes.

Anyone with a heart disorder, high blood pressure, a visual field impairment, or an eye movement or alignment disorder.

If you have any of these conditions, consult a doctor before using this product, and stop using it immediately if you feel ill.



WARNING

Improper use of this product may cause serious injury:

	<p>Under some conditions, viewing with the Eye-Trek may cause:</p> <ul style="list-style-type: none">• Nausea• Headache• Motion sickness• Eye pain or eye fatigue• Neck or shoulder pain• Disturbance of hand-eye coordination• Dizziness• Feeling ill <p>If you experience any of these symptoms, stop viewing and rest until you recover. These symptoms could temporarily disturb your vision or balance. Do not try to operate a vehicle, walk, or move around until you feel better.</p>
<p>Prohibited</p>	<p>Do not use this product while you are actively moving, such as walking, skating, riding a bicycle, or operating a motor vehicle. This could interfere with your vision or balance, and cause a serious or fatal accident.</p> <p>Do not use this product when you are subject to strong vibrations, such as in a car on a bumpy road. This may cause dizziness, nausea, headaches, or motion sickness.</p> <p>Do not use this product continuously for long periods. Continuous use for long periods may damage your eyes. This product will turn off automatically after 2 1/2 hours; when that happens, do not use it again for at least 15 minutes.</p> <p>Do not use this product if the image does not appear clear and stable in both eyes. If the product is malfunctioning or you are not wearing it properly, viewing it could be hazardous.</p> <p>Do not listen to the sound at high volume. This could contribute to a loss of hearing. It could also interfere with your ability to hear important sounds around you, such as alarms, horns and sirens, especially in a public place.</p>



WARNING

To prevent electrical shock or fire with this product:



Do not use this product if there is thunder or lightning. Do not touch the control unit or power cord until after the storm has passed.

Beware of moisture. Do not use this product or leave it in very moist or humid places, such as in the rain, snow, fog, or a steamy bathroom. Do not use it if it has condensation inside, or if your hands are wet.

Do not use it near flammable gas, liquid, or vapor.

Do not expose it to very dusty environments.

Do not disassemble.



Do not use any AC adapter except the AC adapter provided or specified by Olympus.

Follow the appropriate cautions for electrical devices.



WARNING

For your safety:

 <p>Prohibited</p>	<p>Do not use this product in situations that are potentially dangerous, such as on a bus or train where you may fall down, or in places where you cannot guarantee your personal safety.</p> <p>Using this product in such a situation may result in an unexpected accident or injury.</p> <p>Do not leave this product in a closed automobile or in other places under direct sunlight for long periods.</p> <p>Doing so may cause the product to be deformed by heat, resulting in a malfunction and an electric shock hazard.</p>
	<p>Note the following points when plugging the AC adapter into a power outlet.</p> <p>When the AC adapter of this product is plugged in adjacent to another power plug, insert each plug into the power outlet paying attention not to apply excessive force to either one.</p> <p>Insert the AC adapter completely and securely into the power outlet. Leave enough slack for the power cord so that the AC adapter or cord is not subjected to excessive force.</p>

CONTENTS

SAFETY NOTICE	E-2
SAFETY INSTRUCTIONS	E-3
WARNINGS	E-5
<hr/>	
MAIN FEATURES OF Eye-Trek	E-10
ADDITIONAL INFORMATION	E-10
CHECKING THE CONTENTS	E-11
NAMES OF PARTS	E-12
<hr/>	
CONNECTIONS	E-13
WEARING/REMOVING THE DISPLAY UNIT ...	E-15
WATCHING VIDEO	E-17
TURNING ON THE POWER FOR THE FIRST TIME	E-17
TURNING ON THE POWER AFTER THE FIRST TIME	E-19
SELECTING SCREEN FORMAT	E-20
ADJUSTING THE AUDIO/VIDEO	E-21
SAVING, LOADING AND CANCELING THE AUDIO/VIDEO SETTINGS	E-25
REGISTERING, CHANGING OR CANCELING THE PASSWORD.....	E-26
WHEN YOU ARE FINISHED	E-27
<hr/>	
CHANGING THE FRAMES	E-28
SPECIFICATIONS	E-29
TROUBLESHOOTING	E-30
REPAIR SERVICE	E-30

MAIN FEATURES OF Eye-Trek

- New type of personal display that uses a unique optical system to enlarge video images generated by small LCDs.
- Powerful image equivalent to viewing a 62" screen at 6 1/2 feet.
- Can be connected to a variety of video components, including a VCR, Video CD player, laserdisc player, DVD player, video camera, or TV, using audio/video output jacks.
- Compact, lightweight design that is easy to carry.
- As easy to wear as glasses. The user can adjust the nose pad to fit the display unit in the optimum viewing position.
- Can be worn over glasses.
- The image can be adjusted by selecting "**CONTRAST**", "**TINT**" and "**COLOR**" in the Menu.
- The sound can be adjusted by selecting "**SRS (SRS HEADPHONE)***" or "**BASS/TREBLE**".
- Password protection is provided to prevent unauthorized use of this display unit.
- "**WIDE/NORMAL**" display mode available for a more dynamic audio/video effect and a more "live" atmosphere.

* SRS (Sound Retrieval System) HEADPHONE

SRS HEADPHONE technology processes sound from a traditional stereo signal and restores its original three-dimensional qualities. By using Head Related Transfer Functions (the way that human ears create the world of sound in real life), SRS HEADPHONE technology can retrieve the ambient nature of stereo recordings, giving the listener the feel of a live performance.

HEADPHONE™ and the  symbol are trademarks of SRS Labs, Inc.

HEADPHONE™ technology is incorporated under license from SRS Labs, Inc.

ADDITIONAL INFORMATION

- Do not use the display unit if the image cannot be properly focused.
- The display unit may become warm after long periods of use, but this is not a malfunction.
- A black or white spot, or a red, green or blue point may be observed, but this is not a malfunction. More than 99.99% of this product's effective pixels are guaranteed.
- A vague striped pattern may appear, depending on the type of image displayed. This is due to the optical filter built into the product for smoothing the image and is not a malfunction.
- Lines (straight/slanted/curved) on the display may sometimes appear notched. This is due to the characteristics of the LCD monitor and is not a malfunction.
- Depending on the shape of your glasses, you may not be able to use this display unit.

CHECKING THE CONTENTS

Display unit

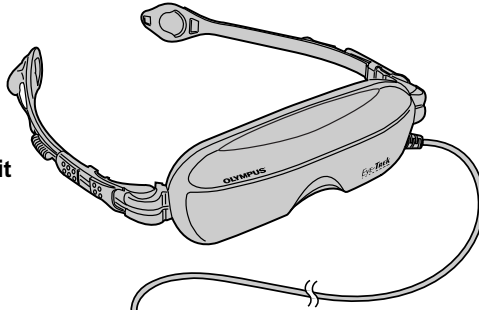

Control unit

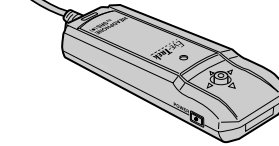

AC adapter

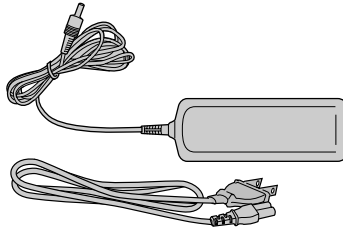

Instruction manual



AV cable

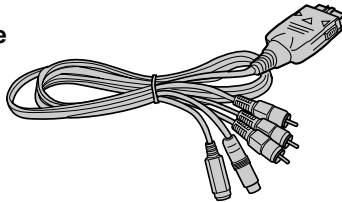

NAMES OF PARTS

DISPLAY UNIT

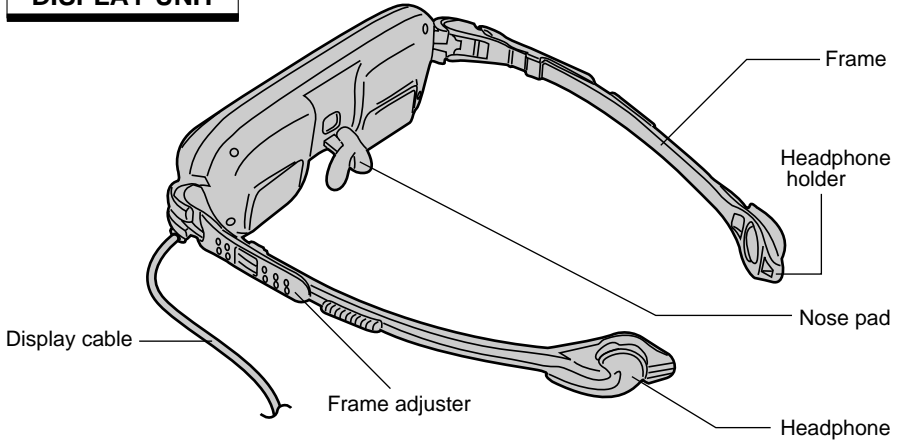

CONTROL UNIT

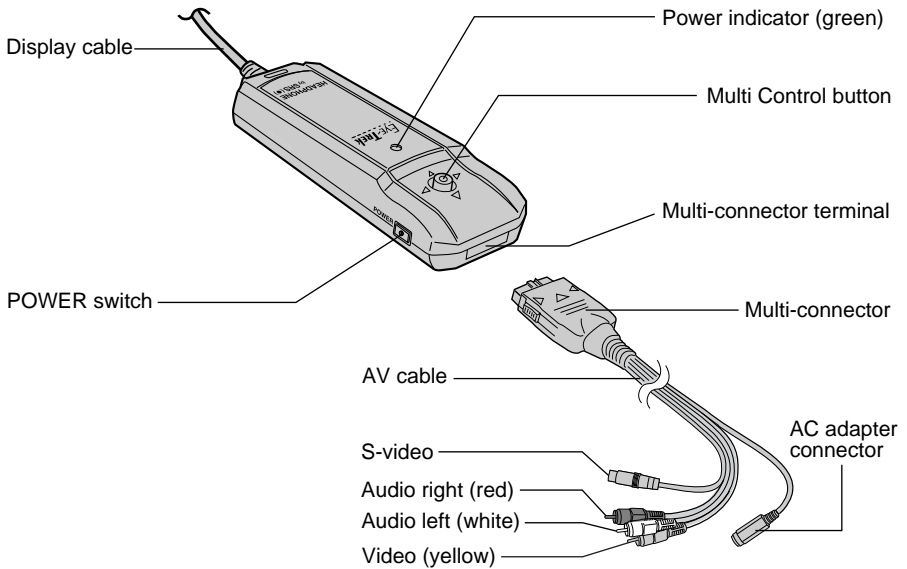

CONNECTIONS

Basic Connections

Notes:

- Make sure that the Eye-Trek and other video components are turned off before connecting.
- **Make sure that the AV cable's red, white, and yellow jacks are connected to the output jacks of the video component. If the AV cable is plugged into the input jacks, no image or sound will appear.**
- The video component's output jacks are usually on the rear side of the unit. Jacks on the front side are usually input jacks. Find out where the output jacks are before connection.
- Also refer to the connected video component's instructions.

Follow the steps below to connect the Eye-Trek to a video component.

- 1 Plug the AV cable into the Multi-connector terminal of the control unit.
- 2 Plug the AC adapter into the AV cable's AC adapter connector.
- 3 Plug the AV cable's red, white, and yellow jacks into the **output jacks** on the video component.
- 4 Plug the AC adapter into a power outlet.

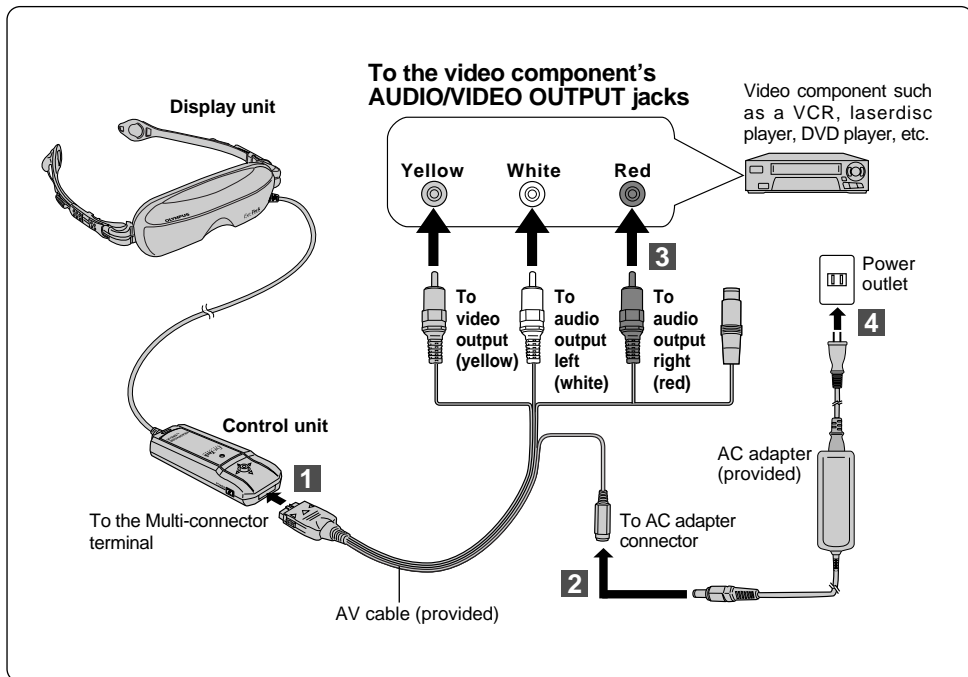

CONNECTIONS (Cont.)

Improving video clarity

If the connected video component has an S-video output jack, clearer video can be viewed by connecting it through the S-video jack.

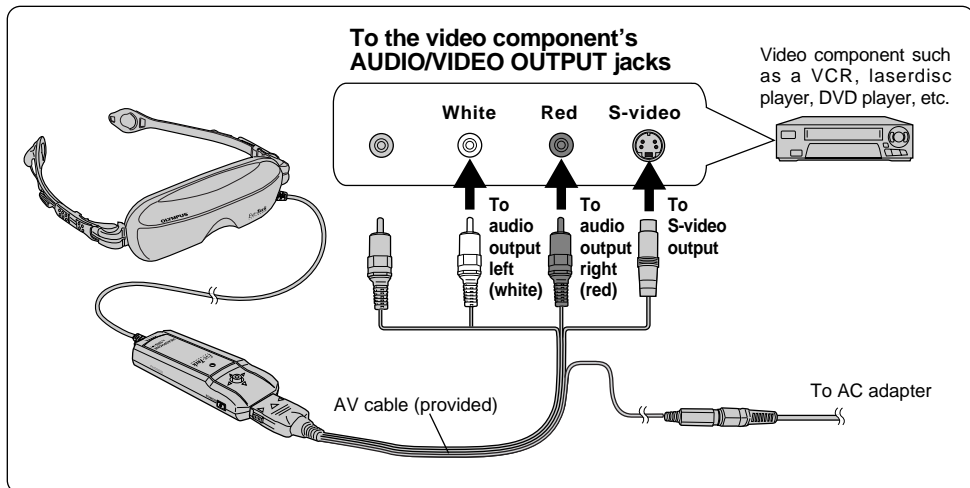

- If the S-video jack and the video jack (yellow) are connected at the same time, the S-video output has priority.

Other connections (connecting to a Mini-Jack)

If the connected video component uses a mini-jack and cannot be directly connected with the AV cable, use plug adapters.

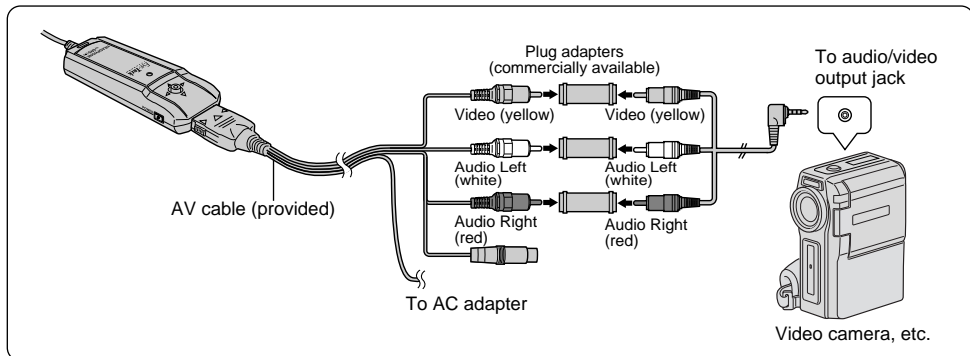

Note: When the video component has more than one output jack, it can be connected with more than one Eye-Trek unit.

WEARING/REMOVING THE DISPLAY UNIT

Wearing the display unit

1 Remove each headphone upward from the holder as shown in the figure.

- When putting the headphones back in the holders, simply reverse the order of removal for each.
- If you wish to use ear pads on the headphones, use 16.0 mm ear pads (commercially available).

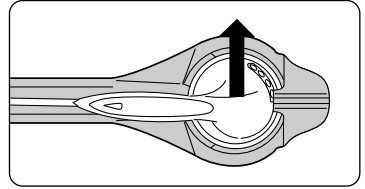
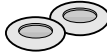

2 Put the display unit on as if wearing glasses and insert the headphones.

- Adjust the nose pad to put the image to the optimal position. If this adjustment is not performed, the image may appear dim.
- If the image still cannot be seen properly or is dim after adjusting the nose pad, switch the left and right frames (☞ pg. 28).
- When wearing the display unit over glasses, pull the nose pad out slightly more than usual.
- If you cannot wear the display unit securely because there is too much space between the frame arms, reduce the space using the frame arm adjusters (☞ pg. 16).

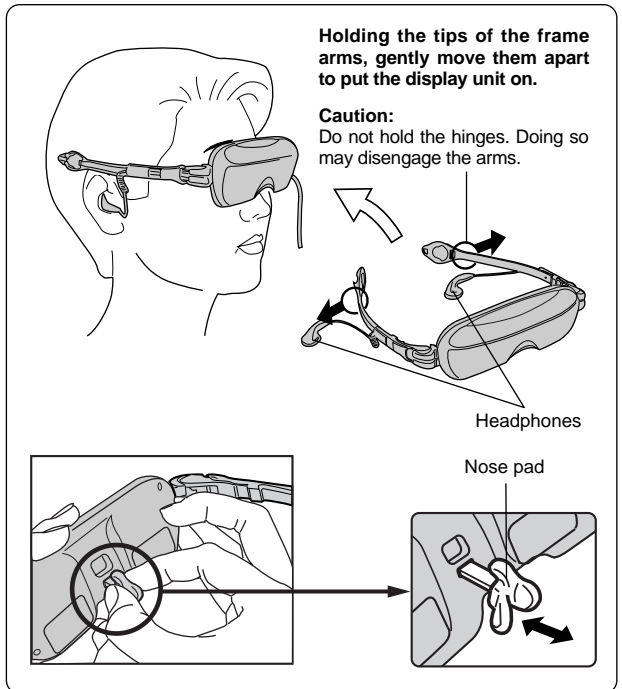

NOTICE

- Be sure to wear the display unit properly so that the image appears clear and stable in both eyes.
- If you widen the frame arms too much when wearing the display unit, the frame adjusters may pop out.
- Do not pull or twist the nose pad excessively in directions other than those shown in the figure. This may break the nose pad or crack its surface.

WEARING/REMOVING THE DISPLAY UNIT (Cont.)

Adjusting the space between the frame arms

You can narrow the space between the frame arms using the frame adjusters when the frame arms don't fit your face.

How to adjust

Slide the frame adjuster in the direction of the display unit. Do not slide it with the frame arm fully opened. If you do so, the end **A** of the frame arm will strike the joint. Adjust without extending the frame arm fully, being sure to set both frame adjusters to the same position.

If you cannot wear the display unit securely even after adjusting the space between the frame arms, switch the left and right frame arms with each other and adjust the space again (☞ pg. 28).

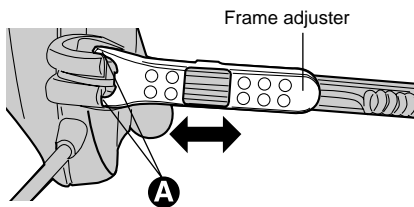

Removing the display unit

- When removing the display unit, first remove the headphones from your ears.
- If you are also wearing glasses, remove the display unit by holding the left and right arms with your fingers while pushing the frame arms of your glasses upward with your thumbs.

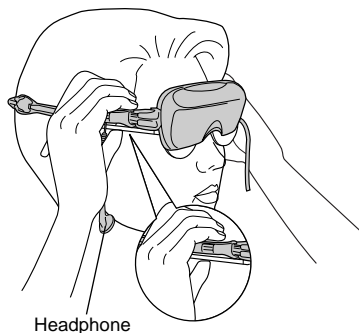

When you remove the display unit, some types of glasses may come off together with the display unit. To avoid this, move the bridge of the glasses in the direction of the arrow as shown.

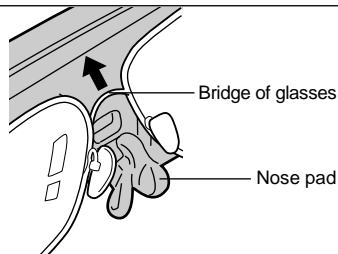

NOTICE

If the display unit is removed before the headphones have been removed from your ears, the headphone cords will be pulled excessively and may be disconnected.

WATCHING VIDEO



TURNING ON THE POWER FOR THE FIRST TIME

Before watching an image, **1** Select the desired language for the Menu screen, and **2** Enter the password ("0, 0, 0").

1 Turn the power on and select the desired language.

1. Turn on the connected video component.
2. Press the POWER switch on the Eye-Trek control unit. The power indicator lights in green, then the language selection screen appears.
3. Move the Multi Control button up/down (▲, ▼) to select the desired language for the On-Screen Display. Then press the Multi Control button.

A warning appears on the screen.

- The  mark appears next to the selected language.
- The language selection screen will not appear the next time the power is turned on. Refer to the reset instructions to change the language ( pg. 24).

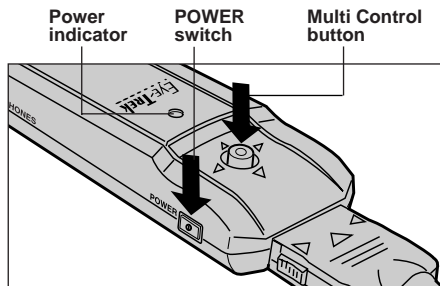

On-Screen Display



Multi Control button



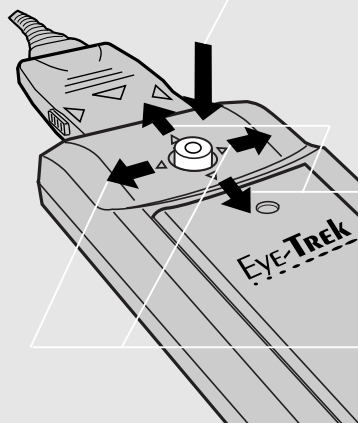

The Multi Control button lets you easily control all Eye-Trek functions from one convenient location.

To the video component





To the display unit



Press

- Confirms the warning/health warning screens ( pg.18-19).
- Displays the menu screen while watching an image ( pg.20, 22-25).
- Sets items selected on the Menu ( pg.17, 20-25).
- Sets the password ( pg.18-19, 26).

Move up/down..... ▲ ▼

- Selects numbers for the password ( pg.18-19, 26).
- Adjusts volume while watching an image. ( pg.21).
- Selects desired items in the Menu screen ( pg.22-25).

Move right/left..... ◀ ▶

- Adjusts the contrast while watching an image. ( pg.21)
- Adjusts the items you want to set while the Menu is on the display ( pg.22-24).

WATCHING VIDEO (Cont.)

2 Acknowledge the warning, then enter the password.

1. Acknowledge the warning on the screen, then press the Multi Control button. The password entry screen appears.
 - If the Multi Control button is not pressed on the warning screen, the password entry screen will not appear.
 - The power will be turned off if there is no operation for 1 minute.
2. When the password entry screen appears, press the Multi Control button three times to select the number '0' for the three digits.

On-Screen Display

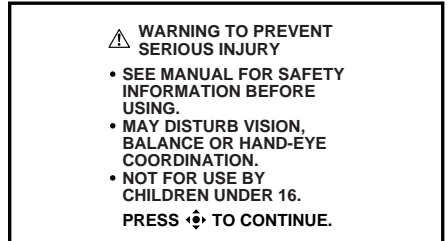

The Eye-Trek is now set.

Start playback on the video component. The image will appear on the Eye-Trek.

- The password is set to 0,0,0 when this product is used for the first time or after it is reset (pg. 24), therefore, the first entry will always be 0,0,0.
- If no video signal is input to this unit, the message "INPUT VIDEO SIGNAL." will appear on the display. If this occurs, check the power and connection to the video component. If a video signal is input, the message will disappear. The power will shut off automatically if a video signal is not input to this unit for approx. 1 minute.
- If you do not wish to use the password registration, you can cancel it. Refer to pg. 26 for REGISTERING, CHANGING OR CANCELING THE PASSWORD.

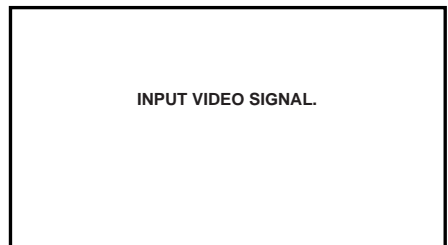

TURNING ON THE POWER AFTER THE FIRST TIME

When you turn on the power after the first time, simply enter the password to display images. (The language selection screen does not appear.)

1 Turn the power on.

1. Turn on the connected video component.
2. Press the POWER switch on the Eye-Trek control unit. The power indicator lights in green and the warning appears on the screen.
3. Acknowledge the warning, then press the Multi Control button.

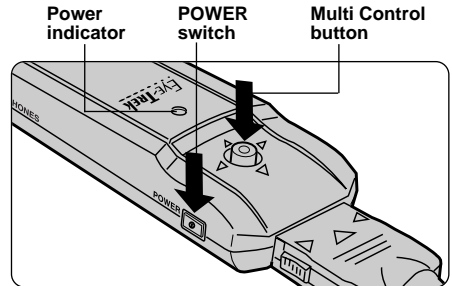

2 Enter the password.

When the password has been registered...

1. When the password entry screen appears, move the Multi Control button up/down (▲, ▼) to select the registered numbers, then press it to complete the entry.
2. Start playback on the video component. The image will appear on the Eye-Trek.

- When the wrong password is entered... The password entry screen appears again after "PASSWORD ENTERED IS NOT CORRECT." is displayed. If you enter the wrong password 3 times in a row, the power automatically turns off after "PASSWORD ENTERED IS NOT CORRECT. SHUTTING POWER OFF." is displayed.

When the password registration has been canceled...

The password entry screen will not appear when the password registration has been canceled (pg. 26).

On-Screen Display

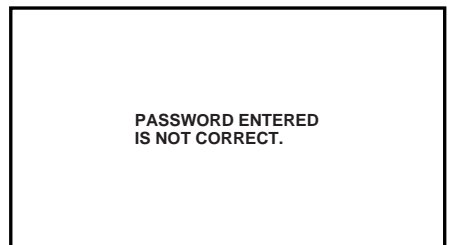
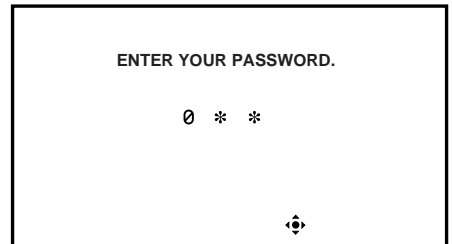

WATCHING VIDEO (Cont.)

SELECTING SCREEN FORMAT

You can select the size of the screen (NORMAL/WIDE).

1

Select NORMAL/WIDE.

1. While an image is being displayed, press the Multi Control button to bring up the Menu screen.
2. Move the Multi Control button up/down (▲, ▼) to select NORMAL/WIDE.
3. Move the Multi Control button right/left (◀, ▶) to select NORMAL/WIDE.
 - Move the Multi Control button to the right to set the screen size to WIDE. Move it to the left to set the screen size to NORMAL.
 - If there is no operation for 10 seconds or more, the selected screen size will be activated, then the display will return to the normal screen.

On-screen display

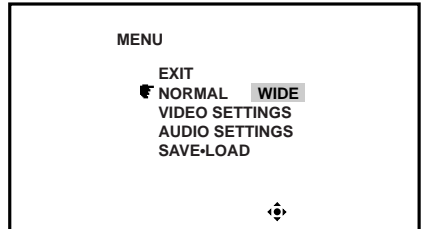

NORMAL

Standard image with an aspect ratio of 4:3. Black bands are inserted at the right and left of the screen.

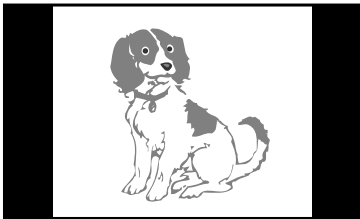

WIDE

Wide screen image with an aspect ratio of 16:9. The top and bottom are unchanged, but the image is expanded horizontally. Suitable for viewing vertically-elongated images (called Squeeze images) recorded on a video camera, DVD images, or Hi-Vision images played back through a MUSE-NTSC converter.

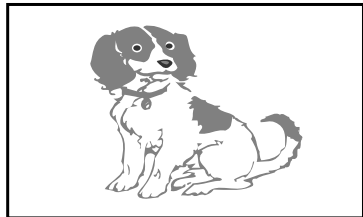

■ Selecting the WIDE mode

When a standard image (4:3 aspect ratio) is viewed in the WIDE mode, and when the image is adjusted to fill up the width of the screen, the edges of the image may be cut off or distorted. For best results, select the normal mode to view the image as originally intended.

■ Displaying the image

The WIDE mode is provided for viewing. Note that if you select the WIDE mode when viewing a TV program or other software on the display, the image will differ from that viewed on a TV.

■ Violating copyright law

If this display unit is placed in a public area (such as a hotel or coffee shop) and used for public display or profit-making, certain copyright laws may be violated when image is compressed or enlarged with the WIDE mode, if doing so displays the image differently than originally intended.

ADJUSTING THE AUDIO/VIDEO

Once the image appears, adjust the VOLUME and CONTRAST.

Adjusting the volume

1. Move the Multi Control button up/down (▲, ▼) while the normal screen is displayed. The volume level appears on the screen.
2. Move the Multi Control button up/down (▲, ▼) to adjust the volume.

▲ : Increases the volume.

▼ : Decreases the volume.

- The volume level is set to the 8th bar on the scale at the factory.
- When VOLUME LIMIT is set to ON, the volume is limited to a certain level in order to avoid excessive noise, ear damage, or the inability to hear outside sound. (☞ pg.23)
- To return to the normal screen, press the Multi Control button. If there is no operation for 3 seconds or more, the adjusted volume level will be activated, and the display will return to the normal screen.

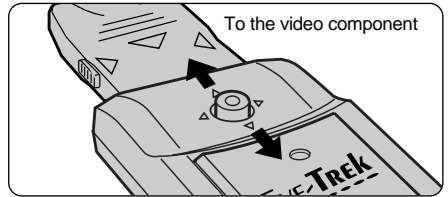

On-Screen Display

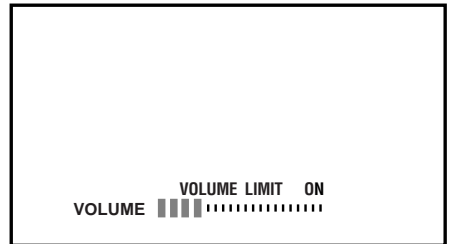

Adjusting the contrast

1. Move the Multi Control button right/left (◀, ▶) while the normal screen is displayed. The contrast level appears on the screen.
2. Move the Multi Control button right/left (◀, ▶) to adjust the contrast.

▶ : Increases the contrast.

◀ : Decreases the contrast.

- The contrast is set to "0" at the factory.
- The contrast can also be set through the Menu screen (☞ pg.22).
- To return to the normal screen, press the Multi Control button. If there is no operation for 3 seconds or more, the adjusted contrast level will be activated, and the display will return to the normal screen.

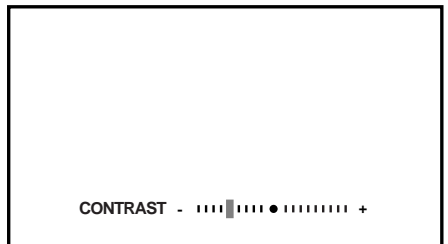
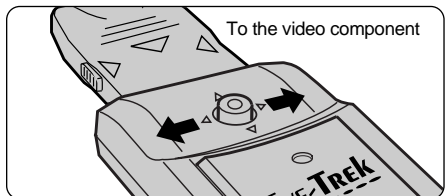

WATCHING VIDEO (Cont.)

You can adjust the desired audio/video items.

You can also save your preferred settings. (For more information, refer to "SAVING, LOADING AND CANCELING THE AUDIO/VIDEO SETTINGS" on pg.25.)

ADJUSTING THE VIDEO

1 Select VIDEO SETTINGS in the Menu screen.

1. Press the Multi Control button to display the Menu screen.
2. Move the Multi Control button up/down (▲, ▼) to select VIDEO SETTINGS, then press it or move it to the right (▶).
 - When EXIT is selected, the Menu disappears from the screen and returns to the normal screen.

On-Screen Display

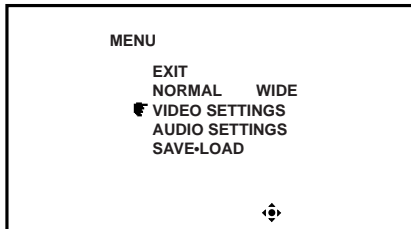

2 Select the desired item in VIDEO SETTINGS.

1. Move the Multi Control button up/down (▲, ▼) to select the item you wish to change.
2. Move the Multi Control button right/left (◀, ▶) to select the desired level.

To adjust CONTRAST, BRIGHTNESS, TINT or COLOR:

Move the Multi Control button right/left (◀, ▶) to increase/decrease the level.

To select ORIGINAL:

Press the Multi Control button or move it to the right (▶). The VIDEO SETTINGS return to the factory default settings.

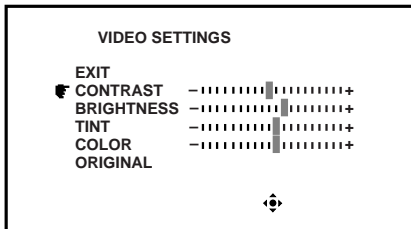

Under ORIGINAL, the settings in SAVE, AUDIO SETTINGS and NORMAL/WIDE settings cannot be changed. Perform a reset if you wish to cancel all the settings (pg. 24).

- CONTRAST can also be adjusted simply by moving the Multi Control button right/left while viewing an image. (pg.21).
- Select EXIT to return to the normal screen.

- If the Multi Control button is not operated for 10 seconds while selecting/adjusting Menu items, the displayed adjustment is activated and the Menu returns to the normal screen.
- The mark appears next to the selected item.

ADJUSTING THE AUDIO

1 Select AUDIO SETTINGS in the Menu screen.

1. Press the Multi Control button to display the Menu.
 2. Move the Multi Control button up/down (▲, ▼) to select AUDIO SETTINGS, then press it or move it to the right (▶).
- When EXIT is selected, the menu disappears from the screen and returns to the normal screen.

On-Screen Display

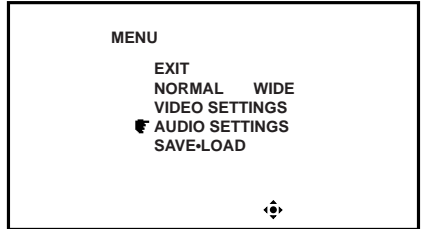

2 Select the desired item in AUDIO SETTINGS.

1. Move the Multi Control button up/down (▲, ▼) to select the item you wish to change.
2. Move the Multi Control button right/left (◀, ▶) to set the desired level.

To adjust SRS, BASS and TREBLE:

Each level changes as follows.

Right (▶): OFF → 1 → 2 → 3

Left (◀): 3 → 2 → 1 → OFF

- To get the most out of SRS, cancel your video component's sound effects (surround, etc.).
- SRS doesn't function if your sound source is monaural.

To set VOLUME LIMIT:

Select ON or OFF.

Right (▶) for ON : The volume can only go up to a certain level.

Left (◀) for OFF : Cancels the VOLUME LIMIT.

To adjust VOLUME:

Right (▶): Increases the volume.

Left (◀) : Decreases the volume.

- VOLUME can also be adjusted simply by moving the Multi Control button up/down while viewing an image.
- Select EXIT to return to the normal screen.

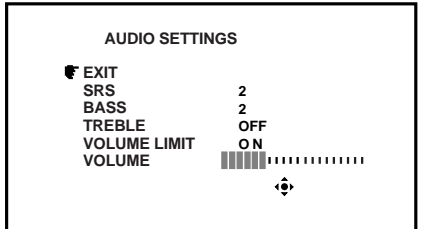

WATCHING VIDEO (Cont.)

ADJUSTING THE AUDIO/VIDEO (Cont.)

Menu items	Functions	Multi Control button	Selections	Default settings
EXIT	Cancels the menu and returns to the normal screen.	Press	—	—
WIDE NORMAL	Selects the size of the screen.	▶ ◀	WIDE (16:9) NORMAL (4:3)	WIDE
CONTRAST	Adjusts the contrast. Can also be adjusted on the normal screen.	▶ (+) ◀ (-)	Stronger Weaker	0
BRIGHTNESS	Adjusts the brightness.	▶ (+) ◀ (-)	Brighter Darker	0
TINT	Adjusts the tint.	▶ (+) ◀ (-)	Redder Greener	0
COLOR	Adjusts the depth of colors in the video image.	▶ (+) ◀ (-)	Deeper Lighter	0
ORIGINAL	The VIDEO SETTINGS return to the factory default settings. To cancel all the settings, see the bottom of this page.	Press or ▶	—	—
SRS	Creates three-dimensional sound to give you a more dynamic listening experience.	▶ (ON; 1/2/3 levels) ◀ (OFF)	Set Cancel	2
BASS	Boosts low frequencies to make the sound more dynamic.	▶ (ON; 1/2/3 levels) ◀ (OFF)	Set Cancel	2
TREBLE	Adjusts high frequencies to make the sound sharper.	▶ (ON; 1/2/3 levels) ◀ (OFF)	Set Cancel	OFF
VOLUME LIMIT	Sets a limit to how high the volume can go.	▶ (ON) ◀ (OFF)	Set Cancel	ON
VOLUME	Adjusts the volume level. Can also be adjusted on the normal screen.	▶ ◀	Higher Lower	8th bar on the scale
SAVE•LOAD	SAVE: Registers the desired audio/video settings. LOAD: Calls up the registered audio/video settings.	Press or ▶	—	—

Resetting (For canceling all the registered settings)

While keeping the Multi Control button pressed down, press the POWER switch for more than 5 seconds. When the power is turned on again, all the settings will return to the initial factory settings.

The Language selection menu will again be accessible and the password will return to 0, 0, 0. Refer to "REGISTERING, CHANGING OR CANCELING THE PASSWORD" on pg. 26.

SAVING, LOADING AND CANCELING THE AUDIO/VIDEO SETTINGS

You can save your desired audio/video settings.

SAVING

1 Select SAVE•LOAD in the Menu screen.

When you complete your audio/video settings, move the Multi Control button up/down to select SAVE•LOAD, then press it or move it to the right (▶) to complete the setting.

On-Screen Display

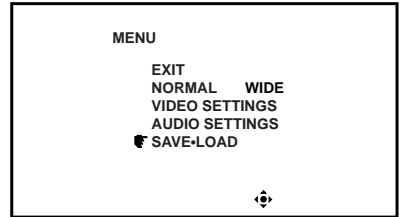

2 Select SAVE.

1. Move the Multi Control button up/down (▲,▼) to select SAVE, then press it or move it to the right (▶) to complete the setting.
2. The word SAVE on the screen blinks and the audio/video settings you have set are saved.
 - VOLUME LIMIT and VOLUME cannot be saved.
 - Select EXIT to return to the Menu screen.
 - The new settings are saved over the previous ones.

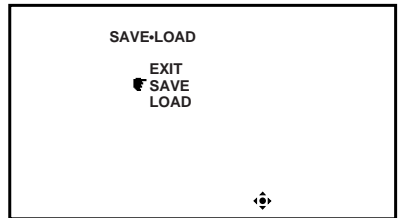

LOADING

1 Select SAVE•LOAD in the Menu screen.

2 Select LOAD.

1. Move the Multi Control button up/down (▲,▼) to select LOAD, then press it or move it to the right (▶) to complete the setting.
2. The word LOAD on the screen blinks and the image is displayed with the loaded audio/video settings.

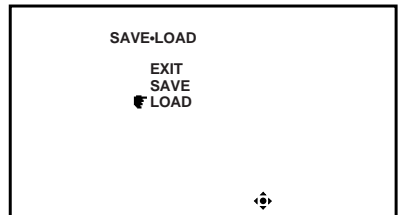

WATCHING VIDEO (Cont.)

REGISTERING, CHANGING OR CANCELING THE PASSWORD

- You can register a 3-digit password to prevent unauthorized use of this display unit.
- If you forget the password, register a new one.
You can cancel the password registration if you do not wish to use this feature.
- The password is preset to “ 0. 0. 0 ” at the factory.

REGISTERING/CHANGING THE PASSWORD

1 Retrieve the password registration screen.

1. When the power is on, press the POWER switch for more than 5 seconds.
The power shuts off.
2. Press the POWER switch again.
After a warning is displayed, the password registration screen appears.

On-Screen Display



- #### 2
- Move the Multi Control button up/down (▲, ▼) to select YES, then press it.
The password entry screen appears.

3 Enter a password.

1. Move the Multi Control button up/down (▲, ▼) to select 3 numbers, then press it.
The password confirmation screen appears.
2. Enter the same password again.
 - If you fail to re-enter the password, the password will not be registered and you will have to start over from the password registration screen.
The power will automatically turn off if you fail to enter the correct password 3 times in a row.
 - If no operation is done for 1 minute, the power will shut off automatically.

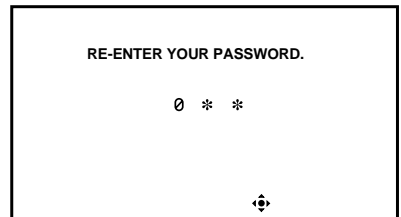

CANCELING THE PASSWORD

1 Retrieve the password registration screen.

(See step 1 in “REGISTERING/CHANGING THE PASSWORD”.)

- #### 2
- Move the Multi Control button up/down (▲, ▼) to select NO, then press it.

WHEN YOU ARE FINISHED

Follow the steps below to turn off the power after use.

1. Remove the headphones from your ears.
2. Remove the display unit from your face.
3. Turn off the control unit.
4. Turn off the video component.

Health warning

A health warning appears approx. 2 hours 30 minutes after the unit is turned on, as shown on the right. The warning will be displayed until the Multi Control button is pressed. After an additional 5 minutes, another warning will be displayed and the power will shut off automatically.

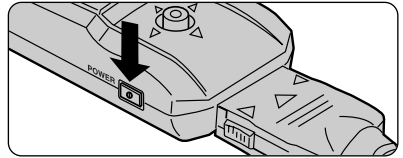

Health Warning

2 HRS. 30 MIN. HAVE ELAPSED.
FOR THE HEALTH OF YOUR EYES AND BODY, STOP VIEWING AND REST. IF YOU CONTINUE VIEWING, POWER WILL SHUT OFF IN 5 MIN. AFTER READING THE ABOVE, PRESS \downarrow .

After 5 minutes

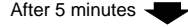

2.5 HOURS HAVE PASSED.
PLEASE STOP WATCHING AND REST FOR A WHILE.
IT WILL AUTOMATICALLY TURN OFF IN A MOMENT.

Product Care

- To clean the display unit, wipe with a soft, dry cloth. If this does not clean the unit to your satisfaction, you can moisten the cloth with a solution of neutral detergent. Do not use chemicals such as thinner, benzene and alcohol. If these chemicals are applied to the windows of the display unit, it may cause them to cloud over.
- Do not wrap the display cable around the display unit or control unit, or apply excessive force to the display cable, so as not to break the wire inside the cable.
- Protect the display unit frame from contact with hair liquids, cosmetic products or other chemicals. If any gets on the frame, wipe it with a soft cloth moistened with a solution of neutral detergent. If the frame is left with these types of chemicals on it, it may cause cracks in the surface.

CHANGING THE FRAMES

- Perform the following steps if a frame is broken and must be replaced.
- If you cannot wear the display unit securely even after increasing or decreasing the space between the frame arms using the frame adjusters, try switching the left and right frame arms following the steps below and adjust the space again.

Notes

- To keep the windows of the display unit free of fingerprints, do not touch the windows when changing the frames.
- Remove the display section from the frame only when necessary (such as when the unit is damaged). Repeated removal and installation may result in loosening of the frame joints.

Removing the frames

1 Detach the frame adjusters.

1. Remove the headphone from the headphone holder.
2. Slide the frame adjuster to position **C** in the direction of the headphone. Pull the adjuster out to detach.
3. Detach the other adjuster following the same procedures.

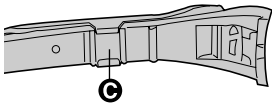

Frame [Left],
Adjuster [Inside]

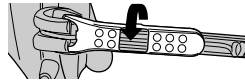

Frame [Left],
Adjuster [Outside]

2 Remove the frames.

1. Hold the frame so that the window part can be seen.
2. Fold the frame to align **A** (convex) of the frame with **B** (concave) of the unit.
3. While keeping **A** and **B** in the above position, slide the frame inward horizontally by approx. 1 mm.
4. To remove the right frame, twist it downward, and to remove the left, twist the frame upward. When pulling the frames out, do not grasp the headphone cable.

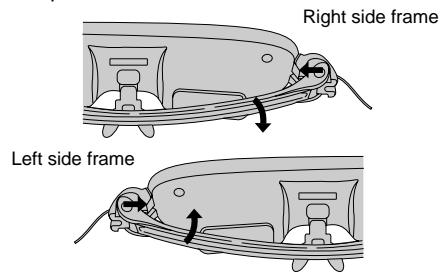
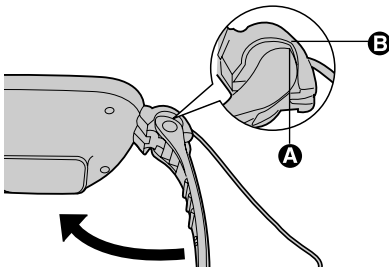

Attaching the frames

1. Push the frame into the display unit while matching shapes **A** (convex) of the frame and **B** (concave) of the unit.
2. Place the headphone cord into the frame's groove.
3. Attach the frame adjuster back to position **C** on the frame.

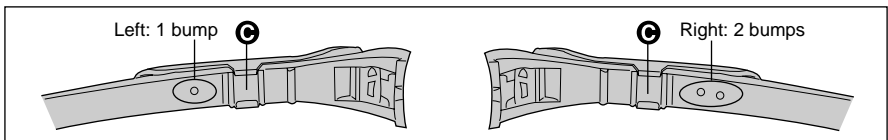

- The frame with 1 bump is attached to the left side, and the frame with 2 bumps is attached to the right side at the factory, as shown above.

SPECIFICATIONS

Product

Type	: Personal LCD Display
Product name	: Eye-Trek
Model name	: FMD-250 W

Power Supply Ratings

AC adapter (provided)	: AC 100 to 240 V, 50/60 Hz
Power consumption	: Approx. 2.2 W

Video

Video signal	: NTSC format
Video display devices	: TFT LCD panel
Effective number of pixels	: 240,000 pixels
Angle of view	: 37.5 degrees horizontal, 21.7 degrees vertical

Input Jacks

Audio/Video/Power input jack	: Exclusive Multi-connector Composite video signal: 1 Vp-p/75 Ω (unbalanced) Separate Y video signal: 0.75 Vp-p/75 Ω (unbalanced) Separate C video signal: 300 mVp-p/75 Ω (unbalanced) Stereo audio signal: 200 mVrms Power supply: Rated 7.5 V DC
------------------------------	--

Ambient Temperatures

Operation	: 5° to 35°C
Storage	: -20° to 60°C

Dimensions

Display unit	: Approx. 132 (W) x 50 (H) x 30 (D) mm (not including display cable and frames) : Approx. 161 (W) x 63.5 (H) x 50 (D) mm (not including display cable/when the frames are folded)
Control unit	: Approx. 39 (W) x 19.5 (H) x 100 (D) mm (not including display cable and bumps)

Weight

Display unit	: Approx. 95 g (not including cables)
Control unit	: Approx. 38 g (not including cables)

Design and specifications are subject to change without notice.

TROUBLESHOOTING

Symptom	Possible Cause	Solution	Ref. Page
The image is not displayed.	Connections are incorrect.	Connect the video cables properly.	pg. 13-14
	A video signal is not input or the power is not on.	Turn on the power of the video component and play back video.	pg. 17,19
The image is not clear.	The display unit is being worn improperly.	Adjust the position with the nose pad and frame adjuster.	pg. 15-16
	Video settings (CONTRAST, TINT, etc.) are adjusted improperly.	Adjust video settings properly with the Multi Control button .	pg. 21-22 pg. 24
The image disappears suddenly.	About 2-1/2 hours have elapsed since the power was turned on (power turns off automatically).	Rest your eyes. Set the POWER switch to ON when you want to use again.	pg. 6 pg. 27
A black, white, red, green or blue dot is observed on the screen.	The LCD screens are manufactured to precise specifications, but colored dots may be observed. This is not a malfunction.		pg. 10
A striped pattern is observed on the image.	This is due to the built-in optical filter which smoothes the image and is not a malfunction.		pg. 10
Audio is not heard.	The volume is too low.	Adjust the VOLUME.	pg. 21,23
	The AV cable is not connected.	Connect the AV cable.	pg. 13-14
You forgot your password.	—	Re-register the password.	pg. 26
You want to change the language on the display.	—	Follow the reset instructions.	pg. 24

REPAIR SERVICE

The warranty period of this unit is one year from the date of purchase. Within this period, Olympus will repair this unit free of charge. However, this warranty may not cover damage caused by user mishandling, even if it occurs during the warranty period. If repairs are required after the warranty period has ended, please contact the dealer from whom you purchased the unit or Olympus.

MEMO

Free Manuals Download Website

<http://myh66.com>

<http://usermanuals.us>

<http://www.somanuals.com>

<http://www.4manuals.cc>

<http://www.manual-lib.com>

<http://www.404manual.com>

<http://www.luxmanual.com>

<http://aubethermostatmanual.com>

Golf course search by state

<http://golfingnear.com>

Email search by domain

<http://emailbydomain.com>

Auto manuals search

<http://auto.somanuals.com>

TV manuals search

<http://tv.somanuals.com>