

OMEGAPHONE®
OMA-P1104
User's Manual

IMPORTANT SAFETY INSTRUCTIONS

Your OMA-P1104 has been carefully designed to give you years of safe, reliable performance. As with all electrical equipment, however, there are a few basic precautions you should take to avoid hurting yourself or damaging the unit:

- Read the installation and operating instructions in this manual carefully. Be sure to save it for future reference.
- Read and follow all warning and instruction labels on the product itself.
- To protect the OMA-P1104 from overheating, make sure all openings on the unit are not blocked. Do not place on or near a heat source, such as a radiator or heat register.
- Do not use your OMA-P1104 near water, or spill liquid of any kind into it.
- Be certain that your power source matches the rating listed on the AC power transformer. If you're not sure of the type of power supply to your facility, consult your dealer or local power company.
- Do not allow anything to rest on the power cord. Do not locate this product where the cord will be abused by persons walking on it.
- Do not overload wall outlets and extension cords, as this can result in the risk of fire or electric shock.
- Never push objects of any kind into this product through ventilation holes as they may touch dangerous voltage points or short out parts that could result in a risk of fire or electric shock.
- To reduce the risk of electric shock, do not disassemble this product, but return it to Omega Customer Service, or other approved repair facility, when any service or repair work is required. Opening or removing covers may expose you to dangerous voltages or other risks. Incorrect reassembly can cause electric shock when the unit is subsequently used.

- If anything happens that indicates that your OMA-P1104 is not working properly or has been damaged, unplug it immediately and follow the procedures in Appendix C for having it serviced. Return the unit for servicing under the following conditions:
 1. The power cord or plug is frayed or damaged.
 2. Liquid has been spilled into the product or it has been exposed to water.
 3. The unit has been dropped, or the cabinet is damaged.
 4. The unit doesn't function normally when you're following the operating instructions.
- Avoid using a telephone (other than a cordless type) during an electrical storm. There may be a remote risk of electric shock from lightning.
- Do not use the telephone to report a gas leak in the vicinity of the leak.

CAUTION

To Reduce the Risk of Fire or Injury to Persons, Read and Follow these Instructions:

1. Use only the following type and size batteries:
Alkaline, size D.
2. Do not dispose of the batteries in a fire. The cell may explode. Check with local codes for possible special disposal instructions.
3. Do not open or mutilate the batteries. Released electrolyte is corrosive and may cause damage to the eyes or skin. It may be toxic if swallowed.
4. Exercise care in handling batteries in order not to short the battery with conducting materials such as rings, bracelets, and keys. The battery or conductor may overheat and cause burns.
5. Do not mix old and new batteries in this product.

FCC Requirements

Part 68: The OMEGAPHONE® OMA-P1104 complies with Part 68 of the FCC rules. On the back of the unit there is a label that contains, among other information, the FCC Registration Number and the Ringer Equivalence Number (REN) for this equipment. You must, upon request, provide this information to your local telephone company.

The REN is useful to determine the quantity of devices that you may connect to your telephone line and still have all of those devices ring when your telephone number is called. In most, but not all areas, the sum of the REN's of all devices connected to one line should not exceed five (5.0). To be certain of the number of devices that you may connect to your line, you may want to contact your local telephone company to determine the maximum REN for your calling area.

This equipment may not be used on coin service provided by the telephone company. Connection to party lines is subject to state tariffs.

Should the OMA-P1104 cause harm to the telephone network, the telephone company may discontinue your service temporarily. If possible, they will notify you in advance. But if advance notice isn't practical, the telephone company may temporarily discontinue service without notice and you will be notified as soon as possible. You will be informed of your right to file a complaint with the FCC. The telephone company may make changes in its facilities, equipment, operations, or procedures where such action is reasonably required in the operation of its business and is not inconsistent with the rules and regulations of the FCC that could affect the proper functioning of your equipment. If they do, you will be notified in advance to give you an opportunity to maintain uninterrupted telephone service.

If you experience trouble with this equipment, or you need information on obtaining service or repairs, please contact:

OMEGA Customer Service
1-800-622-2378 (1-800-622-BEST)

The telephone company may ask that you disconnect this equipment from the network until the problem has been corrected or until you are sure that the equipment is not malfunctioning.

Part 15: This equipment has been tested and found to comply with the limits for a Class B digital device, pursuant to Part 15 of the FCC Rules. These limits are designed to provide reasonable protection against harmful interference in a residential installation. This equipment generates, uses and can radiate radio frequency energy and, if not installed and used in accordance with the instructions, may cause harmful interference to radio communications. However, there is no guarantee that interference will not occur in a particular installation. If this equipment does cause harmful interference to radio or television reception, which can be determined by turning the equipment off and on, the user is encouraged to try to correct the interference by one or more of the following measures:

- Reorient or relocate the receiving antenna.
- Increase the separation between the equipment and the receiver.
- Connect the equipment into an outlet on a circuit different from that to which the receiver is connected.
- Consult the dealer or an experienced radio/television technician for help.

OMEGAPHONE® is a registered trademark of Omega

Touch Tone™ is a registered trademark of AT&T.

Canadian Department of Communications Statement

Notice: The Canadian Department of Communications label identifies certified equipment. This certification means that the equipment meets certain telecommunications network protective operational and safety requirements. The Department does not guarantee the equipment will operate to the user's satisfaction.

Before installing this equipment, users should ensure that it is permissible to be connected to the facilities of the local telecommunications company. The equipment must also be installed using an acceptable method of connection. In some cases, where the company's inside wiring is associated with a single line, individual service may be extended by means of a certified connector assembly (telephone extension cord). The customer should be aware that compliance with the above conditions may not prevent degradation of service in some situations.

Repairs to certified equipment should be made by an authorized Canadian maintenance facility designated by the supplier. Any repairs or alterations made by the user to this equipment, or equipment malfunctions, may give the telecommunications company cause to request the user to disconnect the equipment.

Users should ensure for their own protection that the electrical ground connections of the power utility telephone lines and internal metallic water pipe system, if present, are connected together. This precaution may be particularly important in rural areas.

CAUTION: Users should not attempt to make such connections themselves, but should contact the appropriate electric inspection authority, or electrician, as appropriate.

The Load Number (LN) assigned to each terminal device denotes the percentage of the total load to be connected to a telephone loop which is used by the device to prevent overloading. The termination on loop may consist of any combination of devices subject only to the requirement that the total of the Load Numbers of all the devices does not exceed 100. For the Omegaphone® OMA-P1104, the Load Number is 8.

Omegaphone® OMA-P1104 User's Manual

Table of Contents

IMPORTANT SAFETY INSTRUCTIONS	i
FCC Requirements	iii
Canadian Department of Communications Statement ...	v
Chapter 1: Introduction	1
Technical Support	2
Chapter 2: Installation	3
2.1 Operating Environment.....	3
2.2 Mounting	3
2.3 Power Surge Protection	4
2.4 Power Supply and Battery Backup	4
2.5 Starting the OMA-P1104	5
2.6 Run Mode and Standby Mode	5
2.7 Telephone Line	6
2.8 The Microphone	7
2.9 Alert Inputs	8
2.10 Installing the Sensor	9
2.11 Multiple Sensors	11
2.12 Outdoor Wiring	12
2.13 Disconnecting for Storage or Seasonal Use. ..	13
Chapter 3: Quick Start	15
3.1 The Local Keypad	15
3.2 Preparation for Programming	16
3.3 Quick-Start Programming Steps	
Step 1: Set Configuration of Inputs	16
Step 2: Set the ID Number	17

Step 3: Set Dial-Out Telephone Numbers 18

Step 4: Set Temperature Limits 19

3.4 Summary of the Alarm Dial-Out Process .. 21

Chapter 4: Communications Programming 23

4.1 The Unit ID Number 23

4.1.1 Programming the ID Number 24

4.1.2 Interrogating the ID Number 24

4.2 Dial-out Telephone Numbers 25

4.2.1 Programming Dial-out Telephone Numbers 25

4.2.2 Interrogating a Dial-out Telephone Number 26

4.2.3 Erasing a Telephone Number 26

4.3 Tone or Pulse Dialing 27

4.4 Special Dialing 27

4.4.1 Special Dialing Keys 28

4.4.2 Incorporating a Pause 29

4.4.3 Incorporating a Pound (#) or Asterisk (*) 30

4.4.4 Special Dialing to a Beeper or Pager 31

4.5 Rings Until Answer 33

4.5.1 Programming Rings Until Answer 33

4.5.2 Interrogating Rings Until Answer 34

4.6 TAD (Telephone Answering Device)..... 34

4.6.1 TAD Enable/Disable 35

4.6.2 Using the TAD Feature 35

4.6.3 No TAD In Use 36

4.7 Listen-in Time 36

4.7.1 Programming the Listen-in Time 37

4.7.2 Interrogating the Listen-in Time 38

4.8 Call Delay 38

4.8.1	Programming the Call Delay	38
4.8.2	Interrogating Call Delay	39
4.9	Local Voice Mute	40
4.9.1	Enable/Disable Local Voice Mute	40
4.10	Voice Repetitions	40
4.10.1	Programming Voice Repetitions	41
4.10.2	Interrogating Voice Repetitions	41
4.11	Intercall Time	42
4.11.1	Programming Intercall Time	42
4.11.2	Interrogating Intercall Time	43
4.12	Maximum Number of Calls (Max Calls)	43
4.12.1	Programming Max Calls	44
4.12.2	Interrogating Max Calls	45
4.13	The Clock	45
4.13.1	Setting the Clock	45
4.13.2	Interrogating for the Current Time	46
4.14	The Security Code	47
4.14.1	Locking the Keypad	47
4.14.2	Unlocking the Keypad	48
Chapter 5:	Alarm Programming	49
5.1	Input Configuration	49
5.1.1	Programming Input Configuration	50
5.1.2	Verifying Input Configuration	51
5.2	Enable/Disable Inputs	51
5.2.1	Changing Enabled/Disabled Input Status	51
5.2.2	Verifying Enabled/Disabled Input Status	52
5.3	Input Recognition Time	52
5.3.1	Programming Input Recognition Time	53

- 5.3.2 Interrogating Input Recognition Time 54
- 5.4 Establishing High and Low Temperature Limits .. 54**
 - 5.4.1 Programming Temperature Limits for a Selected Input 55
 - 5.4.2 Disabling Alarm Response to High or Low Temperature 56
 - 5.4.3 Interrogating High and Low Temperature Limits.. 57
- 5.5 Temperature Scale 57**
- 5.6 Temperature Calibration 58**
 - 5.6.1 Programming Temperature Calibration 58
 - 5.6.2 Interrogating Temperature Calibration 59
- 5.7 Obtaining Current Temperature 59**
- 5.8 AC Power Monitoring Enable/Disable 60**
 - 5.8.1 Enabling/Disabling the AC Power Alarm 60
- 5.9 AC Power Failure Recognition Time 61**
 - 5.9.1 Programming Power Failure Recognition Time ... 61
 - 5.9.2 Interrogating Power Failure Recognition Time 62
- 5.10 Sound Alarm Monitoring 63**
 - 5.10.1 Programming Sound Alarm Sensitivity 63
 - 5.10.2 Interrogating Sound Sensitivity 64
 - 5.10.3 Programming High Sound Alarm Recognition Time 64
- 5.11 High Sound Alarm Enable/Disable 65**
 - 5.11.1 Changing Enabled/Disabled High Sound Alarm 66
- 5.12 Exit Delay 66**
- Chapter 6: Acknowledgment, Status Report, and Remote Access 69**
 - 6.1 Alarm Acknowledgment 69**
 - 6.1.1 Local Acknowledgment 69

6.1.2 Touch-Tone™ Acknowledgment	69
6.1.3 Callback Acknowledgment	70
6.2 Status Report	71
6.2.1 Example: Status Report, No Alarms	72
6.2.2 Example: Status Report, Existing Alarms	73
6.2.3 Example: Status Report, Disabled Inputs	74
6.2.4 Battery Condition	75
6.2.5 Remote Access by Touch-Tone™ Telephone	75
Appendix A: Troubleshooting	79
Appendix B: Accessories	87

Omegaphone® OMA-P1104 User's Manual

Chapter 1: Introduction

The OMEGAPHONE® OMA-P1104 is a fully-programmable, environmental monitoring system that offers extensive on-site and remote monitoring capability to small businesses, private homes, farms, greenhouses, computer rooms, and remote facilities. Designed for desktop or wall mounting, the OMA-P1104 is simple to install, program and operate; no changes to standard electrical or telephone service are required. Connected to a telephone line, it will respond to an alarm by dialing up to four separate telephone numbers. When the call is answered, an “*Alert Condition*” message is delivered in digitized speech.

The OMA-P1104 features built-in sensors to monitor a variety of conditions:

- High sound level
- AC electric power failure
- Battery backup
- Temperature

Equipped with 4 alert inputs, additional sensors* can be added for extended monitoring:

- Intrusion or unauthorized entry
- Water leaks and seepage
- Temperature
- Humidity
- Equipment operation
- Many other conditions that may require unique monitoring solutions

* Refer to Appendix B for information on additional sensors (available separately from Omega) that are best suited to your application.

The status of each monitored condition is readily obtained at the unit's installation site or remotely, by telephone. At the close of every Status Report, time is provided for listening to on-site sounds.

To ensure reliable operation, the OMA-P1104 features power backup capability; in the event of AC power failure, six D-cell batteries (not included) will continue to power the unit for approximately 10 hours.

This manual is comprised of the instructions and commands for installing and operating the OMA-P1104. The Quick Start chapter is included to speed understanding of programming and operation. Communication and Alarm Programming chapters demonstrate step-by-step methods for utilizing the full range of available features. The Troubleshooting chapter provides assistance in the event that problems are encountered.

Technical Support

If any questions arise upon installation or operation of the OMA-P1104, please contact Omega Engineering Data Acquisition Group.

Chapter 2: Installation

Correctly installing the OMA-P1104 will ensure proper functioning of the unit. Please read the entire chapter before starting the installation process.

Within the packaging will be a Warranty Registration Card. Please take the time to fill this out and mail. The One Year Limited Warranty is explained in the back of this manual.

2.1 Operating Environment

The OMA-P1104 should be installed and operated in an area that provides space for wiring sensors to the screw terminals, near an AC power source and telephone line. Operating temperature ranges from 32° Fahrenheit (0° Celsius) to +120° Fahrenheit (+49° Celsius).

NOTE

The OMA-P1104 is a sensitive electronic device. Do not install the OMA-P1104 near strong electrostatic, electromagnetic or radioactive fields. Do not expose to fumes or corrosive vapors.

2.2 Mounting

Flat Mount: Place the OMA-P1104 on top of a desk or other horizontal surface. Wall Mount: Mount on a wall with two screws using the keyholes on the back panel of the unit. Place the screws or bolts $3\frac{13}{16}$ " apart at the desired height from the floor. Hook the unit over the screws and toward the floor. Refer to Figure 2-1.

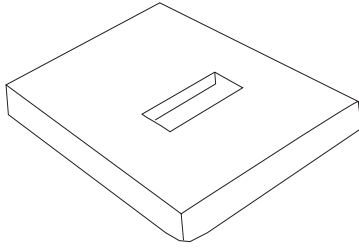

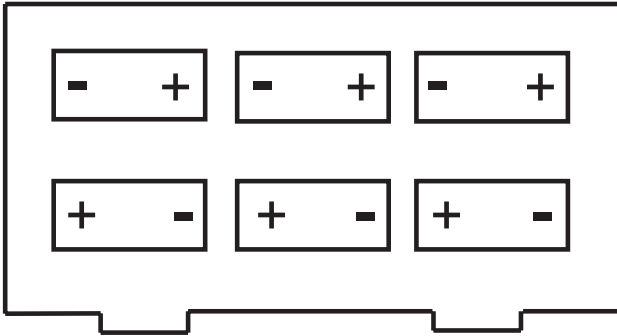

Figure 2-2. Battery Installation

2.5 Starting the OMA-P1104

When the AC power transformer is first plugged into the electrical outlet, the OMA-P1104 automatically starts in RUN mode. The red LED light will begin to glow. The unit will respond with, *“Hello, this is Sensaphone® 1104.”*

2.6 Run Mode and Standby Mode

Pressing the RUN/STANDBY key on the OMA-P1104 keypad will alternately activate or deactivate the unit. If the unit is activated and in RUN mode, the red LED (small red light on the upper right of the unit's front panel) glows steadily. In STANDBY mode, the red LED goes out, but will blink every few seconds to indicate that power is still supplied to the unit.

In RUN mode, the OMA-P1104 is able to receive incoming calls and to automatically dial out in the event of an alarm on one of the monitored conditions. To enter STANDBY mode, press RUN/STANDBY.

As soon as the OMA-P1104 enters STANDBY mode, it responds with *“Have a good day.”* The red light immediately goes out and then resumes with a blink every few seconds. While in STANDBY mode, all functions are disabled, but

programmed memory is preserved. Upon exiting STANDBY mode, any currently existing alert conditions will be announced.

NOTE

STANDBY mode is not equivalent to “power off”—an electrical source, such as the 120 VAC, or the battery backup, continues to provide full power to the unit. If the unit is placed in STANDBY mode, unplugged from the 120 VAC outlet, and placed in storage, the batteries will continue to power the OMA-P1104, discharging until they fail. Consequently, batteries should always be removed from the unit following disconnection from any 120 VAC outlet, prior to storage.

Press the RUN/STANDBY key again to return to RUN mode.



Figure 2-3. The RUN/STANDBY Key

2.7 Telephone Line

The OMA-P1104 will operate with all standard telephone systems that accept pulse or tone dialing. The OMA-P1104 cannot be used on an extension line to dial its own telephone number. Also, it may not be installed on a party line or pay telephone line.

Certain private telephone systems and public switching equipment may not accept the OMA-P1104 dialing or may generate an unacceptable ring signal. In those cases, a dedicated line may be required. Consult the supplier of your telephone system if you encounter problems.

If you do not have a modular telephone extension at the OMA-P1104's location, you must contact your local telephone company to have one installed (there is a charge for this

service). If you have four-pin jacks, adapters are available to convert them to the modular plugs. Contact your local telephone company or electronics parts store.

CAUTION

Never install telephone wiring during a lightning storm. Never install telephone jacks in wet locations unless the jack is specifically designed for wet locations. Never touch uninsulated telephone wires or terminals unless the telephone line has been disconnected at the network interface. Use caution when installing or modifying telephone lines.

To install the telephone line, plug the modular telephone jack provided into any standard RJ11 phone outlet. Refer to Figure 2-4.

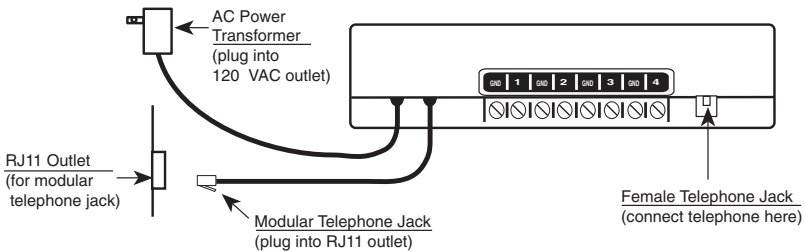

Figure 2-4. Installing the Telephone Line

On the back of the OMA-P1104 is a female telephone jack. This is provided so that a telephone or other answering device may be used on the same line as the unit. It is not necessary to hook up a telephone for the OMA-P1104 to operate.

2.8 The Microphone

The OMA-P1104 is provided with a built-in microphone which is used to monitor high sound levels produced near the installation site. The sensitivity of the microphone is configurable and will detect a continuous as well as a beeping alarm.

Other programming options that apply to the microphone include setting the length of time before a high sound causes an

alarm.

If this sound level exists for 8 consecutive seconds (default) or for the programmed length of time, the OMA-P1104 will dial out with an alarm message.

NOTE

The proximity of the audible alarm to the microphone is extremely important. Normally, the OMA-P1104 and the audible alarm must be in the same room. The maximum distance can vary considerably depending on the alarm, the acoustics, and the size of the room.

During an alarm dial-out, the microphone allows four-second intervals to listen-in to sounds at the OMA-P1104's location.

When calling for a Status Report, the microphone permits listening to on-site sounds for a programmed time interval.

2.9 Alert Inputs

The OMA-P1104 can monitor up to 4 inputs (represented by the numbered terminal screws shown in Figure 2-5, below).



Figure 2-5. Alert Inputs

Inputs are configured as either dry contact or temperature. An input configured as dry contact can be used with any normally open (N.O.) or normally closed (N.C.) device.

“Open” refers to an opened circuit path; if conditions cause the circuit to close, an alert condition occurs. “Closed” refers to a continuous circuit path; if a closed circuit is opened, an alert condition occurs. The OMA-P1104 determines the way inputs are configured by the type of sensor connected to each alert input (refer to Chapter 5, Section 5.1).

An input configured as “temperature” is designed to evaluate a range of settings. The OMA-P1104 will read the temperature at the sensor’s location and compare that value to programmed high and low temperature limits. Temperature inputs *must* be used with Phonetics Remote Temperature Sensor.

NOTE

Before wiring, it is advisable to disable the inputs to prevent accidentally tripping an alarm. See Chapter 5, Section 5.2.

2.10 Installing the Sensor

After you have selected the sensor, loosen the screw of the alert input and its corresponding ground. Two wire leads are used to connect any monitoring sensor. Fasten one lead to the numbered screw and the other lead to GND. Tighten both screws. If the input was not disabled, the OMA-P1104 may recite its *“Alert Condition Exists”* message as you connect the sensor. If it does, just press any key to stop it. Re-enable the input after wiring. Refer to Figures 2-6 and 2-7 for connecting a sensor to an alert input.



Figure 2-7. Two Sensors Wired to Adjacent Inputs

NOTE

Do not use sensors, switches, or relays that supply any voltage or current to the OMA-P1104. Be aware of proximity to other electrical wires or components when placing wires that lead from the sensors to the unit. Avoid running the wires near electrical devices that use high voltage or current, such as motors, heavy machinery, etc. This voltage may be inductively coupled into the sensor wiring and could result in damage to the the OMA-P1104's circuitry. Try to place wires at least 6 inches from other electrical wiring or devices.

2.11 Multiple Sensors

The OMA-P1104 may have more than one sensor connected to the same alert input, as long as the normal condition for each sensor on the same alert input is identical (either all N.O. or all N.C.). However, only one remote temperature sensor can be used on each input.

When wiring several normally closed sensors on one input, they must be connected in series. Connect one lead from the first sensor to the numbered screw of the alert input. Next, take the other lead from the first sensor and connect it to one lead from the next sensor. Continue connecting sensors end-to-end until you have connected all of your sensors. Take the second lead from the last sensor and connect it to the ground screw on the OMA-P1104. See Figure 2-8. Multiple N.C. sensors are typically magnetic reed switches to monitor the security of windows and doors.

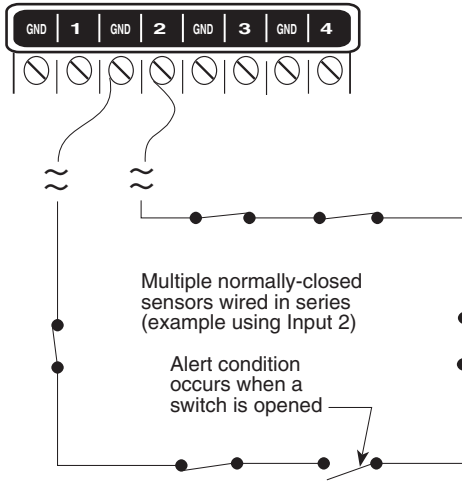

Figure 2-8. Multiple Normally Closed Sensors

To wire several normally open sensors to one alert input, connect them in parallel. To do this, take one lead from each sensor and attach it to the numbered terminal. Then, take the second lead from each sensor and attach each to the corresponding ground screw. Refer to Figure 2-9.

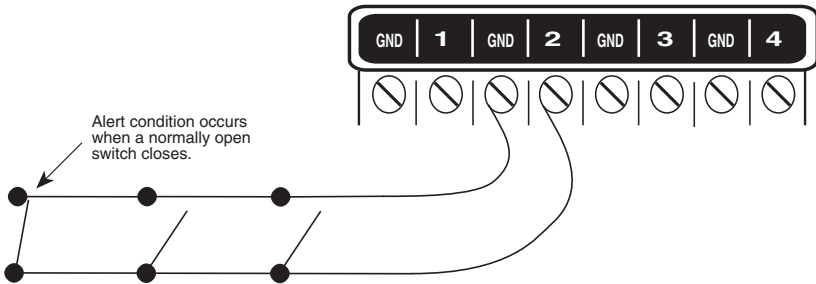

Figure 2-9. Multiple Normally Open Sensors

2.12 Outdoor OMA-P1104g

When wiring sensors outdoors, **DO NOT** allow exposed wires

to run freely in open air; under such conditions, the OMA-P1104 is susceptible to serious damage during a lightning storm. Depending upon the distance outdoor wiring must travel, consideration should be given to use of shielded wire inside a metal conduit. Both shield and conduit should be connected to earth ground. This prevents stray voltage from entering the unit.

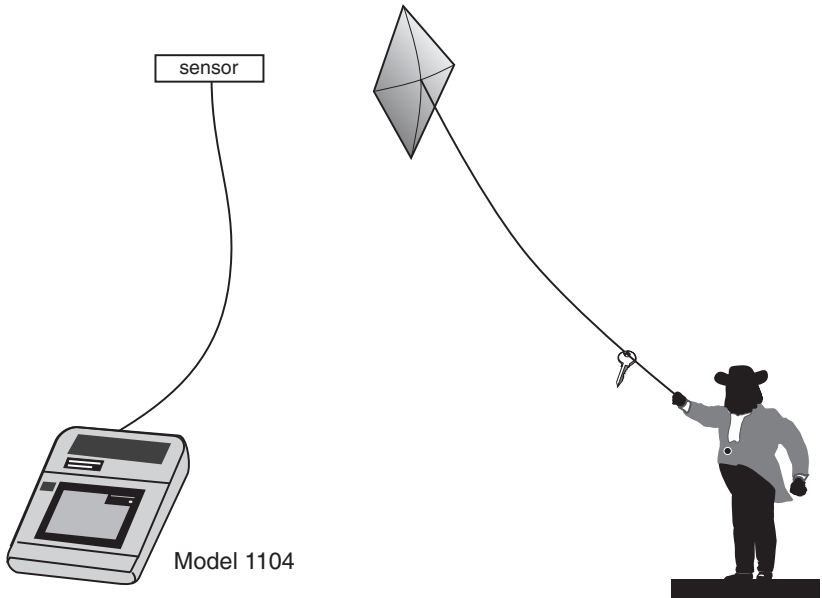

Figure 2-10. Potential Sensor Damage from Stray Electrical Noise

2.13 Disconnecting the OMA-P1104 for Storage or Seasonal Use.

If you plan to employ the OMA-P1104 as a seasonal “watch-dog” for a few months during the year, **you must disconnect all wires from the unit completely to avoid damage to the circuitry when the unit is not in use**. If the unit is unplugged but left in place with all the sensors still connected, the wires act as antennae that draw in any stray “electrical noise” from such devices as fans, blowers, microwaves, etc.

Additionally, it is important to remove the batteries, or they will discharge until they fail.

Preserve your OMA-P1104 during the off-season, or when not in use:

- Remove the sensor wires at the screw terminals

NOTES

Chapter 3: Quick Start

This section presents a useful guide for first-time programming of the OMA-P1104. Follow instructions for installation before attempting to program the OMA-P1104. Refer to Chapter 2: Installation.

3.1 The Local Keypad

Programming is accomplished using the local keypad (shown below, Figure 3-1). Notice that a single key has several functions assigned to it; *programming results are determined by the order in which keys are pressed.*

Individual keystrokes are illustrated to show programming steps in the correct order. If you make a mistake by entering the wrong key, do not press another key until you hear the message, "Error 1." Then, start over with the first key in the programming sequence.

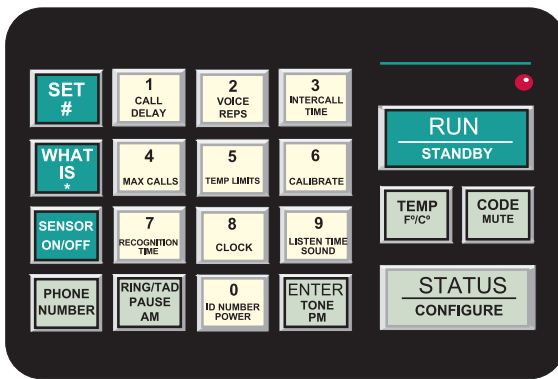

Figure 3-1. The OMA-P1104 Keypad

3.2 Preparation for Programming

Read complete instructions in Chapter 2: Installation, and make sure to follow these steps first:

1. Plug the AC adaptor into the 120 VAC outlet.
2. Install the batteries.
3. Connect the OMA-P1104 to a telephone line.

When these steps are completed, the OMA-P1104 is fully operational and able to monitor temperature, high sound, AC power failure and battery backup condition; it can also be called on the telephone for a Status Report or used for listening to on-site sounds from any remote location. Now, the unit is ready for programming.

3.3 Quick-Start Programming Steps

Step 1: Set Configuration of Inputs

The OMA-P1104 will scan the 4 external inputs and determine if they are N.O. (normally open), N.C. (normally closed), or Temperature. If external sensors are added, make sure they are in their *normal* positions before proceeding—refer to Chapter 5, Section 5.1.

1. Press STANDBY to place the OMA-P1104 in Standby mode.



2. If you have external sensors available, wire the sensors to the inputs on the back of the OMA-P1104 (see Chapter 2, Section 2.10). Otherwise, skip this step and move to step 3.
3. Press RUN. The red light glows when the OMA-P1104 returns to Run mode.



4. Press SET.



5. Press CONFIGURE.



6. The OMA-P1104 will audibly recite the new configuration for each of the four inputs, responding with "OK," if it detects N.O. (normally open), "beep-OK," if it detects N.C (normally closed) or "Temperature," if it detects temperature (regardless of whether all the inputs have attached sensors or not). If an input is unused, it is treated as normally open.

Step 2: Set the ID Number

It is recommended that you set the ID number to reflect the telephone number on which the OMA-P1104 is installed.

1. Press SET.



2. Press ID NUMBER.

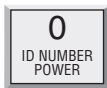

3. Using the number keys, enter the digits (up to 16 are permitted) for the ID number. The OMA-P1104 will recite the digits as they are pressed.



4. Press ENTER. The 1104 will respond: "Enter."



Step 3: Set Dial-Out Telephone Numbers

To program dial-out telephone numbers:

1. Press SET.



2. Press PHONE NUMBER.



3. Select which telephone number to program. Press any unassigned number key (from 1 to 4) to represent the new telephone number entry. OMA-P1104 will respond: "Enter number."



4. Enter the complete telephone number using the number keys. The OMA-P1104 will recite the digits as they are pressed.



5. Press ENTER. The unit will respond: "Enter."



6. Repeat above procedure to program up to four separate telephone numbers.

Step 4: Set Temperature Limits

High and low temperature limits can be separately programmed for each input that is configured as temperature. Limits can range from -20° to $+150^{\circ}$ Fahrenheit, or from -30° to 65° Celsius. Default settings are: 10° F for low temperature and 100° F for high temperature. Do not set temperature limits too close to normal room temperature, since minor fluctuations could result in frequent and unnecessary alarm dialouts.

1. Press SET.



2. Press TEMP LIMITS.

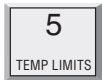

3. From the number keys, press a number (from 1 to 4) that corresponds to the temperature input being programmed.



The OMA-P1104 responds: *“Enter low temperature limit.”*

4. Using the number keys, enter a value for low temperature limit. The OMA-P1104 will recite the digits as they are pressed. If a negative number is required, first press PAUSE, then enter the number.



5. Press ENTER.



The OMA-P1104 responds: *“Enter high temperature limit.”*

- Using the number keys, enter the value for high temperature limit. The OMA-P1104 will recite the digits as they are pressed.



- Press ENTER. The OMA-P1104 responds: *“Enter.”*



This concludes minimum programming to achieve normal operation of the OMA-P1104. In addition to the programming just accomplished, default settings for many more features take effect when the unit is first powered. You will be able to reprogram most of these factory-set defaults to suit your application.

For a complete explanation of each feature (with illustrations of keystrokes), refer to Chapter 4: Communications Programming and Chapter 5: Alarm Programming.

To gain a basic understanding of how the alarm dial-out feature works, refer to this chapter, Section 3-4. For extended information regarding dial-out and related programmable parameters, refer to Chapter 7: Operation.

3.4 Summary of the Alarm Dial-Out Process

Action—Response	Programmable Feature
<p>1. THE OMA-P1104 DETECTS AN ALERT CONDITION</p> <p>An alert condition is not the same as a valid alarm—the condition must continue for the programmed time period, or <i>Recognition Time</i>, before it is recognized as a valid alarm.</p> <p>2. A VALID ALARM IS CONFIRMED</p> <p>An audible, on-site alarm message begins and continues until the alarm is acknowledged. (If the Mute feature is turned on, there is no on-site message.) <i>Call Delay</i> is activated.</p> <p>3. DIAL-OUT BEGINS</p> <p>Dial-out begins by calling telephone number 1 to report an alarm. If there is no acknowledgment, the OMA-P1104 waits the programmed <i>Intercall Time</i> before dialing subsequent telephone numbers. Dial-out continues in this manner, cycling through the remaining telephone numbers, for the programmed <i>Max Calls</i>.</p> <p>4. THE ALARM IS ACKNOWLEDGED</p> <p>When the alarm is acknowledged, the dial-out process is cancelled and the audible, on-site alarm message stops.</p>	<ul style="list-style-type: none"> • Recognition Time <p>This is the programmed waiting period to determine if an alert condition has persisted long enough to be considered a valid alarm. If the sensor returns to normal within recognition time, then no alarm will occur.</p> • Call Delay <p>This is the programmed waiting period, before the first telephone number is called, to report an alarm.</p> • Intercall Time <p>This is the programmed waiting period, in between sequential dialing of telephone numbers, to report an alarm.</p> • Max Calls <p>This is the total number of telephone calls that will be dialed in response to any valid alarm. Telephone numbers are dialed sequentially, and continue to cycle until the maximum number of calls is reached. If no acknowledgment occurs, then at the completion of Max Calls, all alarms are automatically acknowledged.</p>

NOTES

Chapter 4: Communications Programming

This chapter explains the keypad commands for communications programming of the OMA-P1104, including interrogation and resetting of the following:

- The Unit ID Number
- Dial-out Telephone Numbers
- Tone or Pulse Dialing
- Special Dialing with Pagers, Beepers and Access Numbers.
- Rings Until Answer and Telephone Answering Device Compatibility
- Listen-in Time
- Call Delay
- Local Voice Mute
- Voice Repetitions
- Intercall Time
- Maximum Number of Calls
- The Clock
- Security Code

4.1 The Unit ID Number

The Unit ID Number is the identification number of the OMA-P1104. This number may be the same as the telephone number where the unit is installed, or it may be designated using any number that best suits your application.

The purpose of the Unit ID Number is to immediately provide the source of any alarm, especially when using multiple OMA-P1104 units in a complex monitoring system. When the OMA-P1104 is called from a remote location, it always begins its message with the identification number:

“Hello, this is telephone number (Unit ID Number).”

4.1.1 Programming the ID Number

To program the ID Number:

1. Press SET.



2. Press ID NUMBER.

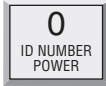

3. Using the number keys, enter up to 16 digits for the ID number. The OMA-P1104 will recite the digits as they are pressed.



4. Press ENTER. The OMA-P1104 will respond: "Enter."



4.1.2 Interrogating the ID Number

To interrogate the ID numbers:

1. Press WHAT IS.



2. Press ID NUMBER. The OMA-P1104 will recite the Unit ID Number programmed.

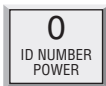

4.2 Dial-out Telephone Numbers

The OMA-P1104 can store up to four 32-digit phone numbers. These are the numbers that will be called during dial-out. In the event of an alarm, the numbers are dialed sequentially, 1 through 4. Begin programming the first telephone number by assigning it to the key labeled with the number 1 on the keypad, and continue to assign any other telephone numbers in numerical order. ***A pause, pound or asterisk can be added*** to an individual phone number to access different phone and beeper systems. See Special Dialing, Section 4.4.

4.2.1 Programming Dial-out Telephone Numbers

To program dial-out telephone numbers:

1. Press SET.



2. Press PHONE NUMBER.



3. Select which telephone number to program. Press any unassigned number key (from 1 to 4) to represent the new telephone number entry. The OMA-P1104 will respond: *"Enter number."*



4. Enter the complete telephone number using the number keys.



5. Press ENTER. The unit will respond with “Enter.”



6. Repeat above procedure to program up to four separate telephone numbers.

4.2.2 Interrogating a Dial-out Telephone Number

To interrogate dial-out telephone numbers:

1. Press WHAT IS.



2. Press PHONE NUMBER.



3. Press a number key (from 1 to 4).



OMA-P1104 will recite the corresponding telephone number. If there is no number programmed for a particular key, the unit will respond: “No number.”

4.2.3 Erasing a Telephone Number

To erase a telephone number:

1. Press SET.



2. Press PHONE NUMBER.



Chapter 4: Communications Programming

3. Press the number key (from 1 to 4) representing the telephone number you want to erase.

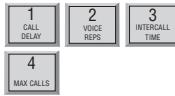

4. Press ENTER. The OMA-P1104 will sa“Enpte.”.

4.4.1 Special Dialing Keys

The following designated keys represent special functions when used with PHONE NUMBER entries:

1. ***Pause***



PAUSE represents a four second pause in dialing. It can be used when an access number is required before dialing to an outside line. (For example, in some cases a "9" or other number, must be dialed first, in order to get a dial tone for an outside line.) When interrogating telephone numbers, PAUSE is audibly represented by a "beep."

2. ***Pound (#)***



A pound may be required when calling some phone or beeper systems. When interrogating telephone numbers, pound (#) is audibly represented by the word "twelve."

3. ***Asterisk (*)***



An asterisk may be required when calling some phone or beeper systems. When interrogating telephone numbers, asterisk (*) is audibly represented by the word "eleven."

4. ***Code***



CODE instructs the OMA-P1104 to wait until the call is answered before continuing. When interrogating telephone numbers, CODE is audibly represented by the word "fourteen."

NOTE

Each time a pause, pound (#) or asterisk (*) is incorporated in a programming sequence, it is counted as one digit toward the total of 32 digits allowed.

4.4.2 Incorporating a Pause

Incorporate PAUSE to access an outside telephone line:

1. Press SET.



2. Press PHONE NUMBER.



3. Press any unassigned number key (from 1 to 4) to represent the new telephone number entry. OMA-P1104 will respond: "Enter number."



4. From the number keys, enter the access digit (i.e., 9). The OMA-P1104 will recite the digit.



5. Press PAUSE. The OMA-P1104 will "beep."



6. Enter the complete telephone number (1 + area code) using the number keys. The OMA-P1104 will recite the digits as they are pressed.



7. Press ENTER. The OMA-P1104 will say “Enter.”



4.4.3 Incorporating a Pound (#) or Asterisk (*)

Incorporate a pound or asterisk if it is normally included in telephone number:

1. Press SET.



2. Press PHONE NUMBER.



3. Press any unassigned number key (from 1 to 4) to represent the new telephone number entry. OMA-P1104 will respond: “Enter number.”



4. Enter the telephone number using the number keys. The OMA-P1104 will recite the digits as they are pressed.



5. Position the pound (#) or asterisk (*) within the telephone number where required by pressing SET (where the pound is located) or WHAT IS (where the asterisk is located). The OMA-P1104 will *beep* each time pound or asterisk is pressed.

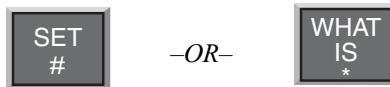

6. Enter any remaining digits of the telephone number.
7. Press ENTER. The OMA-P1104 will say "Enter."



4.4.4 Special Dialing to a Beeper or Pager

The following example demonstrates just one solution to programming the OMA-P1104 for dialing to a beeper or pager. Many other key sequences will also work. Start with steps 1–3 below; next, enter special dialing keys where required for your beeper or pager service.

To incorporate a pound or asterisk:

1. Press SET.



2. Press PHONE NUMBER.



3. Press any unassigned number key (from 1 to 4) to represent the new telephone number entry.

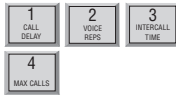

4. Enter the complete telephone number using the number keys. The OMA-P1104 will recite the digits as they are pressed.



5. Press CODE. This instructs the OMA-P1104 to wait for the telephone call to be answered by the beeper or pager service. (A voice message will not occur—only digital tones are used.)



6. Now press PAUSE once to activate a four second delay. This assumes the call is answered by a beeper/pager service that immediately delivers a prerecorded voice message. PAUSE may be pressed more than once to program more time for the beeper/pager service to finish its message. Each press of PAUSE allocates four additional seconds. The OMA-P1104 will “beep” with each press.



7. Enter a telephone number or custom code number that will identify the OMA-P1104 as the caller to your beeper or pager. A code may consist of any number(s) you designate. Many users find it convenient to use the telephone number to which the OMA-P1104 is connected.



8. A pound or asterisk may be required in some dialing situations. If required, position the pound (#) or asterisk (*) within the telephone number where required by pressing SET (where the pound is located) or WHAT IS (where the asterisk is located). The OMA-P1104 will “beep” each time pound or asterisk is pressed. Enter any remaining digits of the telephone number.



–OR–



9. Press ENTER. The OMA-P1104 will say “Enter.”



4.5 Rings Until Answer

Rings Until Answer is the programmed number of times the telephone rings before the OMA-P1104 will answer an incoming call. This can be set from 1 to 15 rings. The default value is 4.

4.5.1 Programming Rings Until Answer

To program Rings Until Answer:

1. Press SET.



2. Press RING/TAD. The OMA-P1104 will respond: *"Enter number."*



3. Using the number keys, enter a value.



4. Press ENTER. The OMA-P1104 will respond: *"Enter."*



4.5.2 Interrogating Rings Until Answer-

To interrogate Rings Until Answer:

1. Press WHAT IS.



2. Press RING/TAD.



4.6 TAD (Telephone Answering Device)

The TAD feature is especially useful because it integrates the operation of the OMA-P1104 with your telephone answering device in a way that retains the full flexibility of each system. This allows you to have on-demand telephone access to the OMA-P1104, for obtaining a Status Report, or for issuing call-in commands, while your telephone answering device is set to

receive outside calls. Programming for use with a telephone answering device (TAD) is always used in conjunction with Rings Until Answer, detailed in section 4.5.

NOTE

The TAD feature only applies to answering devices connected to the same telephone line as the OMA-P1104.

4.6.1 TAD Enable/Disable

To enable/disable the TAD feature:

1. Press SENSOR ON/OFF.



2. Press RING/TAD.



The OMA-P1104 will respond: “On.” (If the OMA-P1104 says “Off,” repeat steps 1 and 2 to reactivate TAD.)

4.6.2 Using the TAD Feature

1. Make sure the TAD feature is *enabled* on the OMA-P1104. (The default setting is *disabled*, so you must enable it first.)
2. Determine the number of rings your telephone answering device uses to answer the telephone. (Most answering devices require 4 rings; others are selectable.)
3. On the OMA-P1104, program Rings Until Answer to a greater number than the number of rings set on your answering machine.

Example:

Telephone answering device, rings = 4

OMA-P1104, Rings Until Answer = 6

Using the procedure just outlined, all incoming calls will be answered by the telephone answering device, allowing it to

operate normally. With the programming just accomplished, the OMA-P1104 can be accessed remotely, by telephone, to obtain the Status Report.

1. Dial the telephone number of the OMA-P1104.
2. Let the telephone ring once and then hang up.
3. Wait approximately ten seconds
4. Call the OMA-P1104 back.

It will answer the telephone on the first ring.

Explanation: The pattern of one ring, followed by a second call (within 30 seconds), signals the OMA-P1104 to answer your incoming call, excluding the telephone answering device.

NOTE

Special Case: If the OMA-P1104 shares the same line with a telephone answering device, and during certain time periods, frequent, incoming calls are expected on that line, then you may want to temporarily disable the TAD feature. If you leave the TAD enabled, it will not adversely affect normal operation, but if two outside telephone calls are received within the same 30-second time window, the OMA-P1104 will interpret this pattern as a signal to answer the telephone. If this occurs, press any key on the OMA-P1104 to hang up.

4.6.3 No TAD In Use

If a telephone answering device is not used on the same telephone line as the OMA-P1104, make sure that the TAD feature is disabled, or turned off. Only Rings Until Answer programming will determine how incoming calls are answered. For example, if you program Rings Until Answer to 3, incoming calls will be answered in 3 rings.

4.7 Listen-in Time

The Listen-in Time is the amount of time you can listen to sounds from the OMA-P1104's built-in microphone at its installation site. When you call in for a Status Report, the

OMA-P1104 announces Listen-in Time at the end of its first round of status readings, saying, “Listen to the sound level for (programmed time entered).” The programmable range is from 0 to 255 seconds (or up to 4.17 minutes). The default value is 15 seconds.

NOTE

The microphone is also used to monitor high sound level. See Chapter 5, Section 5.10 through Section 5.11.1.

4.7.1 Programming the Listen-in Time

To program the Listen-in Time:

1. Press SET.



2. Press LISTEN TIME. The OMA-P1104 will respond: “Enter seconds.”



3. Using the number keys, enter the seconds. The OMA-P1104 will recite the digits as they are pressed.



4. Press ENTER. The OMA-P1104 will respond: “Enter.”



4.7.2 Interrogating the Listen-in Time

To interrogate the Listen-in Time:

1. Press WHAT IS.



2. Press LISTEN TIME. The OMA-P1104 will recite the listen time in seconds programmed.



4.8 Call Delay

Call Delay is the programmed length of time the OMA-P1104 waits, following detection of an alarm, before it begins the dial-out sequence. *This applies only to the first call.* (Delay time between calls is also programmable: refer to Intercall Time, Section 4-11.)

The purpose for Call Delay is to allow time for personnel at the OMA-P1104's installation site to respond to and cancel an alarm before dial-out begins. During this time, the OMA-P1104 will audibly repeat its "alert condition" message (unless the Local Voice Mute feature has been activated—refer to Section 4.9). The default for Call Delay is 30 seconds. Call Delay can be programmed from 0 seconds to 60 minutes (1 hour).

4.8.1 Programming the Call Delay

To program the Call Delay:

1. Press SET.



2. Press CALL DELAY.



The OMA-P1104 will respond: *"Enter minutes."*

- Using the number keys, enter the minutes.
The OMA-P1104 recites the digits as they are pressed.



- Press ENTER. The OMA-P1104 responds: “Enter seconds.”



- Using the number keys, enter the seconds. The OMA-P1104 recites the digits as you press them.



- Press ENTER. The OMA-P1104 responds: “Enter.”



4.8.2 Interrogating Call Delay

To interrogate Call Delay:

- Press WHAT IS.



- Press CALL DELAY.



The OMA-P1104 will recite the programmed Call Delay.

4.9 Local Voice Mute

When the OMA-P1104 dials out to report an alarm, it also audibly recites the alarm message at its installation site. The Local Voice Mute command allows you to turn off the voice at the OMA-P1104's site during alarm dialouts and status call-ins. This feature is used to prevent intruders or unauthorized persons from hearing the alarm dial-out message or from hearing the Status Report during an off-site call.

4.9.1 Enable/Disable Local Voice Mute

To enable/disable Local Voice Mute:

1. Press SENSOR ON/OFF.

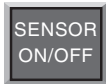

2. Press MUTE.



The OMA-P1104 will say “*On*,” to indicate that Local Voice Mute is enabled, or “*Off*,” to indicate that it is disabled.

3. Repeat key sequence to switch between enabled or disabled Local Voice Mute.

4.10 Voice Repetitions

The Voice Repetitions feature allows programming of the number of times the alarm message is delivered *per phone call* during alarm dial-out.

The maximum repetitions may be set to 10; the default is 3 repetitions.

4.10.1 Programming Voice Repetitions

To program Voice Repetitions:

1. Press SET.



2. Press VOICE REPS.

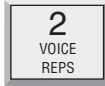

The OMA-P1104 will respond: "Enter number."

3. Using the number keys, enter a value from 0 to 10.



4. Press ENTER. The OMA-P1104 will respond: "Enter."



4.10.2 Interrogating Voice Repetitions

To interrogate Voice Repetitions:

1. Press WHAT IS.



2. Press VOICE REPS.

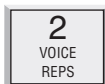

The OMA-P1104 will recite the number programmed.

4.11 Intercall Time

The Intercall Time is the programmable period of time the OMA-P1104 waits in calling subsequent telephone numbers. Intercall Time is activated ***only after alarm dial-out to the first telephone number fails to be acknowledged.*** This period can be programmed from 10 seconds to 60 minutes. The default intercall time is 1 minute.

If an incoming telephone call is made to the OMA-P1104 during Intercall Time (in between its dialing of subsequent telephone numbers to report an alarm), it will answer the incoming call and immediately report any existing alarms. The manner in which the incoming call is answered depends upon whether or not TAD is enabled or disabled:

- If TAD (Telephone Answering Device) is enabled, Rings Until Answer will be 1.
- If TAD is disabled, Rings Until Answer will be 10.

Refer to Section 4.5, Rings Until Answer, and Section 4.6, TAD (Telephone Answering Device).

4.11.1 Programming Intercall Time

To program Intercall Time:

1. Press SET.



2. Press INTERCALL TIME.



The OMA-P1104 will respond: *“Enter minutes.”*

3. Using the number keys, enter the minutes.
The OMA-P1104 recites the digits as you press them.



4. Press ENTER. The OMA-P1104 will respond: “Enter seconds.”



6. Using the number keys, enter the seconds. The OMA-P1104 recites the digits as you press them.



7. Press ENTER. The OMA-P1104 responds: “Enter.”



4.11.2 Interrogating Intercall Time

To interrogate Intercall Time:

1. Press WHAT IS.

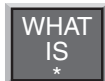

2. Press INTERCALL TIME.

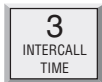

The OMA-P1104 will recite the programmed Intercall Time.

4.12 Maximum Number of Calls (Max Calls)

The Max Calls feature controls the total number of repeated calling attempts by the OMA-P1104 in the event of an alarm. When an alarm occurs, the dial-out process begins, and continues to cycle through your programmed telephone

numbers until a maximum number of calls is reached. The Max Calls setting regulates the number of calls that will be made as a result of any alarms; if more than one alarm is detected at once, or if a second alarm occurs during dial-out on the first alarm, the Max Calls setting will start the calling process from zero, until the programmed number of calling attempts are completed.

The default setting for Max Calls is 16, but it may be programmed from 0 to 255 calls. Max Calls is cancelled when an alarm is acknowledged. If the maximum number of calls is completed and no alarm acknowledgement has occurred, the OMA-P1104 will automatically acknowledge any alarm and stop the dial-out.

NOTE

If only one telephone number is programmed, the OMA-P1104 will dial out a maximum of 15 times to report an alarm.

4.12.1 Programming Max Calls

To program Max Calls:

1. Press SET.



2. Press MAX CALLS.



The OMA-P1104 will respond: *“Enter number.”*

3. Using the number keys, enter a value. The OMA-P1104 will recite the digits as you press them.



5. Press ENTER. The OMA-P1104 responds: “Enter.”



4.12.2 Interrogating Max Calls

To interrogate Max Calls programmed:

1. Press WHAT IS.



2. Press MAX CALLS.



The OMA-P1104 will recite the value set for Max Calls.

4.13 The Clock

The OMA-P1104 has a built-in clock. The power-up time is 12 AM. The clock will keep time from 12 AM until you program the current time. It will then keep time from your programmed time. If the AC power fails, the clock will continue to keep time until the battery back-up fails. It will then reset to 12 AM when power is restored. ***An incorrect time is a good indication that the power has failed and the batteries have been expended.***

4.13.1 Setting the Clock

To set the clock:

1. Press SET.



2. Press CLOCK.



3. Using the number keys, enter the correct time. The OMA-P1104 will recite the digits as they are pressed.



4. If the time is AM, press the AM key. The OMA-P1104 will “beep.” (If the time is PM, there is no key to press—the clock will be automatically set to PM if AM is not set.)



5. Press ENTER. The OMA-P1104 will say “Enter.”



Example: You want to set the clock to 12:45 AM. Press the following keys in the order shown:

SET...CLOCK...1...2...4...5...AM...ENTER.

4.13.2 Interrogating for the Current Time

To interrogate the OMA-P1104 for the current time:

1. Press WHAT IS.



2. Press CLOCK. The OMA-P1104 will recite the programmed time.



4.14 The Security Code

The Security Code is the last step after setting all other programming parameters for the OMA-P1104. The code consists of a 4-digit number you select and will effectively prevent unauthorized changes to the OMA-P1104's programming. When the Security Code is activated, all keyboard programming is inaccessible. The OMA-P1104 may be interrogated using the WHAT IS key, but the keyboard must be unlocked, via the Security Code, before any additional programming is possible.

4.14.1 Locking the Keypad

To program the Security Code:

1. Press SET.



2. Press CODE.



The OMA-P1104 will say *"Enter security code."*

3. Using the number keys, enter 4 digits. The OMA-P1104 says, *"OK."* The keyboard is now locked.



If unauthorized persons attempt to set a parameter, an error message, *"Error 2,"* is returned. Whenever any operation except WHAT IS takes place without entering the security code first, this error message occurs.

4.14.2 Unlocking the Keypad

To unlock the keyboard:

1. Press WHAT IS.



2. Press CODE.



The OMA-P1104 will say *“Enter Security Code.”*

3. Using the number keys, enter the digits for the code.



If the correct code is entered, the OMA-P1104 will say *“OK.”* If the wrong code is entered, the OMA-P1104 will say *“Error 2.”*

Chapter 5: Alarm Programming

This chapter explains the alarm programming and monitoring capabilities of the OMA-P1104, with specific instructions for the following features:

- Configure inputs as dry contact or temperature
- Enable/disable inputs
- Program alarm Recognition Time for each input
- Program high and low temperature limits
- Disable alarm response to high or low temperature
- Program temperature in Fahrenheit or Celsius scale
- Calibrate temperature
- Obtain current temperature
- Program AC power-failure Recognition Time
- Enable/disable AC power monitoring
- Program sound level sensitivity
- Program high sound Recognition Time
- Disable alarm response to high sound
- Use Exit Delay via Status Report

5.1 Input Configuration

In preparing the OMA-P1104 to sense an alert condition, the inputs must be configured as dry contact (either open or closed) or as temperature inputs. The default setting for input 1 is temperature; for inputs 2-4, the default is dry contact and open. To configure input normality, sensors are first wired to the terminal strip at the back of the unit. (Refer to Chapter 2, Section 2.9–2.12, for an explanation on wiring inputs.)

The configuration process directs the OMA-P1104 to initialize the 4 inputs and establish normal settings. Any change in the status of an input (for example, from a normally open contact to a suddenly closed contact) is recognized as an **alert condition**. In the case of a temperature input, an alert condition is recognized when established temperature limits are exceeded.

NOTE

Before starting keyboard commands to configure input normality on the OMA-P1104, ***it is very important to check that the sensors you have wired to the unit are set in their normal, non-alarm positions.***

For example, if a magnetic reed switch (a normally-closed sensor used to detect unauthorized entry) has been wired to the OMA-P1104, make sure that the door or window to be monitored is shut before configuring the input. If a motion-detector is wired to the unit, it is advisable to block all sources of motion from the sensor before and during configuration.

5.1.1 Programming Input Configuration

1. Press STANDBY to place the OMA-P1104 in Standby mode.



2. Wire sensors to the inputs to the back of the OMA-P1104 (see Chapter 2, Section 2.10).
3. Press RUN. The red light glows when the OMA-P1104 returns to Run mode.



4. Press SET.



5. Press CONFIGURE.



6. The OMA-P1104 audibly recites the configuration for each of the four inputs:
 - If the input is normally open, the OMA-P1104 recites the number of the input and says "OK."
 - If the input is normally closed, the OMA-P1104 recites the number of the input, followed by a "beep" and "OK."

- If the input is configured as temperature, the OMA-P1104 recites the number of the input, followed by “*Temperature.*”

5.1.2 Verifying Input Configuration

Input configuration can be verified when interrogating the OMA-P1104 for a complete Status Report. Refer to Chapter 6 for a more detailed description of the Status Report.

5.2 Enable/Disable Inputs

This function allows you to enable or disable an input’s response to an alert condition. An enabled input will respond to an alert condition and allow dial-out. A disabled input will cause dial-out to be suppressed, but any existing alert conditions will be revealed during the Status Report. Enable/disable programming is useful during wiring of inputs (see Chapter 2) or when a condition needs to be monitored, but is not critical enough to be programmed for dial-out reporting. It is important to verify input status after performing any task that requires disabling. The default setting for all inputs is enabled (ON). If an alert condition exists when inputs are re-enabled, Recognition Time will restart—refer to Section 5.3.

5.2.1 Changing Enabled/Disabled Input Status

1. Press SENSOR ON/OFF.



2. Press the number (1 to 4) of the selected input to enable/disable. The OMA-P1104 says “*Off*” to indicate disabled or “*On*” to indicate enabled.



5.2.2 Verifying Enabled/Disabled Input Status

1. Press WHAT IS.



2. Press STATUS.

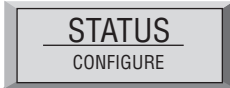

The OMA-P1104 audibly recites the current status of every input. In a Status Report, each input is first identified by its input number, followed by a report that specifies parameters currently affecting that input. ***If an input is disabled, the word “Off” immediately follows the number recited for that input.***

For example, input 3 is configured as a normally open, dry contact input. During the Status Report:

- ***If disabled***, the OMA-P1104 recites:
“Number 3—***Off***—OK,” for input 3.
- ***If enabled***, the OMA-P1104 recites:
“Number 3—OK,” for input 3.

In another example, input 2 is configured as a temperature input. The current temperature is 76 degrees. During a Status Report:

- ***If disabled***, the OMA-P1104 recites “Number 2—***Off***—76 degrees—OK”.
- ***If enabled***, the OMA-P1104 recites “Number 2—76 degrees—OK”.

5.3 Input Recognition Time

The Input Recognition Time is the length of time an alert condition must be present before a valid alarm exists and dial-out is activated. This time period is programmable, from 0 minutes, 0 seconds (for immediate response) up to a period of 272 minutes, 0 seconds. If an alert condition begins and then clears within the established Recognition Time, no dial-out will occur. When an alert condition continues beyond the

programmed Recognition Time, the OMA-P1104 initiates dial-out. The default setting for Input Recognition Time is 0 minutes, 3 seconds.

5.3.1 Programming Input Recognition Time

1. Press SET.



2. Press RECOGNITION TIME.



3. Press the number (1 to 4) of the selected input to be programmed.



The OMA-P1104 responds: *“Enter minutes.”*

4. Using the number keys, enter the minutes. For example, to set a Recognition Time of five minutes, simply press “5” on the keypad. The OMA-P1104 recites the digits as they are pressed.



5. Press ENTER. The OMA-P1104 responds: *“Enter seconds.”*



- Using the number keys, enter the seconds. The OMA-P1104 recites the digits as they are pressed.



- Press ENTER. The OMA-P1104 responds: "Enter."



5.3.2 Interrogating Input Recognition Time

- Press WHAT IS.



- Press RECOGNITION TIME.



- Press the corresponding input key (1 to 4).



The OMA-P1104 recites the programmed Recognition Time for that input.

5.4 Establishing High and Low Temperature Limits

High and low temperature limits can be separately programmed for each input configured as temperature. Limits can range from -20° to $+150^{\circ}$ Fahrenheit, or from -30° to 65° Celsius.

When temperature limits exceed high or low settings, the OMA-P1104 will dial out with an alarm message. Default settings are: 10° F for low temperature and 100° F for high

temperature.

5.4.1 Programming Temperature Limits for a Selected Input

1. Press SET.



2. Press TEMP LIMITS.

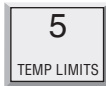

3. From the number keys, press a number (from 1 to 4) that corresponds to the temperature input being programmed.



The OMA-P1104 responds: *“Enter low temperature limit.”*

4. Using the number keys, enter a value for low temperature limit. The OMA-P1104 will recite the digits as they are pressed. If a negative number is required, first press PAUSE, then enter the number.



5. Press ENTER.



The OMA-P1104 responds: *“Enter high temperature limit.”*

- Using the number keys, enter the value for high temperature limit. The OMA-P1104 recites the digits as they are pressed.



- Press ENTER. The OMA-P1104 responds: *“Enter.”*



NOTE

Do not set temperature limits too close to normal room temperature. Minor temperature fluctuations could result in frequent and unnecessary alarm dialouts.

5.4.2 Disabling Alarm Response to High or Low Temperature

To disable alarm response to either high or low temperature settings exclusively, enter the maximum temperature limit when programming the selected input. (The OMA-P1104 will not respond to temperatures encountered at maximum settings or beyond.) Begin by following the key sequence shown in Section 5.4.1, and when prompted to enter the high or low temperature value:

- Set high temperature to either +150° F or +65° C (high temperature limit) to prevent the OMA-P1104 from responding to a high temperature alarm.
- Set low temperature to either -20° F or -30° C to prevent

the OMA-P1104 from responding to a low temperature alarm.

5.4.3 Interrogating High and Low Temperature Limits

1. Press WHAT IS.



2. Press TEMP LIMITS.



3. Press the number key corresponding to the selected temperature input.

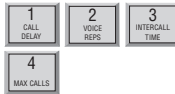

5.5 Temperature Scale

Temperature inputs may be set in either Fahrenheit or Celsius degrees. The default temperature scale is Fahrenheit. To change to Celsius:

1. Press SENSOR ON/OFF.

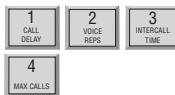

2. Press TEMP. The OMA-P1104 responds: “Off,” indicating Celsius scale has replaced Fahrenheit scale.

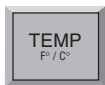

3. To return to Fahrenheit scale, repeat the key sequence. The OMA-P1104 responds: “On,” indicating Fahrenheit scale is in effect.

NOTE

When switching from Fahrenheit to Celsius, or

vice versa, the change applies to all inputs configured to read temperature. When switching temperature scales it is important to reset high and low temperature limits on all temperature inputs. Refer to Section 5.4.1 to reset temperature limits.

5.6 Temperature Calibration

To compensate for minor variances in sensor accuracy, an offset may be programmed for each temperature input. The amount of offset is measured in degrees Fahrenheit or degrees Celsius. Adjustments are possible within a range from -10 degrees to +10 degrees. For example, if input 3 is sensing temperature and is reading 1 degree too high, then the calibration for input 3 is set at -1 to obtain an accurate reading.

5.6.1 Programming Temperature Calibration

1. Press SET.



2. Press CALIBRATE.



3. Press the number (1 to 4) of the selected temperature input to be calibrated.



4. Enter the number required to offset the current temperature reading so a correct reading is obtained.



- To program a positive offset number (up to +10 degrees), enter the number on the keypad. The OMA-P1104 recites the digits as they are pressed.
 - To program a negative offset number (up to -10 degrees), first press PAUSE. The unit responds with a “beep.” Next, enter the number on the keypad. The unit recites the digits as they are pressed.
5. Press ENTER. The OMA-P1104 responds: “Enter.”



NOTE

If you find that your calibration offset exceeds more than + 5 or - 5 degrees, other complicating factors could be affecting normal operation of the OMA-P1104. Call Omega for technical assistance.

5.6.2 Interrogating Temperature Calibration

1. Press WHAT IS.



2. Press CALIBRATE.

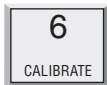

3. Press the number key corresponding to the selected temperature input.



If a “beep” precedes the number as it is recited, then a **negative** offset is indicated.

5.7 Obtaining Current Temperature

Current temperature readings for each temperature input may be accessed at any time. The OMA-P1104 recites the input

number, and the actual temperature detected by the attached sensor, for all inputs configured as temperature. To obtain current temperature:

1. Press WHAT IS.



2. Press TEMP.

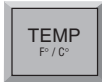

5.8 AC Power Monitoring Enable/Disable

The OMA-P1104 monitors AC power failure. This command enables or disables the power failure detection feature. When enabled, the OMA-P1104 will monitor power and dial out when AC power failure exceeds a programmable span of time (refer to AC Power Failure Recognition Time, Section 5.9).

The default setting for AC power monitoring is enabled (on). When disabled, the OMA-P1104 will not dial-out to report power failure.

5.8.1 Enabling/Disabling the AC Power Alarm

1. Press SENSOR ON/OFF.



2. Press POWER.

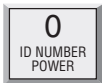

- The OMA-P1104 will say “*Off*” to indicate that the power alarm is disabled, or
- The OMA-P1104 will say “*On*” to indicate that the

power alarm is enabled.

3. Repeat key sequence to change settings.

5.9 AC Power Failure Recognition Time

The AC Power Failure Recognition Time is the length of time that AC electric power is off before a valid alarm is recognized and dial-out begins. The default setting is 5 minutes, 0 seconds, but is programmable from 0 seconds to a maximum of 272 minutes.

When AC power failure occurs, and throughout the programmed Recognition Time, the OMA-P1104 steadily repeats the message, *“the electricity is off,”* at the unit’s installation site. There is no Call Delay programming available for AC power failure. Immediately following Recognition Time, the OMA-P1104 begins the dial-out process to report power failure.

To cancel the power-failure message locally at the keypad (during or after Recognition Time) press any key on the OMA-P1104 keypad. This action also cancels the dial-out process. The AC power failure alarm may also be cancelled remotely, by telephone acknowledgment (see Chapter 6, Section 6.1).

5.9.1 Programming Power Failure Recognition Time

1. Press SET.



2. Press RECOGNITION TIME.



3. Press POWER. The OMA-P1104 responds: *“Enter minutes.”*

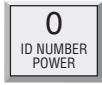

- Using the number keys, enter the number of minutes. The OMA-P1104 will recite the digits as they are pressed.



- Press ENTER. The OMA-P1104 responds: “Enter seconds.”



- Using the number keys, enter the number of seconds. The OMA-P1104 will recite the digits as they are pressed.



- Press ENTER. The OMA-P1104 responds: “OK.”



5.9.2 Interrogating Power Failure Recognition Time

- Press WHAT IS.



- Press RECOGNITION TIME.



3. Press POWER.
The OMA-P1104 will recite the power Recognition Time.

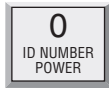

5.10 Sound Alarm Monitoring

This feature allows you to program the level and duration of sound that will cause the OMA-P1104 to respond to an alarm and dial-out. It may be useful to desensitize the OMA-P1104 to sound if it is installed in an area with a relatively high noise level, or where a loud noise occurs frequently but is not associated with an alarm. In some applications, it may be desirable to increase sound sensitivity to low sound levels.

5.10.1 Programming Sound Alarm Sensitivity

The sensitivity setting for sound alarm monitoring ranges from 1 to 255. A value of 1 makes the microphone the MOST sensitive to changes in sound. The value 255 makes the microphone the LEAST sensitive to sound. The default value is 32.

1. Press SET.



2. Press CALIBRATE.

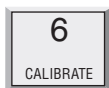

3. Press SOUND. The OMA-P1104 responds: *“Enter number.”*



- Using the number keys, enter a value for sound sensitivity. The OMA-P1104 recites the digits as you press them.



- Press ENTER. The OMA-P1104 responds: “Enter.”



5.10.2 Interrogating Sound Sensitivity

- Press WHAT IS.



- Press CALIBRATE.

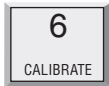

- Press SOUND. The OMA-P1104 recites the programmed sound sensitivity level.



5.10.3 Programming High Sound Alarm Recognition Time

The Recognition Time for sound alarm monitoring ranges from 2 seconds to 59 seconds. The default value is 8 seconds.

1. Press SET.



2. Press RECOGNITION TIME.



3. Press SOUND. The OMA-P1104 responds: "Enter seconds."



4. Using the number keys, enter the number of seconds. The OMA-P1104 will recite the digits as they are pressed.



5. Press ENTER. The OMA-P1104 responds: "OK."



5.11 High Sound Alarm Enable/Disable

The OMA-P1104 monitors sound through the built-in microphone. When the sound level suddenly exceeds the programmed high sound limit, the OMA-P1104 will respond to an alert condition. The increased sound level must continue throughout the programmed recognition time. The default for high sound alarm is enabled (on).

NOTE

The microphone is also used for listening to on-site sounds. Refer to Chapter 4, Section 4.7. Disabling the sound alarm does not affect listen-in capability.

5.11.1 Changing Enabled/Disabled High Sound Alarm

1. Press SENSOR ON/OFF.



2. Press SOUND. The OMA-P1104 will say “Off” to indicate disabled or “On” to indicate enabled.



3. Repeat key sequence to change settings.

5.12 Exit Delay

When tripping an alarm is unavoidable, yet a true alert condition has not actually occurred, the alarm response, including dial-out, can be temporarily suppressed.

The OMA-P1104 is able to suppress and then reset its dial-out function automatically through use of the Status Report. This is especially convenient when an alert condition is created upon exiting a monitored door, and there is no way to cancel from the local keypad.

Example: You are planning to exit through a monitored door. Prior to exiting, you initiate a Status Report recitation at the OMA-P1104 keypad by pressing WHAT IS, followed by STATUS, (key sequence shown below). This allows you approximately 30 seconds to exit without activating the OMA-P1104's programmed response to an alarm. At the conclusion of the status report, normal alarm response is reactivated.

To use exit delay, initiate the Status Report.

1. Press WHAT IS.



2. Press STATUS. The OMA-P1104 recites the full Status Report; during this time, you are able to exit the monitored area without tripping an alarm.

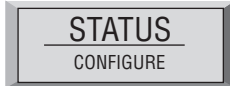

NOTES

Chapter 6: Acknowledgment, Status Report, and Remote Access

In addition to communication and alarm monitoring capabilities, the OMA-P1104 will also respond to your instructions and provide you with access to information on monitored conditions at all times.

By issuing commands to the unit, either at the installation site or over standard telephone lines, the following features may be activated:

- Acknowledgment of existing alarms
- The Status Report on all monitored conditions.

6.1 Alarm Acknowledgment

When the OMA-P1104 dials out with an alarm message, it will request acknowledgment before hanging up. Acknowledgment indicates to the unit that the alarm message has been received. Upon acknowledgment, the OMA-P1104 will cancel the dial-out sequence.

There are three ways* that an alarm is acknowledged directly:

- Local Acknowledgment
- Touch-Tone™ Acknowledgment
- Callback Acknowledgment

* A fourth method of alarm acknowledgment is indirect. Refer to Max Calls, Chapter 4, Section 4.12 for an example of automatic alarm acknowledgment.

6.1.1 Local Acknowledgment

To acknowledge an alarm locally (directly at the installation site of the OMA-P1104), press any key.

6.1.2 Touch-Tone™ Acknowledgment

This method of remote alarm acknowledgment works with a Touch-Tone™ telephone.

Example: You receive a call from the OMA-P1104, reporting that an alarm exists. The message concludes: "Indicate you have received warning message." Now, or at any time during this call, you may acknowledge the alarm with the code "555" if you are using a Touch-Tone™ telephone.

- To enter "555," press the number (5) key on the Touch-Tone™ phone keypad three times. The OMA-P1104 will respond: * ***"Warning message received by telephone number (last number dialed)."*** The OMA-P1104 will hang up and the dial-out sequence, including any further response to the alarm, will be cancelled.
- If you enter the wrong code or do not enter it within 10 seconds following the conclusion of the message, the OMA-P1104 will respond: ***"Dial telephone number (the programmed unit phone number) within (Intercall Time)."*** Then, the OMA-P1104 will hang up. The alarm is still not acknowledged until you call back. You have a period equal to the programmed Intercall Time to call the unit back2(9dntero(y ackno138.4(wledge the alar)-19.5. Refther)

NOTE

If you have the TAD feature (telephone answering device) enabled, the OMA-P1104 will answer the telephone on the first ring. If it is disabled, the telephone must be allowed to ring 10 times. This serves as a precaution against a random alarm acknowledgment. Refer to Chapter 4, Section 4.6, for complete information on using the TAD feature.

6.2 Status Report

The Status Report allows access to complete information on all monitored conditions either locally, from the keypad, or by telephone, from any location. The OMA-P1104 will answer an incoming telephone call following the programmed Rings Until Answer (refer to Chapter 4, Section 4.5). Included with the Status Report are messages related to alarm conditions, AC power, battery backup and sound level. It also provides an opportunity for listening to on-site sounds (refer to Listen-in Time, Chapter 4, Section 4.7).

To initiate the Status Report:

1. Press WHAT IS.



2. Press STATUS.



Sections 6.2.1, 6.2.2, and 6.2.3 demonstrate two different Status Report recitations. The Status Report starts with:

“Hello. This is telephone number 555-1234 (or the programmed ID).”

“The time is 12:15 PM (or the current time).”

The OMA-P1104 proceeds with a separate report for each input. Each input identifies itself by reciting the input number.

6.2.1 Example: Status Report, No Alarms

Inputs 2, 3, and 4 are configured as dry contact and input 1 is configured as temperature. No alarms exist. The Status Report begins by saying, *"Hello, this is telephone number 555-1234; the time is 12:15 PM."* Following this introduction, the report continues:

"Number 1, 74 degrees, OK."

"Number 2, OK."

"Number 3, OK."

"Number 4, OK."

"The electricity is ON." This refers to AC power.

"Battery condition, OK." Other responses: *"Battery condition low"* or *"Replace batteries."* (Refer to Section 6.2.4 for additional information regarding battery condition.)

"Sound level, OK."

"Listen to the sound level for 10 seconds." In this case, the programmed Listen-in Time is set at 10 seconds. (This feature is not available when obtaining the Status Report on-site, directly at the keypad.)

The Status Report repeats once more and the OMA-P1104 concludes the call, saying: *"Have a good day."* (The Status Report will not repeat if obtained at the keypad; *"Have a good day,"* is also not recited.)

The phrase *"no number"* at the end of a Status Report indicates that no dial-out phone numbers have been programmed.

6.2.2 Example: Status Report, Existing Alarms

Inputs 2, 3, and 4 are configured as dry contact and input 1 is configured as temperature. An emergency situation is at hand: a fire in a greenhouse has tripped a smoke alarm and electrical power has been disrupted. In addition to high sound and AC power alarms, separate alarms exist on inputs 1, 2, 3, and 4. You happen to call in for the Status Report, which begins with, *“Hello, this is telephone number 555-1234; the time is 12:15 PM.”* Following this introduction, the report continues:

“Number 1, 110 degrees, HIGH.”

“Number 2, EXISTS.”

“Number 3, EXISTS.”

“Number 4, EXISTS.”

“The electricity is OFF.”

“Battery condition, OK.”

“Sound level, HIGH.”

“Warning message received by ...(last telephone number dialed).”*

“Listen to the sound level for 10 seconds.”

The Status Report repeats once more and the OMA-P1104 concludes the call, saying: *“Have a good day.”*

* The “last telephone number dialed” refers to any one of the programmed, dial-out telephone numbers through which the OMA-P1104 was able to receive alarm acknowledgment, prior to your call for a Status Report; this could also refer to the OMA-P1104’s I.D. Number (identification number), if the alarms are acknowledged at the keypad by someone present at the site.

6.2.3 Example: Status Report, Disabled Inputs

If an input is *disabled*, the dial-out feature for that input is deactivated, but all other programmed parameters remain in effect. In the example below, all 4 inputs are disabled, although inputs 1 and 3 are detecting alarms. AC power and Sound Level is also disabled for dial-out. (Note that to indicate disabled status, only AC power will return two audible “beeps,” rather than the word “OFF”) When you call the OMA-P1104 for a Status Report, you hear the following:

“Hello, this is telephone number 555-1234.

“The time is 12:15 PM.”

“Number 1, OFF, 96 degrees, HIGH.”

“Number 2, OFF, 74 degrees, OK.”

“Number 3, OFF, EXISTS.”

“Number 4, OFF, OK.”

“The electricity is (beep, beep), ON.” If the electricity is off, or the AC adaptor is disconnected, you will hear:
“The electricity is (beep, beep), OFF.”

“Battery condition, OK.”

“Sound level, OFF, OK.” If the sound level is high you will hear: *“Sound level, OFF, HIGH.”*

“Listen to the sound level for 10 seconds.”

The Status Report repeats once more and the OMA-P1104 concludes the call, saying: *“Have a good day.”*

6.2.4 Battery Condition

During a Status Report, you may hear one of three possible messages regarding battery power. The OMA-P1104 determines the appropriate message by measuring battery voltage. Depending upon the remaining voltage, it may respond:

- *“Battery Condition , OK,”* if over 8.2 Volts.
- *“Battery Condition , low,”* if between 7.2 and 8.2 Volts.
- *“Replace batteries,”* if below 7.2 Volts.

6.2.5 Remote Access by Touch-Tone™ Telephone

Calling the OMA-P1104 for a Status Report provides the opportunity to access other functions, using Touch Tone™ push-button commands. Remote telephone commands include:

- Disabling/enabling any input.
- Disabling/enabling High Sound Alarm monitoring.
- Disabling/enabling AC Power monitoring.
- Activation of Listen-In Time.
- Activation of the Status Report.

To issue commands by telephone, first dial the number of the OMA-P1104 to access the Status Report. The Status Report will be followed by the programmed Listen-In Time. If you remain on the telephone, the Status Report will be repeated, followed by a 10 second waiting period and hang-up. During this

10 second waiting period, or ***at any time during the call, other commands may be accessed by pressing any push button on the telephone.***

If a Security Code is in effect, the OMA-P1104 will prompt you with: *“Enter Security Code.”* If no Security Code is set, then it will say *“O.K.”*

- Enter your Security Code (4 digits) with the telephone push buttons. If the code you enter is correct, the OMA-P1104 will respond: *“OK.”*
- If you enter the wrong Security Code, the OMA-P1104 says, *“Error. Have a good day,”* and hangs up.

Disabling/enabling inputs – If an input is set to detect an alert condition, it can be disabled to prevent the OMA-P1104 from dialing out, or re-enabled at any time.

This feature allows the convenience of disabling an input, even if you are away from the site of the OMA-P1104. One such application may involve an input programmed to detect unauthorized entry. You are in another locale, but must allow someone else temporary access to the area monitored by the OMA-P1104. Using a Touch Tone™ telephone, you can disable the appropriate input (thereby disabling any alarm dial-out response). The input remains disabled until you issue the same command, which effectively returns it to its former, enabled state.

Press the following push-buttons on the Touch Tone™ telephone to execute the desired command:

*** (asterisk), 1**

...equal to Sensor On/Off, for input 1. To re-enable the input, repeat the same Touch-Tone™ button sequence used for disabling.

*** (asterisk), 2**

...equal to Sensor On/Off for input 2, and so on, for inputs up to 4. To re-enable the input, repeat the same Touch-Tone™ button sequence used for disabling.

Disabling/enabling High Sound Monitoring –

*** (asterisk), 9**

...equal to SENSOR ON/OFF for High Sound Alarm monitoring. To re-enable High Sound Alarm, repeat the command.

Disabling/enabling AC Power –

*** (asterisk), 0**

...equal to Sensor On/Off for AC Power monitoring. To re-enable AC Power monitoring, repeat the command.

Chapter 6: Acknowledgment, Status Report, and Remote Access

Activating Listen-In Time –

#(pound), 1

...initiates Listen-In Time for listening to on-site sounds for the programmed time available.

Activating Status Report –

#(pound), 2

...initiates a full recitation of the Status Report.

Exiting –

#(pound), #(pound)

...forces exit. The 1104 says, “*Have a good day,*” and hangs up.

NOTES

Appendix A: Troubleshooting

In the event that a problem is encountered, this section will assist you in determining the cause, so you can return the unit to its usual monitoring routine with minimal interruption.

Most problems with the OMA-P1104 are easy to identify and quickly corrected, and are found under the following general headings:

- Communications/dial-out functions
- Temperature monitoring
- Sound level monitoring
- Other monitoring functions

If you have tried the solutions outlined in this section and are not satisfied with the results, call Omega Customer Service.

Communications / Dial-out:

Problem	Cause	Solution
1. The OMA-P1104 fails to dial out.	<ul style="list-style-type: none">a) The telephone number may be incorrectly programmed.b) Tone or pulse (the current dialing method) is not compatible with the telephone line on which the OMA-P1104 is installed.c) Recognition Time is too long. An alert condition does not remain in effect long enough to become a valid alarm.d) Max Calls is set to zero.	<p>Recheck programming steps, Refer to Chapter 4, Section 4.2.1.</p> <p>Switch from the current setting: from tone to pulse, or from pulse to tone. Refer to Chapter 4, Section 4.3.</p> <p>Reprogram Recognition Time. Set the Recognition Time to the minimum duration required to create a valid alarm. If possible, test the new setting by deliberately creating an alert condition. Refer to Chapter 5, Section 5.3.</p> <p>Reprogram Max Calls. It is a good idea to set your Max Calls to at least equal the number of dial-out telephone numbers programmed. Refer to Chapter 4, Section 4.12.1.</p>

<p>e) The OMA-P1104 is connected to an incompatible telephone line.</p>	<p>The OMA-P1104 must be connected to a standard (2-wire analog) telephone line, not a digital extension to a phone system. If the unit will not dial out and the factors previously listed have been ruled out, try connecting the unit to a standard residential telephone line.</p>
<p>a) Rings Until Answer is incorrectly programmed.</p>	<p>Recheck programming of Rings Until Answer. Refer to Chapter 4, Section 4.5.1.</p>
<p>b) The OMA-P1104 is connected to an incompatible telephone line.</p>	<p>Some telephone systems will not allow the telephone to ring beyond 4 rings. If your OMA-P1104's Rings Until Answer is set at more than 4 rings, you may not be able to access the unit. Try setting the Rings Until Answer to less than 4 rings. If this does not correct the problem, it may indicate telephone line incompatibility. In this case, try connecting the OMA-P1104 to a standard, residential telephone line.</p>
<p>2. The OMA-P1104 will not answer the telephone when called for a Status Report or alarm acknowledgment.</p>	<p>The OMA-P1104 must be connected to a standard (2-wire analog) telephone line, not a digital extension to a phone system. If the unit will not dial out and the factors previously listed have been ruled out, try connecting the unit to a standard residential telephone line.</p>

Communications / Dial-out:

Problem	Cause	Solution
<p>(Continued from previous page)</p> <p>3. The OMA-P1104 will not answer the telephone for Callback Acknowledgement.</p>	<p>You did not allow the telephone to ring 10 times. Note: If the TAD (telephone answering device) is disabled, the telephone rings ten times before the OMA-P1104 answers. If the TAD is enabled, the telephone rings once before the OMA-P1104 answers the call.</p>	<p>When calling the OMA-P1104, and the TAD is disabled, allow the telephone to ring 10 times. Refer to Chapter 6, Section 6.1.3, and Chapter 4, Section 4.6.3.</p>
<p>4. The OMA-P1104 recites the alarm message or Status Report over the telephone, but is silent at the installation site.</p>	<p>The local voice mute feature is in effect.</p>	<p>Deactivate local voice mute. Refer to the programming steps in Chapter 4, Section 4.9.</p>
<p>5. The OMA-P1104 dials out correctly but fails to audibly recite its alarm message when you answer the call.</p>	<p>Voice Repts is set to zero.</p>	<p>Reprogram Voice Repts to 1 or greater. Refer to Chapter 4, Section 4.10.</p>
<p>6. The OMA-P1104 and telephone answering device (sharing the same line) answer incoming calls simultaneously.</p>	<p>The OMA-P1104's number of Rings Until Answer is set to equal the number of rings set for the telephone answering device.</p>	<p>Change the number of Rings Until Answer for the OMA-P1104. Refer to Chapter 4, Section 4.5.</p>

Temperature Monitoring:

Problem	Cause	Solution
<p>1. The temperature reading is -20° F or -30° C.</p>	<p>The temperature sensor has been disconnected or has broken wires.</p>	<p>Examine the wires to temperature sensor and connect or replace wiring.</p>
<p>2. Temperature reads 150° F or 65° C.</p>	<p>Temperature sensor wires are touching or have shorted.</p>	<p>Verify and correct wiring.</p>
<p>3. Temperature reading is inaccurate.</p>	<p>a) Temperature sensing may be affected by a source of ambient heat (ie., direct sunlight, or heat duct proximity).</p> <p>b) Temperature may require calibration.</p>	<p>Try moving the unit to a different location.</p> <p>After moving or placing the unit away from ambient heat sources, the temperature may be calibrated to offset inaccurate normal reading by several degrees. Refer to Chapter 5, Section 5.6.</p>

Sound Level Monitoring:

Problem	Cause	Solution
1. False high sound alarms occur frequently.	The programmed sound sensitivity results in over-sensitivity to non-alarm sound as well as alarm sound. Sound Recognition Time is too short.	Reprogram the sound sensitivity. Refer to Chapter 5, Section 5.10. Lengthen the sound Recognition Time. Refer to Chapter 5, Section 5.10.
2. High sound does not cause an alarm.	The unit is not close enough to the high sound source, or the programmed sound setting results in a lack of sensitivity to high sound.	Move the unit closer or reprogram the sound sensitivity. Refer to Chapter 5, Section 5.10.

Other Monitoring:

Problem	Cause	Solution
1. Alarm status of an alert input is incorrect.	Incorrect input normality.	Reconfigure the input. See Chapter 5, Section 5.1.
2. False power out alarms	Programmed Recognition Time is too short.	AC power is often subject to brief interruptions. To avoid frequent, false alarms, increase the power Recognition Time. Refer to Chapter 5, Section 5.9.

<p>3. The OMA-P1104 does not recognize power failure.</p>	<p>a) Batteries are either incorrectly installed or drained.</p>	<p>To verify proper battery function, unplug the unit and verify continued operation using batteries only. If unit ceases to function, first try reinstalling the batteries. If this is not successful, replace the batteries. Refer to Chapter 2, Section 2.4 for complete instructions.</p>
<p>b) Recognition time setting is too long.</p>	<p>Reprogram Recognition Time. Set the Recognition Time to the minimum required before a valid alarm occurs. If possible, test the condition by deliberately creating an alert condition. Refer to Chapter 5, Section 5.9.</p>	<p>Reprogram Recognition Time. Set the Recognition Time to the minimum required before a valid alarm occurs. If possible, test the condition by deliberately creating an alert condition. Refer to Chapter 5, Section 5.9.</p>
<p>4. The OMA-P1104 does not recognize any alarm.</p>	<p>a) Inputs for alarm are disabled.</p>	<p>Enable the inputs for alarm. Refer to Chapter 5, Section 5.2.</p>
<p>b) Programmed Recognition Time is too long.</p>	<p>Reprogram Recognition Time. Set the Recognition Time to the minimum required for a monitored condition to become a valid alarm. If possible, test the condition by deliberately creating an alert condition. Refer to Chapter 5, Section 5.3.</p>	<p>Reprogram Recognition Time. Set the Recognition Time to the minimum required for a monitored condition to become a valid alarm. If possible, test the condition by deliberately creating an alert condition. Refer to Chapter 5, Section 5.3.</p>

Other Monitoring:

Problem	Cause	Solution
1. The batteries drain prematurely.	The unit's AC transformer is unplugged or for some other reason, full AC power is not available to the unit.	The batteries will take over powering the unit when the AC transformer is unplugged from the 120 VAC outlet. When storing the unit, be sure to remove the batteries. Refer to Chapter 2, Section 2.4. Be sure to use alkaline batteries—do not use rechargeable nicad batteries.

If the solutions offered above do not appear to correct the problem, apply the following steps, in the order shown.

- Remove the batteries.
- Unplug the unit.
- Wait one minute for the OMA-P1104 to completely power down.
- Plug in the unit's AC adaptor into a standard 120 VAC outlet.
- Replace the batteries.
- Reconfigure the inputs. Refer to Chapter 5, Section 5.1.

Refer to Chapter 2, Installation, for additional information on batteries and installation procedures.

Appendix B

Accessories

The sensors listed below are available from Omega, and represent the most commonly used input devices. Other dry contact sensors, designed for more specialized applications, may also be used. Commercial or industrial electrical supply houses can provide devices to monitor virtually any condition. For further information, contact Omega's Sales department at 1-800-82-66342 (1-800-TC-OMEGA).

MODEL NUMBER	SENSOR / SWITCH
OMA-PX05	Remote Temperature Sensor
OMA-PX06	Magnetic Reed Switch
OMA-PX13	Water Detection Sensor
OMA-PX22	Temp° Alert

Free Manuals Download Website

<http://myh66.com>

<http://usermanuals.us>

<http://www.somanuals.com>

<http://www.4manuals.cc>

<http://www.manual-lib.com>

<http://www.404manual.com>

<http://www.luxmanual.com>

<http://aubethermostatmanual.com>

Golf course search by state

<http://golfingnear.com>

Email search by domain

<http://emailbydomain.com>

Auto manuals search

<http://auto.somanuals.com>

TV manuals search

<http://tv.somanuals.com>