



User's Guide

CE



<http://www.omega.com>
e-mail: info@omega.com

CCT-55/ CCT-55-I Signal Integrators

M2304/1201

omega.com™

Ω OMEGA®

OMEGAnet™ On-Line Service
<http://www.omega.com>

Internet e-mail
info@omega.com

Servicing North America:

USA:

ISO 9001 Certified

One Omega Drive, Box 4047
Stamford, CT 06907-0047
Tel: (203) 359-1660
e-mail: info@omega.com

FAX: (203) 359-7700

Canada:

976 Bergar
Laval (Quebec) H7L 5A1
Tel: (514) 856-6928
e-mail: canada@omega.com

FAX: (514) 856-6886

For immediate technical or application assistance:

USA and Canada:

Sales Service: 1-800-826-6342 / 1-800-TC-OMEGASM
Customer Service: 1-800-622-2378 / 1-800-622-BESTSM
Engineering Service: 1-800-872-9436 / 1-800-USA-WHENSM
TELEX: 996404 EASYLINK: 62968934 CABLE: OMEGA

Mexico and

Latin America:

Tel: (95) 800-TC-OMEGASM FAX: (95) 203-359-7807
En Español: (203) 359-1660 ext: 2203 e-mail: espanol@omega.com

Servicing Europe:

Benelux:

Postbus 8034, 1180 LA Amstelveen, The Netherlands
Tel: (31) 20 6418405 FAX: (31) 20 6434643
Toll Free in Benelux: 06 0993344
e-mail: nl@omega.com

Czech Republic:

Ostravska 767, 733 01 Karvina
Tel: 42 (69) 6311899 FAX: 42 (69) 6311114
e-mail: czech@omega.com

France:

9, rue Denis Papin, 78190 Trappes
Tel: (33) 130-621-400 FAX: (33) 130-699-120
Toll Free in France: 0800-4-06342
e-mail: france@omega.com

Germany/Austria:

Daimlerstrasse 26, D-75392 Deckenpfronn, Germany
Tel: 49 (07056) 3017 FAX: 49 (07056) 8540
Toll Free in Germany: 0130 11 21 66
e-mail: germany@omega.com

United Kingdom:

ISO 9002 Certified

25 Swannington Road, P.O. Box 7, Omega Drive,
Broughton Astley, Leicestershire, Irlam, Manchester,
LE9 6TU, England M44 5EX, England
Tel: 44 (1455) 285520 Tel: 44 (161) 777-6611
FAX: 44 (1455) 283912 FAX: 44 (161) 777-6622

Toll Free in England: 0800-488-488
e-mail: uk@omega.com

It is the policy of OMEGA to comply with all worldwide safety and EMC/EMI regulations that apply. OMEGA is constantly pursuing certification of its products to the European New Approach Directives. OMEGA will add the CE mark to every appropriate device upon certification.

The information contained in this document is believed to be correct but OMEGA Engineering, Inc. accepts no liability for any errors it contains, and reserves the right to alter specifications without notice.

WARNING: These products are not designed for use in, and should not be used for, patient connected applications.

TABLE OF CONTENTS

	PAGE
Open the Housing	3
Internal Overview	3
Power Supply module MA	4
Changing the Power Supply	4
Signal Output, module MS-55 Overview	5
Types of Pulses	5
Frequency Output Range Selection, Pulses/second	6
Frequency Output Range Selection, Pulses/hour	7
Signal Input, module ME Overview	8
CCT-55-V, Electrical Features (Specifications)	9
Signal Input Range Selection	10
Adjustment and Calibration Procedure	10
CCT-55-I, Electrical Features (Specifications)	11
Signal Input Range Selection	12
Adjustment and Calibration Procedure	12
Wiring Connections	13
Mechanical Specifications	14

OPEN THE HOUSING

PROCEDURE

1. Insert a screwdriver or similar tool in the points marked ①.
2. Turn the screwdriver until the case walls begin to separate towards **A** and **B**, so the two side lugs ③, are free.
3. Grab the Signal Conditioner body, at the points marked ②, and pull it towards **C**, until the two side lugs ③ are out of their housing and the internal circuits are visible. See the sketch below for the disassembly of the circuit boards.
4. Before reinserting the Signal Conditioner body into the case, the following must be checked :

-The front label (blue color) must be in its correct position, with terminals 1 and 7 (power supply) separated from the other terminals.

-The three internal modules must be inserted correctly in their internal case guides.

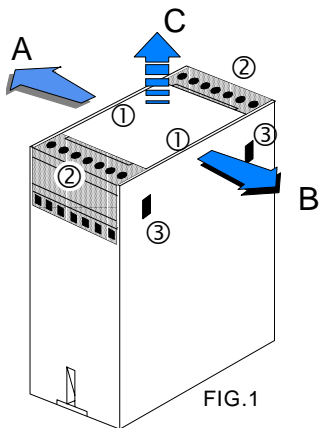

INTERNAL OVERVIEW

- A. "ME" Input module.
- B. "MS-55" Output module.
- C. "MA" Power supply module.
- D. "MP" Input Board.

PROCEDURE FOR DISASSEMBLY

1. Pull out the "ME" input module towards "a".
2. Pull out the "MS-55" output module towards "a".
3. Pull out the "MP" input board towards "b".
4. To assemble reverse the procedure.

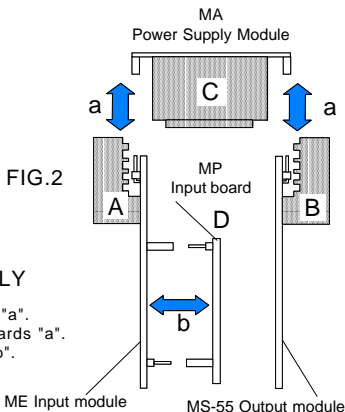

POWER SUPPLY module MA

The power supply must be connected to Terminals 1 and 7.
The characteristics of the power supply are shown on the side label.

WARNING.- If the power supply is dc voltage, be careful with the polarity indicated for each terminal.

Make sure the signal conditioner is correctly connected to a power supply of the correct voltage and frequency. Do not use any other power supply. Permanent damage may result to the signal conditioner.

PRECAUTIONS.- The installation must incorporate safety devices to protect the operator and the process when using the signal conditioner to control a machine or process where injury to personnel or damage to equipment or process, may occur as a result of failure of the signal conditioner.

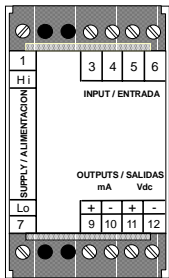

FIG.3

CHANGING THE POWER SUPPLY

Solder pads are used to change the value of the power supply. They are located on the "MA" Power Supply module, on the solder side, Fig. 4.

See Table 1 for more details.

TABLE 1

Power supply	Status of the solder pads	
	Closed	Opened
220 Vac	3,3 and 1	2 and 2
110 Vac	3,3,2 and 2	1
*48 Vac	3,3 and 1	2 and 2
*24 Vac	3,3,2 and 2	1
**24 Vdc	1	3,3,2 and 2

* Using the transformer code 63338301 and selecting the solder pads as indicated.

** Using the power supply option, code 029103 and selecting the solder pads as indicated.

Module MA

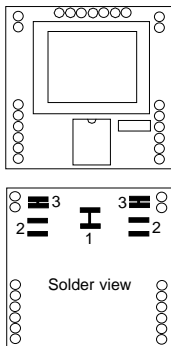

FIG.4

SIGNAL OUTPUT module MS-55

OVERVIEW

This module contains all the components for the frequency generator, and the trimmer for the Span coarse frequency. The jumpers and solder pads to select the output range frequency and solder pad to select the pulse width.

Both models are delivered as a standard version, with the frequency output adjusted from 0 to 4 KHz., unless specified otherwise.

The frequency range can be set in pulses per second (12 different ranges, see table 2) or in pulses per hour (13 different ranges, see table 3), using the jumpers and solder pads located on the MS-55 module, see figure 5.

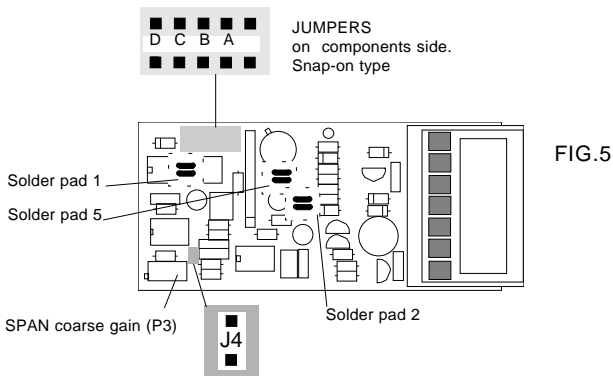

FIG.5

TYPES OF PULSES

The signal conditioner provides two different types of output pulses.

Pulses in Current: 100 mA. (24 Vdc external power supply), terminals 9 - 10

Pulses in Voltage: 24 Vdc. @ 20 mA maximum, terminals 11 - 12

Do not use both outputs simultaneously. Only one selection can be made.

The side label shows which one is selected.

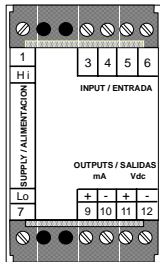

FIG.6

FREQUENCY OUTPUT RANGE SELECTION

PULSES PER SECOND

Table 2 indicates all the standard available ranges for these models when the frequency output must be in pulses per second.

Set the jumpers/solder pads to the position indicated in Table 2. The jumpers are located on the "MS-55" output module.

If the frequency output range is modified follow the adjustment and calibration procedure for each model.

PULSES / SECOND	CLOSE JUMPERS/ AND SOLDER PADS	PULSE WIDTH
0 to 5000/10000	E, 2 & 5	Variable
0 to 2500/5000	E, 1 & 5	50 % of the full cycle
0 to 1250/2500	E, A, 1 & 5	
0 to 625/1250	E, B, 1 & 5	
0 to 312.5/625	E, B, A & 5	
0 to 156.3/312.5	E, C, 1 & 5	
0 to 78.1/156.3	E, C, A, 1 & 5	
0 to 39.1/78.1	E, C, B, 1 & 5	
0 to 19.5/39.1	E, C, B, A, 1 & 5	
0 to 9.77/19.5	E, D, 1 & 5	
0 to 4.88/9.77	E, D, A, 1 & 5	
0 to 2.44/4.88	E, D, B, 1 & 5	

TABLE 2

The frequency output for each range is indicated : 0 to 2500/5000 for example.

This means that the minimum frequency output is 2500 Hz. and the maximum frequency output is 5000 Hz. Any frequency within the low and high value, can be obtained using the trimmer P3 located on the "MS-55" output module.

FREQUENCY OUTPUT RANGE SELECTION

PULSES PER HOUR

Table 3 indicates all the standard available ranges for these models when the frequency output must be in pulses per hour.

Set the jumpers and solder pads to the position indicated in Table 3. The jumpers are located on the "MS-55" output module.

If the frequency output range is modified follow the adjustment and calibration procedure for each model.

PULSES / HOUR	CLOSE JUMPERS/ AND SOLDER PADS	PULSE WIDTH
0 to 4395/8790	B, A & 1	50 % of the full cycle, when solder pad 5, is closed. 100 mS. when solder pad 5, is opened.
0 to 2197/4395	C & 1	
0 to 1099/2197	C, A & 1	
0 to 549/1099	C, B & 1	
0 to 275/549	C, B, A & 1	
0 to 137/275	D & 1	
0 to 68.7/137	D, A & 1	
0 to 34.3/68.7	D, B & 1	
0 to 17.2/34.3	D, B, A & 1	
0 to 8.58/17.2	D, C & 1	
0 to 4.29/8.58	D, C, A & 1	
0 to 2.15/4.29	D, C, B & 1	
0 to 1.07/2.15	D, C, B, A & 1	

TABLE 3

The frequency output for each range is indicated : 0 to 4395/8790 for example.

This means that the minimum frequency output is 4395 Hz. and the maximum frequency output is 8790 Hz. Any frequency within the low and high value, can be obtained using the trimmer P3 located on the "MS-55" output module.

SIGNAL INPUT, module ME

OVERVIEW

This module together with the "MP" input board, performs all the input signal conditioning (see Fig. 2). This module contains the trimmers and jumpers for the amplifier gain and the low level output (offset).

The signal input connections are made at Terminals 3, 4, 5 and 6.

Each model may use some of these terminals, see the Connections Section.

FIG.7

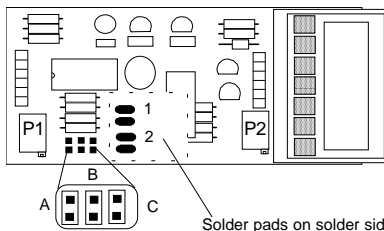

P1 : Output zero adjustment.

P2 : Gain amplifier adjustment.

OFFSET ADJUST

Solder pad 1 if closed : Adjust the low range level of the output (Offset positive coarse).

Solder pad 2 if closed : Adjust the low range level of the output (Offset negative coarse).

Jumper A if closed : Adjust the low range level of the output (Offset negative fine).

AMPLIFIER GAIN

Jumper B if closed : Gain at maximum level

Jumper C if closed : Gain at medium level.

Jumpers B and C opened : Gain at minimum level.

CCT-55-V; DC VOLTAGE INTEGRATOR

ELECTRICAL FEATURES

INPUT

Table 4 indicates all the standard available ranges for the CCT-55-V and its electrical specifications. The position of the jumpers are indicated in Fig. 8.

For different signal ranges, contact the engineering department for more information.

Reference	A	B	C	D	E
Range	0 to 100 mV	0 to 1 V	0 to 10 V	0 to 100 V	0 to 650 V
Min. input span *	10 mV	0.1 V	1 V	10 V	100 V
Impedance	100 K Ω	100 K Ω	1 M Ω		
Overvoltage	25 V	75 V	1,000 V		

* The minimum input span is the minimum difference between the maximum and minimum input for a full scale output.

TABLE 4

OUTPUT

FREQUENCY :	Pulses per second	0 to 10,000 (12 selectable ranges)
	Pulses per hour	0 to 8,790 (13 selectable ranges)
TYPE OF PULSES :	Voltage	24 Vdc @ 20 mA maximum
	Sink Current	100 mA. (24 Vdc external power supply)
PULSE WIDTH		100 ms; 50 % of the full cycle or variable with frequency ratio
ACCURACY		≤ 0.2 % FS
RESPONSE TIME		≤ 250 ms
GALVANIC ISOLATION		Input, Output and Power Supply are all isolated to 2 kVeff. 50 Hz/1 m.

GENERAL SPECIFICATIONS

STORAGE TEMPERATURE	-30° to +80°C
OPERATING TEMPERATURE	-10° to +60°C
TEMPERATURE COEFFICIENT	≤ 0.015 %/°C
STANDARD POWER SUPPLY	115 Vac (± 10 %) 50/60 Hz
POWER CONSUMPTION	≤ 1.5 VA
TEST VOLTAGE	4 kVeff. 50 Hz/1m.

SIGNAL INPUT RANGE SELECTION

Set the jumpers to the position indicated in Table 5 for each range. The jumpers are located on the "MP" input board. See Fig. 8.

If the signal input range is modified, follow the adjustment and calibration procedure.

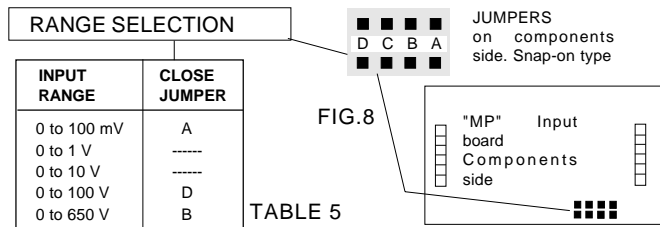

TABLE 5

ADJUSTMENT AND CALIBRATION PROCEDURE

1. When input and output signal values are determined, remove the conditioner case. (Fig. 1).
2. Check on the "MA" module, if the selected power supply is correct. (Table 1).
3. Select on the input board the desired Voltage range, according to Table 5.
Caution : Do not confuse the jumpers on the "MP" board with the jumpers on the "ME" module, (all of the jumpers on the "ME" board must be opened).
Close on "MS-55" output module, jumper E & solder pad 1, and open the jumpers A, B, C & solder pads 2 & 5, according to Tables 2 and 3.
4. Connect the calibrator to the conditioner terminals : 4 and 6 for signal > 1 V.
: 5 and 6 for signal < 1 V.
5. Connect a digital voltmeter to the jumper "J4" located on the "MS-55" output module.
6. Power up the signal conditioner with the appropriate power supply.
7. Adjust the calibrator until it generates the low signal level.
8. Check the voltmeter reading is 0. If not, turn the trimmer P1, located on the "ME" input module, until the reading of the voltmeter is 0.
9. Adjust the calibrator until it generates the high signal level.
10. Check the voltmeter reading is 10.0 V. If not, turn the trimmer P2, located on the "ME" input module, until the reading of the voltmeter is 10.0 V.
11. Repeat steps 7 thru 10, until the two values are correct.
12. Connect a digital frequency meter, to the signal output terminals 11 and 12. The reading must be between 2500/5000 Hz.
13. Select on the "MS-55" output module, the corresponding jumpers, according to Tables 2 & 3.
14. Adjust the calibrator until it generates the high signal level and turn the SPAN trimmer (P3), located on the "MS-55" output module, until the frequency meter shows the desired output frequency.
15. Disconnect the conditioner and the instruments used and reinsert into the case.

CCT-55-I : DC CURRENT INTEGRATOR

ELECTRICAL FEATURES

SIGNAL INPUT

Table 6 indicates two standard available ranges for the CCT-55-I and its electrical specifications. Using the jumpers located on the "MP" input board and "ME" input module, 4 different ranges may be selected (see Table 7).

For other signal ranges, contact the engineering department for more information.

Reference	A	B
Input range	0 to 5 mAdc	0 to 50 mAdc
Min. input Span *	0.5 mAdc	5 mAdc
Impedance	20 Ω	20 Ω
Overload	100 mAdc	100 mAdc

TABLE 6

* The minimum input span is the minimum difference between the maximum and minimum input for a full scale output.

OUTPUT

FREQUENCY :	Pulses per second	0 to 10,000 (12 selectable ranges).
	Pulses per hour	0 to 8,790 (13 selectable ranges).
TYPE OF PULSES:	Voltage	24 Vdc @ 20 mA maximum.
	Sink Current	100 mA. (24 Vdc external power supply)
PULSE WIDTH		100 mS; 50 % of the full cycle or variable with frequency ratio.
ACCURACY		≤ 0.2 % FS.
RESPONSE TIME		≤ 250 ms.
GALVANIC ISOLATION		Input, Output and Power Supply are all isolated to 2 kVeff. 50 Hz/1 m.

GENERAL SPECIFICATIONS

STORAGE TEMPERATURE	-30° to +80°C.
OPERATING TEMPERATURE	-10° to +60°C.
TEMPERATURE COEFFICIENT	≤ 0.015 %/°C.
STANDARD POWER SUPPLY	115 Vac ($\pm 10\%$) 50/60 Hz.
POWER CONSUMPTION	≤ 1.5 VA.
TEST VOLTAGE	4 kVeff. 50 Hz/1m.

SIGNAL INPUT RANGE SELECTION

Set the jumper to the position indicated in the table below for each range. The jumpers are located on the "MP" input board and "ME" input module. See Fig. 9.

If the signal input range is modified, follow the adjustment and calibration procedure.

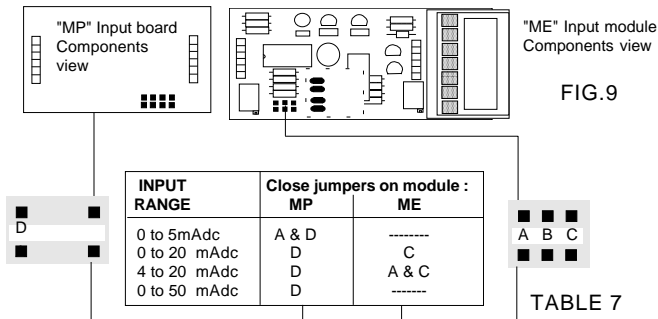

ADJUSTMENT AND CALIBRATION PROCEDURE

1. When input and output signal values are determined, remove the conditioner. (Fig. 1).
2. Check on the "MA" module, if the selected power supply is correct. (Table 1).
3. Select on the "MP" input board and "ME" input module the desired Current range, according to Table 7.
Close on "MS-55" output module, jumper E & solder pad 1, and open the jumpers A, B, C & D and solder pads 2 & 5, according to Tables 2 and 3.
4. Connect the calibrator to the conditioner terminals 5 and 6.
5. Connect a digital voltmeter, to the jumper "J4" located on the "MS-55" output module.
6. Power up the signal conditioner with the appropriate power supply.
7. Adjust the calibrator until it generates the low signal level.
8. Check the voltmeter reading is 0. If not, turn the trimmer P1, located on the "ME" input module, until the reading of the voltmeter is 0.
9. Adjust the calibrator until it generates the high signal level.
10. Check the voltmeter reading is 10.00 V. If not, turn the trimmer P2, located on the "ME" input module, until the reading of the voltmeter is 10.00 V.
11. Repeat steps 7 thru 10, until the two values are correct.
12. Connect a digital frequency meter, to the signal output terminals 11 and 12. The reading must be between 2500/5000 Hz.
13. Select on the "MS-55" output module, the corresponding jumpers, according to Tables 2 & 3.
14. Adjust the calibrator until it generates the high signal level and turn the SPAN trimmer (P3), located on the "MS-55" output module, until the frequency meter shows the desired output frequency.
15. Disconnect the conditioner and the instruments used and reinsert into the case.

WIRING CONNECTIONS

CCT-55-V

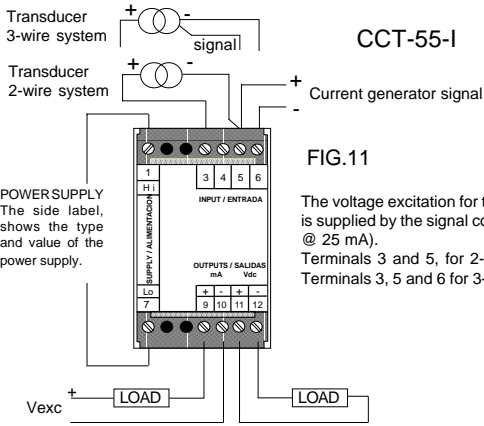
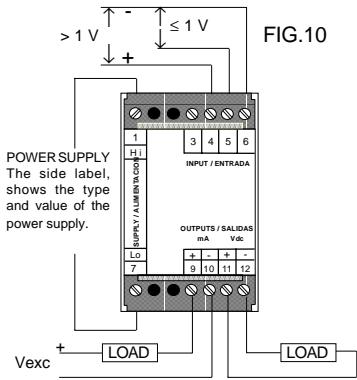

The voltage excitation for the current loop, it is supplied by the signal conditioner (24 Vdc @ 25 mA).

Terminals 3 and 5, for 2-wire transducers.
Terminals 3, 5 and 6 for 3-wire transducers.

MECHANICAL SPECIFICATIONS

DIMENSIONS

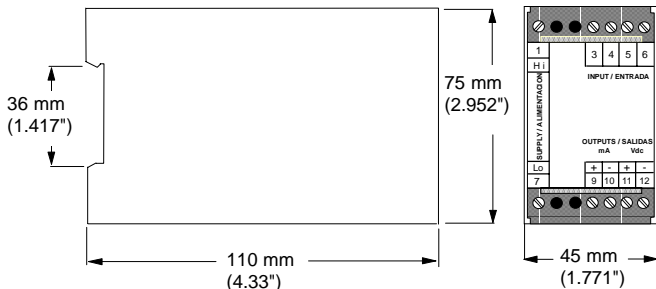

TECHNICAL DATA

WEIGHT 270 g.

HOUSING BASE Polycarbonate, RAL 7032, UL 94 V-1 light grey, IP-40

TERMINAL HOUSING, COVER

AND BLIND PLUGS Polycarbonate, UL 94 V-2 dark grey, IP-20

WIRE CROSS SECTION : 4 mm²

Provided with a snap fastener for attaching to DIN 46277 and DIN EN 50022 (35 x 7.5 mm) assembly rails.

NOTES



WARRANTY/DISCLAIMER

OMEGA ENGINEERING, INC. warrants this unit to be free of defects in materials and workmanship for a period of 13 months from date of purchase. OMEGA Warranty adds an additional one (1) month grace period to the normal one (1) year product warranty to cover handling and shipping time. This ensures that OMEGA's customers receive maximum coverage on each product.

If the unit should malfunction, it must be returned to the factory for evaluation. OMEGA's Customer Service Department will issue an Authorized Return (AR) number immediately upon phone or written request. Upon examination by OMEGA, if the unit is found to be defective it will be repaired or replaced at no charge. OMEGA's WARRANTY does not apply to defects resulting from any action of the purchaser, including but not limited to mishandling, improper interfacing, operation outside of design limits, improper repair, or unauthorized modification. This WARRANTY is VOID if the unit shows evidence of having been tampered with or shows evidence of being damaged as a result of excessive corrosion; or current, heat, moisture or vibration; improper specification; misapplication; misuse or other operating conditions outside of OMEGA's control. Components which wear are not warranted, including but not limited to contact points, fuses, and triacs.

OMEGA is pleased to offer suggestions on the use of its various products. However, OMEGA neither assumes responsibility for any omissions or errors nor assumes liability for any damages that result from the use of its products in accordance with information provided by OMEGA, either verbal or written. OMEGA warrants only that the parts manufactured by it will be as specified and free of defects. OMEGA MAKES NO OTHER WARRANTIES OR REPRESENTATIONS OF ANY KIND WHATSOEVER, EXPRESSED OR IMPLIED, EXCEPT THAT OF TITLE, AND ALL IMPLIED WARRANTIES INCLUDING ANY WARRANTY OF MERCHANTABILITY AND FITNESS FOR A PARTICULAR PURPOSE ARE HEREBY DISCLAIMED. LIMITATION OF LIABILITY: The remedies of purchaser set forth herein are exclusive and the total liability of OMEGA with respect to this order, whether based on contract, warranty, negligence, indemnification, strict liability or otherwise, shall not exceed the purchase price of the component upon which liability is based. In no event shall OMEGA be liable for consequential, incidental or special damages.

CONDITIONS: Equipment sold by OMEGA is not intended to be used, nor shall it be used: (1) as a "Basic Component" under 10 CFR 21 (NRC), used in or with any nuclear installation or activity; or (2) in medical applications or used on humans. Should any Product(s) be used in or with any nuclear installation or activity, medical application, used on humans, or misused in any way, OMEGA assumes no responsibility as set forth in our basic WARRANTY/DISCLAIMER language, and additionally, purchaser will indemnify OMEGA and hold OMEGA harmless from any liability or damage whatsoever arising out of the use of the Product(s) in such a manner.

RETURN REQUESTS / INQUIRIES

Direct all warranty and repair requests/inquiries to the OMEGA Customer Service Department. BEFORE RETURNING ANY PRODUCT(S) TO OMEGA, PURCHASER MUST OBTAIN AN AUTHORIZED RETURN (AR) NUMBER FROM OMEGA'S CUSTOMER SERVICE DEPARTMENT (IN ORDER TO AVOID PROCESSING DELAYS). The assigned AR number should then be marked on the outside of the return package and on any correspondence.

The purchaser is responsible for shipping charges, freight, insurance and proper packaging to prevent breakage in transit.

FOR WARRANTY RETURNS, please have the following information available BEFORE contacting OMEGA:

1. P.O. number under which the product was PURCHASED,
2. Model and serial number of the product under warranty, and
3. Repair instructions and/or specific problems relative to the product.

FOR NON-WARRANTY REPAIRS, consult OMEGA for current repair charges. Have the following information available BEFORE contacting OMEGA:

1. P.O. number to cover the COST of the repair,
2. Model and serial number of product, and
3. Repair instructions and/or specific problems relative to the product.

OMEGA's policy is to make running changes, not model changes, whenever an improvement is possible. This affords our customers the latest in technology and engineering.

OMEGA is a registered trademark of OMEGA ENGINEERING, INC.

© Copyright 1996 OMEGA ENGINEERING, INC. All rights reserved. This document may not be copied, photocopied, reproduced, translated, or reduced to any electronic medium or machine-readable form, in whole or in part, without prior written consent of OMEGA ENGINEERING, INC.

Where Do I Find Everything I Need for Process Measurement and Control? OMEGA...Of Course!

TEMPERATURE

- ✓ Thermocouple, RTD & Thermistor Probes, Connectors, Panels & Assemblies
- ✓ Wire: Thermocouple, RTD & Thermistor
- ✓ Calibrators & Ice Point References
- ✓ Recorders, Controllers & Process Monitors
- ✓ Infrared Pyrometers

PRESSURE, STRAIN AND FORCE

- ✓ Transducers & Strain Gauges
- ✓ Load Cells & Pressure Gauges
- ✓ Displacement Transducers
- ✓ Instrumentation & Accessories

FLOW/LEVEL

- ✓ Rotameters, Gas Mass Flowmeters & Flow Computers
- ✓ Air Velocity Indicators
- ✓ Turbine/Paddlewheel Systems
- ✓ Totalizers & Batch Controllers

pH/CONDUCTIVITY

- ✓ pH Electrodes, Testers & Accessories
- ✓ Benchtop/Laboratory Meters
- ✓ Controllers, Calibrators, Simulators & Pumps
- ✓ Industrial pH & Conductivity Equipment

DATA ACQUISITION

- ✓ Data Acquisition & Engineering Software
- ✓ Communications-Based Acquisition Systems
- ✓ Plug-in Cards for Apple, IBM & Compatibles
- ✓ Datalogging Systems
- ✓ Recorders, Printers & Plotters

HEATERS

- ✓ Heating Cable
- ✓ Cartridge & Strip Heaters
- ✓ Immersion & Band Heaters
- ✓ Flexible Heaters
- ✓ Laboratory Heaters

ENVIRONMENTAL MONITORING AND CONTROL

- ✓ Metering & Control Instrumentation
- ✓ Refractometers
- ✓ Pumps & Tubing
- ✓ Air, Soil & Water Monitors
- ✓ Industrial Water & Wastewater Treatment
- ✓ pH, Conductivity & Dissolved Oxygen Instruments

Free Manuals Download Website

<http://myh66.com>

<http://usermanuals.us>

<http://www.somanuals.com>

<http://www.4manuals.cc>

<http://www.manual-lib.com>

<http://www.404manual.com>

<http://www.luxmanual.com>

<http://aubethermostatmanual.com>

Golf course search by state

<http://golfingnear.com>

Email search by domain

<http://emailbydomain.com>

Auto manuals search

<http://auto.somanuals.com>

TV manuals search

<http://tv.somanuals.com>