

Where Do I Find Everything I Need for Process Measurement and Control? OMEGA...Of Course!

TEMPERATURE

- ☑ Thermocouple, RTD & Thermistor Probes, Connectors, Panels & Assemblies
- ☑ Wire: Thermocouple, RTD & Thermistor
- ☑ Calibrators & Ice Point References
- ☑ Recorders, Controllers & Process Monitors
- ☑ Infrared Pyrometers

PRESSURE, STRAIN AND FORCE

- ☑ Transducers & Strain Gauges
- ☑ Load Cells & Pressure Gauges
- ☑ Displacement Transducers
- ☑ Instrumentation & Accessories

FLOW/LEVEL

- ☑ Rotameters, Gas Mass Flowmeters & Flow Computers
- ☑ Air Velocity Indicators
- ☑ Turbine/Paddlewheel Systems
- ☑ Totalizers & Batch Controllers

pH/CONDUCTIVITY

- ☑ pH Electrodes, Testers & Accessories
- ☑ Benchtop/Laboratory Meters
- ☑ Controllers, Calibrators, Simulators & Pumps
- ☑ Industrial pH & Conductivity Equipment

DATA ACQUISITION

- ☑ Data Acquisition & Engineering Software
- ☑ Communications-Based Acquisition Systems
- ☑ Plug-in Cards for Apple, IBM & Compatibles
- ☑ Datalogging Systems
- ☑ Recorders, Printers & Plotters

HEATERS

- ☑ Heating Cable
- ☑ Cartridge & Strip Heaters
- ☑ Immersion & Band Heaters
- ☑ Flexible Heaters
- ☑ Laboratory Heaters

ENVIRONMENTAL MONITORING AND CONTROL

- ☑ Metering & Control Instrumentation
- ☑ Refractometers
- ☑ Pumps & Tubing
- ☑ Air, Soil & Water Monitors
- ☑ Industrial Water & Wastewater Treatment
- ☑ pH, Conductivity & Dissolved Oxygen Instruments

M-3949/0403

User's Guide



<http://www.omega.com>
e-mail: info@omega.com



LTU-101, LVU-150, LVC-152 LVC-100 & LVF-210 Series Powered Level Switch

OMEGA ENGINEERING, INC. warrants this unit to be free of defects in materials and workmanship for a period of **12 months** from date of purchase. OMEGA's Warranty adds an additional one (1) month grace period to the normal **one (1) year product warranty** to cover handling and shipping time. This ensures that OMEGA's customers receive maximum coverage on each product.

If the unit malfunctions, it must be returned to the factory for evaluation. OMEGA's Customer Service Department will issue an Authorized Return (AR) number immediately upon phone or written request. Upon examination by OMEGA, if the unit is found to be defective, it will be repaired or replaced at no charge. OMEGA's Warranty does not apply to defects resulting from the purchaser's, including but not limited to, mishandling, operation outside of design limits, improper repair, or unauthorized modification. This WARRANTY is VOID if the unit shows evidence of having been tampered with or shows evidence of having been damaged as a result of excessive corrosion, or current, heat, moisture or vibration; improper specification; misapplication; misuse or other operating conditions outside of OMEGA's control. Components which wear are not warranted, including but not limited to contact points, fuses, and traces.

OMEGA is pleased to offer suggestions on the use of its various products. However, OMEGA neither assumes responsibility for any omissions or errors nor assumes liability for any damages that result from the use of its products in accordance with information provided by OMEGA. OMEGA warrants only that the parts manufactured by it will be as specified and free of defects. OMEGA MAKES NO OTHER WARRANTIES OR REPRESENTATIONS OF ANY KIND WHATSOEVER, EXPRESS OR IMPLIED, EXCEPT THAT OF TITLE, AND ALL IMPLIED WARRANTIES INCLUDING ANY WARRANTY OF MERCHANTABILITY AND FITNESS FOR A PARTICULAR PURPOSE ARE HEREBY DISCLAIMED. LIMITATION OF LIABILITY: THE REMEDY FOR A PURCHASER'S DEFECTIVE PRODUCT SHALL BE LIMITED TO THE REPLACEMENT OF THE DEFECTIVE COMPONENT, WHETHER BASED ON CONTRACT, WARRANTY, NEGLIGENCE, INDENTIFICATION, STRICT LIABILITY OR OTHERWISE. OMEGA shall not exceed the purchase price of the component upon which liability is based. In no event shall OMEGA be liable for consequential, incidental or special damages.

CONDITIONS: Equipment sold by OMEGA is not intended to be used, nor shall it be used in a "basic component" under 10 CFR 21 (NRC), used in or with any nuclear installation or activity; or (2) in medical applications or used on humans; should any Product be used in or with any nuclear installation or activity, the purchaser shall assume all responsibility for the use of the Product(s) in such a manner.

Direct all warranty and repair requests/inquiries to the OMEGA Customer Service Department. BEFORE RETURNING ANY PRODUCT(S) TO OMEGA, PURCHASER MUST OBTAIN AN AUTHORIZED RETURN (AR) NUMBER FROM OMEGA'S CUSTOMER SERVICE DEPARTMENT (IN ORDER TO AVOID PROCESSING DELAYS). The assigned AR number should then be marked on the outside of the return package and on any correspondence. The purchaser is responsible for shipping charges, freight, insurance and proper packaging to prevent breakage in transit.

FOR WARRANTY RETURNS, please have the following information available BEFORE contacting OMEGA:

1. Purchase Order number under which the product was purchased.
2. Model and serial number of the product under warranty, and
3. Repair instructions and/or specific problems relative to the product.

OMEGA's policy is to make running changes, not model changes, whenever an improvement is possible. This affords our customers the latest in technology and engineering.

OMEGA is a registered trademark of OMEGA ENGINEERING, INC.
© Copyright 2003 OMEGA ENGINEERING, INC. All rights reserved. This document may not be copied, photo-copied, reproduced, translated, or reduced to any electronic medium or machine-readable form, in whole or in part, without the prior written consent of OMEGA ENGINEERING, INC.

RETURN REQUESTS/INQUIRIES

Direct all warranty and repair requests/inquiries to the OMEGA Customer Service Department. BEFORE RETURNING ANY PRODUCT(S) TO OMEGA, PURCHASER MUST OBTAIN AN AUTHORIZED RETURN (AR) NUMBER FROM OMEGA'S CUSTOMER SERVICE DEPARTMENT (IN ORDER TO AVOID PROCESSING DELAYS). The assigned AR number should then be marked on the outside of the return package and on any correspondence. The purchaser is responsible for shipping charges, freight, insurance and proper packaging to prevent breakage in transit.

FOR WARRANTY RETURNS, please have the following information available BEFORE contacting OMEGA:

1. Purchase Order number under which the product was purchased.
2. Model and serial number of the product under warranty, and
3. Repair instructions and/or specific problems relative to the product.

OMEGA's policy is to make running changes, not model changes, whenever an improvement is possible. This affords our customers the latest in technology and engineering.

OMEGA is a registered trademark of OMEGA ENGINEERING, INC.
© Copyright 2003 OMEGA ENGINEERING, INC. All rights reserved. This document may not be copied, photo-copied, reproduced, translated, or reduced to any electronic medium or machine-readable form, in whole or in part, without the prior written consent of OMEGA ENGINEERING, INC.

The information contained in this document is believed to be correct, but OMEGA Engineering, Inc. accepts no liability for any errors it contains, and reserves the right to alter specifications without notice.

WARNING: These products are not designed for use in, and should not be used for, human applications.



OMEGA® On-Line Service
www.omega.com
Internet e-mail: info@omega.com

Servicing North America:

One OMEGA Drive, Box 4047
Stamford CT 06907-0047
FAX: (203) 359-1660
Tel: (203) 359-7700
Canada: 976 Bergara
Laval (Quebec) H7L 5A1, Canada
Tel: (514) 856-6928
FAX: (514) 856-6886
e-mail: info@omega.ca

For immediate technical or application assistance:

USA and Canada:
Sales Service: 1-800-826-6342 / 1-800-1TC-OMEGA®
Customer Service: 1-800-622-2378 / 1-800-622-BEST®
Engineering Service: 1-800-872-9436 / 1-800-USA-WHEN®
TEL: 996404 EASYLINK: 62968934
CABLE: OMEGA

Servicing Europe:

Germany/Austria:
Daimlerstrasse 26, D-7392
Deckenpfort, Germany
Tel: +49 (0)7056 9398-0
FAX: +49 (0)7056 9398-29
Toll Free in Germany: 0800 639 7678
e-mail: info@omega.de
United Kingdom: ISO 9002 Certified
One Omega Drive
River Bend Technology Centre
Northbank, Ham
Manchester M44 5BD
e-mail: info@omegashop.co.uk
France:
11, rue Jacques Cartier
78280 Guyancourt, France
Tel: +33 (0)1 61 37 29 00 FAX: +33 (0)1 30 57 54 27
Toll Free in France: 0800 466 342
e-mail: sales@omega.fr
Czech Republic:
Fyzikalska 184/46, 273 01 Kavanov, Czech Republic
Tel: +420 (0)59 6311189
FAX: +420 (0)59 6311114
Toll Free: 0800-1-66342
e-mail: info@omegashop.cz
Belux:
Festibus 8094, 1180 LA Anstelveen
The Netherlands
Tel: +31 (0)20 342121 FAX: +31 (0)20 6434643
Toll Free in Benelux: 0800 0993344
e-mail: sales@omegae.nl

SPECIFICATIONS

Step One

Common Specifications:

Orientation:	Universal
Accuracy:	± 1 mm in water
Repeatability:	± 0.5 mm in water
Supply voltage:	12-36 VDC
Consumption:	25 mA maximum
Contact type:	(1) SPST relay
Contact rating:	GP: 120 VAC/VDC @ 1A (CE: 60 VAC/VDC @ 1A)
Contact output:	Selectable NO/NC
Process temp.:	F: -40° to 194° C: -40° to 90°
Pressure:	150 psi (10 bar) @ 25° C., derated @ 1.667 psi (.113 bar) per °C. above 25° C.
Sensor rating:	NEMA 6 (IP68)
Cable type:	4-conductor, #22 AWG (shielded)
Cable length:	Standard: 10' (3m)
Process mount:	3/4" NPT (3/4" G / Rp)
Mount. gasket:	Viton® (G version only)
Classification:	General purpose
CE compliance:	EN 50082-2 immunity EN 55011 emission EN 61010-1 safety

LTU-101 series Specifications:

Sensor material: PP-Ryton® (glass fill)
Cable jacket mat.: PP

LVS-150 series Specifications:

Sensor material: -150/-152: PP
-151/-153: PFA
Cable jacket mat.: -150/-152: PP
-151/-153: PFA

LVC-100 series Specifications:

Dielectric range: > 20 constants
Conductive range: > 100 micromhos
Sensor material: -101/-103: PP
-102/-104: PFA
Cable jacket mat.: -101/-103: PP
-102/-104: PFA

LVC-152 series Specifications:

Dielectric range: > 20 constants
Conductive range: > 100 micromhos
Sensor material: PP
Cable jacket mat.: PP

LVF-210 series Specifications:

Sensor material: -210/-212: PP
-211/-213: PFA
Cable jacket mat.: -210/-212: PP
-211/-213: PFA

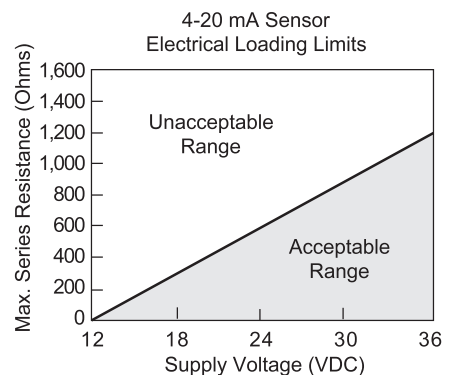
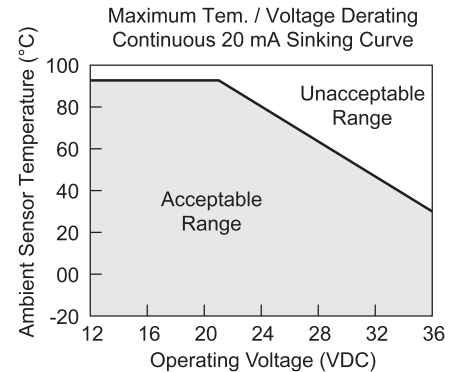
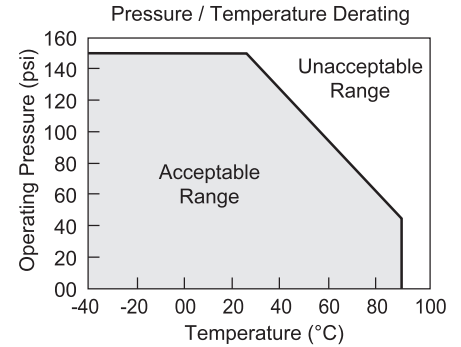

Table of Common Dielectric Constants

NOTE: Liquids with a dielectric constant less than 20 will not be detected by an LVC-152 series or LVC-100 series level switch, as factory calibrated.

Acetone	21	Chlorotoluene	4.7	Ethylene chloride	10.5	Isobutyl methyl ketone	25	Trichloroethylene	3.4
Acetaldehyde	22.2	Chloroform	4.5 to 5.0	Ethyl acetate	6.4	Jet fuel	1.7	Trichloroacetic acid	4.5
Acetyl methyl hexyl ketone	28	Chlorine, liquid	2.0	Ethyl salicylate	8.6	Lead carbonate	18	Terephthalic acid	
Alcohol	16 to 31	Carbon tetrachloride	2.2	Ethyl stearate	2.9	Lead nitrate	38	Oils, mineral	2.3 to 2.4
Ammonia	15 to 25	Cyan	2.6	Ethyl silicote	4.1	Methyl salicylate	9.0	Oils, petroleum	1.8 to 2.2
Acetic acid	4.1 to 6.2	Cyclohexane methanol	3.7	Formic acid	59	Methanol	33	Thinners	3.7
Butyl chloride	9.6	D.I. Water	20	Ferric oleate	2.6	Methyl alcohol	33 to 38	Urea	3.5
Barium chloride	9 to 11	Ethyl toluene	2.2	Freon	2.2	Margarine, liquid	2.8 to 3.2	Vinyl chloride	2.8 to 6
Benzene	2.3	Ethyl alcohol	23	Glycerine	47			Vinyl alcohol	1.8 to 2.0
Benzine	2.3	Ethylene glycol	37	Glycol	30			Water, 20°C	80
Barium nitrate	5.6	Ethylene oxide	14	Glycol nitrite	27			Water, 100°C	48
Bromine	3.1	Ethylene dichloride	11 to 17	Gasoline	2 to 2.2	Methyl acetate	7.3	Potassium nitrate	5.0 to 5.9
Chlorobenzene	4.7 to 6			Hydrochloric acid	4.6	N-butyl formate	2.4	Potassium chloride	5.0
				Isobutyric acid	2.7	Nitrobenzene	26 to 35	Stearic acid	2.3
								Toluene	2.4

DIMENSIONS

Step Two

Vibration Level Switch, LTU-101 series

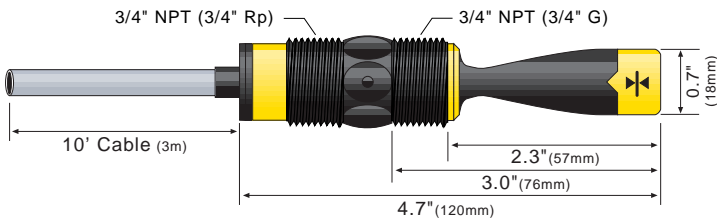

Ultrasonic Level Switch, LVU-150 series

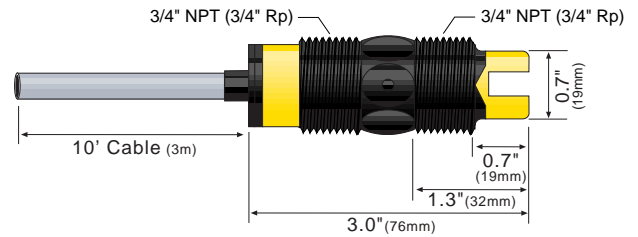
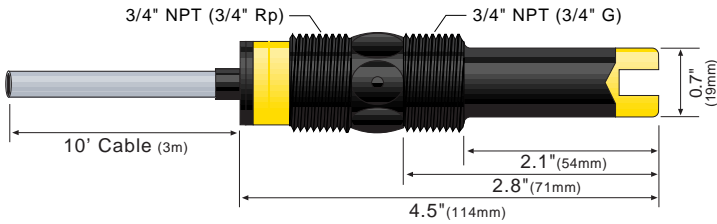

SuperGuard RF Capacitance Level Switch, LVC-152 series

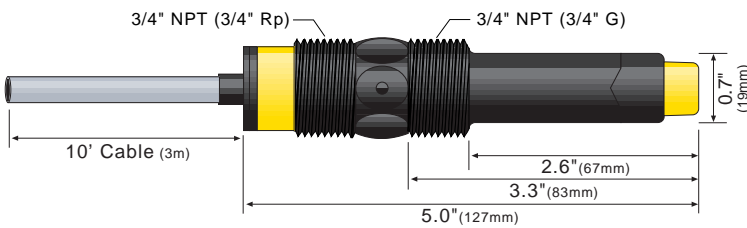

Intrusive RF Capacitance Level Switch, LVC-100 series

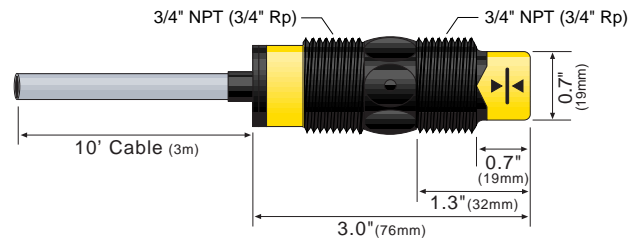
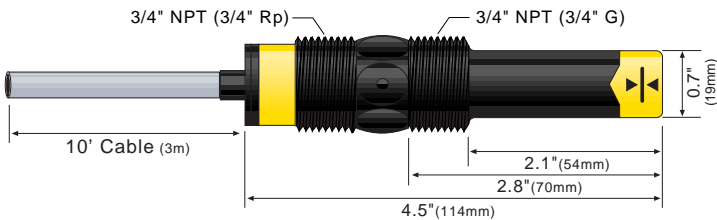

Optic Leak Detection Switch, LVF-210 series

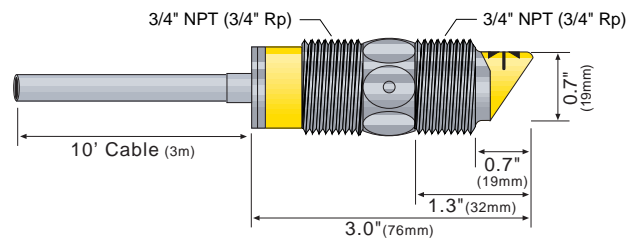
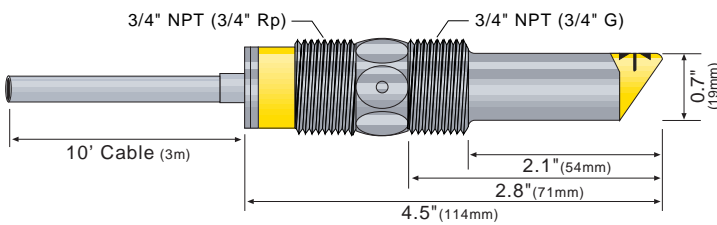

* all dimensions are Nominal

SAFETY PRECAUTIONS

Step Three

About this Manual:

PLEASE READ THE ENTIRE MANUAL PRIOR TO INSTALLING OR USING THIS PRODUCT. This manual includes information on all models of Omega's powered level switches: LTU-101 series, LVU-150 series, LVC-152 series, LVC-100 series and LVF-210 series. Please refer to the part number located on the switch label to verify the exact model which you have purchased.

User's Responsibility for Safety:

Omega manufactures a wide range of liquid level sensors and technologies. While each of these sensors is designed to operate in a wide variety of applications, it is the user's responsibility to select a sensor model that is appropriate for the application, install it properly, perform tests of the installed system, and maintain all components. The failure to do so could result in property damage or serious injury.

Proper Installation and Handling:

Because this is an electrically operated device, only properly-trained staff should install and/or repair this product. Use a proper sealant with all installations. Never overtighten the sensor within the fitting, beyond a maximum of 80 inch-pounds torque. Always check for leaks prior to system start-up.

Material Compatibility:

The LVU-150, LVC-100 and LVF-210 series sensors are available in two different wetted materials. Models LVU-150/-152, LVC-101/-103 and LVF-210/-212 are made of Polypropylene(PP). Models LVU-151/-153, LVC-102/-104 and LVF-211/-213 are made of Perfluoroalkoxy(PFA), also known by the trade name Teflon. The LTU-101 series is made of PP with the forks made of Ryton (40% glass filled) and the LVC-152 series is made of PP. Make sure that the model you have selected is compatible with the application liquid. To determine the chemical compatibility between the sensor and its application liquids, refer to an industry reference.

Wiring and Electrical:

The supply voltage used to power the sensor should never exceed a maximum of 36 volts DC. Electrical wiring of the sensor should be performed in accordance with all applicable national, state, and local codes.

Flammable, Explosive and Hazardous Applications:

DO NOT USE THE LTU-101, LVU-150, LVC-152, LVC-100 OR LVF-210 SERIES GENERAL PURPOSE SWITCH IN HAZARDOUS LOCATIONS.

WARNING

The rating for the relay is 120 VAC/60 VDC @ 1A. For CE rated applications, the relay rating is 60 VAC/60 VDC @ 1A.

Omega's powered level switches are not recommended for use with electrically charged application liquids. For most reliable operation, the liquid being measured may need to be electrically grounded.

INTRODUCTION

Step Four

Vibration Switch:

The Tuning Fork vibration switch operates at a nominal frequency of 400 Hz. As the switch becomes immersed in a liquid or slurry, a corresponding frequency shift occurs. When the measured frequency shift reaches the set point value, the switch changes state indicating the presence of a liquid or slurry medium.

Do not squeeze the forks together. Doing so could damage or break the sensor and void the warranty.

When powering up the LTU-101 series, the start-up procedure requires the switch to cycle through a wet condition for 1/2 second in order to determine an initial resonance.

Ultrasonic Switch:

The Ultrasonic level switch generates a 1.5 MHz ultrasonic wave from a miniature piezoelectric transducer located on one side of the gap in its sensing tip. Another piezo transducer located on the other side of the gap acts as a microphone, picking up the sound. When liquid enters the gap in the sensing tip, the audio level changes.

The sensor should be installed so that the liquid will drip out of the gap when the sensor becomes dry.

Optic Switch:

The Optic Leak Detector use principles of optical refraction to detect the presence or absence of fluid. A pulsed infrared light beam is internally generated by a light emitting diode and aimed at the slanted optical tip of the sensor. If the tip is dry, the light beam bounces at a 90 degree angle to a receiving photo transistor, indicating a dry condition. If the tip is immersed in liquid, the light beam will refract out into the liquid instead of being reflected to the photo transistor, indicating a wet condition.

The Optic Leak Detector can not detect the presence or absence of specular application liquids that reflect light (such as milk), or viscous liquids (such as paint) that form a coating on the sensor tip.

SuperGuard Capacitance Switch:

The SuperGuard level switch generates a pulse-wave radio frequency signal from the capacitance electrode located in the sensing tip of each sensor. When liquid comes into contact with the sensing tip, the capacitance as measured by the sensor changes based on the dielectric constant of the liquid. The guard circuit rejects the negative effects of coating buildup on the probe by eliminating the coating signal path between the active and reference electrodes.

Intrusive RF Capacitance Switch:

The Intrusive RF Capacitance level switch generates a 300 kHz pulse-wave radio frequency signal from the capacitance electrode located in the sensing tip of each sensor. When liquid comes into contact with the sensing tip, the capacitance as measured by the sensor changes based on the dielectric constant of the liquid.

The sensor's operation may vary based on the dielectric properties of various application liquids. The LVC-152 series & LVC-100 series sensor is factory-calibrated to be used with liquids with a dielectric value between 20 and 80.

Liquids with a dielectric constant less than 20 will not be detected by an LVC-152 series & LVC-100 series sensor, as factory calibrated.

INSTALLATION

Step Five

Through Wall Installation:

Omega's powered level switches may be installed through the top, side or bottom of a tank wall. The sensor has male 3/4" NPT threads on either side of a 15/16" wrench flat. This enables the user to select the sensor's mounting orientation, installed outside of the tank in, or inside of the tank out.

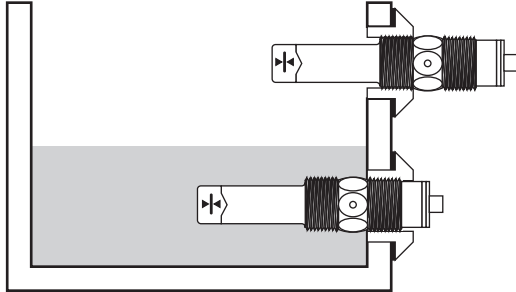

Multi-Point Installation:

Omega's LVM-10 series mounting system is an in-tank fitting which enables users to install up to four OMEGA sensors of any technology, to any depth, along the entire length of track. LVM-10 series may be installed through the top wall of any tank using a standard 2" NPT tank adapter. If no tank top installation is available, Omega's side mount bracket, LVM-30, enables LVM-10 series to be installed directly to the side wall of a tank.

Single-Point Installation:

Omega's LVM-50 series mounting system is an in-tank fitting which enables users to install one OMEGA sensor, of any technology, to a specific depth. The Omega sensor may be installed onto the 3/4" NPT adapter at the end of the LVM-50 series. LVM-50 series may be installed through the top wall of any tank using a standard 2" NPT tank adapter. Omega's side mount bracket, model LVM-30, may also be used if top wall installation is not available.

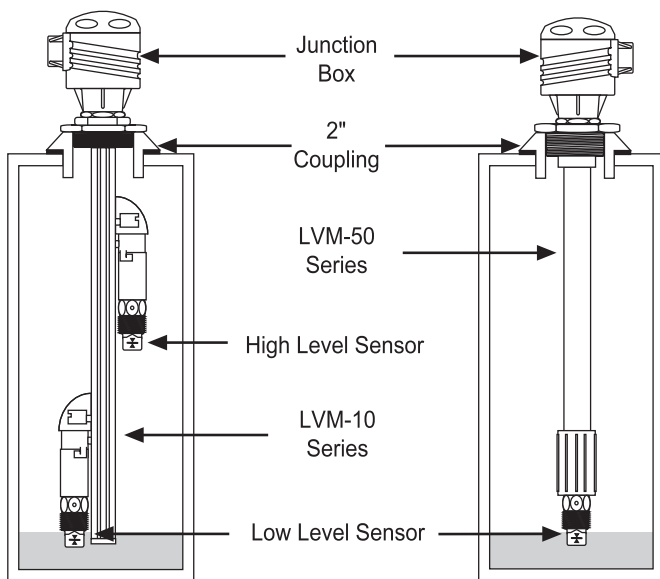

ELECTRICAL

Step Six

Supply Voltage:

The supply voltage to the powered level switch should never exceed a maximum of 36 VDC. Omega controllers have a built-in 13.5 VDC power supply which provides power to all of Omega's electrically powered sensors. Alternative controllers and power supplies, with a minimum output of 12 VDC up to a maximum output of 36 VDC, may also be used with the powered level switch.

Required Cable Length:

Determine the length of cable required between the powered level switch and its point of termination. Allow enough slack to ensure the easy installation, removal and/or maintenance of the sensor. The cable length may be extended up to a maximum of 1000 feet, using a well-insulated, 14 to 20 gauge shielded four conductor cable.

Wire Stripping:

Using a 10 gauge wire stripper, carefully remove the outer layer of insulation from the last 1-1/4" of the sensor's cable. Unwrap and discard the exposed foil shield from around the signal wires, leaving the drain wire attached if desired. With a 20 gauge wire stripper, remove the last 1/4" of the colored insulation from the signal wires.

Signal Outputs (Current sensing):

The standard method used by Omega controllers; this technology uses only two wires (Red and Black). The sensor draws 5 mA when it is dry, and 19 mA when wet. NC/NO status must be set by the controller. The White and Green wires are not used.

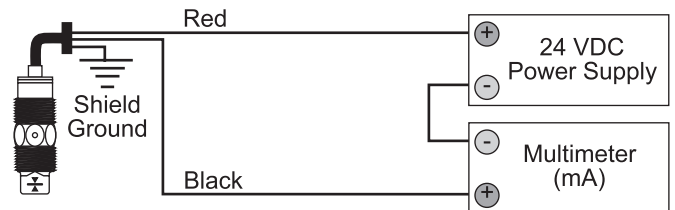

Signal Output (Relay switching):

Allows the sensor to switch a small load on or off directly, using an internal 1A relay (60 VAC/60 VDC). Omega's powered level switches features 4 wires (red, black, white and green) and a shield wire. The NO/NC status is set by the polarity of the voltage feeding the red and black wires. The green wire is the common for the relay and the white wire is the NO or NC, depending on the polarity of red and black.

Normally Open Wiring:

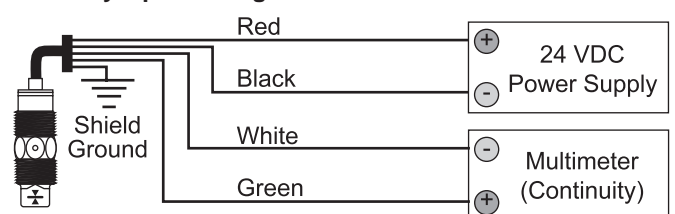

Normally Closed Wiring:

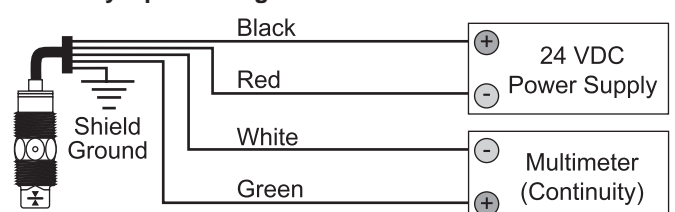

WIRING

Step Seven

Wiring to a Omega Controller: LVCN-110 Series Controller (4 or 20 mA signal output)

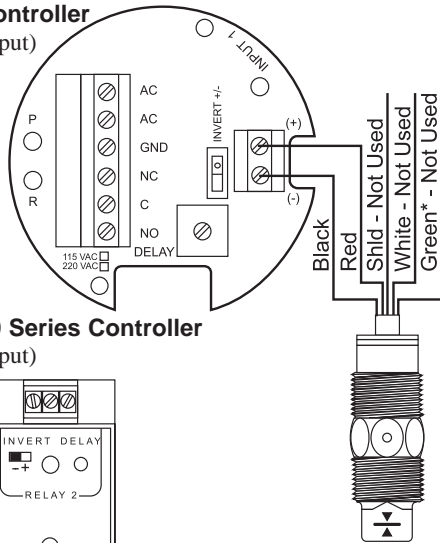

LCVN-120/-130/-140 Series Controller (4 or 20 mA signal output)

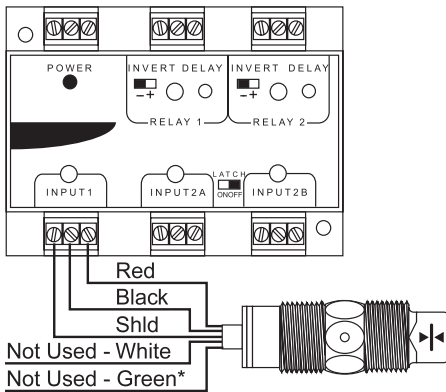

WIRING

Step Eight

Wiring the Relay Output:

The relay output can be wired as a dry contact to a VDC or VAC power source. Powered level switch does require 12 - 36 VDC power to operate the sensor and switch the relay. All illustrations below identify a Dry switch state as the normal position of the relay.

Switching a Normally Open DC Load:

The Red wire connects to Positive (+) of the power supply and the Black wire connects to Negative (-). The LOAD can be attached to either the Green or White wires. Complete the circuit by either connecting the Green to (+) VDC power or White to (-) VDC power (see illustration below).

[Dry Condition]

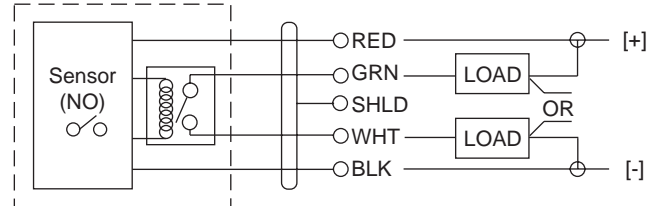

Switching a Normally Closed DC Load:

The Black wire connects to Positive (+) of the power supply and the Red wire connects to Negative (-). The LOAD can be attached to either the Green or White wires. Complete the circuit by either connecting the Green to (+) VDC power or White to (-) VDC power (see illustration below).

[Dry Condition]

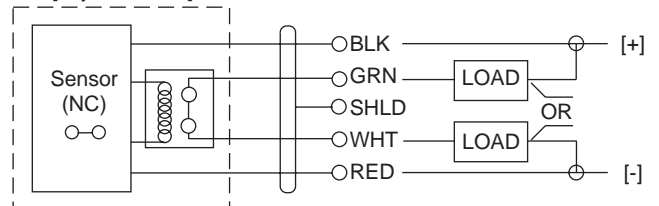

Switching a Normally Open AC Load:

The Red wire connects to Positive (+) of the DC power supply and the Black wire connects to Negative (-). The LOAD can be attached to the Green wire and the Hot of the VAC power. Connect the White to the Neutral of the VAC power (see illustration below).

[Dry Condition]

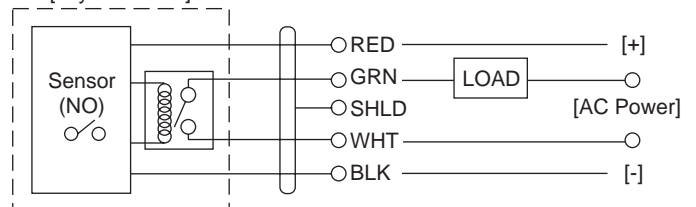

Switching a Normally Closed AC Load:

The Black wire connects to Positive (+) of the DC power supply and the Red wire connects to Negative (-). The LOAD can be attached to the Green wire and the Hot of the VAC power. Connect the White to the Neutral of the VAC power (see illustration below).

[Dry Condition]

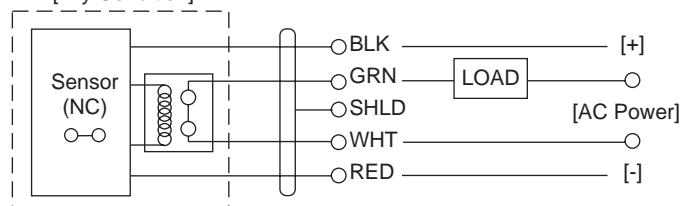

WIRING

Step Nine

Wiring as a P-Channel or N-Channel output:

The powered level switch can be substituted for either a P-Channel (PNP, sourcing) output or a N-Channel (NPN, sinking) output.

Normally Open DC Load as a P-Channel Output:

To wire as a NO P-Channel output, follow the directions below. The Red wire connects to Positive (+) of the power supply and the Black wire connects to Negative (-). The Green wire is jumpered to the Red wire while the White wire is connected to the LOAD. Jumper the LOAD back to the Negative (-) to complete the circuit.

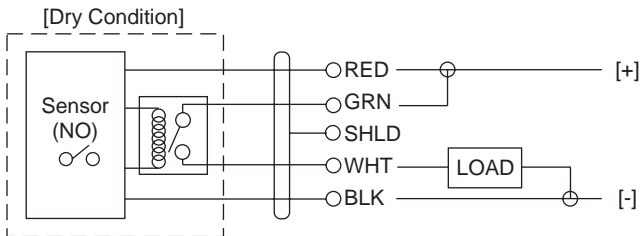

Normally Closed DC Load as a P-Channel Output:

To wire as a NC P-Channel output, follow the directions below. The Black wire connects to Positive (+) of the power supply and the Red wire connects to Negative (-). The Green wire is jumpered to the Black wire while the White wire is connected to the LOAD. Jumper the LOAD back to the Negative (-) to complete the circuit.

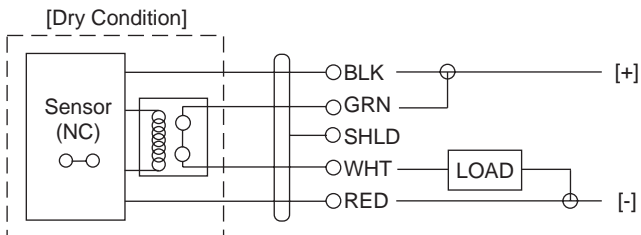

Normally Open DC Load as a N-Channel Output:

To wire as a NO N-Channel output, follow the directions below. The Red wire connects to Positive (+) of the power supply and the Black wire connects to Negative (-). The White wire is jumpered to the Black wire while the Green wire is connected to the LOAD. Jumper the LOAD back to the Positive (+) to complete the circuit.

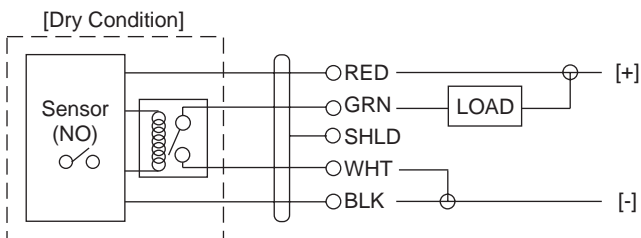

Normally Closed DC Load as a N-Channel Output:

To wire as a NC N-Channel output, follow the directions below. The Black wire connects to Positive (+) of the power supply and the Red wire connects to Negative (-). The White wire is jumpered to the Red wire while the White wire is connected to the LOAD. Jumper the LOAD back to the Positive (+) to complete the circuit.

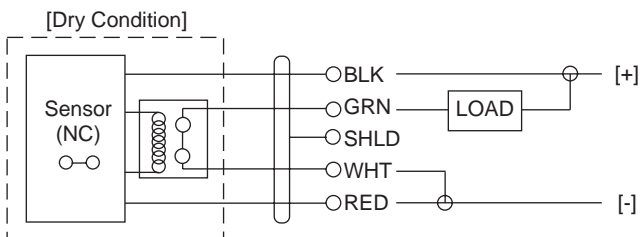

MAINTENANCE

Step Ten

General:

The powered level switch requires no periodic maintenance except cleaning as required. It is the responsibility of the user to determine the appropriate maintenance schedule, based on the specific characteristics of the application liquids.

Cleaning Procedure:

1. **Power:** Make Sure that all power to the sensor, controller and/or power supply is completely disconnected.
2. **Sensor Removal:** In all through-wall installations, make sure that the tank is drained well below the sensor prior to removal. Carefully, remove the sensor from the installation.
3. **Cleaning the Sensor:** Use a soft bristle brush and mild detergent, carefully wash the powered level switch. Do not use harsh abrasives such as steel wool or sandpaper, which might damage the surface sensor. Do not use incompatible solvents which may damage the sensor's PP, PFA, PVDF or Ryton plastic body.
4. **Sensor Installation:** Follow the appropriate steps of installation as outlined in the installation section of this manual.

Testing the installation:

1. **Power:** Turn on power to the controller and/or power supply.
2. **Immersing the switch:** Immerse the sensing tip in its application liquid, by filling the tank up to the switches point of actuation. An alternate method of immersing the switch during preliminary testing is to hold a cup filled with application liquid up to the switch's tip.
3. **Test:** With the switch being fluctuated between wet and dry states, the switch indicator light in the controller should turn on and off. If the controller doesn't have an input indicator, use a voltmeter or ammeter to ensure that the switch produces the correct signal.
4. **Point of actuation:** Observe the point at which the rising or falling fluid level causes the switch to change state, and adjust the installation of the switch if necessary.

Free Manuals Download Website

<http://myh66.com>

<http://usermanuals.us>

<http://www.somanuals.com>

<http://www.4manuals.cc>

<http://www.manual-lib.com>

<http://www.404manual.com>

<http://www.luxmanual.com>

<http://aubethermostatmanual.com>

Golf course search by state

<http://golfingnear.com>

Email search by domain

<http://emailbydomain.com>

Auto manuals search

<http://auto.somanuals.com>

TV manuals search

<http://tv.somanuals.com>