

CE

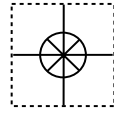

User's Guide

Shop online at

omega.com™

Ω OMEGA®

www.omega.com

e-mail: info@omega.com

ISO 9001
CERTIFIED
CORPORATE QUALITY

STAMFORD, CT

ISO 9002
CERTIFIED
CORPORATE QUALITY

MANCHESTER, UK

PH-2720-PA Preamplifier



OMEGAnet® Online Service www.omega.com	Internet e-mail info@omega.com
---	---

Servicing North America:

USA: One Omega Drive, P.O. Box 4047
ISO 9001 Certified Stamford CT 06907-0047
TEL: (203) 359-1660 FAX: (203) 359-7700
e-mail: info@omega.com

Canada: 976 Bergar
Laval (Quebec) H7L 5A1
TEL: (514) 856-6928 FAX: (514) 856-6886
e-mail: info@omega.ca

For immediate technical or application assistance:

USA and Canada: Sales Service: 1-800-826-6342 / 1-800-TC-OMEGA®
Customer Service: 1-800-622-2378 / 1-800-622-BEST®
Engineering Service: 1-800-872-9436 / 1-800-USA-WHEN®
TELEX: 996404 EASYLINK: 62968934 CABLE: OMEGA

Mexico: En Español: (001) 203-359-7803 e-mail: espanol@omega.com
FAX: (001) 203-359-7807 info@omega.com.mx

Servicing Europe:

Benelux: Postbus 8034, 1180 LA Amstelveen, The Netherlands
TEL: +31 (0)20 3472121 FAX: +31 (0)20 6434643
Toll Free in Benelux: 0800 0993344
e-mail: nl@omega.com

Czech Republic: Rudé armády 1868, 733 01 Karviná 8
TEL: +420 (0)69 6311899 FAX: +420 (0)69 6311114
Toll Free: 0800-1-66342 e-mail: czech@omega.com

France: 9, rue Denis Papin, 78190 Trappes
TEL: +33 (0)130 621 400 FAX: +33 (0)130 699 120
Toll Free in France: 0800-4-06342
e-mail: france@omega.com

Germany/Austria: Daimlerstrasse 26, D-75392 Deckenpfronn, Germany
TEL: +49 (0)7059 9398-0 FAX: +49 (0)7056 9398-29
Toll Free in Germany: 0800 639 7678
e-mail: germany@omega.com

United Kingdom: One Omega Drive, River Bend Technology Centre
ISO 9002 Certified Northbank, Irlam, Manchester
M44 5EX United Kingdom
TEL: +44 (0)161 777 6611 FAX: +44 (0)161 777 6622
Toll Free in United Kingdom: 0800-488-488
e-mail: sales@omega.co.uk

It is the policy of OMEGA to comply with all worldwide safety and EMC/EMI regulations that apply. OMEGA is constantly pursuing certification of its products to the European New Approach Directives. OMEGA will add the CE mark to every appropriate device upon certification.

The information contained in this document is believed to be correct, but OMEGA Engineering, Inc. accepts no liability for any errors it contains, and reserves the right to alter specifications without notice.

WARNING: These products are not designed for use in, and should not be used for, patient-connected applications.

OMEGA PH-2720-PA pH/ORP Preamplifier Instructions

WARNING!



SAFETY INSTRUCTIONS FOR IN-LINE ELECTRODE INSTALLATION

1. Do not remove from pressurized lines.
 2. Do not exceed maximum temperature/pressure specifications.
 3. Wear safety goggles or face shield during installation/service.
 4. Do not alter product construction.
- Failure to follow safety instructions may result in severe personal injury!



1. Wiring

Preamplifier: PH-2720-PA



pH Electrodes:
PHE-3271
PHE-2716

ORP Electrodes:
ORE-2715
ORE-2717

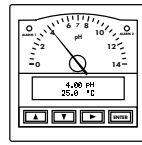

OMEGA
PHCN-5700

Preamplifier: PH-2720-PA



pH Electrodes:
PHE-3271
PHE-2716

ORP Electrodes:
ORE-2715
ORE-2717

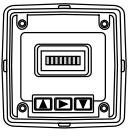

OMEGA
PHCN-5700

Preamplifier: PH-2720-PA



pH Electrodes:
PHE-3271
PHE-2716

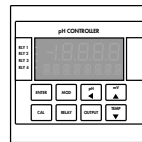

OMEGA
PHCN-90

- Use X1 gain selection

Preamplifier: PH-2720-PA



ORP Electrodes:
ORE-2715
ORE-2717

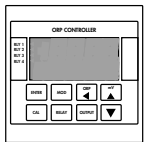
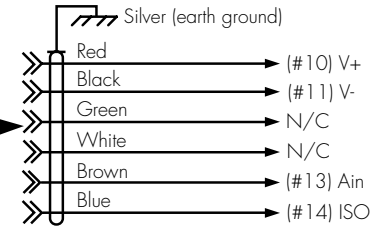

OMEGA
ORCN-90

- Use X1 gain selection

Technical Notes:

- Use 6-conductor shielded cable for cable extensions to 120 m (400 ft)
- Shield must be maintained through cable splice

2. Installation Fittings

Type	Description
<p>Plastic tees</p>	<ul style="list-style-type: none"> • 0.5 to 4 in. • PVC or CPVC • Mounts via glue-on fittings
<p>PVC glue-on saddles (O-ring not required)</p>	<ul style="list-style-type: none"> • 2 to 4 in., use 1-7/16 in. hole in pipe • Align wedge arrows with saddle arrows during assembly.
<p>Iron strap-on saddles</p>	<ul style="list-style-type: none"> • 2 to 4 in., use 1-7/16 in. hole in pipe

Type	Description
<p>Carbon steel weld-on weldolets</p>	<ul style="list-style-type: none"> • 2 to 4 in., use 1-7/16 in. hole in pipe • Remove insert before welding • Installed by certified welder only
<p>Carbon steel threaded tees</p>	<ul style="list-style-type: none"> • 0.5 to 2 in. • Mounts on threaded pipe ends
<p>Universal pipe adapter for large pipes</p>	<ul style="list-style-type: none"> • For existing pipe fittings 2 in. and up • External 1-1/4 inch NPT male threads

Consult OMEGA for additional fitting information.

3. Recommended Position

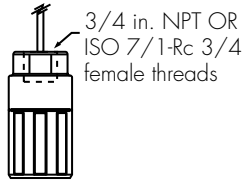

Customer supplied:

- 3/4 in. NPT nipple (male)
- J-box
- flex conduit

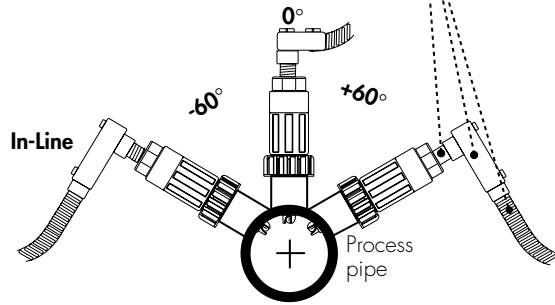

- Vertical (0°) position optimum
- 4 fps or less for max. performance and sensor life

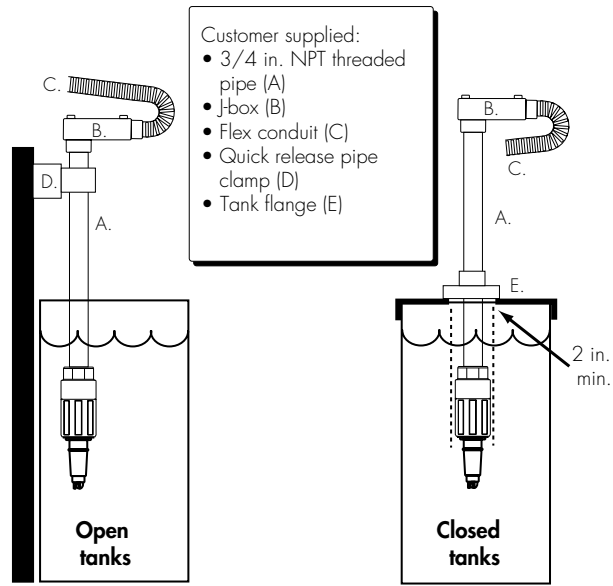

Caution: If liquid level is not constant, always ensure liquid contact with electrode tip

4. Installation

In-line Applications

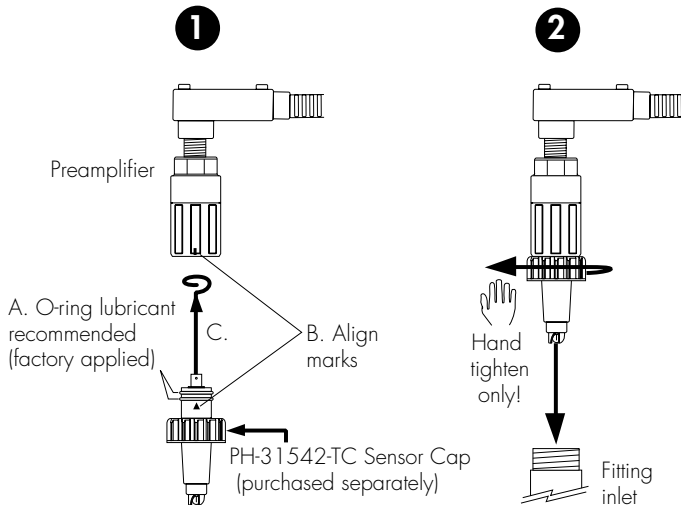

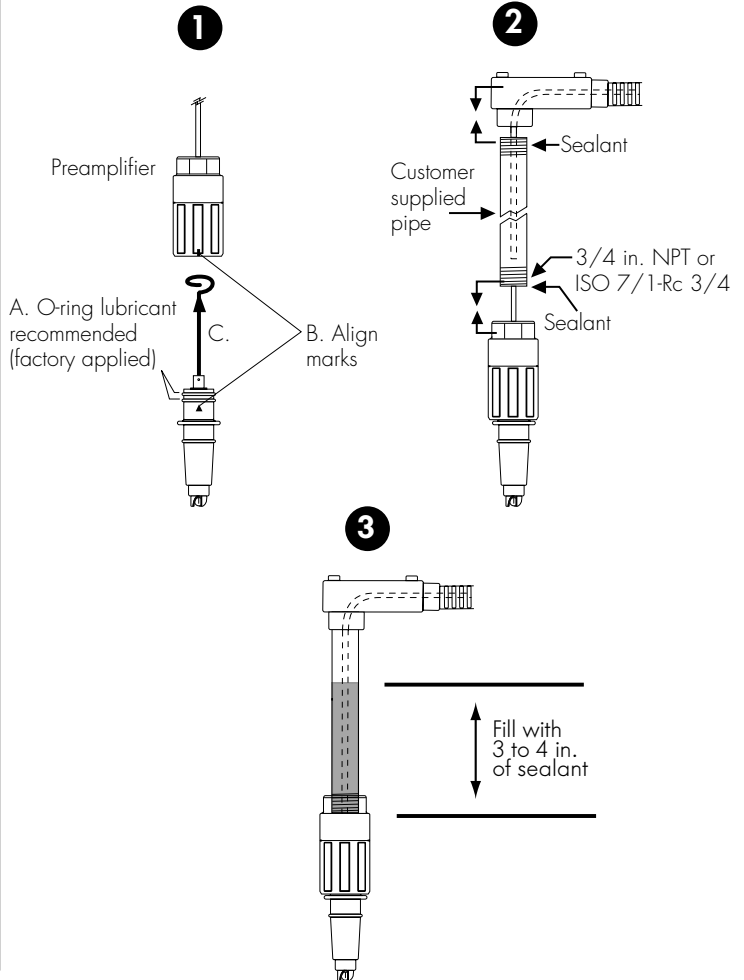

Submersible Applications



Attach 3/4 in. watertight pipe to the top of the preamplifier. Secure the threaded connection to prevent any leakage. For additional defense against possible accumulation of condensation at the back seal area of the sensor, fill the lower 3-4 inches (75-100 mm) of conduit or extension pipe with a flexible sealant such as silicone.

5. Accessories

Part no.	Description	Material
PH-31542-TC	Sensor cap 	PP
FPP-1220-0021 FPP-1224-0021 FPP-1228-0021	Sensor O-ring, 2 required 	Viton® EPR Kalrez



CAUTION!

When replacing O-rings, apply O-ring lubricant to sensor O-rings prior to preamplifier/electrode assembly. Unlubricated O-rings may score the preamplifier sealing surface.

6. Specifications

PH-2720-PA pH/ORP Preamplifier

Housing material:	CPVC
Compatible sensors:	PHE-3271 Flat Surface pH Electrode PHE-2716 Bulb pH Electrode ORE-2715 Flat Surface ORP Electrode ORE-2717 Bulb ORP Electrode
Input Impedance:	$>10^{11} \Omega$
Operating temp.:	0 to 80 °C
Gain:	X1 (unity)
Input power:	± 4.5 to ± 8 VDC, dual supply
Current consumption:	<1 mA, dual supply
Quality standard:	CE

Dimensions:

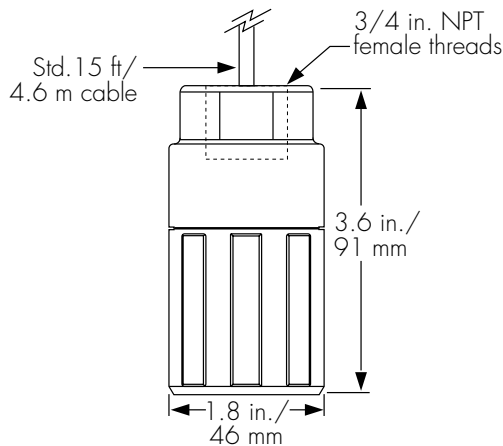

PHE Series pH Electrodes - ORE Series ORP Electrodes

General Specifications

Wetted parts:	
Sensor body:	CPVC
O-rings:	Viton®
Electrode junction:	Porous UHMW polyethylene
Quality standard:	CE

Maximum pressure/temperature ratings:

- 7 bar (100 psi) max. @ ≤ 65 °C (149 °F)
- 4 bar (58 psi) max. @ ≤ 85 °C (185 °F)

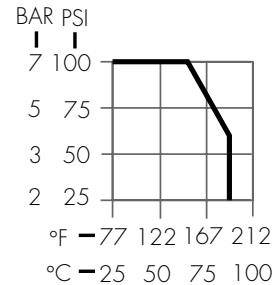

WARNING!

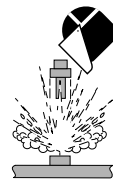

SAFETY INSTRUCTIONS FOR IN-LINE ELECTRODE INSTALLATION

1. Do not remove from pressurized lines.
2. Do not exceed maximum temperature/pressure specifications.
3. Do not install/service without following installation instructions (see sensor manual).
4. Wear safety goggles and faceshield during installation/service.
5. Do not alter product construction.
6. Failure to follow safety instructions could result in severe personal injury!

7. Preamplifier Troubleshooting

Procedure:

- A. Install sensor adapter into preamplifier
- B. With preamplifier and instrument connected, simulate pH 4, 7, and 10 and record displayed mV readings (right) and approximate preamplifier response time between simulations.
- C. Refer to table on next page for preamplifier troubleshooting tips.

Simulator Input	Actual displayed mV
4.00, +177 mV	_____
7.00, 0 mV	_____
10.00, -177 mV	_____
Preamplifier response time: _____	

With simulator connected	Error Condition	Possible Cause	Possible Remedy
	A) mV output stuck at zero B) mV output erratic C) mV output stuck at 1.4 VDC	A) Shorted input signal B) Faulty preamplifier or wiring C) Faulty preamplifier	A) Check preamplifier cable connections and shielding. B) Verify preamplifier shield connections. Verify cable shield wire has been maintained through each cable splice. C) Replace preamplifier
Ok with simulator connected but fails with electrode	A) mV output stuck near zero B) mV output erratic C) Output stuck at 1.4 VDC	A) Cracked electrode glass B1) Poor contact between electrode and preamplifier connectors B2) Fouled electrode reference or aged electrode B3) Ground loop C) Faulty preamplifier	A) Replace electrode B1) Check contacts between electrode and preamplifier. Contacts must be clean and dry. B2) Clean electrode, see electrode manual B3) Isolate electrode in test beaker. If output is stable, ground loops may exist causing erratic behavior; isolate instrument outputs (i.e. 4 to 20 mA, 0 to 5 VDC). C) Replace preamplifier

8. Electrode Maintenance and Cleaning

8.1 Maintenance

Variables can affect long term pH or ORP electrode life. For this reason, a maintenance log is recommended for trend analysis. When storing boxed sensors, lay the sensor flat to maximize hydration of the glass surface. Keep the glass surface wet at all times. Soak the sensor tip in pH 4.0 buffer during system maintenance intervals. In-line applications should be plumbed with a depression (trap) which ensures liquid is maintained around the sensor tip. If sensor dehydration has occurred, soak the sensor tip in pH 4 buffer for 24 to 48 hours, then visually inspect the electrode for surface cracks, swelling, or discoloration.

8.2 Cleaning

Cleaning techniques vary depending on the type of coating present on the glass electrode surface or reference junction.

- **Soft coatings:** can be removed by vigorous stirring, or with directed spray of an applicable detergent or solvent onto the glass electrode surface. Chlorine bleach or mild detergent may be used to remove soft coatings. Always rinse electrode tip in clean water after cleaning.

- **Hard coatings:** can be chemically removed. Always use the least harsh chemical which will remove the contaminant within two (2) minutes without attacking the materials of construction. e.g. calcium carbonate may be removed with a 5% HCL (muriatic acid) solution.
- **Oily or Organic Coatings:** can be removed with detergents or an appropriate solvent that does not attack the materials of construction e.g. isopropyl alcohol may be used but acetone must be avoided to prevent damage to the CPVC sensor body.
- **ORP electrode surface (platinum rod):** can be gently sanded with 600 grit wet and dry silicone or carbide sandpaper, jewelers rouge, crocus cloth, or very fine steel wool.



WARNING!

When using chemicals or solvents care should be taken and appropriate eye, face, hand, body, and/or respiratory protection should be used.



WARRANTY/DISCLAIMER

OMEGA ENGINEERING, INC. warrants this unit to be free of defects in materials and workmanship for a period of **13 months** from date of purchase. OMEGA's WARRANTY adds an additional one (1) month grace period to the normal **one (1) year product warranty** to cover handling and shipping time. This ensures that OMEGA's customers receive maximum coverage on each product.

If the unit malfunctions, it must be returned to the factory for evaluation. OMEGA's Customer Service Department will issue an Authorized Return (AR) number immediately upon phone or written request. Upon examination by OMEGA, if the unit is found to be defective, it will be repaired or replaced at no charge. OMEGA's WARRANTY does not apply to defects resulting from any action of the purchaser, including but not limited to mishandling, improper interfacing, operation outside of design limits, improper repair, or unauthorized modification. This WARRANTY is VOID if the unit shows evidence of having been tampered with or shows evidence of having been damaged as a result of excessive corrosion; or current, heat, moisture or vibration; improper specification; misapplication; misuse or other operating conditions outside of OMEGA's control. Components which wear are not warranted, including but not limited to contact points, fuses, and triacs.

OMEGA is pleased to offer suggestions on the use of its various products. However, OMEGA neither assumes responsibility for any omissions or errors nor assumes liability for any damages that result from the use of its products in accordance with information provided by OMEGA, either verbal or written. OMEGA warrants only that the parts manufactured by it will be as specified and free of defects. OMEGA MAKES NO OTHER WARRANTIES OR REPRESENTATIONS OF ANY KIND WHATSOEVER, EXPRESS OR IMPLIED, EXCEPT THAT OF TITLE, AND ALL IMPLIED WARRANTIES INCLUDING ANY WARRANTY OF MERCHANTABILITY AND FITNESS FOR A PARTICULAR PURPOSE ARE HEREBY DISCLAIMED. LIMITATION OF LIABILITY: The remedies of purchaser set forth herein are exclusive, and the total liability of OMEGA with respect to this order, whether based on contract, warranty, negligence, indemnification, strict liability or otherwise, shall not exceed the purchase price of the component upon which liability is based. In no event shall OMEGA be liable for consequential, incidental or special damages.

CONDITIONS: Equipment sold by OMEGA is not intended to be used, nor shall it be used: (1) as a "Basic Component" under 10 CFR 21 (NRC), used in or with any nuclear installation or activity; or (2) in medical applications or used on humans. Should any Product(s) be used in or with any nuclear installation or activity, medical application, used on humans, or misused in any way, OMEGA assumes no responsibility as set forth in our basic WARRANTY / DISCLAIMER language, and, additionally, purchaser will indemnify OMEGA and hold OMEGA harmless from any liability or damage whatsoever arising out of the use of the Product(s) in such a manner.

RETURN REQUESTS/INQUIRIES

Direct all warranty and repair requests/inquiries to the OMEGA Customer Service Department. BEFORE RETURNING ANY PRODUCT(S) TO OMEGA, PURCHASER MUST OBTAIN AN AUTHORIZED RETURN (AR) NUMBER FROM OMEGA'S CUSTOMER SERVICE DEPARTMENT (IN ORDER TO AVOID PROCESSING DELAYS). The assigned AR number should then be marked on the outside of the return package and on any correspondence.

The purchaser is responsible for shipping charges, freight, insurance and proper packaging to prevent breakage in transit.

FOR **WARRANTY** RETURNS, please have the following information available BEFORE contacting OMEGA:

1. Purchase Order number under which the product was PURCHASED,
2. Model and serial number of the product under warranty, and
3. Repair instructions and/or specific problems relative to the product.

FOR **NON-WARRANTY** REPAIRS, consult OMEGA for current repair charges. Have the following information available BEFORE contacting OMEGA:

1. Purchase Order number to cover the COST of the repair,
2. Model and serial number of the product, and
3. Repair instructions and/or specific problems relative to the product.

OMEGA's policy is to make running changes, not model changes, whenever an improvement is possible. This affords our customers the latest in technology and engineering.

OMEGA is a registered trademark of OMEGA ENGINEERING, INC.

© Copyright 2000 OMEGA ENGINEERING, INC. All rights reserved. This document may not be copied, photocopied, reproduced, translated, or reduced to any electronic medium or machine-readable form, in whole or in part, without the prior written consent of OMEGA ENGINEERING, INC.

Where Do I Find Everything I Need for Process Measurement and Control? OMEGA...Of Course!

Shop online at www.omega.com

TEMPERATURE

- Thermocouple, RTD & Thermistor Probes, Connectors, Panels & Assemblies
- Wire: Thermocouple, RTD & Thermistor
- Calibrators & Ice Point References
- Recorders, Controllers & Process Monitors
- Infrared Pyrometers

PRESSURE, STRAIN AND FORCE

- Transducers & Strain Gages
- Load Cells & Pressure Gages
- Displacement Transducers
- Instrumentation & Accessories

FLOW/LEVEL

- Rotameters, Gas Mass Flowmeters & Flow Computers
- Air Velocity Indicators
- Turbine/Paddlewheel Systems
- Totalizers & Batch Controllers

pH/CONDUCTIVITY

- pH Electrodes, Testers & Accessories
- Benchtop/Laboratory Meters
- Controllers, Calibrators, Simulators & Pumps
- Industrial pH & Conductivity Equipment

DATA ACQUISITION

- Data Acquisition & Engineering Software
- Communications-Based Acquisition Systems
- Plug-in Cards for Apple, IBM & Compatibles
- Datalogging Systems
- Recorders, Printers & Plotters

HEATERS

- Heating Cable
- Cartridge & Strip Heaters
- Immersion & Band Heaters
- Flexible Heaters
- Laboratory Heaters

ENVIRONMENTAL MONITORING AND CONTROL

- Metering & Control Instrumentation
- Refractometers
- Pumps & Tubing
- Air, Soil & Water Monitors
- Industrial Water & Wastewater Treatment
- pH, Conductivity & Dissolved Oxygen Instruments

Free Manuals Download Website

<http://myh66.com>

<http://usermanuals.us>

<http://www.somanuals.com>

<http://www.4manuals.cc>

<http://www.manual-lib.com>

<http://www.404manual.com>

<http://www.luxmanual.com>

<http://aubethermostatmanual.com>

Golf course search by state

<http://golfingnear.com>

Email search by domain

<http://emailbydomain.com>

Auto manuals search

<http://auto.somanuals.com>

TV manuals search

<http://tv.somanuals.com>