

CE

MADE IN  
USA

# iSeries®



## Process/Strain Gauge Controller Manual CNiS8, CNiS8C, CNiS8DH, CNiS8DV, CNiS16, CNiS16D, CNiS32

# User's Guide

Shop on line at

**omega.com**®

Ω OMEGA®

[omega.com](http://omega.com)

e-mail: [info@omega.com](mailto:info@omega.com)

iSeries info:

[omega.com/specs/iseries](http://omega.com/specs/iseries)

For latest product manuals

[omegamanual.info](http://omegamanual.info)



<b>OMEGAnet® On-Line Service</b> <a href="http://www.omega.com">www.omega.com</a>	<b>Internet e-mail</b> <a href="mailto:info@omega.com">info@omega.com</a>
--	--

### **Servicing North America:**

**USA:**  
ISO 9001 Certified One Omega Drive, P.O. Box 4047  
Stamford CT 06907-0047  
TEL: (203) 359-1660 FAX: (203) 359-7700  
e-mail: [info@omega.com](mailto:info@omega.com)

**Canada:**  
976 Berger  
Laval (Quebec) H7L 5A1  
TEL: (514) 856-6928 FAX: (514) 856-6886  
e-mail: [info@omega.ca](mailto:info@omega.ca)

### **For immediate technical or application assistance:**

**USA and Canada:** Sales Service: 1-800-826-6342 / 1-800-TC-OMEGA®  
Customer Service: 1-800-622-2378 / 1-800-622-BEST®  
Engineering Service: 1-800-872-9436 / 1-800-USA-WHEN®

**Mexico and Latin America:** TEL: (001) 203-359-7803 FAX: (001) 203-359-7807  
e-mail: [espanol@omega.com](mailto:espanol@omega.com)

### **Servicing Europe:**

**Benelux:** TEL: +31 20 3472121 FAX: +31 20 6434643  
Toll Free in Benelux: 0800 0993344  
e-mail: [sales@omegaeng.nl](mailto:sales@omegaeng.nl)

**Czech Republic:** Frystatska 184, 733 01 Karviná  
TEL: +420 59 6311899 FAX: +420 59 6311114  
e-mail: [info@omegashop.cz](mailto:info@omegashop.cz)

**France:** TEL: +33 1 61 37 29 00 FAX: +33 1 30 57 54 27  
Toll Free in France: 0800 466 342  
e-mail: [sales@omega.fr](mailto:sales@omega.fr)

**Germany/Austria:** Daimlerstrasse 26, D-75392 Deckenpfronn, Germany  
TEL: +49 7056 9398-0 FAX: +49 7056 9398-29  
Toll Free in Germany: 0800 639 7678  
e-mail: [info@omega.de](mailto:info@omega.de)

**United Kingdom:**  
ISO 9001 Certified One Omega Drive  
River Bend Technology Centre  
Northbank, Irlam Manchester M44 5BD United Kingdom  
TEL: +44 161 777 6611 FAX: +44 161 777 6622  
Toll Free in England: 0800 488 488  
e-mail: [sales@omega.co.uk](mailto:sales@omega.co.uk)

---

It is the policy of OMEGA to comply with all worldwide safety and EMC/EMI regulations that apply. OMEGA is constantly pursuing certification of its products to the European New Approach Directives. OMEGA will add the CE mark to every appropriate device upon certification.

The information contained in this document is believed to be correct but OMEGA Engineering, Inc. accepts no liability for any errors it contains, and reserves the right to alter specifications without notice.

**WARNING:** These products are not designed for use in, and should not be used for, patient connected applications.



This device is marked with the international caution symbol. It is important to read the Setup Guide before installing or commissioning this device as it contains important information relating to safety and EMC.

# TABLE OF CONTENTS

<b>Part 1: Introduction</b> .....	<b>2</b>
1.1 Description .....	2
1.2 Safety Considerations .....	3
1.3 Before You Begin .....	4
<b>Part 2: Setup</b> .....	<b>5</b>
2.1 Front Panel .....	5
2.2 Rear Panel Connections .....	5
2.3 Electrical Installation .....	7
2.3.1 Power Connections .....	7
2.3.2 Process Current .....	8
2.3.3 Process Voltage .....	8
2.3.4 Strain Gauge .....	9
2.3.5 Wiring Outputs - Wiring Hookup .....	10
<b>Part 3: Operation: Configuration Mode</b> .....	<b>13</b>
3.1 Introduction .....	13
Turning your Instrument On for the First Time	
Buttons Functions in Configuration Mode	
3.2 Menu Configuration .....	14
3.2.1 ID Number .....	15
3.2.2 Set Points Menu .....	16
3.2.3 Configuration Menu .....	17
3.2.4 Input Type Menu .....	17
3.2.5 Reading Configuration Menu .....	19
3.2.6 Input/Reading (Scale and Offset) Menu .....	22
3.2.7 Alarm 1 Menu .....	26
3.2.8 Analog Output (Retransmission) Menu .....	30
3.2.9 Alarm 2 Menu .....	33
3.2.10 Loop Break Time Menu .....	34
3.2.11 Output 1 Menu .....	36
3.2.12 Output 2 Menu .....	43
3.2.13 Ramp and Soak Menu .....	46
3.2.14 ID Code Menu .....	48
3.2.15 Communication Option Menu .....	50
3.2.16 Display Color Selection Menu .....	56
<b>Part 4: Specifications</b> .....	<b>59</b>
<b>Part 5: Factory Preset Values</b> .....	<b>62</b>
<b>CE APPROVAL INFORMATION</b> .....	<b>64</b>

## LIST OF FIGURES:

Figure 2.1	Front Panel Display .....	5
Figure 2.2	Rear Panel Power and Output Connections .....	5
Figure 2.3	Rear Panel Input Connections .....	6
Figure 2.4	Main Power Connections .....	7
Figure 2.5	Process Current Wiring Hookup .....	8
	Process Voltage	
Figure 2.6	a) Process Voltage with Sensor Excitation .....	8
	b) Process Voltage without Sensor Excitation .....	8
	Strain Gauge	
Figure 2.7	a) 4-Wire Voltage Input with Internal Excitation.....	9
	b) 4-Wire Bridge Input with External Excitation.....	9
Figure 2.8	a) 6-Wire Voltage Input with Internal Excitation.....	9
	b) 6-Wire Bridge Input with External Excitation.....	9
Figure 2.9	4-Wire Voltage Input with Internal Excitation.....	10
	Wiring Outputs	
Figure 2.10	a) Mechanical Relay and SSR Outputs Wiring Hookup .....	10
	b) Pulse and Analog Outputs Wiring Hookup .....	10
Figure 2.11	Snubber Circuits Wiring Hookup .....	10
Figure 2.12	a) RS-232 Output Wiring Hookup .....	11
	b) RS-485 Outputs Wiring Hookup .....	11
Figure 2.13	Typical Applications .....	12
Figure 2.14	a) Excitation Outputs .....	12
	b) Top View Location of S2 .....	12
	c) Top View Location of S2 on 1/8 DIN Compact Unit .....	12
Figure 3.1	Flow Chart for ID and Setpoints Menu .....	14
Figure 3.2	Flow Chart for Configuration Menu .....	17
Figure 3.3	Flow Chart for Input Type Menu .....	17
Figure 3.4	Flow Chart for Reading Configuration Menu .....	19
Figure 3.5	Flow Chart for Alarm 1 Menu .....	26
Figure 3.6	Flow Chart for Analog Output (Retransmission) Menu.....	30
Figure 3.7	Flow Chart for Alarm 2 Menu .....	33
Figure 3.8	Flow Chart for Loop Break Time Menu .....	34
Figure 3.9	Flow Chart for Output 1 Menu .....	36
Figure 3.10	Flow Chart for Output 2 Menu .....	43
Figure 3.11	Flow Chart for Ramp and Soak Menu .....	46
Figure 3.12	Flow Chart for ID Code Menu .....	48
Figure 3.13	Flow Chart for Communication Option Menu .....	50
Figure 3.14	Flow Chart for Display Color Selection Menu.....	56

## LIST OF TABLES:

Table 2.1	Front Panel Display .....	5
Table 2.2	Rear Panel Connector .....	6
Table 2.3	Fuse Requirements .....	7
Table 2.4	Jumper Connections .....	12
Table 3.1	Button Function in Configuration Mode.....	13
Table 3.2	Conversion Table .....	23
Table 3.3	Input Resolution Multiplier .....	23
Table 5.1	Factory Preset Values .....	62

## NOTES, WARNINGS and CAUTIONS

Information that is especially important to note is identified by following labels:

- **NOTE**
- **WARNING or CAUTION**
- **IMPORTANT**
- **TIP**

**Note** ES

**NOTE:** Provides you with information that is important to successfully setup and use the Programmable Digital Meter.



**CAUTION or WARNING:** Tells you about the risk of electrical shock.



**CAUTION, WARNING or IMPORTANT:** Tells you of circumstances or practices that can effect the instrument's functionality and must refer to accompanying documents.

**Tip** ES

**TIP:** Provides you helpful hints.

# PART 1

## INTRODUCTION

### 1.1 Description

**Note**

This device can be purchased as monitor (read process value only) or as a controller.

- The i Series Strain and Process controllers can measure a wide variety of DC voltage and current inputs for all common load cells, pressure transducers and strain gauge type of transducer. It offers unparalleled flexibility in process control. The voltage /current inputs are fully scaleable to virtually all engineering units, with selectable decimal point, perfect for use with pressure, flow or other process input.
- The process control can be achieved by using on/off or PID control strategy. Control can be optimized with an Auto Tune feature. The controller offers a ramp to set point with timed soak period before switching off the output.
- The i Series controller features a large, three color programmable display with capability to change a color every time when Alarm is triggered. The standard features include dual outputs with relay, SSR, DC pulse, analog voltage or current, built-in excitation for transducers, selectable as 10V @ 60 mA or 5 V @ 40 mA. Analog output is fully scaleable and may be configured as a proportional controller or retransmission to follow your display. Universal power supply accepts 90 to 240. Low voltage power option accepts 24 Vac or 12 to 36 Vdc.
- Options include programmable RS-232 or RS-485 serial communication and ethernet with an embedded web server.

## 1.2 Safety Considerations

---



This device is marked with the **international caution symbol**. It is **important to read** this manual before installing or commissioning this device as it contains important information relating to **Safety and EMC** (Electromagnetic Compatibility).

---

This instrument is a panel mount device protected in accordance with EN 61010-1:2001, electrical safety requirements for electrical equipment for measurement, control and laboratory. Installation of this instrument should be done by qualified personnel. In order to ensure safe operation, the following instructions should be followed.



This instrument has **no power-on switch**. An external **switch or circuit-breaker** shall be included in the building installation as a disconnecting device. It shall be marked to indicate this function, and it shall be in close proximity to the equipment within easy reach of the operator. The switch or circuit-breaker shall not interrupt the Protective Conductor (Earth wire), and it shall meet the relevant requirements of IEC 947-1 and IEC 947-3 (International Electrotechnical Commission). The switch shall not be incorporated in the main supply cord.



Furthermore, to provide protection against **excessive energy** being drawn from the main supply in case of a fault in the equipment, an **overcurrent** protection device shall be installed.



- Do not exceed voltage rating on the label located on the top of the instrument housing.
- Always disconnect power before changing signal and power connections.
- Do not use this instrument on a work bench without its case for safety reasons.
- Do not operate this instrument in flammable or explosive atmospheres.
- Do not expose this instrument to rain or moisture.
- Unit mounting should allow for adequate ventilation to ensure instrument does not exceed operating temperature rating.
- Use electrical wires with adequate size to handle mechanical strain and power requirements. Install without exposing bare wire outside the connector to minimize electrical shock hazards.

### EMC Considerations

- Whenever EMC is an issue, always use shielded cables.
- Never run signal and power wires in the same conduit.
- Use signal wire connections with twisted-pair cables.
- Install Ferrite Bead(s) on signal wires close to the instrument if EMC problems persist.

**Failure to follow all instructions and warnings may result in injury!**

## 1.3 Before You Begin

### Inspecting Your Shipment:

Remove the packing slip and verify that you have received everything listed. Inspect the container and equipment for signs of damage as soon as you receive the shipment. Note any evidence of rough handling in transit. Immediately report any damage to the shipping agent. The carrier will not honor damage claims unless all shipping material is saved for inspection. After examining and removing the contents, save the packing material and carton in the event reshipment is necessary.

### Customer Service:

If you need assistance, please call the nearest Customer Service Department, listed in this manual.

### Manuals, Software:

The latest Operation and Communication Manual as well as free configuration software and ActiveX controls are available at **the website listed on the cover page of this manual or on the CD-ROM enclosed with your shipment.**

**Tip** 



For first-time users: Refer to the QuickStart Manual for basic operation and set-up instructions.

**Tip** 

If you have the Serial Communications/Ethernet Option you can easily configure the controller on your computer or on-line.

### To Disable Outputs:

To ensure that menu changes are properly stored, Standby Mode should be used during setup of the instrument. During Standby Mode, the instrument remains in a ready condition, but all outputs are disabled. Standby Mode is useful when maintenance of the system is necessary.

When the instrument is in "RUN" Mode, **push  twice** to disable all outputs and alarms. It is now in "STANDBY" Mode. **Push  once** more to resume "RUN" Mode.

**Tip** 

**PUSH  TWICE** to disable the system during an **EMERGENCY**.

### To Reset the Meter:

When the controller is in the "MENU" Mode, **push  once** to direct controller one step backward of the top menu item.

**Push  twice** to reset controller, prior to resuming "Run" Mode except after "Alarms", that will go to the "Run" Mode without resetting the controller.



**PART 2  
SETUP  
2.1 Front Panel**

**Note** Refer to the Quick Start Guide for assembly and disassembly instructions.

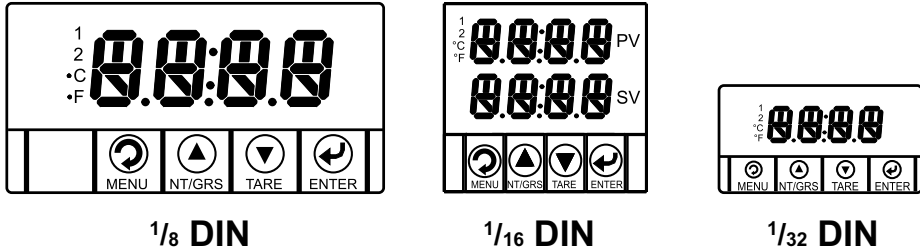

**Figure 2.1 Front Panel Display**

**Table 2.1 Front Panel Annunciators**

<b>1</b>	Output 1/Setpoint 1/ Alarm 1 indicator
<b>2</b>	Output 2/Setpoint 2/ Alarm 2 indicator
	Changes display to Configuration Mode and advances through menu items*
	Used in Program Mode and Peak or Gross Recall*
	Used in Program Mode and to tare your reading*
	Accesses submenus in Configuration Mode and stores selected values*

\* See Part 3 Operation: Configuration Mode

**2.2 Rear Panel Connections**

The rear panel connections are shown in Figures 2.2 and 2.3.

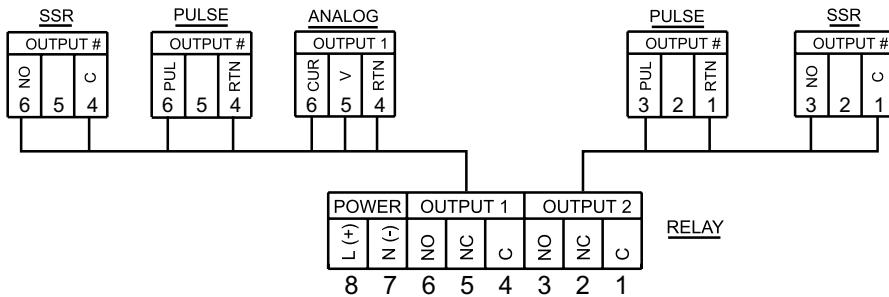

**Figure 2.2 Rear Panel Power and Output Connections**

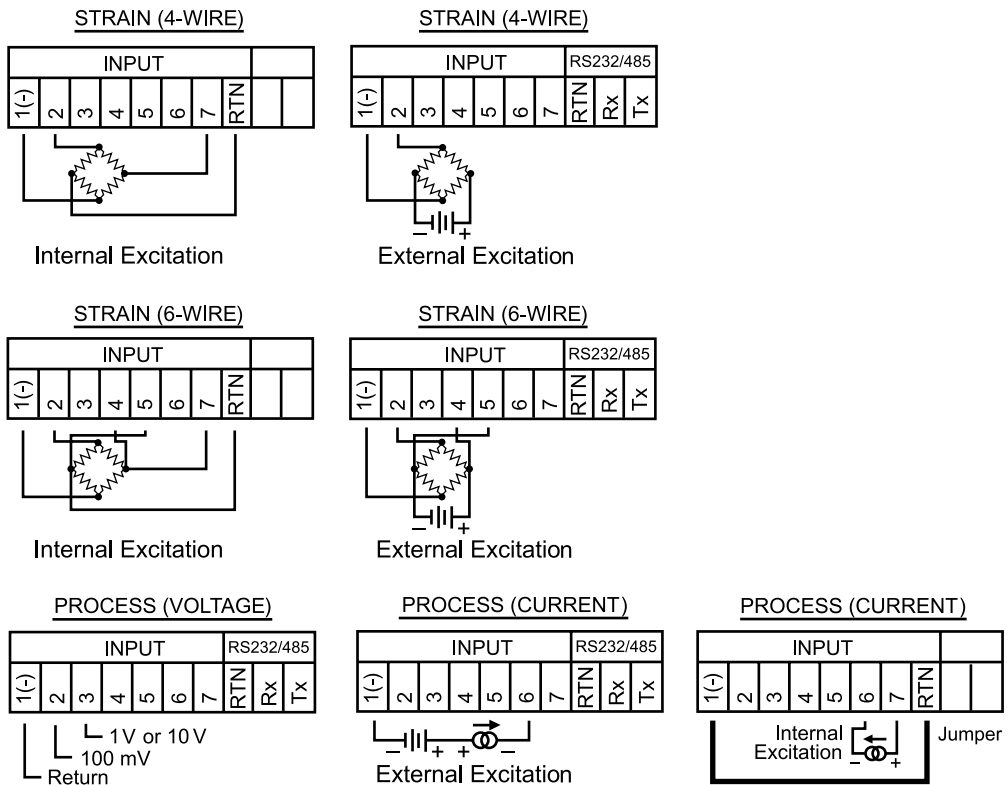

**Figure 2.3 Rear Panel Input Connections**

**Table 2.2 Rear Panel Connector**

<b>POWER</b>	AC/DC Power Connector: All models
<b>INPUT</b>	Input Connector: All models PR (Process) / ST (Strain)
<b>OUTPUT 1</b>	Based on one of the following models: Relay SPDT Solid State Relay Pulse Analog Output (Voltage and Current)
<b>OUTPUT 2</b>	Based on one of the following models: Relay SPDT Solid State Relay Pulse
<b>OPTION</b>	Based on one of the following models: RS-232C or RS-485 programmable Excitation

## 2.3 Electrical Installation

### 2.3.1 Power Connections



**Caution:** Do not connect power to your device until you have completed all input and output connections. Failure to do so may result in injury!

Connect the main power connections as shown in Figure 2.4.

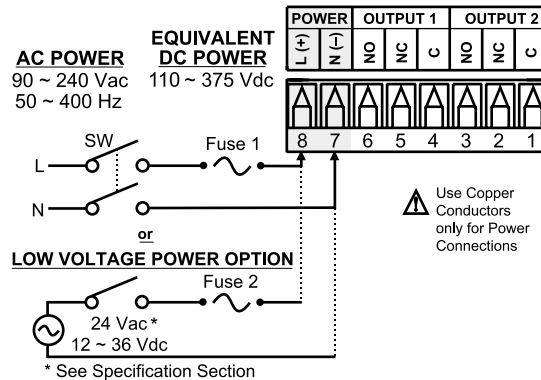

**Figure 2.4 Main Power Connections**

**Table 2.3 Fuse Requirements**

FUSE	Connector	Output Type	For 115 Vac	For 230 Vac	DC
FUSE 1	Power *	N/A	100 mA(T)	100 mA(T)	100 mA(T)
FUSE 2	Power *	N/A	N/A	N/A	400 mA(T)



For the low voltage power option, in order to maintain the same degree of protection as the standard high voltage input power units (90 - 240 Vac), always use a Safety Agency Approved DC or AC source with the same Overvoltage Category and pollution degree as the standard AC unit (90 - 240 Vac).



The Safety European Standard EN61010-1 for measurement, control, and laboratory equipment requires that fuses must be specified based on IEC127. This standard specifies for a Time-lag fuse, the letter code "T". The above recommended fuses are of the type IEC127-2-sheet III. Be aware that there are significant differences between the requirements listed in the UL 248-14/CSA 248.14 and the IEC 127 fuse standards. As a result, no single fuse can carry all approval listings. A 1.0 Amp IEC fuse is approximately equivalent to a 1.4 Amp UL/CSA fuse. It is advised to consult the manufacturer's data sheets for a cross-reference.

### 2.3.2 Process Current

The figure below shows the wiring hookup for Process Current 0 – 20 mA.

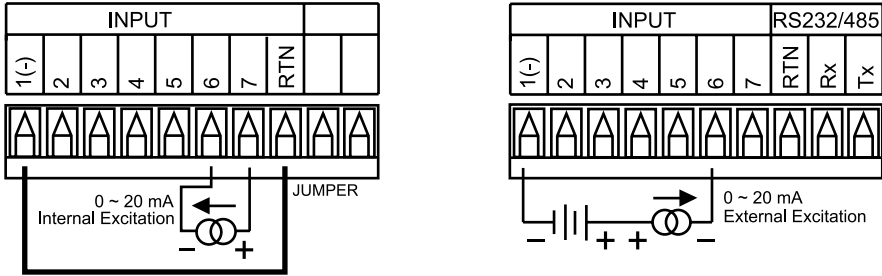

**Figure 2.5 Process Current Wiring Hookup (Internal and External Excitation)**

### 2.3.3 Process Voltage

The figure below shows the wiring hookup for Process Voltage 0 – 100 mV, 0 – 1 V, 0 – 10 V.

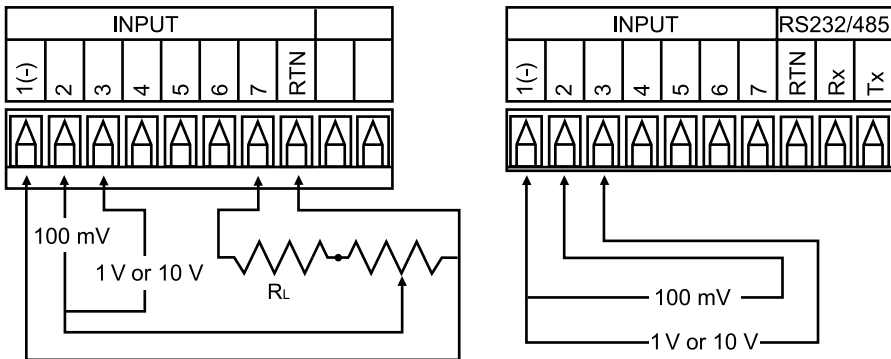

**Figure 2.6**

- a) Process Voltage Wiring Hookup with Sensor Excitation      b) Process Voltage Wiring Hookup without Sensor Excitation

**RL** - Voltage limited resistor, which allows to convert 24 Vdc internal excitation voltage to the appropriate process input value. For instance: if the potentiometer value is equal to 10 kΩ, the minimum RL is 14 kΩ for 10 V process input.

When configuring your instrument, select Process Type in the Input Type Menu (see Part 3).

### 2.3.4 Strain Gauge

The figure below shows the wiring hookup for 4-wire bridge input.

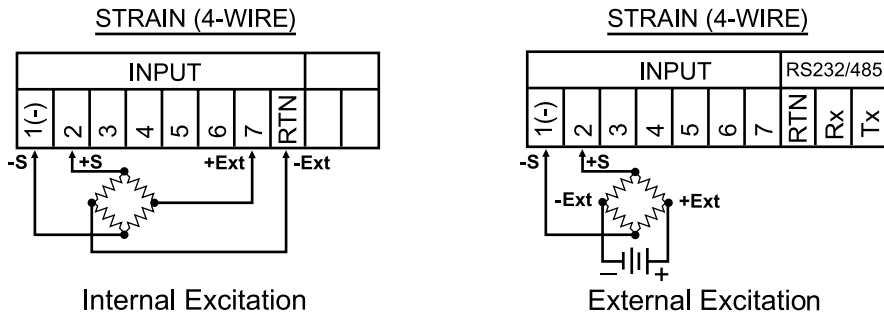

**Figure 2.7**

**a) 4-Wire Voltage/Bridge Input with Internal Excitation Wiring Hookup**

**b) 4-Wire Bridge Input with External Excitation Wiring Hookup**

In 4-Wire connections the voltage drop across long excitation lead wires of strain gauge bridge may cause measurement errors. The output of a strain gauge bridge also depends on the stability of excitation voltage. To correct for voltage drop and changes in excitation voltage, 6-wire input configuration and ratio measurement are used.

**Note** In order for the Ratiometric to work properly, the External Excitation should not drop below 4.6 Vdc.

The figure below shows 6-wire hookup for 6-wire bridge input.

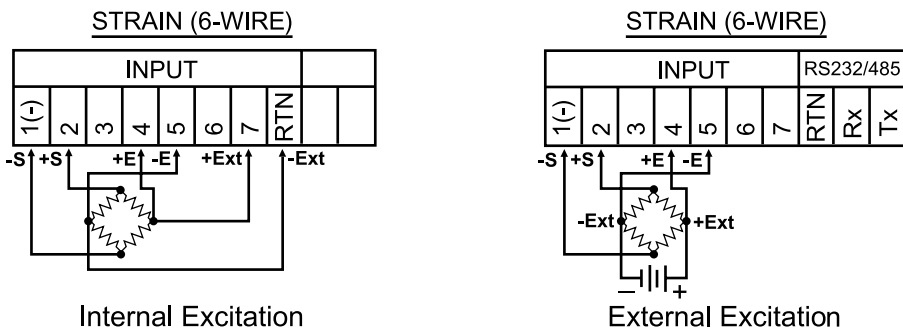

**Figure 2.8**

**a) 6-Wire Bridge Input with Internal Excitation and Ratio Measurement Wiring Hookup**

**b) 6-Wire Bridge Input with External Excitation and Ratio Measurement Wiring Hookup**

### 2.3.4 Strain Gauge (continued)

The figure below shows Voltage (bridge with amplified output) input with internal excitation.

Where:

- +S: signal plus
- S: signal return
- +Ext: excitation plus
- Ext: excitation return
- +E: plus excitation sense
- E: minus excitation sense.

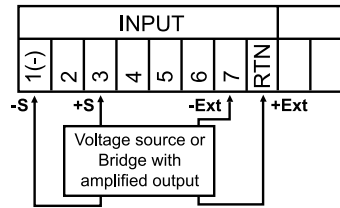

**Figure 2.9**  
**4-Wire Voltage Input (Bridge with Amplified Output) with Internal Excitation.**

### 2.3.5 Wiring Outputs

This meter has two, factory installed, outputs. The SPDT Mechanical Relay, SPST Solid State Relay, Pulse and Analog Output Connection are shown below.

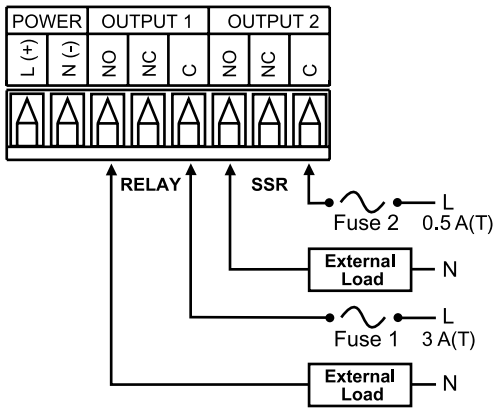

**Figure 2.10 a) Mechanical Relay and SSR Outputs Wiring Hookup**

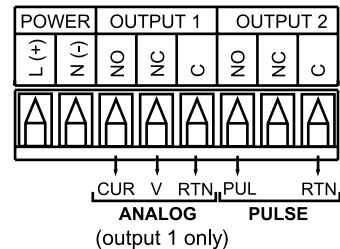

**⚠** Use Copper Conductors only for Power Connections

**b) Pulse and Analog Outputs Wiring Hookup**

**Note**

This device has snubber circuits designed to protect the contacts of the mechanical relays when it switches inductive loads (i.e. solenoids, relays). These snubbers are internally connected between the Common (C) and Normally Open (NO) relay contacts of Output 1 and Output 2.

If you have an inductive load connected between Common (C) and Normally Closed (NC) contacts of the mechanical relays and you want to protect them from the rush current during the switching period, you have to connect an external snubber circuit between Common (C) and Normally Closed (NC) contacts as indicated in the figure below.

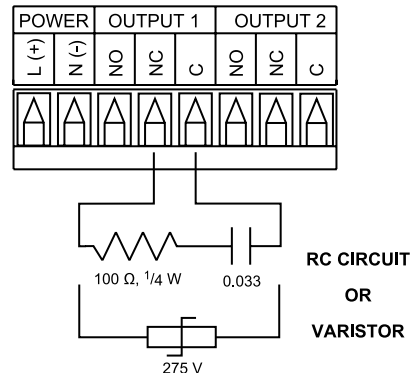

**Figure 2.11 Snubber Circuits Wiring Hookup**

### 2.3.5 Wiring Outputs (continued)

This device may also have a programmable communication output. The RS-232 and RS-485 Output Connection are shown below.

**Note**

If your meter has the communication option, the internal excitation is not available. Use external excitation for strain gauge meter.

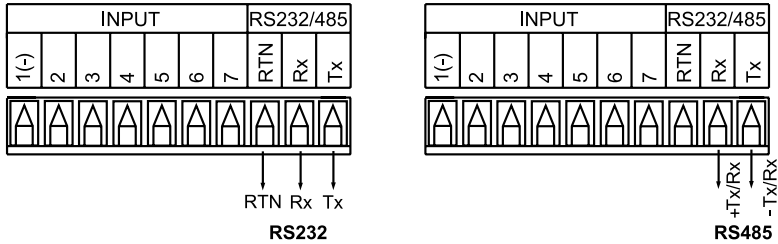

**Note**

External RS-232 connections are not available with -EI or C4EI options.

**Figure 2.12**

**a) RS-232 Output Wiring Hookup    b) RS-485 Output Wiring Hookup**

dc CONTROLLED SSR USED WITH TEMPERATURE CONTROLLER WITH dc VOLTAGE SSR DRIVER OUTPUT

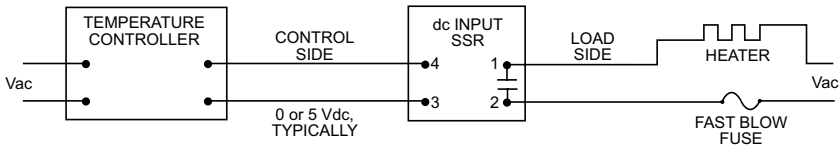

ac CONTROLLED SSR USED WITH TEMPERATURE CONTROLLER WITH MECHANICAL RELAY OUTPUT

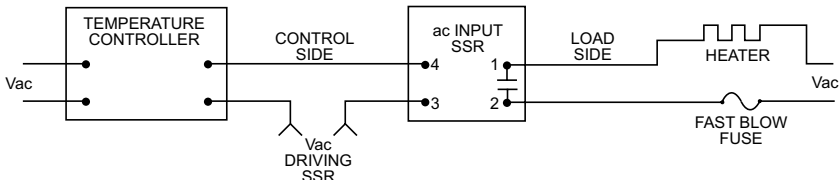

ac CONTROLLED SSR USED WITH TEMPERATURE CONTROLLER WITH TRIAC OUTPUT

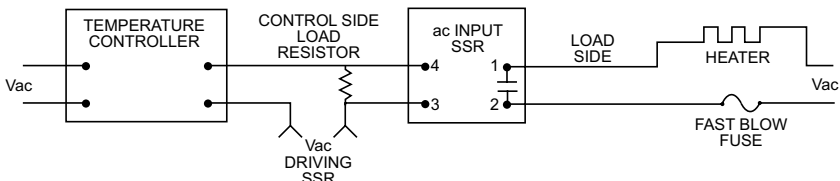
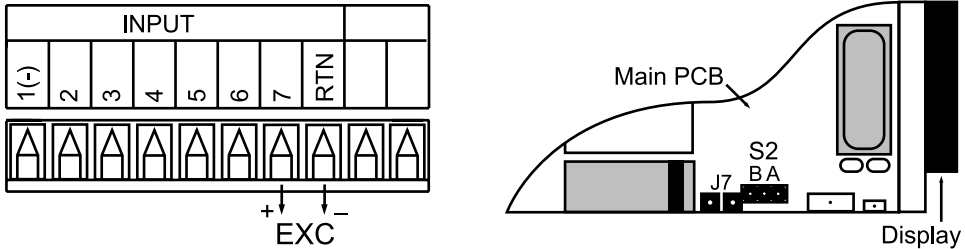

**Figure 2.13 Typical Applications**

### 2.3.5 Wiring Outputs (continued)

This meter is capable of supplying 5 or 10 Vdc sensor excitation. The excitation output connection and location of S2 pin selection jumper are shown below.

**Note** Excitation is not available if Serial Communication (-C24) or Ethernet (-C4EI) or Low Voltage Power Supply (-DC) options are installed.



**Figure 2.14**

**a) Excitation Output**

**b) Top View Location of S2**

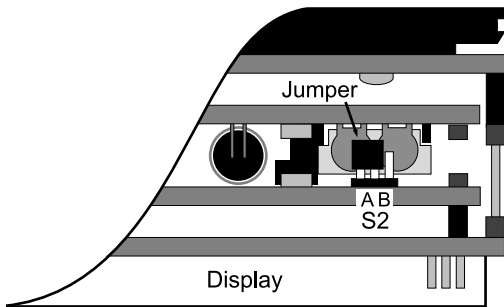

**c) Top View Location of S2 on 1/8 DIN Compact Unit**

Install jumpers according to the table below.

**Table 2.4 Jumper Connections**

Excitation Output	S2	
	A	B
10 V	Close	Open
5 V	Open	Close

**Note** Factory default is 10 V.



## PART 3

# OPERATION: CONFIGURATION MODE

### 3.1 Introduction

The instrument has two different modes of operation. The first, Run Mode, is used to display values for the Process Variable, and to display or clear Peak and Valley values. The other mode, Menu Configuration Mode, is used to navigate through the menu options and configure the controller. Part 3 of this manual will explain the Menu Configuration Mode. For your instrument to operate properly, the user must first "program" or configure the menu options.

#### Turning your Controller On for the First Time

The device becomes active as soon as it is connected to a power source. It has no On or Off switch. The device at first momentarily shows the software version number, followed by reset **RES**, and then proceeds to the Run Mode.



















**Tip** 

For first-time users: Refer to the QuickStart Manual for basic operation and set-up instructions.

**Note** 

If you have the Serial Communications/Ethernet Option you can easily configure the controller on your computer or on-line.

**Table 3.1 Button Function in Configuration Mode**

 MENU	<ul style="list-style-type: none"><li>• To enter the Menu, the user must first press  button.</li><li>• Use this button to advance/navigate to the next menu item. The user can navigate through all the top level menus by pressing .</li><li>• While a parameter is being modified, press  to escape without saving the parameter.</li></ul>
 PK/GRS (UP)	<ul style="list-style-type: none"><li>• Press the up  button to scroll through "flashing" selections. When a numerical value is displayed press this key to increase value of a parameter that is currently being modified.</li><li>• Holding the  button down for approximately 3 seconds will speed up the rate at which the set point value increments.</li><li>• In the Run Mode press  causes the display to flash the PEAK or GROSS value – press again to return to the Run Mode.</li></ul>
 TARE (DOWN)	<ul style="list-style-type: none"><li>• Press the down  button to go back to a previous Top Level Menu item.</li><li>• Press this button twice to reset the controller to the Run Mode.</li><li>• When a numerical value is flashing (except set point value) press  to scroll digits from left to right allowing the user to select the desired digit to modify.</li><li>• When a setpoint value is displayed press  to decrease value of a setpoint that is currently being modified. Holding the  button down for approximately 3 seconds will speed up the rate at which the setpoint value is decremented.</li><li>• In the Run Mode press  causes the display to flash the TARE value to tare your reading (zeroing). Press again to return to the Run Mode.</li></ul>
 ENTER	<ul style="list-style-type: none"><li>• Press the enter  button to access the submenus from a Top Level Menu item.</li><li>• Press  to store a submenu selection or after entering a value — the display will flash a <b>SEt</b> message to confirm your selection.</li><li>• To reset flashing Peak or Valley press .</li><li>• In the Run Mode, press  twice to enable Standby Mode with flashing <b>StBY</b>.</li></ul>

**Note** 

**Reset:** Except for Alarms, modifying any settings of the menu configuration will reset the instrument prior to resuming Run Mode.

### 3.2 Menu Configuration



It is required that you put the controller in the Standby Mode for any configuration change other than Set Points & Alarms.

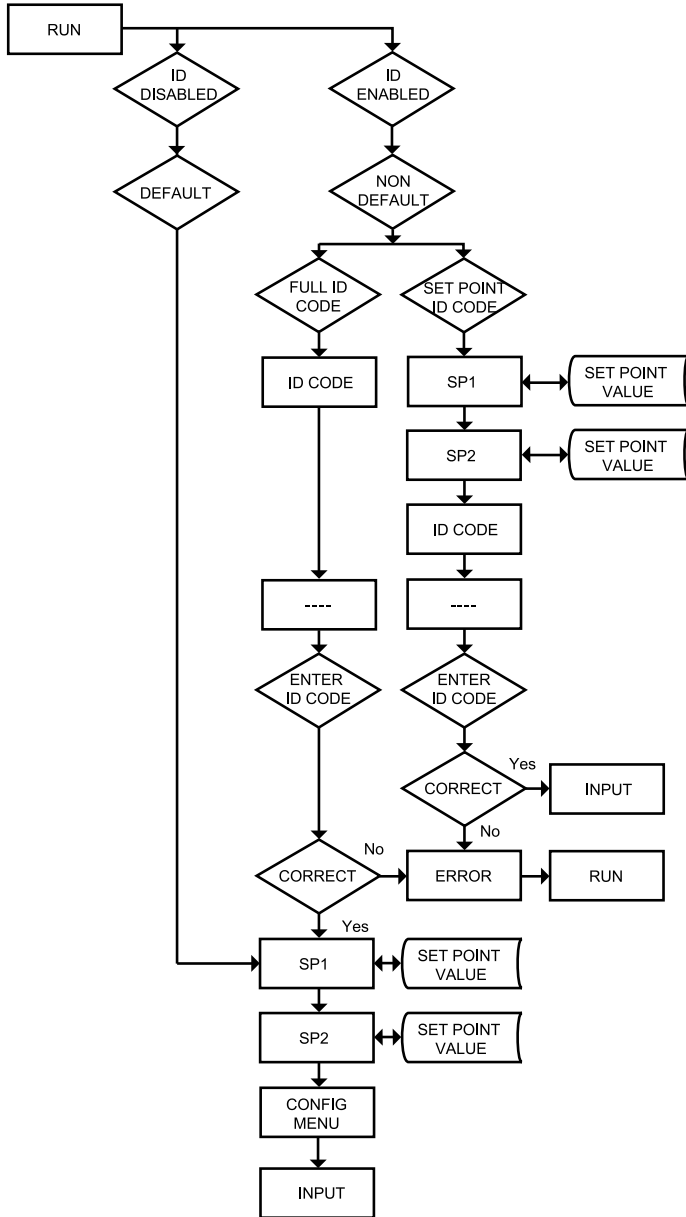

Figure 3.1 Flow Chart for ID and Set Points Menu

### 3.2.1 ID Number Menu

#### SEE ID MENU SELECTION IN CONFIGURATION SECTION FOR ENABLE/DISABLE OR CHANGE ID CODE.

**Note** If ID Code is **Disabled** or set as **Default** (0000) the menu will skip ID step to Set Point Menu.

If ID Code is set to **Full Security Level** and user attempts to enter the Main Menu, they will be prompted for an ID Code.

If ID Code is set to **Setpoint/ID Security Level** and user attempts to enter the Configuration Menu, they will be prompted for an ID Code.

#### ENTERING YOUR NON-DEFAULT FULL SECURITY ID NUMBER.

- Press **⏪** 1) Display shows **ID**.
- Press **⏪** 2) Display advances to **----**.
- Press **▲** & **▼** 3) Press **▲** to increase digit 0-9. Press **▼** to activate next digit (flashing). Continue to use **▲** and **▼** to enter your 4-digit ID code.
- Press **⏪** 4) If the correct ID code is entered, the menu will advance to the Setpoint 1 Menu, otherwise an error message **ERR** will be displayed and the instrument will return to the Run Mode.

**Note** To change ID Code, see ID Menu in the Configuration section.

#### ENTERING YOUR NON-DEFAULT SETPOINT/ID SECURITY ID NUMBER.







- Press **⏪** 5) Display shows **SP1** Setpoint 1 Menu.
- Press **⏪** 6) Display shows **SP2** Setpoint 2 Menu.
- Press **⏪** 7) Display shows **ID** ID Code Menu.
- Press **⏪** 8) Display advances to **----**.
- Press **▲** & **▼** 9) Use **▲** and **▼** to change your ID Code.
- Press **⏪** 10) If correct ID Code is entered, the display will advance to the **INPE** Input Menu, otherwise the error message **ERR** will be displayed and the controller will return to the Run Mode.



**Note** To prevent unauthorized tampering with the setup parameters, the instrument provides protection by requiring the user to enter the ID Code before allowing access to subsequent menus. If the ID Code entered does not match the ID Code stored, the controller responds with an error message and access to subsequent menus will be denied.







**Tip** Use numbers that are easy for you to remember. If the ID Code is forgotten or lost, call customer service with your serial number to access and reset the default to **0000**.

## 3.2.2 Set Points Menu





### SETPOINT 1:



- Press  1) Press , if necessary until **SP 1** prompt appears.
- Press  2) Display shows previous value of "Setpoint 1" with 1<sup>st</sup> digit flashing.
- Press  &  3) Press  and  to increase or decrease Setpoint 1 respectively.



 **Note** Holding  &  buttons down for approximately 3 seconds will speed up the rate at which the set point value increments or decrements.

- Press  &  4) Continue to use  and  to enter your 4-digit Setpoint 1 value.
- Press  5) Display shows **SETRd** stored message momentarily and then advance to **SP 2** only, if a change was made, otherwise press  to advance to **SP 2** Setpoint 2 Menu.

### SETPOINT 2:

- Press  6) Display shows previous value of "Setpoint 2" with 1<sup>st</sup> digit flashing.
- Press  &  7) Press  and  to increase or decrease Setpoint 2 respectively.

 **Note** Holding  &  buttons down for approximately 3 seconds will speed up the rate at which the setpoint value increments or decrements.

- Press  8) Display shows **SETRd** stored message momentarily and then advances to **ENFG** only, if a change was made, otherwise press  to advance to **ENFG** Configuration Menu.

### 3.2.3 Configuration Menu

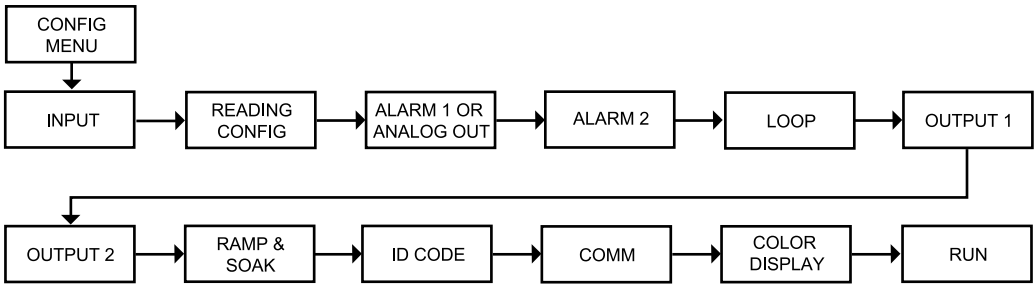
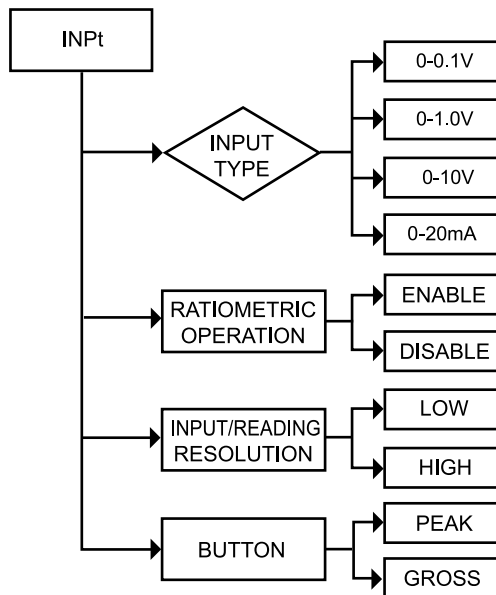

**Figure 3.2 Flow Chart for Configuration Menu**

#### Enter Configuration Menu:





- Press 1) Press , if necessary, until **CONF** prompt appear.
- Press 2) Display advance to **INPE** Input Menu.
- Press 3) Press and release to scroll through all available menus of Configuration section.

### 3.2.4 Input Type Menu



**Figure 3.3 Flow Chart for Input Type Menu**

## ENTER INPUT TYPE MENU:



- Press  1) Press , if necessary, until **CONF** prompt appears.
- Press  2) Display advances to **INPE** Input Menu.
- Press  3) Display flashes **0-0.1**, **0-1.0**, **0-10** or **0-20** (0 to 100 mV, 0 to 1 V, 0 to 10 V or 0 to 20 mA).

## INPUT TYPE MENU:

- Press  4) Scroll through the available selection of input ranges **0-0.1**, **0-1.0**, **0-10** or **0-20** to the selection of your choice.
- Press  5) Display shows **SETRd** stored message momentarily and then advances to the **REto** Ratiometric Operation Submenu.

Input Types:      100 mV   1 V      10 V      0 – 20 mA  
Display:          **0-0.1**   **0-1.0**   **0-10**   **0-20**



## RATIOMETRIC OPERATION SUBMENU:

- Press  6) Display flashes previous selection of **ENbL** Enable or **DSbL** Disable.
- Press  7) Scroll through the available selection **ENbL** or **DSbL** (flashing).
- Press  8) Display shows **SETRd** stored message momentarily and then advances to **RESO** Input/Reading Resolution Submenu.

 **Note** ESP The Ratiometric operations are typically used for Strain gauge controller. If your controller is configured as Process (Voltage and Current), set **REto** to **DSbL** disable Ratiometric operations.

 **Note** ESP If **ENbL** Ratiometric operations **Enabled** was selected, the changes to the excitation voltage will be compensated through Ratio measurement. If **DSbL** Ratiometric operation **Disabled** was selected, any changes to the excitation voltage will effect the output of strain gauge bridge and, as a result, a reading of the controller.

## INPUT/READING RESOLUTION SUBMENU:

- Press  9) Display flashes previous selection of **LO** Low or **HI** High resolution.
- Press  10) Scroll through the available selection **LO** or **HI** (flashing).
- Press  11) Display shows **SETRd** stored message momentarily and then advances to **BUEN** Button Selection Submenu.

 **Note** ESP If **LO** Low Resolution was selected the resolution of the display is 10  $\mu$ V. If **HI** High Resolution was selected the resolution of the display is 1  $\mu$ V. In case of High Resolution, the maximum input signal is 10 mV.

## BUTTON SELECTION SUBMENU:

- Press **↻** 12) Display flashes previous selection of **GROS** Gross or **PEAK** Peak.
- Press **⬇** 13) Scroll through the available selection **GROS** or **PEAK** to the selection of your choice.
- Press **↻** 14) Display shows **SEtPd** stored message momentarily and then advances to **RdC** Reading Configuration Menu.

**Note** If **GROS** was selected, in the Run Mode pressing **⬇** button causes the display to flash Gross value (value measured without zeroing of the display).  
 If **PEAK** was selected, in the Run Mode pressing **⬇** button causes the display to flash Peak value.

**Note** 0 - 20 mA current input used for process control only.  
 For 4 - 20 mA Input select 0 - 20 mA and adjust the Input/Reading accordingly. To adjust 4 - 20 mA input, see example under INPUT/READING Submenu.

### 3.2.5 Reading Configuration Menu

**Note** It is required that you put the controller in the Standby Mode for any configuration change other than Set Points & Alarms.

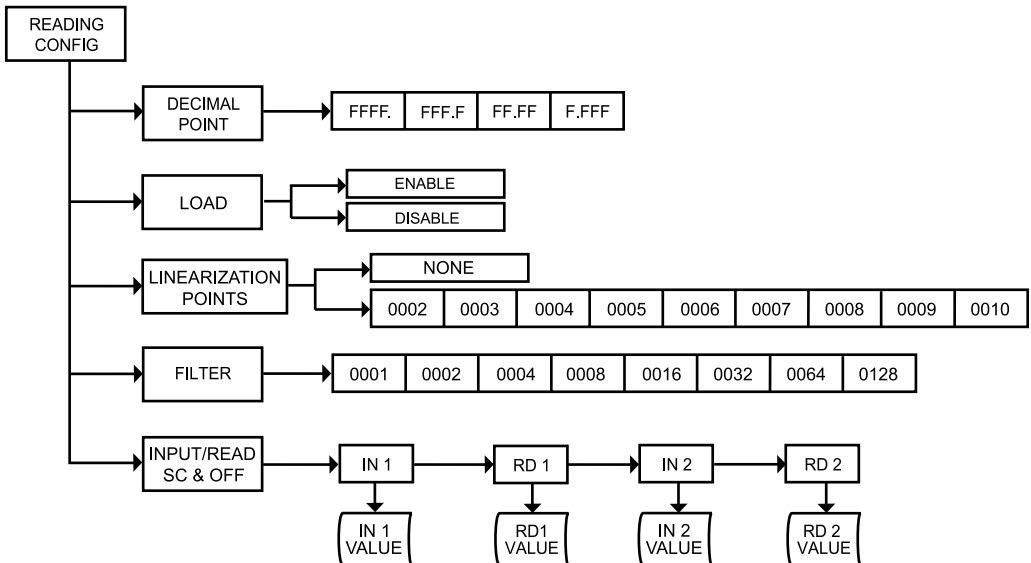











Figure 3.4 Flow Chart for Reading Configuration Menu

## ENTER READING CONFIGURATION MENU:

- Press  1) Press , if necessary, until **ENFG** prompt appears.
- Press  2) Display advances to **INPE** Input Menu.
- Press  3) Display advances to **RdG** Reading Configuration Menu.
- Press  4) Display advances to **DEC** Decimal Point.



## DECIMAL POINT SUBMENU:

- Press  5) Display flashes previous selection for Decimal location.
- Press  6) Scroll through the available selections and choose Decimal location: **FFFF**, **FFF.F**, **FF.FF** or **F.FFF**
- Press  7) Display shows **SEEd** stored message momentarily only, if changes were made, otherwise press  to advance to **LOAD** Known/Unknown Loads Submenu.

**Note** 

Decimal Point is passive.



## KNOWN/UNKNOWN LOADS SUBMENU:

- Press  8) Display flashes previous selection of **ENbL** Enable or **DSbL** Disable.
- Press  9) Scroll through the available selection of **ENbL** or **DSbL** (flashing).
- Press  10) Display shows **SEEd** stored message momentarily and then advances to **L.PNE** Linearization Points Submenu.

**Note** 



If **ENbL** Known Loads scaling method was selected, calculate the input values to the instrument based on the actual signal being received. If **DSbL** Without Known Loads scaling method was selected, calculate input values to the instrument based on the transducer specification.

## LINEARIZATION POINTS SUBMENU:

- Press  11) Display flashes previous selection of Linearization Points Submenu.
- Press  12) Scroll through the available selections: **0002**, **0003**, **0004**, **0006**, **0008**, **0007**, **0008**, **0009**, **0010** - up to 10 Linearization Points can be selected. Default is **0002**.

**Note** 





If display flashes **NONE**, your instrument has only 2 linearization points.

- Press  13) Display shows **SEEd** stored message momentarily only, if a change was made, otherwise press  to advance to the **FLER** Filter Constant Submenu.

Linearization Points allow users to customize the Transducer curve.



## FILTER CONSTANT SUBMENU:

- Press  14) Display flashes previous selection for Filter Constant.
- Press  15) Scroll through the available selections: **0001**, **0002**, **0004**, **0008**, **0016**, **0032**, **0064**, **0128**. - Default is **0004**
- Press  16) Display shows **SEtRd** stored message momentarily only, if a change was made, otherwise press  to advance to **IN.Rd** Input/Reading Submenu.

The Filter Constant Submenu allows the user to specify the number of readings stored in the Digital Averaging Filter.



**Note**

For PID control select filter value 0001-0004. A filter value of 2 is approximately equal to 1 second RC low pass time constant.

### 3.2.6 Input/Reading (Scale and Offset) Menu

Input voltage or current can be converted or scaled into values appropriate for the process or signal being measured. So, a reading may be displayed, for example, in units of weight or velocity instead of in amperes and volts.

The controller determines scale and offset values based on two user-provided input values entered with the corresponding readings.

There are two methods to scale this meter to display readings in engineering units. The **first** method is to scale with known loads. Do this by applying known loads to a transducer connected to a meter, or by simulating the output of the transducer with voltage or current simulator.

The **second** method is to scale without known inputs. Do this by calculating input values based on transducer specifications and manually entering them through the front panel push-buttons.

#### Example 1: Scaling with Known Loads (On-Line Calibration).

**Note** ESP When entering the input or reading values, disregard the position of the decimal point.

**Note** ESP If **ENBL** Enabled Load Submenu was selected, instrument is ready for scaling with Known Loads method.

Apply a known load equal to approximately 0% of the transducer range.

Press **↶** 17) Press **↶** at the **IN Rd** prompt. Display shows **IN 2** Input 1 Submenu.

Press **↷** 18) Display shows the actual signal being received.

Press **↶** 19) Display advances to **Rd 1** Reading 1 Submenu.

Press **↶** 20) Display shows last stored Reading 1 value with 1<sup>st</sup> digit flashing.

Press **▲** & **▼** 21) Use **▲** and **▼** buttons to enter **Rd 1** value.

This value corresponds to Input 1 in terms of some meaningful engineering units. To show Input 1 as zero percent enter **Rd 1** value = 0000.

Press **↶** 22) Display shows **IN 2** Input 2 Submenu.

Apply a known load equal to approximately 100% of the transducer range.

Press **↷** 23) Display shows the actual signal being received.

Press **↶** 24) Display advances to **Rd 2** Reading 2 Submenu.

Press **↶** 25) Display shows last stored Reading 1 value with 1<sup>st</sup> digit flashing.

Press **▲** & **▼** 26) Use **▲** and **▼** buttons to enter **Rd 2** value.

This value corresponds to Input 2 in terms of some meaningful engineering units. To show Input 2 as 100% enter **Rd 2** value = 0100.

**Note** ESP This scaling method based on 2 input values entered with 2 corresponding reading. Up to 10 linearization points can be selected to customize the transducer curve. To select linearization points see "L.Pnt" Submenu.

Note

Max scale should not be more than 50% FS because of noise related issues.

Press

27) Display flashes **SEEd** stored message momentarily and then advances to **ALR 1** only, if a change was made, otherwise advances to **ALR 1** Alarm 1 Menu.

### Example 2: Scaling without Known Loads.

Note

If **DSbL** Disabled **Load** Submenu was selected, instrument is ready for scaling Without Known Loads method.

To scale without known inputs, calculate inputs based on transducer specifications and manually enter them on the via front panel push-buttons. The following example assumes load cells with this specification:

Maximum Load: 100.0 lb  
 Output: 3.0 mV/V  
 Sensor Excitation 10 V  
 Maximum Sensor Output = 3.0 (mV/V) x 10 (V) = 30 mV

1. Determine the correct values for Inputs (**IN 1** and **IN 2**). Calculate **IN 1** and **IN 2** using the following equation:

$$IN = (\text{Sensor Output}) \times (\text{Conversion Number}) \times (\text{Multiplier})$$

Tip

Conversion number is a coefficient of conversion between input values and real full display range (10000 counts). See Table 3.1 below for proper conversion number.

Table 3.2 Conversion Table

INPUT RANGE	CONVERSION NUMBER
0 ~ 100 mV	10000 / (100 x 1) = 100 cts/mV
0 ~ 1 V	10000 / (1000 x 1) = 10 cts/mV
0 ~ 10 V	10000 / (1000 x 10) = 1 cts/mV
0 ~ 20 mA	10000 / (20 x 1) = 500 cts/mV

Tip

Multiplier determined by the Input Resolution setting (**RESO** in the **INPE** Menu). See Table 3.2 below for proper multiplier.

Table 3.3 Input Resolution Multiplier

INPUT RANGE	RESOLUTION	
	LOW	HIGH
0 ~ 100 mV	1.0	10.0
0 ~ 1 V	1.0	10.0
0 ~ 10 V	1.0	10.0
0 ~ 20 mA	1.0	10.0

Determine **IN 1** and **IN 2** Input Range and Resolution. For our transducer select 0 ~ 100 mV range and LOW resolution (10  $\mu$ V)

$$\begin{aligned} \text{IN 1} &= 0 \text{ (mV)} \times 100 \text{ (cts/mV)} \times 1.0 = 0 \\ \text{IN 2} &= 30 \text{ (mV)} \times 100 \text{ (cts/mV)} \times 1.0 = 3000 \end{aligned}$$

2. Determine correct values for Display Reading (**Rd 1** and **Rd 2**). In most cases, **Rd 1** and **Rd 2** are equal to the minimum and the maximum of the transducer output range.

$$\begin{aligned} \text{Rd 1} &= 0000 \\ \text{Rd 2} &= 100.0 \end{aligned}$$

3. Scaling the controller.

- Press **↻**      28) Press **↻** at the **IN.Rd** prompt. Display shows **IN 1** Input 1 Submenu.
- Press **↻**      29) Display shows last stored Input 1 value with 1<sup>st</sup> digit flashing.
- Press **▲** & **▼**      30) Use **▲** and **▼** buttons to enter **IN 1** value (0000).
- Press **↻**      31) Display advances to **Rd 1** only, if a change was made, otherwise press **↻** to advance to **Rd 1** Reading 1 Submenu.
- Press **↻**      32) Display shows last stored Reading 1 value with 1<sup>st</sup> digit flashing.
- Press **▲** & **▼**      33) Use **▲** and **▼** buttons to enter **Rd 1** value (0000).
- Press **↻**      34) Display **IN 2** Input 2 Submenu.
- Press **↻**      35) Display shows last stored Input 2 value with 1<sup>st</sup> digit flashing.
- Press **▲** & **▼**      36) Use **▲** and **▼** buttons to enter **IN 2** value (3000).
- Press **↻**      37) Display advances to **Rd 2** only, if a change was made, otherwise press **↻** to advance to **Rd 2** Reading 2 Submenu.
- Press **↻**      38) Display shows last stored Reading 2 value with 1<sup>st</sup> digit flashing.
- Press **▲** & **▼**      39) Use **▲** and **▼** buttons to enter **Rd 2** value (1000).
- Press **↻**      40) Display flashes **SE.Rd** stored message momentarily and then advances to **ALR 1** only, if a change was made, otherwise advances to **ALR 1** Alarm 1 Menu.

**Note**

This scaling method based on 2 input values entered with 2 corresponding reading. Up to 10 linearization points can be selected to customize the transducer curve. To select linearization points see "L.Pnt" Submenu.

### Example 3: Scaling with Current/Voltage Transducer (Process) Input.

The following example include details for a specific scenario in which a 4 - 20 mA input is to be represented as a measurement of 0 - 100 percent.

Press **↩** 41) Press **↩** at the **IN.Rd** prompt. Display shows **IN 1** Input 1 Submenu.

Press **↩** 42) Display shows Input 1 value with 1<sup>st</sup> digit flashing.

Press **▲** & **▼** 43) Use **▲** and **▼** buttons to enter **IN 1** value.

The **IN 1** value = min. input value x conversion number  
from Table 3.1

Enter 4 mA as  $4 \text{ (mA)} \times 500 = 2000$

Press **↩** 44) Display advances to **Rd 1** Reading 1 Submenu.

Press **▲** & **▼** 45) Use **▲** and **▼** buttons to enter **Rd 1** value.

This value corresponds to Input 1 in terms of some meaningful engineering units. To show 4 mA as zero percent enter **Rd 1** value = 0000.

Press **↩** 46) Display **IN 2** Input 2 Submenu.

Press **↩** 47) Display shows **IN 2** Input 2 value with 1<sup>st</sup> digit flashing.

The **IN 2** value = max. input value x conversion number  
from Table 3.1

Enter 20 mA as  $20 \text{ (mA)} \times 500 = 10000$  (entered as 9999)

Press **▲** & **▼** 48) Use **▲** and **▼** buttons to enter **IN 2** value.

Press **↩** 49) Display advances to **Rd 2** Reading 2 Submenu.

Press **▲** & **▼** 50) Use **▲** and **▼** buttons to enter **Rd 2** value.

To show 20 mA as 100 percent enter **Rd 2** value = 0100

Press **↩** 51) Display flashes **StRd** stored message momentarily and then advances to **ALR 1** only, if a change was made, otherwise advances to **ALR 1** Alarm 1 Menu.

### 3.2.7 Alarm 1 Menu

This unit is equipped with two physical outputs that can only be configured as follows: **Alarm 1 & Alarm 2**, **Alarm 1 & Output 2**, **Output 1 & Alarm 2**, **Output 1 & Output 2**, **Analog Out 1 & Alarm 2**, **Analog Out 1 & Output 2**. Analog Out available only if Analog Output Option board is factory installed.

**Note** If Analog Output Option is installed, the controller will skip Alarm 1 Menu item to Analog Output.

**Note** Alarm must be DISABLED if Ramp is ENABLED.

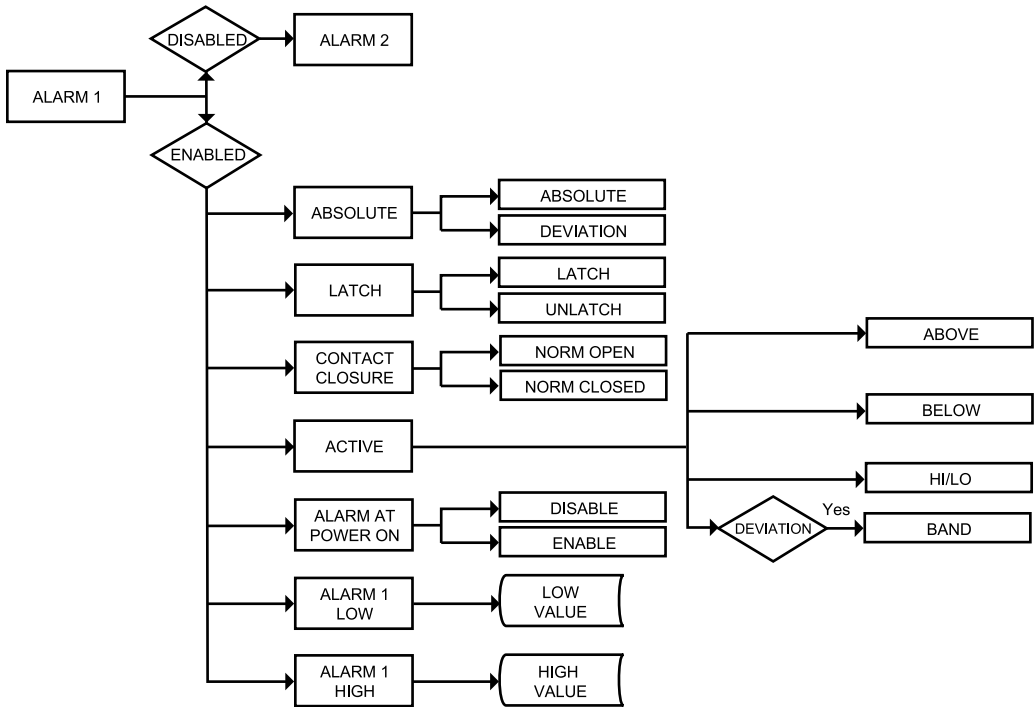

Figure 3.5 Flow Chart for Alarm 1 Menu

#### ENTER ALARM 1 MENU:

- Press **⏪** 1) Press **⏪**, if necessary, until **ENFC** prompt appears.
- Press **⏩** 2) Display advances to **INPL** Input Menu.
- Press **⏪** 3) Press **⏪**, if necessary, until Display advances to **ALR 1** Alarm 1 Menu.
- Press **⏩** 4) Display advances to Alarm 1 **ENBL** Enable or **DSBL** Disable Submenu and flashes the previous selection.

## ALARM 1 ENABLE/DISABLE SUBMENU:

- Press ▲ 5) Scroll through the available selection until **ENBL** displays to use Alarm 1.
- Press ⏻ 6) Display shows **STRT** stored message momentarily and then advances to **ABS** only, if it was changed, otherwise press ⏻ to advance to **ABS** Alarm 1 Absolute/Deviation Submenu.



If **DSBL** Alarm 1 **Disabled** was selected, all submenus of Alarm 1 Menu will be skipped and meter advances to **ALR2** Alarm 2 Menu. If **ENBL** Alarm 1 **Enabled** was selected, Output 1 would be automatically disabled, and reassigned as Alarm 1.

## ALARM 1 ABSOLUTE/DEVIATION SUBMENU:

- Press ⏻ 7) Display flashes previous selection. Press ▲ to **ABS** Absolute or **DEV** Deviation.
- Press ⏻ 8) Display shows **STRT** stored message momentarily and then advances to **LATCH** only, if it was changed, otherwise press ⏻ to advance to **LATCH** Alarm 1 Latch/Unlatch Submenu.

**Absolute Mode** allows Alarm 1 to function independently from Setpoint 1. If the process being monitored does not change often, then "Absolute" Mode is recommended.

**Deviation Mode** allows changes to Setpoint 1 to be made automatically to Alarm 1. Deviation Mode is typically the ideal mode if the process value changes often. In Deviation Mode, set Alarm 1 a certain number of degrees or counts away from Setpoint 1 — this relation remains fixed even if Setpoint 1 is changed.

## ALARM 1 LATCH/UNLATCH SUBMENU:

- Press ⏻ 9) Display flashes previous selection. Press ▲ to **LATCH** Latched or **UNLATCH** Unlatched.
- Press ⏻ 10) Display shows **STRT** stored message momentarily and then advances to **CC** only, if it was changed, otherwise press ⏻ to advance to **CC** Contact Closure Submenu.

**Latched Mode:** Relay remains "latched" until reset. To reset already latched alarm, select Alarm Latch and press ▲ twice (i.e. Unlatch and then back to Latch) or from a Run Mode, push ⏻ twice to put the controller in Standby Mode and then push ⏻ one more time to return to the Run Mode.

**Unlatched Mode:** Relay remains latched only as long as the alarm condition is true.

## CONTACT CLOSURE SUBMENU:

- Press **⏪** 11) Display flashes previous selection. Press **⏩** to **N.C.**. Normally Closed or **N.O.**. Normally Open.
- Press **⏪** 12) Display shows **SEtPd** stored message momentarily and then advances to **AcEN** only, if it was changed, otherwise press **⏪** to advance to **AcEN** Active Submenu.

**Normally Open:** If this feature is selected, then the relay is "energized" only when an alarm condition occurs.

**Normally Closed:** "Fail Safe" Mode. Relay is energized under "normal" conditions and becomes de-energized during alarm or power failure.

## ACTIVE SUBMENU:

- Press **⏪** 13) Display flashes previous selection. Press **⏩** to scroll through the available selections: **AbOv** Above, **bELo** Below, **HiLo** HI/Low and **band** Band. (Band is active if **DEV** Deviation was selected).
- Press **⏪** 14) Display shows **SEtPd** stored message momentarily and then advances to **R.P.oN** only, if it was changed, otherwise press **⏪** to advance to **R.P.oN** Alarm Enable/Disable at Power On Submenu.

**Above:** Alarm 1 condition triggered when the process variable is greater than the Alarm Hi Value (Low value ignored).

**Below:** Alarm 1 condition triggered when the process variable is less than the Alarm Low Value (Hi value ignored).

**Hi/Low:** Alarm 1 condition triggered when the process variable is less than the Alarm Low Value or above the Hi Value.

**Band:** Alarm 1 condition triggered when the process variable is above or below the "band" set around Setpoint 1. Band equals Hi Value (Low Value ignored). A "band" is set around the Setpoint by the instrument only in the "Deviation" Mode.

The Band for the AL 1 would be following the Setpoint 1 value

The Band for the AL 2 would be following the Setpoint 2 value.

The Band or the Deviation Value should be entered under:

AL1 High (if they want Alarm 1)

AL2 High (if they want Alarm 2)

AL Low value is ignored in the Band mode.

**Example:** if customer requires a Deviation Value of  $\pm 10$  degrees around a setpoint (using Output 2 as alarm)

Output 2: disabled (this enables the Alarm 2)

Alarm 2: - Deviation





Contact Closure type: Deviation---Band

AL2 High: 10 (Band they want around Setpoint 2)

Then the Band Value is to be entered under AL2 HI: 10 not  $80 + 10 = 90$











## ALARM ENABLE/DISABLE AT POWER ON:

- Press  15) Display flashes previous selection. Press  to **ENBL** enable or **DSBL** disable.
- Press  16) Display shows **SETRd** stored message momentarily and then advances to **ALR.L** only, if it was changed, otherwise press  to advance to the **ALR.L** Alarm 1 Low Value Submenu.









### Note

If the alarm is enabled at Power On, the alarm will be active right after reset. If the alarm is disabled at Power On, the alarm will become enabled when the process value enters the non alarm area. The alarm is not active while the process value is approaching Setpoint 1.

## ALARM 1 LOW VALUE SUBMENU:

- Press  17) Display flashes 1<sup>st</sup> digit of previous value. Use  and  to enter new value.
- Press  &  18) Use  and  to enter Alarm 1 Low Value.
- Press  19) Display shows **SETRd** storage message momentarily and then advances to **ALR.H** only, if it was changed, otherwise press  to advance to **ALR.H** Alarm 1 HI Value Submenu.

## ALARM 1 HI VALUE SUBMENU:

- Press  20) Display flashes 1<sup>st</sup> digit of previous value. Use  and  to enter new value.
- Press  &  21) Use  and  to enter Alarm1 HI Value.
- Press  22) Display shows **SETRd** stored message momentarily and then advances to the next menu only, if it was changed, otherwise press  to advance to the next menu.

### Note

If the input wires of the meter get disconnected or broken, it will display **+ OL** Input (+) Overload message. For safety purposes you can set up your alarm to be triggered when input is open.

### 3.2.8 Analog Output (Retransmission) Menu

**Note** Analog Output can be configured as Retransmission or Control outputs. In this section we will discuss Retransmission Output.

This unit is equipped with two physical outputs that can only be configured as follows: **Alarm 1 & Alarm 2**, **Alarm 1 & Output 2**, **Output 1 & Alarm 2**, **Output 1 & Output 2**, **Analog Out 1 & Alarm 2**, **Analog Out 1 & Output 2**. Analog Output is available only if Analog Output Option board is factory installed.

**Note** If Analog Output Option is not installed, the instrument will skip to Alarm 2 Menu.

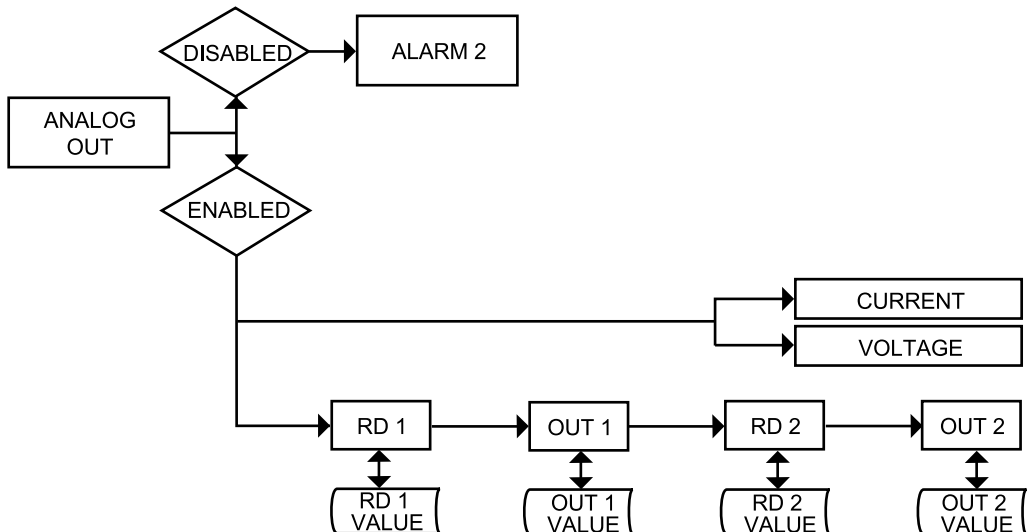

**Figure 3.6 Flow Chart for Analog Output (Retransmission) Menu**

#### ENTER ANALOG OUTPUT MENU:

- Press **⏏** 1) Press **⏏**, if necessary, until **ENFG** prompt appears.
- Press **⏏** 2) Display advances to **INPE** Input Menu.
- Press **⏏** 3) Press **⏏**, if necessary, until display advances to **ANLG** Analog Output Menu.
- Press **⏏** 4) Display advances to Analog Output **ENBL** Enable or **DSBL** Disable Submenu and flashes the previous selection.

## ANALOG OUTPUT ENABLE/DISABLE SUBMENU:

- Press **▲** 5) Scroll through the available selection until **ENBL** displays to use Analog Output Retransmission (output proportional to the input signal).
- Press **▶** 6) Display shows **STRD** stored message momentarily and then advances to **CURR** or **VOLT** Submenu only if it was changed, otherwise press **▶** to advance to **CURR** or **VOLT** Current/Voltage Submenu.

### Note

If **DSBL** Analog Output **Disabled** was selected, all submenus of Analog Output Menu will be skipped and the meter will advance to **ALRM2** Alarm 2 Menu. If **ENBL** Analog Output **Enabled** was selected, Output 1 would be automatically **Disabled**, and reassigned as Analog Output.

## CURRENT/VOLTAGE SUBMENU:

- Press **▶** 7) Display flashes **CURR** Current or **VOLT** Voltage.
- Press **▲** 8) Scroll through the available selection: Current or Voltage (Example **VOLT**).
- Press **▶** 9) Display shows **STRD** stored message momentarily and then advances to **Rd1** Submenu only if it was changed, otherwise press **▶** to advance to **Rd1** Reading 1 Submenu.

## READING 1:

- Press **▶** 10) Display flashes 1<sup>st</sup> digit of previous "Reading 1" value.
- Press **▲** & **▼** 11) Enter "Reading 1" value. (Example 0000)
- Press **▶** 12) Display advances to **OUT.1** Out 1 Submenu.

## OUT 1:

- Press **▶** 13) Display flashes 1<sup>st</sup> digit of previous "Out 1" value.
- Press **▲** & **▼** 14) Enter "Out 1" value. (Example 00.00)
- Press **▶** 15) Display advances to **Rd2** Reading 2 Submenu.

## READING 2:

- Press **▶** 16) Display flashes 1<sup>st</sup> digit of previous "Reading 2" value.
- Press **▲** & **▼** 17) Enter "Reading 2" value. (Example 9999)
- Press **▶** 18) Display advances to **OUT.2** Out 2 Submenu.

## OUT 2:

- Press **▶** 19) Display flashes 1<sup>st</sup> digit of previous "Out 2" value.
- Press **▲** & **▼** 20) Enter "Out 2" value. (Example 10.00)
- Press **▶** 21) Display advances to the **ALRM2** Alarm 2 Menu.

### Note

The above example is for 0 - 10 V of the entire range of the Process Input and Analog Output. For 0 - 20 mA output you need to set "Analog Type" to Current and OUT 2 to 20.00.

**Accuracy of Analog Output** board is +/-1% of FS (Full Scale) when following conditions are satisfied:

1. The input is not scaled below 1% of Input FS (10 mV @ 1 V or 0.2 mA @ 20 mA input ranges).
2. Analog Output is not scaled below 3% of Output FS (300 mV @ 10 V or 0.6 mA @ 20 mA output ranges).

Otherwise certain corrections need to be applied.

**For example:**

For entire range of process input, the Analog Output on 10 V FS scaled for **300 mV** output range:

$$\begin{aligned} \text{Rd1} &= 0000, & \text{Out1} &= 00.00 \\ \text{RD2} &= 9999, & \text{Out2} &= 00.30 \end{aligned}$$

The **measured output** will be as follows:

$$\begin{aligned} \text{Rd1} &= 0000, & \text{Out1} &= -0.07 \text{ V} \\ \text{Rd2} &= 9999, & \text{Out2} &= 0.23 \text{ V} \end{aligned}$$

This means that for 300 mV output range we have -70 mV offset at zero and at full scale. In order to compensate this 70 mV offset the **correct scaling** will be as follows:

$$\begin{aligned} \text{Rd1} &= 0000, & \text{Out1} &= 00.07 \\ \text{Rd2} &= 9999, & \text{Out2} &= 00.37 \end{aligned}$$

The above corrections need to be applied only for **Input scaled below 1% of FS** and **Output scaled below 3% of FS** or if you need the **Analog Output accuracy to be better than 1% of FS**.

### 3.2.9 Alarm 2 Menu

This unit is equipped with two physical outputs that can only be configured as follows: **Alarm 1 & Alarm 2**, **Alarm 1 & Output 2**, **Output 1 & Alarm 2**, **Output 1 & Output 2**, **Analog Out 1 & Alarm 2**, **Analog Out 1 & Output 2**. Analog Out available only if Analog Output Option board is factory installed.

**Note** Alarm must be DISABLED if Ramp is ENABLED.

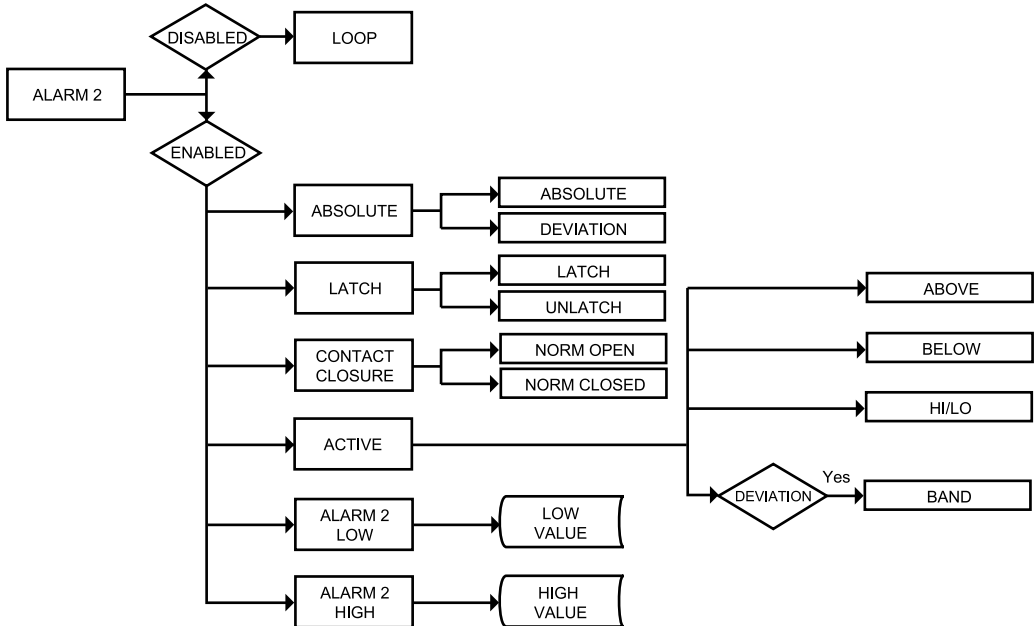

**Figure 3.7 Flow Chart for Alarm 2 Menu**

#### ENTER ALARM 2 MENU:

- Press **⏪** 1) Press **⏪**, if necessary, until **CHFD** prompt appears.
- Press **⏩** 2) Display advances to **INPE** Input Menu.
- Press **⏪** 3) Press **⏪**, if necessary, until display advances to **ALR2** Alarm 2 Menu.
- Press **⏩** 4) Display advances to Alarm 2 **ENBL** Enable or **DSBL** Disable Submenu.

## ALARM 2 ENABLE/DISABLE SUBMENU:

- Press **⏪** 5) Display flashes previous selection. Press **⏩** until **ENBL** displays to use Alarm 2.
- Press **⏪** 6) Display shows **SETRd** stored message momentarily and then advances to **ABSd** only if it was changed, otherwise press **⏪** to advance to **ABSd** Absolute/Deviation Submenu.

**Note** If **dsbl** Alarm 2 **Disabled** was selected, all submenus of Alarm 2 will be skipped and meter advances to **LOOP** Loop Break Time Menu. If **ENBL** Alarm 2 **Enabled** was selected, Output 2 will automatically be **Disabled**, and reassigned as Alarm 2.

**Note** The remaining Alarm 2 menu items are identical to Alarm 1 Menu. Modifying Alarm Settings will not reset the instrument.

### 3.2.10 Loop Break Time Menu

**Note** It is required that you put the controller in the Standby Mode for any configuration change other than Set Points & Alarms.

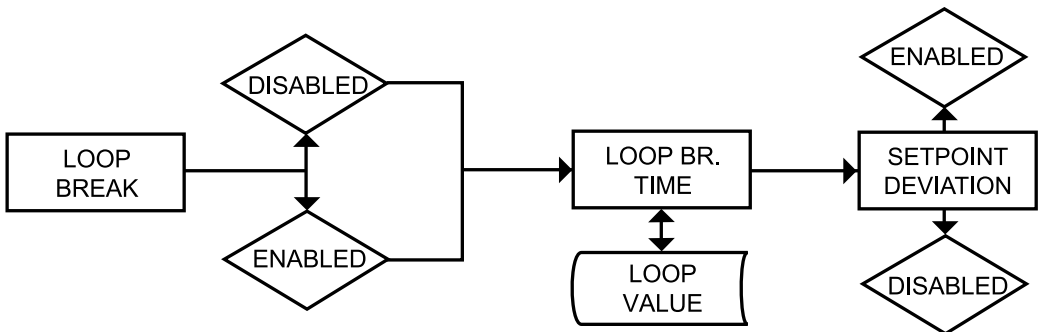

Figure 3.8 Flow Chart for Loop Break Time Menu

### ENTER LOOP BREAK TIME MENU:

- Press **⏪** 1) Press **⏪**, if necessary, until **CHFD** prompt appears.
- Press **⏪** 2) Display advances to **INPE** Input Menu.
- Press **⏪** 3) Press **⏪**, if necessary, until Display advances to **LOOP** Loop Break Time Menu.

## LOOP BREAK ENABLE/DISABLE SUBMENU:

- Press **⏪** 4) Display advances to Loop Break Time **ENBL** Enable or **DSBL** Disable Submenu and flashes the previous selection.
- Press **⏩** 5) Scroll through the available selections: **ENBL** or **DSBL**.
- Press **⏪** 6) Display shows **STRd** stored message momentarily and then advances to **b.t IM** Loop Break Time Value Submenu.

Loop Break is an additional safety feature intended to monitor the rate of change of the Process value, while approaching the SP1. It is strictly intended as an additional warning system, therefore its use is entirely optional. An active Loop Break will cause the Process Value digits to blink in a rotating pattern. If the Process value reaches the set point the blinking will stop and **b.t IM** is completed successfully, otherwise **BR.AL** Break Alarm warning will flash, and Output 1 will be turned off.

## LOOP BREAK TIME VALUE SUBMENU:

- Press **⏪** 7) Display flashes 1<sup>st</sup> digit of previous Loop Value.
- Press **⏩** & **⏪** 8) Press **⏩** and **⏪** buttons to enter a new Loop Value (0 to 99.59).
- Press **⏪** 9) Display shows **STRd** stored message momentarily and then advances to **SP.dV** Setpoint Deviation Submenu.

**Loop Break Time Value** allows the user to determine the time interval in MM:SS (from zero to 99 minutes and 59 seconds) that the Process Value changes at least 10 counts. At the specified time interval, if the process value change is less than the stated rate, flashing **b.t IM** will be displayed, the output 1 will be de-energized, and Alarm 1 energized. Loop break time will be disabled when the Process Value (PV) enters the control band.

## SETPOINT DEVIATION ENABLE/DISABLE SUBMENU:

- Press **⏪** 13) Display advances to Setpoint Deviation **ENBL** Enable or **DSBL** Disable Submenu and flashes the previous selection.
- Press **⏩** 14) Scroll through the available selections: **ENBL** or **DSBL**.
- Press **⏪** 15) Display shows **STRd** stored message momentarily and then advances to **OUT 1** Output 1 Menu.

**Set Point Deviation** Submenu, if “enabled”, allows changes to Setpoint 1 to be made automatically to Setpoint 2. This mode is very helpful if the Process Value changes often. In Set Point Deviation Mode, set SP2 a certain number of counts away from SP1 - this relation remains fixed when SP1 is changed. For instance: Setting SP1=200 and SP2=20 and enabling **SP.dV** means that the absolute value of SP2=220. Moving SP1 to 300, the absolute value of SP2 becomes 320.

### 3.2.11 Output 1 Menu

Alarm 1 and Output 1 or Analog Output (Retransmission) share the same contacts on the rear panel connector. If Alarm 1 or Analog Output (Retransmission) is **Enabled**, Output 1 is automatically **Disabled**.

**Note** It is required that you put the controller in the Standby Mode for any configuration change other than Set Points & Alarms.

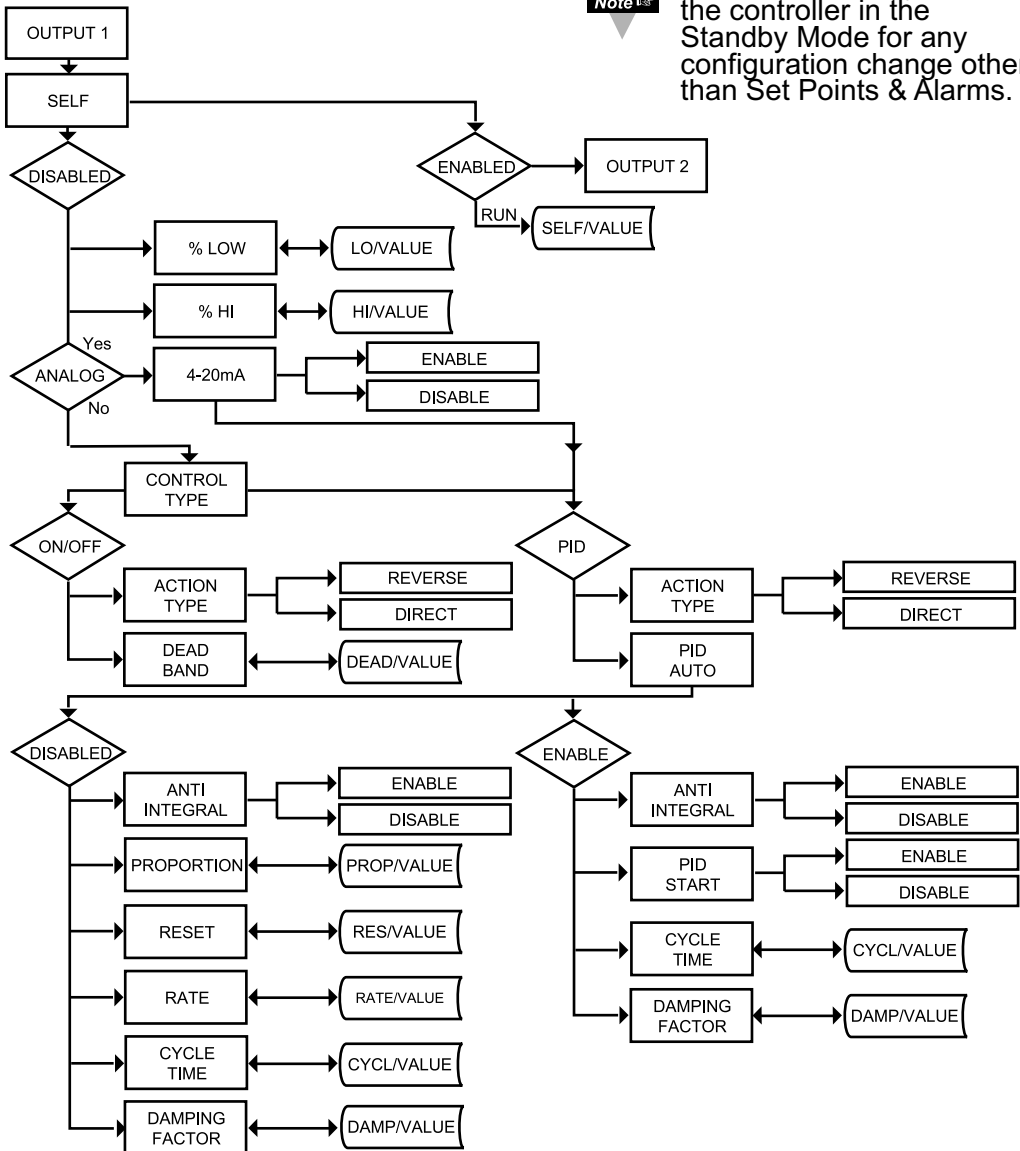

**Figure 3.9 Flow Chart for Output 1 Menu**



## ENTER OUTPUT 1 MENU:

- Press **⏪** 1) Press **⏪**, if necessary, until **ENFG** prompt appears.
- Press **⏪** 2) Display advances to **INPE** Input Menu.
- Press **⏪** 3) Press **⏪**, if necessary, until display advances to **OUT1** Output 1 Menu.
- Press **⏪** 4) Display advances to **SELF** Self Submenu.

## SELF SUBMENU:

The Self Option allows the output of the instrument to be controlled manually from the front panel.

- Press **⏪** 5) Display flashes the current setting of Self, **ENBL** Enabled or **DSBL** Disabled.
- Press **⏴** 6) Press the **⏴** button to select between Enable and Disable.
- Press **⏴** 7) If Self **ENBL** Enabled was selected, display shows **STRD** stored message momentarily and then advances to the next menu (Output 1 setting is completed).

On the Run Mode display shows **MXX.X** The output is now under the direct control of the operator and can be adjusted in the Run Mode (**M00.0** to **M99.9**), by pressing the **⏴** and **⏵** buttons, where **M** calls for manual (Self) control. For example, setting of **M50.0** of an analog output of 0 to 10 Vdc would produce roughly 5 Vdc at the output.

8) If Self **DSBL** Disabled was selected, display shows **STRD** stored message momentarily and then advances to **LOLO** Minimum/Percent Low Submenu of Output 1 Menu.



There is a shorter way to Enable or Disable SELF Mode. From a Run Mode press **⏴** and then press **⏪**. SELF Mode is Enabled now. Press **⏴** or **⏵** to display **MXX.X** To Disable SELF press **⏴** and then press **⏪**. Display goes to the Run Mode. SELF Mode is Disabled now.

## MINIMUM/PERCENT LOW SUBMENU:

Specify in percent, the minimum value (0000) for control output. If the output is analog proportional (Current or Voltage), then the minimum voltage or current, in percent, is specified. If the output is time proportional (Relay, SSR or Pulse), then the minimum duty-cycle, in percent, is specified.

- Press **⏴** 9) Display flashes 1st digit of previous “Percent Low” setting.
- Press **⏴** & **⏵** 10) Use **⏴** and **⏵** buttons to enter a new value for “Percent Low”.
- Press **⏴** 11) Display shows **STRD** stored message momentarily and then advances to **PHHI** Maximum/Percent High Submenu.

## MAXIMUM/PERCENT HIGH SUBMENU:

Specify in percent, the maximum value (99) for control output. If the output is analog proportional (Current or Voltage), then the maximum voltage or current, in percent, is specified. If the output is time proportional (Relay, SSR, or Pulse), then the maximum duty-cycle, in percent, is specified.

- Press **⏪** 12) Display flashes 1<sup>st</sup> digit of previous "Percent High" setting.
- Press **▲** & **▼** 13) Use **▲** and **▼** buttons to enter a new value for "Percent High".
- Press **⏪** 14) Display shows **SERd** stored message momentarily and then advances to **CTRL** Control Type Submenu.

**Example:** On an Analog Output of 0-10 Vdc, a setting of %LO = 10 and %HI = 90, cause the minimum on the control output to be 1 V and the maximum on the control output to be 9 V. The same setting on a time proportional output, will cause 10% duty cycle for the minimum control output and 90% duty cycle for maximum control output. To disable %LO/HI, set LO to 00 and HI to 99. If %LO/HI is at other values than the default (%LO = 00, %HI = 99), **SOAR** is disabled.

## \*CONTROL TYPE OUTPUT:

(Relay, SSR, Pulse or Analog)

- Press **⏪** 15) Display flashes **ON.OF** On/Off or **PID** PID.
- Press **▲** 16) Scroll through the available selections: "ON.OF" or "PID".
- Press **⏪** 17) Display flashes **SERd** stored message momentarily and then advances to **ACTION** only, if it was changed, otherwise press **⏪** to advance to **ACTION** Action Type Submenu.

The **ON.OF** control is a coarse way of controlling the process. The "Dead Band" improves the cycling associated with the ON.OF control. The **PID** control is best for processes where the set point is continuously changing and/or a tight control of the process variable is required. PID control requires tuning and adjustment of the "Proportional", "Integral or Reset" and "Derivative or Rate" terms by a trial-and-error method. The instrument provides an "Auto Tuning" feature making the tuning process automatic, possibly optimum.





\* If Analog Output (Current/Voltage) is your control Output 1, this menu i.e. **CTRL** type will not appear, instead **4-20** Current will be displayed. Select **ENBL** for a 4-20 mA current (2-10 V Voltage) outputs or **DSBL** for a 0-20 mA current (0-10 V Voltage) outputs. If 4-20 mA is enabled, %HI/LO setting will have no effect.

**Note**

Both Current and Voltage control outputs are active simultaneously.

## ACTION TYPE SUBMENU:





The error that results from the measurement of the Process Variable may be positive or negative since it may be greater or smaller than the Setpoint. If a positive error should cause the instrument output to increase, it would be called **Direct Acting**. If a negative error should cause the output to decrease, it would be called **Reverse Acting**.

- Press  18) Display flashes **DRCT** Direct or **RVRV** Reverse.
- Press  19) Scroll through the available selections: “Direct” or “Reverse”.
- Press  20) Display shows **SEEd** stored message momentarily and then advances to **AUto** only, if it was changed, otherwise press  to advance to **AUto** Auto PID Submenu (if PID Control Type was selected).

**Note** 

If “**ON/OFF**” was selected in the Control Type, the display skips to the Dead Band Submenu.

## AUTO PID SUBMENU:

- Press  21) Display flashes **ENbL** or **DSbL**.
- Press  22) Scroll through the available selections: “Enable” or “Disable”.
- Press  23) Display shows **SEEd** stored message momentarily and then advances to **ANtL** only, if it was changed, otherwise press  to advance to **ANtL** Anti Integral Submenu.





**Note** 

If “**Enabled**”, the controller can determine, by enabling Start PID, the optimum values for the three adjustments — Proportional, Reset and Rate corresponding to P, I, and D. These values may be changed once the auto tuning is complete.

**Note** 

If “**Disabled**” is selected, the user will manually enter these three adjustment values. If you want the instrument to do the auto PID and the P, PI or PID, first select auto disable and enter 0000 for each unwanted parameter. e.g. for PI enter 0000 for the rate.

## ANTI INTEGRAL SUBMENU:

- Press  24) Display flashes **ENbL** or **DSbL**.
- Press  25) Scroll through the available selections: “Enable” or “Disable”.
- Press  26) Display shows **SEEd** stored message momentarily and then advances to **SEtE** only, if it was changed, otherwise press  to advance to **SEtE** to Start Auto Tune PID Submenu (If auto PID was Enabled).

**Note** 

If Auto PID was disabled display advances to **PRoP** Proportional Band Submenu.

Note

If Anti Integral (Anti Windup) Submenu “**Enabled**”, this feature allows the error term outside the proportional band to be calculated and accumulated for integration. This may be an important feature in applications where fast response time is desirable.

## START AUTO TUNE PID:

- Press **⏻** 27) Display flashes **ENBL** or **DSBL**.
- Press **▲** 28) Scroll through the available selections: “Enable” or “Disable”.
- Press **⏻** 29) Display shows **SEEd** stored message momentarily and then advances to **CYCL** only, if it was changed, otherwise press **⏻** to advance to **CYCL** Cycle Time Submenu.

Note

If “**Enabled**”, the controller is ready to calculate P, PI or PID parameters. The instrument performs this by activating the output and observing the delay and rate at which the Process Value changes. The set points must be at least 20 counts above the (PV) Process Value in order to perform Auto Tune, otherwise an error message will be displayed.

To start Auto Tune PID select PID, enable Auto PID and enable Start PID. Sometimes Auto PID parameter needs fine tuning i.e. for each 10 counts over shoot increase the Proportional Band (PB) by 15% and for each  $\pm 1$  count fluctuation at the Set Point (SP) increase reset by 20%.

Once started, display shows **A.TUN** with letters blinking in the rotating pattern. When auto tune stops, display will show process value. Do not perform any operations or settings before first stopping Auto Tune. Any alarms or other output is disabled during Auto Tune.

Note

If “**AUTO PID**” was “**DISABLED**”, the display will show the following three submenus. This allows the user to manually enter values for Proportional, Reset and Rate terms corresponding to P, I, and D. It also can be used for Auto PID by disabling unwanted parameter e.g. PI enter 0000 for Rate.

## PROPORTIONAL BAND SUBMENU:

- Press **⏻** 30) Display flashes 1<sup>st</sup> digit of the previous **P PRoP** Proportional band value.
- Press **▲** & **▼** 31) Press **▲** and **▼** buttons to enter a new “Proportional Band” value.
- Press **⏻** 32) Display shows **SEEd** stored message momentarily and then advances to **RESE** only, if it was changed, otherwise press **⏻** to advance to **RESE** Reset Setup Submenu.

Proportional Band is in counts. Proportional Band is defined, as the change in the instrument input to cause a 100% change in the controller output.

## RESET SETUP SUBMENU:

- Press **↻** 33) Display flashes 1<sup>st</sup> digit of the previous **RESET** Reset value.
- Press **▲** & **▼** 34) Press **▲** and **▼** buttons to enter a new "Reset" value.
- Press **↻** 35) Display shows **SETRd** stored message momentarily and then advances to **RATE** only, if it was changed, otherwise press **↻** to advance to **RATE** Rate Setup Submenu.

Reset unit is in seconds 0-3999.

## RATE SETUP SUBMENU:

- Press **↻** 36) Display flashes 1<sup>st</sup> digit of previous **RATE** Rate value.
- Press **▲** & **▼** 37) Press **▲** and **▼** buttons to enter a new **RATE** value.
- Press **↻** 38) Display shows **SETRd** stored message momentarily and then advances to the **CYCL** only, if it was changed, otherwise press **↻** to advance to **CYCL** Cycle Time submenu.

Rate unit is in seconds 000.0-399.9.



If the Output 1 is Analog Option the display skips to Damping Factor.

## CYCLE TIME SUBMENU:

- Press **↻** 39) Display flashes 1<sup>st</sup> digit of the previous **CYCL** Cycle Time value.
- Press **▲** & **▼** 40) Press **▲** and **▼** buttons to enter a new "Cycle Time" value. (1 to 199 seconds)
- Press **↻** 41) Display shows **SETRd** stored message momentarily and then advances to **DAMP** only, if it was changed, otherwise press **↻** to advance to **DAMP** Damping Factor Submenu.





A Cycle Time selected between 1 and 199 seconds determines the total On/Off time of each proportional cycle.

For example, a 15 second cycle time means that every 15 seconds the output will turn on for part or all of the cycle.

For Relay control outputs, do not select a cycle time of less than 7 seconds or the relays' lifetime will be shortened. For a cycle time of less than 7 seconds select SSR or DC pulse.

Use an external SSR with the DC pulse option for higher currents (higher than 1 Amp).

## DAMPING FACTOR SUBMENU:

- Press  42) Display flashes the previous “Damping Factor” selection.
- Press  43) Scroll through the available selections: **0000**, **0001**, **0002**, **0003**, **0004**, **0005**, **0006**, **0007**.
- Press  44) Display flashes **SEtRd** stored message and then advances to **OUT2** only, if it was changed, otherwise press  to advance to **OUT2** Output 2 Menu.







Damping Factor is a measure of speed, overshoot, and undershoot in which the process variable responds to the output changes of the instrument, which were used during the Auto Tune. This value is typically set to the ratio of Rate to Reset.

This Default value is (0003). For fast response time, this value should be decreased while for slow response time it should be increased.



The “DEADBAND” Submenu will only appear if “ON.OF” was selected from the “Control Type” Menu.

## DEADBAND SUBMENU:

- Press  45) Display flashes 1<sup>st</sup> digit of the previous **DEAd** Deadband value.
- Press  &  46) Press  and  buttons to enter a new “Deadband” value.
- Press  47) Display shows **SEtRd** stored message and then advances to **OUT2** only, if it was changed, otherwise press  to advance to **OUT2** Output 2 Menu.



Dead Band units are the same as Proportional Band units.



The Dead Band or neutral zone is the number of counts around the set point which the Process Variable must pass above or below the set point, before the output changes state.

### 3.2.12 Output 2 Menu

Output 2 and Alarm 2 share the same contacts on the rear panel connector. If Alarm 2 is **Enabled**, Output 2 is automatically **Disabled**.

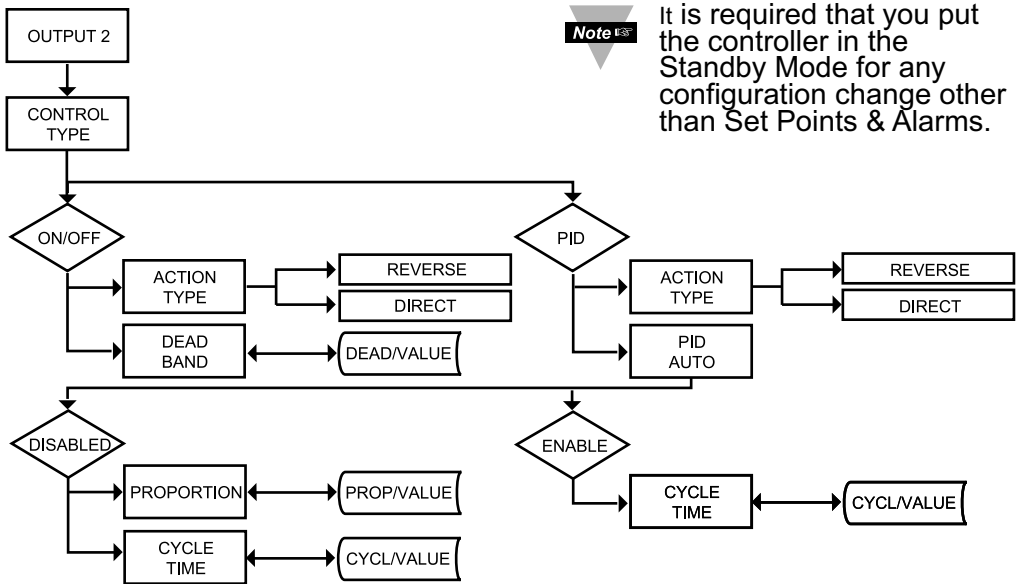

**Figure 3.10 Flow Chart for Output 2 Menu**

#### ENTER OUTPUT 2 MENU:

- Press **⏪** 1) Press **⏪**, if necessary, until **ENFG** prompt appears.
- Press **⏩** 2) Display advances to **INPE** Input Menu.
- Press **⏪** 3) Press **⏪**, if necessary, until Display advances to **OUT2** Output 2 Menu.
- Press **⏩** 4) Display advances to **CTRL** Control Type Submenu.





#### CONTROL TYPE SUBMENU:

- Press **⏪** 3) Display flashes **ON.OF** On/Off, or **PID** PID.
- Press **⏩** 4) Scroll through the available selections: "ON.OF" or "PID".
- Press **⏩** 5) Display shows **STRD** stored message momentarily and then advances to **ACTN** only, if it was changed, otherwise press **⏩** to advance to **ACTN** Action Type Submenu.

The **ON.OF** control is a coarse way of controlling the Process. The "Dead Band" improves the cycling associated with the ON.OF control. The **PID** control is best for processes where the set point is continuously changing and/or tight control of the Process Variable is required.

## ACTION TYPE SUBMENU:

The error that results from the measurement of the process variable may be positive or negative since it may be greater or smaller than the set point. If a positive error should cause the instrument output to increase, it would be called **Direct Acting**. If a negative error should cause the output to decrease, it would be called **Reverse Acting**.

- Press  6) Display flashes **DRctE** Direct or **RvRS** Reverse.
- Press  7) Scroll through the available selections: "Direct" or "Reverse".
- Press  8) Display shows **SErE** stored message momentarily and then advances to **AUto** only, if it was changed, otherwise press  to advance to **AUto** Auto PID Submenu (If PID Control type was selected).

**Note** 



If "ON.OF" was selected in the Control Type, the display skips to the Dead Band Submenu.

## AUTO PID SUBMENU:

- Press  9) Display flashes **ENbL** Enable or **dsbL** Disable.
- Press  10) Scroll through the available selections: "Enable" or "Disable".

**Note** 

If "Enabled", the PID parameter of Output 1 will be copied to Output 2.







- Press  11) Display shows **SErE** stored message momentarily and then advances to the next submenu only, if it was changed, otherwise press  to advance to the next submenu.

**Note** 

If AUTO PID was "ENABLED", the display skips to the **CYCL** CYCLE TIME submenu. If "AUTO PID" was "DISABLED", the display will show **PRoP** PROPORTIONAL BAND Submenu allowing the user to manually enter the Proportional Band value.

The Reset and Rate value are the same as Output 1.

## PROPORTIONAL BAND SUBMENU:







- Press  12) Display flashes 1<sup>st</sup> digit of the previous Proportional Band value.
- Press  &  13) Press  and  buttons to enter a new Proportional Band value.
- Press  14) Display shows **SErE** stored message momentarily and then advances to **CYCL** only, if it was changed, otherwise press  to advance to the **CYCL** Cycle Time Submenu.

**Note** 

Refer to "Proportional Band" Submenu of "Output 1" Menu.



## CYCLE TIME SUBMENU:

- Press  15) Display flashes 1<sup>st</sup> digit of the previous "Cycle Time" value.
- Press  &  16) Press  and  buttons to enter a new "Cycle Time" value (1 to 199 seconds).
- Press  17) Display shows **SEtRd** stored message momentarily and then advances to **RAMP** only, if it was changed, otherwise press  to advance to **RAMP** Ramp Value Submenu.







A cycle time selected between 1 to 199 seconds indicates the total On/Off time of each proportional cycle.

For example, a 15 second cycle time means that every 15 seconds the output will turn on for part or all of the cycle.

For Relay Control Outputs, do not select a cycle time of less than 7 seconds or the relays' lifetime will be shortened. For a cycle time of less than 7 seconds select SSR or DC pulse. Use an external SSR with the DC pulse option for higher current (higher than 1 Amp).

**The DEADBAND Submenu will only appear if the ON/OFF was selected from the "Control Type" Submenu.**

## DEADBAND SUBMENU:

- Press  18) Display flashes 1<sup>st</sup> digit of the previous "Dead Band" value.
- Press  &  19) Press  and  buttons to enter a new "Dead Band" value.
- Press  20) Display shows **SEtRd** stored message momentarily and then advances to **RAMP** only, if it was changed, otherwise press  to advance to **RAMP** Ramp Value Menu.

**Note** 

Dead Band units are the same as Proportional Band units.

**Tip** 

The Dead Band or neutral zone is the number of counts around the set point which the Process Variable must pass above or below the set point, before the output changes state.

### 3.2.13 Ramp & Soak Menu

**Note** ESP Alarm must be DISABLED if Ramp is ENABLED.

**Note** ESP It is required that you put the controller in the Standby Mode for any configuration change other than Set Points & Alarms.

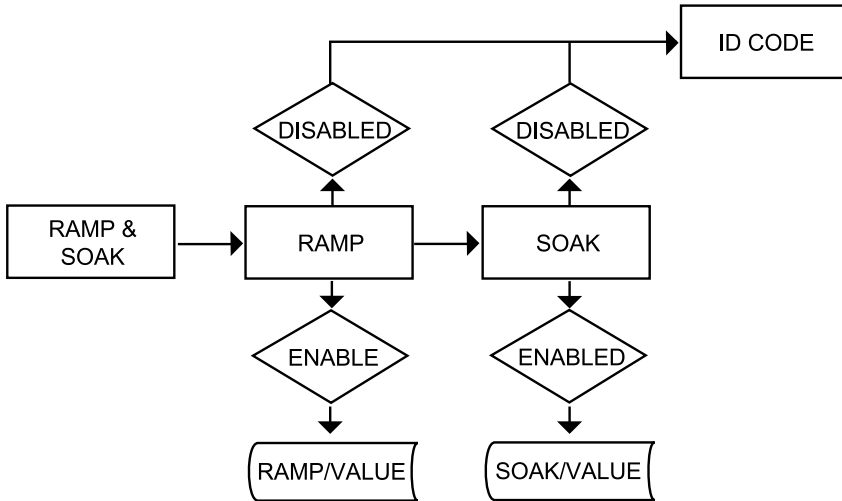

**Figure 3.11 Flow Chart for Ramp and Soak Menu**

#### ENTER RAMP AND SOAK MENU:

- Press **⏪** 1) Press **⏪**, if necessary, until **CONF** prompt appears.
- Press **⏩** 2) Display advances to **INPE** Input Menu.
- Press **⏪** 3) Press **⏪**, if necessary, until Display advances to **RAMP** Ramp and **SOAK** Soak Menu.

#### RAMP ENABLE/DISABLE SUBMENU:

- Press **⏪** 4) Display advances to “Ramp Enable/Disable” Submenu and flashes **ENBL** or **DSBL**.
- Press **⏴** 5) Scroll through the available selections: “Enable” or “Disable”.
- Press **⏩** 6) Display shows **SEED** stored message momentarily and then advances to **SOAK** Soak Enable/Disable Menu.

**Note** ESP If **RAMP Disable** was selected, display skips to the next menu item (ID Code).

## SOAK ENABLE/DISABLE SUBMENU:

- Press **↻** 7) Display flashes **ENBL** or **DSBL**.
- Press **▲** 8) Scroll through the available selections: "Enable" or "Disable".
- Press **↻** 9) Display shows **SERd** stored message momentarily and then advances to "Ramp Value" Submenu.

Ramp & Soak provides users with the flexibility to slowly bring the Process Variable (PV) to the desired set point. Ramp & Soak values are specified in HH.MM format. The Ramp value indicates the time specified to bring the process variable to Setpoint 1 (SP1). Once set point is reached, the PID takes over and the Process Variable will be controlled at the desired set point indefinitely. If Soak is enabled, PID will control the Process Variable at the specified set point for the duration of Soak time and then will turn off Output 1. To start a new Ramp/Soak cycle, reset the instrument by pressing **↻** and then **▼** button.

An active Ramp/Soak will change SP1 one count above the PV and will cause the most significant digit to blink. The SP1 will be incremented by one count until it reaches the original SP1. The minimum Ramp time must be at least twice the time that it will take the PV to reach the Setpoint Value (SV) with OUT 1 fully ON.

## RAMP VALUE SUBMENU:

- Press **↻** 10) Display flashes 1<sup>st</sup> digit of previous stored "Ramp Value".
- Press **▲** & **▼** 11) Press **▲** and **▼** buttons to enter a new "Ramp Value".
- Press **↻** 12) Display shows **SERd** stored message momentarily and then advances to "Soak Value" Submenu.

## SOAK VALUE SUBMENU:

- Press **↻** 13) Display flashes 1<sup>st</sup> digit of previous stored "Soak Value".
- Press **▲** & **▼** 14) Press **▲** and **▼** buttons to enter a new "Soak Value".
- Press **↻** 15) Display shows **SERd** stored message and advances to the **ID** ID Code Menu.

The Ramp and Soak time is 00:00 to 99:59 i.e. HH.MM. (from zero to 99 hours and 59 minutes) During Ramp & Soak do not perform any operations or settings before first stopping it. Any alarms or other output are disabled during this time. To stop Ramp & Soak first put instrument into Standby Mode, then go to Ramp & Soak Menu and disable it.

### 3.2.14 ID Code Menu

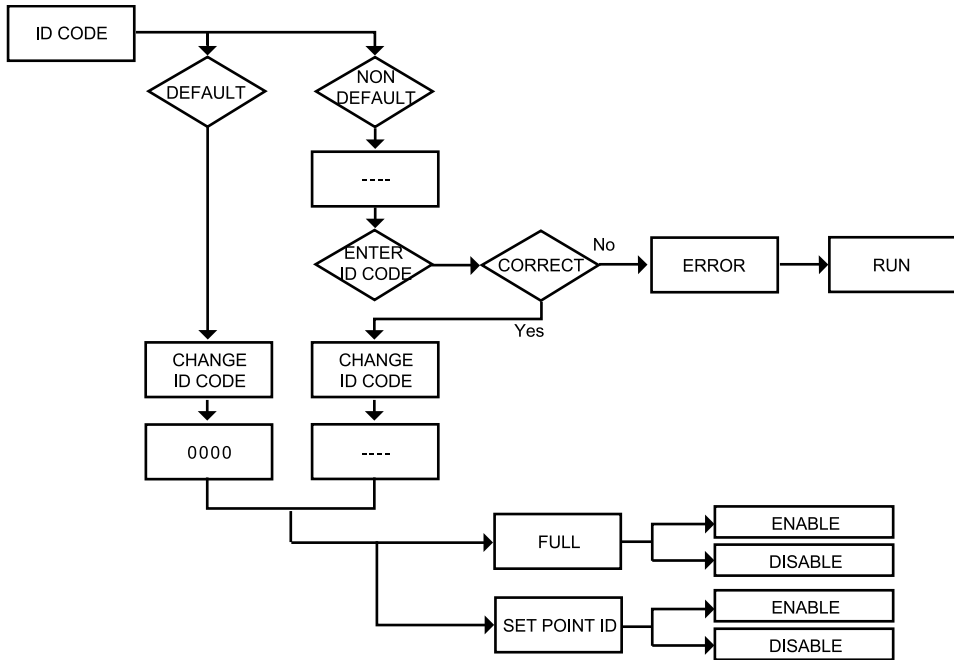

**Figure 3.12 Flow Chart for ID Code Menu**

#### ENTER ID CODE MENU:

- Press **⏪** 1) Press **⏪**, if necessary, until **CHFD** prompt appears.
- Press **⏩** 2) Display advances to **INPE** Input Menu.
- Press **⏪** 3) Press **⏪**, if necessary, until display advances to **ID** ID Code Menu.

#### ENTERING OR CHANGING YOUR (NON-DEFAULT) ID CODE:

- Press **⏩** 4) Display advances to **----** with 1<sup>st</sup> under score flashing.
- Press **▲** & **▼** 5) Press **▲** and **▼** to enter your 4-digit "ID Code" number.
- Press **⏩** 6) Display advances to **CH.ID** Change ID Code Submenu.

**Note** If entered "ID Code" is incorrect display shows **ERR** Error message momentarily and then skips to the Run Mode.

- Press **⏩** 7) Display flashes the first digit of previous entered "ID Code" number.
- Press **▲** & **▼** 8) Press **▲** and **▼** buttons to enter your new "ID Code" number.
- Press **⏩** 9) Display shows **STRD** stored message momentarily and then advances to the **FULL** Full Security Submenu.

## ENTERING OR CHANGING YOUR (DEFAULT) ID CODE:

**Note** 

Enter **ID** menu (Repeat steps from 1 to 3).

- Press  10) Display advances to **CH.ID** Change ID Code Submenu.  
Press  11) Display shows **0000** message with flashing 1<sup>st</sup> digit.

**Note** 

If you want to change your default "ID Code" you can do it now, otherwise press  and menu will skip to **FULL** Full Security Submenu.

- Press  &  12) Press  and  buttons to enter your new "ID Code" number.  
Press  13) Display shows **SEEd** stored message momentarily and then advances to the **FULL** Full Security Submenu.

## FULL SECURITY LEVEL SUBMENU:

- Press  14) Display flashes **ENbL** Enable or **DSbL** Disable.  
Press  15) Scroll through the available selections: "Enable" or "Disable".  
Press  16) Display shows **SEEd** stored message momentarily and then advances to **SP.ID** Setpoint/ID Submenu.

**Note** 

If "Full" Security Level is "Enabled" and the user attempts to enter the Main Menu, they will be prompted for an ID Code. The ID Code should be correct to enter the instrument Menu item.

## SETPOINT/ID SECURITY LEVEL SUBMENU:

This Security Level can be functional only if **FULL** Security Level is Disabled.

- Press  17) Display flashes **ENbL** Enable or **DSbL** Disable.  
Press  18) Scroll through the available selections: "Enable" or "Disable".  
Press  19) Display shows **SEEd** stored message momentarily and then advances to **COMM** Communication Submenu.

**Note** 

If "**Setpoint/ID**" Security Level is "**Enabled**" and the user attempts to advance into the **CONF** Configuration Menu, he will be prompted for ID Code number. The ID Code should be correct to proceed into the Configuration Menu, otherwise display will show an Error and skip to the Run Mode.

**Note** 

If "**Full**" and "**Setpoint/ID**" Security Levels are "**Disabled**", the ID code will be "Disabled" and user will not be asked for ID Code to enter the Menu items ("ID" Submenu will not show up in "ID/Setpoint" Menu).

### 3.2.15 Communication Option Menu

Purchasing the controller with Serial Communications permits an instrument to be configured or monitored from an IBM PC compatible computer using software available from **the website listed on the cover page of this manual or on the CD-ROM enclosed with your shipment**. For complete instructions on the use of the Communications Option, refer to the Serial Communications Reference Manual.

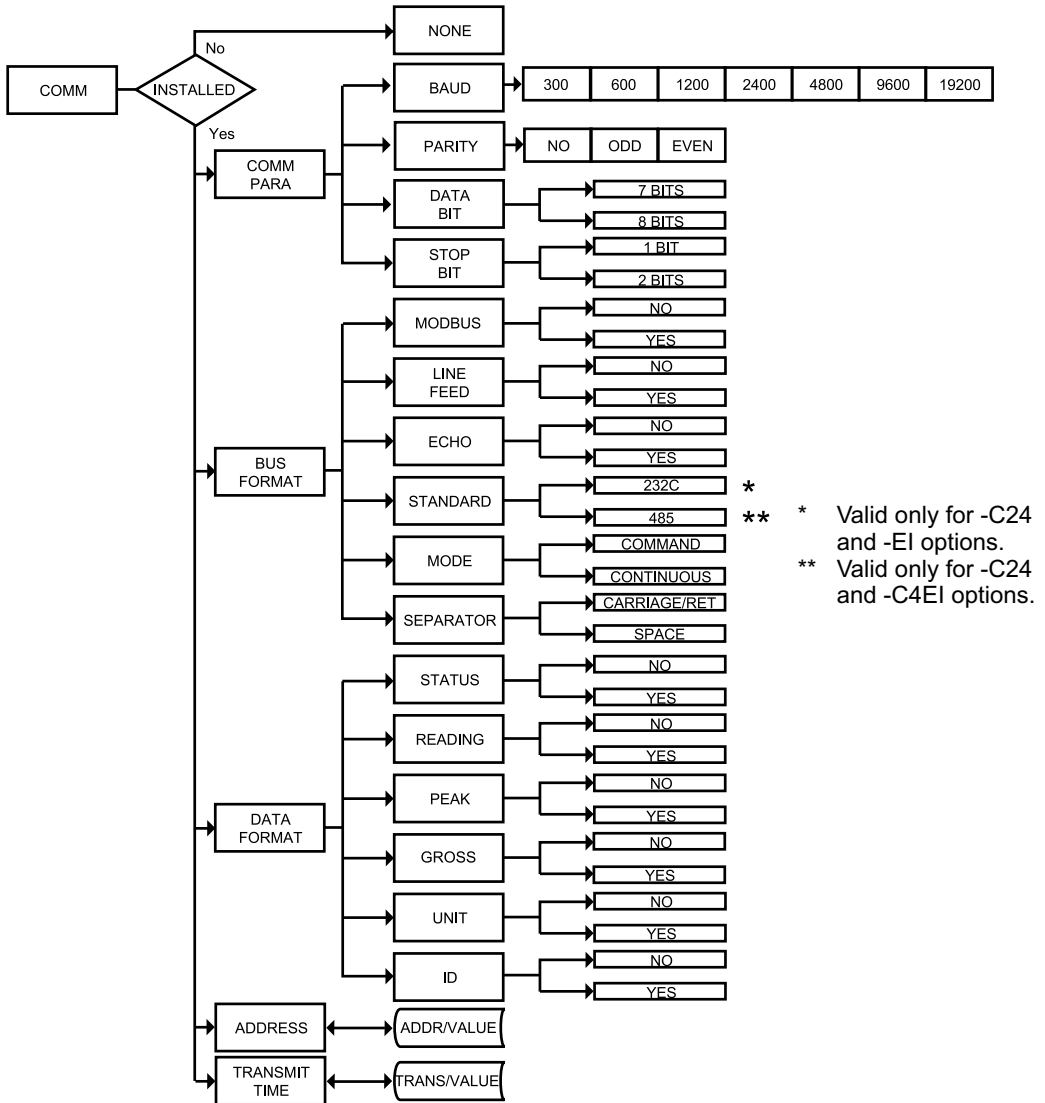







**Note ES\***

External RS-232 connections are not available with -EI or -C4EI options.

**Figure 3.13 Flow Chart for Communication Option Menu**

## ENTER COMMUNICATION OPTION MENU:

- Press  1) Press , if necessary, until **ENFC** prompt appears.
- Press  2) Display advances to **INPE** Input Menu.
- Press  3) Press , if necessary, until display advances to **COMM** Communication Options Menu.
- Press  4) Display advances to **LPAR** Communication Parameters Submenu.







If Communication Option is not installed, the display shows **NONE** and skips to the Color Display Menu.

## COMMUNICATION PARAMETERS SUBMENU:





Allows the user to adjust Serial Communications Settings of the instrument. When connecting an instrument to a computer or other device, the Communications Parameters must match. Generally the default settings (as shown in **Section 5**) should be utilized.

- Press  5) Display advances to **BAUD** Baud Submenu.





## BAUD SUBMENU:

- Press  6) Display flashes previous selection for **BAUD** value.
- Press  7) Scroll through the available selections: **300**, **600**, **1200**, **2400**, **4800**, **9600**, **19.2K**.
- Press  8) Display shows **SEED** stored message momentarily and then advances to **PREY** only, if it was changed, otherwise press  to advance to **PREY** Parity Submenu.





## PARITY SUBMENU:

- Press  9) Display flashes previous selection for "Parity".
- Press  10) Scroll through the available selections: NO, ODD, EVEN.
- Press  11) Display shows **SEED** stored message momentarily and then advances to **DATA** only, if it was changed, otherwise press  to advance to **DATA** Data Bit Submenu.

## DATA BIT SUBMENU:

- Press  12) Display flashes previous selection for "Data Bit".
- Press  13) Scroll through the available selections: 7-BIT, 8-BIT.
- Press  14) Display shows **SEED** stored message and then advances to **STOP** only, if it was changed, otherwise press  to advance to **STOP** Stop Bit Submenu.

## STOP BIT SUBMENU:





- Press  15) Display flashes previous selection for "Stop Bit".
- Press  16) Scroll through the available selections: 1-BIT, 2-BIT.
- Press  17) Display shows **SErD** stored message momentarily and then advances to **bUS.F** only, if it was changed, otherwise press  to advance to **bUS.F** Bus Format Submenu.

## BUS FORMAT SUBMENU:

Determines Communications Standards and Command/Data Formats for transferring information into and out of the controller via the Serial Communications Bus. Bus Format submenus essentially determine how and when data can be accessed via the Serial Communications of the device.

- Press  18) Display advances to **m.bUS** Modbus Submenu.

## MODBUS PROTOCOL SUBMENU:

- Press  19) Display flashes previous selection for **m.bUS**.
- Press  20) Scroll through the available selections: NO, YES.
- Press  21) Display shows **SErD** stored message momentarily and then advances to **-LF-** only, if it was changed, otherwise press  to advance to **-LF-** Line Feed submenu.





To select iSeries Protocol, set Modbus submenu to "No".  
To select Modbus Protocol, set Modbus submenu to "Yes".

### Note

If Modbus Protocol was selected, the following Communications Parameters must be set as: No Parity, 8-bit Data Bit, 1-Stop Bit. Do not attempt to change these parameters.

## LINE FEED SUBMENU:

Determines if data sent from the instrument will have a Line Feed appended to the end - useful for viewing or logging results on separate lines when displayed on communications software at a computer.

- Press  22) Display flashes previous selection for "Line Feed".
- Press  23) Scroll through the available selections: NO, YES.
- Press  24) Display shows **SErD** stored message momentarily and then advances to **ECHO** only, if it was changed, otherwise press  to advance to **ECHO** Echo Submenu.

## ECHO SUBMENU:

When valid commands are sent to the instrument, this determines whether the command will be echoed to the Serial Bus. Use of echo is recommended in most situations, especially to help verify that data was received and recognized by the controller.



- Press **↻** 25) Display flashes previous selection for “Echo”.
- Press **▲** 26) Scroll through the available selections: NO, YES.
- Press **↻** 27) Display flashes **SEEd** stored message momentarily and then advances to **SEEd** only if it was changed, otherwise press **↻** to advance to **SEEd** Communication Standard Submenu.

### COMMUNICATION INTERFACE STANDARD SUBMENU:

Determines whether device should be connected to an RS-232C serial port (as is commonly used on IBM PC-compatible computers) or via an RS-485 bus connected through appropriate RS-232/485 converter. When used in RS-485 Mode, the device must be accessed with an appropriate Address Value as selected in the Address Submenu described later.

- Press **↻** 28) Display flashes previous selection for “Standard”.
- Press **▲** 29) Scroll through the available selections: 232C, 485.
- Press **↻** 30) Display shows **SEEd** stored message momentarily and then advances to **Mode** only, if it was changed, otherwise press **↻** to advance to **Mode** Data Flow Mode Submenu.

### DATA FLOW MODE SUBMENU:

Determines whether the instrument will wait for commands and data requests from the Serial Bus or whether the instrument will send data automatically and continuously to the Serial Bus. Devices configured for the RS-485 Communications Standard operate properly only under Command Mode.

- Press **↻** 31) Display flashes previous selection for “Mode”.
- Press **▲** 32) Scroll through the available selections: **Cmd** “Command”, **ContE** “Continuous”.
- Press **↻** 33) Display shows **SEEd** stored message momentarily and then advances to **SEPR** only, if it was changed, otherwise press **↻** to advance to **SEPR** Data Separation Submenu.

### DATA SEPARATION CHARACTER SUBMENU:

Determines whether data sent from the device in Continuous Data Flow Mode will be separated by spaces or by Carriage Returns.

- Press **↻** 34) Display flashes previous selection for “Separation” Submenu.
- Press **▲** 35) Scroll through the available selections: **SPCE** “Space” or **CR** “Carriage Return”.
- Press **↻** 36) Display shows **SEEd** stored message momentarily and then advances to **DATE.F** only, if it was changed, otherwise press **↻** to advance to **DATE.F** Data Format Submenu.

## DATA FORMAT SUBMENU:

Preformatted data can be sent automatically or upon request from the controller. Use the Data Format Submenus to determine what data will be sent in this preformatted data string. Refer to the iSeries Communications Manual for more information about the data format. At least one of the following suboptions must be enabled and hence output data to the Serial Bus.

**Note** This menu is applicable for Continuous Mode of RS-232 communication.

Press **⏪** 37) Display advances to **SEAL** Alarm Status Submenu.

## ALARM STATUS SUBMENU:

Includes Alarm Status bytes in the data string.

Press **⏪** 38) Display flashes previous selection for "Status" (alarm status).  
Press **⏩** 39) Scroll through the available selections: NO, YES.  
Press **⏪** 40) Display shows **SEAL** stored message momentarily and then advances to **RJNG** only, if it was changed, otherwise press **⏪** to advance to **RJNG** Reading Submenu.

## MAIN READING SUBMENU:

Includes Main Reading in the data string.

Press **⏪** 41) Display flashes previous selection for "Reading".  
Press **⏩** 42) Scroll through the available selections: NO, YES.  
Press **⏪** 43) Display shows **SEAL** stored message momentarily and then advances to **PEAK** only, if it was changed, otherwise press **⏪** to advance to **PEAK** Peak Submenu.

## PEAK VALUE SUBMENU:

Includes Peak Value in the data string.





Press **⏪** 44) Display flashes previous selection for **PEAK** Submenu.  
Press **⏩** 45) Scroll through the available selections: NO, YES.  
Press **⏪** 46) Display shows **SEAL** stored message momentarily and then advances to **GROS** only, if it was changed, otherwise press **⏪** to advance to **GROS** Gross Submenu.

## GROSS VALUE SUBMENU:

Includes Gross Value in the data string.

Press **⏪** 47) Display flashes previous selection for "Gross".  
Press **⏩** 48) Scroll through the available selections: NO, YES.  
Press **⏪** 49) Display shows **SEAL** stored message momentarily and then advances to **UNTE** only, if it was changed, otherwise press **⏪** to advance to **UNTE** Unit Submenu.

## UNIT SUBMENU (not applicable):







- Press  50) Display flashes previous selection for **UNIT**.
- Press  51) Scroll through the available selections: NO, YES.
- Press  52) Display shows **SEEd** stored message momentarily and then advances to **Addr** only, if it was changed, otherwise press  to advance to **Addr** Address Setup Submenu.

## ADDRESS SETUP SUBMENU:

**Note**  This menu is applicable to the RS-485 Option only.

- Press  53) Display advances to “Address Value” (0000 to 0199) Submenu.

## ADDRESS VALUE SUBMENU:

- Press  54) Display flashes 1<sup>st</sup> digit of previously stored Address Value.
- Press  &  55) Press  and  to enter new “Address Value”.
- Press  56) Display shows **SEEd** stored message momentarily and then advances to **ER.TM** only, if it was changed, otherwise press  to advance to **ER.TM** Transmit Time Interval Submenu.







## TRANSMIT TIME INTERVAL SUBMENU:

This menu is applicable if “Continuous” Mode was selected in the “Data Flow Mode” Submenu and the device is configured as an RS-232C Standard device. Also, one or more options under the Data Format Submenu must be enabled.

- Press  57) Display advances to “Transmit Time Value” Submenu.

## TRANSMIT TIME INTERVAL VALUE SUBMENU:

Determines the interval at which data will be emitted to the RS-232 Serial Bus when the instrument is in Continuous Data Flow Mode.

- Press  58) Display flashes 1<sup>st</sup> digit of previous “Transmit Time Value” in seconds.
- Press  &  59) Press  and  to enter new “Transmit Time Value”, e.g. 0030 will send the data every 30 seconds in Continuous Mode.
- Press  60) Display shows **SEEd** stored message momentarily and then advances to **COLR** only, if it was changed, otherwise press  to advance to **COLR** Color Display Selection Menu.

**Note**  For more details, refer to the Communication Manual available at the website listed on the cover page of this manual or on the CD-ROM enclosed with your shipment.

### 3.2.16 Display Color Selection Menu

The menu below allows the user to select the color of the display.

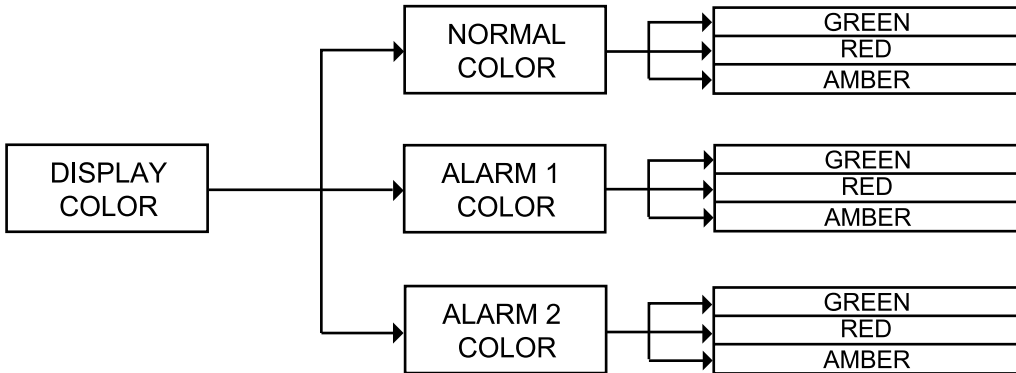

Figure 3.14 Flow Chart for Display Color Selection Menu

#### ENTER DISPLAY COLOR SELECTION MENU:

- Press **⏻** 1) Press **⏻**, if necessary, until **ENFC** prompt appears.
- Press **⏻** 2) Display advances to **INPE** Input Menu.
- Press **⏻** 3) Press **⏻**, if necessary, until Display advances to **COLOR** Display Color Selection Menu.
- Press **⏻** 4) Display advances to **N.CLR** Normal Color Submenu.

#### NORMAL COLOR DISPLAY SUBMENU:



- Press **⏻** 5) Display flashes the previous selection for “Normal Color”.
- Press **⏴** 6) Scroll through the available selections: **GRN**, **RED** or **AMBR**.
- Press **⏻** 7) Display shows **SEEd** stored message momentarily and then advances to **1.CLR** only, if it was changed, otherwise press **⏻** to advance to **1.CLR** Alarm 1 Display Color Submenu.

The menu below allows the user to change the color of display when alarm is triggered.

#### ALARM 1 DISPLAY COLOR SUBMENU:

- Press **⏻** 8) Display flashes previous selection for “Alarm 1 Color Display”.
- Press **⏴** 9) Scroll through the available selections: **GRN**, **RED** or **AMBR**.
- Press **⏻** 10) Display shows **SEEd** stored message momentarily and then advances to **2.CLR** only, if it was changed, otherwise press **⏻** to advance to **2.CLR** Alarm 2 Display Color Submenu.

## ALARM 2 DISPLAY COLOR SUBMENU:

- Press  11) Display flashes previous selection for "Alarm 2 Color Display".
- Press  12) Scroll through the available selections: **GRN**, **RED** or **AMBR**.
- Press  13) Display shows **SEtRd** stored message momentarily and then momentarily shows the software version number, followed by **RSE** Reset, and then proceeds to the Run Mode.



**Tip** IN ORDER TO DISPLAY ONE COLOR, SET THE SAME DISPLAY COLOR ON ALL THREE SUBMENUS ABOVE.



**Note** If user wants the Display to change color every time that both Alarm 1 and Alarm 2 are triggered, the Alarm values should be set in such a way that Alarm 1 value is always on the top of Alarm 2 value, otherwise value of Alarm 1 will overwrite value of Alarm 2 and Display Color would not change when Alarm 2 is triggered.

### Example 1:

Output 1 & Output 2: SSR

Alarm Setup: Absolute, Above, Alarm 2 HI Value "ALR.H" = 200,

Alarm 1 HI Value "ALR.H" = 400

Color Display Setup: Normal Color "N.CLR" = Green, Alarm 1 Color "1.CLR" = Amber, Alarm 2 Color "2.CLR" = Red

### Display Colors change sequences:



### Example 2:

Output 1 & Output 2: Pulse

Alarms Setup: Absolute, Below, Alarm 2 Low Value "ALR.L" = 300,

Alarm 1 Low Value "ALR.L" = 100

Color Display Setup: "N.CLR" = Green, "1.CLR" = Amber, "2.CLR" = Red

### Display Colors change sequences:

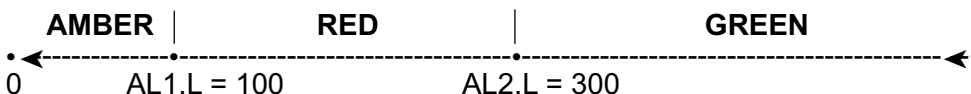

**Example 3:**

Output 1 = Analog Output (Alarm 1 disabled), Setpoint 1 = 300,

Output 2 = Relay, Setpoint 2 = 200

Alarm 1 & 2 Setup: Deviation, Band, "ALR.H" = 10

Color Display Setup: "N.CLR" = Green, "1.CLR" = Amber, "2.CLR" = Red

**Display Colors change sequences:**

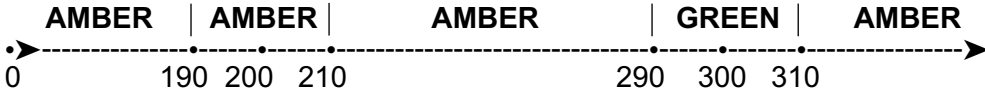

Alarm 1 is designed to monitor the Process Value around the Setpoint 1.  
Alarm 2 is designed to monitor the Process Value around the Setpoint 2.  
If Analog Output Option board is installed (Alarm 1 is disabled), only Alarm 2 is active and only two colors are available.

**Example 4:**

Output 1 = Relay, Setpoint 1 = 200

Output 2 = Relay, Setpoint 2 = 200

Alarm 1 Setup: Deviation, Band, "ALR.H" = 20

Alarm 2 Setup: Deviation, Hi/Low, "ALR.H" = 10, "ALR.L" = 5

Color Display Setup: "N.CLR" = Green, "1.CLR" = Amber, "2.CLR" = Red

**Display colors change sequences:**



**Reset:** The instrument automatically resets after the last menu of the Configuration Mode has been entered. After the instrument resets, it advances to the Run Mode.

## PART 4 SPECIFICATIONS

**Accuracy** 0.03% reading

**Resolution** 10 / 1  $\mu$ V

**Temperature Stability** 50 ppm/ $^{\circ}$ C

**NMRR** 60 dB

**CMRR** 120 dB

**A/D Conversion** Dual slope

**Reading Rate**  
3 samples per second

**Digital Filter**  
Programmable

**Display**  
4-digit, 9-segment LED  
• 10.2 mm (0.40"): iS32, iS16, iS16D (DualDisplay), iS8DV (Dual Vertical)  
• 21 mm (0.83"): iS8  
• 10.2 mm (0.40") and 21 mm (0.83"): iS8DH (Dual Horizontal)  
red, green and amber programmable colors for process variable, set point

**Warm up to Rated Accuracy**  
30 min.

**INPUT**  
**Input Types**  
Analog Voltage, Analog Current

**Voltage Input**  
0 to 100 mV  
0 to 1 V ( $\pm$ 100 mV),  
0 to 10 Vdc

**Input Impedance:**  
10 M $\Omega$  for 100 mV  
1 M $\Omega$  for 1 V or 10 Vdc

**Current Input**  
0 to 20 mA (5 ohm load)

**Linearization Points**  
Up to 10 Linearization Points

**Configuration**  
Single-ended

**Polarity**  
Unipolar

**Step Response**  
0.7 sec for 99.9%

**Decimal Selection**  
None, 0.1, 0.01 or 0.001

**Setpoint Adjustment**  
-1999 to 9999 counts

**Span Adjustment**  
0.001 to 9999 counts

**Offset Adjustment**  
-1999 to +9999

**CONTROL**  
**Action**  
Reverse or direct

**Modes**  
Time and Amplitude Proportional Control Modes; selectable Manual or Auto PID, Proportional, Proportional with Integral, Proportional with Derivative with Anti-reset Windup and ON/OFF

**Rate**  
0 to 399.9 seconds

**Reset**  
0 to 3999 seconds

### **Cycle Time**

1 to 199 seconds; set to 0 for on/off operation

### **Gain**

0.5 to 100% of span; Setpoints 1 or 2

### **Damping**

0000 to 0008

### **Soak**

00.00 to 99.59 (HH:MM), or off

### **Ramp to Setpoint**

00.00 to 99.59 (HH:MM), or off

### **Auto Tune**

Operator initiated from front panel

## **CONTROL OUTPUT 1 & 2**

### **Relay**

250 Vac or 30 Vdc @ 3 A  
(Resistive Load); configurable for on/off, PID and Ramp and Soak

**Output 1:** SPDT type, can be configured as Alarm 1 output

**Output 2:** SPDT type, can be configured as Alarm 2 output

### **SSR**

20-265 Vac @ 0.05-0.5 A  
(Resistive Load); continuous

### **DC Pulse**

Non-Isolated; 10 Vdc @ 20 mA

### **Analog Output (Output 1 only)**

Non-Isolated, Proportional 0 to 10 Vdc or 0 to 20 mA; 500  $\Omega$  max

## **NETWORK AND COMMUNICATIONS (Optional -C24, -C4EI, -EI not available with excitation)**

**Ethernet:** Standards Compliance  
IEEE 802.3 10Base-T

**Supported Protocols:** TCP/IP, ARP, HTTPGET

## **RS-232/RS-422/RS-485/MODBUS:**

Selectable from menu; both ASCII and modbus protocol selectable from menu. Programmable 300 to 19.2 K baud; complete programmable setup capability; program to transmit current display, alarm status, min/max, actual measured input value and status.

### **RS-485**

Addressable from 0 to 199

### **Connection**

Screw terminals

### **ALARM 1 & 2 (programmable):**

Same as Output 1 & 2

### **Operation**

High/low, above/below, band, latch/unlatch, normally open/normally closed and process/deviation; front panel configurations

### **ANALOG OUTPUT (programmable)**

Non-Isolated, Retransmission 0 to 10 Vdc or 0 to 20 mA, 500  $\Omega$  max (Output 1 only). Accuracy is  $\pm 1\%$  of FS, for Scaling Gain from 0.03 to 100 mV per count

### **EXCITATION**

#### **(optional in place of Communication)**

5 Vdc @ 40 mA

10 Vdc @ 60 mA

Not available for Low Power Option

### **INSULATION**

#### **Power to Input/Output, (Reinforce)**

2300 Vac per 1 min. test

1500 Vac per 1 min. test,  
(Low Voltage/Power Option)

#### **Power to Relays/SSR Outputs**

2300 Vac per 1 min. test

#### **Relays/SSR to Relay/SSR Outputs**

2300 Vac per 1 min. test

#### **RS-232/485 to Inputs/Outputs**

500 Vac per 1 min. test

(no isolation is provided for Strain units)



## Approvals

UL, C-UL and see CE Approval Section

## GENERAL

### Line Voltage/Power

90-240 Vac +/-10%, 50-400 Hz\*

110-375 Vdc, equivalent voltage

**4 W** power for iS8, iS8C, iS16, iS32

**5 W**, power for iS8DV, iS8DH, iS16D

\* No CE compliance above 60 Hz

### Low Voltage/Power Option

12-36 Vdc, **3 W\*\*** power for iS8, iS8C, iS16, and iS32

20-36 Vdc, **4 W**, power for iS8DV, iS8DH, and iS16D

External power source must meet Safety Agency Approvals.

\*\* *Units can be powered safely with 24 Vac power but, no Certification for CE/UL are claimed.*

### External Fuse Required

Time-Delay, UL 248-14 listed:

100 mA/250 V

400 mA/250 V (Low Voltage/Power Option)

Time-Lag, IEC 127-3 recognized:

100 mA/250 V

400 mA/250 V (Low Voltage/Power Option)

### Environmental Conditions

•All models: 0 to 55 °C (32 to 131 °F), 90% RH non-condensing

•iS8DV, iS8DH, iS8C, iS16D:

0 to 50 °C (32 to 122 °F) for UL only,

90% RH non-condensing

## Protection

NEMA-4x/Type 4x/IP65 front bezel: iS32, iS16D, iS8C

NEMA-1/Type 1 front bezel: iS8, iS8DH, iS8DV

## Dimensions

i/8 Series:

48 H x 96 W x 127 mm D

(1.89 x 3.78 x 5")

i/8 Compact Series:

48 H x 96 W x 74 mm D

(1.89 x 3.78 x 2.91")

i/16 Series: 48 H x 48 W x 127 mm D

(1.89 x 1.89 x 5")

i/32 Series:

25.4 H x 48 W x 127 mm D

(1.0 x 1.89 x 5")

## Panel Cutout

i/8 Series:

45 H x 92 W mm (1.772" x 3.622 "),

1/8 DIN

i/16 Series: 1/16 DIN

45 mm (1.772") square

i/32 Series:

22.5 H x 45 W mm (0.886" x 1.772"),

1/32 DIN

## Weight

i/8 Series: 295 g (0.65 lb)

i/16 Series: 159 g (0.35 lb)

i/32 Series: 127 g (0.28 lb)

## PART 5 FACTORY PRESET VALUES

**Table 5.1 Factory preset value**

MENU ITEMS	FACTORY PRESET VALUES	NOTES
Set Point 1 (SP1)	000.0	
Set Point 2 (SP2)	000.0	
<b>Input:</b>		
Input Type (INPT)	0 TO 100 MV (0-0.1)	
Ratiometric Operation (RTIO)	Enable (ENBL)	
Input/Reading Resolution (RESO)	Low (LO)	
ⓘ Button	Peak (PEAK)	
<b>Reading Configuration (RDG):</b>		
Decimal Point (DEC.P)	FFF.F	
Known/Unknown Load (LOAD)	Disable (DSBL)	
Linearization Points (L.PNT)	0002 or NONE	
Filter Value (FLTR)	0004	
Input/Reading (IN.RD) Scale and Offset	0-100 mV = 0-9999	
<b>Alarm 1 &amp; 2:</b>		
Alarm 1 (ALR1), Alarm 2 (ALR2)	Disable (DSBL)	
Absolute/Deviation (ABSO/DEV)	Absolute (ABSO)	
Latch/Unlatch (LTCH/UNLT)	Unlatch (UNLT)	
Contact Closure (CT.CL)	Normally Open (N.O.)	
Active (ACTV)	Above (ABOV)	
Alarm At Power On (A.P.ON)	Disable (DSBL)	Alarm 1 only
Alarm Low (ALR.L)	-100.0	
Alarm High (ALR.H)	400.0	
<b>Loop:</b>		
Loop Break Time (LOOP)	Disable (DSBL)	
Loop Value (B.TIM)	00:59	
Setpoint Deviation (SP.dV)	Disable (DSBL)	
<b>ANALOG OUTPUT (Retransmission):</b>		
Analog Output (ANLG)	Enabled (ENBL)	
Current/Voltage (CURR/VOLT)	Voltage (VOLT)	
Scale and Offset	Reading: 0 - 999.9 cts, Output: 0 - 10 V	
<b>Output 1 &amp; 2:</b>		
Self (SELF)	Disabled (DSBL)	Output 1 only
% Low Value (%LO)	0000	Output 1 only
% High Value (%HI)	0099	Output 1 only
Control Type (CTRL)	On/Off	
Action Type (ACTN)	Reverse (RVRS)	
Dead Band (DEAD)	020.0	

MENU ITEMS	FACTORY PRESET VALUES	NOTES
<b>PID:</b>		
PID Auto (AUTO)	Disable (DSBL)	
Anti Integral (ANTI)	Disable (DSBL)	Output 1 only
Proportion Value (PROP)	020.0	
Reset Value (REST)	0180	Output 1 only
Rate Value (RATE)	0000	Output 1 only
Cycle Value (CYCL)	0007	
Damping Factor (DPNG)	0003	
<b>Ramp &amp; Soak (RAMP):</b>		
Ramp (RAMP)	Disable (DSBL)	
Soak (SOAK)	Disable (DSBL)	
Ramp Value (RAMP)	00:00	
Soak Value (SOAK)	00:00	
<b>ID:</b>		
ID Value	0000	
Full ID (FULL)	Disable (DSBL)	
Set Point ID (ID.SP)	Disable (DSBL)	
<b>Communication Parameters:</b>		
Baud Rate (BAUD)	9600	
Parity (PRTY)	Odd	
Data bit (DATA)	7 bit	
Stop Bit	1 bit	
Modbus Protocol (M.BUS)	No	
Line Feed (LF)	No	
Echo (ECHO)	Yes	
Standard Interface (STND)	RS-232 (232C)	
Command Mode (MODE)	Command (CMD)	
Separation (SEPR)	Space (SPCE)	
Alarm Status (STAT)	No	
Reading (RDNG)	Yes	
Peak	No	
Gross (GROS)	No	
Units (UNIT)	No	
Multipoint Address (ADDR)	0001	
Transmit Time (TR.TM)	0016	
<b>Display Color (COLR):</b>		
Normal Color (N.CLR)	Green (GRN)	
Alarm 1 Color (1.CLR)	Red (RED)	
Alarm 2 Color (2.CLR)	Amber (AMBR)	

## PART 6 CE APPROVALS INFORMATION

 This product conforms to the EMC directive 89/336/EEC amended by 93/68/EEC, and with the European Low Voltage Directive 72/23/EEC.

### Electrical Safety EN61010-1:2001

Safety requirements for electrical equipment for measurement, control and laboratory.

#### Double Insulation

#### Pollution Degree 2

#### Dielectric withstand Test per 1 min

- Power to Input/Output: 2300Vac (3250Vdc)
- Power to Input/Output: 1500Vac (2120Vdc)  
(Low Voltage dc Power Option\*)
- Power to Relays/SSR Output: 2300Vac (3250Vdc)
- Ethernet to Inputs: 1500Vac (2120Vdc)
- Isolated RS232 to Inputs: 500Vac (720Vdc)
- Isolated Analog to Inputs: 500Vac (720Vdc)
- Analog/Pulse to Inputs: No Isolation

#### Measurement Category I

Category I are measurements performed on circuits not directly connected to the Mains Supply (power). Maximum Line-to-Neutral working voltage is 50Vac/dc. This unit should not be used in Measurement Categories II, III, IV.

#### Transients Overvoltage Surge (1.2 / 50µs pulse)

- Input Power: 2500V
- Input Power: 1500V  
(Low Voltage dc Power Option\*)
- Ethernet: 1500V
- Input/Output Signals: 500V

**Note:** \*Units configured for external low power dc voltage, 12-36Vdc

#### EMC EN61326:1997 + and A1:1998 + A2:2001

Immunity and Emissions requirements for electrical equipment for measurement, control and laboratory.

- EMC Emissions Table 4, Class B of EN61326
- EMC Immunity\*\* Table 1 of EN61326

**Note:** \*\*I/O signal and control lines require shielded cables and these cables must be located on conductive cable trays or in conduits. Furthermore, the length of these cables should not exceed 30 meters



Refer to the EMC and Safety installation considerations (Guidelines) of this manual for additional information.







## WARRANTY/DISCLAIMER

OMEGA ENGINEERING, INC. warrants this unit to be free of defects in materials and workmanship for a period of **one (1) year** from the date of purchase. In addition to OMEGA's standard warranty period, OMEGA Engineering will extend the warranty period for **four (4) additional years** if the warranty card enclosed with each instrument is returned to OMEGA.

If the unit malfunctions, it must be returned to the factory for evaluation. OMEGA's Customer Service Department will issue an Authorized Return (AR) number immediately upon phone or written request. Upon examination by OMEGA, if the unit is found to be defective, it will be repaired or replaced at no charge. OMEGA's WARRANTY does not apply to defects resulting from any action of the purchaser, including but not limited to mishandling, improper interfacing, operation outside of design limits, improper repair, or unauthorized modification. This WARRANTY is VOID if the unit shows evidence of having been tampered with or shows evidence of having been damaged as a result of excessive corrosion; or current, heat, moisture or vibration; improper specification; misapplication; misuse or other operating conditions outside of OMEGA's control. Components which wear are not warranted, including but not limited to contact points, fuses, and triacs.

**OMEGA is pleased to offer suggestions on the use of its various products. However, OMEGA neither assumes responsibility for any omissions or errors nor assumes liability for any damages that result from the use of its products in accordance with information provided by OMEGA, either verbal or written. OMEGA warrants only that the parts manufactured by it will be as specified and free of defects. OMEGA MAKES NO OTHER WARRANTIES OR REPRESENTATIONS OF ANY KIND WHATSOEVER, EXPRESS OR IMPLIED, EXCEPT THAT OF TITLE, AND ALL IMPLIED WARRANTIES INCLUDING ANY WARRANTY OF MERCHANTABILITY AND FITNESS FOR A PARTICULAR PURPOSE ARE HEREBY DISCLAIMED. LIMITATION OF LIABILITY: The remedies of purchaser set forth herein are exclusive, and the total liability of OMEGA with respect to this order, whether based on contract, warranty, negligence, indemnification, strict liability or otherwise, shall not exceed the purchase price of the component upon which liability is based. In no event shall OMEGA be liable for consequential, incidental or special damages.**

CONDITIONS: Equipment sold by OMEGA is not intended to be used, nor shall it be used: (1) as a "Basic Component" under 10 CFR 21 (NRC), used in or with any nuclear installation or activity; or (2) in medical applications or used on humans. Should any Product(s) be used in or with any nuclear installation or activity, medical application, used on humans, or misused in any way, OMEGA assumes no responsibility as set forth in our basic WARRANTY/DISCLAIMER language, and, additionally, purchaser will indemnify OMEGA and hold OMEGA harmless from any liability or damage whatsoever arising out of the use of the Product(s) in such a manner.

## RETURN REQUESTS/INQUIRIES

Direct all warranty and repair requests/inquiries to the OMEGA Customer Service Department. **BEFORE RETURNING ANY PRODUCT(S) TO OMEGA, PURCHASER MUST OBTAIN AN AUTHORIZED RETURN (AR) NUMBER FROM OMEGA'S CUSTOMER SERVICE DEPARTMENT (IN ORDER TO AVOID PROCESSING DELAYS).** The assigned AR number should then be marked on the outside of the return package and on any correspondence.

The purchaser is responsible for shipping charges, freight, insurance and proper packaging to prevent breakage in transit.

FOR WARRANTY RETURNS, please have the following information available **BEFORE** contacting OMEGA:

1. Purchase Order number under which the product was PURCHASED,
2. Model and serial number of the product under warranty, and
3. Repair instructions and/or specific problems relative to the product.

FOR NON-WARRANTY REPAIRS, consult OMEGA for current repair charges. Have the following information available **BEFORE** contacting OMEGA:

1. Purchase Order number to cover the COST of the repair,
2. Model and serial number of product, and
3. Repair instructions and/or specific problems relative to the product.

OMEGA's policy is to make running changes, not model changes, whenever an improvement is possible. This affords our customers the latest in technology and engineering.

© Copyright 2006 OMEGA ENGINEERING, INC. All rights reserved. This document may not be copied, photocopied, reproduced, translated, or reduced to any electronic medium or machine-readable form, in whole or in part, without the prior written consent of OMEGA ENGINEERING, INC.

**TRADEMARK NOTICE:** ®, *omega.com*®,  **OMEGA**®, and  are Trademarks of OMEGA ENGINEERING, INC.

**PATENT NOTICE:** This product is covered by one or more of the following patents: U.S. Pat. No. Des. 336,895; 5,274,577; 6,243,021 / CANADA 2052599; 2052600 / ITALY 1249456; 1250938 / FRANCE BREVET No. 91 12756 / SPAIN 2039150; 2048066 / UK PATENT No. GB2 249 837; GB2 248 954 / GERMANY DE 41 34398 C2. The "Meter Bezel Design" is a Trademark of NEWPORT Electronics, Inc. USED UNDER LICENSE. Other US and International Patents pending or applied for.

# Where Do I Find Everything I Need for Process Measurement and Control? **OMEGA...Of Course!**

***Shop on line at [omega.com](http://omega.com)***

## **TEMPERATURE**

- Thermocouple, RTD & Thermistor Probes, Connectors, Panels & Assemblies
- Wire: Thermocouple, RTD & Thermistor
- Calibrators & Ice Point References
- Recorders, Controllers & Process Monitors
- Infrared Pyrometers

## **PRESSURE, STRAIN AND FORCE**

- Transducers & Strain Gauges
- Load Cells & Pressure Gauges
- Displacement Transducers
- Instrumentation & Accessories

## **FLOW/LEVEL**

- Rotameters, Gas Mass Flowmeters & Flow Computers
- Air Velocity Indicators
- Turbine/Paddlewheel Systems
- Totalizers & Batch Controllers

## **pH/CONDUCTIVITY**

- pH Electrodes, Testers & Accessories
- Benchtop/Laboratory Meters
- Controllers, Calibrators, Simulators & Pumps
- Industrial pH & Conductivity Equipment

## **DATA ACQUISITION**

- Data Acquisition & Engineering Software
- Communications-Based Acquisition Systems
- Plug-in Cards for Apple, IBM & Compatibles
- Datalogging Systems
- Recorders, Printers & Plotters

## **HEATERS**

- Heating Cable
- Cartridge & Strip Heaters
- Immersion & Band Heaters
- Flexible Heaters
- Laboratory Heaters

## **ENVIRONMENTAL MONITORING AND CONTROL**

- Metering & Control Instrumentation
- Refractometers
- Pumps & Tubing
- Air, Soil & Water Monitors
- Industrial Water & Wastewater Treatment
- pH, Conductivity & Dissolved Oxygen Instruments



## Free Manuals Download Website

<http://myh66.com>

<http://usermanuals.us>

<http://www.somanuals.com>

<http://www.4manuals.cc>

<http://www.manual-lib.com>

<http://www.404manual.com>

<http://www.luxmanual.com>

<http://aubethermostatmanual.com>

Golf course search by state

<http://golfingnear.com>

Email search by domain

<http://emailbydomain.com>

Auto manuals search

<http://auto.somanuals.com>

TV manuals search

<http://tv.somanuals.com>