

CE



User's Guide



<http://www.omega.com>
e-mail: info@omega.com

CL23A, 24, 25, 26, 27 Digital Calibrator/Thermometer

Download from [Www.Somanuals.com](http://www.Somanuals.com). All Manuals Search And Download.

omega.com™

Ω OMEGA®

OMEGAnetSM On-Line Service
http://www.omega.com

Internet e-mail
info@omega.com

Servicing North America:

USA:
ISO 9001 Certified

One Omega Drive, Box 4047
Stamford, CT 06907-0047
Tel: (203) 359-1660
e-mail: info@omega.com

FAX: (203) 359-7700

Canada:

976 Bergar
Laval (Quebec) H7L 5A1
Tel: (514) 856-6928
e-mail: canada@omega.com

FAX: (514) 856-6886

For immediate technical or application assistance:

USA and Canada:

Sales Service: 1-800-826-6342 / 1-800-TC-OMEGASM
Customer Service: 1-800-622-2378 / 1-800-622-BESTSM
Engineering Service: 1-800-872-9436 / 1-800-USA-WHENSM
TELEX: 996404 EASYLINK: 62968934 CABLE: OMEGA

**Mexico and
Latin America:**

Tel: (95) 800-TC-OMEGASM
En Español: (203) 359-1660 ext: 2203

FAX: (95) 203-359-7807
e-mail: espanol@omega.com

Servicing Europe:

Benelux:

Postbus 8034, 1180 LA Amstelveen, The Netherlands
Tel: (31) 20 6418405
Toll Free in Benelux: 06 0993344
e-mail: nl@omega.com

FAX: (31) 20 6434643

Czech Republic:

Ostravska 767, 733 01 Karvina
Tel: 42 (69) 6311899
e-mail: czech@omega.com

FAX: 42 (69) 6311114

France:

9, rue Denis Papin, 78190 Trappes
Tel: (33) 130-621-400
Toll Free in France: 0800-4-06342
e-mail: france@omega.com

FAX: (33) 130-699-120

Germany/Austria:

Daimlerstrasse 26, D-75392 Deckenpfronn, Germany
Tel: 49 (07056) 3017
Toll Free in Germany: 0130 11 21 66
e-mail: germany@omega.com

FAX: 49 (07056) 8540

United Kingdom:

ISO 9002 Certified

25 Swannington Road,
Broughton Astley, Leicestershire,
LE9 6TU, England
Tel: 44 (1455) 285520
FAX: 44 (1455) 283912

P.O. Box 7, Omega Drive,
Irlam, Manchester,
M44 5EX, England
Tel: 44 (161) 777-6611
FAX: 44 (161) 777-6622

Toll Free in England: 0800-488-488
e-mail: uk@omega.com

It is the policy of OMEGA to comply with all worldwide safety and EMC/EMI regulations that apply. OMEGA is constantly pursuing certification of its products to the European New Approach Directives. OMEGA will add the CE mark to every appropriate device upon certification.

The information contained in this document is believed to be correct but OMEGA Engineering, Inc. accepts no liability for any errors it contains, and reserves the right to alter specifications without notice.

WARNING: These products are not designed for use in, and should not be used for, patient connected applications.

Download from [Www.Somanuals.com](http://www.Somanuals.com). All Manuals Search And Download.

TABLE OF CONTENTS

General Information.....	2
Common Specifications.....	2
Unique Specifications.....	5
Features.....	6
Manual Addenda.....	6
Unpacking Your Unit.....	7
Safety Information.....	7
Safety Precautions.....	7
Battery Installation/Replacement.....	9
Memory Backup.....	10
Operation with Rechargeable Battery.....	10
Operating Instructions.....	11
1. Diagnostics and Error Messages.....	11
2. Initial Turn On.....	11
3. Meter Mode Operation (Thermocouple).....	13
4. Meter Mode Operation (RTD, Thermistor, Ohms).....	14
5. Data Logging & Recall.....	15
6. Calibrator Mode Operation (Thermocouples).....	17
7. Calibrator Mode Operation (RTD, Thermistor, Ohms).....	18
8. Storage and Recall of Calibrator Settings.....	20
9. Step Function.....	22
10. Ramp Function.....	22
Service Information.....	23
1. Calibration Procedures.....	23
2. Calibration Verification.....	32
3. Mechanical Parts Diagram.....	38
Warranty.....	45
Limitation of Warranty.....	45
Statement of Calibration.....	45

GENERAL INFORMATION

This manual provides operating instructions and maintenance information for five temperature instruments. These instruments are high performance calibrator-thermometers capable of simulating and measuring a wide-variety of sensors. In addition, features such as data storage and ramping further enhance their versatility.

It is recommended that you read this manual thoroughly, especially the sections on safety, prior to operating these instruments.

COMMON SPECIFICATIONS

THERMOMETER INPUTS: THERMOCOUPLE; Miniature TC jack. RTD, OHMS, THERMISTOR; T-series instrumentation connector.

CALIBRATOR OUTPUTS: THERMOCOUPLE; Miniature TC jack. RTD, OHMS, THERMISTOR; T-series instrumentation connector.

THERMOCOUPLE TYPES: K, J, T, E, N, B, R, S, G, C, D.

RTD TYPES: 100 Ω platinum ($\infty = 0.00385$)
1000 Ω platinum ($\infty = 0.00385$)

THERMISTOR TYPE: 2252 Ω (YSI Series 400).

RANGES:

- K; -200°C to 1372°C, -328°F to 2502°F
- J; -210°C to 760°C, -346°F to 1400°F
- T; -200°C to 400°C, -328°F to 752°F
- E; -230°C to 1000°C, -382°F to 1832°F
- N; -200°C to 1300°C, -328°F to 2372°F
- B; 500°C to 1820°C, 932°F to 3308°F
- R; 0°C to 1768°C, 32°F to 3214°F
- S; 0°C to 1768°C, 32°F to 3214°F
- G; 300°C to 2316°C, 572°F to 4201°F
- C; 0°C to 2316°C, 32°F to 4201°F
- D; 0°C to 2316°C, 32°F to 4201°F

RTD; -200°C to 850°C, -328°F to 1562°F

THERMISTOR; -40°C to 150°C, -40°F to 302°F

OHMS; 0-999.99 Ω
0-9,999.9 Ω
0-99,999 Ω

ACCURACY (18°C to 28°C ambient, 2 years)*:

K, J, T, E, N; $\pm 0.5^\circ\text{F}$ (rdg $\geq -50^\circ\text{F}$)
 $\pm 1.0^\circ\text{F}$ (rdg $< -50^\circ\text{F}$)

B, R, S, G, C, D; $\pm 1.7^\circ\text{F}$

RTD; $\pm 0.2^{\circ}\text{F}$ (rdg $\geq -50^{\circ}\text{F}$)
 $\pm 0.5^{\circ}\text{F}$ (rdg $< -50^{\circ}\text{F}$)
 $\pm 0.2^{\circ}\text{F} \pm 0.04\%$ rdg (meter mode)
THERMISTOR; $\pm 0.5^{\circ}\text{F}$
OHMS; $\pm 0.02\%$ range

* Exclusive of sensor errors, and lead resistance induced errors.

RESOLUTION: TEMPERATURE; $0.1^{\circ}/1^{\circ}$ F/C
OHMS; $0.01\Omega/0.1\Omega/1\Omega$

REPEATABILITY (1 week at constant ambient temperature):

K, J, T, E, N; $\pm 0.2^{\circ}\text{F}$ typ.
B, R, S, G, C, D; $\pm 1.0^{\circ}\text{F}$ typ.
RTD, THERMISTOR; $\pm 0.1^{\circ}\text{F}$ typ.
OHMS; $\pm 0.01\%$ rng typ.

TEMPERATURE COEFFICIENT:

From 18°C to 28°C , included in accuracy specifications.

From 0°C to 18°C , and 28°C to 50°C :

K, J, T, E, N; $\pm(0.002\% \text{ rdg} + 0.03^{\circ}\text{C})/^{\circ}\text{C}$

B, R, S, G, C, D; $\pm(0.002\% \text{ rdg} + 0.1^{\circ}\text{C})/^{\circ}\text{C}$

RTD, THERMISTOR, OHMS; $\pm(0.002\% \text{ rdg} + 0.004\% \text{ rng})/^{\circ}\text{C}$

METER-MODE INPUT-CURRENT (THERMOCOUPLES): 50nA typ.

METER-MODE READING-RATE: 1 reading/second typ.

METER-MODE EXCITATION-CURRENTS:

100Ω RTD; $<2\text{mA}$

1000Ω RTD; $<200\mu\text{A}$

999.99Ω ; $<2\text{mA}$

9999.9Ω ; $<200\mu\text{A}$

99999Ω ; $<50\mu\text{A}$

THERMISTOR; $T \leq 113^{\circ}\text{F}$ $<50\mu\text{A}$

$T > 113^{\circ}\text{F}$, $<2\text{mA}$

CALIBRATOR MODE OUTPUT LOAD (THERMOCOUPLES): 500Ω min.

CALIBRATOR-MODE EXCITATION-CURRENTS:

100Ω RTD; $0.5 - 1\text{mA}$ ($0.1 - 2\text{mA}$ typ.)

1000Ω RTD; $50 - 100\mu\text{A}$ ($10-200\mu\text{A}$ typ.)

999.99Ω ; Same as 100Ω RTD

9999.9Ω ; Same as 1000Ω RTD

99999Ω ; $10 - 20\mu\text{A}$ ($1 - 20\mu\text{A}$ typ.)

THERMISTOR; $T \leq 113^{\circ}\text{F}$, $10 - 20\mu\text{A}$

$T > 113^{\circ}\text{F}$, $0.5 - 1\text{mA}$

MAXIMUM COMMON MODE VOLTAGE: 42V peak to earth.

KEYPAD: 12 momentary switches with tactile feedback select;

- On/Off
- Change/Enter
- Clear/-0
- Sensor Select/1
- °F/°C/2
- Resolution/3
- Operate/4
- Store/5
- Recall/6
- Calibrator/Meter/Up Ramp/7
- Calibrator Step/Down Ramp/8
- Calibrator Ramp/Meter Hold/9

DISPLAY: 5 digit LCD, 0.4" height, and decimal point. Annunciators;

- Loaded Memory Locations (10 for data storage, 4 for ramp parameters)
- Low Battery (BAT)
- Number Change Mode (NUM)
- Calibrator Mode (CALIB)
- Meter Mode (METER)
- Operate Mode (OPR)
- Store Mode (STO)
- Recall Mode (RCL)
- Meter Hold (HOLD)
- Scale (°F/°C)
- Sensor Type

POWER OFF CONFIGURATION RETENTION: Instrument retains last selected;

- Sensor Type
- °F/°C Scale
- 0.1°/1° Resolution
- Calibrator/Meter Mode
- Memory Contents (data storage and ramp parameters).

DIAGNOSTICS: Display codes indicate following conditions;

- 'BAT': Low Battery
- 'OPEN': Open Input Thermocouple, RTD or Thermistor.
- 'E-1' (momentary): Invalid Keypad Entry
- 'E-2' (momentary): Ramp Function Not Installed
- 'HI': Temperature Reading or Keypad Entry Exceeds Rating
- 'LO': Temperature Reading or Keypad Entry Too Low For Accuracy
- LCD Test: During power-up, all segments and annunciators enabled momentarily

ENVIRONMENTAL LIMITS FOR OPERATING: 0°C to 50°C, less than 90% relative humidity (R.H.) up to 35°C; reduce R.H. limit by 3%/°C from 35°C to 50°C.

ENVIRONMENTAL LIMITS FOR STORAGE: -35°C to 60°C, less than 95% relative humidity (R.H.) up to 35°C; reduce R.H. limit by 3%/°C from 35°C to 60°C.

POWER: 9 volt alkaline battery (NEDA 1604A).

BATTERY LIFE, CONTINUOUS: 10 hrs. typical, alkaline; 3 hrs typical, Ni-Cd (rechargeable).

BATTERY INDICATOR: Display indicates BAT when less than 10% of life remains.

DIMENSIONS, WEIGHT: 7.0" × 2.9 × 1.1". Net weight 12 oz.

UNIQUE SPECIFICATIONS

NOTE: The specifications below are specific to the model(s) as identified by model number. The difference specifications are in addition to the OVERALL SERIES SPECIFICATIONS found on pages 2-5.

• **MODEL CL23A/CL23EC:**

SENSOR SELECTION: K, J, T/K, J, T, L Thermocouples

ACCURACY: (18°C to 28°C ambient, 2 years): $\pm 0.5^{\circ}\text{F}$ (rdg $\geq -50^{\circ}\text{F}$).
 $\pm 0.04\%$ rdg (rdg $> 1250^{\circ}\text{F}$)
 $\pm 1.0^{\circ}\text{F}$ (rdg $< -50^{\circ}\text{F}$)

TEMPERATURE COEFFICIENT: 18°C to 28°C; included in accuracy specifications. From 0°C to 18°C, and 28°C to 50°C; less than $\pm(0.006\% \text{ rdg } +0.03^{\circ}\text{C})/^{\circ}\text{C}$.

RAMP FUNCTION: Not Included.

BATTERY LIFE, CONTINUOUS: 16 hrs typical, alkaline; 4 hrs typical, Ni-Cd (rechargeable).

• **MODEL CL24:**

SENSOR SELECTION: K, J, T, E Thermocouples

ACCURACY: (18°C to 28°C ambient, 2 years): $\pm 0.5^{\circ}\text{F}$ (rdg $\geq -50^{\circ}\text{F}$).
 $\pm 0.04\%$ rdg (rdg $> 1250^{\circ}\text{F}$)
 $\pm 1.0^{\circ}\text{F}$ (rdg $< -50^{\circ}\text{F}$)

TEMPERATURE COEFFICIENT: 18°C to 28°C; included in accuracy specifications. From 0°C to 18°C, and 28°C to 50°C; less than $\pm(0.006\% \text{ rdg } +0.03^{\circ}\text{C})/^{\circ}\text{C}$.

RAMP FUNCTION: Not Included.

BATTERY LIFE, CONTINUOUS: 16 hrs typical, alkaline; 4 hrs typical, Ni-Cd (rechargeable).

• **MODEL CL25/CL25EC:**

SENSOR SELECTION: K, J, T, E, N, B, R, S, G, C, D/K, J, T, E, N, B, R, S, L, C, D Thermocouples

RAMP FUNCTION: Included.

BATTERY LIFE, CONTINUOUS: 16 hrs typical, alkaline; 4 hrs typical, Ni-Cd (rechargeable)

• **MODEL CL26:**

SENSOR SELECTION: K, J, T, E Thermocouples

100Ω Platinum RTD

2252Ω Thermistor

1,000Ω/100,000Ω Resistance

ACCURACY: (18°C to 28°C ambient, 2 years): ± 0.5 °F (rdg ≥ -50 °F).
 $\pm 0.04\%$ rdg (rdg > 1250 °F)
 ± 1.0 °F (rdg < -50 °F)
OHMS; $\pm 0.04\%$ range

TEMPERATURE COEFFICIENT: 18°C to 28°C; included in accuracy specifications.
From 0°C to 18°C, and 28°C to 50°C.

K, J, T, E; $\pm(0.006\% \text{ rdg} + 0.03^\circ\text{C})/^\circ\text{C}$

RTD, THERMISTOR, OHMS; $\pm(0.006\% \text{ rdg} + 0.012\% \text{ mg})/^\circ\text{C}$

RAMP FUNCTION: Not Included.

• **MODEL CL27/CL27EC:**

SENSOR SELECTION: K, J, T, E, N, B, R, S, G, C, D/K, J, T, E, N, B, R, S, L, C,
D Thermocouples
100 Ω /1000 Ω Platinum RTD
1,000 Ω /10,000 Ω Resistance

RAMP FUNCTION: Included.

FEATURES

- Combination calibrator, thermometer and datalogger.
- Function selection and numeric data entered via 12 keyswitch color coded keypad.
- Keyswitches have tactile feedback.
- 5 digit LCD includes annunciators for operating modes.
- Up to 11 thermocouple types, 2 RTD types, and thermistor.
- 1° or 0.1° resolution over temperature range of each sensor.
- °F and °C scales.
- Reading hold mode.
- 10 memory locations for saving meter readings and/or calibrator outputs.
- Step mode for quick sequential recall of calibrator outputs from memory.
- Manual/automatic ramping for testing controller setpoints.
- Conforms to ITS-90 thermocouple tables.
- Dust proof, splash proof, drop proof construction.
- Built-in tilt stand/hanger for bench use or hands free field measurements.
- User friendly programming.
- Retains data and programming, even when turned off.
- Performs diagnostic tests and indicates fault conditions.
- Low battery and open sensor indications.

MANUAL ADDENDA

Improvements or changes to this manual will be explained on an addendum included with the instrument. All change information should be incorporated immediately into the appropriate places in the manual.

UNPACKING YOUR UNIT

Remove the Packing List and verify that you have received all equipment. If you have any questions about the shipment, please call the OMEGA Customer Service Department at 1-800-622-2378 or (203) 359-1660.

When you receive the shipment, inspect the container and equipment for any signs of damage. Note any evidence of rough handling in transit. Immediately report any damage to the shipping agent.

NOTE: The carrier will not honor any claims unless all shipping material is saved for their examination. After examining and removing contents, save packing material and carton in the event reshipment is necessary.

Make sure that you have the following items in the packing box.

- 1 CL20 Series Calibrator and Holster.
- 1 Operator's Manual
- 1 NIST Certificate
- 1 Accessories Kit

SAFETY INFORMATION

SAFETY SYMBOLS AND TERMS

The symbol  on the instrument denotes that the user should refer to the operating instructions.

The **WARNING** used in this manual explains dangers that could result in personal injury or death.

The **CAUTION** used in this manual explains hazards that could damage the instrument.

SAFETY PRECAUTIONS

WARNING

These instruments are intended for use by qualified personnel trained in the safe operation of electronic testing equipment. Read the instruction manual thoroughly before using, to become familiar with the instrument's operations and capabilities.

WARNING

Do not touch a temperature probe sheath when measuring excessively high or low temperatures, or toxic substances.

WARNING

Do not attempt to measure temperatures beyond the range of the probe being used. Probe damage or personal injury could result from exceeding a probe's maximum temperature rating.

WARNING

The American National Safety Institute (ANSI) states that a shock hazard exists when probes or sensors are exposed to voltage levels greater than 42VDC or 42V peak AC. Do not use this instrument where voltages at the measurement surface exceed these levels.

WARNING

Do not substitute a metal part for the nylon screw in the rear case. Doing so will degrade electrical isolation of the case.

WARNING

The battery is accessible through a cover on the back of the instrument. To avoid electrical shock hazard, disconnect all temperature probes and sensors and turn the unit off before removing the cover.

WARNING

Never use this instrument or any probe or sensor inside a microwave oven.

CAUTION

Avoid making sharp bends in probe or sensor lead wires. Bending lead wires at a sharp angle can damage the wire causing probe failure.

CAUTION

Keep inputs electrically isolated from outputs. Do not connect an external voltage source between the two connectors, and avoid any external electrical pathways between input and output (T2 & T1).

Failure to do so will disturb meter readings and calibrator output levels. Damage to the instrument is also possible.

Where the meter and calibrator connectors are simultaneously wired into a system lacking the above isolation, it is necessary to use an "ungrounded" (i.e. electrically isolated) probe at the thermometer input.

BATTERY INSTALLATION/REPLACEMENT

A 9V alkaline battery is supplied with the instrument but not installed. Read the following installation instructions before attempting to install or remove the battery. Replacement batteries should also be alkaline types.

WARNING

Turn the unit off and disconnect any input/output connections before replacing the battery. Put the cover back into place on the battery compartment before resuming use of the instrument.

1. Remove the cover from the battery compartment by sliding it off in the direction of the arrow located on the battery cover.

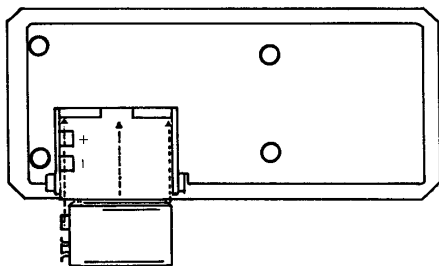

Figure 1. Battery Installation

2. Remove the old battery by lifting the battery extractor loop.
3. Place the new battery in the battery compartment. Be sure to observe proper polarity.
4. Re-install the battery cover before resuming use of the instrument.

NOTES:

- Less than 10% of battery life remains when the BAT annunciator turns on.
- When the battery is excessively discharged, the display is blanked.
- If the instrument is going to be stored for a long period of time or in a high temperature environment, remove the battery to prevent leakage damage.
- **After a new battery is installed, allow approximately 5 seconds for display turn-on the first time the unit is turned on. During this period, microcomputer initialization is performed.**

MEMORY BACKUP

During battery replacement, the contents of user-programmed memory (data, operating modes, etc.) can be saved. Prior to removing the old battery, turn off the instrument, and connect an HH22-AC battery charger. Then exchange batteries, and disconnect the battery charger. Do not leave the battery charger connected to instruments with non-rechargeable batteries.

OPERATION WITH RECHARGEABLE BATTERY

HH22-AC provides a 9-volt Ni-Cd battery and recharger suitable for use with the unit. This battery provides 3-4 hours of continuous operation. This duration can be extended to several days by operating simultaneously from both the battery and recharger.

Turn off the instrument to recharge the battery. Allow 7 hours to fully recharge the battery. Then unplug the recharger to avoid overcharging.

OPERATING INSTRUCTIONS

1. DIAGNOSTICS AND ERROR MESSAGES

Unit self-diagnostics provide fault condition readouts which are described below:

PROBLEM:

LIKELY CAUSE:

Blank display, unit does not power-up.

- (1) Improper battery installation. Check battery polarity.
- (2) Dead battery.

BAT Annunciator.

- (1) Low battery voltage, install a new battery. If problem persists, consult factory.

Display reads OPEN.

- (1) No thermocouple, RTD or thermistor is plugged into the meter input.

Display reads E1 momentarily.

- (1) This indicates that an invalid keypad entry has been made. Review keystroke sequence, or consult manual for input instructions.

Display reads E2 momentarily.

- (1) Attempt made to activate non-installed ramp function. NOTE: RAMP Function enabled on Models CL25 and CL27 only.

Display reads HI.

- (1) Meter-mode input-temperature exceeds rating of selected sensor.
- (2) Calibrator-mode keypad-entry exceeds rating of sensor type.

Display reads LO.

- (1) Meter-mode input-temperature too low for accurate measurement.
- (2) Calibrator-mode keypad-entry too low for accurate simulation.

2. INITIAL TURN ON

Turn on the instrument by depressing the ON-OFF keyswitch once (Figure 2). At power-up, the unit first performs a display test. All segments and annunciators of the liquid crystal (LCD) are momentarily turned on for visual confirmation by the user (Figure 3).

NOTE: In case of missing or poor-contrast segments, contact factory.

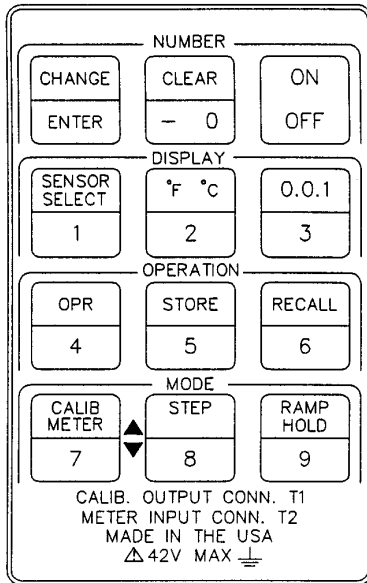

Figure 2. Keypad



Figure 3. Display Test

If the unit is turning on for the first time after a new battery is installed, it will automatically default to the METER mode (ie. temperature measurement operation). It also defaults to K-type thermocouples, and °F readings with 0.1° resolution. The corresponding LCD annunciators are enabled:

METER: (unit functioning as a thermometer)
K: (K-type thermocouple)
°F: (Fahrenheit readings)
OPR: (Instrument is operational)

If no input thermocouple is connected to the unit at this time, the numeric segments will indicate "OPEN".

Plugging a thermocouple into the meter jack (connector T2, on the top right side) will give actual thermocouple temperature readings.

NOTE: To obtain full accuracy, allow 1-2 minutes after connecting a thermocouple plug, for thermal setting.

If the instrument is to be used as a thermometer or ohmmeter, refer to the Meter Mode Operation section for detailed instructions. For use as a temperature-calibrator or ohms simulator, refer to Calibrator Mode Operation.

3. METER MODE OPERATION (Thermocouples)

Set-Up:

1. Turn on instrument by depressing the ON/OFF key.
2. Check that the BAT annunciator turns off following the power-up LCD test. If it does not turn off, less than 10% of battery remains. Refer to Battery Installation/Replacement instructions.
3. If the meter is already in the METER mode, the METER annunciator will be on. Otherwise the calibrator mode is enabled and the CALIB annunciator is on. Depress the METER key to return to meter mode.
4. Connect an input thermocouple (TC) to connector T2. Select the appropriate TC Type with the select-key. A display annunciator will indicate the selected TC-type.

NOTE: Space and legibility constraints on the display preclude the use of dedicated annunciators for the less common tungsten-rhenium thermocouple types (G, C & D). Instead, these types are annunciated momentarily on the alpha-numeric display when first selected. Both T and R annunciators remain on to indicate a Tungsten-Rhenium selection. To recall the actual G, C, D selection, turn the unit off, then on again for another momentary read-out.

5. Select temperature scale with °F/°C key. The corresponding annunciator is enabled.

6. Select display resolution with 0.1°/1° key.

NOTE: Set-up is retained during power-off.

Hold:

Meter readings can be put on hold at any time by depressing the HOLD key. At this time, the HOLD annunciator turns on, the reading is frozen, and all keys (except ON/OFF and HOLD) are locked out. Depress the HOLD key again to return to real-time readings, and re-enable the keypad.

4. METER MODE OPERATION (RTD, Thermistor & Ohms)

Set-Up:

1. Connect a sensor or unknown resistance to the instrument as shown in Figures 4, 5, or 6.

The 2-wire configuration is simplest, but includes lead-wire resistance in the measurement. 2-wire measurements are generally limited to high resistance sensors (e.g. 1000-ohm RTDs, 2252-ohm thermistors).

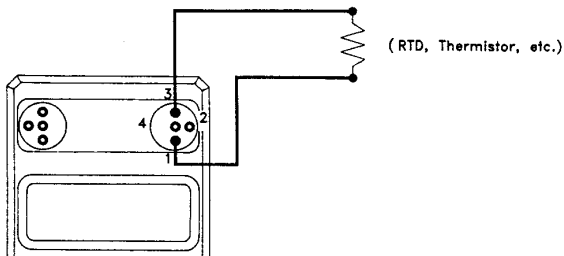

Figure 4. 2-Wire Resistance Measurement

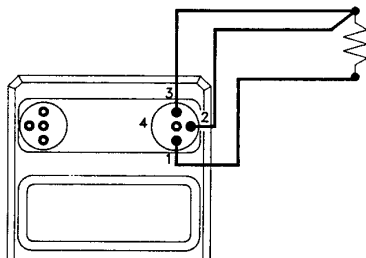

Figure 5. 3-Wire Resistance Measurement

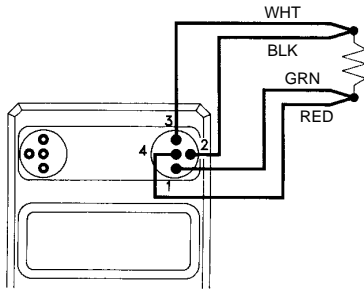

Figure 6. 4-Wire Resistance Measurement

Lead resistance errors are compensated for in 3-wire configurations. However full compensation requires equal resistance in each lead. This configuration is common with 100-ohm RTDs.

In 4-wire configurations, accuracy is unaffected by lead resistance, and resistance differences between leads.

NOTE: These instruments measure input voltages on all 4 terminals, and are able to distinguish between 2-4 and 3-wire hookups. Switching between these measurement modes is automatic.

2. Set instrument to METER mode.
3. Use the sensor-select key to set the instrument to the appropriate function and range.

NOTE: Due to limited display area, 100 Ω and 1000 Ω RTD's are indicated on the display by a momentary readout of "RTD-100" (or "RTD-1000") when first selected.

Thermistors are identified by a momentary alpha-numeric readout of "Y-400" (signifying YSI Series-400 type thermistor).

Any of these readouts can be recalled by turning the unit off and back on.

5. DATA LOGGING AND RECALL

Operating as a meter, the unit can save and recall up to 10 readings (each with independent parameters: eg. °F/°C, TC-type and resolution) in random access memory.

To Save Readings:

1. While in the METER OPR mode, depress the STORE key. Note that the OPR annunciator is replaced by STO.
2. Next depress one of the memory location numbers (keys 0, 1, . . . , 9). The corresponding memory annunciator turns on and the meter returns momentarily to the OPR mode, displaying thermocouple temperature.

eg. STORE 7

NOTES:

- The enabled location annunciator indicates that the meter reading at the instant that the location number key was hit, was stored in memory.
- When data is stored in a location already filed with data, the new data replaces the old.
- Stored readings are retained during power-off.

To Recall Readings:

1. While in the METER OPR mode, readings stored earlier can be displayed by first depressing the RECALL key. Note that the OPR annunciator is replaced by RCL, and all memory location annunciators are blanked.
2. Next depress the keypad number corresponding to the desired location. Note that the annunciator for this location turns on, and the memory contents are displayed.
3. Several stored readings can be randomly recalled by a key sequence such as:

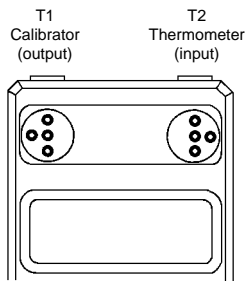

Figure 7.

eg. RECALL 3
RECALL 5
RECALL 2
etc.

4. To return the meter to the operate mode, depress OPR after recalling the last reading. All active location annunciators will turn on again, together with the OPR annunciator.

NOTE: Recalling data from unused (ie, empty) locations will give a zero reading.

To Erase Data Locations (Meter Mode):

1. Individual data locations can be erased by recalling the location to be cleared, followed by a CLEAR key input. Note that the annunciator for the cleared location is turned off, and the meter returns to OPR.

eg. RECALL 3
CLEAR

NOTES: There is no need to clear a location if new data is ready for saving in this location. Just STORE the new data. It will write over and delete the old.

6. CALIBRATOR MODE OPERATION (Thermocouples)

Set-Up:

1. Turn on the instrument by depressing the ON/OFF key.
2. Check that the BAT annunciator turns off after display check. If not, refer to Battery Installation/Replacement instructions.
3. When operating as a calibrator, the display indicates CALIB. Should the instrument be in the METER mode, hit the CALIB key to change to the calibrator function.
4. Select the thermocouple type that will be used.

NOTE: Space and legibility constraints on the display preclude the use of dedicated annunciators for the less common tungsten-rhenium thermocouple types (G, C, & D). Instead, these types are annunciated momentarily on the alpha-numeric display when first selected. Both T and R annunciators remain on to indicate a Tungsten-Rhenium selection. To recall the actual G, C, D selection, turn the unit off, then on again for another momentary read-out.

5. Select the desired temperature scale (°F/°C key).

6. Select the resolution desired (0.1°/1° key).

NOTE: With 1° resolution, one less key stroke will be required to enter calibrator output temperatures via the keypad.

7. The unit accepts numeric inputs by first changing the keypad to its number-entry mode (NUM) by depressing the CHANGE/ENTER key once. The numeric display will flash, the OPR annunciator will turn off, and the NUM annunciator will turn on. Key in desired temperature value, most significant digit first. After the desired temperature value is keyed in, hit CHANGE//ENTER to return to OPR mode.

To enter a value of 212° with 0.1° resolution, the following keystrokes are used:

CHANGE/ENTER, 2, 1, 2, 0, CHANGE/ENTER

NOTES:

- Invalid numeric entries (eg. a temperature beyond the span of the selected TC type) will cause a corresponding error code to be displayed.
- To enter negative (ie. minus) temperatures, hit the -0 key first when in the NUM mode. The first hit on this key enters the negative sign. Subsequent hits enter zeros.
- To correct a numeric entry while in the NUM mode, hit the CHANGE/ENTER key twice. This will return number entry to the beginning of a new number.
- To return the calibrator output to 0° while in the OPR mode, hit the CLEAR key.
- The unit can be used as a convenient °F to °C or °C to °F calculator.

For example, to convert 77°F to a Celsius reading, go to the CALIB OPR mode, enter the reading to be converted, and change scale.

eg. °F
CHANGE/ENTER
77
CHANGE/ENTER
°C (Display reads 25°C)

7. CALIBRATOR MODE OPERATION (RTD, Thermistor & Ohms)

Set-Up:

1. Connect measurement equipment under test (eg. RTD thermometer, ohmmeter, etc.) to the instrument as shown in Figures 8, 9, or 10.

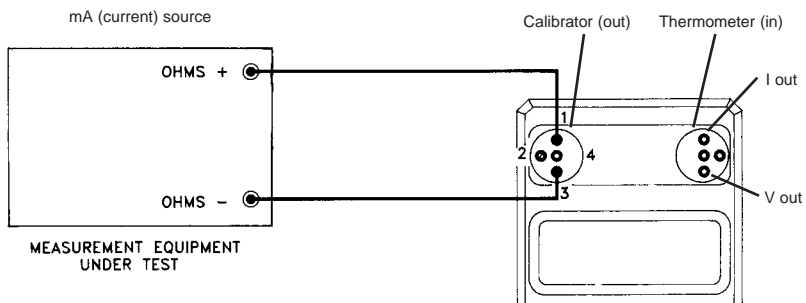

Figure 8. 2-Wire Resistance Simulation

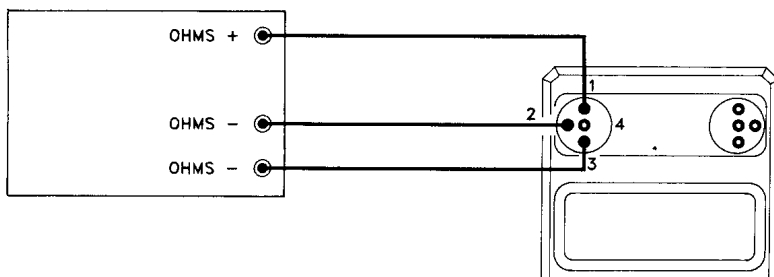

Figure 9. 3-Wire Resistance Simulation

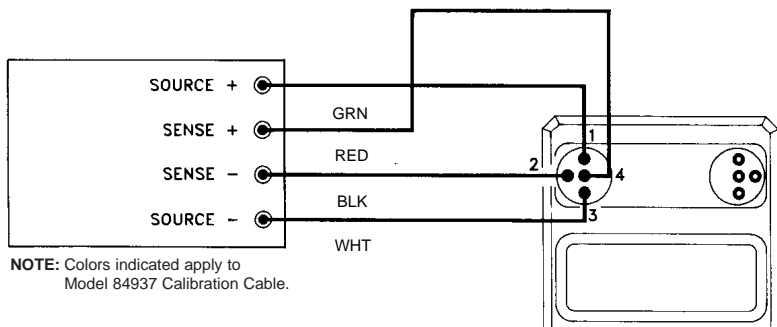

Figure 10. 4-Wire Resistance Simulation

The same performance tradeoffs apply to 2, 3 and 4-wire simulations as to 2, 3, and 4-wire measurements. Refer to RTD, Thermistor and Ohms Meter-Mode section above for wiring guidelines.

2. Set instrument to CALIBRATOR mode.
3. Use the sensor-select key to set the instrument to the appropriate function and range.

NOTE: To ensure accurate calibrator outputs, observe specified limits to excitation currents. If in doubt, check current levels with a DMM in series with either source lead (1 or 3).

NOTE: Due to limited display area, 100 Ω and 1000 Ω RTD's are indicated on the display by a momentary readout of "RTD-100" (or "RTD-1000") when first selected.

Thermistors are identified by a momentary alpha-numeric readout of "Y-400" (signifying YSI Series-400 type thermistor).

Any of these readouts can be recalled by turning the unit off and back on.

8. STORAGE AND RECALL OF CALIBRATOR SETTINGS

While operating as a calibrator, the unit can store and recall up to 10 output settings (each with independent parameters, eg. °F/°C, sensor type, and resolution) in random access memory.

To Store Outputs:

1. While in the CALIB OPR mode, depress the STORE key. Note that the OPR annunciator is replaced by STO.
2. Next depress one of the memory location numbers (keys 0, 1, 2, . . . , 9). The corresponding memory annunciator turns on, and the calibrator returns to the OPR mode.

eg. STORE 2

NOTES:

- The enabled memory annunciator shows that the output set-up has been saved.
- When a set up is stored in a location already in use, the new set-up replaces the old.
- Saved set-ups are retained during power-off.
- To store a reading of 0° just hit the CLEAR while in the CALIB OPR mode. Then depress STORE and a location number.

To Recall Outputs:

1. While in the CALIB OPR mode, set-ups saved earlier in memory can be recalled to program the calibrator output. First depress the RECALL key to recall a set-up.

Note that the RCL annunciator turns on, OPR turns off, and all memory locations annunciators are blanked.

2. Next hit the key with the number corresponding to the desired memory location. The corresponding annunciator turns on, and the LCD updates to show the new calibrator setting.

eg. RECALL 8

3. Several stored set-ups can be randomly recalled by a key sequence such as:

eg. RECALL 6
RECALL 3
RECALL 9
etc.

4. To return the unit to the CALIB OPR mode after recalling the last set-up, hit the OPR key.

NOTES:

- Any other key except ON/OFF and CLEAR will also return the OPR mode.
- Set-ups recalled from unused locations will display and output 0°.
- Calibrator set-ups can be recalled even when the unit is functioning in the meter mode. The same 10 storage locations are shared in both meter and calibrator modes.
- Readings stored in memory while operating as a METER, can be recalled in the CALIB mode. In this unusual application, the unit generates calibrator outputs that simulate earlier stored meter inputs.

To Erase Set-Up Locations (Calibrator Mode):

1. Individual set-up locations can be erased by recalling the location followed by a hit to the CLEAR key.

eg. RECALL 5
CLEAR

9. STEP FUNCTION

When operating in the CALIBRATOR mode, the STEP key will sequentially recall data stored in memory (up to 10 steps). At each step, the calibrator will display and output these parameters. The STEP function is non-functional in METER mode.

10. RAMP FUNCTION: CL25 and CL27

This feature, available only on Models CL25 and CL27, allows the calibrator to automatically ramp up and down a user-defined staircase. Up and down keys allow for manual ramping by the user.

To activate the RAMP function, the instrument must first be in the CALIBRATE mode. Depress the RAMP key once to enter the ramp programming mode. The display reads "prog", with memory annunciators 1-4 flashing. A second hit to the RAMP key starts automatic ramping. A third hit turns off the RAMP function.

User definable RAMP memory locations 1, 2, 3, & 4 are dedicated to storage of RAMP parameters; step size, staircase starting point, upper limit, and lower limit respectively. These memory locations are accessible only when in RAMP "prog" mode, and are independent of the other 10 memory locations. Numeric values for RAMP parameters can be set, stored, recalled, and cleared like other calibrator settings. (Refer page 17, CALIBRATOR MODE OPERATION).

When automatic ramping is in progress, a hit to either the 7 or 8 key activates manual up-ramping or down-ramping respectively. Whenever the battery is replaced (and memory backup is not performed), the ramp parameters default to factory-set values:

- LOC 1 Step Size =10°F (K TC)
- 2 Start Point = 500°F
- 3 High Limit = 550°F
- 4 Low Limit = 450°F

SERVICE INFORMATION

WARNING

All service information is intended for qualified electronic maintenance personnel only.

1. CALIBRATION PROCEDURES

This is a two-part procedure. Products with thermocouple functions only, follow the Thermocouple Calibration procedure below. Products with resistance functions (RTD, thermistor, ohms) follow first the Thermocouple Calibration procedure, then the Resistance Calibration procedure.

A. THERMOCOUPLE CALIBRATION

Test Equipment Required:

1. Thermocouple simulator (OMEGA CL521, or equivalent) calibrated to ITS-90.
2. Microvolt DMM (OMEGA OM7551, or equivalent)
3. Calibration cables, per Figures 11, 12, 13.

NOTE: The copper constantan cables used in Figures 12 and 13 need to be calibrated. Voltage errors in these cables should be compensated at the simulator.

4. Calibration cover (OMEGA 820-307-4).

Ambient Conditions:

Units should be calibrated at an ambient temperature of $23^{\circ}\text{C} \pm 1^{\circ}\text{C}$, with relative humidity less than 80%.

Preparation for Calibration:

1. Remove battery from unit under test (U.U.T.). Refer to Battery Installation/Replacement section in the manual.
2. Remove bottom-cover from U.U.T. Refer to Disassembly Instructions.
3. Remove calibration-jumpers J1 and J2 from printed-circuit board.

NOTE: Removal of J1, J2 causes partial loss of previously stored calibration data. Do not remove these jumpers unless recalibration is intended.

NOTE: For calibrators with the older, single-jumper configuration, refer to calibration procedure beginning on page 39.

4. Install calibration cover in place of bottom-cover.
5. Re-install battery.
6. Hook up test-equipment, calibration cables, and U.U.T. per Figure 10.
7. Turn on DMM and TC simulator for warmup. Allow at least 30 minutes.
8. Set the DMM to 200mV DC range.
9. Set the TC simulator to its COPPER output mode, with a reference temperature of 32.0°F.
10. Turn on U.U.T. and verify that "RTD" and "Ω" annunciators are flashing on the display. This verifies removal of J1 and J2 respectively.

NOTE: Flashing "RTD" indicates that zero-offset corrections can be stored in EEPROM. It also indicates that cold-junction compensation is disabled.

Flashing 'Ω' indicates that error corrections for the cold-junction sensors can be stored or recalled from EEPROM.

11. Clear the EEPROM locations used to store E1 (meter cold-junction sensor error) and E2 (calibrator cold-junction sensor error) as follows:
 - a. Set U.U.T to CALIB, OPR, K, °F mode.
 - b. Key in: CHANGE/0.0/ENTER/STO/1/OPR (E1 is set to 0.0°F)
 - c. Key in: CHANGE/0.0/ENTER/STO/2/OPR (E2 is set to 0.0°F)

NOTE: Both 1 & 2 memory annunciators should be turned on, but the "RTD" annunciator will have turned off.

- d. Perform RECALL 1 and RECALL 2 to verify storage of 0.0°F in both locations.

NOTE: At the completion of calibration, E1 and E2 will be saved in EEPROM. Memory locations 1 and 2 will be free for normal use.

- e. Set U.U.T. to METER, OPR, K, °F.
 - f. Turn U.U.T. OFF, then ON to re-enable 'RTD' and 'Ω' annunciators.

Calibration Adjustments:

NOTE: Do not deviate from the calibration adjustment sequence that follows. This will ensure that adjustments to be stored in EEPROM go to the correct locations.

1. Set meter-mode zero and gain adjustments per Table 1.
2. Hit OPR key (RTD annunciator turns off).
3. Set U.U.T. to CALIB, OPR, K, °F.
4. Turn U.U.T. OFF, then ON, to re-enable RTD & Ω annunciators.
5. Set calibrator-mode zero and gain adjustments per Table 2. Hit CHANGE and ENTER at the completion of each step in Table 2.
6. Hit OPR key (RTD annunciator turns off).
7. Install J1 jumper.
8. Set U.U.T. to METER, OPR, T, °F
9. Change TC simulator output to Type T, 32°F, ALLOY mode.
10. Reconfigure calibration set-up per Figure 12. Allow 2-3 minutes for thermal stabilization.
11. Calculate E1 as follows: $E1 = \text{U.U.T. Reading} - 32.0$.
12. Set U.U.T. to CALIB, OPR, T, °F mode.
13. Store E1; CHANGE/(E1 value)/ENTER/STO/1/OPR.
14. Go to METER mode, and verify U.U.T. reading of $32.0 \pm 0.1^\circ\text{F}$.
15. Reconfigure calibration setup per Figure 12. Leave simulator output at 32°F, Type T, ALLOY mode. Allow 2-3 minutes for thermal stabilization.
16. Set U.U.T. to CALIB mode, 32°F, Type T.
17. Calculate E2 as follows:
$$E2 = \frac{\text{DMM Reading (in } \mu\text{V)}}{-22}$$

(For example with DMM reading of +11 μV , $E2 = -0.5^\circ\text{F}$)
18. Store E2; CHANGE/(E2 value)/ENTER/STO/2/OPR.
19. Install J2 jumper.
20. Re-set U.U.T. output to 32°F, DMM reading should be $0 \pm 2\mu\text{V}$.
21. Turn OFF U.U.T.
22. Thermocouple calibration is complete. Remove calibration cover. Re-install original back-cover, unless going on to Part B (Resistance Calibration).

Table 1: Meter-Mode Zero & Gain Adjustments

Step	Sensor Select	U.U.T. Input	Adjust	U.U.T. Reading*
1	K	0.000 mV	P1	32.0 ±0.1°F
2	K	54.856 mV	P11	2500.0 ±0.1°F
3	Repeat Steps 1 & 2 As Required			
4	J	0.000 mV	P1	32.0 ±0.1°F
5	T	0.000 mV	P1	32.0 ±0.1°F
6	E	0.000 mV	P1	32.0 ±0.1°F
7	N	0.000 mV	P1	32.0 ±0.1°F
8	B	1.439 mV	P1	1000.0 ±0.5°F
9	R	0.000 mV	P1	32.0 ±0.5°F
10	S	0.000 mV	P1	32.0 ±0.5°F
11	G**	2.238 mV	P1	600.0 ±0.2 °F
12	C	0.000 mV	P1	32.0 ±0.2°F
13	D	0.000 mV	P1	32.0 ±0.2°F

* exclusive of noise.

** on EC models, G replaced by L. Calibrate L per J.

Table 2: Calibrator-Mode Zero & Gain Adjustments

Step	Sensor Select	U.U.T. Output	Adjust	DMM Reading*
1	K	32.0°F	P1	0.000 mV ±1μV
2	K	2500.0°F	P41	54.856 mV ±1μV
3	Repeat Steps 1 & 2 As Required			
4	J	32.0°F	P1	0.000 mV ±1μV
5	T	32.0°F	P1	0.000 mV ±1μV
6	E	32.0°F	P1	0.000 mV ±1μV
7	N	32.0°F	P1	0.000 mV ±1μV
8	B	1000.0°F	P1	1.439 mV ±1μV
9	R	32.0°F	P1	0.000 mV ±1μV
10	S	32.0°F	P1	0.000 mV ±1μV
11	G**	600.0°F	P1	2.238 mV ±1μV
12	C	32.0°F	P1	0.000 mV ±1μV
13	D	32.0°F	P1	0.000 mV ±1μV

* exclusive of noise.

** on EC models, G replaced by L. Calibrate L per J.

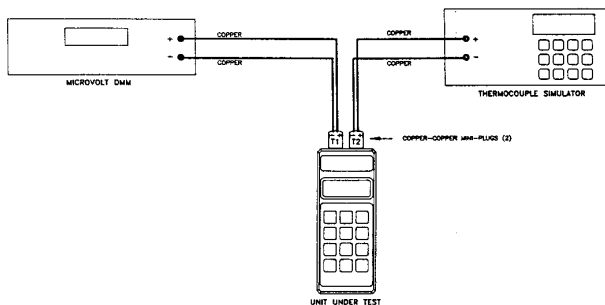

Figure 11. Calibration Setup, Copper Mode.

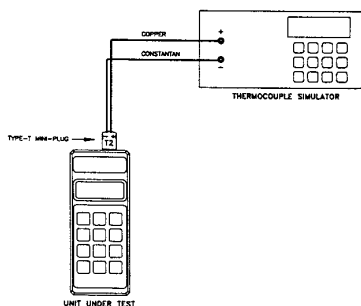

Figure 12. Calibration Setup, Meter Mode.

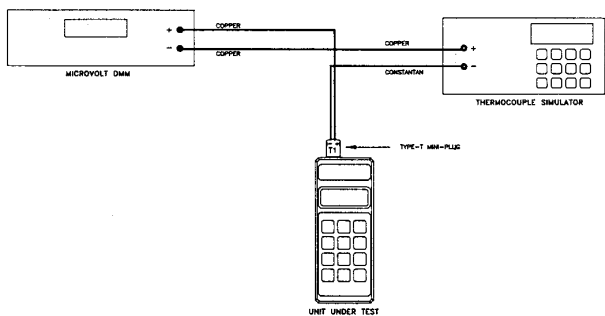

Figure 13. Calibration Setup, Calibrator Mode.

B. RESISTANCE CALIBRATION

NOTE: Thermocouple and resistance calibrations are independent. However, potentiometer P1 is used in both thermocouple and resistance calibrations to set EEPROM constants. Follow calibration procedures carefully to ensure that thermocouple and resistance calibrations do not disturb one another.

Test Equipment Required:

1. Resistance Decades (General Resistance RTD-100, RTD-500/1000, and RDS-54, or equivalent).
2. Current Source (Fluke 5101B, or equivalent).
3. Digital Multimeter (OMEGA OM7551, or equivalent).
4. Calibration cables per Figure 14.

Ambient Conditions:

Unit should be calibrated at an ambient temperature of $23^{\circ}\text{C}\pm 1^{\circ}\text{C}$, with relative humidity less than 80%.

Preparation For Calibration:

1. Turn off unit, and remove bottom-cover. Refer to Disassembly Instructions.
2. Secure battery with a piece of adhesive tape.

NOTE: Momentary loss of battery power during the following calibration will invalidate previous adjustments, both resistance and thermocouple.

3. Hook up test-equipment and unit per Figure 14.
4. Set current-source to 1mA, STANDBY mode.
5. Set DMM to 2V DC range.
6. Turn on unit.
7. Set unit to METER mode, RTD-100, °F.
8. Turn off unit. Remove jumper J1. Turn on unit. 'RTD' annunciator should be flashing.

NOTES: Flashing 'RTD' indicates that calibration adjustments will be written to memory. Avoid selecting thermocouple functions while in this mode.

Should it be necessary to scroll through thermocouple functions, first hit the OPR key (disables flashing 'RTD'), and start again at Step 7 above.

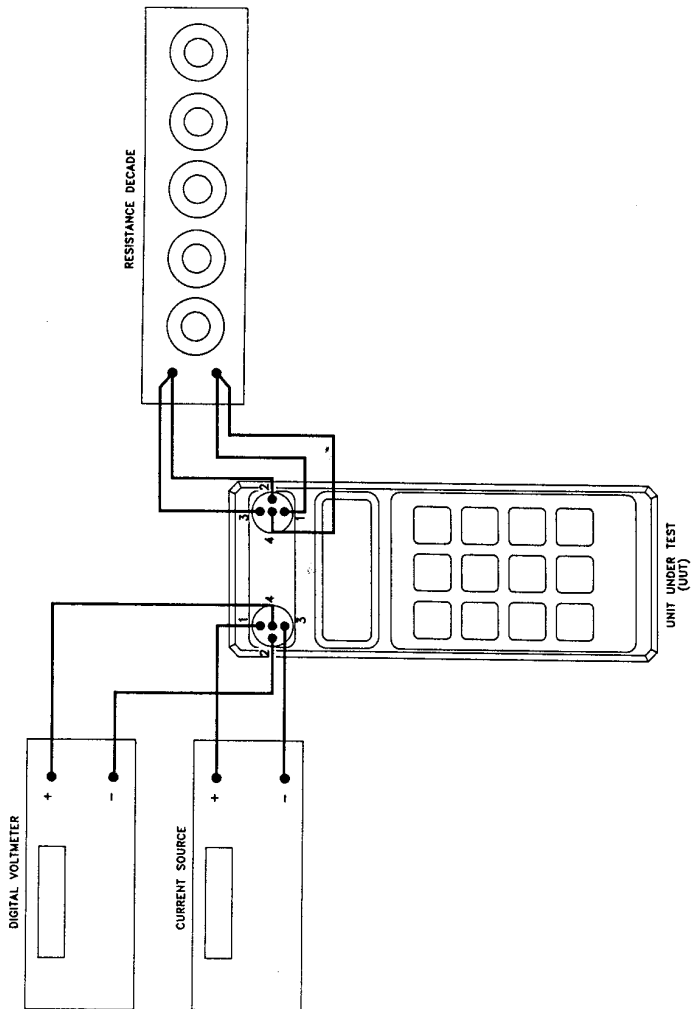

Figure 14. Resistance Calibration Setup

Calibration Adjustments:

NOTE: Do not deviate from the calibration adjustment sequence that follows. This will ensure that adjustments to be stored in EEPROM go to the correct locations.

1. Perform meter-mode adjustments and verifications per Table 3 (use Table 5 for RTD-Thermistor models).
2. Hit OPR key (Flashing 'RTD' annunciator turns off).
3. Install J1 jumper.
4. Set unit to CALIB mode, RTD-100, °F.
5. Switch current source to OPERATE mode.
- 6 Perform calibrator-mode adjustments and verifications per Table 4 (use Table 6 for RTD-Thermistor models).
7. Turn off unit. Remove tape holding battery.
8. Re-install back cover. Resistance-function calibration is complete.

**Table 3: Calibration of Meter-Mode Resistance Functions
(RTD-100/1000)**

Step	Sensor Select	Unit Input	Adjust	Verify	Unit Reading*
1	RTD-100	390.26Ω	P1**		1562.0°F±0.5°F
2	RTD-100	100.00Ω		√	32.0±0.1°F
3	RTD-100	18.49Ω		√	-328.0±0.2°F
4	RTD-1000	3,902.6Ω	P1**		1562.0°F±0.5°F
5	RTD-1000	1000.0Ω		√	32.0±0.1°F
6	1,000Ω	900.00Ω	P1		900.00Ω
7	1,000Ω	1.00Ω		√	1.00±0.10Ω
8	10,000Ω	9,000.0Ω	P1		9000.0Ω
9	10,000Ω	10.0Ω		√	10.0±1.0Ω

* exclusive of noise.

** adjust as necessary to obtain steps 2, 5.

Table 4: Calibration of Calibrator-Mode Resistance Functions (RTD-100/1000)

Step	Sensor Select	Unit Output	Current Source Input	Adjust	Verify	DMM Reading*
1	RTD-100	1562.0°F	1mA	P38	√	0.39026v
2	RTD-100	32.0°F	1mA			0.10000
3	RTD-100	-328.0°F	1mA			±0.00003v
4	RTD-1000	1562.0°F	100µA	P51	√	0.01849
5	RTD-1000	32.0°F	100µA			±0.00006v
6	1,000Ω	900.00Ω	1mA			0.39026v
7	1,000Ω	1.00Ω	1mA			0.10000
8	10,000Ω	9,000.0Ω	100µA			±0.00003v
9	10,000Ω	10.0Ω	100µA			0.90000
						±0.00010v
						0.00100
						±0.00010v

* exclusive of noise.

Table 5: Calibration of Meter-Mode Resistance Functions (RTD-Thermistor)

Step	Sensor Select	Unit Input	Adjust	Verify	Unit Reading*
1	RTD-100	390.26Ω	P1	√	1562.0°F
2	RTD-100	100.00Ω			32.0±0.3°F
3	RTD-100	18.49Ω			-328.0±0.5°F
4	1,000Ω	900.00Ω	P1	√	900.00Ω
5	1,000Ω	1.00Ω			1.00±0.20Ω
6	100,000Ω	90,000Ω	P1	√	90,000Ω
7	100,000Ω	100Ω			100±20Ω
8	Thermistor	47.0Ω	P1	√	293.0°F
9	Thermistor	2252Ω			77.0±0.2°F
10	Thermistor	75,790Ω			-40.0±0.2°F

* exclusive of noise.

Table 6: Calibration of Calibrator-Mode Resistance Functions (RTD-Thermistor)

Step	Sensor Select	Unit Output	Current Source Input	Adjust	Verify	DMM Reading*
1	RTD-100	1562.0°F	1mA	P38		0.39026v
2	RTD-100	32.0°F	1mA		√	0.10000 ±0.00006v
3	RTD-100	-328.0°F	1mA		√	0.01849 ±0.00012v
4	1,000Ω	900.00Ω	1mA		√	0.90000 ±0.00020v
5	1,000Ω	1.00Ω	1mA	P51	√	0.00100 ±0.00020v
6	100,000Ω	90,000Ω	10μA		√	0.90000v 0.00100
7	100,000Ω	100Ω	10μA			±0.00020v
8	Thermistor	293.0°F	1mA		√	0.04700 ±0.00020v
9	Thermistor	77.0°F	10μA		√	0.02252 ±0.00020v
10	Thermistor	-40.0°F	10μA		√	0.75790 ±0.00500v

* exclusive of noise.

2. CALIBRATION VERIFICATION

Calibration is verified with the same instrument hookups as used for calibration (ie. Figures 12 and 13 for thermocouple functions, Figure 14 for resistance functions).

While one hookup serves to verify all resistance functions (RTD, thermistor, ohms), a full check-out of thermocouple functions requires a set of calibration cables for each thermocouple type.

To simplify the verification of thermocouple calibration, software has been enhanced to reactivate the copper-mode used during calibration. This feature is available on products that use the following (and later) software revisions:

Model	Software Revision
CL23A	6.7
CL24	7.7
CL25	3.7
CL26	5.6
CL27	4.16

(Software revision is marked on a label attached to integrated-circuit U1 on the mother-board).

"Copper-mode" is a non-compensated mode of operation during which cold-junction compensation of inputs and outputs is disabled. This permits the use of copper-wire interconnections between instruments, while avoiding the time and expense of multiple thermocouple-cable hookups. At the conclusion of calibration verification, cold-junction compensation is re-enabled, and operation returns to "alloy-mode".

"Alloy-mode" refers to Thermocouple operations; for example, a Type-K thermocouple is made up of Nickel/Chromium and Nickel/Aluminum alloys. Referring to the OMEGA Calibrator(s) in TC operation, "Alloy-mode" means in effect "other than Copper-mode." In order to make accurate measurements using a thermocouple device one must eliminate erroneous voltage signals. In "Alloy-mode", the OMEGA calibrator automatically calculates the cold-junction compensation for the selected TC type, based on the value(s) from the ITS-90 table. This feature enables the user to make accurate temperature measurements without making manual calculations for error corrections.

COPPER MODE VERIFICATION PROCEDURE FOR THERMOCOUPLE FUNCTIONS

Equipment Required:

1. OMEGA Model to be verified.
 2. *Voltmeter* accurate to $1\mu V$ resolution.
 3. *Cable assembly* (Fig. 11).
1. Start your calibration with a fresh battery.
 2. Press the **ON** function button to turn the unit on.
 3. Select the calibrator mode ("CALIB" on display) by pressing the **CALIB/METER** function button.

4. Select type K thermocouple ("K" on display) by pressing the **SENSOR SELECT** function button until type K is reached.
5. Select the tenth degree display (with a digit appearing after the decimal point on the display) by pressing the **0.0.1** function button.
6. Select °F ("°F" on display) by pressing the **°F °C** function button.
7. Press the **CHANGE** function button. The numerical display should blink.
8. Press **9 9 9 9 9**. ("9999.9" should appear blinking on display).
9. Press the **ENTER** function button. The display will blink "Hi" once or twice, and then will display "0.0 °F" blinking. There will also be an "Ω" symbol blinking in the upper left. It will blink with the "0.0 °F" display.
10. Press the **ENTER** function button. The "0.0 °F" display will stop blinking, and the "Ω" will continue to blink. You are now in the copper mode. If or when you turn off the power (or remove the battery) the unit will no longer be in the copper mode and you would have to repeat the above steps to return to the copper mode. **As long as you see the "Ω" blinking you are in the copper mode.**
11. While in the copper mode attach the *Copper Mode Calibrator Verification Cable* to the connector on the top of the *CL25* that is labeled T1. Attach the other end of the cable to a *precision voltmeter*.
12. Press the **CHANGE** function button. The "0.0 °F" display will blink, and "NUM" will appear on the display.
13. Press **3 2 0** buttons and then press the **ENTER** function button. "NUM" will disappear and "32.0 °F" will appear, not blinking. The voltmeter should read 0.000 mV.
14. Press the **CHANGE** function button. The "32.0 °F" display will blink, and "NUM" will appear on the display.
15. Press **2 5 0 0 0** buttons and then press **ENTER** function button. "NUM" will disappear and "2500.0 °F" will appear, not blinking. The voltmeter should read 54.845 mV.
16. Press the **CHANGE** function button. The "2500.0 °F" display will blink, and "NUM" will appear on the display.
17. Press **3 2 0** buttons and then press the **ENTER** function button. "NUM" will disappear and "32.0 °F" will appear, not blinking. The voltmeter should read 0.000 mV.
18. Press the **SENSOR SELECT** function button. The sensor type will change to type J. The "K" will disappear from the display and a "J" will appear on the display. The voltmeter should read 0.000 mV.

19. Press the **SENSOR SELECT** function button. The sensor type will change to type T. The "J" will disappear from the display and a "T" will appear on the display. The voltmeter should read 0.000 mV.
20. Press the **SENSOR SELECT** function button. The sensor type will change to type E. The "T" will disappear from the display and an "E" will appear on the display. The voltmeter should read 0.000 mV.
21. Press the **SENSOR SELECT** function button. The sensor type will change to type N. The "E" will disappear from the display and a "N" will appear on the display. The voltmeter should read 0.000 mV.
22. Press the **SENSOR SELECT** function button. The sensor type will change to type B. The "N" will disappear from the display and a "B" will appear on the display. "LO" will also appear on the display.
23. Press the **CHANGE** function button. The "32.0 °F" display will blink, and "NUM" will appear on the display.
24. Press **1 0 0 0 0** buttons and then press **ENTER** function button. "NUM" will disappear and "1000.0 °F" will appear, not blinking. The voltmeter should read 1.438 mV.
25. Press the **SENSOR SELECT** function button. The sensor type will change to type R. The "B" will disappear from the display and a "R" will appear on the display.
26. Press the **CHANGE** function button. The "1000.0 °F" display will blink, and "NUM" will appear on the display.
27. Press **3 2 0** buttons and then press **ENTER** function button. "NUM" will disappear and "32.0 °F" will appear, not blinking. The voltmeter should read 0.000 mV.
28. Press the **SENSOR SELECT** function button. The sensor type will change to type S. The "R" will disappear from the display and a "S" will appear on the display. The voltmeter should read 0.000 mV.
29. Press the **SENSOR SELECT** function button. The sensor type will change to type G. The "R" will disappear from the display and a "g" will appear momentarily in the center of the display. "LO" will then appear in the center of the display and both the "T" and "R" will appear along the top row of the display.
30. Press the **CHANGE** function button. The "32.0 °F" display will blink, and "NUM" will appear on the display.
31. Press **6 0 0 0** buttons and then press **ENTER** function button. "NUM" will disappear and "600.0 °F" will appear, not blinking. The voltmeter should read 2.238 mV.

32. Press the **SENSOR SELECT** function button. The sensor type will change to type C. A "C" will appear momentarily in the center of the display. "600.0" will then appear in the center of the display and both the "T" and "R" will appear along the top row of the display.
33. Press the **CHANGE** function button. The "600.0 °F" display will blink, and "NUM" will appear on the display.
34. Press **3 2 0** buttons and then press **ENTER** function button. "NUM" will disappear and "32.0 °F" will appear, not blinking. The voltmeter should read 0.000 mV.
35. Press the **SENSOR SELECT** function button. The sensor type will change to type D. A "d" will appear momentarily in the center of the display. "32.0" will then appear in the center of the display and both the "T" and "R" will appear along the top row of the display. The voltmeter should read 0.000 mV.
36. Press the **SENSOR SELECT** function button. The sensor type will change to type K. The "T" and the "R" will disappear from the display and a "K" will appear on the display. The voltmeter should read 0.000 mV.
37. Press the **OFF** function button. The unit will turn off.
38. Press the **ON** function button. The unit will power up and return to the calibrator mode. "CALIB" will appear on the display along with the "K" enunciator, the "OPR" enunciator, and "32.0 °F" will be displayed. The blinking "Ω" symbol will have completely disappeared indicating that you have exited the copper mode.
39. Remove the *Copper Mode Calibrator Verification Cable* from both the *voltmeter* and the CL25.
40. The copper mode verification is now complete. Press the **OFF** function button to turn the unit off.

ALLOY MODE VERIFICATION PROCEDURE FOR THERMOCOUPLE FUNCTIONS

Equipment Required:

1. OMEGA Model to be verified.
2. Precision *temperature simulator / voltage source*.
3. *Voltmeter* accurate to 1μV resolution.
4. *Cable assembly*.

1. Start your calibration with a fresh battery.
2. Press the **ON** function button to turn the unit on.

3. Select the calibrator mode ("CALIB" on display) by pressing the **CALIB/METER** function button.
4. Select type K thermocouple ("K" on display) by pressing the **SENSOR SELECT** function button until type K is reached.
5. Select the tenth degree display with a digit appearing after the decimal point on the display) by pressing the **0.0.1** function button.
6. Select °F ("°F" on display) by pressing the **°F °C** function button.
7. Attach the *Alloy Mode Calibrator Verification Cables* per Fig. 12 & 13. If you are using a *Type K Thermocouple Temperature Simulator ITS-90* you will use the regular set up. If you are using a *Precision Voltage Source* use the alternate set up. When performing the following procedure using a *Precision Voltage Source* with the alternate set up, anywhere a temperature is transmitted (output) by the *Thermocouple Temperature Simulator*, you should adjust the *Voltage Source* to the equivalent voltage as listed by a Type K N.I.S.T. ITS-90 Thermocouple Reference Table. (Example: 32.0 °F would equal 0.000 mV)
8. Press the **CHANGE** function button and the numerical display will blink and "NUM" will appear on the display.
9. Press **3 2 0** buttons and then press the **ENTER** function button. "NUM" will disappear and "32.0 °F" will appear, not blinking.
10. Adjust the *Thermocouple Temperature Simulator* to 32.0 °F.
Note: The reading on the voltmeter should read null. 0.000 mV. Adjusting the CL25 to any temperature and adjusting the Temperature Simulator to the same temperature should result in a null, or 0.000 mV on the voltmeter.
11. Remove the *Alloy Mode Calibrator Verification Cable* from all equipment.
12. The Alloy Mode verification is now complete. Press the **OFF** function button to turn the unit off.

4. MECHANICAL PARTS DIAGRAM

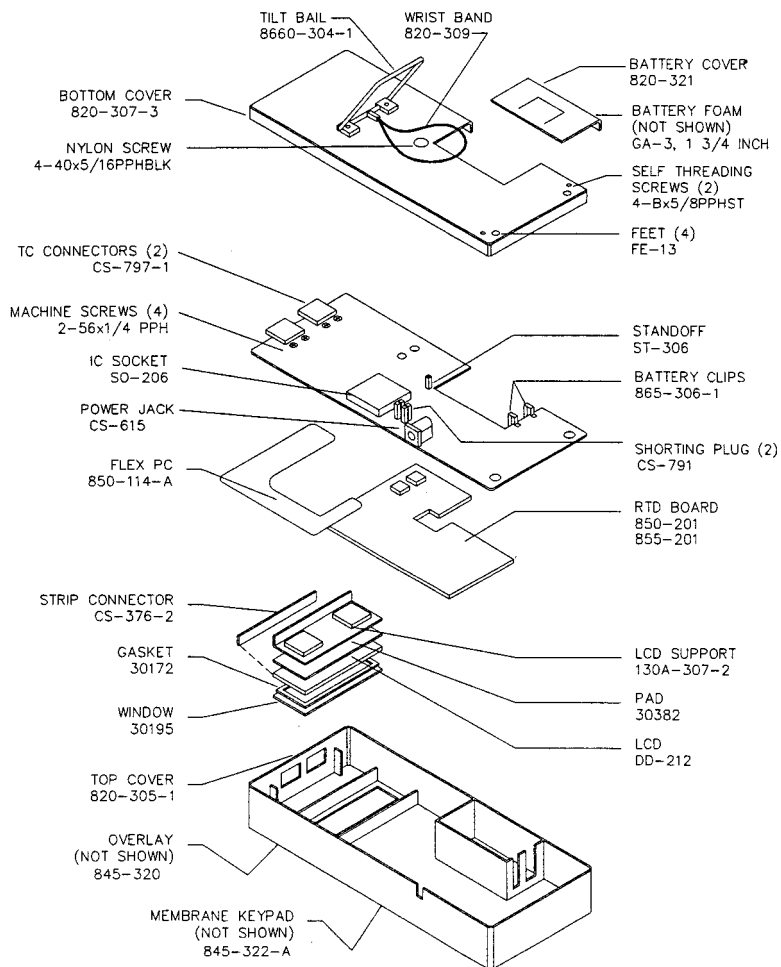

CALIBRATION PROCEDURES

Test Equipment Required:

1. Thermocouple simulator (OMEGA CL25, or equivalent).
2. Microvolt null-meter (Keithley 155, or equivalent)
3. Calibration cover (OMEGA 820-307-4).
4. Calibration cables, T.C. types K, J, T & E (as required) per Figure1 below.
5. Low-thermal (eg. copper) shorting-link for null-meter.

NOTE: The (2) alloy-copper junctions in the calibration cables can be either solder-joints (cleaned to remove flux), or crimp-connections. Insulate each junction with heat-shrink tubing, then wrap them close together in copper-foil to ensure that they maintain identical temperatures (ambient).

Ambient Conditions:

Units should be calibrated at an ambient temperature of $23^{\circ}\text{C} \pm 1^{\circ}\text{C}$, with relative humidity less than 80%. Test equipment and the unit-under-test (U.U.T.) should have 1 hour to reach thermal equilibrium with ambient-temperature.

Calibration Adjustments:

1. Remove battery from unit under test (U.U.T.). Refer to Battery Installation/Replacement instructions in the manual.
2. Remove bottom-cover from U.U.T. Refer to Disassembly Instructions.
3. Remove calibration-jumper J1 from printed-circuit board.

NOTE: When installed, J1 protects the contents of EEPROM locations where zero-offset adjustments are stored. Once J1 is removed, this data is erased when the U.U.T. is turned on.

4. Install calibration cover in place of bottom-cover.
5. Re-install battery.
6. Connect U.U.T. to test equipment per Figure 2 using the K-type calibration cable.
7. Turn on U.U.T. and allow 2-3 minutes for thermal re-stabilization of the TC mini-plug and input-jack.

NOTE: • U.U.T. will be in the Type K, °F meter-mode. The FUNC annunciator is on, indicating that new constants will be stored in EEPROM.

- With J1 removed, the digital-filters in the U.U.T. are disabled. This is to speed up U.U.T. response to calibration adjustments. In this mode $\pm 0.1^{\circ}\text{F}$ of reading noise is normal.
 - Do not deviate from the calibration adjustment sequence that follows. This will ensure that zero adjustments for each TC type will be stored in the appropriate memory locations.
8. Apply 32°F (Type K) to U.U.T. Adjust potentiometer P1 for a reading of 32.0°F (exclusive of noise).
 9. Apply 2500°F (Type K) to U.U.T. Adjust potentiometer P11 for a reading of 2500.0°F .
NOTE: Adjustment steps 8 & 9 are interactive. Repeat these steps as necessary to get the desired readings.
 10. Hit OPR key to store K-meter zero-adjustment in EEPROM. Note that "FUNC" annunciator turns off.
 11. Select Type J thermocouple (KJT key on CL23A, SENSOR SELECT key on CL24).
 12. Turn off U.U.T.
 13. Replace K calibration-cable with J calibration-cable.
 14. Turn on U.U.T. Note that "FUNC" annunciator is on again. Allow 2-3 minutes for thermal restabilization.
 15. Apply 32°F (Type J). Adjust P1 for a reading of 32.0°F (exclusive of noise).
 16. Hit OPR key to store J-meter zero-adjustment.
 17. Select Type T thermocouple.
 18. Turn off U.U.T.
 19. Replace J calibration-cable with T calibration-cable.
 20. Turn on U.U.T. Allow 2-3 minutes for thermal stabilization.
 21. Apply 32°F (Type T). Adjust P1 for a reading of 32.0°F (exclusive of noise).
 22. Hit OPR key to store T-meter zero-adjustment.
NOTE: Steps 23 thru 28 apply to Model CL24 only. For Model CL23A, go to step 29 next.

23. Select Type-E thermocouple.
24. Turn off U.U.T.
25. Replace T calibration-cable with E calibration-cable.
26. Turn on U.U.T. Allow 2-3 minutes for thermal stabilization.
27. Apply 32°F (Type E). Adjust P1 for a reading of 32.0°F (exclusive of noise).
28. Hit OPR key to store E-meter zero-adjustment.
29. Select Type-K thermocouple.
30. Select CALIB mode.
31. Turn off U.U.T.
32. Connect U.U.T. to test-equipment per Figure 3 using the K calibration-cable.
33. Turn-on U.U.T. and allow 2-3 minutes, for thermal stabilization
34. Set both the U.U.T. and TC-simulator to output 32.0°F (Type K). Adjust P2 for a null-meter reading of $0\pm 3\mu V$.
35. Set both the U.U.T. and T-simulator to output 2400°F (Type K). Adjust P41 for a null-meter reading of $0\pm 3\mu V$.
NOTE: Steps 34 and 35 are interactive. Repeat each as necessary to get the desired null readings.
36. Hit OPR key to store K-calib zero adjustment.
37. Select J thermocouple.
38. Turn off U.U.T.
39. Replace K calibration-cable with J calibration-cable.
40. Turn on U.U.T. Allow 2-3 minutes for thermal stabilization.
41. Set both the U.U.T. and TC-simulator to output 32.0°F (Type J). Adjust P1 for a null-meter reading of $0\pm 3\mu V$.
42. Hit OPR Key to store J-calib zero adjustment.
43. Select Type-T thermocouple.
44. Turn off U.U.T.
45. Replace J calibration-cable with T calibration-cable.
46. Turn on U.U.T. Allow 2-3 minutes for thermal stabilization.

47. Set both the U.U.T. and TC-simulator to output 32.0°F (Type T). Adjust P1 for a null-meter reading of $0\pm 3\mu V$.
48. Hit OPR key to store T-calib zero adjustment.
NOTE: Steps 49 thru 54 apply to Model CL24 only. For Model CL23A go next to step 55.
49. Select Type-E thermocouple.
50. Turn off U.U.T.
51. Replace T calibration-cable with E calibration-cable.
52. Turn on U.U.T. Allow 2-3 minutes for thermal stabilization.
53. Set both the U.U.T. and thermocouple-simulator to 32.0°F (Type E). Adjust P1 for a null-meter reading of $0\pm 3\mu V$.
54. Hit OPR Key to store E-calib zero adjustment
55. Turn off U.U.T.
56. Remove calibration cover. Be careful not to disturb battery connections.
57. Re-install J1 jumper.
58. Re-install original back cover. Calibration is complete.

NOTES

NOTES



WARRANTY/DISCLAIMER

OMEGA ENGINEERING, INC. warrants this unit to be free of defects in materials and workmanship for a period of **37 months** from date of purchase. OMEGA Warranty adds an additional one (1) month grace period to the normal **three (3) year product warranty** to cover handling and shipping time. This ensures that OMEGA's customers receive maximum coverage on each product.

If the unit should malfunction, it must be returned to the factory for evaluation. OMEGA's Customer Service Department will issue an Authorized Return (AR) number immediately upon phone or written request. Upon examination by OMEGA, if the unit is found to be defective it will be repaired or replaced at no charge. OMEGA's WARRANTY does not apply to defects resulting from any action of the purchaser, including but not limited to mishandling, improper interfacing, operation outside of design limits, improper repair, or unauthorized modification. This WARRANTY is VOID if the unit shows evidence of having been tampered with or shows evidence of being damaged as a result of excessive corrosion; or current, heat, moisture or vibration; improper specification; misapplication; misuse or other operating conditions outside of OMEGA's control. Components which wear are not warranted, including but not limited to contact points, fuses, and triacs.

OMEGA is pleased to offer suggestions on the use of its various products. However, OMEGA neither assumes responsibility for any omissions or errors nor assumes liability for any damages that result from the use of its products in accordance with information provided by OMEGA, either verbal or written. OMEGA warrants only that the parts manufactured by it will be as specified and free of defects. OMEGA MAKES NO OTHER WARRANTIES OR REPRESENTATIONS OF ANY KIND WHATSOEVER, EXPRESSED OR IMPLIED, EXCEPT THAT OF TITLE, AND ALL IMPLIED WARRANTIES INCLUDING ANY WARRANTY OF MERCHANTABILITY AND FITNESS FOR A PARTICULAR PURPOSE ARE HEREBY DISCLAIMED. LIMITATION OF LIABILITY: The remedies of purchaser set forth herein are exclusive and the total liability of OMEGA with respect to this order, whether based on contract, warranty, negligence, indemnification, strict liability or otherwise, shall not exceed the purchase price of the component upon which liability is based. In no event shall OMEGA be liable for consequential, incidental or special damages.

CONDITIONS: Equipment sold by OMEGA is not intended to be used, nor shall it be used: (1) as a "Basic Component" under 10 CFR 21 (NRC), used in or with any nuclear installation or activity; or (2) in medical applications or used on humans. Should any Product(s) be used in or with any nuclear installation or activity, medical application, used on humans, or misused in any way, OMEGA assumes no responsibility as set forth in our basic WARRANTY/DISCLAIMER language, and additionally, purchaser will indemnify OMEGA and hold OMEGA harmless from any liability or damage whatsoever arising out of the use of the Product(s) in such a manner.

RETURN REQUESTS / INQUIRIES

Direct all warranty and repair requests/inquiries to the OMEGA Customer Service Department. BEFORE RETURNING ANY PRODUCT(S) TO OMEGA, PURCHASER MUST OBTAIN AN AUTHORIZED RETURN (AR) NUMBER FROM OMEGA'S CUSTOMER SERVICE DEPARTMENT (IN ORDER TO AVOID PROCESSING DELAYS). The assigned AR number should then be marked on the outside of the return package and on any correspondence.

The purchaser is responsible for shipping charges, freight, insurance and proper packaging to prevent breakage in transit.

FOR **WARRANTY** RETURNS, please have the following information available BEFORE contacting OMEGA:

1. P.O. number under which the product was PURCHASED,
2. Model and serial number of the product under warranty, and
3. Repair instructions and/or specific problems relative to the product.

FOR **NON-WARRANTY** REPAIRS, consult OMEGA for current repair charges. Have the following information available BEFORE contacting OMEGA:

1. P.O. number to cover the COST of the repair,
2. Model and serial number of product, and
3. Repair instructions and/or specific problems relative to the product.

OMEGA's policy is to make running changes, not model changes, whenever an improvement is possible. This affords our customers the latest in technology and engineering.

OMEGA is a registered trademark of OMEGA ENGINEERING, INC.

© Copyright 1996 OMEGA ENGINEERING, INC. All rights reserved. This document may not be copied, photocopied, reproduced, translated, or reduced to any electronic medium or machine-readable form, in whole or in part, without prior written consent of OMEGA ENGINEERING, INC.

Where Do I Find Everything I Need for Process Measurement and Control? OMEGA...Of Course!

TEMPERATURE

- ☑ Thermocouple, RTD & Thermistor Probes, Connectors, Panels & Assemblies
- ☑ Wire: Thermocouple, RTD & Thermistor
- ☑ Calibrators & Ice Point References
- ☑ Recorders, Controllers & Process Monitors
- ☑ Infrared Pyrometers

PRESSURE, STRAIN AND FORCE

- ☑ Transducers & Strain Gauges
- ☑ Load Cells & Pressure Gauges
- ☑ Displacement Transducers
- ☑ Instrumentation & Accessories

FLOW/LEVEL

- ☑ Rotameters, Gas Mass Flowmeters & Flow Computers
- ☑ Air Velocity Indicators
- ☑ Turbine/Paddlewheel Systems
- ☑ Totalizers & Batch Controllers

pH/CONDUCTIVITY

- ☑ pH Electrodes, Testers & Accessories
- ☑ Benchtop/Laboratory Meters
- ☑ Controllers, Calibrators, Simulators & Pumps
- ☑ Industrial pH & Conductivity Equipment

DATA ACQUISITION

- ☑ Data Acquisition & Engineering Software
- ☑ Communications-Based Acquisition Systems
- ☑ Plug-in Cards for Apple, IBM & Compatibles
- ☑ Datalogging Systems
- ☑ Recorders, Printers & Plotters

HEATERS

- ☑ Heating Cable
- ☑ Cartridge & Strip Heaters
- ☑ Immersion & Band Heaters
- ☑ Flexible Heaters
- ☑ Laboratory Heaters

ENVIRONMENTAL MONITORING AND CONTROL

- ☑ Metering & Control Instrumentation
- ☑ Refractometers
- ☑ Pumps & Tubing
- ☑ Air, Soil & Water Monitors
- ☑ Industrial Water & Wastewater Treatment
- ☑ pH, Conductivity & Dissolved Oxygen Instruments

M1554/1105

Free Manuals Download Website

<http://myh66.com>

<http://usermanuals.us>

<http://www.somanuals.com>

<http://www.4manuals.cc>

<http://www.manual-lib.com>

<http://www.404manual.com>

<http://www.luxmanual.com>

<http://aubethermostatmanual.com>

Golf course search by state

<http://golfingnear.com>

Email search by domain

<http://emailbydomain.com>

Auto manuals search

<http://auto.somanuals.com>

TV manuals search

<http://tv.somanuals.com>