

Table of Contents

Introduction	iii
• Terms used in this Manual	iii
• Product Symbols	iii
Operator Safety Information	iv
1.0 UNPACKING	1
2.0 FEATURES	2
2.1 OM-550 FEATURES	2
2.1.1 ACTIVITY LED & HORN	3
2.1.2 KEYPAD	4
• ON-OFF	5
• RUN	6
• STOP	7
• PROG/EXIT	7
• OK	7
2.1.3 CHANNEL CONNECTORS	8
2.1.4 PRINTER WINDOW	9
2.1.5 THERMAL PAPER	10
2.1.6 BATTERY COVER	10
2.1.7 DC JACK	10
2.1.8 SERIAL DATA PORT	10
2.1.9 GAIN ADJUST	11
2.1.10 TILT STAND	11
2.2 POWER SUPPLIES	12
2.3 INPUTS	13
2.3.1 VOLTAGE (TRANSDUCER) INPUTS	13
2.3.2 PROBES	13
2.3.3 THERMOCOUPLE INPUTS	14
2.4 PROGRAMMED FEATURES	15
2.4.1 DATA CACHE	15
2.4.2 STATISTICS	16
2.4.3 POWER-SAVE MODE	17
2.4.4 LOW BATTERY OPERATION	17
2.4.5 BATTERY CHECK	17

3.0 SET-UP	18
3.1 POWER CONNECTION	18
3.1.1 BATTERY INSTALLATION	18
3.1.2 CONNECTING THE AC POWER ADAPTER	19
3.1.3 CONNECTING THE DC POWER CABLE	19
3.2 PAPER INSTALLATION	20
3.3 DATA PORT CONNECTION	21
4.0 PROGRAMMING.....	22
4.1 PROGRAMMING KEYS	23
4.2 PRINT FORMATTING.....	24
4.3 TEMPERATURE CHANNELS	25
4.4 VOLTAGE CHANNELS.....	25
4.5 MATH PSEUDO-CHANNEL	26
4.6 LOG INTERVAL	27
4.7 OPERATION AT FULL CACHE (RECORDING TIME)	28
4.8 DATE	29
4.9 TIME	29
4.10 TEMPERATURE UNITS	29
4.11 REJECTION FREQUENCY	29
4.12 CALIBRATION MODE	30
4.13 TADJUST	31
4.14 VOLTAGE INPUT SCALING.....	32
4.14.1 MATCHING TRANSDUCERS TO THE OM-550.....	32
4.14.2 MATCHING A VOLTAGE TRANSDUCER	32
4.14.3 MATCHING A CURRENT TRANSDUCER	33
4.14.4 DATA SCALING (mX + b calculation)	34
4.14.5 MATCHING AND SCALING A VOLTAGE TRANSDUCER	35
4.14.6 MATCHING AND SCALING A CURRENT TRANSDUCER	37
4.15 UNIT LABELS	39
5.0 OPERATION	40
APPENDIX A: CALIBRATION	45
• MANUAL RESET	45
• PERFORMING A MANUAL RESET	45
• CALIBRATION PROCEDURE	46
• VOLTAGE ADJUSTMENT PROCEDURE:	47
• THERMOCOUPLE ADJUSTMENT PROCEDURE:.....	47
• EXITING CAL MODE.....	48
APPENDIX B: SPECIFICATIONS.....	49



Introduction

This **User's Guide** explains how to use OM-550.

This manual is written for users of varied experience. If a section covers information you already know, feel free to skip to the next section.







• Terms used in this Manual

In this manual, the following definitions are used for special terms and symbols.

-  **Warns the user that the note identifies conditions or practices that could result in personal injury or damage to property other than the equipment.**
-  **Warns the user that the note identifies conditions or practices that could result in damage to the equipment.**
-  **Warns the user that the note includes important information.**
- **Thermocouple** may be referred to as **T/C**.
- **The OM-550 Datalogger** may be referred to as **“Logger”**.

• Product Symbols

The following symbols may be present on the Product:

-  Direct Current (DC) Power
-  Alternating Current (AC) Power
-  **CAUTION:** Whenever this internationally recognized symbol is used on the product, additional information concerning that particular feature or function appears in the manual.
-  Battery Charger protected throughout by double or reinforced insulation.
-  Indoor use only. For electric-shock protection, always operate the battery charger in a protected, indoor location.
-  Input power connector
-  Thermocouple connection

Operator Safety Information

The safety information in this summary is for the benefit of operating personnel. Warnings and Cautions will also be found throughout the manual where they apply.



PRODUCT USAGE WARNINGS:

For fire and electric shock protection, DO NOT connect the input channels to objects at elevated electrical potential. The common terminal of each measurement input channel is not isolated from the common terminal of the 9V DC input power connector and the RS-232 serial data port while that channel is being measured.



This interconnected common circuitry is not connected to ground or to the enclosure of the OM-550. If the OM-550 is interconnected to a desktop computer, its internal circuitry very likely could be connected to ground through the serial data port of the computer. The enclosure and the measurement circuitry provide functional isolation of the measurement and data circuitry sufficient to allow for small electrical noise-related potentials to occur. This functional isolation is not intended for electrical safety isolation. Therefore for electric-shock protection and to prevent fire and damage to data interconnect wiring due to high currents, the input channels must not be connected to objects at elevated electrical potential.

- Do not operate the OM-550 in flammable or explosive atmospheres. Such usage constitutes a fire or explosion risk.
- For electric-shock protection, only operate the AC power adapter indoor location.
- For continued fire and electric shock protection, use only the specified power adapter.
- For continued fire protection, use only the specified optional DC power cable, which incorporates a two-ampere fuse.



A two-ampere fuse is incorporated in the cigarette lighter plug which is part of the DC power cable. This fuse provides overcurrent protection should a short or overload circuit occur in the OM-550 or the DC power cable.



For protection of the OM-550 itself, observe the following:

- **Do not immerse the OM-550 in liquids.**
- **Do not subject the OM-550 to sharp impacts or drops.**
- **Do not expose the OM-550 to corrosive environments.**
- **Extended exposure to temperatures below the specified minimum may damage the battery (optional external rechargeable battery pack only).**
- **Extended exposure to temperatures above the specified maximum may damage the OM-550 itself or its optional external rechargeable battery pack.**
- **Do not excessively stress the power input, the RS-232 serial data, and the accessory port connections.**



The warranty will not cover damage caused by neglect or abuse of this product. To maintain the safety features incorporated in this product, operation must be in strict compliance with the requirements specified herein.

1.0 UNPACKING

Unpack the unit carefully. Be sure to check for options and accessories that may have been packed separately. Retain the shipping carton for reshipment (for recalibration or any other purpose).

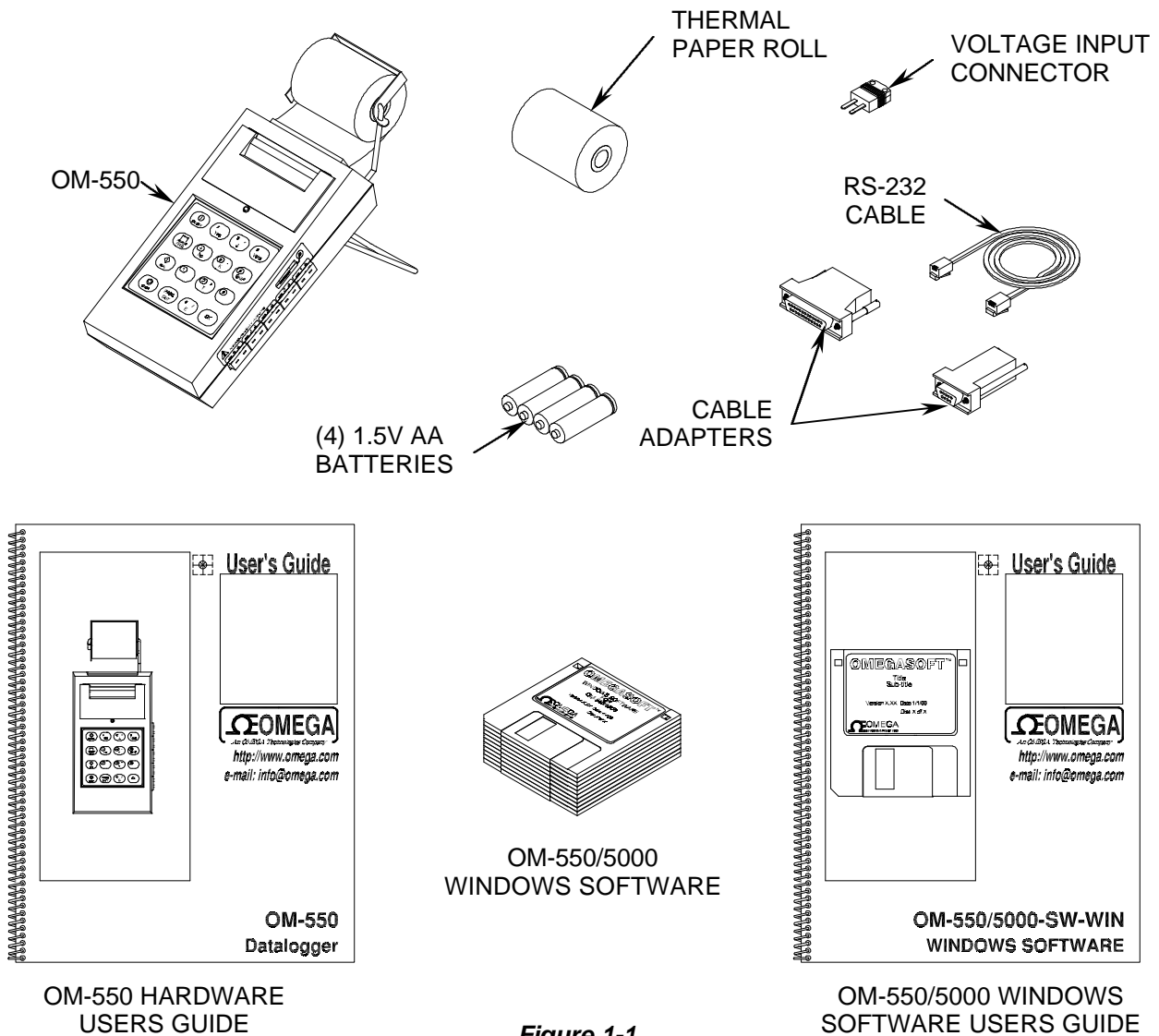

Figure 1-1

2.0 FEATURES

This section explains the Features for the OM-550 System and optional items.

2.1 OM-550 FEATURES

OM-550 features:

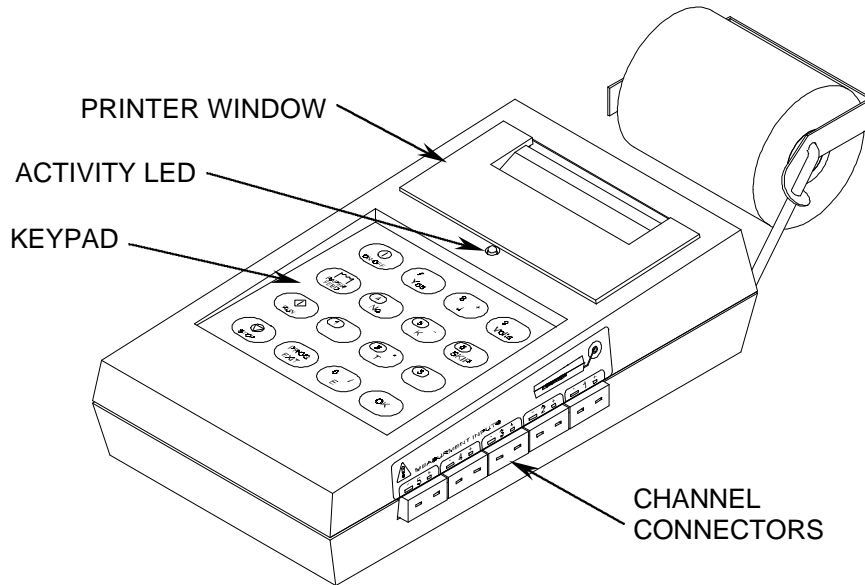

Figure 2-1

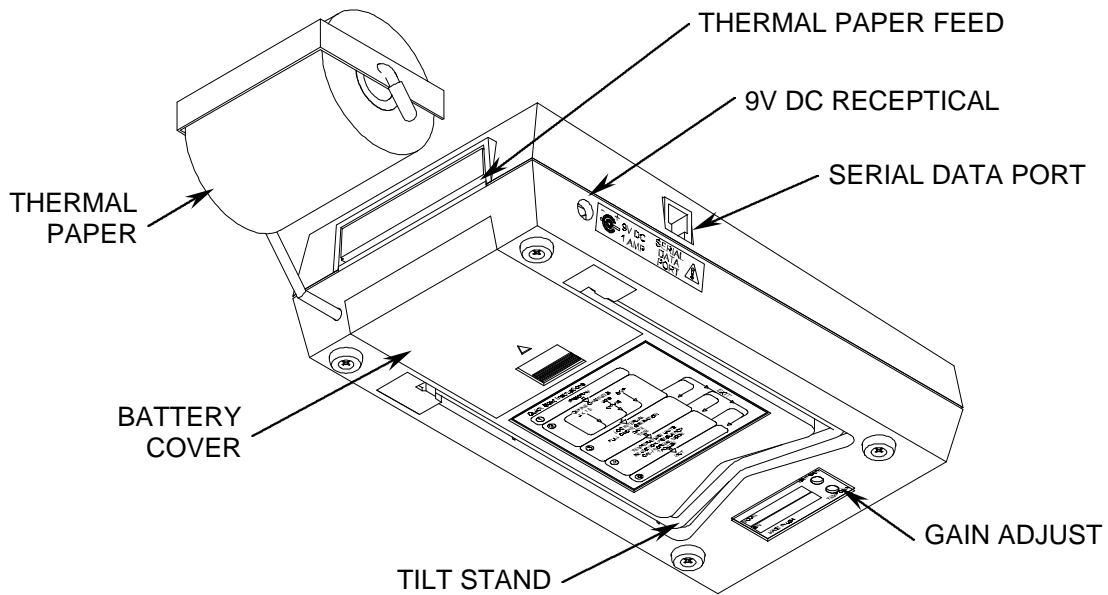

Figure 2-2

2.1.1 ACTIVITY LED & HORN

The Activity LED and internal horn provide a quick indication of the unit's status. For example a short, periodic **beep** and **flash** indicates that the OM-550 is "ON" but not being programmed.

The horn produces two different sounds, a **beep** and **blat**. Valid key closures produce the **beep** sound and invalid keys produce the **blat**. For example, the **OK** key is only used in programming. Pressing the **OK** key when not programming will produce a **blat** sound.

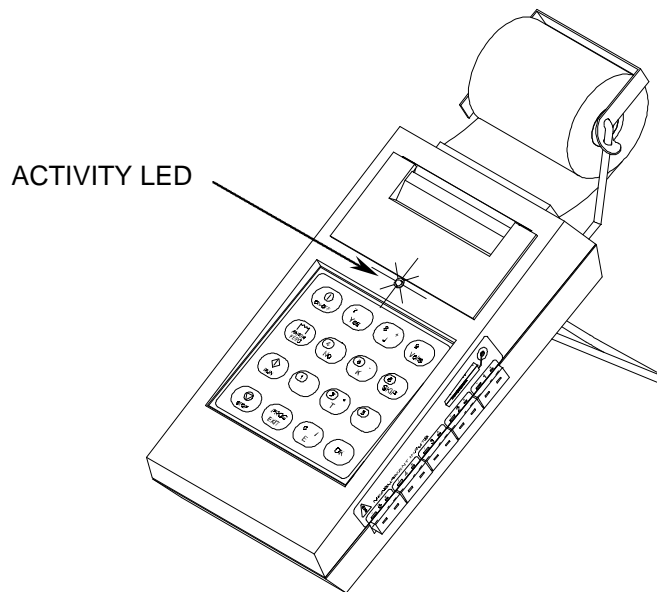

Figure 2-3

- A periodic **beep-beep** and **flash-flash** indicates that the OM-550 is being programmed.
- Key closures override this regular activity with a steady **beep** (or **blat**) whenever a key is pressed.
- If no activity is evident (**beeps** and **flashes**, or printing), the unit is "OFF".



Menus are printed when a choice is available. Then, when the operator presses a key the resulting Selection is printed to confirm the action. In most cases, the user need not wait for a menu to print before making a selection. Experienced operators can operate the unit very swiftly, with little printing. If the unit *blats*, just wait for the menu to print, then continue by pressing the correct key(s).

2.1.2 KEYPAD

The Keypad has more than one function and many are self-evident, so only the main key functions are discussed here.

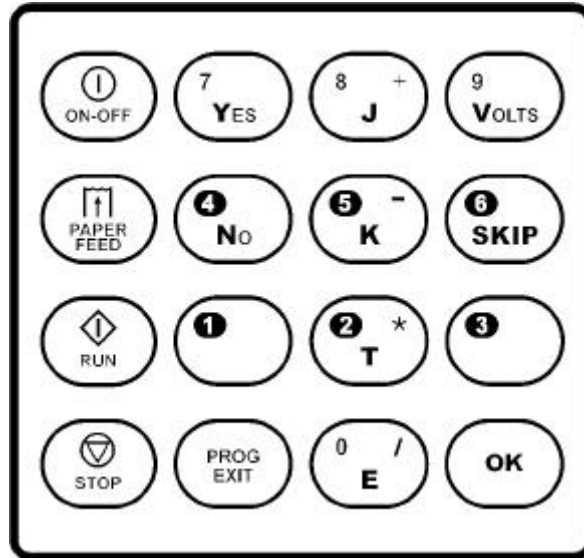

Figure 2-4

The **ON-OFF** and **PROG/EXIT** keys are toggles. They are often discussed here by separate function to avoid confusion.

For example, the **ON** key and the **OFF** key are the same key but its function changes (toggles) between “ON” and “OFF”. All keys but the **ON** key are disabled when the unit is “OFF”.



• ON-OFF

The **ON-OFF** key activates the OM-550. If the unit is “OFF”, pressing the **ON** key will activate it, light the Activity LED and **beep** the horn. When the key is released, the unit will print the key name, time, date, and a command menu:

KEY NAME →

```
***** ON *****
00:00:00 01/01/00
MENU { RUN  starts logging
      STOP stops logging
      PROG starts programming
```

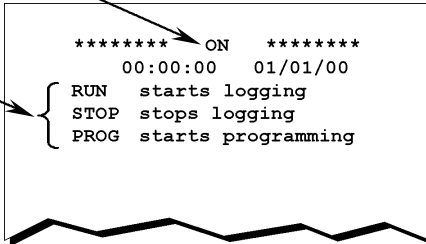

Figure 2-5

If the OM-550 is “ON”, pressing the **OFF** key will cause it to print:

```
***** OFF *****
```

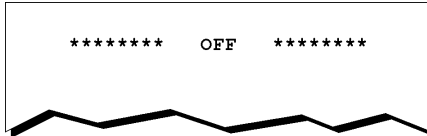

Figure 2-6

... then deactivate. It will remain “OFF” until the **ON** key is pressed.

The OM-550 can turn itself “OFF” (power save mode) when logging at long intervals, to conserve power (refer to section 2.4.3 *POWER-SAVE MODE* for more information). If the unit is powered down, pressing the **ON** key will activate the unit but only the key name will print, with the following message:

```
**** ON (RUNNING) ***
```

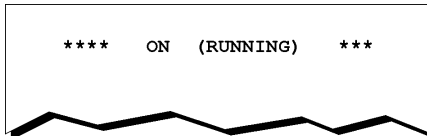

Figure 2-7



• RUN

The **RUN** key activates the OM-550 to begin logging. The data is stored in internal memory, optionally printed, and can be transferred to a PC at a later time. When the **RUN** key is pressed, the messages shown in Figure 2-8 are displayed.

```
*****  RUN  *****
Log Interval=00:10:00
Stop in 0001:05:10:00
Print data? (Yes/No)
```

Figure 2-8

This printout shows the pressed key (**RUN**), and how often the inputs will be sampled as HH:MM:SS (hours, minutes, seconds), shows the time required to fill the data cache as DDDD:HH:MM:SS (days, hours, minutes, seconds), indicates that the unit is programmed to automatically stop when the cache is full, and asks if the data should be printed during logging (refer to section 4.7 *OPERATION AT FULL CACHE (RECORDING TIME)*).

Pressing the **YES** key will activate the OM-550 to begin collecting data for all active channels (those not programmed as **SKIP**). The inputs will be sampled at the preset log interval and the data will be printed and saved to the cache. If the log interval is greater than 1 minute, the unit will turn "OFF" (Power save mode) between scans to save battery power.

If the **NO** key is pressed, data will still be collected and saved to the data cache, but not printed. This will save power and paper allowing the unit to log at shorter log interval settings. Only the statistics will print when the **STOP** key is pressed. The data can, of course, be printed after it is transferred to a PC.



• STOP

Once logging is started, it will continue until the **STOP** key is pressed, the unit is deliberately turned “OFF”, or the batteries are exhausted. The OM-550 can also be programmed to automatically stop logging when the data cache is full.

To stop logging, first ensure that the unit is “awake”, then press the **STOP** key. (If the unit is in Power save mode, press **ON** and then the **STOP** key instead.) The unit will complete the current scan but logging is now disabled and the Statistics will be printed.



• PROG/EXIT

This key toggles the OM-550 in and out of the Program mode.

Pressing the **PROG** key enters the Program mode and will erase the data cache and print a complete description of its current programming. The Activity LED double-blinks and the horn double-beeps to signal that the unit is in Program mode. Refer to section 4.0 *PROGRAMMING* for more information.

Pressing the **EXIT** key accepts all existing programming and returns the unit to a ready state. Incomplete keyboard entries (part of a new date, for example) are rejected and the Activity LED and horn return to a single beep/blink.



• OK

The **OK** key is used only during programming. Use it to accept the current item, as is without changing. This function skips quickly down through the programming menu to reach a particular item to be reprogrammed. All accepted items are printed, as confirmation. Refer to section 4.0 *PROGRAMMING* for more information.

2.1.3 CHANNEL CONNECTORS

The five input connectors on the right side of the OM-550 accept either voltage or thermocouple inputs values.

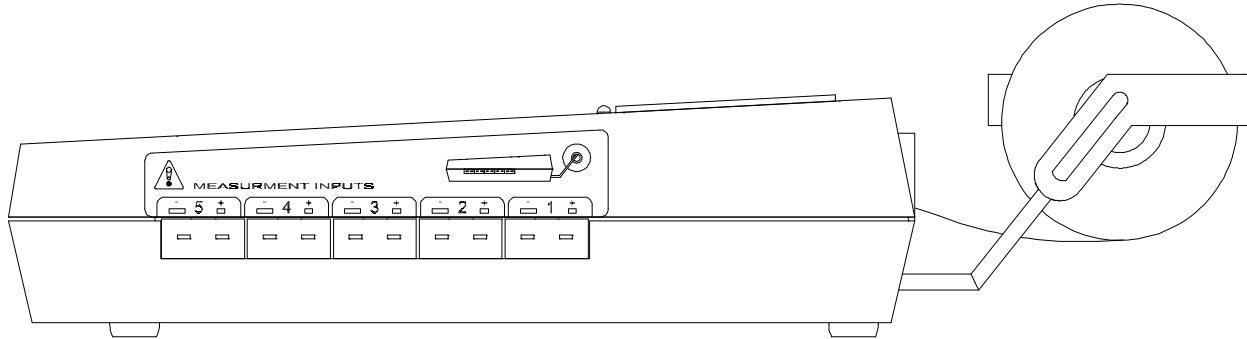

Figure 2-9

The mating connectors are color coded by conductor material, as described in the table below. For best accuracy, use the appropriate color of connector.

<u>CONNECTOR COLOR</u>	<u>APPLICATION</u>	
White	Uncompensated	Voltage inputs
Black	Type J	thermocouples
Yellow	Type K	thermocouples
Blue	Type T	thermocouples
Purple	Type E	thermocouples
Orange	Type N	thermocouples

• Optional Connectors:

White	Type B	thermocouples
Green	Type S or R	thermocouples



To minimize danger to personnel, and to avoid ground loops which could affect measurement accuracy, always disconnect the RS-232 cable before attaching the input signals.

2.1.4 PRINTER WINDOW

The OM-550 has a protective viewing window that can be removed to clear paper jams, or to allow closer inspection of the print head & paper path.

To remove the Viewing Window:

1. Lift under the bottom edge to a 45-degree angle, then pull it away from the case, as shown in Figure 2-10:

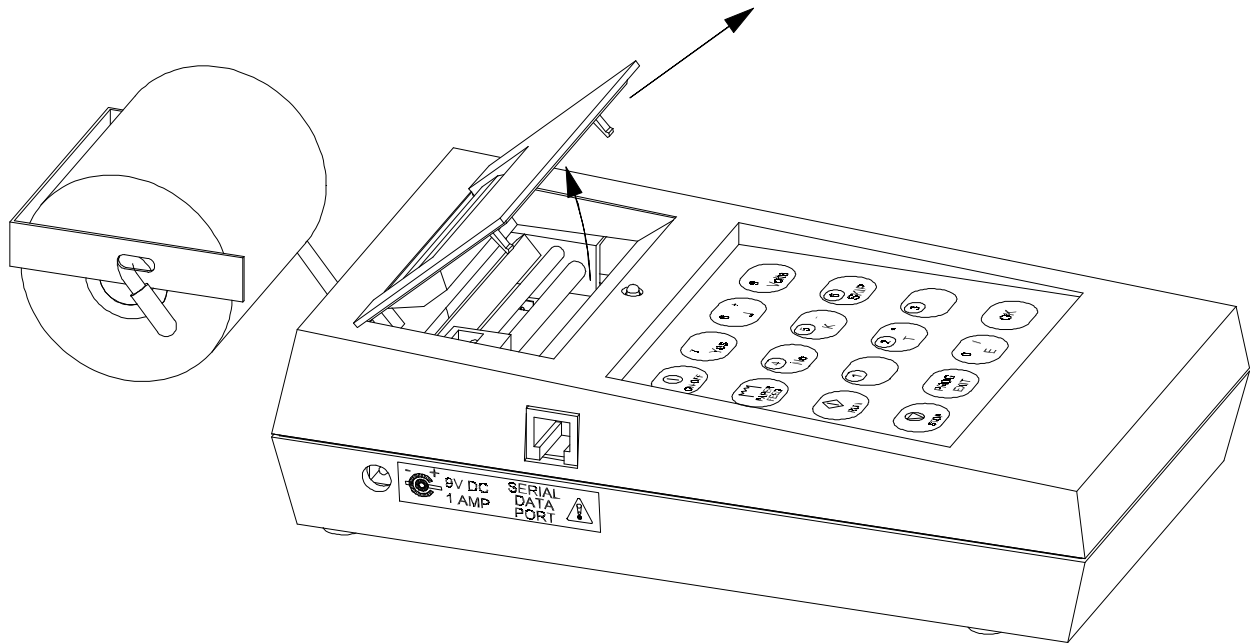

Figure 2-10

2. Replace the window by reversing the removal sequence making sure the tabs click into place.



The window material is very durable but may be scratched by abrasives. For best service, clean it regularly with mild soap and a soft cloth. Avoid solvents and harsh abrasives that might scratch the viewing area or interfere with the mechanical operation of the printer head.

2.1.5 THERMAL PAPER

Two thermal paper rolls are supplied for printing logged and programming data. The paper is placed on the paper bail with the active side of the paper-inserted face down into the rear paper feed slot. Refer to section 3.2 *PAPER INSTALLATION* for more information.

2.1.6 BATTERY COVER

Four AA Batteries are supplied in the kit that must be installed prior to operation. The Battery cover is located on the bottom side of the OM-550. To remove it simply slide it toward the thermal paper roll (refer to section 3.1.1 *BATTERY INSTALLATION* for more information).

2.1.7 DC JACK

Omega offers an optional AC Power Adapter and a DC Power Cable designed to extend battery life. Both of these items are inserted into the DC Jack and then to the proper power source (refer to section 3.1.2 *CONNECTING THE AC POWER ADAPTER* and 3.1.3 *CONNECTING THE DC POWER CABLE* for more information).

2.1.8 SERIAL DATA PORT

The RS-232 Port transfers the logged data to a PC. The port uses a telephone-style 4P4C connector, shown in Figure 2-11:

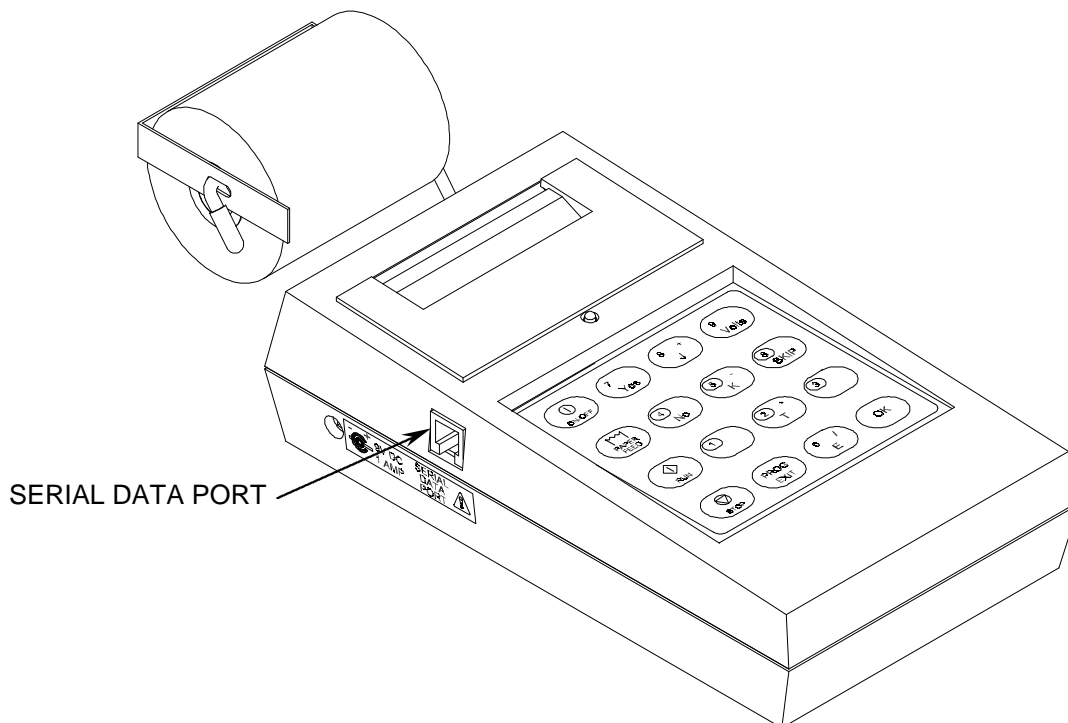

Figure 2-11

2.1.9 GAIN ADJUST

The Gain Adjust holes are used when performing a Voltage or Temperature calibration procedure. There are two holes located on the bottom of the OM-550 one for adjusting the Volt Gain and another for adjusting the Temp Gain (see *APPENDIX A: CALIBRATION* for more information).

2.1.10 TILT STAND

The Tilt Stand allows the user to get a better view of the Keypad and printed data. Tilt the OM-550 up by rotating the stand downward until it comes to a complete stop and then set the OM-550 on a table or flat surface.

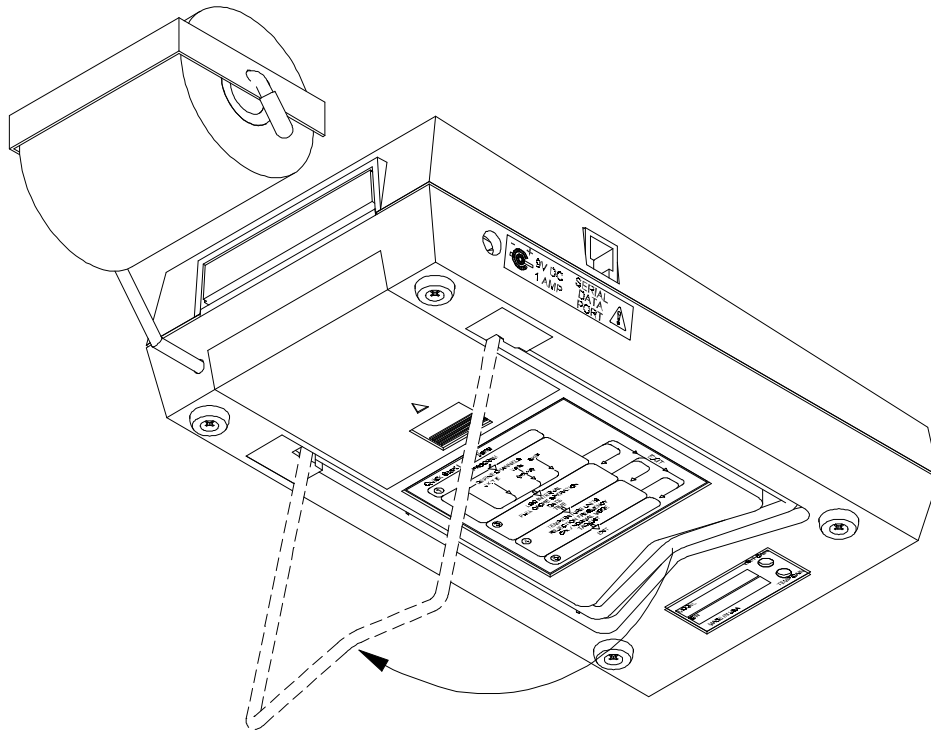

Figure 2-12

2.2 POWER SUPPLIES

As previously discussed the OM-550 operates from four AA internal batteries, AC power adapter, DC power cable or an external rechargeable battery pack. Prior to use, always ensure that external power supplies are operating properly before connecting them to the OM-550.

- The AC Power Adapter plugs into an appropriate 120V AC (in North America) power outlet and then the DC power plug is inserted into the DC Jack on the left side of the unit.



The AC Power Adapter does not charge the internal batteries. Use only alkaline, size AA batteries. Do not use rechargeable Ni-cad cells.

- The DC power cord connects to a 12V DC automobile cigarette lighter and then the DC power plug is inserted into the DC Jack.
- The External, 12V DC, Rechargeable battery pack is connected to the OM-550 by connecting the DC power cord to the battery pack and the DC power plug to the DC Jack on the left side of the OM-550. Polarity of the connection does not matter.



Install the internal batteries as a back-up source of power to avoid loss of data when using the AC Power Adapter (or the external battery pack).

2.3 INPUTS

As previously discussed, the OM-550 accepts either voltage or thermocouple inputs. The Signals discussed in this section are input through one of the channel connectors on the right side of the OM-550.

2.3.1 VOLTAGE (TRANSDUCER) INPUTS

The Voltage connector used for inputs is a white connector with copper pins.

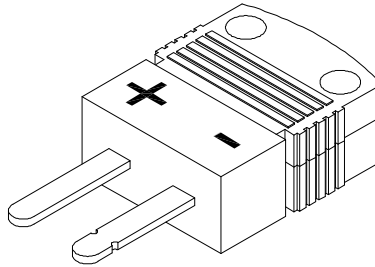

Figure 2-13

2.3.2 PROBES

Optional Voltage and Current probe sets are available for the OM-550. They provide a convenient way to connect the OM-550 to voltage or current signals:

<u>PROBE SET</u>	<u>APPLICATION</u>
±2 VDC VOLTAGE	connects to signals in the ±2 VDC range
±10 VDC VOLTAGE	connects to signals in the ±10 VDC range
4-20 mA CURRENT	converts 4-20 mA loop currents to ±2 VDC signals

For convenience, the OM-550 can be programmed to Scale data. The following table includes **m** (slope), **b** (offset) and **dp** (decimal point) settings for common probe applications:

PROBE	INPUT RANGE	m	b	dp	PRINT RANGE	UNITS
±2 V	±2 VDC	+1.00000	+000000	4	-2.0000 to +2.0000	V*
±10 V	±10 VDC	+0.50000	+000000	3	-10.000 to +10.000	V
	0-10 VDC	+0.50000	+000000	3	00.000 to +10.000	V
	0-5 VDC	+0.50000	+000000	3	00.000 to +05.000	V
	1-5 VDC	+0.50000	+000000	3	+01.000 to +05.000	V
4-20 mA	4-20 mA	+1.00000	+000000	3	+04.000 to +20.000	mA**

* Default label for VOLTAGE channels ** Example only; many UNIT labels are available.

Refer to sections 4.15 UNIT LABELS and 4.14 VOLTAGE INPUT SCALING for more information.

2.3.3 THERMOCOUPLE INPUTS

Use a connector of the appropriate color, by thermocouple (T/C) type, as explained previously. Determine the polarity by the thermocouple type and insulation color:

<u>T/C TYPE</u>	<u>POSITIVE LEAD</u>	<u>NEGATIVE LEAD</u>
J	white	red
K	yellow	red
T	blue	red
E	violet	red

Attach the thermocouple to the connector as shown below:

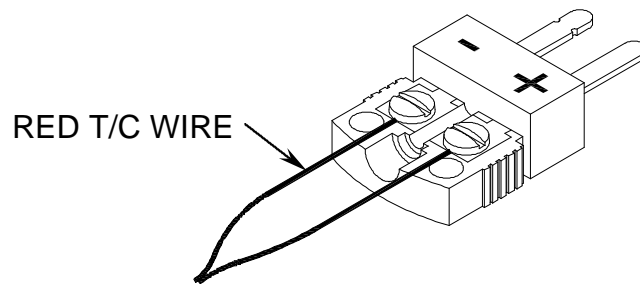

Figure 2-14

2.4 PROGRAMMED FEATURES

There are special programmed features that support the operation of the OM-550. These features are described in the following sections.

2.4.1 DATA CACHE

The OM-550 contains a 28 Kbyte data cache that retains its data even when the unit is "OFF". Each data point occupies four bytes of cache memory; thus the capacity of the cache depends upon the quantity of active (unskipped) channels.

<u>ACTIVE CHANNELS</u>	<u>CACHE CAPACITY</u>
1	7000 scans
2	3500 scans
3	2333 scans
4	1750 scans
5	1400 scans



When the RUN or PROG keys are pressed, the cache is automatically erased. Do not press RUN or PROG until the data has been transferred to a PC, otherwise it will be lost.

During a Manual Reset, 100 "phony" data readings will automatically be logged to the cache, as CH 1 & CH 2 data. The statistics for this artificial data can be viewed by pressing the **STOP** key after executing a Manual Reset, explained in *APPENDIX A: CALIBRATION*.

The artificial data is a functional test of the unit and can also be used to ensure that the RS-232 port connection to a PC is functioning properly. When the data is transferred to a PC, it will graph as a straight line with constant, increasing slope.



The Math channel data is not saved to cache. It is calculated and "transferred" to the PC during upload (refer to section 4.5 MATH PSEUDO-CHANNEL for more information).

2.4.2 STATISTICS

When the **STOP** key pressed after a data run, the Statistics are then printed. This printout shows the date, time, number of samples taken (N), and the minimum, average, and maximum values (by channel) of the data presently stored in the cache:

```
***** STOP *****
01:09:21 01/01/00
Run statistics N=00004
      Min   Avg   Max
1 -025.87 064.62 090.49
2 -***** 050.23 025.32
```

Figure 2-15

If "*****" appears on the tape, as shown in Figure 2-15, the value stored in cache memory is not printable.

If the selected Log Interval was shorter than the time required to log (or log and print) the data, the Statistics will include a warning (refer to section 4.6 *LOG INTERVAL* for more information).

LOG INTERVAL WARNING →

```
***** STOP *****
01:09:21 01/01/00
Log Interval exceeded!
Run statistics N=00004
      Min   Avg   Max
1 -025.87 064.62 090.49
```

Figure 2-16

If no samples were taken, no data has been written to the cache. In this case, N=0 and there will be no statistics to print.

2.4.3 POWER-SAVE MODE

When logging data, the OM-550 prolongs its battery life by automatically turning “OFF” (power-save mode) when unattended (no key closures detected for about 1 minute). If the OM-550 is in RUN mode it will wake and log data at the next appropriate time.



When the OM-550 is in the Programming and CAL modes it remains “ON”; and must be turned “OFF” manually.

2.4.4 LOW BATTERY OPERATION

The OM-550 continually checks the battery voltage and automatically turns “OFF” when the batteries are exhausted. Printing will then be inhibited (because the required power is not available) but the time, date, and cached data are retained.

If the batteries are exhausted while logging, the OM-550 will automatically stop, then turn “OFF”. Printing time is will also be prohibited and data will be retained.

To retrieve the data, connect the AC Power Adapter or the collected data will be lost if the batteries are removed. Connect the OM-550 to a PC and turn it “ON”. Now transfer the data as usual.

If the batteries become completely exhausted or removed the cached data is lost but all programming except the time and date is retained.

2.4.5 BATTERY CHECK

To check the battery voltage, disconnect the AC Power Adapter and press the **VOLTS** key while the units is “ON” but not running (logging data).

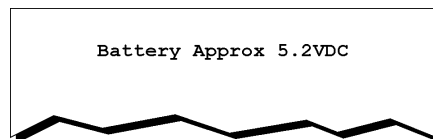

Figure 2-17

Fresh batteries typically read from 5.9V to 6.4V. Consider replacing the batteries when the readings fall below 5.0V. Readings near 4.5V show that the batteries are nearly exhausted.

3.0 SET-UP

This section provides the necessary information to set the OM-550 up for proper operation.

3.1 POWER CONNECTION

As previously discussed there are several options to supply power to the OM-550 and the following sections explain how to use them.

3.1.1 BATTERY INSTALLATION

Slide the battery cover open and insert the batteries as shown below. Replace the cover and turn the unit "ON" by pressing the **ON-OFF** key. The OM-550 will then activate and initiate printer activity. If the OM-550 does not respond, ensure that the batteries are properly positioned.



When the batteries have been removed from the OM-550 for an extended period, the unit may activate (printer activity may begin) immediately upon insertion of the batteries, without pressing the ON-OFF key.

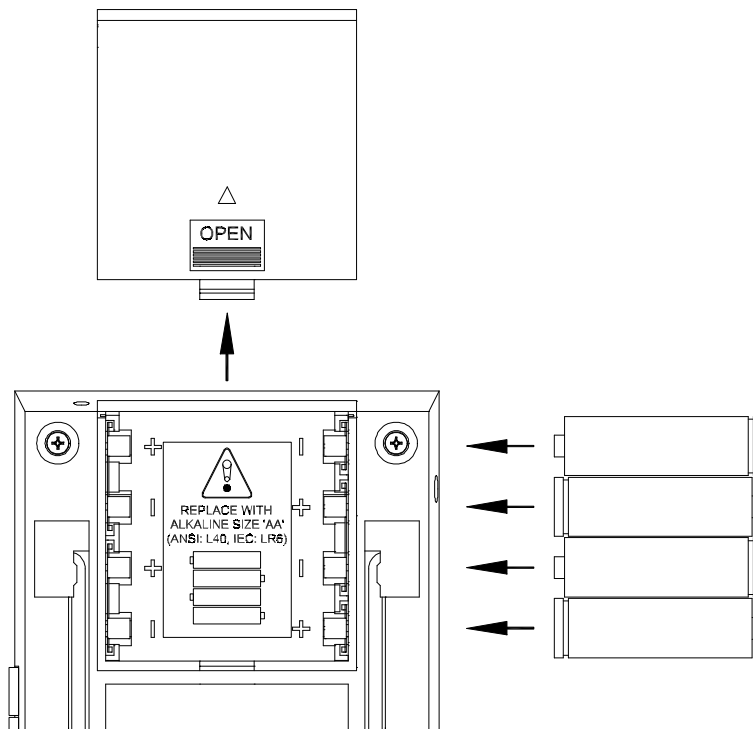

Figure 3-1

3.1.2 CONNECTING THE AC POWER ADAPTER

Plug the AC Power Adapter into an appropriate 120V AC (in North America) power outlet. Insert the adapter's connector into the receptacle on the left side of the unit. The OM-550 is now ready to operate on external power.

The OM-550 will operate without batteries but data may be lost if the power fails or the AC Power Adapter is accidentally removed.



It is recommended when operating OM-550 the batteries are installed first.

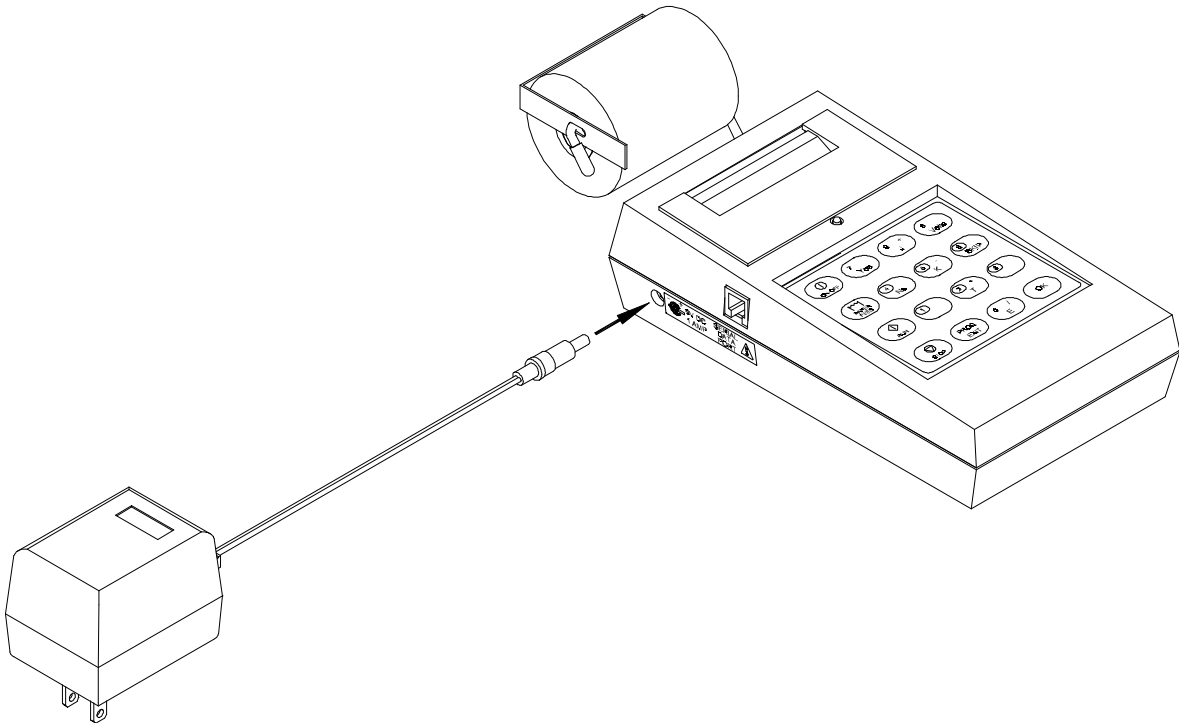

Figure 2-18



For continued fire and electric-shock protection, use only the specified AC Power Adapter.

3.1.3 CONNECTING THE DC POWER CABLE

Plug the large DC connector into a 12V DC cigarette lighter power outlet, whether in the optional rechargeable battery pack or in a motor vehicle. Plug the small DC plug into the jack on the left side of the OM-550.



For continued fire protection, use only the specified DC power cable which contains a two-ampere fuse.

3.2 PAPER INSTALLATION

1. Unwind several inches of paper from the paper roll.
2. Fold the end of the thermal paper over creating a straight flat edge as shown in Figure 3-2. This creates a strong edge and allows the paper properly center in the printer when inserting it into the rear paper slot.



Paper orientation is very important because only one side is coated for thermal printing.

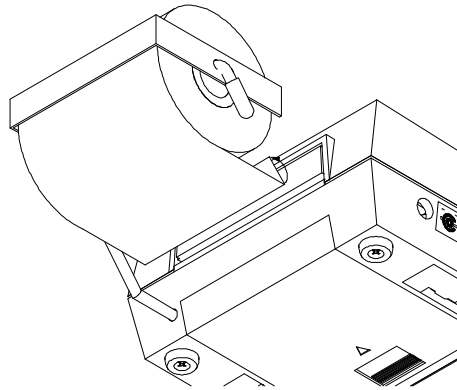

Figure 3-2

3. Insert the paper into the rear paper slot as shown in Figure 3-2. Turn the OM-550 “ON”, then press and hold the “**PAPER FEED**” key to feed the paper through the printer.

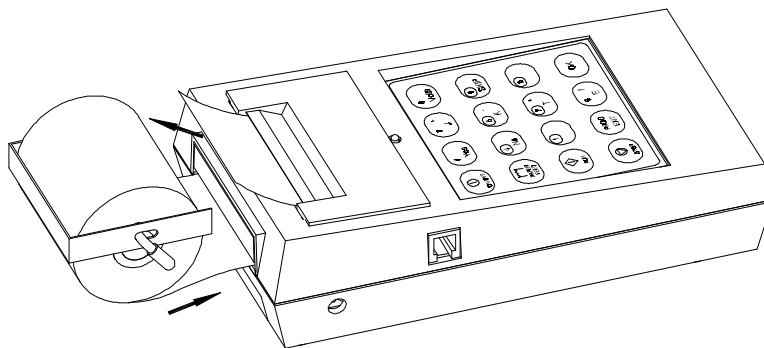

Figure 3-3

4. After the paper appears in the front window, pull several inches through.
5. Test the operation of the printer & paper-feed mechanism by turning the unit “OFF” and back “ON”. When finished examine the printed messages for clarity.

3.3 DATA PORT CONNECTION

Prior to transferring data, the OM-550 must be connected to a PC with the RS-232 cable assembly supplied with the kit. The cable assembly includes a telephone-style cable and two adapters. The OM-550 for Windows software supplied with the kit is used to transfer data through the OM-550 RS-232 Port to a PC for analysis and storage.

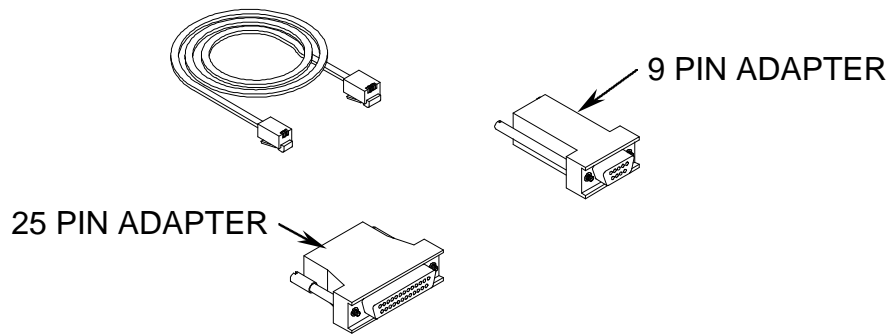

Figure 3-4

The cable is fitted with a 4P4C connector for the Data Port on the OM-550 and a 6P4C connector for an adapter. The adapters convert 6P4C connectors to 9-pin (or 25-pin) PC serial-port connectors (DB9 or DB25, female).

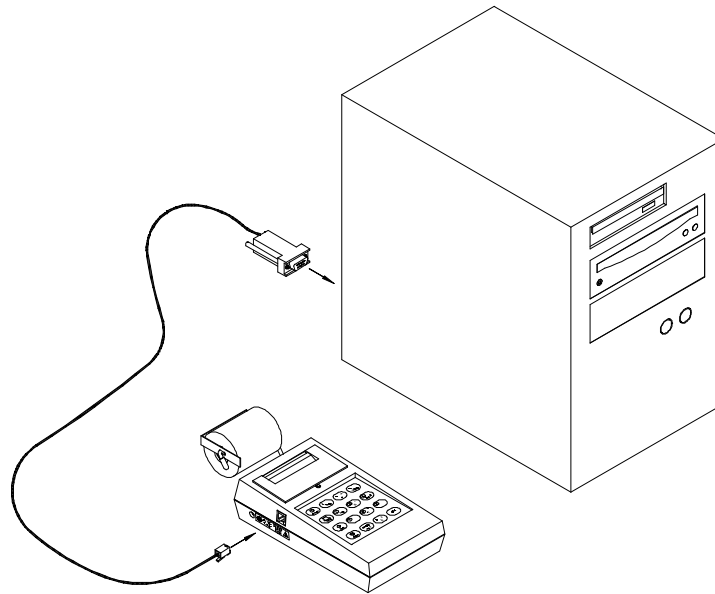

Figure 3-5



To minimize danger to personnel, and to avoid ground loops which could affect measurement accuracy, never connect the OM-550 to a PC and to the signal inputs simultaneously!

4.0 PROGRAMMING

When prior to operating the OM-550 it must first be programmed. This section covers all of the programming options available. All programmed settings but the time & date are stored in EEPROM and retained even if the batteries are removed.

• Programming outline:

1. Select Channel (1-6)
 - If Channel (1-5)
 - Set Channel Type (J,K,T,E,V,Skip)
 - If Channel Type (J,K,T, Or E)
(Return To Select Channel)
 - If Channel V (Voltage) Set Mx And B
 - Set Engineering Units
 - Set Decimal Position
(Return To Select Channel)
 - If Channel Type Skip
(Return To Select Channel)
 - If Channel 6 (Math)
 - If Channel Type Skip
(Return To Select Channel)
 - If Not Channel Type Skip
 - Set Math Function (+ , - , / , X)
 - Select First Operand Channel
 - Select Second Operand Channel
 - Set Engineering Units
 - Set Decimal Fix Position
(Return To Select Channel)
2. Set Log Interval
3. Select Activity at Full Cache
4. Set Date
5. Set Time
6. Select Temperature Units (F/C)
7. Select 60/50 Hz A/D Reject
8. Select Calibration Mode
 - If Normal Mode Selected
 - Set Tadjust
 - Programming Done
 - If Calibration Mode Selected
 - Programming Done

When operating the OM-550 and you are unsure of the programmed settings, a Manual Reset can be performed to force it to a standard configuration (refer to section *APPENDIX A: CALIBRATION* for more information).



4.1 PROGRAMMING KEYS

Pressing the **PROG** key activates the Program mode. The unit immediately prints the current programming information and prompts the user to select a channel to reprogram:

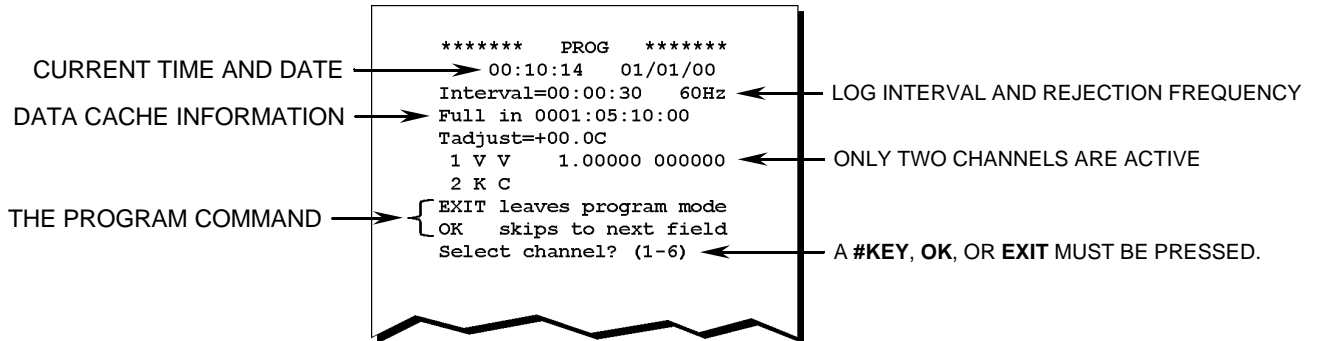

Figure 4-1

Channels may be defined as Voltage, Temperature (T/C) or Skipped. To save paper and speed programming, the definitions for Skipped channels are not printed in the above listing.

The **EXIT** key may be pressed at any time to leave the Program mode. All completed programming will be retained but partial entries will be ignored.

The **OK** key is used only during programming. It lets the user accept the current setting and advance to the next item to be programmed. This is helpful if only one or two features need to be changed and they are in the middle of the programming menu.

For example, if the channel information is correctly programmed, but you wish to change the Log Interval, use the **OK** key to break out of the channel-programming loop and reset the Log Interval. The following example shows how to set the Log Interval to 1 minute, then exit the Program mode:

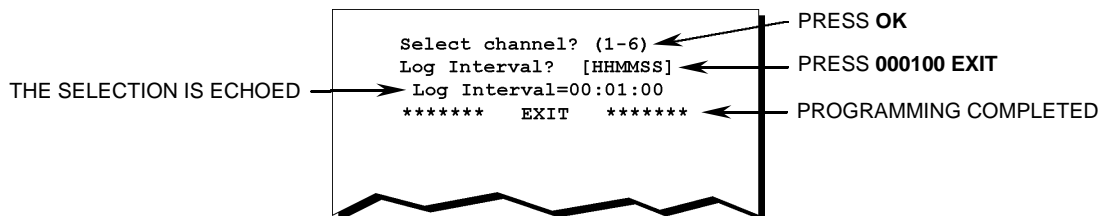

Figure 4-2

4.2 PRINT FORMATTING

When a Voltage channel (or the Math) channel is programmed, the OM-550 prompts the user for a decimal point position (or decimal point fix). This number between 0 and 5 is the location of the decimal point in the print field.

<u>POSITION</u>	<u>INTERPRETATION</u>	<u>EXAMPLE</u>
5	.#####	.00001
4	#.####	0.0001
3	##.###	00.001
2	###.##	000.01
1	####.#	0000.1
0	#####.	00001.

Any five-digit data value between " ± 0.00000 " and " ± 99999 " can be printed. Values outside this range are valid data, and will be accurately saved in memory, but printed as "*****" because they exceed the space available for printing on the paper tape.

Temperature channels are automatically formatted with one decimal place (to produce 0.1° resolution). The user can select the decimal-point position for Voltage and Math channels.

For example, a Voltage channel could receive $+2.0000$ VDC input. This would display properly with decimal-point positions of 0 through 4 but be printed as "*****" if the position 5 is chosen because "2.0000" cannot be displayed in a ".#####" field. The solution in this example is to reprogram the channel's decimal-point position to 4, as follows:

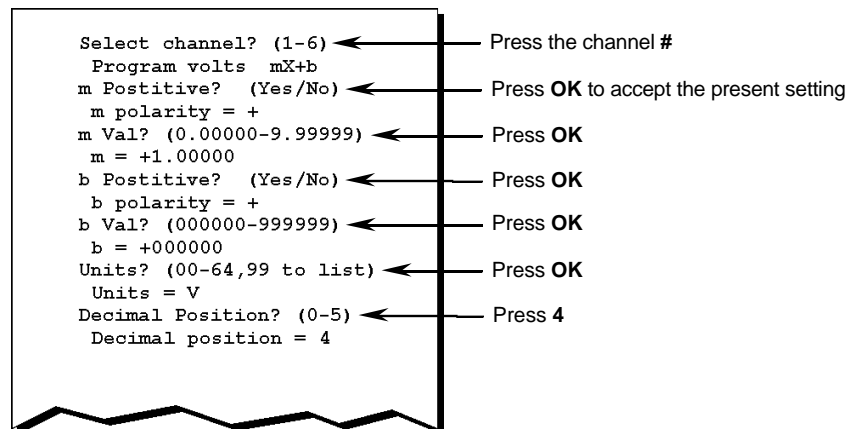

Figure 4-3

Notice that each selection is echoed whether it is changed or accepted by pressing **OK**.

4.3 TEMPERATURE CHANNELS

Any of the five channels can be programmed as Temperature channels. The user may select one of the four standard thermocouple types: J, K, T, or E and three optional types: B, S, or R.

The Thermocouple types can be mixed. For example, channel #1 with a Type E thermocouple and channel #2 with a Type J thermocouple may be used.

Temperature channel data is calculated, saved and printed in the temperature units currently selected (°C or °F). The temperature units are chosen during programming and affect all Temperature channels and Tadjust.

Temperature channel readings are automatically converted from Fahrenheit to Celsius according to the selected temperature units, but the Tadjust value is a convenient numeric constant whose value does not change when the units are changed (refer to section 4.13 TADJUST for more information).

4.4 VOLTAGE CHANNELS

Any of the five channels can be programmed as Voltage channels. Voltage channels can accept inputs over a range of ± 2.0000 VDC and the user can scale the data so that it prints in the range of values appropriate for their application.

The optional Probes include attenuators to permit ± 10 VDC or 4-20 mA signal measurements.

Refer to section 2.3.2 PROBES and 4.14 VOLTAGE INPUT SCALING for detailed information.

4.5 MATH PSEUDO-CHANNEL

The OM-550 has five physical channels and a sixth "channel" that can display the result of a math operation involving any two of the other channels (or a single channel, twice). The channels chosen as a basis for the Math channel are its "constituents".

The Math channel can be activated or "skipped" during programming. Math channel data will be printed only (not stored to RAM) if it and both constituent channels are active (not skipped). If the Math channel is active, its data will be printed (and included in the "run statistics") with data from the other channels, as channel #6 (refer to section 2.4.2 *STATISTICS*).

To inhibit the Math channel, program it as Skipped or program it as the combination of at least one other Skipped channel.

The Math channel can be used to multiply another channel by a constant or add a constant to another channel. For example, if channel 1 is a Type K Temperature channel and the user wants to log $CH\ 6 = CH\ 1 + 10^{\circ}C$, then

- Program CH 5 as a Voltage channel:
 $m=0.00000$, $b=000100$, $dp=1$, $units=00$
- Program CH 6 as $CH\ 1 + CH\ 5^*$

(*Other math functions can be used for desired results).

Now channel 5 will always be logged as 0010.0, regardless of the actual input voltage, and channel 6 will be logged as $CH\ 1 + 10$. Refer to section 4.14.4 *DATA SCALING* ($mX + b$ calculation) for more information about **m** and **b**.

The format rules for printing Math channel data are the same as for other channels; a "*****" will be printed if the value exceeds the available space or the decimal position selected during programming. Refer to section 4.2 *PRINT FORMATTING* for more information.

Although Math channel data may be calculated and printed, it is not actually stored in the cache memory. When the cached data is transferred to a PC, the software recreates the Math channel data as necessary. This has one limitation: only one cache-full of data can be sent to the PC. If more data than will fit in the cache is logged, then the oldest data is lost and the Math channel statistics (printed on STOP) will be based on data unavailable to the PC. If this is a problem, program the OM-550 to stop logging when the cache is full.

4.6 LOG INTERVAL

The each active channel is scanned once during each log interval.

The Log Interval is the time between readings, expressed in HH:MM:SS (hours:minutes:seconds). It can be programmed from one second to one day (00:00:01 to 23:59:59). The Keypad has no colon key, so enter the log interval as six numbers and the colons will automatically be inserted.

The interval can be set much faster than it can print it. At short Log Intervals the OM-550 waits until printing is complete before beginning another scan, so the data may actually be acquired less often than the Log Interval setting suggests. If this occurs, an error message is printed when the **STOP** key is pressed.

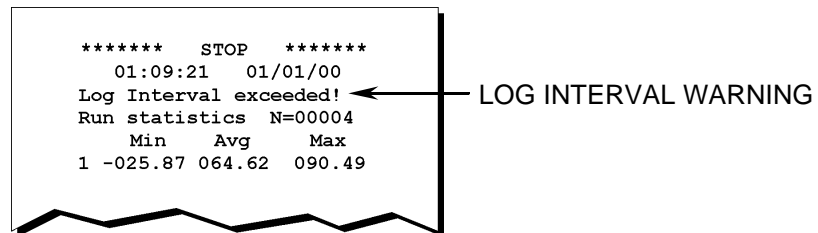

Figure 4-4

This Interval Overrun can be avoided in two ways:

- Choose not to print the data at RUN time.
- Choose a longer log interval, to allow time to print.

The Minimum log interval is 1 second but the actual rate can depend upon the number of active channels, battery Voltage input connector and whether or not data is being printed. The following table gives approximate minimum Log Intervals when logging with fresh batteries.

<u># ACTIVE CHANNELS</u>	<u>NOT PRINTING</u>	<u>PRINTING</u>
1	1 second	5 seconds
2	1	7
3	1	8
4	2	9
5	2	10
6	2	11

For example, the above table shows that if all six channels are logging and printing the data, it can require up to 11 seconds to complete one scan/print cycle.

4.7 OPERATION AT FULL CACHE (RECORDING TIME)

The OM-550 includes a battery-backed, 28-Kb data cache. The cache is erased when the **RUN** or **PROG** keys are pressed and new data is stored during logging. The OM-550 can be programmed to stop when the data cache is full or to log continuously and overwrite the oldest data when the cache fills.

When the **RUN** key is pressed, the selected operation and the time required to fill the cache is displayed. In this example, the unit will stop on a full cache:

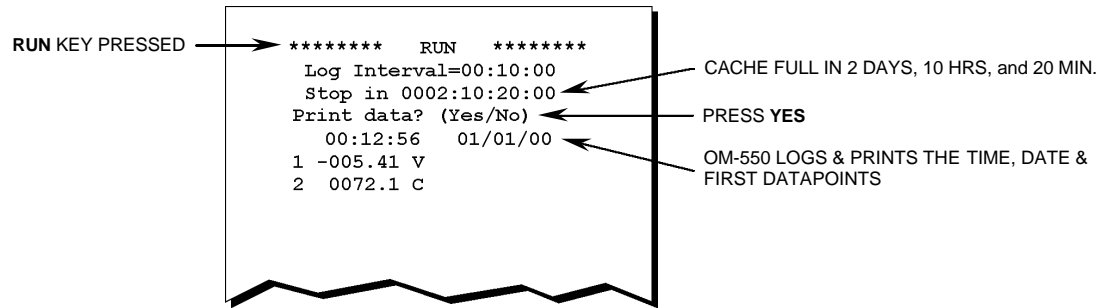

Figure 4-5

Operation at full cache is determined during programming. To program the OM-550 to stop logging when the cache is full, answer the programming prompts as follows:

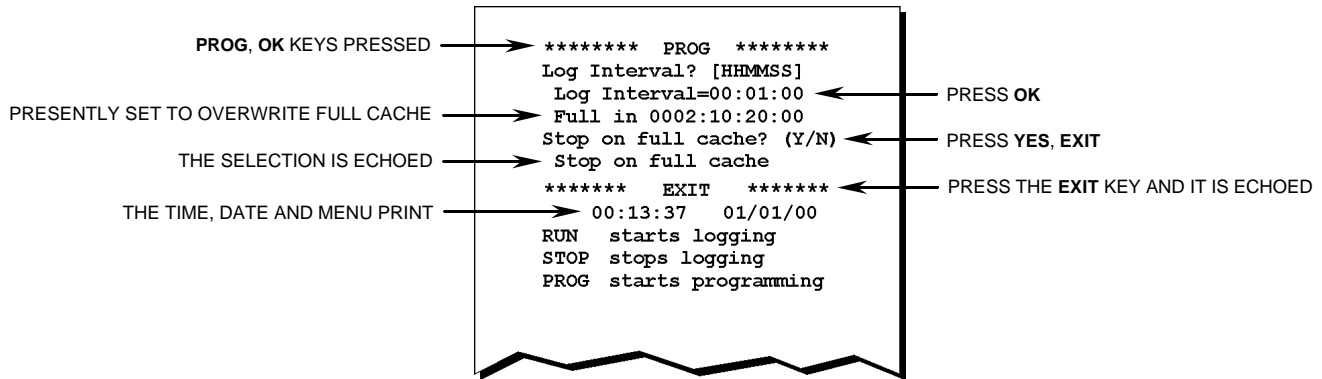

Figure 4-6

4.8 DATE

The current date is entered during programming and is kept in a real-time clock that is backed by the AA batteries. The clock will then be accurate unless the batteries are removed or a Manual Reset is executed.

The Keypad has no colon key, so enter the date as six numbers and the colons will automatically be inserted as necessary.

4.9 TIME

The current time is entered during programming and kept in real-time clock that is backed by the AA batteries. The clock will then be accurate unless the batteries are removed or a Manual Reset is executed.

The Keypad has no colon key, so enter the time as six numbers and the colons will automatically be inserted as necessary.

4.10 TEMPERATURE UNITS

Any channel (except the Math channel) may be programmed to be a Temperature channel. All Temperature channel data is scaled, stored, and printed in the current temperature units (°C or °F). The temperature units selection applies to all channels defined as J, K, T, or E thermocouple inputs. This selection is stored in EEPROM and retained even if the batteries are removed.

Tadjust is not scaled in the current temperature units. It retains its value when the temperature units are changed. Refer to section 4.13 *TADJUST* for more information.

4.11 REJECTION FREQUENCY

An A to D Conversion method is used by the OM-550 that can be optimized to reject inputs at the ambient power-line frequency, for greater measurement precision.

The Rejection Frequency defaults to 60 Hz at Manual Reset but may be reprogrammed to 50 Hz as necessary. This setting is stored in EEPROM and retained when the batteries are removed.

4.12 CALIBRATION MODE

The OM-550 includes a Cold-Junction Compensation network server that is automatically disabled during temperature calibration. Calibration mode temperature measurements performed in the usual manner will appear abnormal with the OM-550 in the CAL mode.

When the OM-550 is in the CAL mode, the time and date are printed with additional characters:

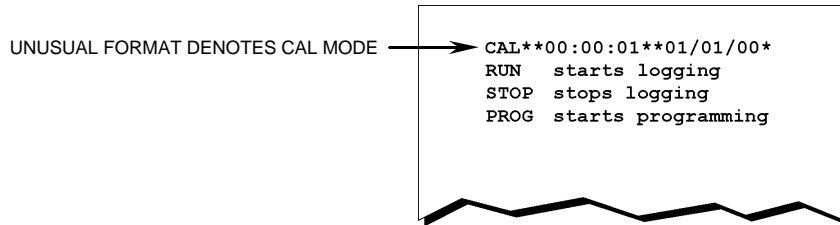

Figure 4-7

To return to Normal mode:

- Turn the unit “OFF”, then back “ON”.
- Reprogram the unit, answering **NO** to the "CAL Mode?" prompt.
- Perform a Manual Reset.



When unattended for about 1 minute, the OM-550 normally turns “OFF” (Power-save mode). This operation is different in the CAL mode: the unit does NOT automatically turn “OFF”.

Tadjust is cleared to 00.0 when entering the CAL mode and must be reprogrammed when the unit is returned to the Normal mode. See *APPENDIX A: CALIBRATION* for more information.

4.13 TADJUST

Tadjust is a cumulative value set during programming and summed with each Temperature channel's data during logging. It is cleared to a value of +00.0 at Manual Reset and on entry to the CAL mode.

Use Tadjust to correct temperature readings for batch variances in thermocouple wire or to align the readings with another measurement device.

Tadjust is programmed differently from other values because its use is different. The Tadjust value is cumulative. When a value of +0.2°C is selected during programming, that amount is **added to** the present Tadjust value.

For example, if the user wants to read exactly like another instrument, and if Tadjust=-00.3° and the readings are one-tenth of a degree below the other instrument, then increase Tadjust by +00.1. The final Tadjust value will be -00.2° and the two units will now produce the same readings.

4.14 VOLTAGE INPUT SCALING

Any of the input channels (1 through 5) may be programmed as Voltage channels. Each Voltage channel includes unique **m** and **b** constants for "scaling" data to your application. These constants default to +1.00000 and 000000, respectively, when the channel is first programmed as a Voltage channel but the user may reprogram them as necessary. The following pages include examples for common transducers.

4.14.1 MATCHING TRANSDUCERS TO THE OM-550

Some transducers provide a "voltage" output; others provide a "current" output. This section explains how to use resistors to match either output to the input.

Currents must be converted to a voltage and voltages must be attenuated (reduced) if they can exceed the maximum input (± 2.0000 VDC). This process is called Matching, which means converting or attenuating the transducer's output to an acceptable level without overloading it.

4.14.2 MATCHING A VOLTAGE TRANSDUCER

Use two resistors to attenuate a voltage without overloading the transducer. The method shown here will draw approximately half of the transducer's maximum current at full-scale.

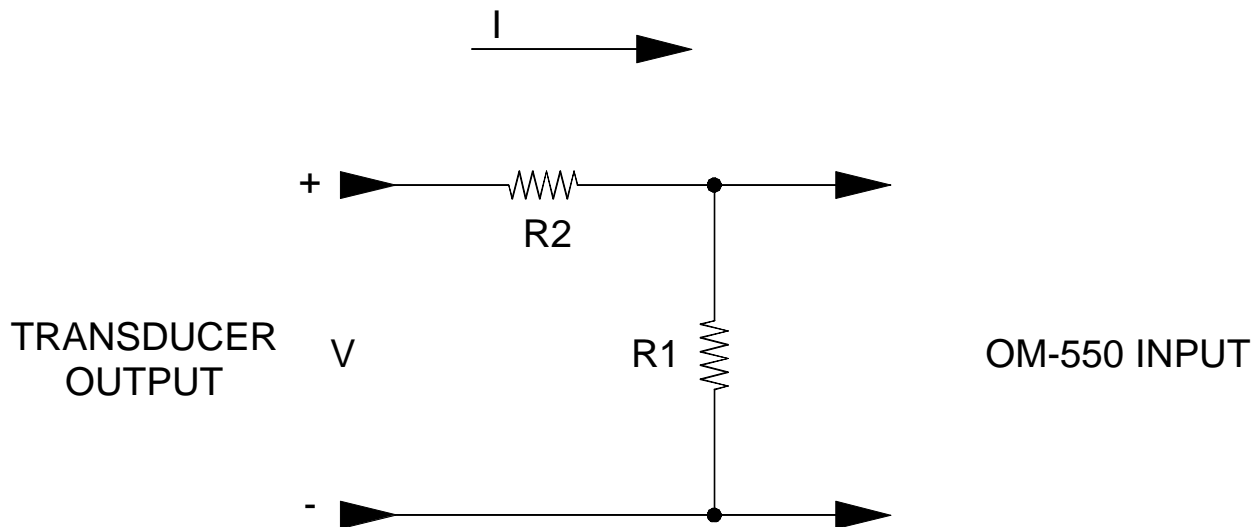

Figure 4-8

$$\begin{aligned} V &= \text{transducer maximum output voltage.} \\ I &= \frac{1}{2} \text{ transducer's maximum output current.} \\ R1 &= \frac{2}{I} \\ R2 &= \frac{(V-2)}{I} \end{aligned}$$

The ± 10 Voltage Probe (P/N E29-0050-35) uses this technique to attenuate ± 10 VDC signals to the input range of ± 2 VDC.

4.14.3 MATCHING A CURRENT TRANSDUCER

Use one resistor to develop the necessary voltage at the input:

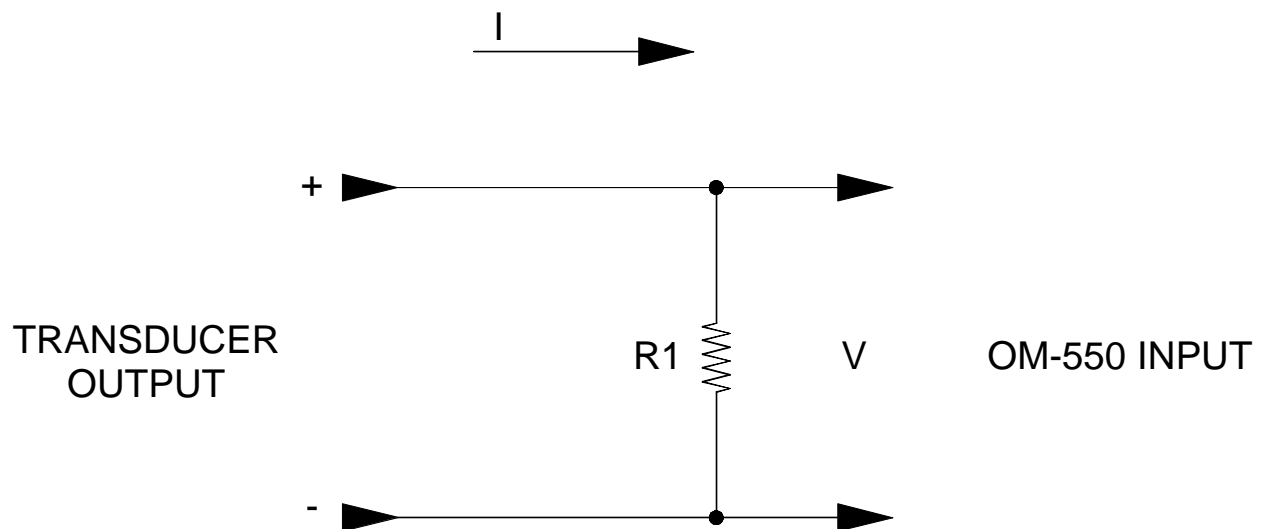

Figure 4-9

$$\begin{aligned} V &= \text{OM-550 maximum input voltage} \\ &= \mathbf{2.0000} \text{ VDC} \\ &= \mathbf{R1 * I} \end{aligned}$$

$$I = \mathbf{1/2} \text{ transducer's maximum output current}$$

$$R1 = \mathbf{2 / I}$$

The 4-20 mA Current Probe uses this technique (with **R1=100 Ω**) to convert a 4-20 mA current to a 0.4-2.0 VDC signal.

4.14.4 DATA SCALING ($mX + b$ calculation)

The output voltage of a properly matched transducer can be read but the data will be in "volts" and the user might prefer data in units that reflect the application. Programming the OM-550 to produce data in terms of the actual parameter being measured is called Scaling.

The linear slope-intercept formula ($Y = mX + b$) makes this possible. Given an input "X", careful choice of **m** and **b** can scale the output "Y" to any value, with some restrictions:

- Some **m** or **b** values will produce values too large (or small) to print, although they will be correctly saved to memory for transfer to a PC. Such values will print as "*****". Refer to section 4.2 *PRINT FORMATTING*.
- The OM-550 can resolve 100 μ V (± 0.0001 VDC). This means that one A/D converter "count" (the LSB) is worth 0.0001 VDC and the maximum input voltage (± 2.0000 VDC) represents $\pm 20,000$ A/D converter counts.
- The **m** and **b** values you choose must be within the allowable ranges:

$$-9.99999 \leq m \leq +9.99999 \quad -999999 \leq b \leq +999999$$

The following equations show how to scale data to the actual value of the parameter being measuring. They assume that an increasing transducer output indicates an increasing parameter. (If your system is inversely proportional, just change the sign of the **m** value). Remember that **m** and **b** can be positive or negative.

X1 = minimum voltage expected at the input
X2 = maximum voltage expected at the input

Y1 = minimum parameter value for your application
Y2 = maximum parameter value for your application

$$m = (Y1 - Y2) / (X1 - X2) \quad b = Y2 - (m * X2)$$

4.14.5 MATCHING AND SCALING A VOLTAGE TRANSDUCER

EXAMPLE: Given a 20 - 90 % RH (Relative Humidity) transducer with a 0 - 10 VDC output at a maximum current of 3 mA.

Program the OM-550 to indicate 20.00 %RH to 90.00 %RH (that is, to indicate %RH with 0.01% resolution).

If a ± 10 Voltage Probe is being used, begin with step 3, below. (This probe is already matched to the OM-550).

1. First, find the Matching resistors:

$$\begin{aligned} I &= 1/2 \text{ maximum current} \\ &= 0.003 / 2 \\ &= 0.0015 \text{ Amps} \end{aligned}$$

$$\begin{aligned} R1 &= 2 / I \\ &= 2 / 0.0015 \\ &= 1333 \Omega \end{aligned}$$

$$\begin{aligned} R2 &= (V - 2) / I \\ &= (10 - 2) / 0.0015 \\ &= 5333 \Omega \end{aligned}$$

2. Check:

$$\begin{aligned} V &= (R1 + R2) * I \\ &= (1333+5333)*1.5 \text{ mA} \\ &= 9.999 \\ &= 10 \end{aligned}$$

$$\begin{aligned} V &= R2 * I \\ &= 1333*1.5 \text{ mA} \\ &= 1.9995 \\ &= 2 \end{aligned}$$

With these matching resistors the OM-550 will see a max 2 VDC at the Transducer max output of 10 VDC.

3. Next, find m & b:

<p>X1 = 0 VDC = 0 A/D counts</p> <p>X2 = 2.0000 VDC = 20000 A/D counts</p> <p>Y1 = 20.00 %RH = 2000 display counts</p> <p>Y2 = 90.00 %RH = 9000 display counts</p> <p>m = (Y1 - Y2) / (X1 - X2) = (2000 - 9000) / (0 - 20,000) = 0.35000</p> <p>b = Y2 - (m * X2) = 9000 - (0.350 * 20,000) = 002000</p>	<p>← minimum expected input at Transducer minimum output</p> <p>← maximum allowable input at Transducer maximum output</p> <p>← choose decimal point = 2</p> <p>← keep decimal point = 2 [Desired % RH resolution 2 places to right of the decimal point (.01% RH)]</p>
--	---

4. Programming for the previous example:

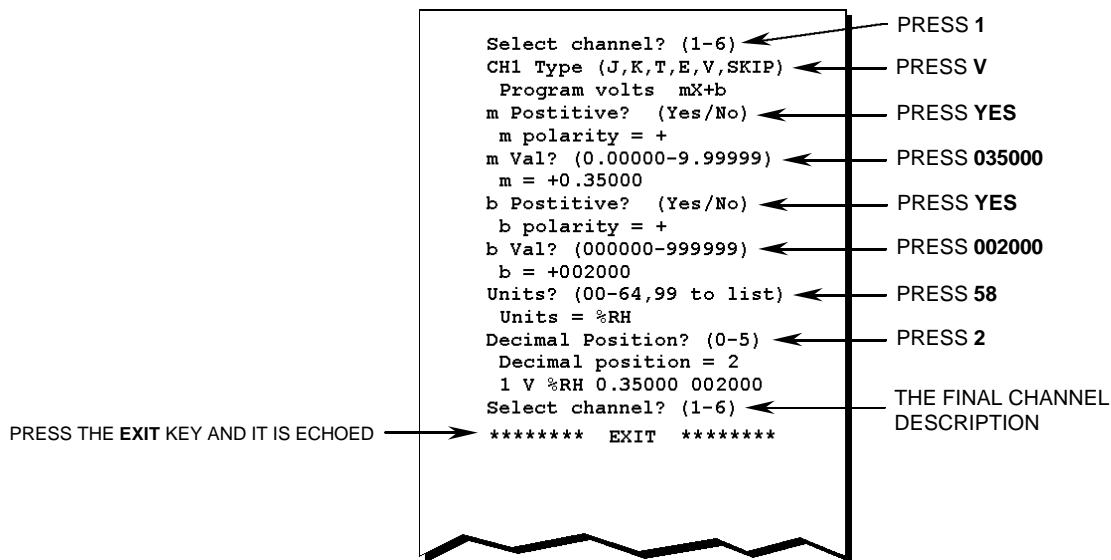

Figure 4-10

4.14.6 MATCHING AND SCALING A CURRENT TRANSDUCER

Example:

Given a 0 - 150-PSI transducer with a 4-20 mA output.

Program the OM-550 to indicate 0 - 150 PSI with 0.01-PSI resolution.

If the 4-20 mA Current Probe is being used, begin with step 2, below. (This probe is already matched to the OM-550).

1. First, find the Matching resistor:

$$\begin{aligned} R1 &= 2 / I \\ &= 2 / 20 \text{ mA} \\ &= 2 / 0.02 \\ &= 100 \Omega \end{aligned}$$

When the transducer output is 4 mA, the OM-550 will see 0.4 VDC and when the transducer output is 20 mA, the OM-550 will see 2 VDC.

2. Next, find m & b:

$$\begin{aligned} X1 &= 0.4000 \text{ VDC} && \leftarrow \text{minimum expected input} \\ &= 4000 \text{ A/D counts} && \text{at Transducer minimum output} \end{aligned}$$

$$\begin{aligned} X2 &= 2.0000 \text{ VDC} && \leftarrow \text{maximum allowable input} \\ &= 20000 \text{ A/D counts} && \text{at Transducer maximum output} \end{aligned}$$

$$\begin{aligned} Y1 &= 0.00 \text{ PSI} && \leftarrow \text{minimum transducer output} \\ &= 0.00 \text{ PSI} && \leftarrow \text{choose decimal point} = 2 \end{aligned}$$

$$\begin{aligned} Y2 &= 150.00 \text{ PSI} \\ &= 15000 \text{ display counts} \end{aligned}$$

$$\begin{aligned} m &= (Y1 - Y2) / (X1 - X2) \\ &= (0 - 15000) / (4000 - 20000) \\ &= 0.93750 \end{aligned}$$

$$\begin{aligned} b &= Y2 - (m * X2) \\ &= 15000 - (0.93750 * 20000) \\ &= -003750 \end{aligned}$$

Notice the decision to indicate with 0.01-PSI resolution determined a decimal position of 2.

3. Programming for the previous example:

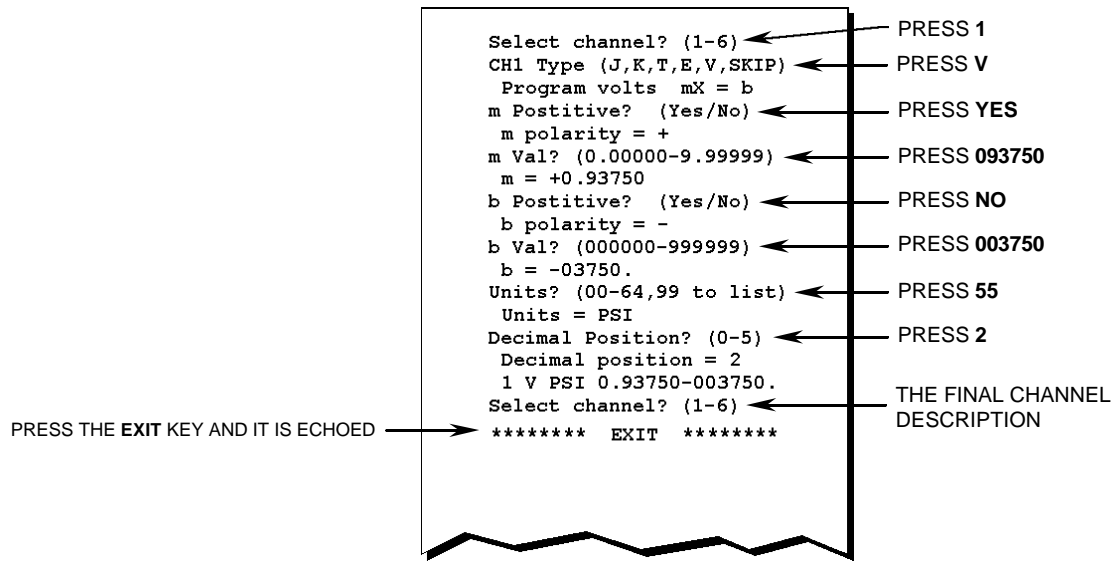

Figure 4-11

4.15 UNIT LABELS

Each channel includes a character Unit label. The Unit label is assigned during programming and printed with the data for that channel during logging.

All Temperature channels use one, common label (°C or °F). Refer to section 4.10 *TEMPERATURE UNITS* for more information.

Each Voltage channel may be programmed with an individual Unit label and every available label has an associated number.

When prompted for a Units label during programming, enter the corresponding number to assign the Unit or press "99" to see a list of the labels and their associated numbers, as below:

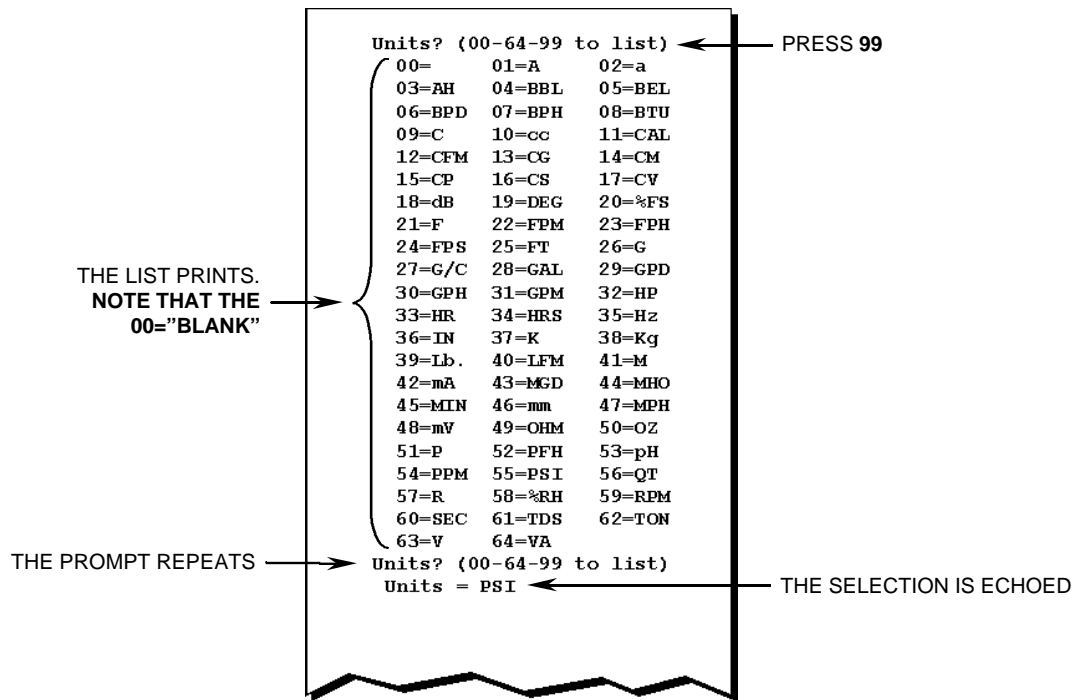

Figure 4-12

This list is always available from the Keypad but many operators prefer to print it and save the printout to avoid the delay while it reprints.

5.0 OPERATION

The following section will guide the user through a typical logging process. These steps may vary depending on the type of data the user is logging. When using this procedure it may be necessary to refer to section 4.0 *PROGRAMMING* for proper programming procedures and alternate options.

1. Turn the OM-550 "ON".
2. Press the **PROG** key to confirm the current programming information.

```
*****  PROG  *****
00:10:14  01/01/00
Interval=00:00:30  60Hz
Full in 0001:05:10:00
Tadjust=+00.0C
1 V V  1.00000 000000
2 K C
EXIT leaves program mode
OK skips to next field
Select channel? (1-6)
```

Figure 5-1: Programmed Information



If the channel information is correctly programmed press the **EXIT** key to accept the current settings and the OM-550 is ready to log data.

2. Select a type of voltage or thermocouple input for each channel (J, K, T, E, V, SKIP), or press **OK** to advance to the next item.

```
Select channel? (1-6)
CH1 Type (J,K,T,E,V,SKIP)
1 ? ?
CH2 Type (J,K,T,E,V,SKIP)
2 ? ?
CH3 Type (J,K,T,E,V,SKIP)
3 ? ?
CH4 Type (J,K,T,E,V,SKIP)
4 ? ?
CH5 Type (J,K,T,E,V,SKIP)
5 ? ?
CH6 Type (J,K,T,E,V,SKIP)
6 ? ?
```

Figure 5-2: Channel Type Selection

3. Enter the desired Log Interval time, or press **OK** to advance to the next item.

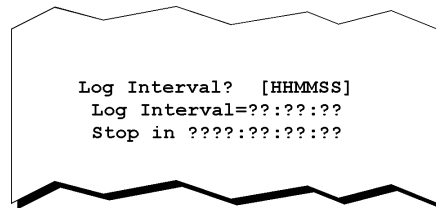

```
Log Interval? [HHMMSS]
Log Interval=?:?:?:??
Stop in ??:?:?:?:??
```

Figure 5-3: Log Interval Time

4. Select whether to stop collecting data when the Cache is full, collect data continuously, or press **OK** to advance to the next item.

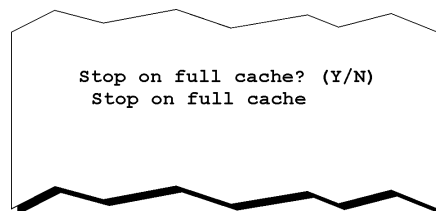

```
Stop on full cache? (Y/N)
Stop on full cache
```

OR

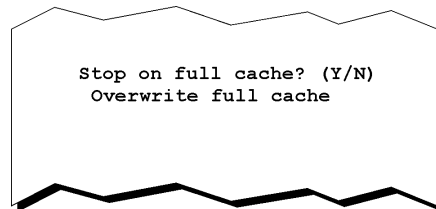

```
Stop on full cache? (Y/N)
Overwrite full cache
```

Figure 5-4: Operation at Full Cache

5. Enter the current Time, or press **OK** to advance to the next item.

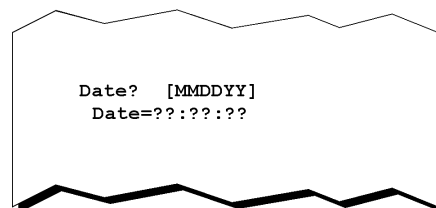

```
Date? [MMDDYY]
Date=?:?:?:??
```

Figure 5-5: Current Date

6. Enter the current Date, or press **OK** to advance to the next item.

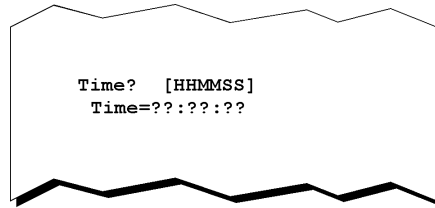
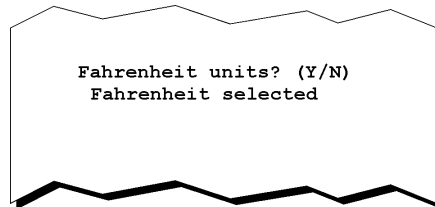

Figure 5-6: Current Date

7. Select the desired temperature units, or press **OK** to advance to the next item.



OR

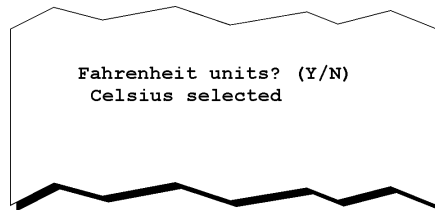
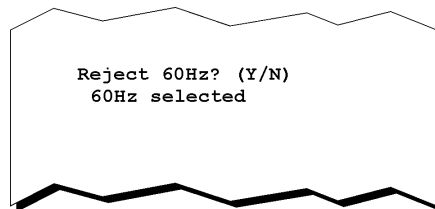

Figure 5-7: Temperature Units

8. Select the Rejection frequency, or press **OK** to advance to the next item.



OR

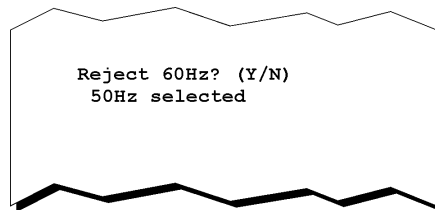

Figure 5-8: Reject Frequency

9. Turn the Cal mode ON, OFF, or press **OK** to advance to the next item.

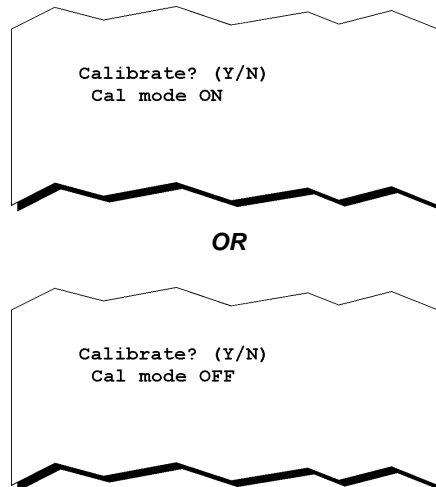

Figure 5-9: Cal Mode Selection

10. Enter a Tadjust value, or press **OK** to finish programming.

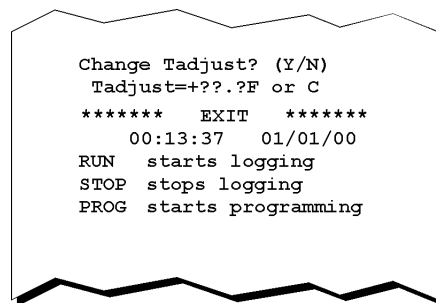

Figure 5-10: Tadjust Value Selection

- Programming is now complete and the list of functions will be printed.

11. Press the **RUN** key and the OM-550 will print the log interval, stop time and prompt the user to choose if they want to print the data while logging. When either YES or NO is selected the data collection process automatically begins.

```
*****  RUN  *****  
Log Interval=00:10:00  
Stop in 0001:05:10:00  
Print data? (Yes/No)
```

Figure 5-11

12. When the data collection process is complete the data stored in the internal cache can now be transferred to a PC.
13. Connect the RS-232 cable to the Data port on the OM-550 and make sure the other end is connected to the PC (refer to section 3.3 *DATA PORT CONNECTION* for more information).
14. Turn the OM-550 "ON" and transferred the data into the software program for analysis and data basing. Use the appropriate OM-550 Software and Manual for detailed data transfer information.

APPENDIX A: CALIBRATION

• MANUAL RESET

A Manual Reset returns the OM-550 to a "known" condition. This is useful when troubleshooting or learning to program the unit.

A Manual Reset programs the OM-550 as follows:

- CH1 is a Voltage channel, m=1.00000, b=000000, dp=4, units = (63) "V".
- CH2 is a Type K thermocouple Temperature channel.
- CH3 through 5 are Skipped
- CH6 is Skipped but defined as CH4+CH5, decimal fix=1, units = .00 (Blank)
- The Temperature Units for all temperature channels are °C.
- The Real-time Clock/Calendar is initialized to 00:00:00 01/01/00.
- The Log Interval is 00:00:30 (30 seconds).
- The OM-550 is in the Normal (not the Calibration) mode.
- Tadjust = 00.0
- The Rejection Frequency = 60Hz.
- The data cache contains 100 "phony" points of data for channels 1 & 2.
- The OM-550 is programmed to overwrite a full cache.

• PERFORMING A MANUAL RESET

1. Turn the unit "OFF"
2. Press & hold the **5** key
3. Momentarily press the **ON** key
4. Release the **5** key

A collection of messages similar to the one shown in Figure A-1 will be printed.

```
**** MANUAL RESET ****
*** version XX.XX ***
** programming init **
* channel records init *
***** clock init *****
***** cache init *****
***** ON *****
00:00:00 01/01/00
RUN starts logging
STOP stops logging
PROG starts programming
```

Figure A-1

• CALIBRATION PROCEDURE

Using the following Calibration procedure we recommend that the OM-550 is recalibrated every 6 months.

Setup:

1. Perform a Manual Reset
2. Press the **PROG** key to enter the programming mode
3. Expect a printout similar to the following:

```
*****  PROG  *****
00:00:0X  01/01/00
Interval=00:00:30  60Hz
Full in 0001:05:10:00
Tadjust=+00.0C
 1 V V   1.00000 000000
 2 K F
EXIT leaves program mode
OK  skips to next field
```

Figure A-2

4. Answer the prompts as follows:

```
Select channel? (1-6) ← PRESS OK
Log Interval? [HHMMSS] ← PRESS 000005
Log Interval=00:00:05
Full in 0000:04:51:40
Stop on full cache? (Y/N) ← PRESS NO
Overwrite full cache
Date? [MMDDYY] ← PRESS (CURRENT DATE)
Date=XX/XX/XX
Time? [HHMMSS] ← PRESS (CURRENT TIME)
Time=XX:XX:XX
Celsius units? (Yes,No) ← PRESS NO
Fahrenheit selected
60HZ REJECT? (Yes,No) ← PRESS OK
60Hz selected
Calibrate? (Yes,No) ← PRESS YES
Cal mode ON
Tadjust=+00.0
*****  EXIT  ***** ← PROGRAMMING IS DONE
```

Figure A-3

• VOLTAGE ADJUSTMENT PROCEDURE:



It is recommended that the OM-550 is operated with the batteries while this procedure is performed to reducing noise in measured voltages.

1. Use a white (copper) voltage connector and copper wire for all voltage and thermocouple inputs during calibration.
2. Locate the access hole for the Volt Gain adjustment on the bottom of the OM-550.

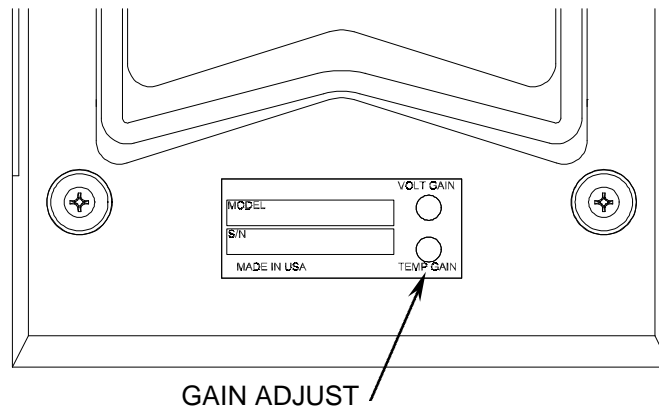

Figure A-4

3. Apply a 2.00000 VDC standard voltage to channel #1.
4. Start logging and produce a printout, press **RUN, YES** on the keypad.
5. Adjust the Volt Gain pot for a CH #1 reading of 2.0000 V (± 0.0001 V).
6. Press the **STOP** key.
7. Proceed with the thermocouple adjustment.

• THERMOCOUPLE ADJUSTMENT PROCEDURE:

1. Apply a 49.996mV (type K @ 2250 °F) standard voltage to channel #2.
2. Locate the access hole for the Temp Gain adjustment in the back cover.
3. Start logging and produce a printout, press **RUN, YES** on the keypad.
4. Adjust the Temp Gain pot for a channel #2 reading of +2250.0°F(± 1 °F).
5. Press the **STOP** key.

• EXITING CAL MODE

When calibration is complete, the unit is still in the CAL mode (it is ignoring the cold junction compensation).

To return to normal operation:

- Press **PROG** on the keypad to enter the programming mode, then use the **OK** key to step down through the menu to the Calibration prompt, and then answer **NO**.

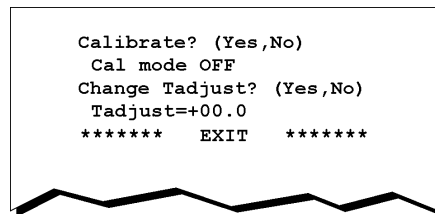

```
Calibrate? (Yes,No)
Cal mode OFF
Change Tadjust? (Yes,No)
Tadjust=+00.0
*****  EXIT  *****
```

Figure 6-1

OR

- Turn the unit “OFF” (and back “ON” if desired).

OR

- Perform a Manual Reset.

APPENDIX B: SPECIFICATIONS

(OM-550 at 25°C unless otherwise stated)

VOLTAGE MEASUREMENT INPUTS:

IMPEDANCE:	10 Meg Ω nominal
RANGE:	± 2 VDC
RESOLUTION:	100 μ V
ACCURACY:	± 500 μ V
CMRR:	>120 db at 50/60 Hz
NMRR:	> 45 db at 50/60 Hz
ABSOLUTE MAXIMUM OVERVOLTAGE PROTECTION:	120 VAC

THERMOCOUPLE INPUTS:

TYPES:	J, K, T, E
RESOLUTION:	0.1°, C or F
INPUT IMPEDANCE:	100 Meg Ω
LEAD RESISTANCE EFFECT:	<20 μ V / 800 Ω
COLD JUNCTION COMPENSATION:	$\pm 0.5^\circ$ C Max, (10°C to 40°C)
CMRR at 50/60 Hz:	>120 db
NMRR at 50/60 Hz:	> 60 db

ACCURACY:

<u>TYPE</u>	<u>RANGE (°C)</u>	<u>TABLE CONFORMITY</u>	<u>TOTAL ACCURACY</u>
J	-165. to +760.	0.08°	$\pm 0.8^\circ$
	0. to +760.	0.08°	$\pm 0.6^\circ$
K	-101. to +1250.	0.10°	$\pm 0.8^\circ$
	0. to +1250.	0.10°	$\pm 0.6^\circ$
T	-105. to +400.	0.10°	$\pm 0.8^\circ$
	0. to +400.	0.10°	$\pm 0.6^\circ$
E	-140. to +660.	0.09°	$\pm 0.8^\circ$
	0. to +660.	0.09°	$\pm 0.6^\circ$

<u>TYPE</u>	<u>RANGE (°F)</u>	<u>TABLE CONFORMITY</u>	<u>TOTAL ACCURACY</u>
J	-265. to +1400.	0.14°	$\pm 1.5^\circ$
	+32. to +1400.	0.14°	$\pm 1.0^\circ$
K	-150. to +2282.	0.18°	$\pm 1.5^\circ$
	+32. to +2282.	0.18°	$\pm 1.0^\circ$
T	-158. to +752.	0.18°	$\pm 1.5^\circ$
	+32. to +752.	0.18°	$\pm 1.0^\circ$
E	-220. to +1225.	0.16°	$\pm 1.5^\circ$
	+32. to +1225.	0.16°	$\pm 1.0^\circ$

PRINTER

TYPE: 24-Column Thermal
PAPER ROLL CAPACITY: 82 ft \pm 1.6 ft
LINE HEIGHT: 0.150 inches per printed line
LINES PER ROLL: 6,560 \pm 128

PAPER LIFE

(Printing 5 channels every 10-min.) Approximately 217 hours or 9 days

DIGITAL INTERFACE (RS-232)

COMMUNICATION FORMAT: 9600 baud, No parity, 8 data bits, 1 stop bit
OUTPUT VOLTAGES: \pm 9 VDC

A/D CONVERSION

RESOLUTION: \pm 20,000 counts
TECHNIQUE: Dual slope, selectable 50/60 Hz rejection

CHANNEL CAPACITY

NUMBER OF INPUT CHANNELS: 5 Voltage or Thermocouple, 1 Pseudo-math

INTERNAL DATA STORAGE

MAXIMUM CAPACITY: 28 Kbytes or 7000 data samples

ENVIRONMENTAL

OPERATING AND STORAGE

ENVIRONMENT: Indoor use only
OPERATING TEMPERATURE RANGE: 0°C to 50°C (32°F to 122°F)
STORAGE TEMPERATURE RANGE: -25°C to 75°C (-13°F to 167°F)
OPERATING RELATIVE HUMIDITY RANGE: Maximum 80% R.H. for temperatures up to 31°C decreasing linearly to Max. 50% R.H. at 40°C, remaining constant from 40°C to 50°C.

STORAGE RELATIVE HUMIDITY RANGE: Max. 95% R.H., non-condensing

MAINS VOLTAGE FLUCTUATION RANGE: Maximum \pm 10%



This is the maximum fluctuation from the nominal rated input voltage for the AC Power Adapter.

POLLUTION DEGREE:

Pollution Degree 2 per IEC Publication 664



This classification means that normally only non-conductive pollution (in the form of dust) occurs. Occasionally, however, a temporary conductivity caused by condensation must be expected.

INSTALLATION CATEGORY
(OVERVOLTAGE CATEGORY):

Installation Category II per IEC publication 664



This classification applies to products used on electric supply branch circuits. This is defined as a classification of parts of installation systems or circuits with standardized limits for transient overvoltages, dependent on the nominal line voltage to earth.

POWER/CURRENT REQUIREMENTS

INTERNAL CELLS:	4-AA alkaline cells
OM-550 POWER INPUT:	9VDC, 50 mA (700 mA Peak while printing)
AC POWER ADAPTER INPUT:	120 VAC or 230 VAC, model-specific
OUTPUT:	9 VDC, 1 A, 9 W
EXTERNAL OPTIONAL BATTERY PACK:	12 VDC, Rechargeable,
FUSE FOR DC POWER CABLE:	2A/250V, 0.25" x 1.25" (6.3 mm x 32 mm)

BATTERY LIFE

INTERNAL CELLS:	Approximately 8000 printed lines
-----------------	----------------------------------

PHYSICAL DIMENSIONS

WEIGHT:	4" W X 9.5" D X 1.5" H (with paper roll) 2 lb. (with batteries and paper)
CALIBRATION:	NIST traceability
RECALIBRATION PERIOD:	6 months
WARRANTY PERIOD:	1 year
SHIPPING WEIGHT:	6 Lb.

CONNECTORS

ANALOG INPUTS:	Miniature female thermocouple style
DC POWER:	5.5 mm X 2.1 mm (.216" X .080") male jack
RS-232 DATA PORT:	4 Position 4 Circuit Modular (4P4C)

OM-550 DOS Software

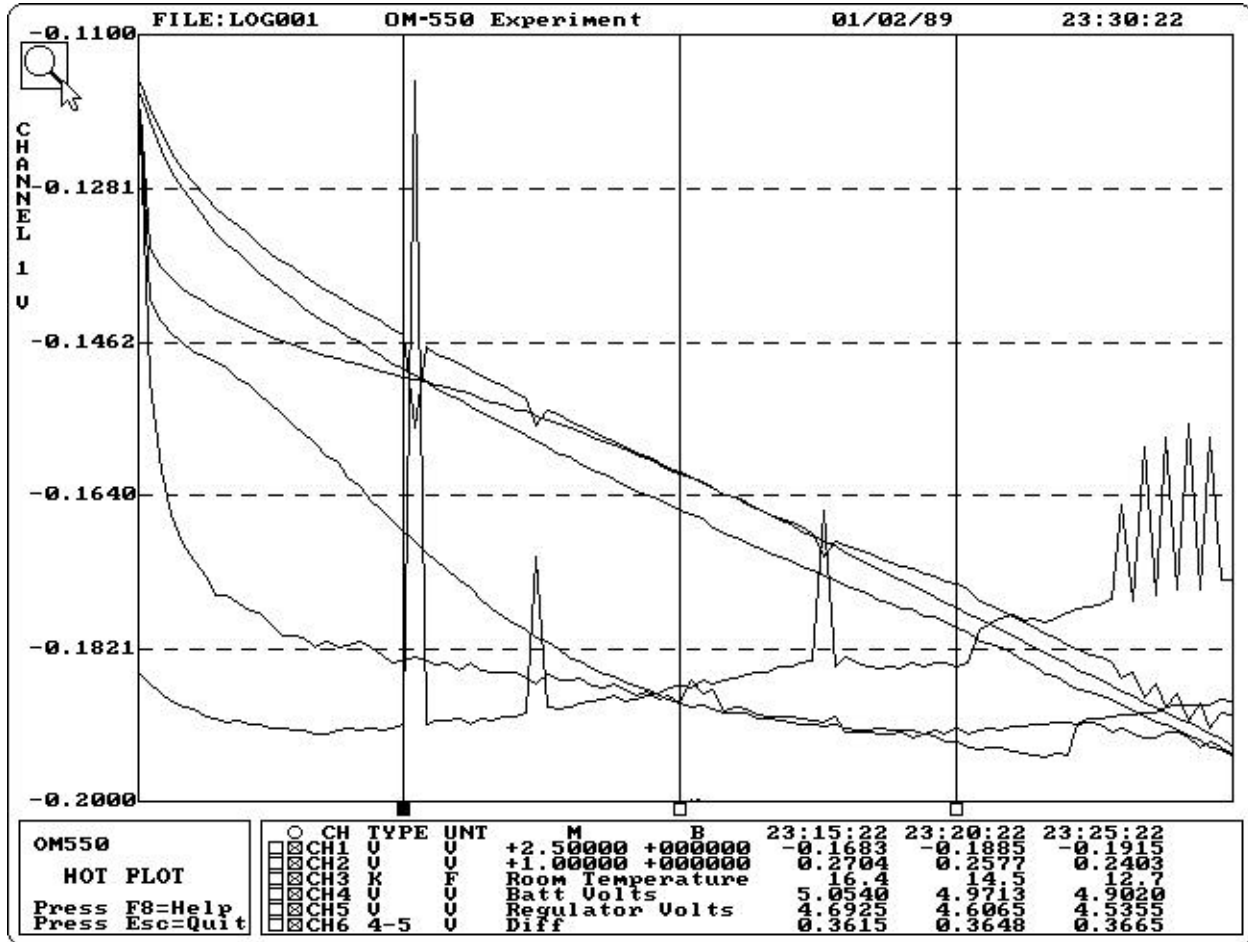

TABLE OF CONTENTS

INTRODUCTION	ii
• How to Use This Manual.....	ii
• Terms Used in this Manual.....	ii
• Fonts Used in this Manual.....	iii
• File Formats.....	iii
PC Hardware Requirements	iv
Software Installation	v
1.0 STARTING THE PROGRAM	1
2.0 MASTER MENU	2
2.1 READING DATA FROM THE OM-550.....	3
2.2 LOAD EXISTING LOG FILES.....	4
2.3 MODIFY SOFTWARE CONFIGURATION.....	5
2.4 LIST DATA ON MONITOR.....	7
2.5 PRINT DATA ON PRINTER.....	8
2.6 SAVE TEXT FILE.....	8
2.7 EDIT PLOT LABELS.....	9
2.8 HOT PLOT.....	10
2.8.1 STATUS BAR.....	11
2.8.2 MAGNIFY TOOL.....	12
2.8.3 Y-AXIS LABELS.....	14
2.8.4 CHANNEL DATA.....	15
2.8.5 DATA GRAPH.....	18
2.8.6 HELP MENU.....	20
2.9 LIST EXISTING LOG FILES ON PRINTER.....	21
2.10 QUIT.....	21
APPENDIX A: KEY FUNCTIONS	22

INTRODUCTION

This **Software User's Guide** explains how to use Omega's OM-550 DOS software.

The software requires an IBM™ PC or compatible, with 640K of ram and 1 or 2 serial ports.

The software is supplied on a 3 ½" disk, and it is recommended that at least one backup copy is made to hold in reserve. Refer to your computer manual for copying instructions.

OM-550 data can be saved to disk as experiment files. The files are automatically named with the word LOG, followed by three numbers, like LOG007. The numbers will increment as new experiments are saved or can be user configurable.

In addition to the OM-550 data, an experiment file can (optionally) contain information describing the parameters of the experiment and the data.



• How to Use This Manual

This manual is written for users of varied experience. If a section covers information you already know, feel free to skip to the next section.

- You **do not need** to be a computer expert to use this manual or the software.

• Terms Used in this Manual

The following definitions, special terms and symbols will be used in this manual.

- **Thermocouple**, may be referred to as **T/C**
-  **Informs the user that the note includes important information.**
-  **Informs the user that the note includes a handy software tip.**

• Fonts Used in this Manual

This manual uses a special font to indicate terms or words that can be found directly on the PC display.

For Example: The *Master Menu* options change to match what you are doing. This font indicates the words *Master Menu* are actually found in the PC display.

• File Formats

Data transferred from the OM-550 to a PC can be stored to disk in two file formats:

Experiment files (LOG###.BIN) are stored in binary format to conserve disk space. Experiment files contain the OM-550 data and the labels assigned from the Master Menu. Experiment files are the primary storage medium for the software program and can be recalled from the hard drive at any time.

The data may also be saved in Text files (LOG###.PRN) for export to spreadsheet programs. Although the software can write both types of files, it can only read the Binary (BIN) files.

The software always loads LOG001.BIN when it starts. Existing files can then be loaded using option #2 *Load Existing LOG File* from the Master Menu.

Experiment files are automatically numbered when saved to disk. The numbers can be controlled using Option #3 *Modify Software Configuration* from the Master Menu.

If the data is graphed before being saved, it has no filename. The “name” is displayed on the graph as “LOG???” to remind the user to save the data before exiting the program.

In general, the software is designed to help the user avoid losing valuable data.

PC Hardware Requirements

Before OM-550 DOS software can be used, a 386 or better computer will be required to run the software. Specific recommendations are as follows:

- CPU, RAM, Hardware:** 386
640K RAM (minimum).
400KB of free disk space.
- Disk Drive:** 3.5" high-density floppy disk drive.
- Mouse:** IBM compatible mouse, plugged into either a dedicated mouse or serial port.
- Serial Port:** At least one port in addition to the one used for the mouse.
- Video:** Color VGA or better graphics adapter and appropriate video monitor.
- Printer:** Color printer is recommended.

Software Installation

The software is on a 3.5" floppy disk and before it is installed on a PC, make a backup copy of the program disk, you should never work from your original program disks. Be sure to view the README file on the program disk before installing the software (any standard text viewer can be used). The README contains the latest information on the software and installation instructions.

• HARD DRIVE INSTALLATION

1. Insert disk 1 in the disk drive.
2. At the DOS prompt, type the drive name, colon, backslash and *instalit* and hit the [enter] key.

For example, if the program diskette is inserted into the "A" drive; type: *A:\instalit*.

3. Follow the setup instructions provided with the software.

1.0 STARTING THE PROGRAM

To start the program:

1. At the DOS prompt type the DOS command, CD (change directory), drive name, colon, backslash and the program name and hit the [enter] key.

For example, if the program is installed in the default directory C:\M50 type:

- CD C:\M50\M50C (If you have a computer with a CGA video card).
- CD C:\M50\M50E (If you have a computer with a EGA video card).
- CD C:\M50\M50V (If you have a computer with a VGA video card).
- CD C:\M50\M50H (If you have a computer with a Hercules video card).

When the program begins it will display the *Master Menu*.

```
OM550 Graphic Analysis Software V1.30
Copyright Omega Engineering, ECD 1988,89,95

OM550 GRAPHIC ANALYSIS MASTER MENU

1=Read Data From OM550
2=Load Existing LOG File
3=Modify Software Configuration
4=List Data on Monitor
5=Print Data on Printer
6=Save Text File (LOGNNN.PRN)
7=Edit Plot Labels
8=HOT PLOT
L=List Existing Log Files On Printer
Q=Quit

Current File Loaded =LOG001.bin
```

Master Menu Screen

2.0 MASTER MENU

The *Master Menu* lists the options available to assist the user to read data from the OM-550, read an existing experiment file, or modify the software configuration parameters (custom labels and computer configuration). The following sections will describe how each option will assist the user to analyze the data collected by OM-550.



Experiment file LOG001 is always automatically loaded when the program is started and is the file used in all the figures in this manual.

```
OM550 Graphic Analysis Software V1.30
Copyright Omega Engineering, ECD 1988,89,95

OM550 GRAPHIC ANALYSIS MASTER MENU

1=Read Data From OM550
2=Load Existing LOG File
3=Modify Software Configuration
4=List Data on Monitor
5=Print Data on Printer
6=Save Text File (LOGNNN.PRN)
7=Edit Plot Labels
8=HOT PLOT
L=List Existing Log Files On Printer
Q=Quit

Current File Loaded =LOG001.bin
```

Master Menu

2.1 READING DATA FROM THE OM-550

Option #1 *Reading Data from the OM-550*, on the Master menu allows the user to transfer the data from the OM-550 to the PC.



Before starting the read process, the communication cable must be installed and the OM-550 is ON.

To transfer data:

1. Press the  key and instructions how to properly transfer data will appear on the screen.

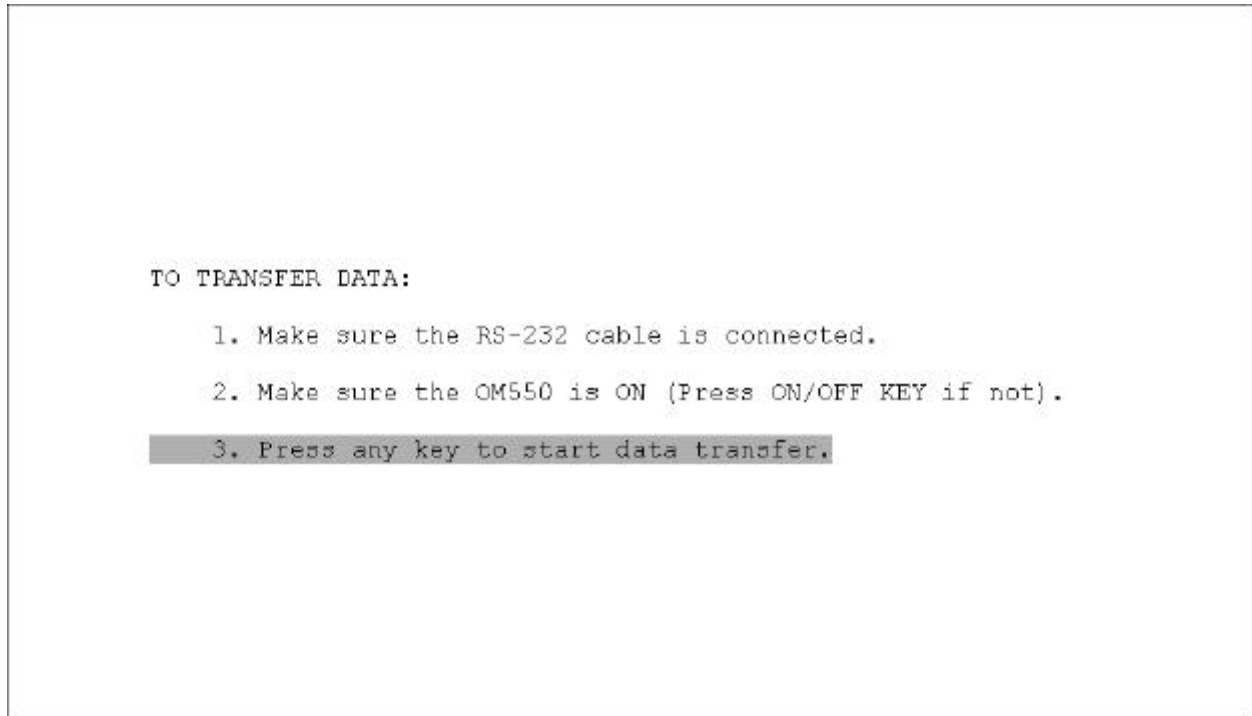

Data Transfer Screen

2. Press any key to start transferring data and the number of bytes being moved will appear on the screen. If the program detects any errors during the data transfer, an error message will appear.



If the same communication port is being used for both the mouse and OM-550, be sure to reconnect the mouse after the data has been read.

2.2 LOAD EXISTING LOG FILES

Option #2 *Load Existing LOG Files*, on the Master menu allows the user to load saved LOG files into the software program.

To load a LOG file:

1. Press the key and a list of saved experiment files will appear. The list includes the Log Interval used to acquire the data, the Date and Time when the last datapoint in the file was taken, the Number of data points in the file, and the Optional Plot Title assigned to the file (user configurable).

```
EXPERIMENT FILES ON DISK
File      Interval   Last Data Taken  Points   Plot Title
LOG006    00:00:10   14:22:51 08/14/99   00707
LOG005    00:00:10   15:20:18 12/11/99   00600
LOG004    00:00:01   19:00:12 05/21/99   00100
LOG003    00:00:05   10:46:48 11/02/99   00011
LOG002    00:00:01   12:15:55 10/13/99   02000
```

```
TYPE IN EXPERIMENT FILE NAME (e.g. LOG003) OR Esc IF NONE
LOG
```

Log Files Screen

2. At the prompt type a number of an experiment to load for example; LOG(003). If an incorrect entry is entered, an error message will appear.

2.3 MODIFY SOFTWARE CONFIGURATION

Option #3 *Modify Software Configuration*, on the Master menu allows the user to configure the system by selecting the serial port, printer, print orientation, company name, and next file number.



The choices made using this option will be automatically saved in a file named M51.CON when this screen is exited.

To make changes:

1. Press the **F3** key and a list of configuration items will appear.

```
Current Value: 2

SOFTWARE CONFIGURATION /LOG001

PC COM: Channel (1=COM1:,2=COM2:)      2
PRINTER (1=STD,2=CLR-1,3=CLR-2,4=LASER) 1
PRINTER (1=PORTRAIT,2=LANDSCAPE)      1
COMPANY                               Your Company Name
NEXT AVAILABLE FILE NUMBER             002

USE ↑ AND ↓ TO MOVE CURSOR      HIT RETURN TO CHANGE      Esc=MENU
```

Software Configuration Screen

2. To make new entries or change existing ones, use the up and down arrow keys to highlight the item to change. The new entry first appears on the line at the top of the screen, then it is copied to the highlighted area when you press [enter] and the highlight cursor will move down to the next item.

The following definitions explain what items can be configured using this screen.

- Select the PC COM: # (serial interface port #) that will be used to transfer data from the OM-550 to the computer. The available ports are COM1 and COM2.
- Select a Printer type, supported printers fall into one of four groups. See the README file for more details.
- Select paper orientation of printed data (Portrait or Landscape).
- Enter a Company name that will be included when you Print the data, List or save it as a Text file.
- The Next Available File Number determines the number assigned to the next saved file. The user can select the next file number that will be assigned to an experiment when it is saved. The software will then automatically increment the file number up one for each new experiment saved.



If an error has been made, use the Backspace key to remove it, and then re-enter a new selection.

3. When all the desired items have been entered, press the [esc] key and the selections will be automatically updated to the M51.CON file.

2.4 LIST DATA ON MONITOR

Option #4 *List Data on Monitor*, on the Master menu allows the user to view the experiment data in columnar format.

To list data:

1. Press the **[4]** key and experiment data will start scrolling vertically across the screen. To stop or start the data, press the Spacebar at any time. To increment individual data points one at a time, press an arrow key once.

```
OM550 Data Transfer
Your Company Name
Log Interval = 00:00:12
Time Stamp = 23:30:22 01/02/89
RejFreq = 6
Math Channel = Ch4-Ch5
Plot Title = OM550 Experiment
Note: Best Guess at Channel locations
Labels: 1. 2. 3.Room Temperature 4.Batt Volts 5.Regulator Volts 6.Diff
        Ch1      Ch2      Ch3      Ch4      Ch5      Ch6
TYPE    V        V        K        V        V        MATH
UNITS   V        V        F        V        V        V
M       +2.50000  +1.00000          +2.50000 +2.50000
B       +0000000  +0000000          +0000000 +0000000
  1     -0.1157  0.3087      42.8     5.2175  4.8517  0.3657
  2     -0.1412  0.2872      29.2     5.1993  4.8342  0.3650
  3     -0.1437  0.2846      25.1     5.1825  4.8183  0.3642
  4     -0.1450  0.2833      23.1     5.1705  4.8070  0.3635
  5     -0.1462  0.2819      21.8     5.1595  4.7965  0.3630
  6     -0.1473  0.2809      21.0     5.1500  4.7873  0.3628
  7     -0.1477  0.2800      20.3     5.1415  4.7793  0.3622
  8     -0.1485  0.2791      19.4     5.1340  4.7720  0.3620
  9     -0.1493  0.2783      19.4     5.1270  4.7653  0.3617
 10     -0.1505  0.2775      19.1     5.1217  4.7600  0.3618
Press any key to continue...ESC to abort
```

Listing Data

2. Press the **[esc]** key when finished viewing data.

2.5 PRINT DATA ON PRINTER

Option #5 *Print Data on Printer*, on the Master menu allows the user to print the data in columnar format on the selected printer as discussed in section 2.3 *MODIFY SOFTWARE CONFIGURATION*.

To print data:

1. Press the  key and the printing process will automatically start, when the data is done spooling the software will automatically return to the Master Menu.

2.6 SAVE TEXT FILE

Option #6 *Save Text File*, on the Master menu allows the user to save the currently loaded data as a text file suitable for direct import into a standard spreadsheet format.

To save data as text:

1. Press the  key and the data will automatically be saved to the same file name but with the file extension of (**.PRN**). For example if the loaded file name is LOG006.BIN the saved text file will be LOG006.PRN.



See • *File Formats* section or more information.

2.7 EDIT PLOT LABELS

Option #7 *Edit Plot Labels*, on the Master menu allows the user to choose Plot Labels for any OM-550 channel.

Plot Labels are text on the Hot Plot graph to identify the data from each individual channel, the graph Title or other notes about the data.

For example, Channel 1 might be labeled as “Boiler Room Temperature”. The label would be displayed near the channel 1 description on the Hot Plot screen.

To edit a plot label:

1. Press the  key and the Plot Label screen will appear.

```
Current Value: OM-550 Experiment .
-----
                        LABEL PLOT AND CHANNELS          /LOG006
-----

PLOT TITLE OM-550 Experiment

CHANNEL 1:
CHANNEL 2:
CHANNEL 3: Room Temperature
CHANNEL 4: Batt Volts
CHANNEL 5: Regulator Volts
CHANNEL 6: Diff

NOTE:      Best Guess at Channel locations

-----
USE ↑ AND ↓ TO MOVE CURSOR      HIT RETURN TO CHANGE      Esc=MENU
```

Plot Labels Screen

2. Enter the Plot title and channel labels by highlighting the text field and typing the desired text. Press the [enter] key to move to the next text field to enter a description. To skip a text field, press the up or down arrow key or press [esc] to exit the screen.

The Plot Title will appear at the top of the Hot Plot screen and the channel labels will appear at the bottom next to the appropriate channel number. Voltage channels display their m & b values if there is no Plot Label.

The Plot labels are saved in the experiment files, for later use. When new data is read from the OM-550, the software prompts the user if they want to use the existing Plot Labels. Select YES to use the labels or NO to erase any labels previously established.

2.8 HOT PLOT

Option #8 *HOT PLOT*, on the Master menu plots the experiment data in a graphical format and allows the user analyze the data.



The HOT PLOT screen is designed for use with either a mouse or a keyboard and this manual describes the functionality for both.

The HOT PLOT has the following features:

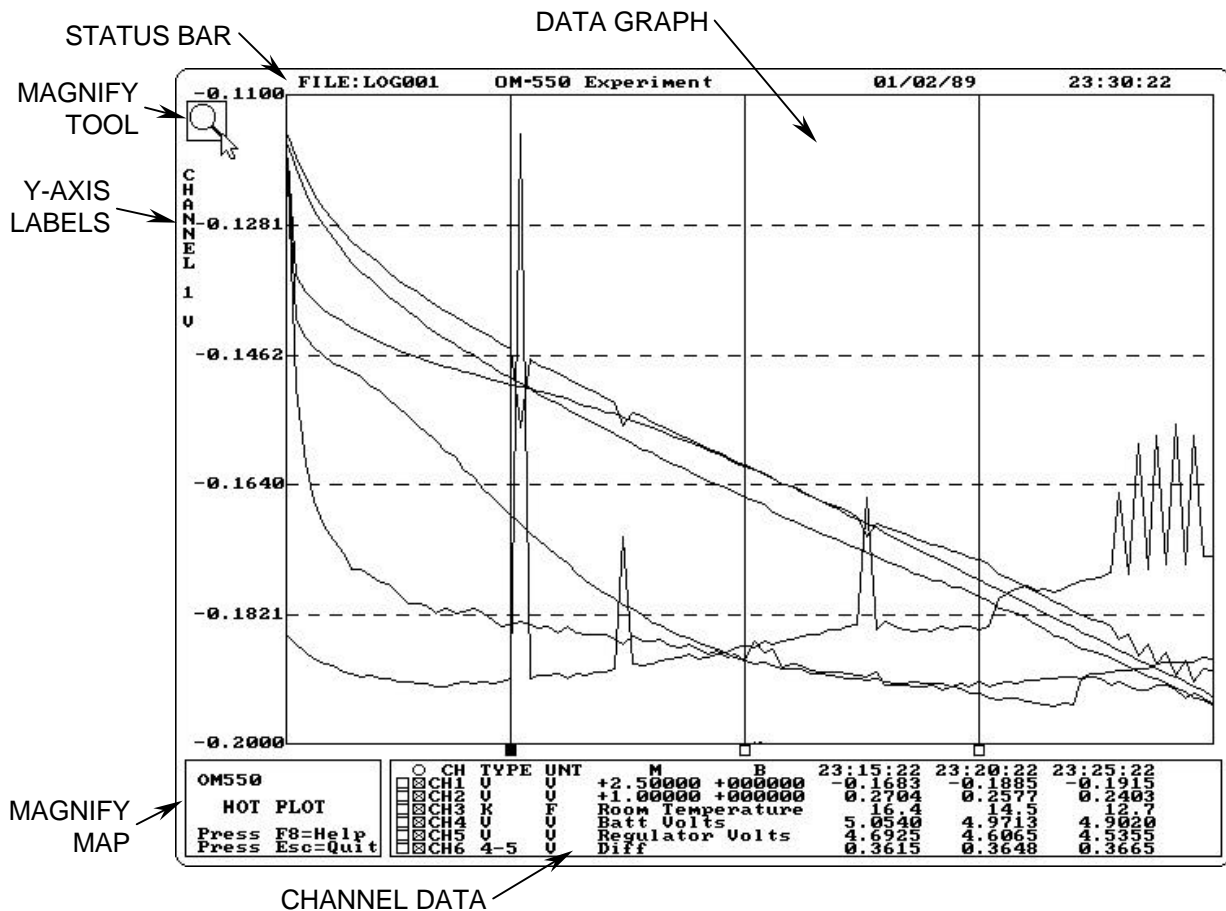

HOT PLOT Elements

2.8.1 STATUS BAR

The top of the Hot Plot shows the File Name, Plot Title, and Time Stamp/X-Y Readout.

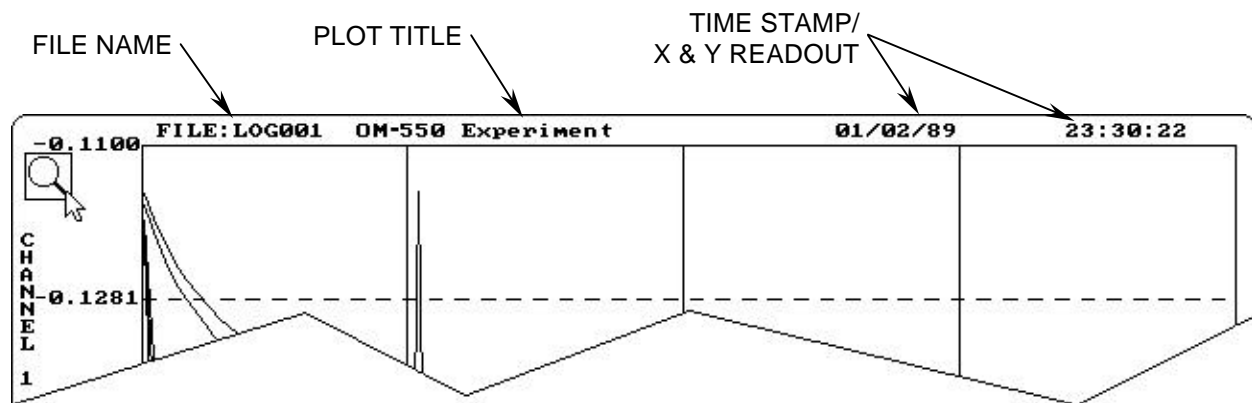

Status Bar

- The File name is the name of the currently loaded experiment file. If the current experiment data is not saved the file name will read "?????" in this location.
- The Plot Title is the entry specified by the user using the Edit Plot Labels option (See section 2.7 *EDIT PLOT LABELS* for details).
- The Time stamp is the data and time that the last reading was logged by the OM-550 during experiment.
- When the mouse pointer is placed over the Data Graph, the Time stamp is replaced by X & Y-axis data.

This is a fast way to get information from the Hot Plot graph because the user can use the mouse to read Times and Values anywhere on the plot.

The X and Y Readout shows the Day, Time, and Y-Axis Value at the place where the mouse pointer is currently positioned. The Day and Time are shown as D-HH:MM:SS. For example, **1-12:33:22** means day 1, 12 hours, 33 minutes, and 22 seconds.

If there are several channels of data on the graph, the Y-Axis Value belong to the channel identified by the Y-Axis Labels, along the left side of the graph. It will be the last channel selected. On color displays, the Plot and Labels will be the same color.

Screen resolution may limit the accuracy of these X-Y Readout Values to less than that of the actual data displayed in the X-Cursor Data Table near the bottom of the screen.

The X-Y Readout can also give Delta information: When using the Magnify Tool the absolute X-Y Values are replaced with Delta-X and Delta-Y Values which are the lengths of the sides of the magnification rectangle.

2.8.2 MAGNIFY TOOL

The Magnify tool enlarges any selected area of the graph for easy visual examination.

To Magnify a portion of the Data Graph:

1. Click the *Magnify* tool. A message box will appear below the Magnify Tool informing the user to: "*Click and drag to select area*".
2. Position the mouse pointer to select one corner of the desired area to enlarge.
3. Press the left mouse button and drag the pointer diagonally to the opposite corner of the box. An outline of the box appears as you drag.
5. Release the left mouse button when the outline of the area to be magnified is visible. The area inside the box is then magnified to fill the entire graph.

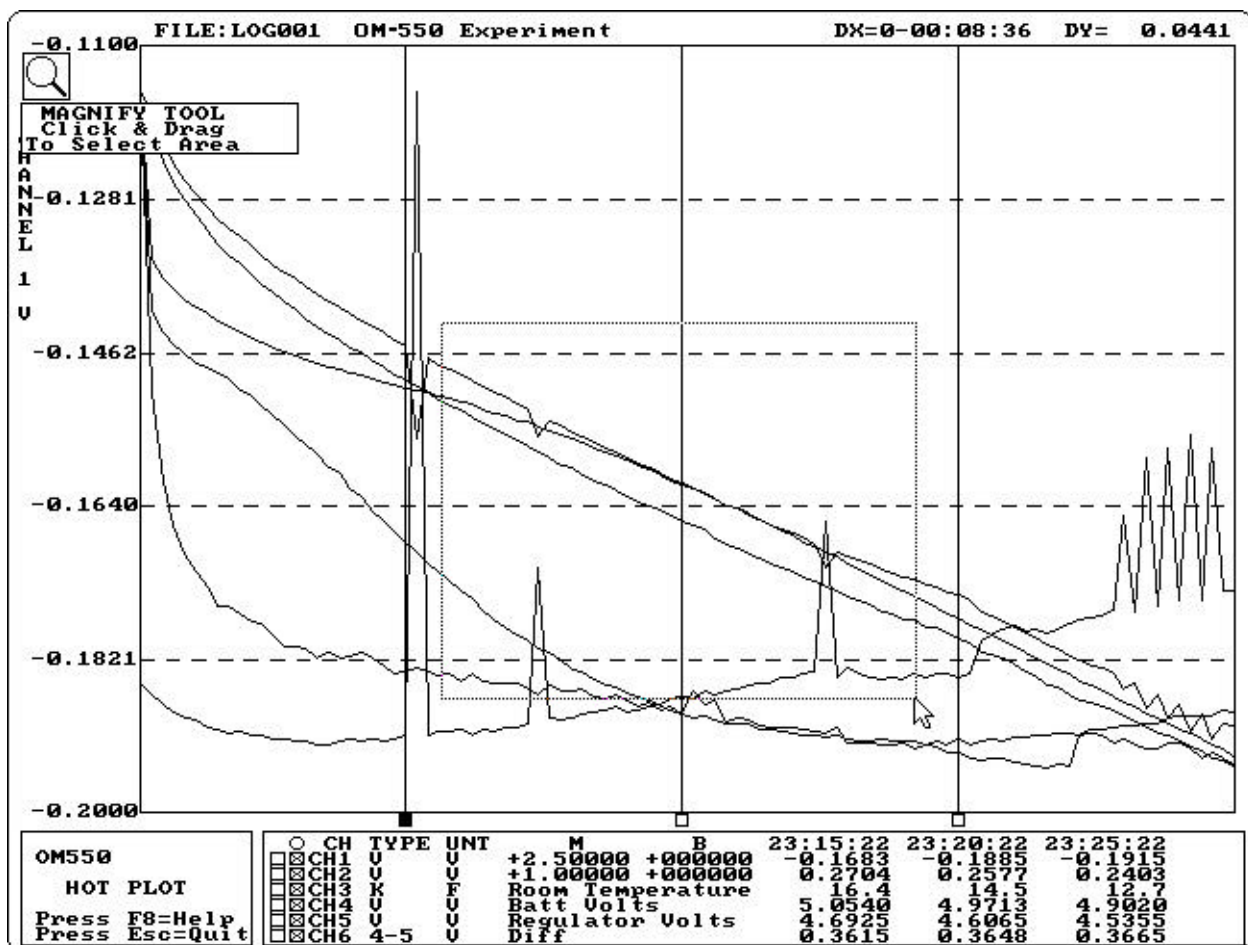

Magnify Tool

When using the Magnify tool, the Magnify Map indicates the area being magnified with red box drawn around the area currently being magnified. If the data graph was previously magnified, the current level of magnification is displayed as the smallest red box (Previous magnified areas are noted with a white outlined box).

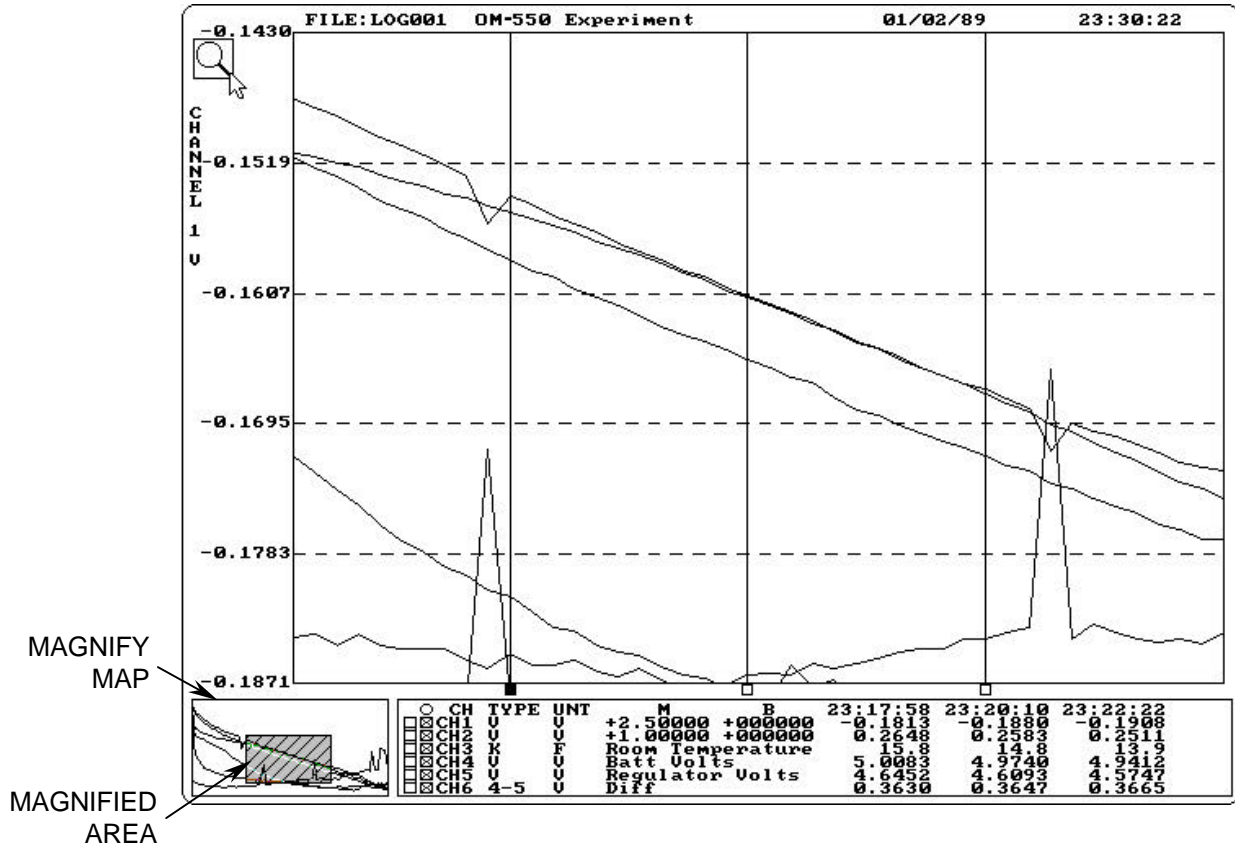

To return to the full view, click the Magnify Map outside of the magnified area.

To show even more detail in the Data Graph, Magnify can be performed multiple times. If the Magnify tool is used more than eight times the software will display a message box informing that too to many magnifications have been requested.



When the Magnify tool has been used multiple times, point to any box within the magnify map to go back to a previously selected level of magnification.

2.8.3 Y-AXIS LABELS

The Y-Axis labels (to the left of the Data Graph) include the channel number, range of values and units. If no channels are linked together, then the Y-Axis labels show the information for the last channel selected.

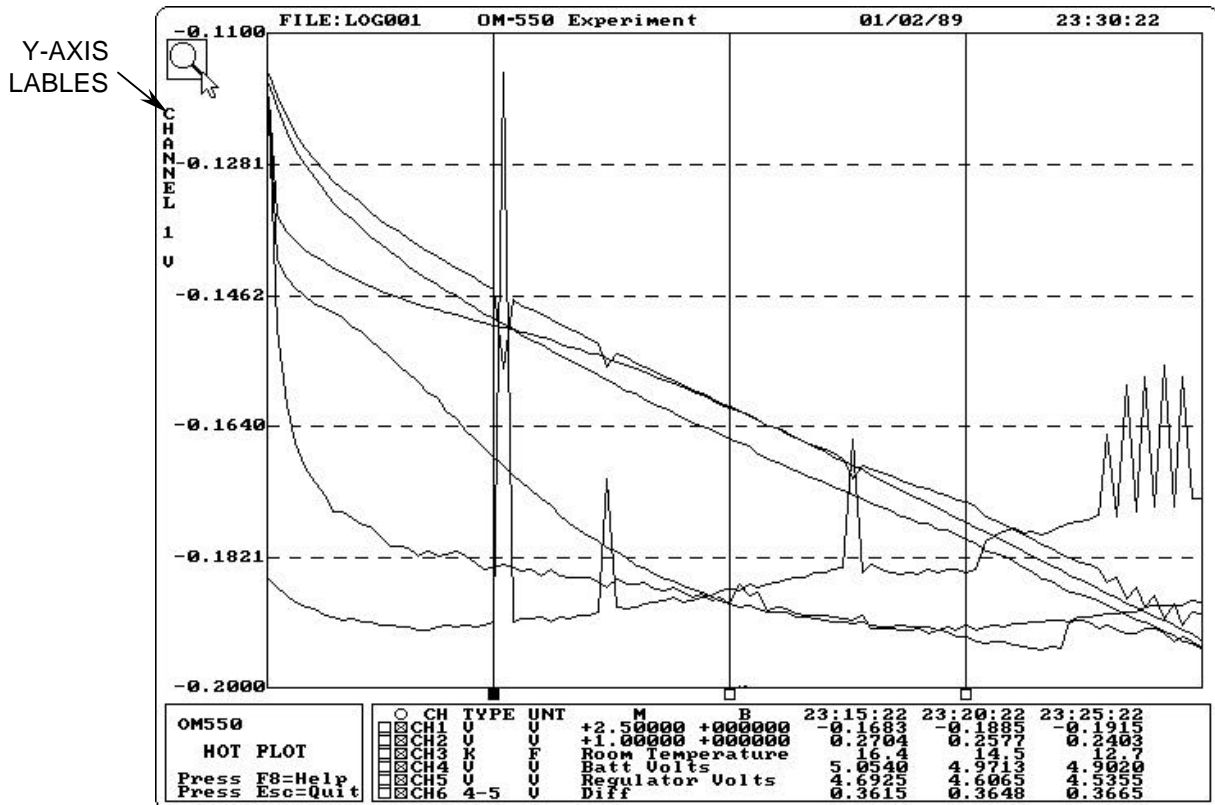

For example, if you plot channel #1, then add channel #2, the Y-Axis Labels will show the Channel #2 information. To display the Y-Axis Labels for channel #1, deselect then reselect that channel (See section 2.8.4 CHANNEL DATA for more details).

2.8.4 CHANNEL DATA

The Channel Data includes status boxes to show which channels are presently selected (graphed) and which are linked together on a common Y-Axis scale. The boxes in the right column show which channels are "Selected" and the boxes in the left column show which channels are "Linked" together. The boxes toggle between the selected and deselected.

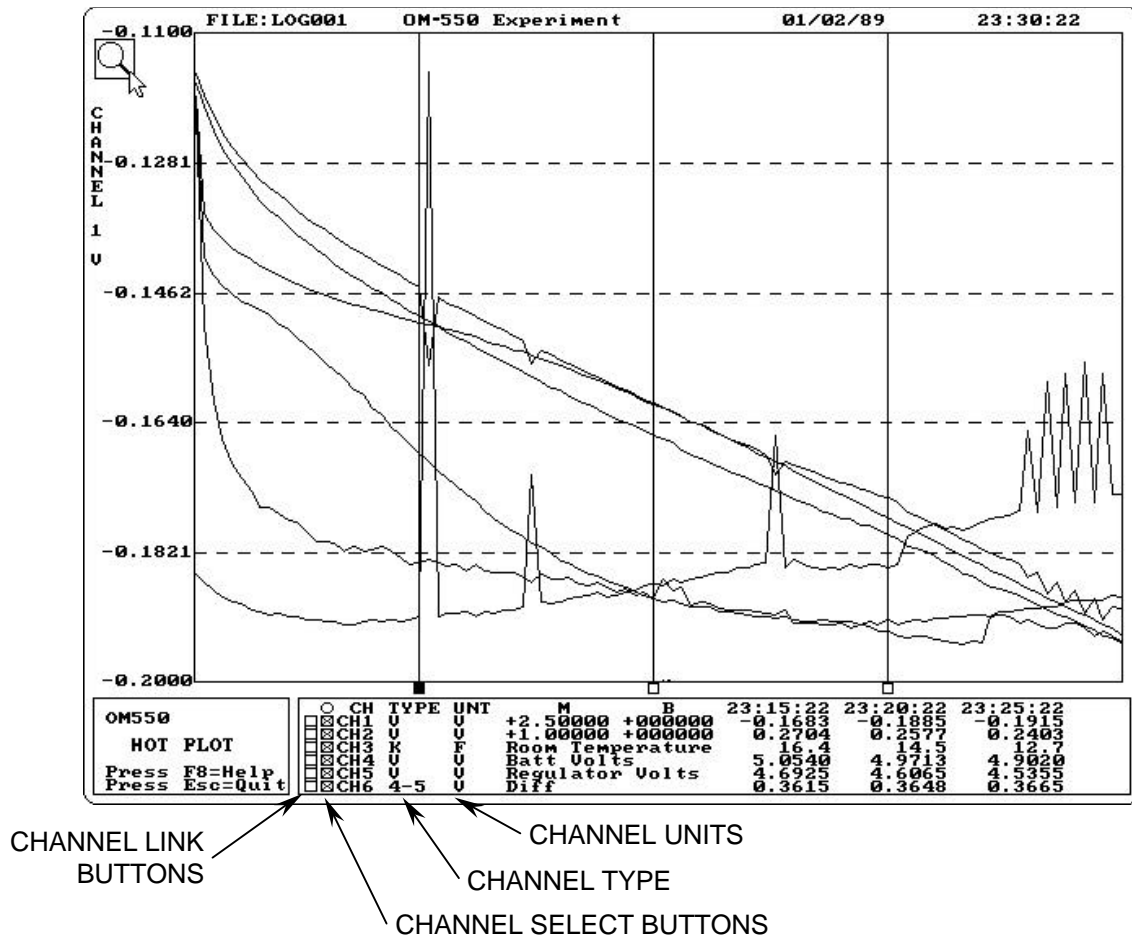

Channel Data

To select a channel to graph:

1. Click the Channel select button(s) with the mouse pointer or press a number key (1-6). For example press number key 3 to turn channel 3 ON or OFF.

The software initially expands each plot line (vertically) to fill the entire screen. All of the data can be seen but each channel is shown with a different Y-scale. To compare the plot lines from several channels on a common Y-scale, the lines must be linked together.

To link plot lines:

1. Determine which channels are displayed on common Y-Axis. Selected channels will be scaled together. The multi-channel select/deselect feature also works when linking channels.
2. Click the Channel link button(s) with the mouse pointer or press the [alt] key + a number key. For example press [alt+4] then [alt+5] to select channels 4 and 5 to be linked together.

The next two illustrations show channels 4 and 5 prior to linking, and the result of when the user has linked them together.

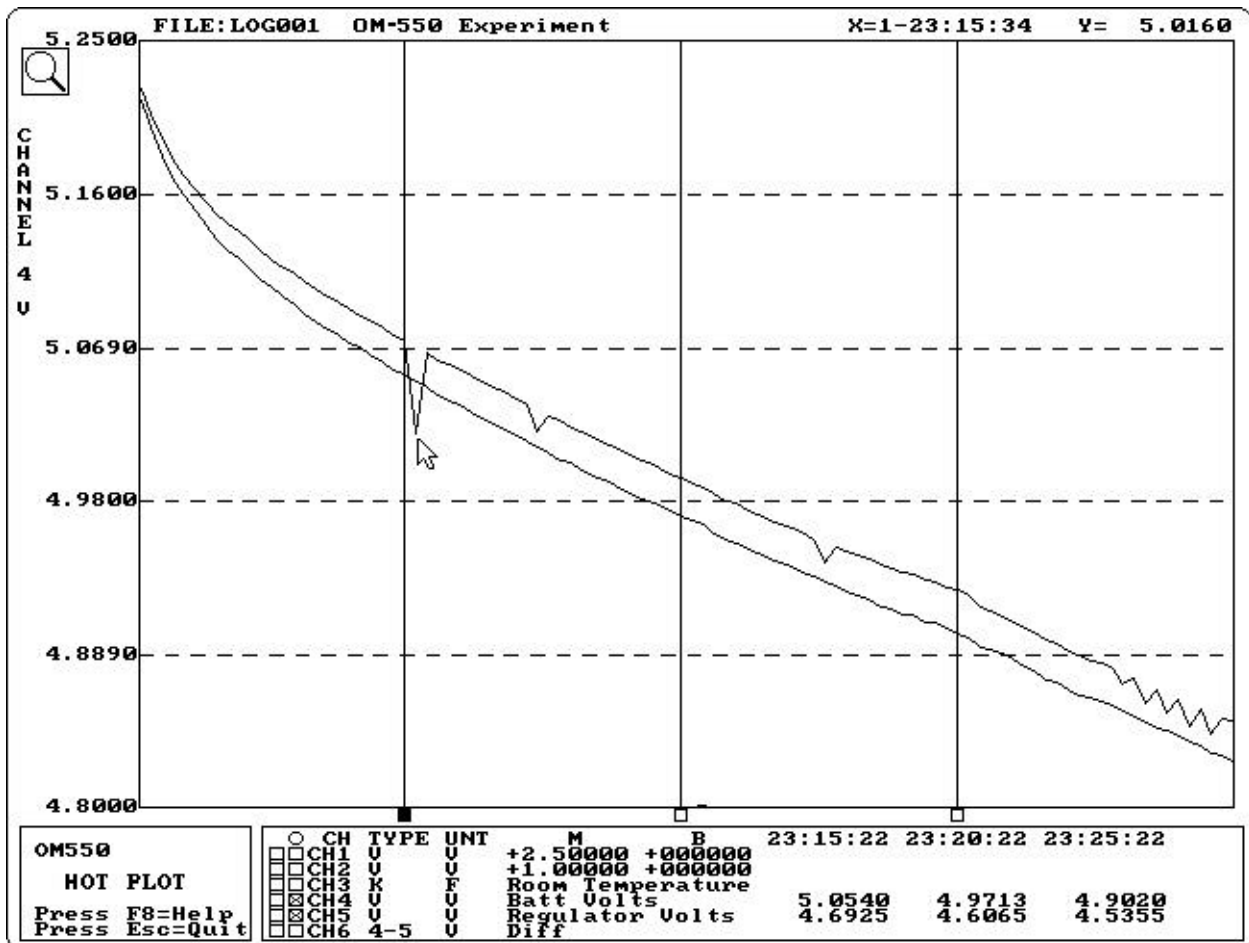

Channels 4 & 5 Before Linking

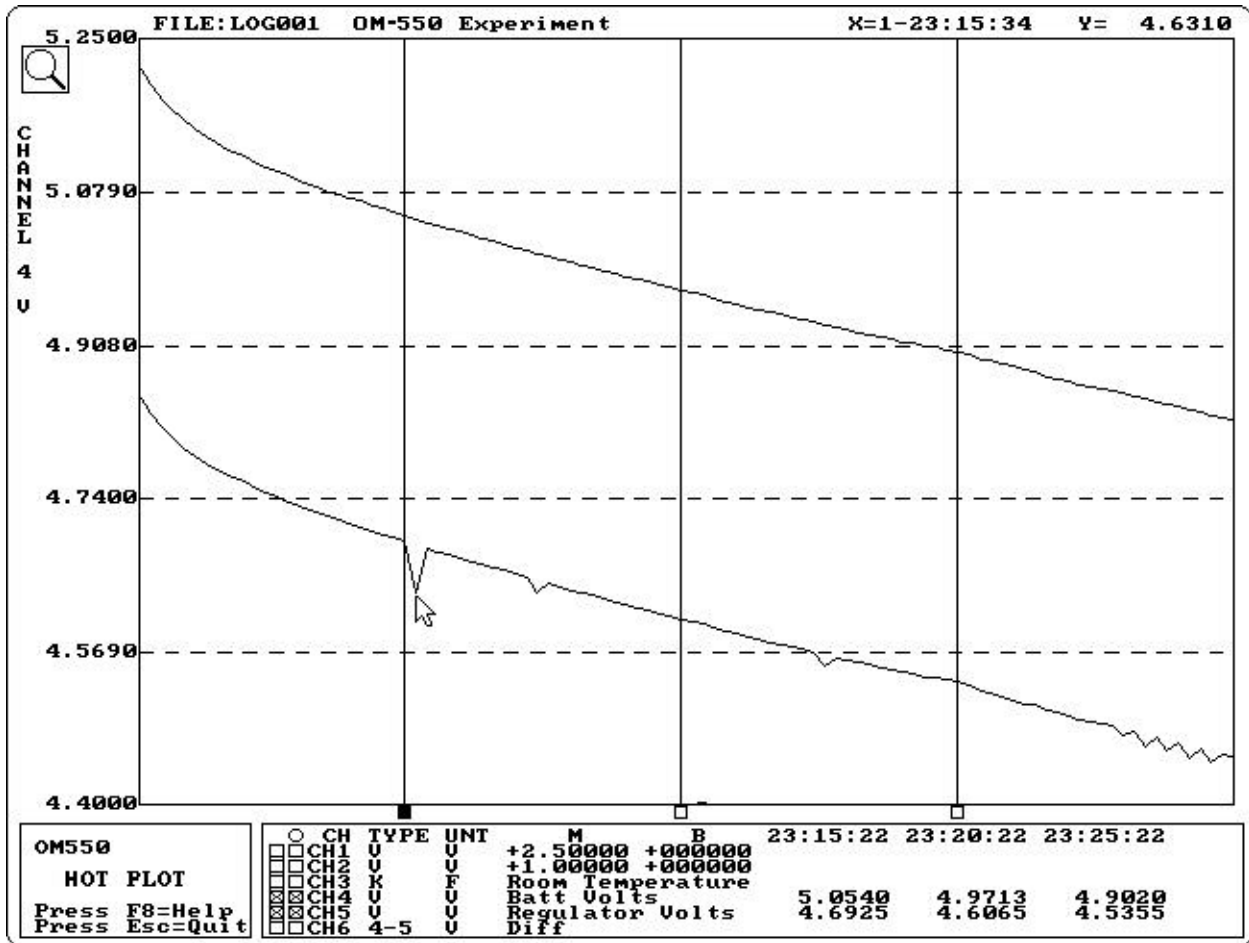

Channels 4 & 5 After Linking

2.8.5 DATA GRAPH

The Data Graph is where the data for each channel on the OM-550 is graphed in XY format. The Data Graph X (horizontal) axis represents time (or point #) and the Y (vertical) axis shows the values of the data points. The values are also shown in the X-cursor Data Table section of the Channel Data location.

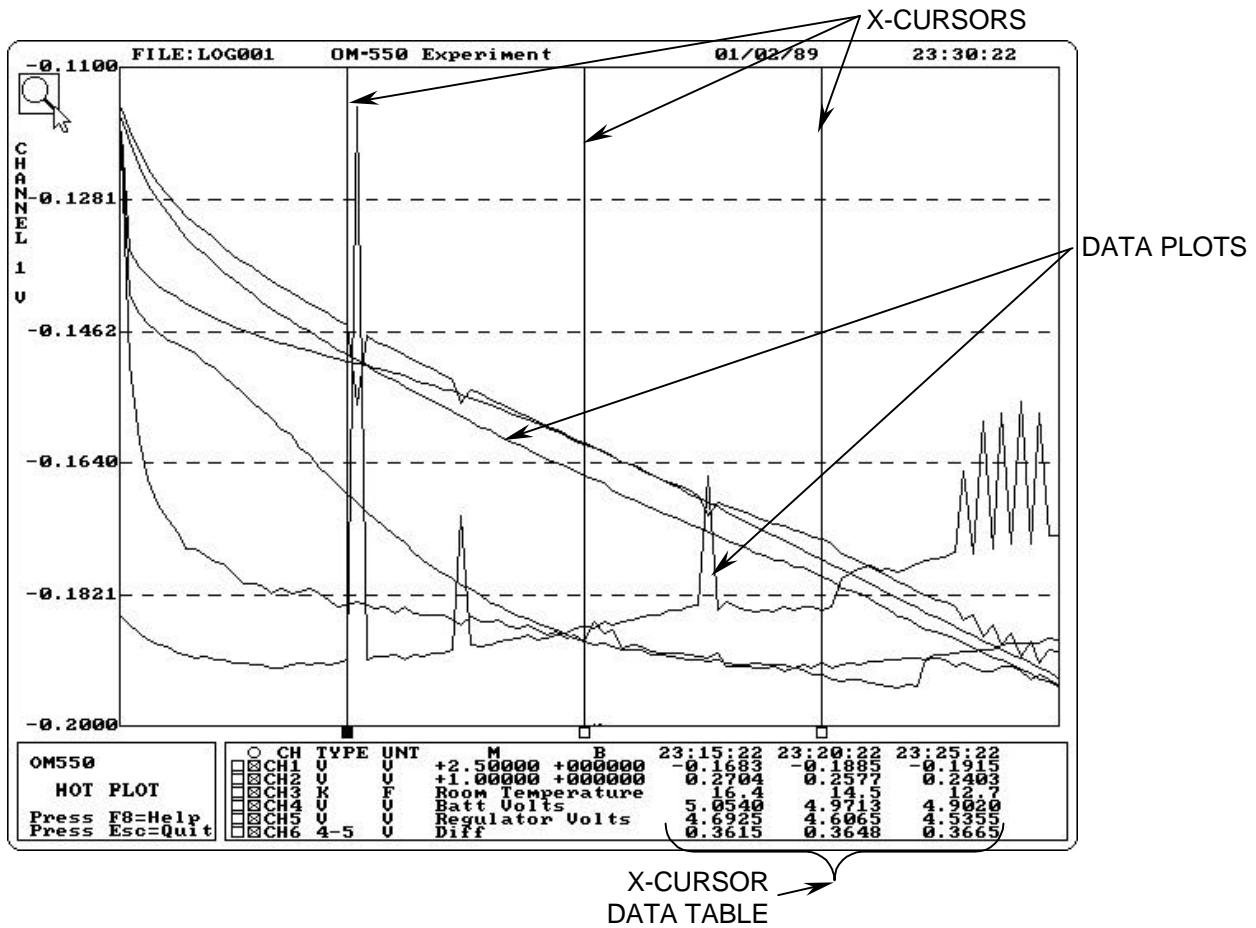

Data Graph

• Data Plots

The Data Plots in the Data Graph represent the data for each of the channels on the OM-550. Each channel is represented by a different color and corresponds to the color of its channel description in the X-Cursor Data Table

• X-Data Cursors

Three vertical cursors terminate in boxes along the X-Axis. Each cursor can be positioned anywhere on the graph.

• X-Cursor Data Table

Located on the right side of the Channel Data box includes the data for each X-Cursor. Each column shows the time (or point #) where the cursor is positioned and the data value on each active channel at that point. The position of an X-Cursor controls the X-values displayed in the X-Cursor Data Table. When an X-Cursor is moved, values in the X-Cursor Data Table (Time or point #) will automatically update.



Press the F9 key to toggle the X-Cursor Data Table for Time to Sample Point #.

To move X-cursor:

1. Position the mouse pointer over the small box below the vertical line and press and hold the left mouse button and drag it left or right releasing the mouse button when the X-Cursor is at the desired location.
- There is also an option to press a function key to select an X-cursor. For example, press **F2** to select the second X-cursor. When the desired X-cursor is selected the small box will turn red and then use the left or right arrow keys to move the selected X-cursor.



Moving the selected cursor can be pushed into other cursors causing them to move them along with it.

2.8.6 HELP MENU

Another feature of the HOT PLOT is the Help Menu. This menu lists all available Keyboard functions. Refer to *APPENDIX A: KEY FUNCTIONS* for more details.

To activate the Help menu:

1. Press the **F8** key and the Help menu will appear.
2. When finished, press the [esc] key to close.

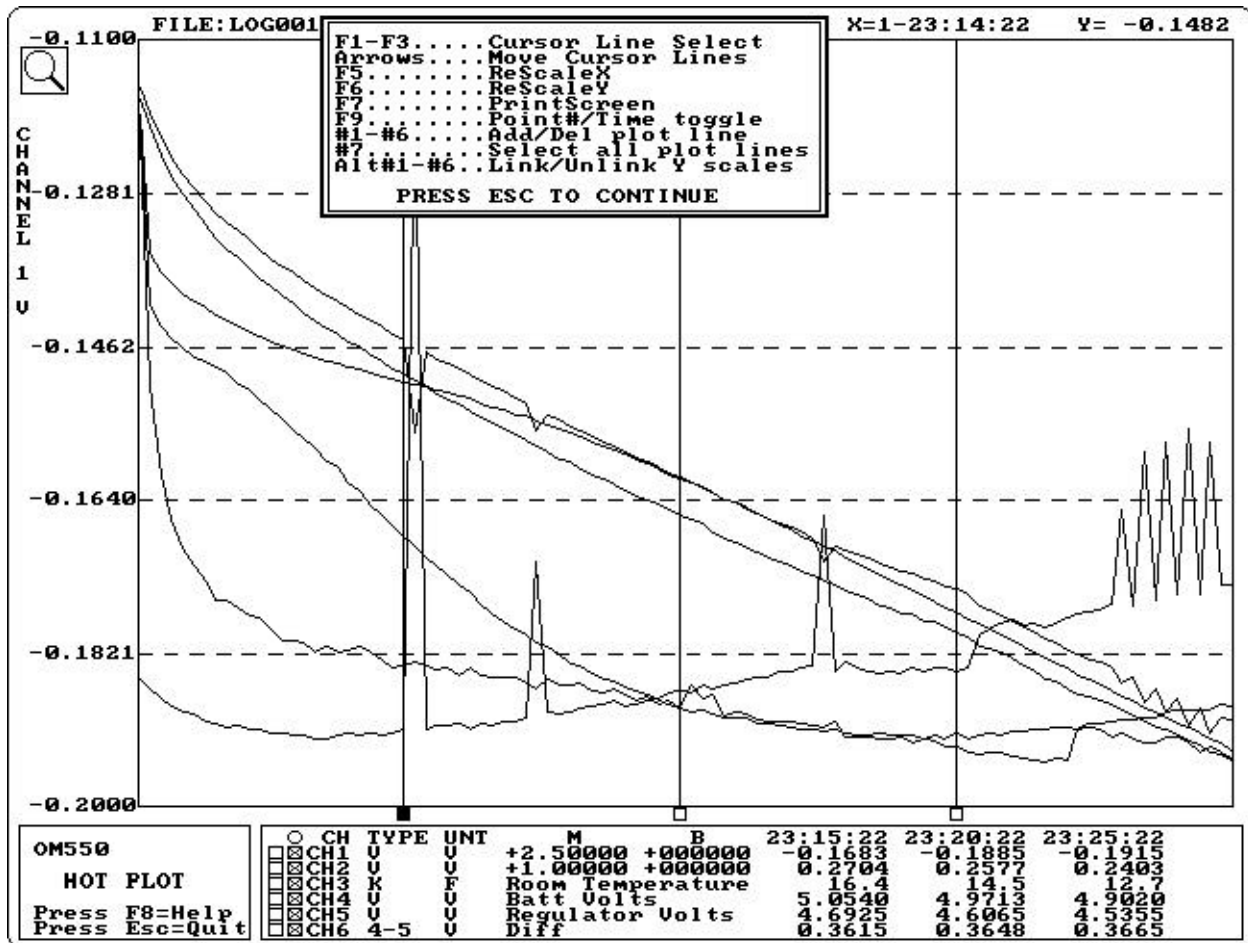

Help Menu

2.9 LIST EXISTING LOG FILES ON PRINTER

Option #9 *List Existing Log Files on Printer*, on the Master Menu prints the saved LOG files to the printer. Set the printer up using Option #3 Modify Software Configure.

To list log files:

1. Press the  key, and the printing process will start. When it is finished spooling the program will automatically return to the Master Menu.

2.10 QUIT

Option #10 *Quit*, on the Master menu quits the software program.

To quit:

1. Press , if the data has not been saved the software program will prompt the user to save it. If you want to save press "Y" for Yes and "N" for no.

APPENDIX A: KEY FUNCTIONS

There are several keys used to control functions on the HOT PLOT screen the keys and functions they control are listed below.



Selects X-Cursor #1



Toggles Channel 1 (ON/OFF)



Selects X-Cursor #2



Toggles Channel 2 (ON/OFF)



Selects X-Cursor #3



Toggles Channel 3 (ON/OFF)



Selects X (horizontal) zoom zone



Toggles Channel 4 (ON/OFF)



Selects Y (vertical) zoom zone



Toggles Channel 5 (ON/OFF)



Prints Screen



Toggles Channel 6 (ON/OFF)



Help Menu



Toggles X-Cursor Data (Time/Point #)



Toggles Channel 1 (ON/OFF) for Linking



Toggles Channel 2 (ON/OFF) for Linking



Toggles Channel 3 (ON/OFF) for Linking



Toggles Channel 4 (ON/OFF) for Linking



Toggles Channel 5 (ON/OFF) for Linking



Toggles Channel 6 (ON/OFF) for Linking

Free Manuals Download Website

<http://myh66.com>

<http://usermanuals.us>

<http://www.somanuals.com>

<http://www.4manuals.cc>

<http://www.manual-lib.com>

<http://www.404manual.com>

<http://www.luxmanual.com>

<http://aubethermostatmanual.com>

Golf course search by state

<http://golfingnear.com>

Email search by domain

<http://emailbydomain.com>

Auto manuals search

<http://auto.somanuals.com>

TV manuals search

<http://tv.somanuals.com>