

Where Do I Find Everything I Need for Process Measurement and Control? OMEGA...Of Course!

TEMPERATURE

- ☑ Thermocouple, RTD & Thermistor Probes, Connectors, Panels & Assemblies
- ☑ Wire: Thermocouple, RTD & Thermistor
- ☑ Calibrators & Ice Point References
- ☑ Recorders, Controllers & Process Monitors
- ☑ Infrared Pyrometers

PRESSURE, STRAIN AND FORCE

- ☑ Transducers & Strain Gauges
- ☑ Load Cells & Pressure Gauges
- ☑ Displacement Transducers
- ☑ Instrumentation & Accessories

FLOW/LEVEL

- ☑ Rotameters, Gas Mass Flowmeters & Flow Computers
- ☑ Air Velocity Indicators
- ☑ Turbine/Paddlewheel Systems
- ☑ Totalizers & Batch Controllers

pH/CONDUCTIVITY

- ☑ pH Electrodes, Testers & Accessories
- ☑ Benchtop/Laboratory Meters
- ☑ Controllers, Calibrators, Simulators & Pumps
- ☑ Industrial pH & Conductivity Equipment

DATA ACQUISITION

- ☑ Data Acquisition & Engineering Software
- ☑ Communications-Based Acquisition Systems
- ☑ Plug-in Cards for Apple, IBM & Compatibles
- ☑ Datalogging Systems
- ☑ Recorders, Printers & Plotters

HEATERS

- ☑ Heating Cable
- ☑ Cartridge & Strip Heaters
- ☑ Immersion & Band Heaters
- ☑ Flexible Heaters
- ☑ Laboratory Heaters

ENVIRONMENTAL MONITORING AND CONTROL

- ☑ Metering & Control Instrumentation
- ☑ Refractometers
- ☑ Pumps & Tubing
- ☑ Air, Soil & Water Monitors
- ☑ Industrial Water & Wastewater Treatment
- ☑ pH, Conductivity & Dissolved Oxygen Instruments

M-3949/0403

User's Guide



<http://www.omega.com>
e-mail: info@omega.com

LVP-51 Series Non-Intrusive Capacitance Switch

WARRANTY/ DISCLAIMER

OMEGA ENGINEERING, INC. warrants this unit to be free of defects in materials and workmanship for a period of 12 months from date of purchase. OMEGA's Warranty adds an additional one (1) month grace period to the normal one (1) year product warranty to cover handling and shipping time. This ensures that OMEGA's customers receive maximum coverage on each product.

If the unit malfunctions, it must be returned to the factory for evaluation. OMEGA's Customer Service Department will authorize Return (AR) number immediately upon phone or written request. Upon OMEGA's Warranty does not apply to defects resulting from any action of the purchaser, including but not limited to mishandling, improper interfacing, operation outside of design limits, improper repair, or unauthorized modification. This WARRANTY is VOID if the unit shows evidence of having been tampered with or shows evidence of having been damaged as a result of excessive corrosion, or current, heat, moisture or vibration; improper specification, misapplication, misuse or other operating conditions outside of OMEGA's control. Components which wear are not warranted, including but not limited to contact points, fuses, and brass.

OMEGA is pleased to offer suggestions on the use of its various products. However, OMEGA neither assumes responsibility for any omissions or errors nor assumes liability for any damages that result from the use of its products in accordance with information provided by OMEGA, either verbal or written. OMEGA warrants only that the parts manufactured by it will be as specified and free of defects. OMEGA MAKES NO OTHER WARRANTIES OR REPRESENTATIONS OF ANY KIND WHATSOEVER, EXPRESS OR IMPLIED, EXCEPT THAT OF TITLE, AND ALL IMPLIED WARRANTIES INCLUDING MERCHANTABILITY AND FITNESS FOR A PARTICULAR PURPOSE ARE HEREBY DISCLAIMED. LIMITATION OF LIABILITY: THIS AGREEMENT FOR A COMPONENT under 10 CFR 21 (NRC), used in or with any nuclear installation or activity, or (2) in medical applications or used on humans, should any Product(s) used in or with any nuclear installation or activity, or (2) in medical applications, shall not exceed the purchase price of the component upon which liability is based. In no event shall OMEGA be liable for consequential, incidental or special damages.

CONDITIONS: Equipment sold by OMEGA is not intended to be used, nor shall it be used, (1) as a "basic component" used in or with any nuclear installation or activity, or (2) in medical applications or used on humans, should any Product(s) used in or with any nuclear installation or activity, or (2) in medical applications, shall not exceed the purchase price of the component upon which liability is based. In our basic WARRANTY/DISCLAIMER language, and additionally, purchaser will indemnify OMEGA and hold OMEGA harmless from any liability or damage whatsoever arising out of the use of the Product(s) in such a manner.

RETURN REQUESTS/INQUIRIES

Direct all warranty and repair requests/inquiries to the OMEGA Customer Service Department. BEFORE NUMBER FROM OMEGA'S CUSTOMER SERVICE DEPARTMENT (IN ORDER TO AVOID PROCESSING DELAYS). The assigned AR number should then be marked on the outside of the return package and on any correspondence. The purchaser is responsible for shipping charges, freight, insurance and proper packaging to prevent breakage in transit.

FOR NON-WARRANTY REPAIRS, please have the following information available BEFORE contacting OMEGA:

1. Purchase Order number under which the product was PURCHASED.
2. Model and serial number of the product under warranty, and
3. Repair instructions and/or specific problems relative to the product.

OMEGA's policy is to make tuning changes, not model changes, whenever an improvement is possible. This affords our customers the latest in technology and engineering.

OMEGA is a registered trademark of OMEGA ENGINEERING, INC. All rights reserved. This document may not be copied, photocopied, reproduced, translated, or reduced to any electronic medium or machine-readable form, in whole or in part, without the prior written consent of OMEGA ENGINEERING, INC.

FOR NON-WARRANTY REPAIRS, please have the following information available BEFORE contacting OMEGA:

1. Purchase Order number under which the product was PURCHASED.
2. Model and serial number of the product, and
3. Repair instructions and/or specific problems relative to the product.

OMEGA's policy is to make tuning changes, not model changes, whenever an improvement is possible. This affords our customers the latest in technology and engineering.

OMEGA is a registered trademark of OMEGA ENGINEERING, INC. All rights reserved. This document may not be copied, photocopied, reproduced, translated, or reduced to any electronic medium or machine-readable form, in whole or in part, without the prior written consent of OMEGA ENGINEERING, INC.

FOR NON-WARRANTY REPAIRS, please have the following information available BEFORE contacting OMEGA:

1. Purchase Order number under which the product was PURCHASED.
2. Model and serial number of the product, and
3. Repair instructions and/or specific problems relative to the product.

OMEGA's policy is to make tuning changes, not model changes, whenever an improvement is possible. This affords our customers the latest in technology and engineering.

OMEGA is a registered trademark of OMEGA ENGINEERING, INC. All rights reserved. This document may not be copied, photocopied, reproduced, translated, or reduced to any electronic medium or machine-readable form, in whole or in part, without the prior written consent of OMEGA ENGINEERING, INC.

FOR NON-WARRANTY REPAIRS, please have the following information available BEFORE contacting OMEGA:

1. Purchase Order number under which the product was PURCHASED.
2. Model and serial number of the product, and
3. Repair instructions and/or specific problems relative to the product.

OMEGA's policy is to make tuning changes, not model changes, whenever an improvement is possible. This affords our customers the latest in technology and engineering.

OMEGA is a registered trademark of OMEGA ENGINEERING, INC. All rights reserved. This document may not be copied, photocopied, reproduced, translated, or reduced to any electronic medium or machine-readable form, in whole or in part, without the prior written consent of OMEGA ENGINEERING, INC.

FOR NON-WARRANTY REPAIRS, please have the following information available BEFORE contacting OMEGA:

1. Purchase Order number under which the product was PURCHASED.
2. Model and serial number of the product, and
3. Repair instructions and/or specific problems relative to the product.

OMEGA's policy is to make tuning changes, not model changes, whenever an improvement is possible. This affords our customers the latest in technology and engineering.

OMEGA is a registered trademark of OMEGA ENGINEERING, INC. All rights reserved. This document may not be copied, photocopied, reproduced, translated, or reduced to any electronic medium or machine-readable form, in whole or in part, without the prior written consent of OMEGA ENGINEERING, INC.

FOR NON-WARRANTY REPAIRS, please have the following information available BEFORE contacting OMEGA:

1. Purchase Order number under which the product was PURCHASED.
2. Model and serial number of the product, and
3. Repair instructions and/or specific problems relative to the product.

OMEGA's policy is to make tuning changes, not model changes, whenever an improvement is possible. This affords our customers the latest in technology and engineering.

OMEGA is a registered trademark of OMEGA ENGINEERING, INC. All rights reserved. This document may not be copied, photocopied, reproduced, translated, or reduced to any electronic medium or machine-readable form, in whole or in part, without the prior written consent of OMEGA ENGINEERING, INC.

FOR NON-WARRANTY REPAIRS, please have the following information available BEFORE contacting OMEGA:

1. Purchase Order number under which the product was PURCHASED.
2. Model and serial number of the product, and
3. Repair instructions and/or specific problems relative to the product.

OMEGA's policy is to make tuning changes, not model changes, whenever an improvement is possible. This affords our customers the latest in technology and engineering.

OMEGA is a registered trademark of OMEGA ENGINEERING, INC. All rights reserved. This document may not be copied, photocopied, reproduced, translated, or reduced to any electronic medium or machine-readable form, in whole or in part, without the prior written consent of OMEGA ENGINEERING, INC.

FOR NON-WARRANTY REPAIRS, please have the following information available BEFORE contacting OMEGA:

1. Purchase Order number under which the product was PURCHASED.
2. Model and serial number of the product, and
3. Repair instructions and/or specific problems relative to the product.

OMEGA's policy is to make tuning changes, not model changes, whenever an improvement is possible. This affords our customers the latest in technology and engineering.

OMEGA is a registered trademark of OMEGA ENGINEERING, INC. All rights reserved. This document may not be copied, photocopied, reproduced, translated, or reduced to any electronic medium or machine-readable form, in whole or in part, without the prior written consent of OMEGA ENGINEERING, INC.

FOR NON-WARRANTY REPAIRS, please have the following information available BEFORE contacting OMEGA:

1. Purchase Order number under which the product was PURCHASED.
2. Model and serial number of the product, and
3. Repair instructions and/or specific problems relative to the product.

OMEGA's policy is to make tuning changes, not model changes, whenever an improvement is possible. This affords our customers the latest in technology and engineering.

OMEGA is a registered trademark of OMEGA ENGINEERING, INC. All rights reserved. This document may not be copied, photocopied, reproduced, translated, or reduced to any electronic medium or machine-readable form, in whole or in part, without the prior written consent of OMEGA ENGINEERING, INC.

FOR NON-WARRANTY REPAIRS, please have the following information available BEFORE contacting OMEGA:

1. Purchase Order number under which the product was PURCHASED.
2. Model and serial number of the product, and
3. Repair instructions and/or specific problems relative to the product.

OMEGA's policy is to make tuning changes, not model changes, whenever an improvement is possible. This affords our customers the latest in technology and engineering.

OMEGA is a registered trademark of OMEGA ENGINEERING, INC. All rights reserved. This document may not be copied, photocopied, reproduced, translated, or reduced to any electronic medium or machine-readable form, in whole or in part, without the prior written consent of OMEGA ENGINEERING, INC.

WARNING: These products are not designed for use in, and should not be used for, human applications. OMEGA contains and reserves the right to alter specifications without notice.

The information contained in this document is believed to be correct, but OMEGA Engineering, Inc. accepts no liability for any errors it may have made. Add the CE mark to every appropriate device upon certification.

It is the policy of OMEGA to comply with all worldwide safety and EMC/EMI regulations that apply. OMEGA is constantly pursuing certification of its products to the European New Approach Directives. OMEGA will add the CE mark to every appropriate device upon certification.

United Kingdom: ISO 9002 Certified

Germany/Austria:
Danklstrasse 26, D-75392
Deckenpfonten, Germany
Tel: +49 (0)7056 9398-0
FAX: +49 (0)7056 9398-29
Toll Free in Germany: 0800 659 7678
e-mail: info@omega.de

United Kingdom:
One Omega Drive
River Bend Technology Centre
Northbank, Hram
Manchester M14 5BD
United Kingdom
Tel: +44 (0)161 777 6611
FAX: +44 (0)161 777 6622
Toll Free in United Kingdom:
0800-488-488
e-mail: sales@omega.co.uk

Czech Republic:
Fyzická 184/46, 733 01 Karvina, Czech Republic
Tel: +420 (0)59 6311899
FAX: +420 (0)59 6311814
Toll Free: 0800-1-66342
e-mail: info@omegashop.cz

France:
11, rue Jacques Cartier
78280 Cayenne, France
Tel: +33 (0)1 61 37 29 00 FAX: +33 (0)1 30 57 54 27
Toll Free in France: 0800 466 342
e-mail: sales@omega.fr

Benelux:
Postbus 8034, 1180 LA Amsterdam
The Netherlands
Tel: +31 (0)20 342121 FAX: +31 (0)20 6434643
Toll Free in Benelux: 0800 0993344
e-mail: sales@omegagroup.nl

Servicing Europe:

USA and Canada:
Sales Service: 1-800-826-6342 / 1-800-TC-OMEGA®
Customer Service: 1-800-622-2378 / 1-800-622-BEST®
EM Espanol: (001) 203-359-7807
FAX: (001) 203-359-7807
e-mail: espanol@omega.com
info@omega.com.mx

For immediate technical or application assistance:

Canada:
One Omega Drive, Box 4047
Stamford CT 06907-0047
Tel: (203) 359-1660
FAX: (203) 359-7700
e-mail: info@omega.com

Servicing North America:

OMEGA.net® On-Line Service
www.omega.com
Internet e-mail: info@omega.com



SPECIFICATIONS

Step One

Tank mounting:	Non-intrusive
Tank mat. comp.:	Non-metallic
Tank wall thick.:	< 1" (25 mm)
Accuracy:	± 1 mm in water
Repeatability:	± 0.5 mm in water
Dielectric range:	> 10 constants
Conductive range:	> 100 micromhos
Supply voltage:	12-36 VDC
Consumption:	25 mA maximum
Contact type:	(1) SPST relay
Contact rating:	120 VAC/VDC @ 1A (CE: 60 VAC/VDC @ 1A)
Contact output:	Selectable NO/NC
Process temp.:	F: -40° to 194° C: -40° to 90°
Enclosure rating:	NEMA 4X (IP65)
Enclosure mat.:	PSO
Conduit entrance:	Single, 1/2" NPT
Bracket material:	PE
Bracket mounting:	3M adhesive / plastic thermal weld
Cable jacket mat.:	PP
Cable type:	4-conductor, #22 AWG (shielded)
Cable length:	Standard: 10' (3m)
Classification:	General purpose
CE compliance:	EN 50082-2 immunity EN 55011 emission EN 61010-1 safety

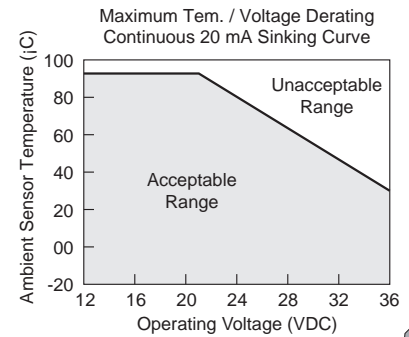
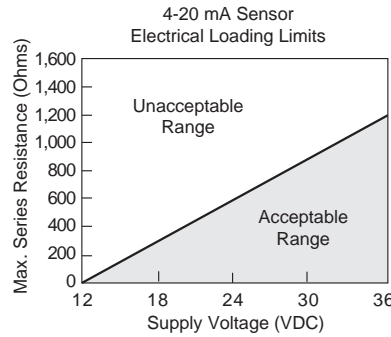

Technology:

The non-intrusive RF capacitance switch detects the presence of liquid or air by measuring the conductive or dielectric values which are present in all materials. An electrical capacitor is formed between the level switch and the outer tank wall. As liquid rises and falls against the inner wall, the capacitance effect is greatly increased and the 1A SPST relay changes state.

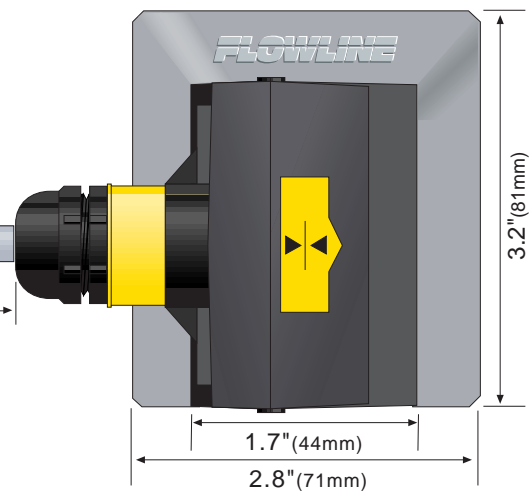
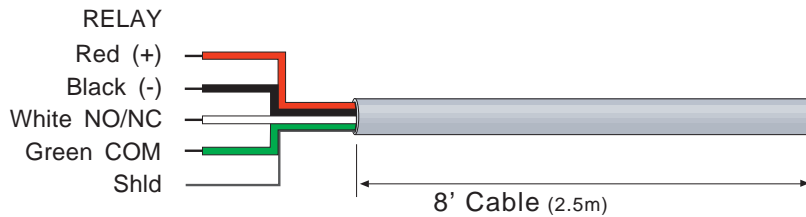
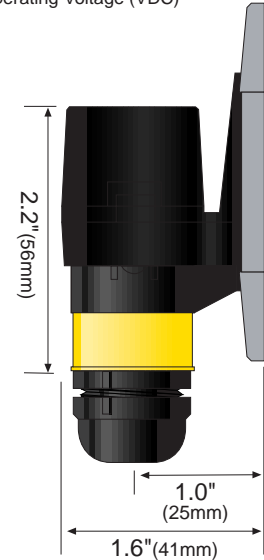

Table of Common Dielectric Constants:

NOTE: Liquids with a conductivity value > 100 μU are fine if coating is not an issue. Liquids with a dielectric constant less than 20 may not be reliably detected by an LVP-51 series level switch, depending on conditions.

Acetone	21	Chlorobenzene	4.7 to 6	Ethylene dichloride		Gasoline	2 to 2.2	Nitrobenzene	26 to 35	Trichloroethylene	3.4
Acetaldehyde	22.2	Chlorotoluene	4.7		11 to 17	Hydrochloric acid	4.6	Nitrotoluene	25	Trichloroacetic acid	4.5
Acetyl methyl hexyl ketone	28	Chloroform	4.5 to 5.0	Ethylene chloride	10.5	Isobutyric acid	2.7	Naphthalene	2.3 to 2.5	Terephthalic acid	
Alcohol	16 to 31	Chlorine, liquid	2.0	Ethyl acetate	6.4	Isobutyl methyl ketone	13	Oils, vegetable	2.5 to 3.5		1.5 to 1.7
Ammonia	15 to 25	Carbon tetrachloride	2.2	Ethyl salicylate	8.6	Jet fuel	1.7	Oils, mineral	2.3 to 2.4	Thinner	3.7
Acetic acid	4.1 to 6.2	Cyan	2.6	Ethyl stearate	2.9	Lead carbonate	18	Oils, petroleum	1.8 to 2.2	Urea	3.5
Butyl chloride	9.6	Cyclohexanemethanol	3.7	Ethyl silicote	4.1	Lead nitrate	38	Oleic acid	2.5	Vinyl chloride	2.8 to 6
Barium chloride	9 to 11	D.I. Water	20	Formic acid	59	Methyl salicylate	9.0	Propane, liquid	1.8 to 1.9	Vinyl alcohol	1.8 to 2.0
Benzene	2.3	Ethyl toluene	2.2	Ferric oleate	2.6	Methanol	33	Potassium nitrate		Water, 20°C	80
Benzine	2.3	Ethyl alcohol	23	Freon	2.2	Methyl alcohol	33 to 38		5.0 to 5.9	Water, 100°C	48
Barium nitrate	5.6	Ethylene glycol	37	Glycerine	47	Margarine, liquid	2.8 to 3.2	Potassium chloride	5.0		
Bromine	3.1	Ethylene oxide	14	Glycol	30	Methyl acetate	7.3	Stearic acid	2.3		
				Glycol nitrite	27	N-butyl formate	2.4	Toluene	2.4		

SAFETY PRECAUTIONS

Step Two

About this Manual:

PLEASE READ THE ENTIRE MANUAL PRIOR TO INSTALLING OR USING THIS PRODUCT. This manual includes information on all models of the LVP-51 series Non-Intrusive RF Capacitance level switch from Omega. Please refer to the part number located on the switch label to verify the exact model which you have purchased.

User's Responsibility for Safety:

Omega manufactures a wide range of liquid level sensors and technologies. While each of these sensors is designed to operate in a wide variety of applications, it is the user's responsibility to select a sensor model that is appropriate for the application, install it properly, perform tests of the installed system, and maintain all components. The failure to do so could result in property damage or serious injury.

Proper Installation and Handling:

Because this is an electrically operated device, only properly-trained staff should install and/or repair this product. *The adhesive on the fitting is for temporary installation only.* For permanent installation, the fitting for the sensor should be welded, glassed or strapped to the tank itself using approved plastic welding techniques. Do not install the LVP-51 series sensor on a metal tank, or within 6" of any metal pipe or fitting.

Mounting Bracket:

The LVP-51 series sensor may be mounted in the PE bracket (polyethylene, colored white). Make sure that the fitting is compatible with the tank it will be applied to.

Material Compatibility:

The sensor itself is not designed to be immersed. It should be mounted in such a way that it does not normally come into contact with fluid. Its case is made out of Polysulfone (PSO). Refer to an industry reference to ensure that compounds that may splash onto the controller housing will not damage it. Such damage is not covered by the warranty.

Wiring and Electrical:

The supply voltage used to power the LVP-51 series sensor should never exceed a maximum of 36 volts DC. Electrical wiring of the sensor should be performed in accordance with all applicable national, state, and local codes.

Flammable, Explosive and Hazardous Applications:

The LVP-51 series switch is not rated for use in hazardous locations. Refer to the National Electric Code (NEC) for all applicable installation requirements in hazardous locations. **DO NOT USE THE LVP-51 SERIES GENERAL PURPOSE SWITCH IN HAZARDOUS LOCATIONS.**

WARNING

Do not install the LVP-51 series level switch on a metallic tank, or within 6" of any metallic object. Metal will adversely affect the dielectric sensitivity of the sensor.

OMEGA's LVP-51 series sensors are not recommended for use with electrically charged application liquids. For most reliable operation, the liquid being measured may need to be electrically grounded.

INTRODUCTION

Step Three

About Non-Intrusive RF Capacitance Technology:

OMEGA's LVP-51 series level switch generates a high radio frequency signal from the capacitance electrode on the tank side of each sensor. Depending on the thickness of the tank wall and the material of which it is made, there is a particular minimum dielectric value the electrode measures when there is no liquid on the other side of the tank wall from the sensor. When liquid is on the other side of the wall, the dielectric value rises.

As part of installation, a two-step calibration procedure ensures that the threshold between wet and dry is set at the ideal point for your particular tank and application fluid, without the use of any external test equipment. The sensor's operation and point of actuation may vary based on the dielectric properties of various application liquids, tank materials and thicknesses. The LVP-51 series sensor is intended to be used with liquids with a dielectric value between 20 and 80. Due to its user calibration capability it may be able to detect liquids below a dielectric constant of 20 under certain conditions, but this must be verified by experimentation.

INSTALLATION

Step Four

OMEGA's LVP-51 series level switch may be installed anywhere on a tank wall using the supplied PE fitting that the switch slides into. The fitting comes with adhesive on the tank side that is sufficient to hold the sensor in position temporarily while the installation is tested, but for permanent installation the fitting must be welded, glassed or strapped to the tank. Extra fittings are available from Omega, so that the level switch may be moved to different locations on the tank by sliding it into other fittings.

Attach the fitting to the tank:

1. Determine the mounting location for the level switch. The point of actuation (where the sensor will send a "wet" signal) is most often at the center of the sensor; however the actual Point of Actuation (POA) may differ depending on the application liquid and tank wall characteristics. After positioning the fitting to check clearances, etc., remove the paper protective strips from the adhesive of the fitting.

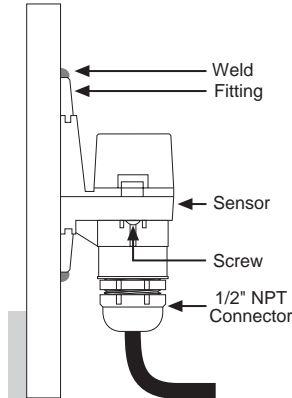

2. Press the fitting into place. The adhesive provides a seal between the sensor and the tank wall, and will hold it in place during testing and installation.

If desired, the sensor may be installed temporarily without welding the fitting to the wall. If several different locations must be tried before permanent installation, use double-sided foam stick tape designed for PE, for example Arclad type PE-6024, CO#7331 (from Adhesive Research Inc., Glen Rock PA 17327) or equivalent.

3. After the sensor has been tested to verify the POA, weld, glass or strap the fitting to the tank using standard industrial plastic techniques.

Special note for small round tanks:

The fitting may be attached to small, round tanks, as long as the majority of the fitting is firmly attached to the wall. However, extreme installations may effect the switches performance.

Mount the sensor in the fitting:

1. Slide the sensor into the fitting.
2. After trimming the sensor wire to length if needed by the installation, thread the sensor wire into a plastic flexible conduit with a 1/2" male fitting. Screw the conduit into the sensor, being careful not to cross the threads. Do not over tighten the conduit in the sensor as this may break the fitting. Such damage is not covered by the warranty. Take care while pulling the wire through conduit that no excessive tension is placed on the sensor end of the wire, so that the wire is not broken from the sensor housing.
3. Connect the sensor wire to the controller following the instructions in its manual. See the following Wiring Section for detailed wiring instructions.

ELECTRICAL

Step Five

Supply Voltage:

The supply voltage to the LVP-51 series level switch should never exceed a maximum of 36 VDC. Omega controllers have a built-in 13.5 VDC power supply which provides power to all of OMEGA's electrically powered sensors. Alternative controllers and power supplies, with a minimum output of 12 VDC up to a maximum output of 36 VDC, may also be used with the LVP-51 series level switch.

Required Cable Length:

Determine the length of cable required between the LVP-51 series level switch and its point of termination. Allow enough slack to ensure the easy installation, removal and/or maintenance of the sensor. The cable length may be extended up to a maximum of 1000 feet, using a well-insulated, 14 to 20 gauge shielded four conductor cable.

Wire Stripping:

Using a 10 gauge wire stripper, carefully remove the outer layer of insulation from the last 1-1/4" of the sensor's cable. Unwrap and discard the exposed foil shield from around the signal wires, leaving the drain wire attached if desired. With a 20 gauge wire stripper, remove the last 1/4" of the colored insulation from the signal wires.

Signal Outputs (Current sensing):

The standard method used by Omega controllers; this technology uses only two wires (Red and Black). The sensor draws 5 mA when it is dry, and 19 mA when wet. NC/NO status must be set by the controller. The Green and White wires are not used.

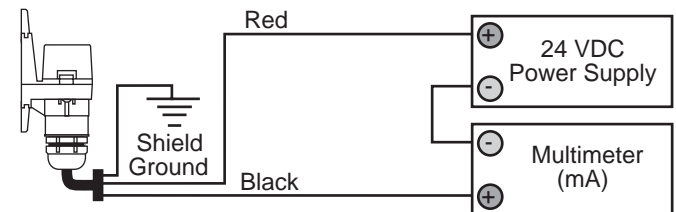

Signal Outputs (Relay switching):

Allows the sensor to switch a small load on or off directly, using an internal 1 A relay (60 VAC/60 VDC). All models, LVP-51 series_005, use the relay and features 4 wires (red, black, white and green) and a shield wire. The NO/NC status is set by the polarity of the voltage feeding the Red and Black wires. The Green wire is the common for the relay and the White is the NO or NC, depending on the polarity of Red and Black.

Normally Open Wiring:

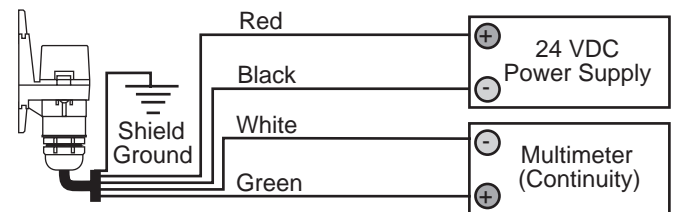

Normally Closed Wiring:

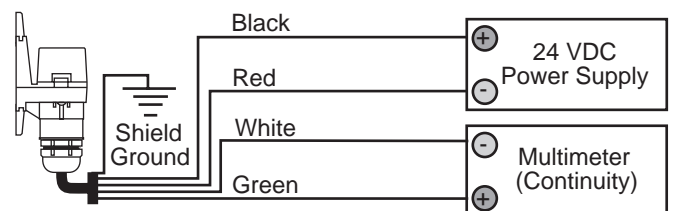

WIRING

Step Six

Wiring to a Omega Controller LVCN-120/130/140 Series Controller:

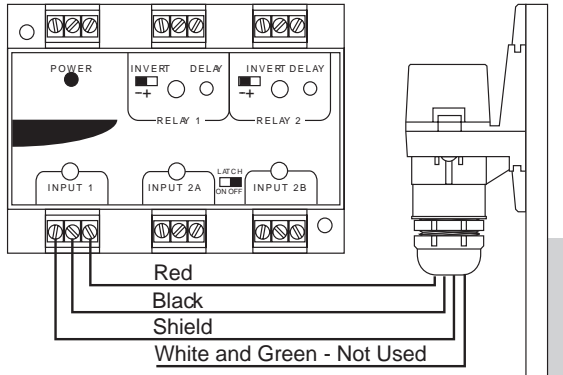

Wiring as a P-Channel or N-Channel output:

The LVP-51 series can be substituted for either a P-Channel (PNP, sourcing) output or a N-Channel (NPN, sinking) output.

Normally Open DC Load as a P-Channel Output:

To wire as a NO P-Channel output, follow the directions below. The Red wire connects to Positive (+) of the power supply and the Black wire connects to Negative (-). The Green wire is jumpered to the Red wire while the White wire is connected to the LOAD. Jumper the LOAD back to the Negative (-) to complete the circuit.

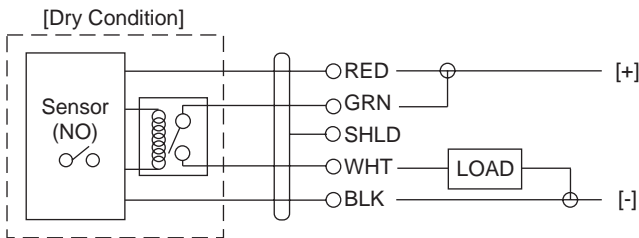

Normally Closed DC Load as a P-Channel Output:

To wire as a NC P-Channel output, follow the directions below. The Black wire connects to Positive (+) of the power supply and the Red wire connects to Negative (-). The Green wire is jumpered to the Black wire while the White wire is connected to the LOAD. Jumper the LOAD back to the Negative (-) to complete the circuit.

Normally Open DC Load as a N-Channel Output:

To wire as a NO N-Channel output, follow the directions below. The Red wire connects to Positive (+) of the power supply and the Black wire connects to Negative (-). The White wire is jumpered to the Black wire while the Green wire is connected to the LOAD. Jumper the LOAD back to the Positive (+) to complete the circuit.

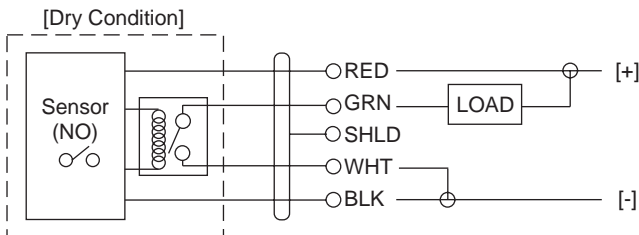

Normally Closed DC Load as a N-Channel Output:

To wire as a NC N-Channel output, follow the directions below. The Black wire connects to Positive (+) of the power supply and the Red wire connects to Negative (-). The White wire is jumpered to the Red wire while the White wire is connected to the LOAD. Jumper the LOAD back to the Positive (+) to complete the circuit.

WIRING

Step Seven

Wiring the Relay Output:

The LVP-51 series relay output can be wired as a dry contact to a VDC or VAC power source. LVP-51 series requires 12 - 36 VDC power to operate the sensor and switch the relay. All illustrations below identify a Dry switch state as the normal position of the relay.

Switching a Normally Open DC Load:

The Red wire connects to Positive (+) of the power supply and the Black wire connects to Negative (-). The LOAD can be attached to either the Green or White wires. Complete the circuit by either connecting the Green to (+) VDC power or White to (-) VDC power (see illustration below).

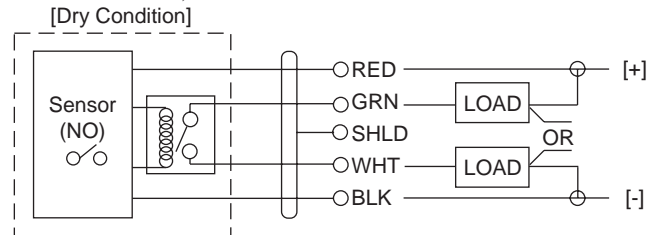

Switching a Normally Closed DC Load:

The Black wire connects to Positive (+) of the power supply and the Red wire connects to Negative (-). The LOAD can be attached to either the Green or White wires. Complete the circuit by either connecting the Green to (+) VDC power or White to (-) VDC power (see illustration below).

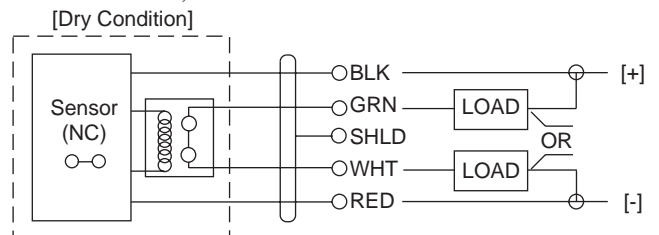

Switching a Normally Open AC Load:

The Red wire connects to Positive (+) of the DC power supply and the Black wire connects to Negative (-). The LOAD can be attached to the Green wire and the Hot of the VAC power. Connect the White to the Neutral of the VAC power (see illustration below).

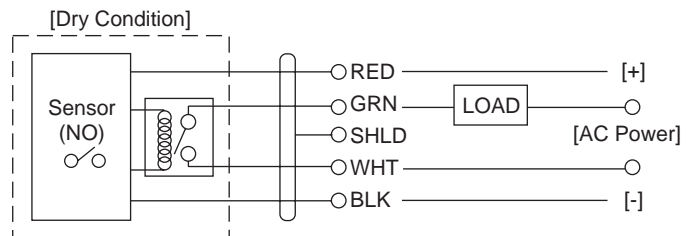

Switching a Normally Closed AC Load:

The Black wire connects to Positive (+) of the DC power supply and the Red wire connects to Negative (-). The LOAD can be attached to the Green wire and the Hot of the VAC power. Connect the White to the Neutral of the VAC power (see illustration below).

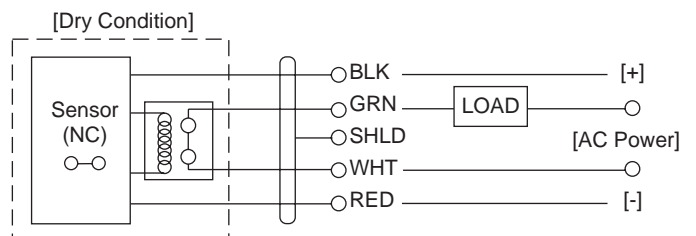

CALIBRATION

Step Eight

After it is installed in place, the LVP-51 series must be calibrated by the user before operation. Everything needed for the procedure is self-contained within the electronics of the LVP-51 series level switch. Two dielectric states—full condition and empty condition—are measured by the LVP-51 series, and then averaged to set the threshold between “wet” and “dry” at the sensor. The empty state must be at least 6” below the bottom of the sensor for calibration. The full state must be to the top of the sensor (not just to the point of actuation) for calibration. The actual application fluid at its intended operating temperature must be used during calibration. Use the following procedure assumes that the sensor has already been wired to a power supply.

1. Remove the cap from the sensor body by loosening the two screws located below the sensor. Do not remove the screws from the sensor. Insert a small screwdriver into the small slot at the edge of the cap and gently pry upwards.
2. Looking down you will see a small three-position switch and two trimpots marked Full and Empty. You may start with whatever state the tank is in.

3. Full state: With the tank filled to the top of the sensor, set the switch to the Full position (right). Make sure your hands or any other objects are not touching the sensor while calibrating because this will cause a false reading. Using a small nonmetallic screwdriver or alignment tool, turn trimpot Full until the LED just lights, and no farther. Note the position. Now turn the trimpot back until the LED turns off. The ideal setting for the trimpot is midway between these on and off points.

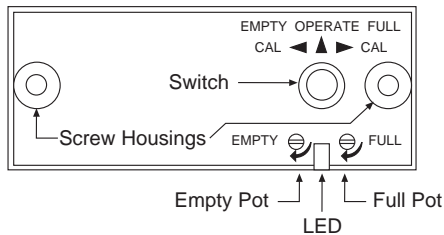

4. Empty state: With the tank drained to a point no closer than 6 inches below the bottom of the sensor, set the switch to the Empty position (left). Set the Empty trimpot as in Step 3.
5. After completing calibration, make sure to return the switch to the center position. Snap the cap back on by pressing down, and tighten the two screws.

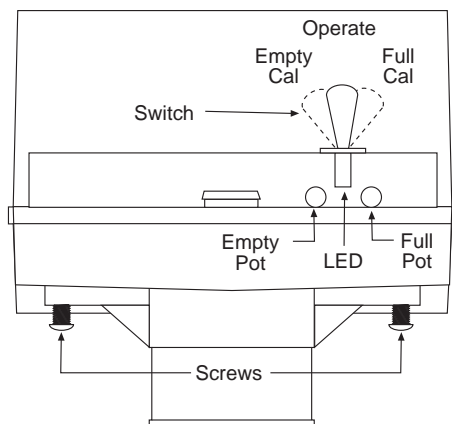

CALIBRATION

Step Nine

Checking the Point of Actuation:

Raise the fluid level to the point where the sensor sends a “wet” signal (Input LED will turn Amber on Omega controllers). The “dry” signal should be sent when the fluid level is lowered (Input LED will turn Green on Omega controllers). The actual Point of Actuation (POA) depends on many variables, including the thickness of the wall and the dielectric value of the liquid. For example, thicker tank walls can raise the POA while thinner walls could lower the POA.

If the POA needs to be changed, measure the distance and remount the sensor in a new location.

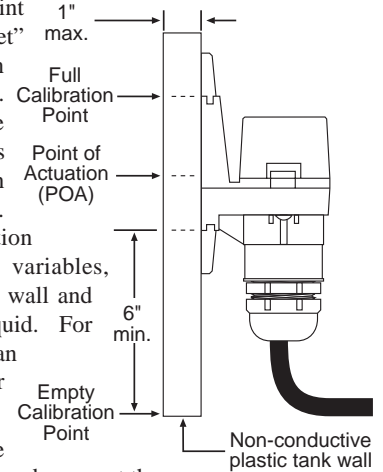

Do not attempt to change the Point of Actuation by intentional miscalibration.

If the sensor does not signal wet and dry reliably, it may be that:

- the dielectric constant of the application fluid is too low
- the tank wall is too thick for the application fluid
- there are static or other electrical charges in the fluid
- metal objects are within 6" of the sensor
- calibration was performed incorrectly

Try the calibration procedure again, after making corrections if possible. If the full and empty states are too similar dielectrically, it may not be possible to use a capacitance sensor.

Testing the Sensor:

1. **Power:** Apply power to sensor, by connecting power to the controller and/or power supply.
2. **Full condition:** Fill the tank with the application liquid, by filling the tank up to the sensor's point of actuation.
3. **Test:** With the sensor being fluctuated between wet and dry states, use a multimeter to ensure that the correct signals are being produced by the LVP-51 series level switch, or observe the sensor indicator light in the controller.
4. **Point of Actuation:** Observe the point at which the rising or falling fluid level causes the sensor to change state, and move the installation of the sensor if necessary.

Maintenance:

The LVP-51 series level switch itself requires no periodic maintenance except cleaning as required. However, periodically clean any coating or scaling on the tank wall the sensor is attached to and check the calibration. It is the responsibility of the user to determine the appropriate maintenance schedule, based on the specific characteristics of the application liquids. In addition, any dripping or condensation between the sensor and the tank wall fitting may need to be periodically cleaned to maintain accuracy.

Free Manuals Download Website

<http://myh66.com>

<http://usermanuals.us>

<http://www.somanuals.com>

<http://www.4manuals.cc>

<http://www.manual-lib.com>

<http://www.404manual.com>

<http://www.luxmanual.com>

<http://aubethermostatmanual.com>

Golf course search by state

<http://golfingnear.com>

Email search by domain

<http://emailbydomain.com>

Auto manuals search

<http://auto.somanuals.com>

TV manuals search

<http://tv.somanuals.com>