

Automatic Blood Pressure Monitor & Printer

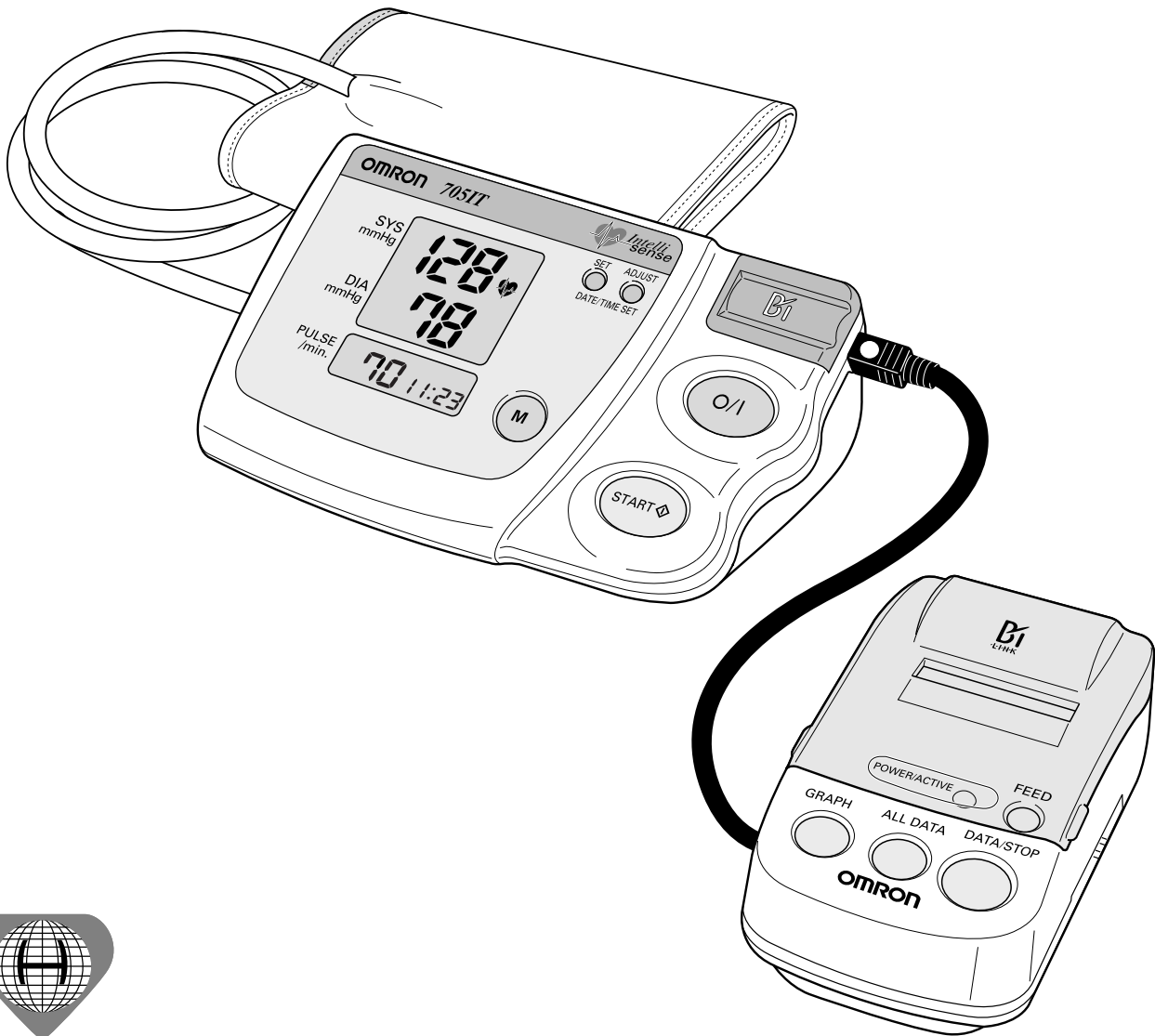

The World Hypertension League recommends regular blood pressure monitoring with clinically validated devices.

Instruction manual
 Gebrauchsanweisung
 Gebruiksaanwijzing

page 1
 Seite 23
 pagina 45

Mode d'emploi
 Istruzioni per l'uso
 Instrucciones de uso

page 67
 pagina 89
 pagina 111

All for Healthcare

IM-HEM-759-E2-02-10/2011
 1628532-8F

Contents

Blood pressure monitor
 Important instructions to help you obtain meaningful readings2
 Your blood pressure monitor: the benefits3
 Battery installation / replacement4
 How to set time and date5
 How to apply the cuff6
 How to take a reading8
 How to use the memory function10
 Hints on taking blood pressure readings11
 Failure, causes and rectification12
 Maintenance and storage13
 Technical data14
 OMRON spare parts15
 Some useful information about blood pressure16

Printer
 Introduction18
 Description of the printer18
 Battery installation/ replacement18
 How to connect printer unit19
 How to load printer paper19
 How to use the printer unit20
 Troubleshooting22
 Specifications22

Dear Customer

Thank you for purchasing an OMRON product. You can be sure you have made a wise choice. By buying the OMRON 705CP-II blood pressure monitor and printer, you have chosen a high-quality, innovative instrument for health monitoring. During its development, particular emphasis was placed upon reliability and ease of use. **Before using for the first time, please read through this manual carefully.** If you should still have any questions regarding its use, please contact the OMRON distributor at the given address on the packaging. They will be pleased to help you.

Best wishes for a healthy future.
 Yours sincerely,
 OMRON HEALTHCARE



The World Hypertension League recommends regular blood pressure monitoring by doctors and patients with clinically validated devices

Important instructions to help you obtain meaningful readings

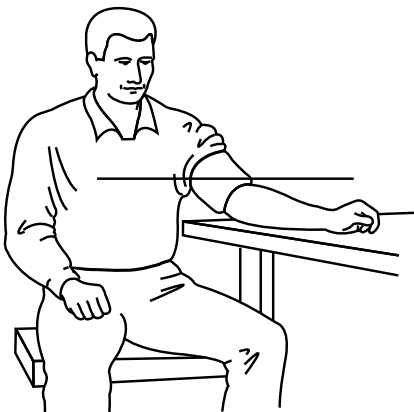
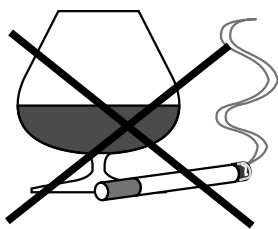

Regular blood pressure monitoring is essential for the prevention, the control and the management of hypertension. It also helps to support the doctors' work.

The World Hypertension League is a world-wide association of experts specialising in hypertension. The World Hypertension League recommends regular blood pressure monitoring by doctors and patients with clinically validated devices.

As the worlds leading manufacturer OMRON provides a range of products for regular blood pressure monitoring.

- **Important:** Blood pressure measurement is not suitable in cases of serious arteriosclerosis (hardening of the arteries).
- The pulse display is not suitable for monitoring the frequency of cardiac pacemakers.
- If you suffer from disorders of heart rhythm, known as arrhythmia, you should only use this blood pressure monitor in consultation with your doctor. In certain cases the oscillometric measuring method can produce incorrect readings.
- Pregnant women should only measure their own blood pressure in consultation with their doctor, since the readings may be changed by pregnancy.
- You should avoid eating, drinking (alcohol), smoking and sports before measuring your blood pressure, as this could affect your blood pressure level.
- Don't move, don't speak while measurement is being taken.
- Make yourself comfortable in a chair and relax before each reading.
- We recommend that you monitor your blood pressure twice a day, in the morning after getting up and in the evening after work, or as advised by your doctor.
- **Please remember: Self-measurement is not the same as medical treatment !**
You should never change the dose of medicines prescribed by your doctor.

Your blood pressure monitor: the benefits

OMRON 705CP-II is a compact, fully automatic blood pressure monitor, operating on the oscillometric principle. It measures your blood pressure and pulse rate simply and quickly. It contains an intelligent “fuzzy logic” system for controlled inflation, known as “Intellisense”. This is an advanced method of oscillometric measurement and does not require pressure pre-setting or re-inflation. OMRON is the world’s leading manufacturer of blood pressure monitors with the goal to always fulfill the need for reliable regular monitoring.

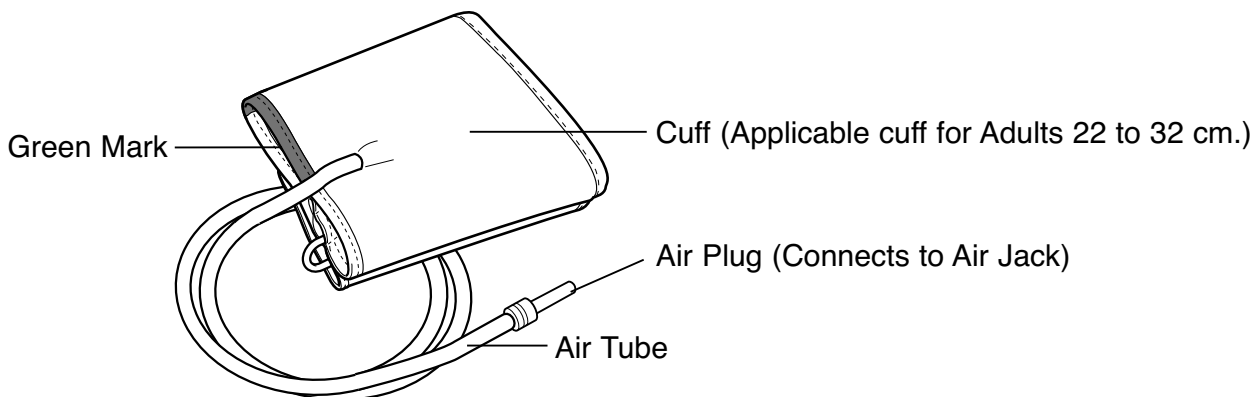
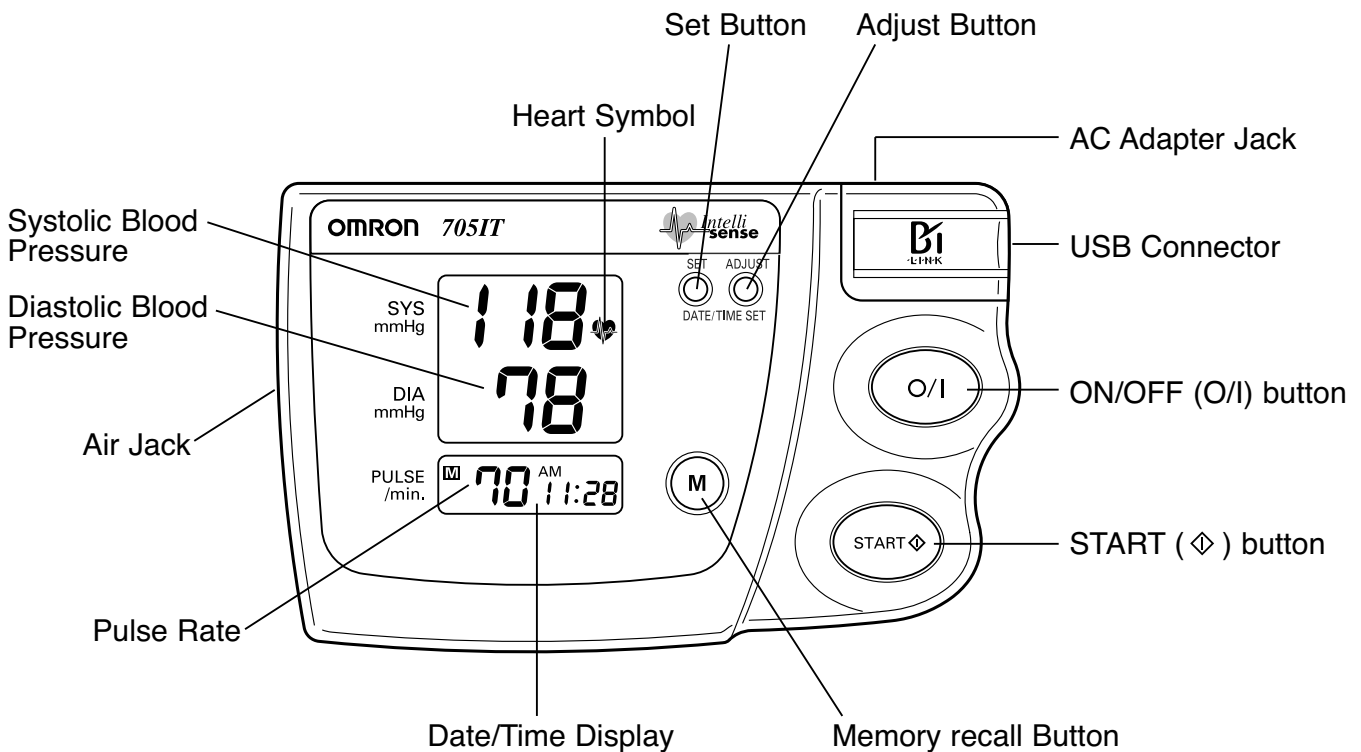

Battery installation / replacement

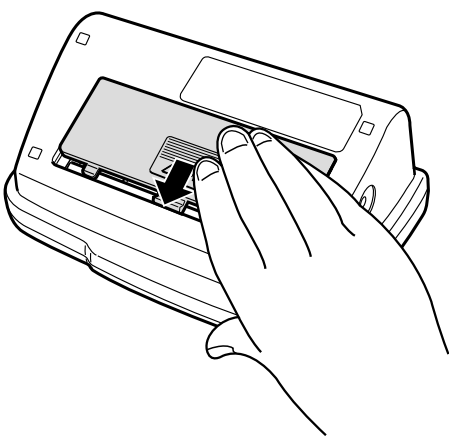
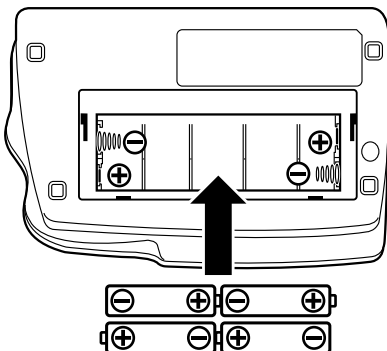
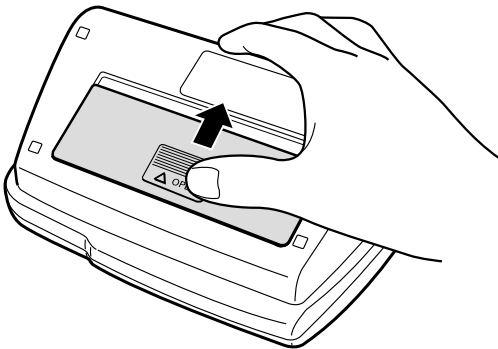

- ❶ Slide the battery cover off in the direction of the arrow.
- ❷ Install or replace 4 “LR6” batteries so the + (positive) and – (negative) polarities match the polarities of the battery compartment as indicated.
- ❸ Replace the battery cover.

NOTES :

If the Low Battery Indicator () appears on the display, replace all four batteries. Long-life alkaline batteries are recommended.

Remove the batteries if the monitor will not be used for an extended period of time.

Replace batteries within 30 seconds. If the batteries remain removed longer than that time, the set date and time will be deleted.

How to set time and date

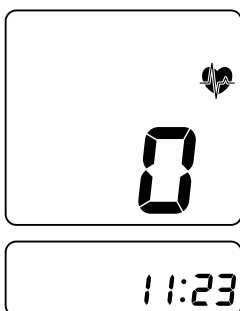
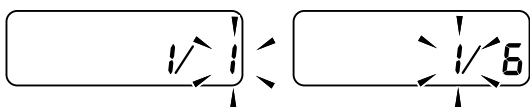
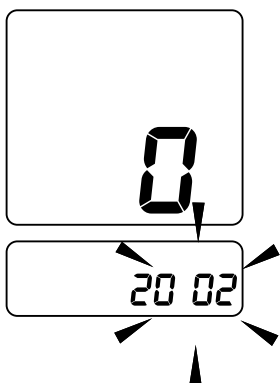
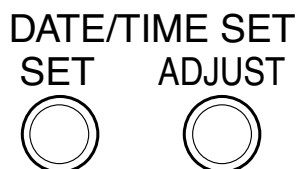
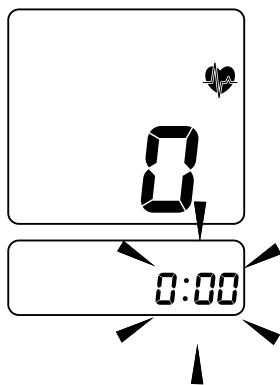

- ❶ Install the batteries and press the ON/OFF button.
The display will show 0:00

- ❷ Press and hold the SET button.
The year digits (2002) will flash.

- ❸ Press the ADJUST button to advance the digit(s) one at a time.
If you hold down the ADJUST button, the digits will advance rapidly.

- ❹ Press SET button when desired number is on the display to lock setting.

- ❺ Repeat Step 3-4 for month and date.

- ❻ Repeat Step 3-4 for hour and minutes.

How to apply the cuff

(when wrapping on your left arm)

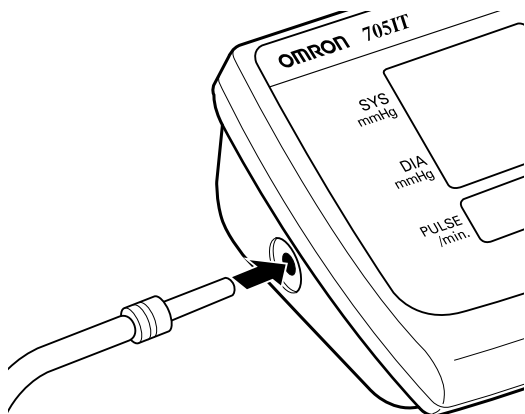

• You can wrap the cuff either on your right or left arm.

- ❶ Insert air tube to air jack (on the left side of the device). The cuff must be airless.
- ❷ Remove tight-fitting clothing from your upper arm.
- ❸ Sit in a chair with your feet flat on the floor and place your arm on a table so that the cuff is at the same level as your heart.
- ❹ Put your arm through the cuff loop. The bottom of the cuff should be approximately 1 to 2 cm above the elbow. The green marker on the cuff should lie over the brachial artery on the inside of the arm. The tube should run down centre of arm approximately even with middle finger.

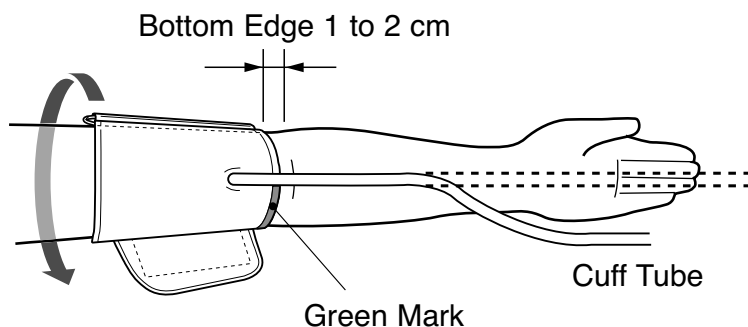

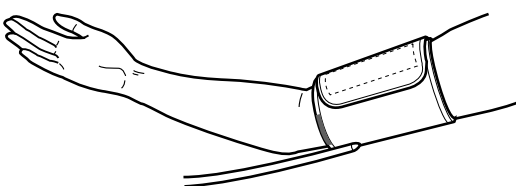
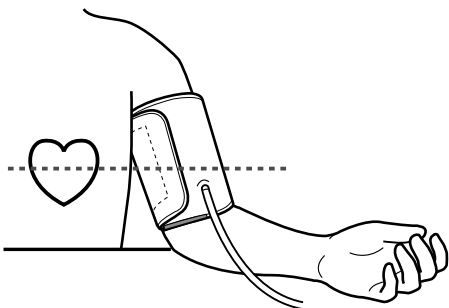
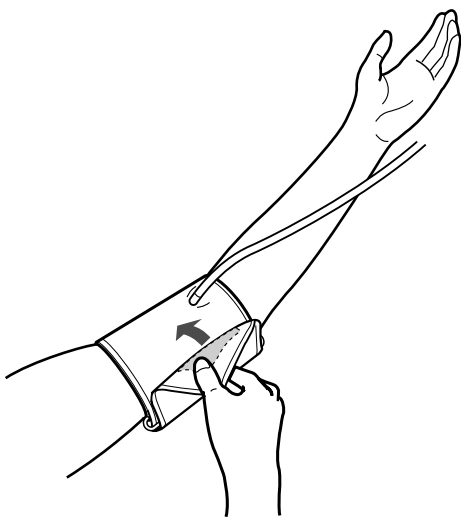
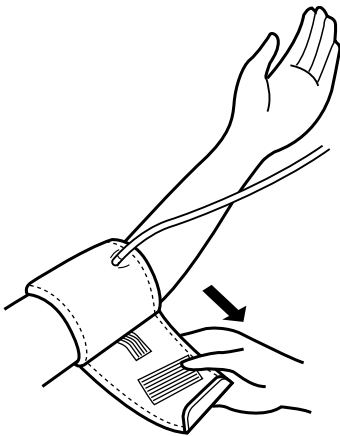

Right hand measurement

- 5 Pull the cuff so that the top and bottom edges are tightened evenly around your arm.
- 6 When the cuff is positioned correctly, close the velcro fastener **FIRMLY**.
- 7 Make certain the cuff fits snugly around your arm. The cuff should make good contact with your skin. **You should be able to fit your index finger between the cuff and your arm easily, so you can pull the cuff off and on.**
- 8 Relax your arm and turn your palm upward.
- 9 Be sure there are no kinks in the air tubing.

How to take a reading

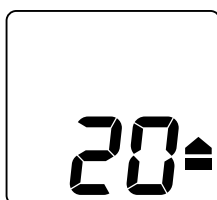
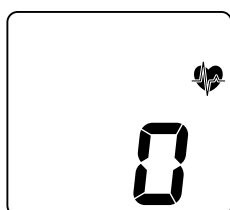
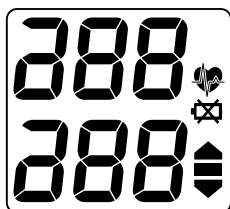

Inflation

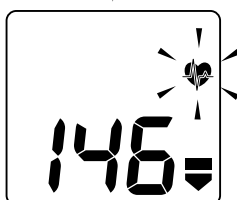

Deflation

❶ Press the (O/I) button.

a) All display symbols appear for approximately one second.

b) When the monitor becomes ready to measure, the () symbol appears on the display.

❷ Press the (START ) button and remain still.

As the cuff begins to inflate, the monitor automatically determines your ideal inflation level. Because this monitor detects the pulse even during inflation, do not move your arm but remain still until the entire measurement completes.

- If you want to stop the inflation or measurement, press the (O/I) button. The monitor will stop inflating and start deflating rapidly, then the monitor will turn off.

❸ Inflation stops automatically and measurement is started.

As the cuff slowly deflates, decreasing numbers appear on the display and the () symbol flashes at every heartbeat. In rare circumstances, a higher inflation may be necessary. In those cases, the monitor reinflates the cuff up to 30 mmHg higher than initial inflation and restarts the measurement.

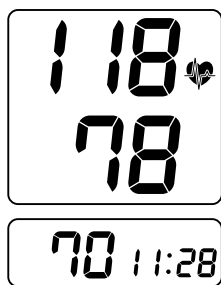

- ④ When the measurement is complete, the cuff completely deflates and your blood pressure and pulse rate are displayed.

NOTE :

The monitor automatically stores blood pressure and pulse rate into the memory.

- When 28 sets of readings are stored in memory, the oldest set will be deleted to store a new set.

- ⑤ Press the (O/I) button to turn the monitor off.

NOTE :

If you forget to turn the monitor off, it will automatically shut itself off after five minutes.

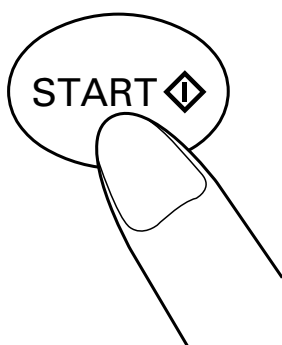

Continue to press button

Instructions for special conditions:

- If your systolic pressure is known to be more than 220 mmHg, press and hold the (START ◊) button until the monitor inflates 30 to 40 mmHg higher than your suspected systolic pressure.

NOTE :

Do not apply more pressure than necessary.

The monitor will not inflate above 300 mmHg.

How to use the memory function

This monitor has a memory capable of storing 28 sets of readings. Every time you complete the measurement, the monitor automatically stores blood pressure and pulse rate.

- Turn on the monitor by pressing the (O/I) button.
- Press the (M) button to recall stored readings while the (P) symbol is displayed.

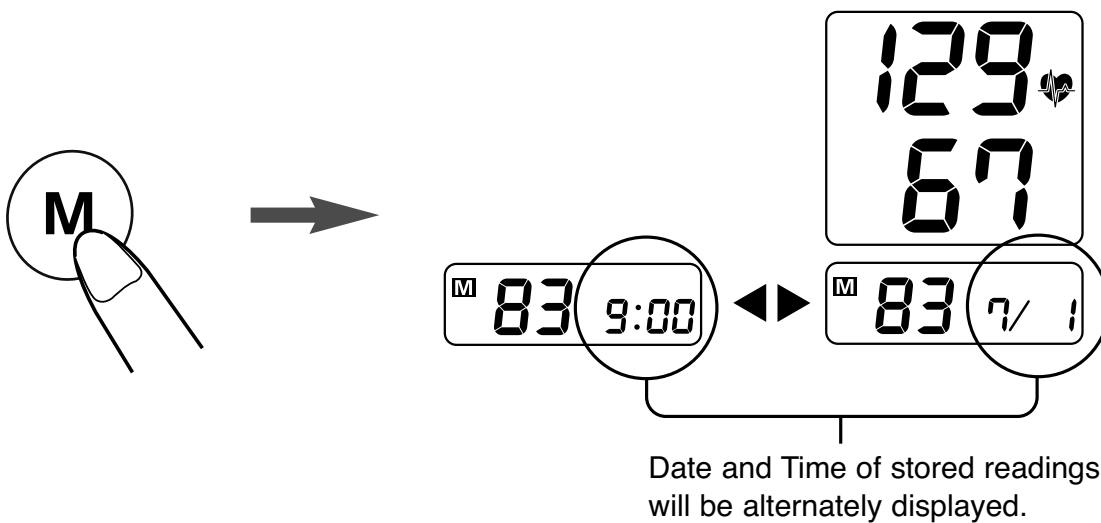

- To delete all the stored readings, press the (M) button and the (START) button simultaneously.

NOTE :



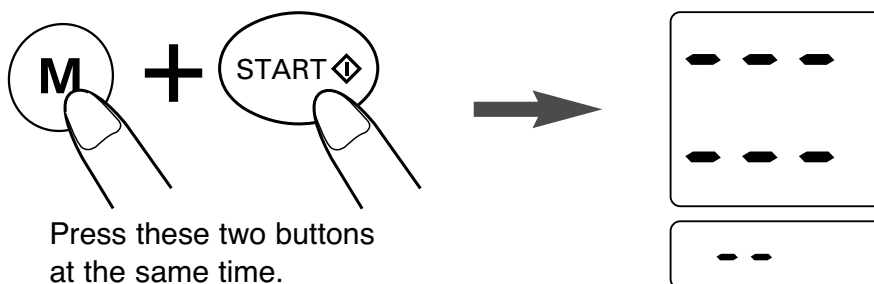



You can not delete the stored readings partially.



Hints on taking blood pressure readings

- Before measuring, stretch your back and sit up straight, breath normally 5-6 times, relax your shoulders, arms and entire body.
- Slightly bend and support your elbow (e.g. on a table).
- Do not move, talk or touch the device during measurement.
- Stress influences your blood pressure, so try to relax before taking a measurement.
- To compare results, measurements must always be taken from the same arm.
- Do not place the cuff over thick clothes and do not roll up your sleeve if it is too tight.
- Align the cuff with the height of your heart (breast height). If necessary use a pillow or cushion.
- Coldness raises your blood pressure. It is recommended to measure at room temperature (+20°C).
- Relax before measurement. If necessary go to the bathroom before measurement.
- Do not measure directly after bathing.
- If you wish to interrupt measurement prematurely, press the (O/I) button. Inflation is stopped and the air is automatically released from the cuff.
- Blood pressure measurements taken in a moving vehicle may be influenced by vibration.
- If an error has occurred during measurement **E** is displayed. Please refer to the next chapter.
- The monitor should be switched off after measurement to avoid running down the batteries unnecessarily. If you forget to do so, the monitor switches itself off automatically after 5 minutes.

Failure, causes and rectification

Failure and their possible causes	Rectification
<p>Incorrect measurement is indicated by E</p> <ol style="list-style-type: none"> 1. A correct reading could not be obtained because measurement was disturbed by movement of the body. 2. The cuff is not fitted correctly. 3. Your clothing has constricted your blood flow. 4. There is still air in the cuff when the monitor is switched off. 	<ol style="list-style-type: none"> 1. Repeat the measurement keeping perfectly still. Do not move your arm and do not speak. 2. Check that the cuff is correctly fitted. Then repeat the measurement. 3. Remove the item of clothing which caused the constriction. 4. The unit may be defective. Please have it examined and, if necessary, repaired by OMRON.
<p>The (START ) button was pressed before the () symbol was displayed.</p>	<p>Wait for the () symbol indicating readiness before you press the (START ) button.</p>
<p>The blood pressure values displayed are extremely low or high, or they are implausible.</p>	<p>Refer to the instructions and then repeat the measurement.</p>
<p>The display does not light up when the (START ) button is pressed.</p> <ol style="list-style-type: none"> 1. The batteries are exhausted. 2. The +/- poles of the batteries have been reversed. 3. The battery contacts are dirty. <p> The batteries are weak or exhausted.</p>	<ol style="list-style-type: none"> 1. Check the batteries and, if necessary, fit 4 new batteries. 2. Reinsert the batteries with the +/- poles the right way round. 3. Clean the battery contacts with a dry cloth. <p>Fit new batteries.</p>
<p>The cuff pressure does not rise although the pump motor can be heard.</p> <p>E_r problem with mem. function</p>	<p>Check that the air tube is properly connected to the monitor. Push the tube connector firmly into the socket.</p> <p>Contact your Omron retailer or distributor.</p>

Maintenance and storage

- For cleaning the monitor only use a soft, lightly moistened cloth.
Do not use petroleum spirits, thinners or similar solvents !
- Stains on the cuff can be carefully removed using a moist cloth and soapy water.
Do not wash the cuff or make it wet !
- Keep your blood pressure monitor in the storage case to protect it from dust and moisture.
- Protect your monitor against vibrations and do not leave it in a place where temperatures are extremely low (below -20°C) or extremely high (above 60°C) or with high humidity (+ 85%).
- Do not use your monitor at very low temperatures (below 10°C) or very high temperatures (above 40°C).
- Do not fold the cuff or air tube together too tightly and do not crease them.
- Do not carry out repairs of any kind yourself. If a defect occurs, consult the OMRON distributor or Customer Services or seek the advice of your surgical appliance stockist or pharmacist.
- The accuracy of this blood pressure monitor is designed to last a long time.
- In order to increase the lifetime of the batteries take them out when you store the device for a longer period than 2 months.
- Electro-magnetic fields can influence the measurement. Do not use a portable phone near this unit.

Technical data

This device fulfils the provisions of the EC directive 93/42/EEC (Medical Device Directive). This blood pressure monitor is designed according to the European standard EN1060, Non-invasive sphygmomanometers Part 1: General requirements and Part 3: Supplementary requirements for electromechanical blood pressure measuring systems. This OMRON product is produced under the strict quality system of OMRON HEALTHCARE CO. LTD., Japan. The Core component for OMRON blood pressure monitors, which is the Pressure Sensor, is produced in Japan.

Model:	OMRON 705CP-II
Display:	LCD digital display
Blood Pressure Measurement Range:	Pressure: 0 mm Hg to 299 mm Hg Pulse: 40 – 180/min.
Accuracy:	Pressure: ±3 mm Hg Pulse: ±5% of reading
Memory:	28 measurements
Inflation:	Fuzzy-Logic controlled by electric pump
Deflation:	Automatic pressure release valve
Pressure Detection:	Capacitive pressure sensor
Measurement Method:	Oscillometric method
Power Source:	4 Alkaline batteries 1.5V (Type LR6) or AC/DC adapter (optional, 6V = 4W)
Battery Life:	Capacity of new batteries is approx. 300 measurements
Operating Temperature:	10°C to 40°C
Storage Temperature:	-20°C to 60°C
Humidity:	15 to 90% RH maximum
Storage humidity:	10 to 95% RH maximum
Console Weight:	Approximately 380g without batteries
Outer Dimensions:	Approximately 115 (l) mm x 177 (w) mm x 71 (h) mm
Cuff Dimensions:	Approximately 140 mm x 480 mm (arm circumference 22 – 32 cm)
Accessories:	Medium cuff, instruction manual, storage case, battery set
	Made in China

NOTE: Subject to technical modification without prior notice

- Disposal of this product and used batteries should be carried out in accordance with the national regulations for the disposal of electronic products.

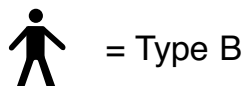

= Type B

CE 0197

OMRON spare parts

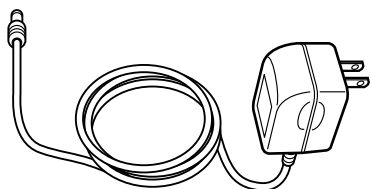

AC adapter



Small cuff

Arm circumference 17 – 22 cm



Medium cuff

Arm circumference 22 – 32 cm



Extra large cuff

Arm circumference 32 – 42 cm

Calibration

The accuracy of this blood pressure monitor has been carefully tested and is designed for a long service life. It is generally recommended to have the monitor inspected every two years to ensure correct functioning and accuracy. Please consult your authorised dealer or the OMRON Customer Service at the address given on the packaging/attached literature.

OMRON devices are especially designed for regular blood pressure monitoring. OMRON therefore has direct contact with medical specialists and takes advice, on the design and features of its blood pressure monitors.

Spare parts & accessories

Due to high company quality standards, OMRON considers the main unit as a non-serviceable part because of the necessity of proper calibration after replacement of high-tech components.

Some useful information about blood pressure

What is Blood Pressure ?

Blood pressure is a measure of the force of blood flowing against the walls of the arteries. Arterial blood pressure is constantly changing during the course of the heart's cycle. The highest pressure in the cycle is called the **SYSTOLIC BLOOD PRESSURE**; the lowest is the **DIASTOLIC BLOOD PRESSURE**. Both pressure readings, the **SYSTOLIC** and **DIASTOLIC**, are necessary to enable a doctor to evaluate the status of a patient's blood pressure.

Many factors such as physical activity, anxiety, or the time of day, can influence your blood pressure. Blood pressure is typically low in the morning and increases from afternoon to evening. It is lower in the summer and higher in the winter.

Blood pressure is measured in millimetres of mercury (mmHg) and measurements are written with the systolic pressure before the diastolic e.g. A blood pressure written as 140/90, is referred to as 140 over 90 mmHg.

High Blood Pressure

The discovery that you have high blood pressure is more often than not a chance finding. People with high blood pressure usually feel well unless the blood pressure has been high for some time, and complications have occurred. Such complications may affect the heart, brain and other important organs. They may bring on ill health and affect your enjoyment of life. It is because of the complications, rather than the high blood pressure itself, that this condition is taken so seriously today.

High blood pressure is sometimes referred to as raised blood pressure, elevated blood pressure, or hypertension. Most people with this condition require regular long-term drug treatment, usually in the form of tablets. Some can lower their blood pressure sufficiently by other means, such as changing diet and life-style.

People who have high blood pressure, and who also understand their condition, have an advantage. They are more likely to attend for regular check-ups, to cooperate with advised diets and changes in lifestyle, and to take medicines correctly. This immediately leads to better health. It is hoped that, by a better understanding of high blood pressure and how it is treated, you will take an active and informed part in your health care, and so enjoy a better quality of life.

What Causes High Blood Pressure ?

Blood pressure is only classed as high if it doesn't go down when you rest. Permanently raised blood pressure can be caused by several factors such as hardening of the arteries, smoking or drinking too much alcohol. It can also be caused by cholesterol, a type of fat, building up inside your blood vessels and making them narrower. Being under stress can add to the problem.

High blood pressure is also known to run in families hence if you find you have a high blood pressure it is a good idea to test other closely related members of your family.

Fluctuation within a Day
(Example: 35-year-old male)

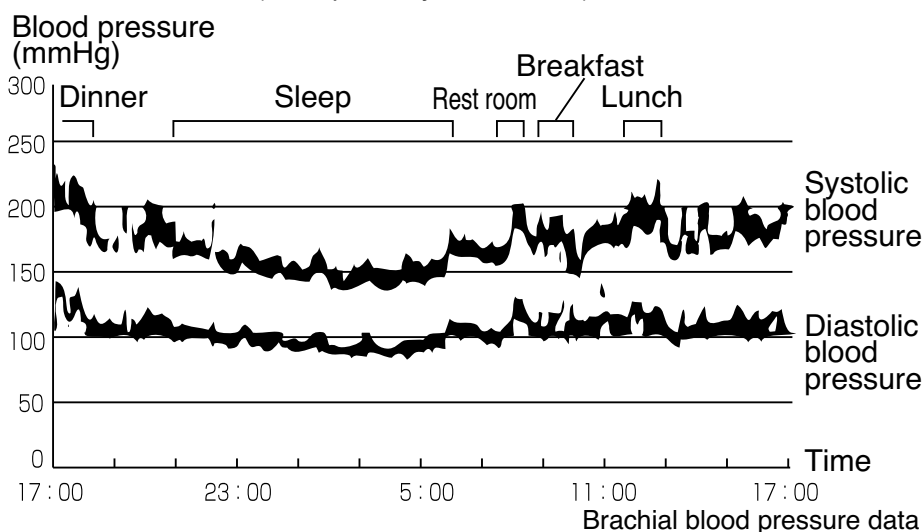

Why is it a Good Thing To Measure Blood Pressure at Home ?

Having your blood pressure measured by a doctor can cause anxiety which is a cause itself of high blood pressure. As a variety of conditions affect blood pressure, a single measurement may not be sufficient for an accurate diagnosis.

The blood pressure measured first thing in the morning after getting up, before eating and while at rest, is known as the fundamental blood pressure. In practice it is rather difficult to record the fundamental blood pressure, but it is important to get readings in an environment that is as close as possible to this.

Classification of Blood Pressure by the World Health Organization

The World Health Organization (WHO) and the International Society of Hypertension (ISH) developed the Blood Pressure Classification shown in this figure.

This classification is based on the blood pressure values measured on people in a sitting position in outpatient departments of hospitals.

**There is no universally accepted definition of hypotension. However, those having the systolic pressure below 100 mmHg are assumed as hypotensive.*

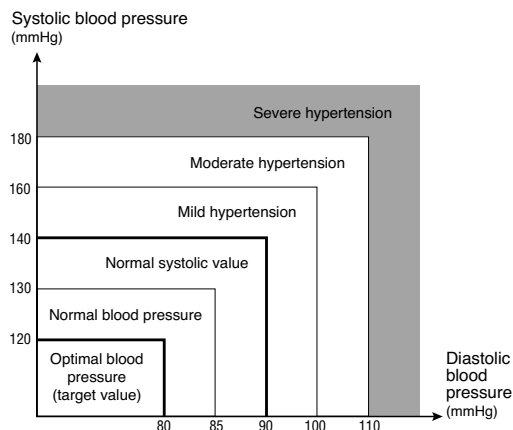

According to the blood pressure classification by the WHO/ISH* (revised in 1999)
* International Society of Hypertension

Introduction

The OMRON printer can be connected to OMRON blood pressure monitors with IT functions.

Description

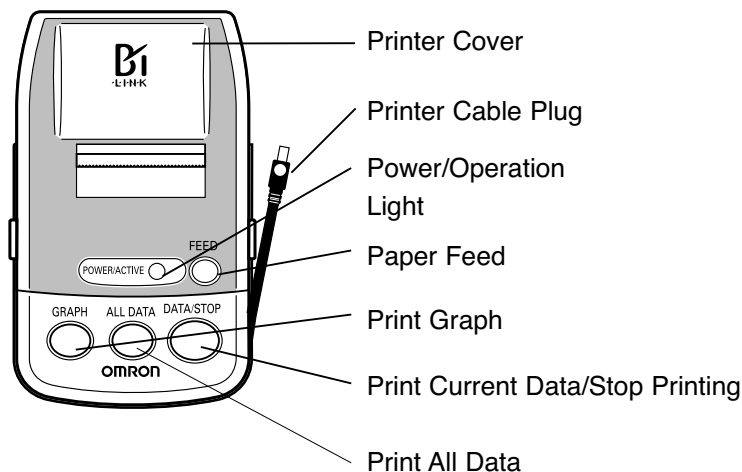

Battery installation / replacement

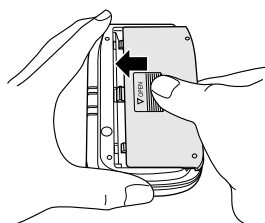
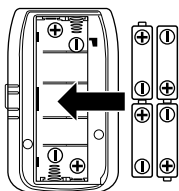
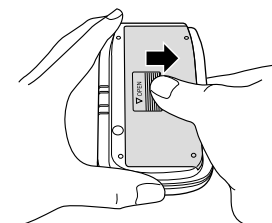

- ❶ Slide the battery cover off in the direction of the arrow.
- ❷ Install or replace 4 “LR6” batteries so the + (positive) and – (negative) polarities match the polarities of the battery compartment as indicated.
- ❸ Replace the battery cover. Remove the batteries if the monitor will not be used for an extended period of time.

How to connect the printer unit

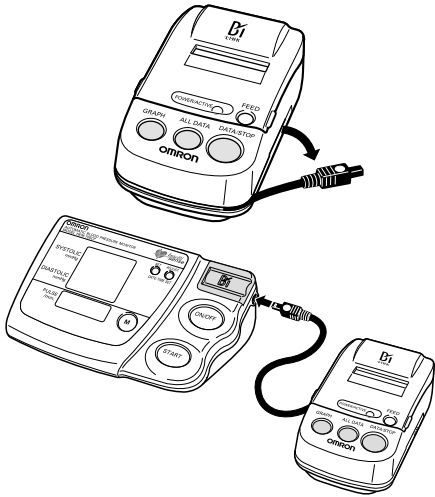

- ❶ Remove printer cable plug from the printer unit.
- ❷ Connect printer cable plug cord to the main unit. The circle on the cable plug should face up.

How to load the printer paper

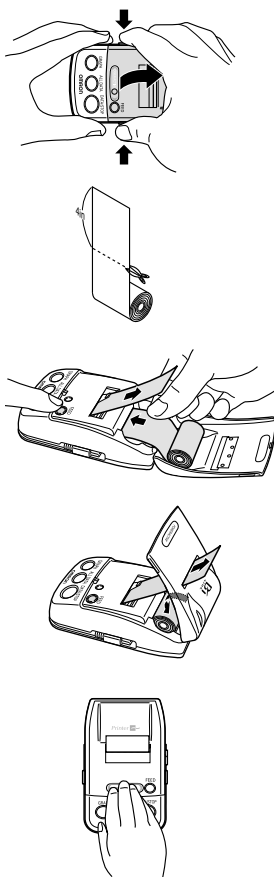

- ❶ Open printer cover in the direction indicated by the arrow symbol and remove paper roll from the main unit.
- ❷ Peel of the glued edge of the printing paper included with the unit, and cut the first 10 cm (4 inch) with a pair of scissors.
- ❸ Press the FEED button while inserting the edge of the printing paper into the paper feeding slot. When the edge of the paper protrudes sufficiently, release the FEED button.
- ❹ Close the plastic printer cover. Make certain that the paper sticks out from the top when the cover is replaced.
- ❺ Thermal sensitive paper is supplied with the unit. Use only thermal paper of similar size (width approx. 38mm) and roll diameter (not to exceed approx. 26mm)! These rolls of paper can be ordered from OMRON. Printer paper can be ordered by your OMRON shop or distributor.

How to use the printer

OMRON IT blood pressure monitors have the ability to print all the readings stored in memory.

- NOTE:**
- Make sure printer-unit is connected to main unit (see How to Connect Printer-Unit)
 - Do not use printer-unit without loading printer paper (see How to Load Printer Paper). Improper use will decrease operation life cycle of printer-unit.
 - Main unit does NOT have to be ON to operate printer-unit.
 - Printer-unit will automatically shut OFF when printing is completed.
 - If you need to stop printing during printing process, press "DATA/STOP" button.

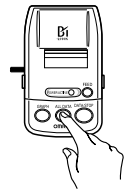

- 1** Press "DATA/STOP" to print measurement of most recent reading.
The numeric print-out will look like the following example:

Month/Date	7/9	6:36 AM	Time
Systolic Reading	SYS	111mmHg	
Diastolic Reading	DIA	67mmHg	
Pulse Reading	PULSE	77/min	

- 2** Press "ALL DATA" button to print a numerical list and average of all stored readings (maximum depending on your blood pressure monitor).
The numerical print-out will list all stored readings starting with the most recent reading to last stored reading:

Month(s)	D. T.	Systolic Reading Column mmHg SYS	Diastolic Reading Column /min DIA	Pulse Reading Column PUL
	20 15	113	75	67
	23 11	117	69	64
	1 15	113	71	63
Time/Hour	3 14	110	67	66
	5 7	112	66	64
	15 7	110	61	64
	20 12	106	66	65
	3 12	110	65	64
	10 12	108	61	67
	12 14	111	56	62
	14 7	107	64	64
	21 15	111	64	64
	22 12	121	62	66
	4 6	112	64	63
	*AV.	112	65	65

- Month(s)**
 The month or months will be printed.
 Example: If the blood pressure reading was stored between months March-June, then the printout will indicate "3-6".
- Date**
 Only the day's date (1-31) will be printed.
 Example: If the blood pressure reading was stored on June 1st, then the printout will indicate 1 under the "D" column.
- Time/Hour**
 Only the hour (in military time) will be printed.
 Example: if the blood pressure reading was stored at 3:00 PM, then the printout will indicate 15 under the "T" column.

Note: If Time and Date was not initially set up before taking blood pressure measurement (see How to Set Time and Date) on printer-unit, the numerical value will not appear on print-out for month, time/hour and date.)

- Press "GRAPH" button to print a graph of all stored readings

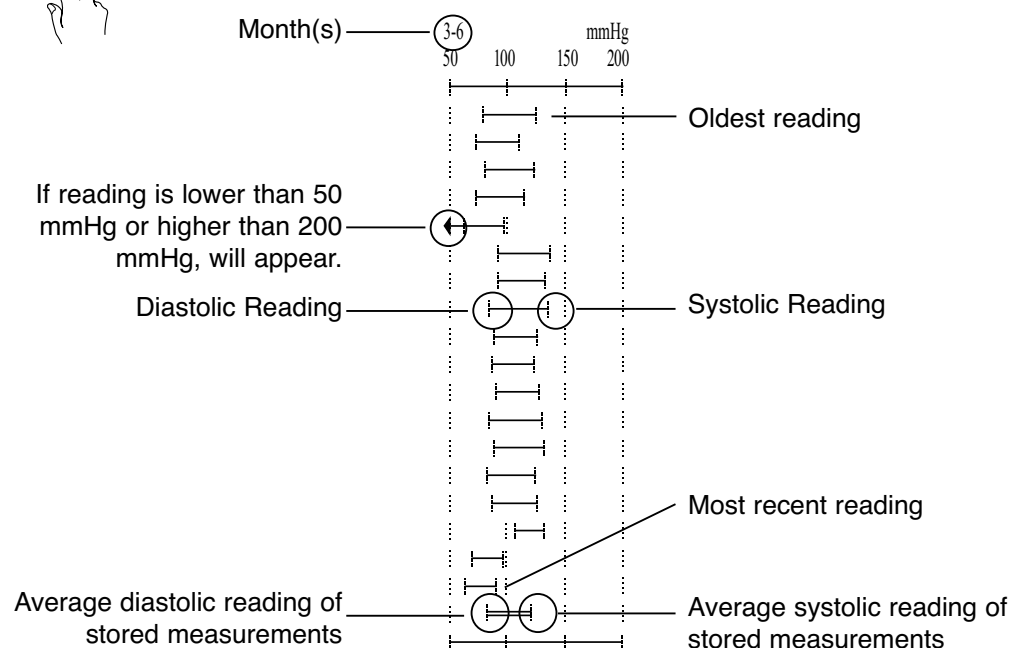

Troubleshooting

Error Indicator	Cause	Correction
Nothing is printed	Printer cable plug is not connected properly or damaged	Connect correctly reference p.10 Contact your OMRON distributor.
	Batteries are worn	Replace with new batteries
	No readings stored	Take measurement then print
	Printer paper is not installed correctly	Install correctly
Power/Operation light is blinking, stopped printing	Batteries are worn	Replace with new batteries
No printer paper comes out	No printer paper installed	Take paper jammed from the printer and install again
	Printer paper jammed	
	Ran out of printer paper	Purchase new printer paper

Specifications

Power Source:	4 "AA" batteries
Battery Life:	Approximately 300 uses
Paper Usage:	Approximately 200 uses for 1 roll
(Printer) Weight:	Approximately 6 oz. (170 g) (not including batteries)
(Printer) Dimensions:	Approximately 4 4/5" (l) x 2 4/5" (w) x 2" (h) (123 mm x 72 mm x 50 mm)

NOTE: These specifications are subject to change without notice.

EU-representative: OMRON HEALTHCARE EUROPE B.V.
Scorpius 33, 2132 LR Hoofddorp
THE NETHERLANDS

CE 0197

Disposal of this product and used batteries should be carried out in accordance with the national regulations for the disposal of electronic products.



Manufacturer 	OMRON HEALTHCARE Co., Ltd. 53, Kunotsubo, Terado-cho, Muko, Kyoto, 617-0002 JAPAN			
EU-representative <table border="1" data-bbox="204 539 387 613"> <tr> <td data-bbox="204 539 296 613">EC</td> <td data-bbox="296 539 387 613">REP</td> </tr> </table>	EC	REP	OMRON HEALTHCARE EUROPE B.V. Scorpius 33, 2132 LR Hoofddorp, THE NETHERLANDS www.omron-healthcare.com	
EC	REP			
Production facility Produktionsstätte Productiefaciliteit Site de production Oficina de producción Stabilimento di produzione	OMRON (DALIAN) CO., LTD. Dalian, CHINA			
Subsidiary Niederlassung Dochteronderneming Succursale Empresa filial Consociata	<table border="1" data-bbox="595 875 1433 1296"> <tr> <td data-bbox="595 875 1433 965"> OMRON HEALTHCARE UK LTD. Opal Drive, Fox Milne, Milton Keynes, MK15 0DG, U.K. </td> </tr> <tr> <td data-bbox="595 965 1433 1077"> OMRON MEDIZINTECHNIK HANDELSGESELLSCHAFT mbH John-Deere-Str. 81a, 68163 Mannheim, GERMANY www.omron-medizintechnik.de </td> </tr> <tr> <td data-bbox="595 1077 1433 1296"> OMRON SANTÉ FRANCE SAS 14, rue de Lisbonne, 93561 Rosny-sous-Bois Cedex, FRANCE Uniquement pour le marché français: OMRON Service Après Vente N° Vert 0 800 91 43 14 consommateurs@omron-sante.fr www.omron-sante.fr/contact </td> </tr> </table>	OMRON HEALTHCARE UK LTD. Opal Drive, Fox Milne, Milton Keynes, MK15 0DG, U.K.	OMRON MEDIZINTECHNIK HANDELSGESELLSCHAFT mbH John-Deere-Str. 81a, 68163 Mannheim, GERMANY www.omron-medizintechnik.de	OMRON SANTÉ FRANCE SAS 14, rue de Lisbonne, 93561 Rosny-sous-Bois Cedex, FRANCE Uniquement pour le marché français: OMRON Service Après Vente N° Vert 0 800 91 43 14 consommateurs@omron-sante.fr www.omron-sante.fr/contact
OMRON HEALTHCARE UK LTD. Opal Drive, Fox Milne, Milton Keynes, MK15 0DG, U.K.				
OMRON MEDIZINTECHNIK HANDELSGESELLSCHAFT mbH John-Deere-Str. 81a, 68163 Mannheim, GERMANY www.omron-medizintechnik.de				
OMRON SANTÉ FRANCE SAS 14, rue de Lisbonne, 93561 Rosny-sous-Bois Cedex, FRANCE Uniquement pour le marché français: OMRON Service Après Vente N° Vert 0 800 91 43 14 consommateurs@omron-sante.fr www.omron-sante.fr/contact				

Made in China
Hergestellt in China
Geproduceerd in China
Fabriqué en Chine
Fabricado en China
Prodotto in Cina

Free Manuals Download Website

<http://myh66.com>

<http://usermanuals.us>

<http://www.somanuals.com>

<http://www.4manuals.cc>

<http://www.manual-lib.com>

<http://www.404manual.com>

<http://www.luxmanual.com>

<http://aubethermostatmanual.com>

Golf course search by state

<http://golfingnear.com>

Email search by domain

<http://emailbydomain.com>

Auto manuals search

<http://auto.somanuals.com>

TV manuals search

<http://tv.somanuals.com>