

OMRON

INSTRUCTION MANUAL

OMRON Digital Automatic Blood Pressure Monitor

Model

HEM-907

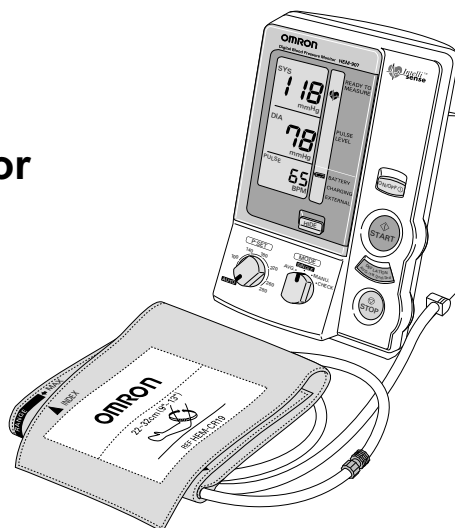

Thank you very much for purchasing the OMRON Digital Automatic Blood Pressure Monitor.

Requests from OMRON to the operators and the persons responsible for maintenance

Please read thoroughly the “Notes on Safety” of this Instruction Manual before using this unit so that you can use it safely and correctly after sufficient understanding.

After reading this Instruction Manual, please keep it near the unit all the times for future reference.



= Read the instruction manual carefully

Table of Contents

Intended use.....	2
Exemptions.....	3
Names and Functions of the Parts.....	4
Notes on Safety.....	8
Components of the Product.....	12
Options.....	12
How to Apply the Arm Cuff.....	13
How to Use the Power Source (AC Adapter).....	14
How to Measure Blood Pressure.....	15
SINGLE Mode.....	16
AVG. Mode.....	17
MANU. Mode.....	18
CHECK Mode.....	19
Installation and Replacement of Battery Pack.....	20
How to Clean the Unit after Use.....	21
List of Error Codes.....	22
Troubleshooting.....	23
Specifications.....	24

All for Healthcare

IM-HEM-907-E7-03-01/2012
5329412-4C

Intended Use

Medical Purpose	This is a medical device that measures the brachial blood pressure in a non-invasive manner.
Intended User	Legally certified: such as doctor, nurse and medical expert.
Patient Population	It is used on adult patients only.
Environment	The instrument is used in physicians' offices, hospitals, clinics and other medical facilities.
Measurement Parameter	<ul style="list-style-type: none">■ Non-invasive Blood Pressure■ Pulse rate
Precautions for use	Warnings and cautions described in the instruction manual should be observed.

Exemptions

OMRON will not bear any responsibilities on the following matters.

1. When a problem or damage occurs caused by the maintenance and/or repair conducted by a person other than OMRON or the dealer specified by OMRON
2. The problem or damage of OMRON product caused by the product of other manufacturer not delivered by OMRON
3. The problem and damage caused by the maintenance and/or repair using the repair parts not specified by OMRON
4. The problem and damage caused by the results not observing the Notes on Safety or the operational method mentioned in this Instruction Manual
5. Under the circumstances not within the operating conditions of this unit including the power source or the setting environment mentioned in this Instruction Manual
6. The problem and damage caused by the result(s) of remodeling or improper repair of this product
7. The problem and damage caused by act of god such as fire, earthquake, flood, or lightening

1. The contents of this Instruction Manual may be changed without prior notice.
2. We have thoroughly reviewed the contents of this Instruction Manual. However, if an inadequate description or error is found, please let us know.
3. It is prohibited to copy a part of or the entire Instruction Manual without getting OMRON's permission. Unless this Instruction Manual is used by an individual (company), it cannot be used without getting OMRON's permission from the standpoint of the Copyright Law.

Names and Functions of the Parts

Main unit

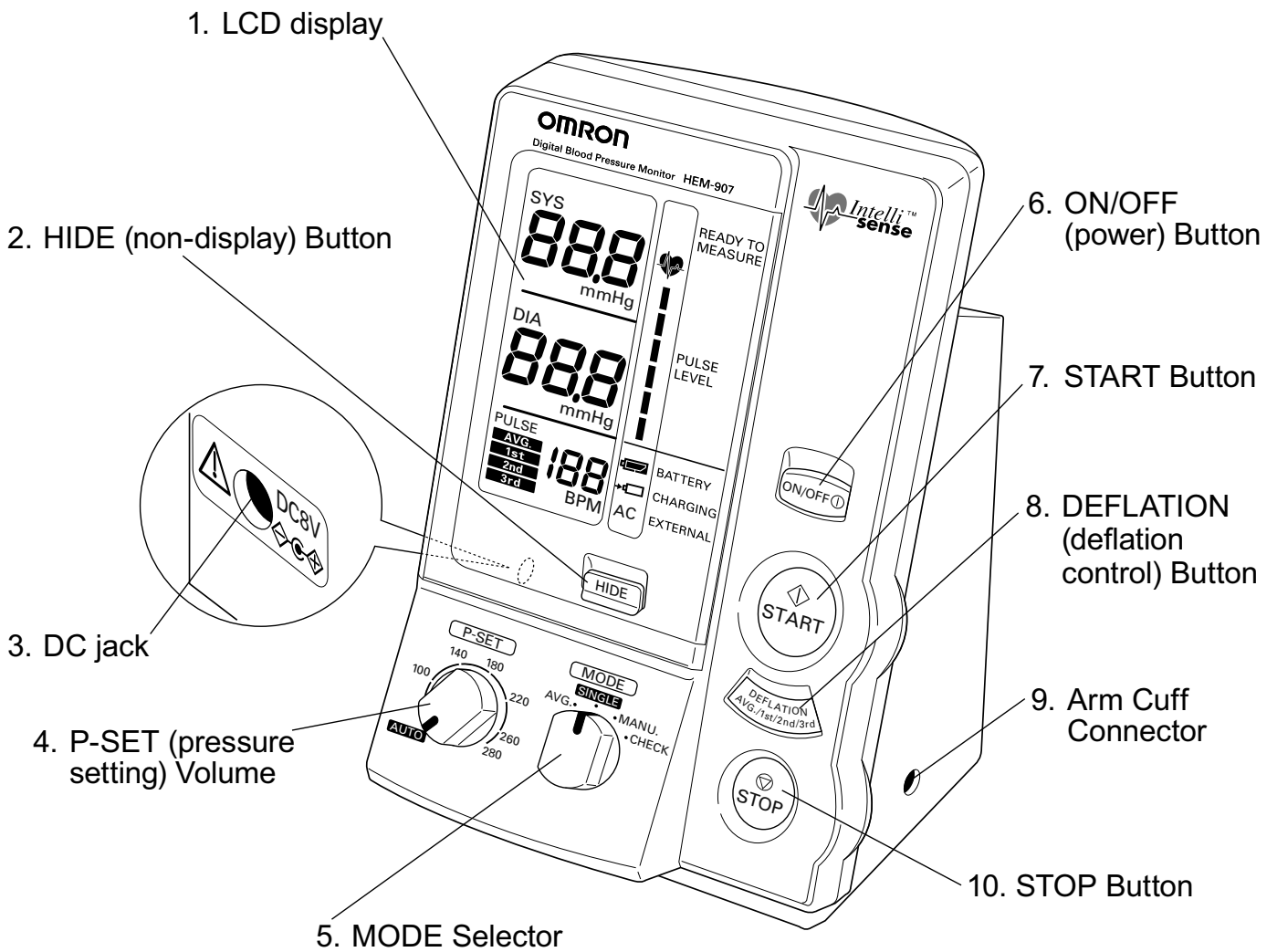

Names and Functions of the Parts

Explanation of Functions

(1) Pressure setting function P-SET

Inflation can be set by AUTO (automatic setting) or the target value.

AUTO (automatic setting): In the SINGLE (single measurement), AVG. (average), and MANU. (auscultation) Modes, the monitor estimates the systolic blood pressure value during inflation and automatically inflates to the proper value.

Target value setting: The monitor inflates to the target value. Pressure value is set to 30 to 40 mmHg above the expected systolic pressure.

(2) Non-display function HIDE

A function not to display the results of measured blood pressures. However, the pressure values during the measurement are displayed.

This function can be used when SINGLE (single measurement) or AVG. (average) Mode is selected.

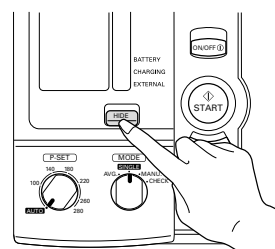

(3) Manual deflation control function DEFLATION AVG./1st/2nd/3rd

A function to accelerate the deflation speed by pushing a DEFLATION Button during deflation.

This function can be used when MANU. (auscultation) Mode is selected.

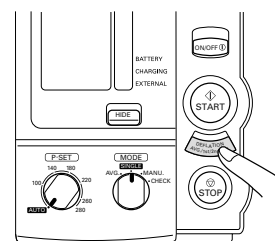

Names and Functions of the Parts

(4) Setting mode change function

You can set the number of times to measure, the waiting time until the start of measurement, and the interval between measurements.

	Items to set	Set value
F1	Number of measurements	2 times, 3 times
F2	Waiting time until the start of measurement	0 sec, 3 min, 5 min, 10 min.
F3	Measurement interval time	5 sec, 30 sec, 1 min, 2 min, 3 min.

Procedure to change the set values

- 1) When the power is off, press the ON/OFF Button for more than three seconds while holding the START Button and change the mode to the Setting Change Mode.
- 2) Press the START Button to select the item from F1 to F3.
- 3) Press the DEFLATION Button to change the set values.

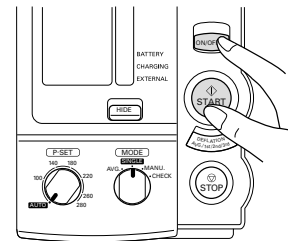



List of Functions for each Mode



Measurement Mode / Function	Single measurement (SINGLE)	Average (AVG.)	Auscultation (MANU.)	Check (CHECK)
Pressure setting function	<input type="radio"/>	<input type="radio"/>	<input type="radio"/>	—
Non-display function	<input type="radio"/>	<input type="radio"/>	—	—
Manual deflation control function	—	—	<input type="radio"/>	—
Setting mode change function	<input type="radio"/>	<input type="radio"/>	<input type="radio"/>	<input type="radio"/>





Notes on Safety

- The warning signs and the sample icons shown here are listed for you to use the product safely and correctly as well as to prevent the risk and the damage to you and others from happening.
- The icons and meanings are as follow.

Warning sign	Contents
 Warning	Indicates matters in which death or sever bodily damage may arise as a result of incorrect handling.
 Caution	Indicates matters in which bodily harm or material damage* may arise as a result of incorrect handling.





* Material damage refers to a wide range of damage involving your house, household goods, domestic animals, and pets.

Examples of signs	
	The \triangle icon indicates caution (including warning and danger). Matters involving actual caution are indicated by text or pictures in or near \triangle . The left icon refers to “caution for ignition”.
	The \ominus icon indicates prohibitions (what you cannot do). Matters involving actual prohibitions are indicated by text or pictures in or near \ominus . The left icon refers to “prohibition to disassemble”.
	The \bullet icon indicates something that is compulsory (always follow). Matters involving actual compulsory actions are indicated by text or pictures in or near \bullet . The left icon refers to “pulling the power source plug”.

 Warning	
If any abnormal matter occurs during the measurement such as inflation does not stop, remove the arm cuff or pull out the air tube from the main unit. • You may suffer peripheral neuropathy.	
Do not wrap the arm cuff over the arm to which intravenous injection or transfusion is being conducted. • Intravenous injection or transfusion is impossible.	
Do not use the unit in the place where inflammable gas, such as highly inflammable anesthetic, may be generated or in a high pressure oxygen room or an oxygen tent. • It may cause ignition and explosion.	
Do not touch the AC adapter with wet hands. • You may suffer electric shock.	

Notes on Safety

⚠ Caution

<p>When you are not going to use the unit for a long period of time, be sure to remove the AC adapter from the electric outlet.</p> <ul style="list-style-type: none"> You may suffer electric shock, or electric leak or fire may arise because of deteriorated insulation. Be sure to remove the AC adapter from the electric outlet when installing, removing, or cleaning the part. You may suffer electric shock or injure yourself. Pull the AC adapter from the electric outlet when cleaning the unit. You may suffer electric shock. 	
<p>In the following case, confirm the measurement with the stethoscope.</p> <p>(1) When an irregular pulse wave is displayed</p> <ul style="list-style-type: none"> An error may be displayed when an external vibration is applied or the patient moves his/her body. <p>(2) When an error is generated or the measured value is doubtful</p> <ul style="list-style-type: none"> An error may be displayed when an external vibration is applied or the patient moves his/her body. An error may be generated in the measured value or the blood pressure may not be able to measure for the patient having peripheral circulatory disturbance or extreme hypotension. An error may be generated in the measured value or the blood pressure may not be able to measure for the patient having short variation of blood pressure such as arrhythmia. <p>After cleaning the unit, dry it well, then insert the AC adapter to the electric outlet.</p> <ul style="list-style-type: none"> You may suffer electric shock. <p>Insert the AC adapter to the electric outlet as far as it goes.</p> <p>Wipe off the dust on the AC adapter.</p> <ul style="list-style-type: none"> You may suffer electric shock, or there may be short circuit or fire ignition. <p>If you find any trouble with this unit, immediately stop using it, turn off the power, pull out the AC adapter from the electric outlet, then contact the repair department.</p> <ul style="list-style-type: none"> You may suffer electric shock, or there may be short circuit or fire ignition. 	
<p>Do not disassemble or remodel the unit.</p> <ul style="list-style-type: none"> You may suffer electric shock, or there may be short circuit or fire ignition. 	
<p>Do not use the unit to the patient using a pump oxygenator.</p> <ul style="list-style-type: none"> The unit can not measure correctly. The unit cannot measure when it cannot detect any beat. <p>Do not use the AC adapter and the battery pack not specified for this unit.</p> <ul style="list-style-type: none"> It may cause fire or electric shock. <p>Do not use a portable phone near the unit.</p> <ul style="list-style-type: none"> The unit may malfunction. <p>Do not install the parts and/or instrument not specified for this unit.</p> <ul style="list-style-type: none"> It may cause damage to the unit. <p>Do not use the damaged power cord or AC adapter, or loose electric outlet.</p> <ul style="list-style-type: none"> You may suffer electric shock, or there may be short circuit or fire ignition. <p>Do not damage the power cord of the AC adapter by placing heavy thing on it or pinching it, or modify, forcibly bend, pull, twist, or bundle it.</p> <ul style="list-style-type: none"> You may suffer electric shock or there may be electric leak and fire because of deteriorated insulation. 	

Notes on Safety

Caution

Be sure to use the power supply of 230 VAC.

- It may cause fire or electric shock.
- Do not share an electric outlet with other unit or electric appliance.
- It may cause fire or electric leak.
- Do not pull the power cord when pulling out the AC adapter from the electric outlet.
- The power cord will be disconnected or shorted and may cause fire or electric shock.



Do not install or store the unit where it may be sprayed with water or medication.

- You may suffer electric shock.



Requests from OMRON

- Do not place or put anything on the unit.
- Do not apply strong shock to or drop the unit.
- When you move the unit, be sure to turn off the power and remove the connected AC adapter.
- When using this unit concurrently with other unit, be sure to read the Instruction Manual of the other unit to be used concurrently and understand the warnings and cautions before use.
- Be sure to confirm that all cords and tubes are connected correctly and completely before use.
- Inspect the Buttons and so on to confirm that the unit operates normally before use.
- When using a battery pack, be sure to confirm that the voltage is sufficient before use. If you are not going to use the unit for a long period of time, remove the battery pack.
- Do not inflate the arm cuff without being wrapped over the arm.
- Do not use a damaged arm cuff.
- Do not use the unit in a vehicle.
- Be sure to monitor all the time that the unit and the patient are not abnormal.
- Please keep the unit out of the reach of patient.
- Clean and store the unit and accessories after each use.
- Do not clean the unit with gasoline, thinner, or high concentration alcohol.
- Do not disinfect the unit by autoclave or gas sterilization (EOG, formaldehyde, or high concentration ozone.)
- Do not store the unit in the following places.
 - Under the direct sunshine
 - Dusty or salty environment
 - Places which slope, vibrate, and/or are prone to shocks
 - Storage of chemicals or where gas may be generated
 - Under high temperature and high humidity

Notes on Safety

Maintenance

1. Be sure to inspect the unit on regular basis. Check accuracy on a 1 year interval.
2. If the unit has not been used for a while, be sure to confirm that the unit operates normally and safely before use

Durability

The durability of this unit is five years. (Arm cuff is a consumable.)

Measures to take at the time of trouble or accident

If a device error (Er9) occurs, take the following procedure promptly.

1. Remove the arm cuff from the patient's arm.
2. Turn off the power and pull the AC adapter from the electric outlet. If an optional battery pack is used, remove it also.
3. Display "Trouble" on the unit so that it cannot be used.
4. Contact the dealer where you purchased the unit or the nearest OMRON dealer

Components of the Product

Main unit

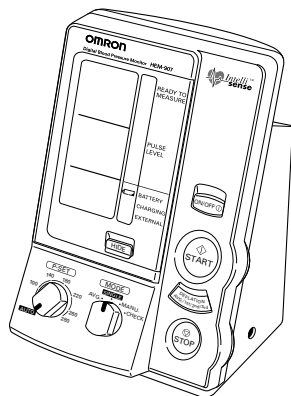

Accessories

Medium size arm cuff (with built-in air bag)
 Model: HEM-9CMC
 Art.no.: 4928640-0
 Applicable arm circumference: 22 to 32 cm

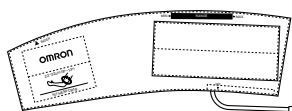

AC adapter
 (80230H907S)
 Model: HEM-9ADAP
 Art.no.: 1098200-0

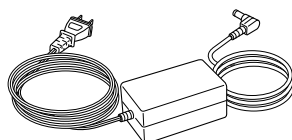

Instruction Manual
 (with guarantee card)

Air tube (1 m)
 Art.no.: 4928647-8

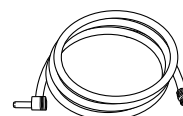

Battery pack
 (48H907N-E)
 Model: HEM-9BAT
 Art.no.: 1098391-0

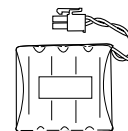

Options

Large size arm cuff
 Model: HEM-9CLC
 Art.no.: 4928654-0
 Applicable arm circumference:

32 to 42 cm

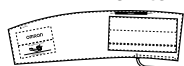

Medium size arm cuff
 Model: HEM-9CMC
 Art.no.: 4928640-0
 Applicable arm circumference:

22 to 32 cm

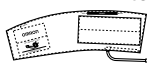

Small size adult arm cuff
 Model: HEM-9CSC
 Art.no.: 4928639-7
 Applicable arm circumference:

17 to 22 cm

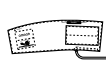

Air tube (1.3 m)
 Model: HEM-9T1.3
 Art.no.: 4928648-6

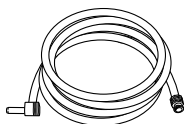

Stand exclusive
 for this unit
 Model: HEM-9ST
 Art.no.: 4928649-4

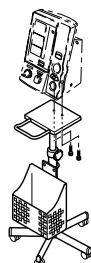

Wall-hanging kit
 Model: HEM-9WM
 Art.no.: 4928650-8

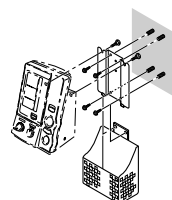

Pole-mounting kit
 Model: HEM-9PM
 Art.no.: 4928651-6

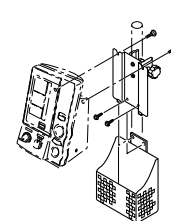

How to Apply the Arm Cuff

Warning

Do not apply the arm cuff during the intravenous injection or transfusion.
 • Intravenous injection or transfusion is impossible.



Requests from OMRON

- Do not use the unit to the patient using a pump oxygenator.
- Do not inflate the unit without applying the arm cuff.
- Do not use the damaged cuff.

1. Select the arm cuff according to the arm circumference of the patient.

Arm circumference	Name of the arm cuff
17 - 22 cm	Small size adult arm cuff (option)
22 - 32 cm	Adult arm cuff
32 - 42 cm	Large size adult arm cuff (option)

- Be sure to use the arm cuff suitable for the size of the patient's arm.
- If an arm cuff not suitable for the size of the arm is used, blood pressure may not be measured correctly.

2. Securely connect the air tube.

- If you connect the attached 1m air tube, the air tube can be used with the entire length of 1.2 m.

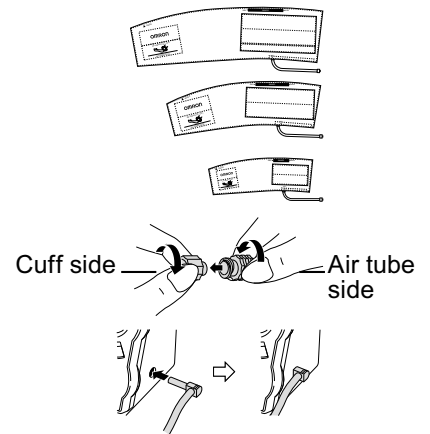

3. Prepare the patient to be ready to wrap the arm cuff.

- Wrap the arm cuff over the right upper arm's skin as a rule.
- If the arm cuff is wrapped over a thick cloth or by rolling up the jacket or shirt, blood pressure may not be measured correctly.

4. Place the right hand of the patient with the palm of hand facing upward.

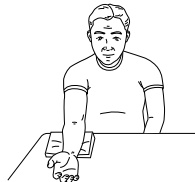

5. Place the arm cuff over the patient's arm by matching the mark indicating the artery position to the brachial artery.

ART. ▼

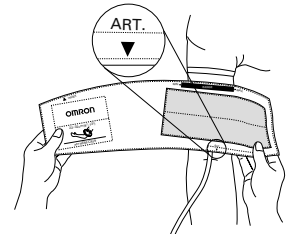

6. Wrap the arm cuff snugly using both hands and securely fasten it with the Velcro tape. At this time, the lower edge of the arm cuff must be placed 1 to 2 cm above the inner side of elbow joint.

- If the arm cuff is not wrapped snugly, patient may feel numbness on his/her arm, or blood pressure may not be measured correctly.
- The arm cuff wrapped diagonally along the shape of the arm does not affect the measurement value.

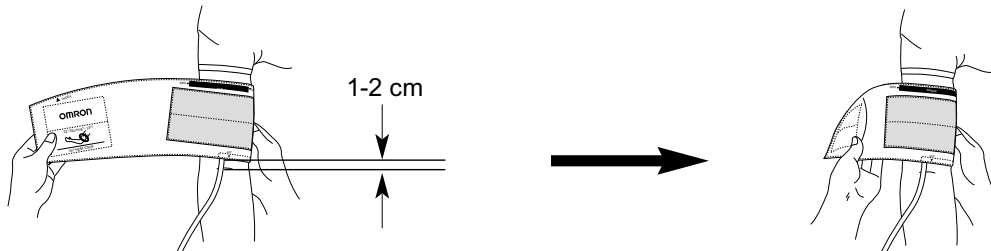

How to Apply the Arm Cuff (cont.)

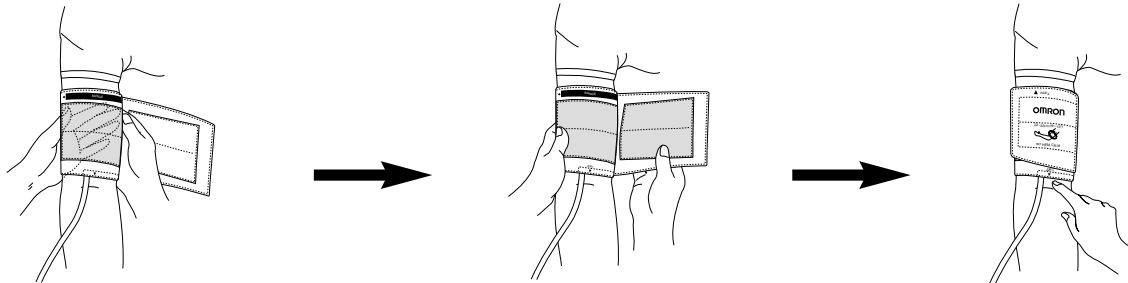

7. Adjust the level of the arm cuff to the level of the heart.

- Keep the level of the arm cuff at the same level as the heart during the measurement.

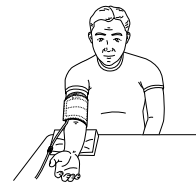

How to use the Power Source (AC adapter exclusive for this unit)

Warning

Do not use the unit in the place where inflammable gas, such as highly inflammable anesthetic, may be generated, or in the high pressure oxygen room or the oxygen tent.

- It may cause ignition and explosion.



Do not touch the AC adapter with wet hands.

- You may suffer electric shock.



Caution

Be sure to use the power supply of 230 VAC.

- It may cause fire or electric shock.



Do not install or store the unit where it may be sprayed with water or medication.

- You may suffer electric shock.



Requests from OMRON

- If this unit is used concurrently with other unit, be sure to read the Instruction Manual of the other unit to be used concurrently and understand the warnings and cautions before use.
- Inspect the Buttons to confirm that the unit operates normally before use.

Connect the AC adapter to the DC jack of the main unit [1] and the electric outlet [2].

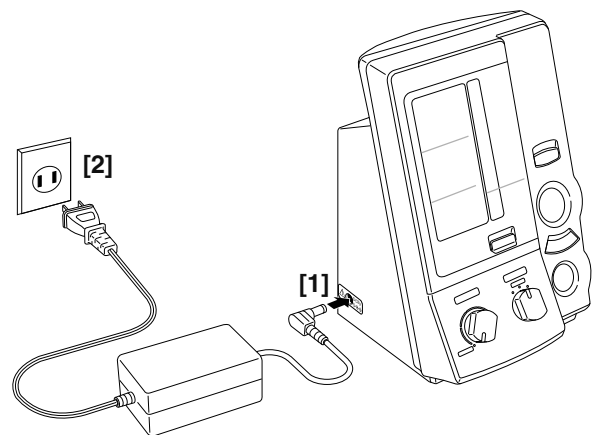

- When using an optional battery pack, the AC adapter functions as the charger also.

How to Measure Blood Pressure

Warning

If any abnormal matter occurs during the measurement such as the inflation does not stop, remove the arm cuff or pull the air tube from the main unit.

- You may suffer peripheral neuropathy.



Requests from OMRON

- Be sure that the patient should not touch the unit.
- Be sure to monitor all the time that the unit and the patient are not abnormal.
- Do not use the unit in a vehicle.

Caution

In the following case, confirm the measurement with the stethoscope.

- (1) When an irregular pulse wave is displayed
 - An error may be displayed when an external vibration is applied or the patient moves his/her body.
- (2) When an error is generated or the measured value is doubtful
 - An error may be displayed when an external vibration is applied or the patient moves his/her body.
 - An error may be generated in the measured value or the blood pressure may not be able to measure for the patient having peripheral circulatory disturbance or extreme hypotension.
 - An error may be generated in the measured value or the blood pressure may not be able to measure for the patient having short variation of blood pressure such as arrhythmia.



Do not use a portable phone near the unit.

- The unit may malfunction.



List of Measurement Modes

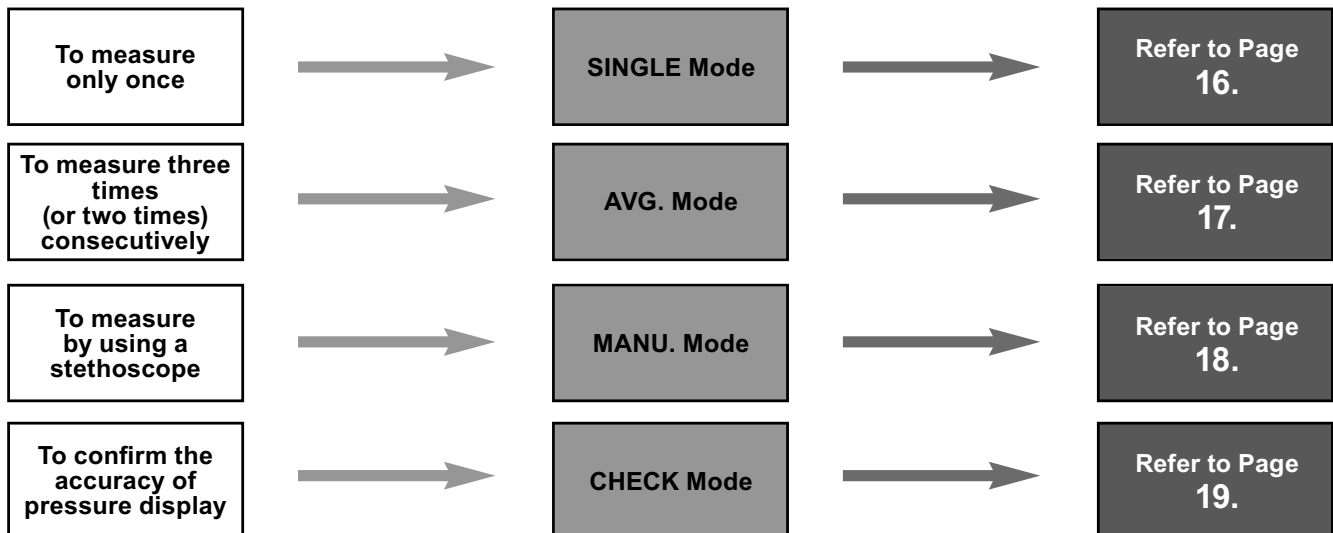

How to Measure Blood Pressure (in SINGLE Mode)

1. Wrap the arm cuff over the patient's arm.

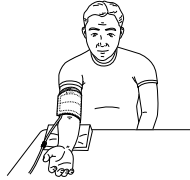

3. Set the MODE Selector to "SINGLE".

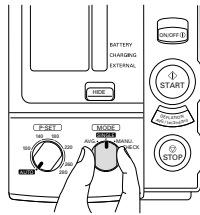

2. Push the ON/OFF (power) Button to turn on the power.

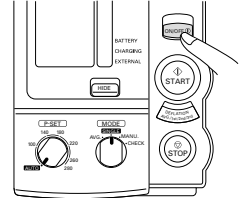

4. Set the P-SET (pressure setting) Volume to "AUTO" or the target inflation value.

- When setting the P-SET to "AUTO", turn the Volume counterclockwise as far as it goes until you can hear the click sound.
- When the systolic pressure is expected to exceed 220 mmHg, proper inflation may not be possible in "AUTO" setting. Set the target inflation value to 30 to 40 mmHg higher than the expected systolic pressure.

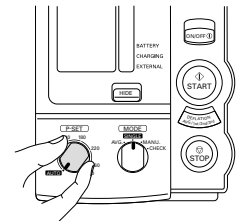

5. Push the START Button to start the measurement.

- If the inflation is determined insufficient, the unit may start inflation again automatically.
- If you want to stop measurement, push the STOP Button. The unit deflates fast.

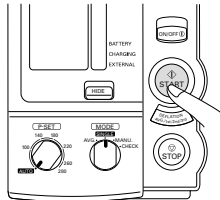

6. Measured results are displayed.

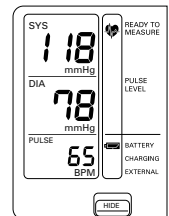

7. Push the ON/OFF (power) Button to turn off the power.

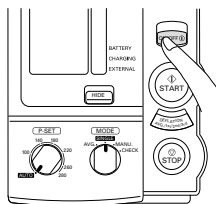

How to Measure Blood Pressure (in AVG. Mode)

1. Wrap the arm cuff over the patient's arm.

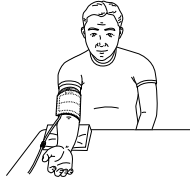

2. Push the ON/OFF (power) Button to turn on the power.

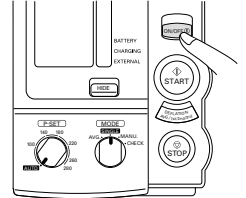

3. Set the MODE Selector to "AVG.".

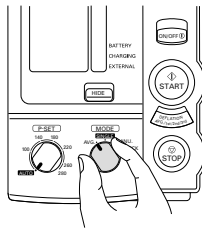

4. Set the P-SET (pressure setting) Volume to "AUTO" or the target inflation value.

- When setting the P-SET to "AUTO", turn the Volume counterclockwise as far as it goes until you can hear the click sound.
- When the systolic pressure is expected to exceed 220 mmHg, proper inflation may not be possible in "AUTO" setting. Set the target inflation value to 30 to 40 mmHg higher than the expected systolic pressure.

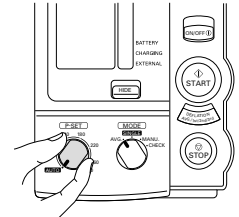

5. Push the START Button to start the measurement.

- Set the unit to the start time of the first measurement, then the unit starts measurement automatically.
- After displaying the results of first measurement, the unit will measure blood pressure in the set number of times automatically by taking an interval.
- For the setting of the number of measurements, the waiting time before start of measurement, and the interval time, refer to Page 7.

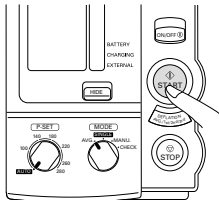

6. Measured results are displayed.

- After the measurement is completed, average values are displayed.
- Each time a DEFLATION (deflation control) Button is pushed, the measurement results for each time are displayed.

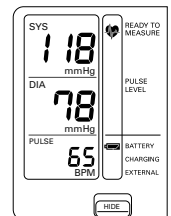

7. Push the ON/OFF (power) Button to turn off the power.

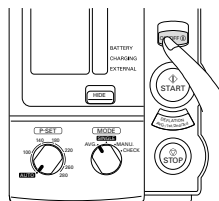

To stop the measurement during the measurement:
Push the STOP Button.
 To start the stopped measurement again:
Push the START Button.

How to Measure Blood Pressure (in MANU. Mode)

1. Wrap the arm cuff over the patient's arm.

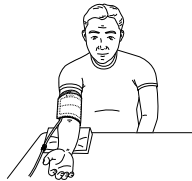

2. Place the stethoscope on the patient's arm.



3. Push the ON/OFF (power) Button to turn on the power.

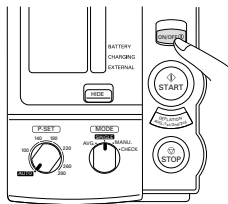

4. Set the MODE Selector to "MANU.".

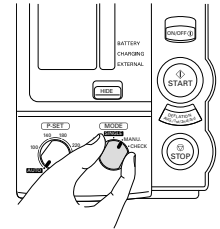

5. Set the P-SET (pressure setting) Volume to "AUTO" or the target inflation value.

- When setting the P-SET to "AUTO", turn the Volume counterclockwise as far as it goes until you can hear the click sound.
- When the systolic pressure is expected to exceed 220 mmHg, proper inflation may not be possible in "AUTO" setting. Set the target inflation value to 30 to 40 mmHg higher than the expected systolic pressure.

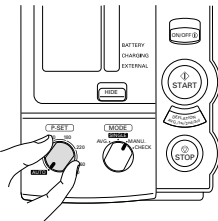

6. Push the START Button to start the measurement.

- In the "AUTO" setting, the unit stops inflation at the pressure considered to be 30 to 40 mmHg above the expected systolic pressure, then start deflation.
- The unit can be re-inflated only while the START Button is pushed.
- The pressure display is synchronized with the pulse rate and renewed.
- Each time the DEFLATION (deflation control) Button is pushed, the unit deflates by 5~10 mmHg.
- When you press the STOP Button, the unit deflates fast and ends the operation.

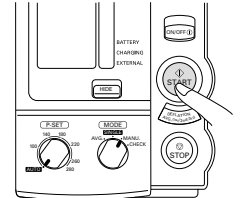

7. Push the ON/OFF (power) Button to turn off the power.

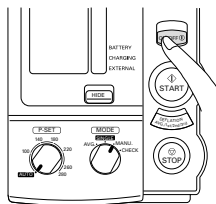

How to Measure Blood Pressure (in CHECK Mode)

Display of pressure can be confirmed by the CHECK Mode (yearly procedure).

What you need to prepare

- (1) Well-adjusted reference pressure monitor (including rubber ball),
- (2) T-shaped tube,
- (3) Two rubber tubes, and (4) something in the cylindrical shape to wrap the arm cuff such as the tea container (sturdy one that will not break or deform with pressure)

* Measurement error may occur even with the mercury blood pressure monitor because of insufficient amount of mercury in the mercury, dirty glass tube, or clogged glass tube cap.

How to use the blood pressure monitor

1. Connect the mercury blood pressure monitor, rubber ball, and this unit with the T-shaped tube as shown in the Figure.
2. Push the ON/OFF (power) Button to turn on the power.
3. Set the MODE Selector to "CHECK".
4. Tightly wrap the arm cuff over a sturdy cylindrical object.
5. Close the air release valve of rubber ball and inflate the monitor to a certain value (pressure to be checked).
6. Compare the value displayed on this monitor and that on the mercury.
7. Open the air release valve of rubber ball to deflate.

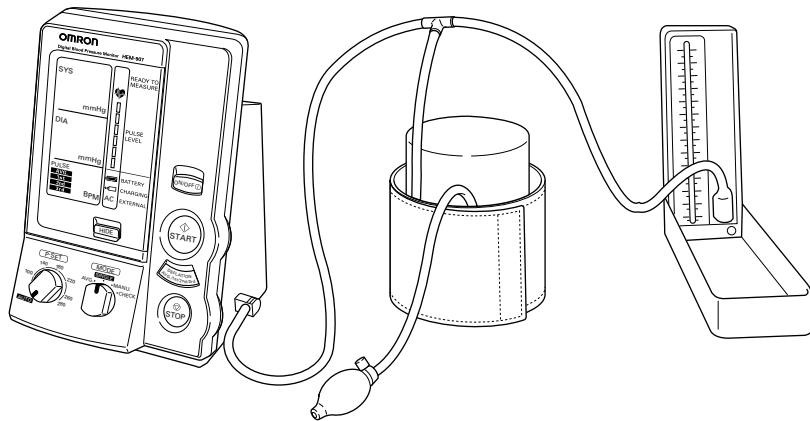

CHECK result

- (1) In the measuring rule, the test tolerance of blood pressure monitor (accuracy of pressure when shipped from the factory) should not exceed 3 mmHg.
- (2) If the CHECK result is +/- 3 mmHg or above, contact the dealer where you purchased this unit or the nearest OMRON dealer.

Installation and Replacement of Battery Pack

⚠ Warning

Do not disassemble or modify the battery pack.
Do not throw the battery pack into fire or heat it.
Do not charge the battery pack by using equipment other than this unit.

If the fluid in the battery pack gets into your eye, wash the eye with sufficient water without rubbing the eye. Then immediately consult the doctor for treatment.

- You may suffer injury, or battery fluid may leak, or battery may heat, ignite fire, or explode.



⚠ Caution

Do not short the polarities of battery using metal object such as the wire.

If the fluid in the battery is stained on your skin or cloth, immediately wash off the fluid with water.

- You may suffer injury, or battery fluid may leak, or battery may heat, ignite fire, or explode.



1. Remove the battery cover on the back of the main unit.

2. Installation: To install the battery pack, connect the battery pack connector to the connector in the battery cover.

Replacement: Remove the battery pack from the connector and replace with a new one.

3. Install the battery cover and fasten it with screws.

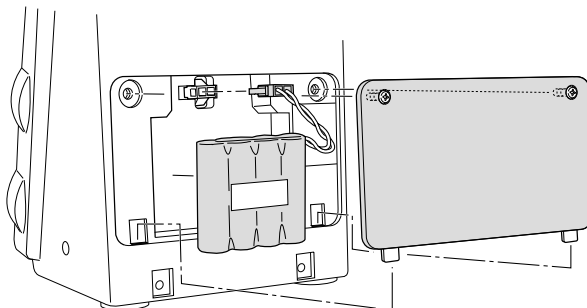



Battery life

- You can use the unit for approximately three hundred measurements.
- If a  mark appears frequently even after the battery is charged, replace the battery.
- Approximate battery life is two years.

Charging time

- After inserting the AC adapter, the battery will start to charge automatically in approximately five seconds.
- While the battery is being charged, a  mark turns on.
- The battery can be charged in approximately twelve hours.

Battery low

- Even after a  mark starts to flash, you can use the battery for twenty to thirty measurements. However it is better to charge the battery as soon as possible.
- If a  mark is displayed, the battery is low. Please charge the battery.

How to Clean the Unit after Use

⚠ Caution

Pull the AC adapter from the electric outlet when cleaning the unit.

- You may suffer electric shock.



After cleaning the unit, dry it well, then insert the AC adapter to the electric outlet.

- You may suffer electric shock.



Requests from OMRON

- Do not clean the unit with gasoline, thinner, or high concentration alcohol.
- Do not sterilize the unit by autoclave or gas sterilization (EOG, formaldehyde, or high concentration ozone.)

1. Clean the blood pressure monitor, the cuff and the cables using a cloth dampened with water, diluted disinfectant alcohol or diluted mild detergent.

- To disinfect, wipe the unit with a soft cloth squeezed well after moistened with the following disinfectant.

Benzalkonium chloride	0.01 - 0.2 w/v%
Chlorhexizin	0.05 - 0.5 w/v%
Amphoteric surface active agent	0.01 - 0.2 w/v%

- When cleaning or disinfecting the unit, do not wipe the AC adapter.

2. Then wipe the unit with a soft dry cloth.

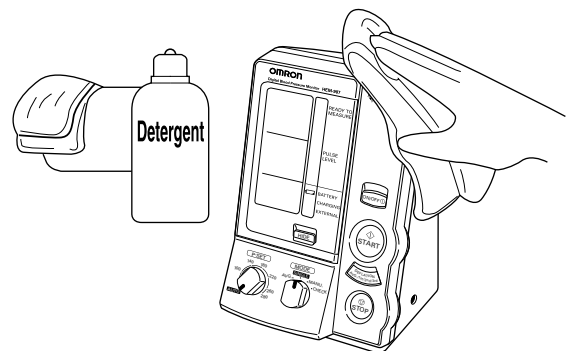

List of Error Codes

Error code	Cause	How to correct
Er1	Inflation error <ul style="list-style-type: none"> • When the pressure does not exceed 15 mmHg after operating a pump for 15 seconds from the start of inflation • When the inflation does not reach the set pressure of the arm cuff within the specified time after starting the inflation 	<ul style="list-style-type: none"> • If the connector of rubber tube connecting the arm cuff and the main unit is loose, connect them correctly, then measure. • If the rubber tube connecting the arm cuff and the main unit is bent, stretch it, then measure. • If the arm cuff is wrapped loosely, wrap it correctly, then measure.
Er2	Deflation error <ul style="list-style-type: none"> • When the deflation speed is too fast during the measurement • When the deflation speed is too slow during the measurement • When the measurement does not end within the specified time after starting the measurement • When the pressure is applied more than 5 minutes 	
Er3	Overpressure error <ul style="list-style-type: none"> • The arm cuff pressure exceeded 299 mmHg. 	<ul style="list-style-type: none"> • If the rubber tube connecting the arm cuff and the main unit is bent, stretch it, then measure.
Er4	Insufficient inflation error <ul style="list-style-type: none"> • Blood pressure could not be measured due to insufficient inflation after the measurement ends. 	<ul style="list-style-type: none"> • If the measurement is made by setting P-SET to "AUTO", ask the patient not move his/her arm or body during the inflation. • When setting the P-SET to "AUTO", turn the Volume counterclockwise as far as it goes until you can hear the click sound. • Set the P-SET to 30 to 40 mmHg higher than the systolic pressure of the patient, then measure.
Er5	Indeterminable blood pressure error <ul style="list-style-type: none"> • Blood pressure could not be measured even when the arm cuff pressure reached the specified pressure. 	<ul style="list-style-type: none"> • If the arm cuff is wrapped loosely, wrap it correctly, then measure.
Er6	Pulse wave small error <ul style="list-style-type: none"> • Pulse wave was too small. 	<ul style="list-style-type: none"> • If the arm cuff is wrapped loosely, wrap it correctly, then measure. • Do not wrap the arm cuff over a thick cloth or by rolling up the jacket or shirt.
Er7	Measurement error <ul style="list-style-type: none"> • Relationship between systolic and diastolic pressures was abnormal. 	<ul style="list-style-type: none"> • Check if the patient has an arrhythmia. • Ask the patient not to move his/her arm or body during the measurement.
Er8	Pulse rate error <ul style="list-style-type: none"> • Pulse rate did not stay within the range of 30 to 199 beats/min. 	
Er9	Device error <ul style="list-style-type: none"> • There is a problem with the main unit of the blood pressure monitor. 	<ul style="list-style-type: none"> • Contact the dealer where you purchased the unit or the nearest OMRON dealer.

Troubleshooting

If a trouble occurs while using the unit, please check the following.

Problem	What to inspect	How to correct
The unit inflates to abnormally high (low) pressure.	Is the arm cuff wrapped correctly?	Wrap the arm cuff correctly, and measure again.
	Is the patient moving his/her arm or body during inflation?	Ask the patient not to move his/her arm or body during measurement, and measure again.
	Does this trouble occur with a specific patient? For patients having arrhythmia, the unit may not inflate properly	Check the measurement by the stethoscope.
The unit cannot measure blood pressure. The blood pressure values are extremely high (low).	First of all, check the patient's condition.	After checking the patient with the stethoscope as needed, take a proper measure in accordance with the "list of error codes".
	Is the patient moving his/her arm or body during measurement?	Ask the patient not to move his/her arm or body during measurement, and measure again.
	Does the patient have an arrhythmia?	Check the patient with a stethoscope.
	Is the size of the arm cuff and the wrapping of arm cuff correct?	Select the arm cuff in accordance to the circumference of the patient's arm, wrap it correctly, then measure again.
	Is the level of the brachium to which the arm cuff is wrapped at the same level as the heart?	Keep the level of the brachium to which the arm cuff is wrapped at the same level as the heart, then measure again.

Specifications

Name	:	OMRON Digital Automatic Blood Pressure Monitor HEM-907
Model	:	HEM-907-E / HEM-907-E7
Display	:	Digital display
Measurement	:	Oscillometric method
Measurement Range	:	Pressure; 0 to 299 mmHg Pulse rate: 30 to 199 beats/min
Accuracy	:	Pressure; Within +/-3 mmHg Pulse rate; Within +/-5% of reading
Inflation	:	Automatic inflation with pumping
Deflation	:	Automatic deflation by electromagnetic control valve
Air Release	:	Automatic rapid air release by electromagnetic control valve
Power supply	:	AC adapter (230 VAC, 50 Hz. 20 VA) or battery pack (4.8 VDC, 6 W)
Electric Shock Protection Method	:	Class II B type
Operating Temperature and Humidity	:	10 to 40°C, 30 to 85% RH
Weight of Main Unit	:	Approximately 910 g
External Dimensions	:	139 (W) x 203 (H) x 131 (D) mm
Also included in the package	:	Adult arm cuff (with built-in air bag), AC adapter, air tube (1 m), Instruction Manual (with guarantee card)
Options	:	Large size adult arm cuff, adult arm cuff, small size adult arm cuff, cuff cloth of each size, air bag of each size, air tube (1.3 m), air tube (1 m), battery pack, stand exclusive for this unit, wall-hanging kit, pole-mounting kit

* Please understand that specifications may be changed without prior notice.

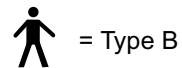

= Type B

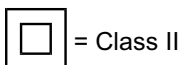

= Class II

CE 0197

This blood pressure monitor fulfils the requirements of the EC directive 93/42 EC directive 93/42/EEC (Medical Device Directive). It also conforms to the European standard EN 1060, Non-invasive Sphygmomanometers. Part 1: General Requirements an Part 3: Additional Requirements for Electromechanical Blood Pressure Measuring Systems.

Manufacturer 	OMRON HEALTHCARE Co., Ltd. 53, Kunotsubo, Terado-cho, Muko, Kyoto, 617-0002 JAPAN		
EU-representative <table border="1" data-bbox="140 667 331 743"> <tr> <td data-bbox="140 667 236 743">EC</td> <td data-bbox="236 667 331 743">REP</td> </tr> </table>	EC	REP	OMRON HEALTHCARE EUROPE B.V. Scorpius 33, 2132 LR Hoofddorp, THE NETHERLANDS www.omron-healthcare.com
EC	REP		
Production facility	OMRON HEALTHCARE Co., Ltd. Mie, JAPAN		
Subsidiary	OMRON HEALTHCARE UK LTD. Opal Drive Fox Milne, Milton Keynes, MK15 0DG, U.K.		
	OMRON MEDIZINTECHNIK HANDELSGESELLSCHAFT mbH John-Deere-Str. 81a, 68163 Mannheim, GERMANY www.omron-medizintechnik.de		
	OMRON SANTÉ FRANCE SAS 14, rue de Lisbonne, 93561 Rosny-sous-Bois Cedex, FRANCE		

Made in Japan

Important information for users

Important information regarding Electro Magnetic Compatibility (EMC)

With the increased number of electronic devices such as PC.s and mobile (cellular) telephones, medical devices in use may be susceptible to electromagnetic interference from other devices. Electromagnetic interference may result in incorrect operation of the medical device and create a potentially unsafe situation.

Medical devices should also not interfere with other devices.

In order to regulate the requirements for EMC (Electro Magnetic Compatibility) with the aim to prevent unsafe product situations, the EN60601-1-2 standard has been implemented. This standard defines the levels of immunity to electromagnetic interferences as well as maximum levels of electromagnetic emissions for medical devices.

This medical device manufactured by OMRON Healthcare conforms to this EN60601-1-2:2007 standard for both immunity and emissions.

Nevertheless, special precautions need to be observed:

- Do not use mobile (cellular) telephones and other devices, which generate strong electrical or electromagnetic fields, near the medical device. This may result in incorrect operation of the unit and create a potentially unsafe situation. Recommendation is to keep a minimum distance of 7 m. Verify correct operation of the device in case the distance is shorter.

Further documentation in accordance with EN60601-1-2:2007 is available at OMRON Healthcare Europe at the address mentioned in this instruction manual.

Documentation is also available at www.omron-healthcare.com.

Correct Disposal of This Product (Waste Electrical & Electronic Equipment)



This marking shown on the product or its literature, indicates that it should not be disposed with other household wastes at the end of its working life. To prevent possible harm to the environment or human health from uncontrolled waste disposal, please separate this from other types of wastes and recycle it responsibly to promote the sustainable reuse of material resources.

Household users should contact either the retailer where they purchased this product, or their local government office, for details of where and how they can take this item for environmentally safe recycling.

Business users should contact their supplier and check the terms and conditions of the purchase contract. This product should not be mixed with other commercial wastes for disposal.

This product does not contain any hazardous substances.

Disposal of used batteries should be carried out in accordance with the national regulations for the disposal of batteries.

EMC & WEEE

All for Healthcare

Free Manuals Download Website

<http://myh66.com>

<http://usermanuals.us>

<http://www.somanuals.com>

<http://www.4manuals.cc>

<http://www.manual-lib.com>

<http://www.404manual.com>

<http://www.luxmanual.com>

<http://aubethermostatmanual.com>

Golf course search by state

<http://golfingnear.com>

Email search by domain

<http://emailbydomain.com>

Auto manuals search

<http://auto.somanuals.com>

TV manuals search

<http://tv.somanuals.com>