

OMRON®

Instruction Manual

Body Composition MONITOR with Scale

Model **HBF-500**

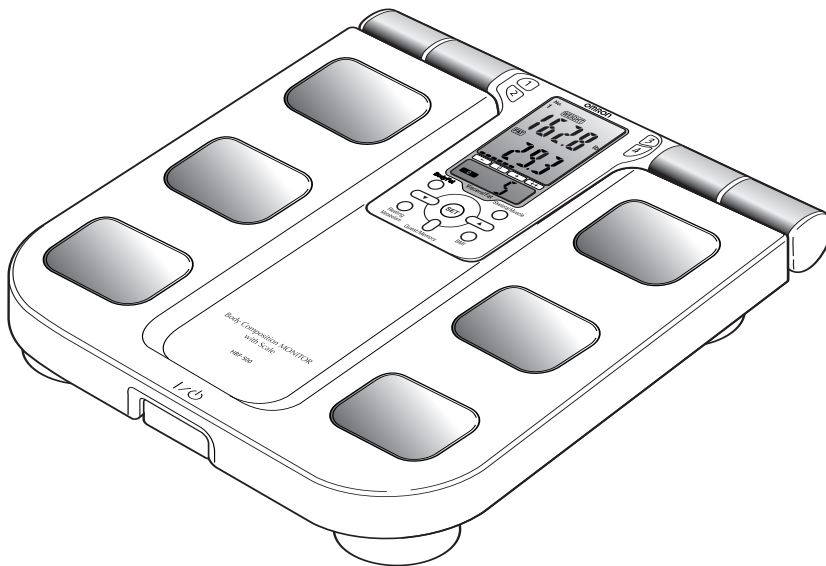

TABLE OF CONTENTS

Before Using the Monitor

Introduction	3
Safety Information	4
Useful Information	6
Body Mass Index and Ideal Weight	6
Body Fat	7
Visceral Fat	8
Resting Metabolism & Skeletal Muscle	9
Long-term Planning for Successful Weight Loss	11
Principle of Body Composition Calculation	12
Recommended Measurement Times	13

Operating Instructions

Know Your Unit	15
Battery Installation	18
Setting the Date and Time	20
Setting Personal Data	22
Changing Personal Data	24
How to Take a Measurement	26
How to Measure Weight Only	32
How to Use the Memory Function	33

Care and Maintenance

Error Indicators	37
Troubleshooting Tips	38
Care and Maintenance	39
FCC Statement	40
Warranty	41
Specifications	42
Notes	43

INTRODUCTION

Thank you for purchasing the OMRON® HBF-500 Body Composition MONITOR with Scale.

Fill in for future reference.

DATE PURCHASED: _____

SERIAL NUMBER: _____

Staple your purchase receipt here

The Body Composition MONITOR with Scale is easy to use. The monitor calculates the estimated values for body fat percentage with 12 levels, skeletal muscle percentage, resting metabolism and visceral fat level with two levels using the BI (Bioelectrical Impedance). The monitor also calculates the estimated BMI (Body Mass Index) in four ranges as well as weight. Push the power switch on, select your Personal Profile Number, and step onto the measurement platform. The personal memory function can be used to store data for up to four personal profiles. The memory function stores the measurement results for each personal profile from 1 day, 7 days, 30 days and 90 days ago.

Your HBF-500 comes with the following components:

- Main Unit
- Instruction Manual
- 4 “AA” Batteries

⚠ WARNING

Do not use, or allow others to use, this monitor if fitted with with a cardiac pacemaker or other implanted medical device.

⚠ WARNING

Pregnant women should not use this device.



⚠ CAUTION

Read all of the information in the instruction manual and any other literature in the box before operating the unit.













SAVE THESE INSTRUCTIONS

SAFETY INFORMATION

To assure the correct use of the product, basic safety measures should always be followed including the warnings and cautions listed in this instruction manual.

SAFETY SYMBOLS USED IN THIS INSTRUCTION MANUAL	
 WARNING	Indicates a potentially hazardous situation which, if not avoided, could result in death or serious injury.
 CAUTION	Indicates a potentially hazardous situation which, if not avoided, may result in minor or moderate injury to the user or patient or damage to the equipment or other property.

OPERATING THE DEVICE

-  This monitor cannot be used with a cardiac pacemaker or other implanted medical devices. The Body Composition MONITOR with Scale passes an extremely weak electrical current of 50kHz and less than 500 A through your body when taking a measurement to determine the amount of fat tissue. This weak current is not felt while using the monitor. Do not use, or allow others to use, this monitor if fitted with a cardiac pacemaker or other medical device.
-  Contact your physician or healthcare provider before beginning a weight reduction or exercise program.
-  Keep the monitor out of the reach of young children. Cord can become entangled and cause strangulation.
-  Persons with disabilities or persons that are physically frail should be assisted by another person when using this monitor or use a handrail, a walker, or other support device to prevent falling when stepping on and off the monitor.
-  Read all of the information in the instruction manual and any other literature in the box before operating the unit.
-  Do not use mobile telephones, microwave and other devices that generate strong electrical or electromagnetic fields near the monitor. This may result in an operational failure.
-  Do not step on the edge or the display area of the measurement platform. The monitor may tilt. The display unit may be damaged.
-  Do not step on the measurement platform when your body or feet are wet, for example after taking a bath or shower. You may slide and lose your balance.
-  Do not place the monitor on a cushioned floor surface such as a carpet or mat. A correct measurement may not be possible.
-  Do not use the unit on slippery surfaces such as tile floors or wet floors. A monitor may move. You may lose your balance and fall.
-  Do not jump on the measurement platform. You may lose your balance and fall. The monitor may be damaged.
-  Stand on the measurement platform with bare feet. Attempting to stand on the measurement platform when wearing socks may cause you to slip and lose your balance.

SAFETY INFORMATION

OPERATING THE DEVICE (continued)

- ⚠ Should battery fluid leak and contact your eyes, skin or clothing immediately rinse with plenty of clean water. Immediately contact your physician in case of eye contact. (or skin, but not clothing.)
- ⚠ Dispose of the device, batteries, components and optional accessories according to applicable local regulations. Unlawful disposal may cause environmental pollution.
- ⚠ Operate the unit only as intended. Do not use for any other purpose.
- ⚠ This unit is intended for home use only. It is not intended for professional use in hospitals or other medical facilities. This unit does not support the standards required for professional use.

CARE AND MAINTENANCE

- ⚠ Do not disassemble or modify the unit. Changes or modifications not approved by Omron Healthcare will void the user warranty.
- ⚠ Do not subject the monitor to strong shocks, such as dropping the unit on the floor.
- ⚠ Do not submerge the device or any of the components in water.



USEFUL INFORMATION

⚠ WARNING

Contact your physician or healthcare provider before beginning a weight reduction or exercise program.

BODY MASS INDEX AND IDEAL WEIGHT

Everybody is concerned about their weight. But what is the basis for determining your ideal weight? The key is Body Mass Index.

How to Calculate BMI

BMI is short for Body Mass Index. This index uses the following simple formula to indicate the ratio between weight and height of a person.

$$\text{BMI} = \text{weight (lb)} / \text{height (inch)} / \text{height (inch)} \times 703$$

The OMRON HBF-500 uses the height information stored in your Personal Profile Number to calculate your BMI classification.

Let's look at an example

Example of display:

- Weight: 162.8 lb
- BMI: 27.7
- BMI Classification: +

Interpreting the BMI Result

BMI	BMI (Designation by the WHO)	BMI Classification Bar				BMI Rating
		-	0	+	++	
Less than 18.5	- (Underweight)	■				7.0 - 10.7 10.8 - 14.5 14.6 - 18.4
18.5 or more and less than 25	0 (Normal)	■■■	■■■			18.5 - 20.5 20.6 - 22.7 22.8 - 24.9
25 or more and less than 30	+ (Overweight)	■■■■	■■■■	■■■		25.0 - 26.5 26.6 - 28.2 28.3 - 29.9
30 or more	++ (Obese)	■■■■■	■■■■■	■■■■■	■■■	30.0 - 34.9 35.0 - 39.9 40.0 - 90.0

The above-mentioned indices refer to the values for obesity judgment proposed by WHO, the World Health Organization.



USEFUL INFORMATION

BODY FAT

Hidden Fat Not Revealed by BMI

Although BMI calculates a simple obesity level, there is also hidden fat that not revealed by a BMI designation.

Although both cases are for people of similar height and weight, and their BMI designation are normal, the body fat percentage for case B is high.

That is, although case B has normal body weight, the actual fat level is high, revealing the “hidden fat.” This hidden fat may lead to increased susceptibility to common diseases, even though the BMI designation is normal.

Examples of hidden fat

CaseA		CaseB	
F	Gender	F	Gender
34	Age	34	Age
5' 7 7/8"	Height	5' 7 1/2"	Height
144.0 lb	Weight	141.0 lb	Weight
22.0 (Normal)	BMI	21.8 (Normal)	BMI
27.2%	Body fat percentage	34.5%	Body fat percentage
Normal		High	

Body fat percentage classification

Let's look at an example

Example of display:

- Body Fat Percentage: 29.3 %
- Body Fat Percentage Classification: 0

When most people think of body fat, they have a negative image of it. However, body fat serves a vital role in storing energy, protecting internal organs, etc. While too much body fat may be unhealthy, having too little may also be unhealthy. The distribution of body fat in men and women is different, so the basis of classifying the body fat percentage for males is different than for females.

Interpreting the Body Fat Percentage Result

Gender	Age	Low (-)	Normal (0)	High (+)	Very High (++)
Female	20-39	< 21.0	21.0 - 32.9	33.0 - 38.9	≥ 39.0
	40-59	< 23.0	23.0 - 33.9	34.0 - 39.9	≥ 40.0
	60-79	< 24.0	24.0 - 35.9	36.0 - 41.9	≥ 42.0
Male	20-39	< 8.0	8.0 - 19.9	20.0 - 24.9	≥ 25.0
	40-59	< 11.0	11.0 - 21.9	22.0 - 27.9	≥ 28.0
	60-79	< 13.0	13.0 - 24.9	25.0 - 29.9	≥ 30.0

Based on NIH/WHO guidelines for BMI

Based on Gallagher et al., American Journal of Clinical Nutrition, Vol. 72, Sept. 2000



USEFUL INFORMATION

VISCERAL FAT

Body fat is classified as subcutaneous fat or visceral fat, depending on where it is located in the body.

Visceral fat = fat surrounding the internal organs

Too much visceral fat is thought to be closely linked to increased levels of fat in the bloodstream, which can lead to common conditions such as high cholesterol, cardiovascular disease and diabetes. In order to prevent or improve conditions of these common diseases, it is important to try and reduce the visceral fat levels to an acceptable level.

Subcutaneous fat = fat below the skin

Subcutaneous fat not only accumulates around the stomach but also around the upper arms, hips and thighs, and can cause a distortion of the body's proportions. Although not directly linked to increased risk of disease, it is thought to increase pressure on the heart and may be associated with other complications. Subcutaneous fat is not displayed separately in this unit, but is included in the body fat percentage.

MRI Cross Section of at the Navel Level

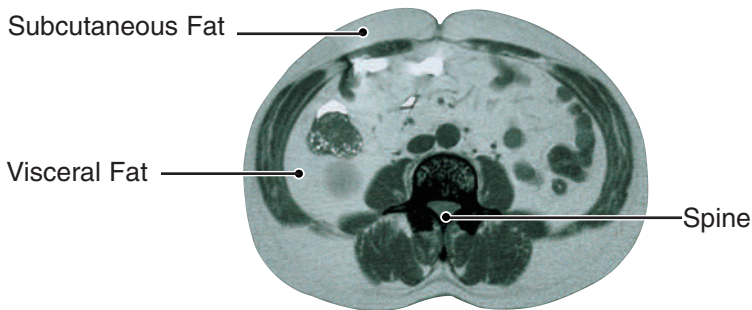

Let's look at an example

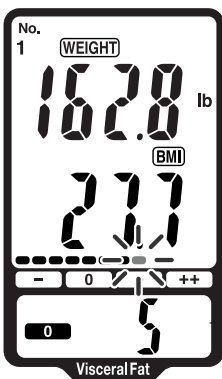



VISCERAL FAT LEVEL/
VISCERAL FAT
CLASSIFICATION

Example of display:

- Visceral Fat Classification: 0
- Visceral Fat: 5

Interpreting the Visceral Fat Level Result

 Visceral Fat Level ≤ 9	 Visceral Fat Level ≥ 10
0 (Normal)	+ (High)

Visceral fat area (0 - Approx. 300 cm², 1 inch=2.54 cm) distribution with 30 levels.

Level Classification

0: 1 - 9 level

+: 10 - 30 level

* The data referenced by Omron Healthcare.

NOTE: Visceral fat levels are relative and not absolute values.



USEFUL INFORMATION

RESTING METABOLISM & SKELETAL MUSCLE

Skeletal muscle is muscle that is connected to bone and used to move parts of the body. The maintenance and increase of this skeletal muscle is closely linked to resting metabolism.

What is resting metabolism?

Regardless of your activity level, a minimum level of energy is required to sustain the body's everyday functions. Resting metabolism, the amount of calories needed to supply the body with the minimum level of energy, differs between individuals depending on variables such as age, weight, body composition, and energy expenditure.

Let's look at an example

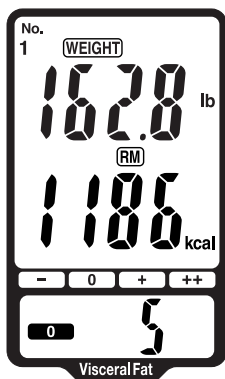

RESTING METABOLISM

Example of display:

- Resting Metabolism: 1186 kcal

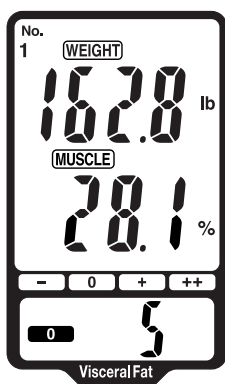

SKELETAL MUSCLE PERCENTAGE

Example of display:

- Skeletal Muscle Percentage: 28.1%

60-70% of daily energy use is for resting metabolism

The total amount of energy burned by the body in a typical day is as follows.

Resting metabolism	Energy required to maintain vital functions.
Daily activity metabolism	Energy used for daily activities such as commuting to work, household chores, hobbies, etc.
Diet-induced thermogenesis	Energy emitted after eating a meal.

The ratio of these is 60%-70% for resting metabolism, 20%-30% for daily activity, and 10% for diet induced thermogenesis. This means that resting metabolism accounts for most of our daily energy consumption.

If our daily food intake exceeds the amount of energy required for these activities, the additional energy is stored as fat.

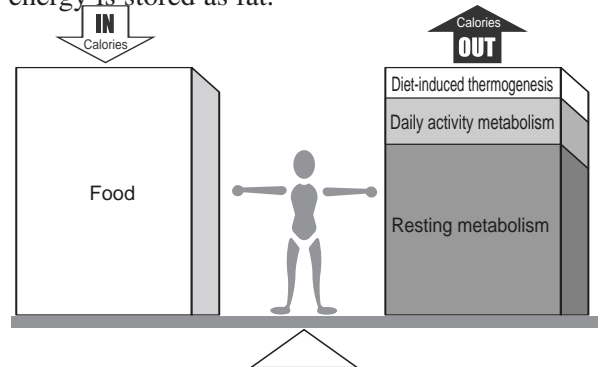



USEFUL INFORMATION

What is skeletal muscle?

Muscle is divided into two types, muscle in internal organs, such as the heart, and muscle attached to bones that is used to move the body. Skeletal muscle can be increased through exercise and other activity.

Resting metabolism reduces as we get older

Resting metabolism level peaks in the late teenage years and then gradually reduces over the years. This leads to reductions in the body's functions as we get older and in particular, it is one of the main causes for muscle reduction as we get older.

Even when not being used to move parts of the body, muscles burn energy throughout the day to generate heat for the body which is part of the resting metabolism. As the amount of muscle decreases, so does the amount of energy burned. If people continue to eat the same amount of food as when they are younger, then they develop "middle-age spread."

In order to avoid this, it is important to know your resting metabolism and maintain muscles through exercise.



USEFUL INFORMATION

LONG-TERM PLANNING FOR SUCCESSFUL WEIGHT LOSS

Ignoring a balanced diet and simply reducing food intake to lose weight can lead to a decline in muscle and bone. So even though your weight goes down, your resting metabolism is reduced making the body more prone to putting on fat.

Example comparing the same loss of 20 lb:

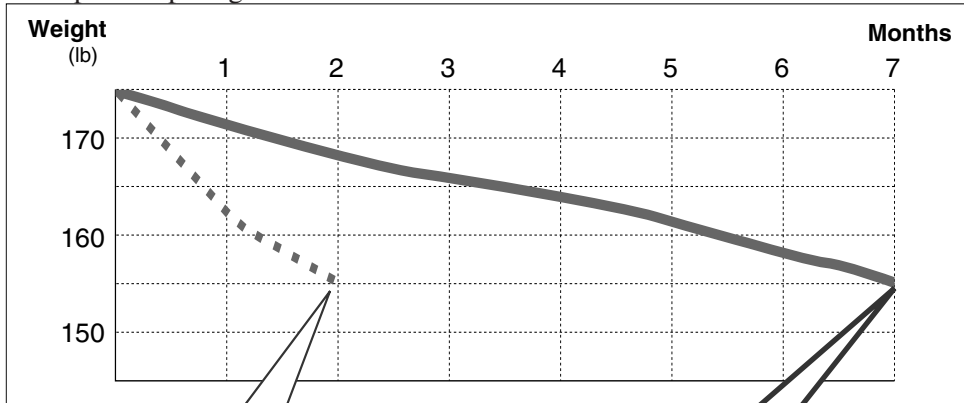

A starvation diet produces rapid weight loss of 20 lb, but disrupts body mass...

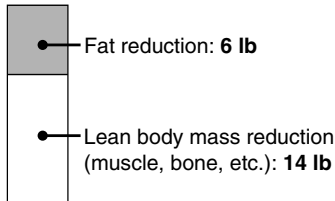

Change in body fat percentage

Body fat percentage
 Before diet: **36.0%**
 ↓
 After diet: **36.9%**

Lean body mass (muscle, bone, etc.) greatly reduced, while the body fat percentage has not changed.

A healthy diet with weight loss of 20 lb...

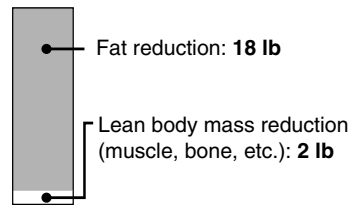

Change in body fat percentage

Body fat percentage
 Before diet: **36.0%**
 ↓
 After diet: **28.3%**

Body fat percentage reduced to a normal level.

*This is an extreme case of the effect.

Repeated dieting and regaining weight leads to increased visceral fat levels

It is easy to regain weight after sudden diets. This regained weight tends to appear as visceral fat rather than subcutaneous fat. Increased visceral fat levels are thought to increase the likelihood of common diseases. Repeated dieting and subsequent regaining of weight may lead to increased visceral fat levels.



USEFUL INFORMATION

PRINCIPLE OF BODY COMPOSITION CALCULATION

What is the Bioelectrical Impedance Method?

The HBF-500 estimates the body fat percentage by the Bioelectrical Impedance (BI) method. Muscles, blood vessels and bones are body tissues with high water content that conduct electricity easily. Body fat is tissue that has little electric conductivity. The HBF-500 sends an extremely weak electrical current of 50 kHz and less than 500 μA through your body to determine the amount of each tissue. This weak electrical current is not felt while operating the HBF-500.

How to Calculate the Body Composition

The following methods have been the established method for accurate evaluation of body composition.

Body Fat Percentage: This is based on the DXA (Dual Energy X-Ray Absorptiometry) method, which uses two different x-rays to make a quantitative assessment of the amount of fat in the body.

Resting Metabolism: This is based on exhalation analysis, where the composition of exhaled air is analyzed. This makes it possible to calculate the resting metabolism by measuring the consumption of oxygen in exhaled air.

Visceral Fat Level: This is based on MRI (Magnetic Resonance Imaging) analysis, which uses nuclear magnetic resonance to make non-intrusive images of the body. This makes it possible to calculate the area of visceral fat at cross section of abdomen.

Skeletal Muscle Percentage: This is based on MRI (Magnetic Resonance Imaging) analysis, which uses nuclear magnetic resonance to make non-intrusive images of the body. This makes it possible to calculate the amount of skeletal muscle in the body.

Omron has developed a formula referring to the above methods. The body composition is calculated by a formula that includes five factors: electrical resistance, height, weight, age and gender.

Measures the whole body to avoid the influence of fluctuations

The ratios of the water in your upper body and lower body may change through the day. This means that the electrical impedance of the body also varies. Since the HBF-500 uses electrodes for both the hands and feet to take measurements, it can reduce the influence of water movement on measurement results.



USEFUL INFORMATION

RECOMMENDED MEASUREMENT TIMES

Understanding the normal changes in your body fat percentage can help you in preventing or reducing obesity. Being aware of the times when the body fat percentages shift within your own daily schedule will assist you in obtaining an accurate trending of your body fat. It is recommended to use this unit in the same environment and daily circumstances. Reference the chart below:

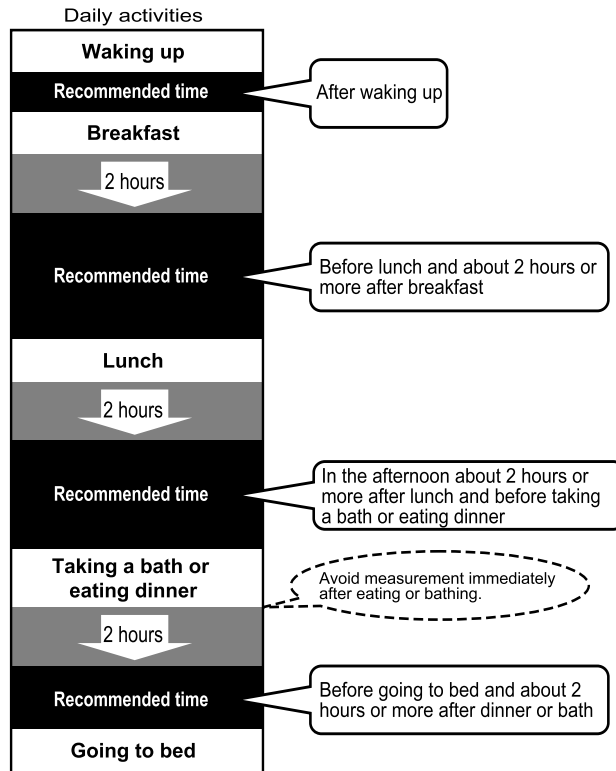

Avoid Taking Measurements Under the Following Conditions

If a measurement is taken under the following physical conditions, the calculated body composition may differ significantly from the actual one because the water content in the body is changing: Immediately after vigorous exercise, after a bath or sauna, after drinking alcohol, after drinking a large amount of water or after a meal (1 to 2 hours).



USEFUL INFORMATION

The reason calculated results may differ from actual body fat percentage

There are certain conditions when significant differences may occur between the estimated and the actual body fat values. These differences may be related to changing ratios of body fluid and/or body composition.

The body fat percentage measured by this monitor may significantly differ from the actual body fat percentage in the following situations:

- Elderly people
- People with a fever
- Body builders or highly trained athletes
- Persons undergoing dialysis
- Persons with osteoporosis who have very low bone density
- Pregnant women
- Post-menopausal women
- Persons with edema (Swelling in the body)
- Children in growth stage

KNOW YOUR UNIT

Display Unit

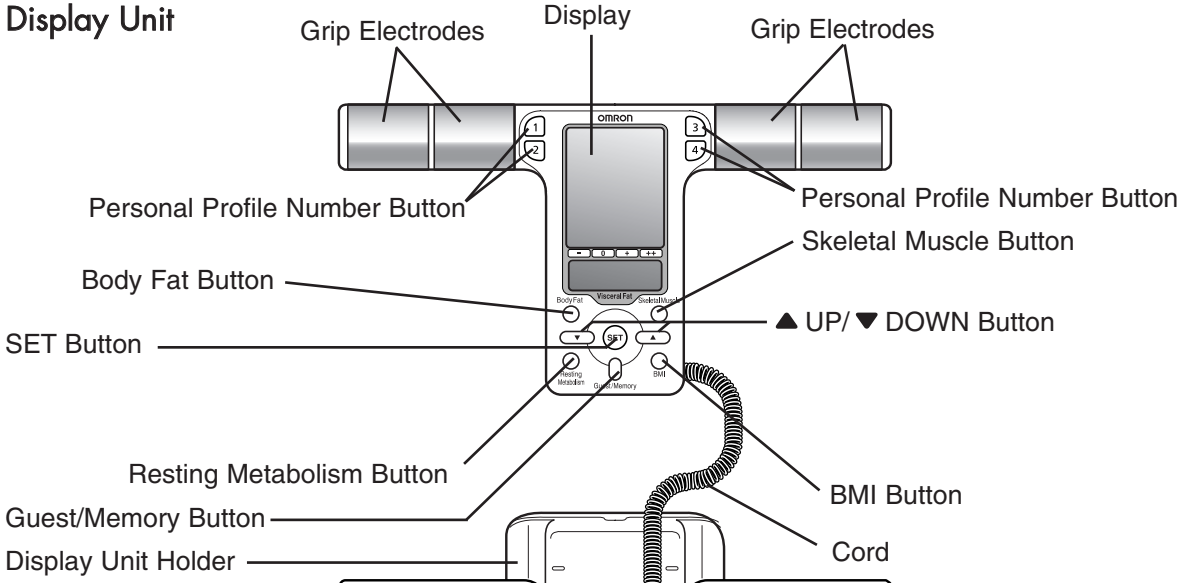

Main Unit (Measurement Platform)

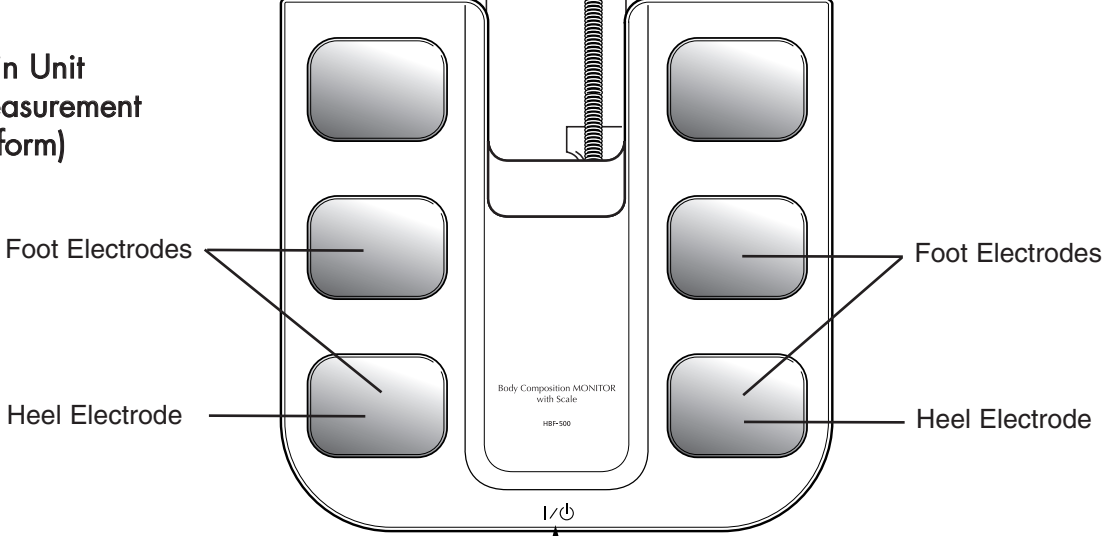

Front View

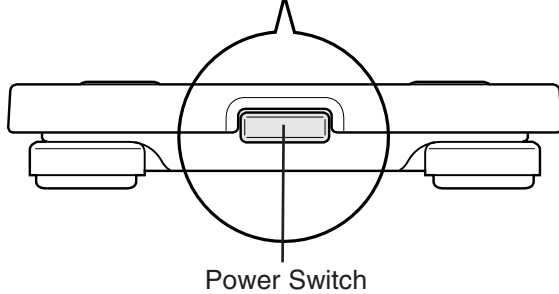

Components

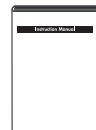
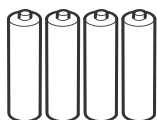

Instruction Manual

KNOW YOUR UNIT

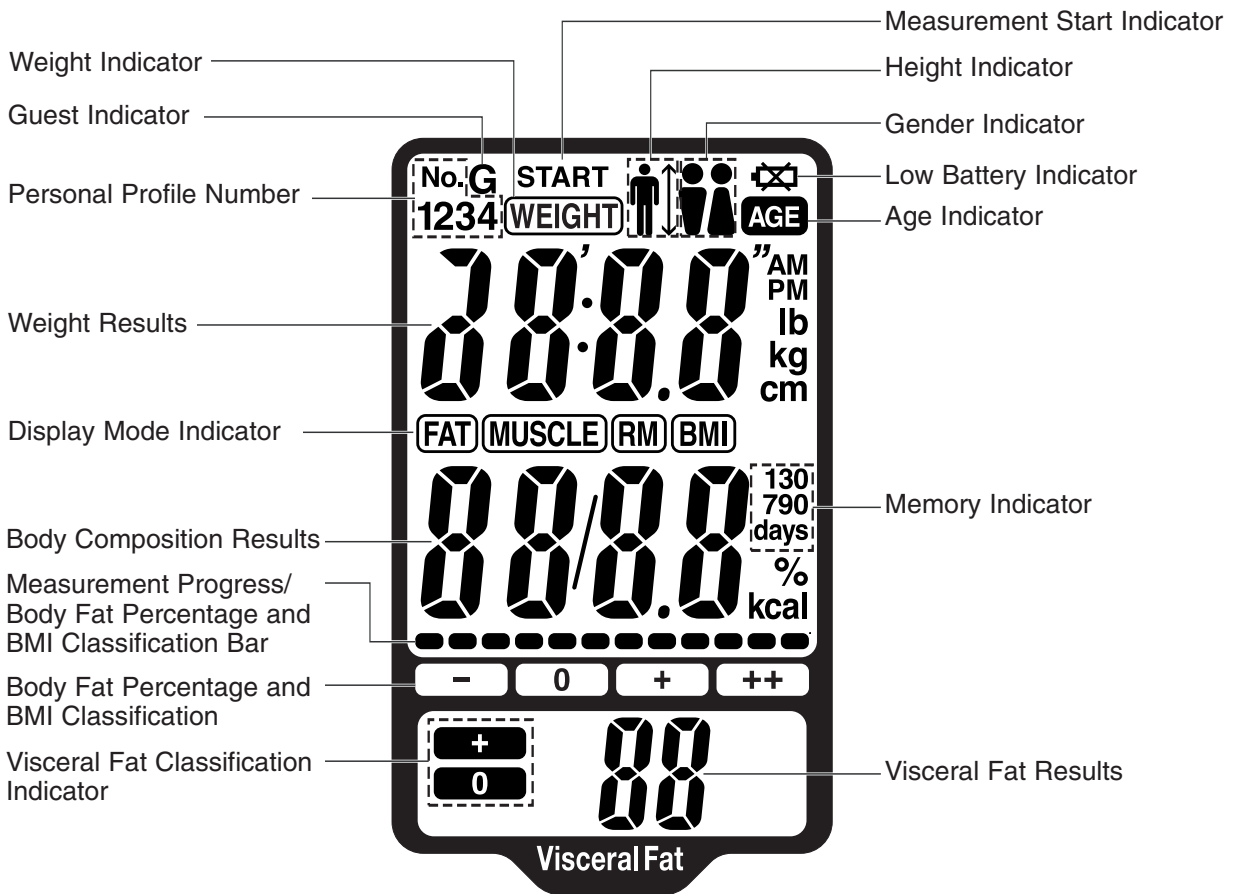

KNOW YOUR UNIT

⚠ WARNING

Contact your physician or healthcare provider before beginning a weight reduction or exercise program.

USING THE DISPLAY UNIT

Extend the cord as illustrated to the right.

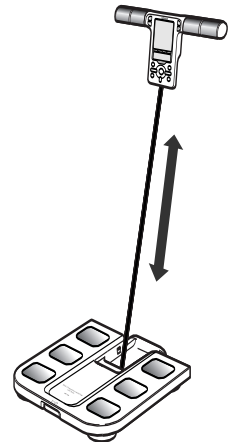

STORING THE DISPLAY UNIT

1. Coil the cord into the Display Unit Holder.

Make sure the cord is coiled evenly, and does not stick out of the Display Unit Holder.

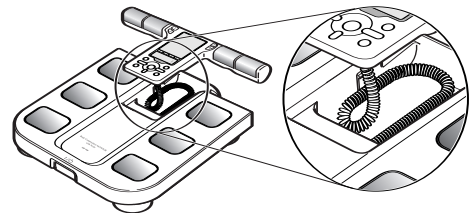

2. Place the Display Unit into the Display Unit Holder.

The display unit will click into place.

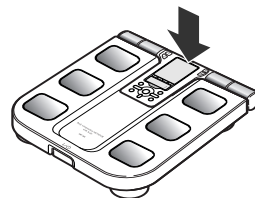

POWER SWITCH

The power will automatically switch off in the following conditions:

1. If the monitor is not used within one minute of 0.0 lb appearing on the display.
2. If no information is entered for 5 minutes when entering personal data.
3. If the monitor is not used for 5 minutes after the measurement results are displayed.
4. Five (5) minutes after the result is displayed when measuring weight only.

BATTERY INSTALLATION

1. Locate the Battery Cover on the back of the unit.

- 1) Press the tab on the battery cover in the direction of the arrow to release the cover as illustrated.
- 2) Pull the tab of the cover upwards.

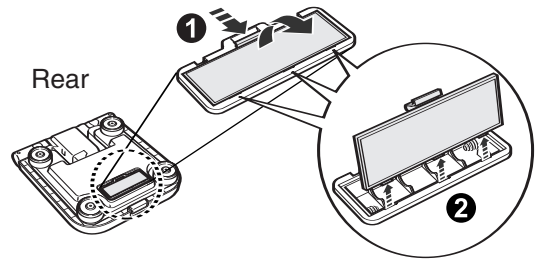

2. INSTALL 4 “AA” SIZE BATTERIES so the + (positive) and – (negative) polarities match the polarities of the battery compartment as indicated in the battery compartment.

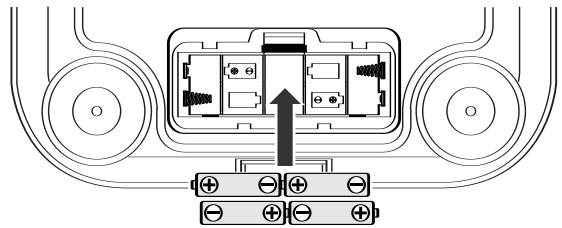

3. Replace the battery cover.

- 1) Align the hooks on the battery cover with the slots in the battery compartment.
- 2) Push the battery cover until the tab clicks into place.

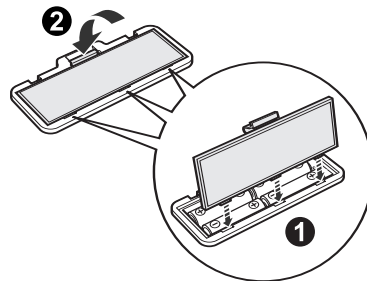

BATTERY INSTALLATION

BATTERY REPLACEMENT

Measurement values and personal profiles stored in the memory will not be deleted during battery replacement. The date and time will need to be set when monitor is turned on.

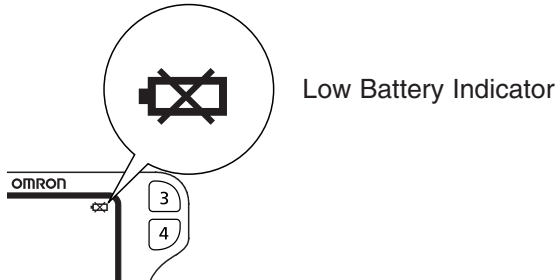

When the Low Battery Indicator appears on the display screen remove all four worn batteries. Replace with four new batteries at the same time.

NOTES:

- New batteries will last for approximately one year if the unit is used four times per day. Trial batteries supplied with the unit may have a shorter life.
- Remove the batteries if you do not intend to use the unit for a period of three months or longer before placing in storage.

⚠ CAUTION:

Should battery fluid leak and contact your eyes, skin or clothing immediately rinse with plenty of clean water. Immediately contact your physician.

⚠ CAUTION:

Dispose of the device, batteries, components and optional accessories according to applicable local regulations. Unlawful disposal may cause environmental pollution.

SETTING THE DATE AND TIME

When the power is turned on for the first time, it is necessary to set the date and time.

Buttons Used in this Procedure

SET Button

Use this button to confirm the setting or move to the next item after confirming the set item.

▼ DOWN Button

Press this button to go back one. Press continuously to rapidly decrease.

▲ UP Button

Press this button to advance one. Press continuously to rapidly advance.

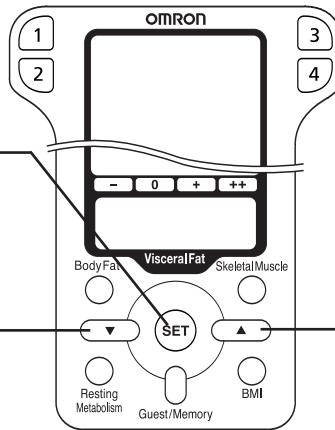

1. Press the Power Switch to turn the monitor ON.

If this is the first time that the monitor has been turned on, the year setting flashes.

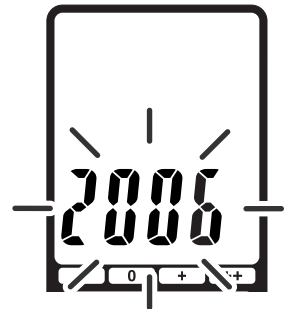
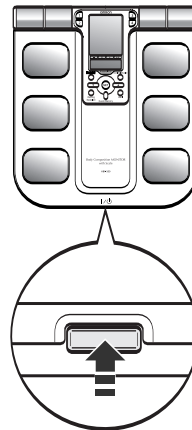

2. SETTING THE YEAR

1) Press the ▲ UP or ▼ DOWN button to change the year.

2) Press the SET button.

The year is set.

The month flashes on the display.

3. SETTING THE MONTH

1) Press the ▲ UP or ▼ DOWN button to change the month.

2) Press the SET button.

The month is set

The day flashes on the display.

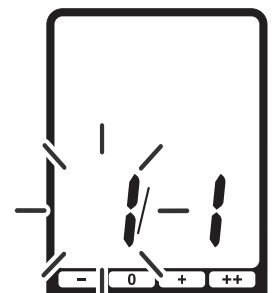

SETTING THE DATE AND TIME

4. SETTING THE DAY

- 1) Press the ▲ UP or ▼ DOWN button to change the day.
- 2) Press the SET button.
The day is set.
The hour flashes on the display.



5. SETTING THE HOUR

- 1) Press the ▲ UP or ▼ DOWN button to change the hour.
- 2) Press the SET button.
The hour is set.
The minute flashes on the display.

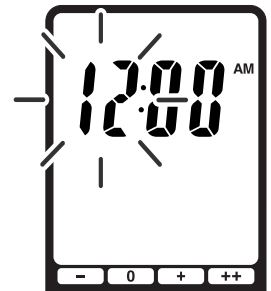

6. SETTING THE MINUTE

- 1) Press the ▲ UP or ▼ DOWN button to change the minute.
- 2) Press the SET button.

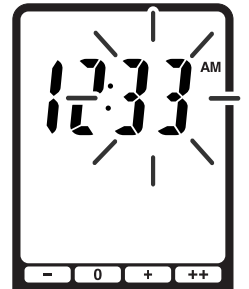

The current settings for the year, month and day, hour and minute appear in this sequence on the display. The monitor automatically turns off.

TO ADJUST THE DATE AND TIME

- 1) Turn the monitor on.
The CAL symbol blinks on the display, then the display changes to 0.0 lb. Wait until 0.0 lb appears on the display.
- 2) Press and hold the SET button.
The year flashes on the display.
- 3) Refer to page 20, SETTING THE YEAR, to begin changing the Date and Time.

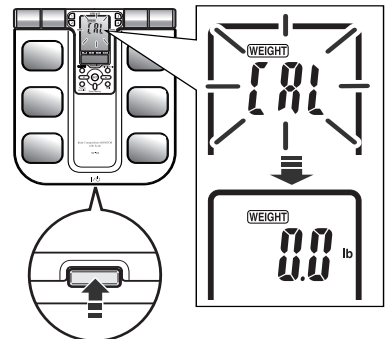

SETTING PERSONAL DATA

To measure Body Composition, your personal data must be set. Your personal data includes your age, gender and height. The Body Composition Monitor with SCALE provides two options to enter your personal data.

- 1) Select a personal profile number to save your personal data. The monitor saves up to 4 personal profiles. Select a number 1 through 4. Use this number to enter your personal data and when taking a measurement.
- 2) Select Guest/Memory button if you do not want your personal data stored in the memory. When you use the Guest option you will need to enter your personal data each time you take a measurement. Measurement results are not stored in the memory when the Guest option is used to take a measurement.

Buttons Used in this Procedure

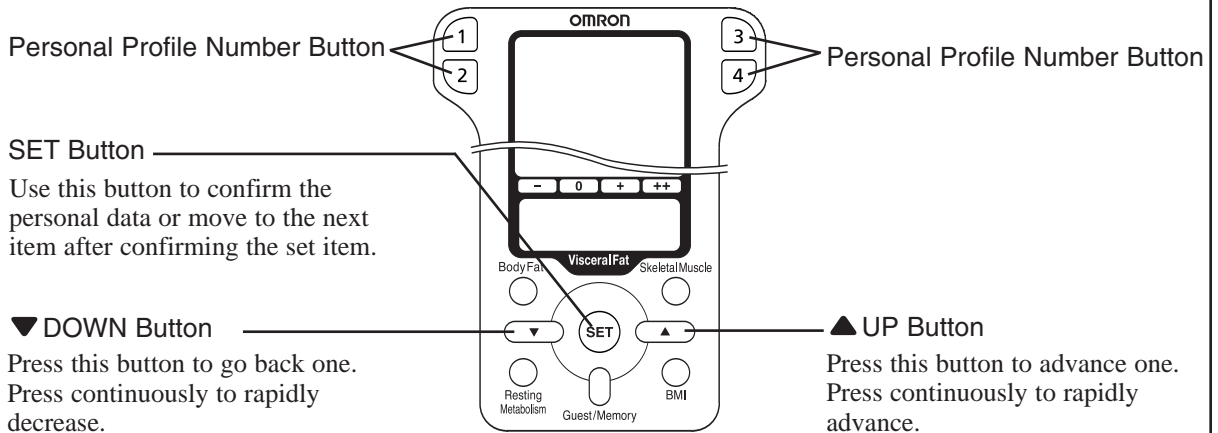

1. Press the Power Switch to turn the monitor ON.

The CAL symbol blinks on the display, then the display changes to 0.0 lb.
Wait until 0.0 lb appears on the display.

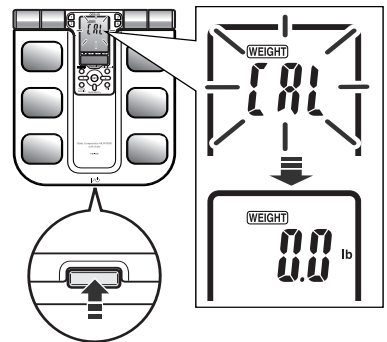

2. Lift the Display Unit out of the Display Unit Holder.

NOTE: This monitor can be set to either the US or Metric System. Personal Profile and memory will be displayed by selected system. To change the US/Metric mode:

- 1) Press and hold the ▲ UP button until "lb" and "kg" blink on the display.



- 2) Press the ▲ UP or ▼ DOWN button to select the mode, "lb" or "kg".
- 3) Press the SET button to confirm the change.

SETTING PERSONAL DATA

3. Select a Personal Profile or GUEST as your Personal Data Option.

A. Personal Profile

Press the desired Personal Profile Number button (1 through 4).
Press the SET button.

NOTE:

- 1) If no information has been entered for the Personal Profile Number you selected, the number and the symbols for gender, age and height blink on the display.
- 2) If the personal data has been entered for the number, the Personal Profile Number blinks on the display.

B. GUEST

Press the Guest/Memory button.
The Guest indicator appears.

The default value for age blinks on the display.

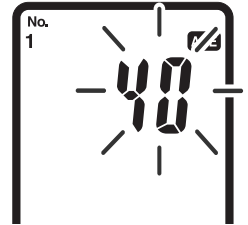
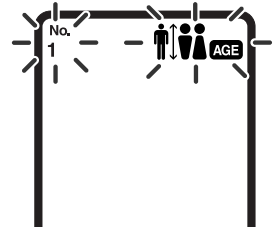

4. Enter your Personal Data

SETTING THE AGE

Set the age between 10 and 80.

- 1) Press the ▲UP or ▼DOWN button to change the age.

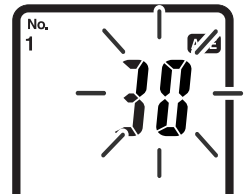

- 2) Press the SET button.

The age is set.

The gender symbols blink on the display.



SETTING PERSONAL DATA

SETTING THE GENDER

Set the gender to **♂** MALE OR **♀** FEMALE

1) Press the **▲UP** or **▼DOWN** button to change the gender.

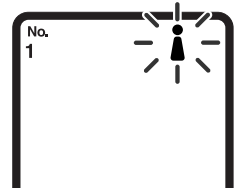

2) Press the **SET** button.

The gender is set.

The default value for height blinks on the display.

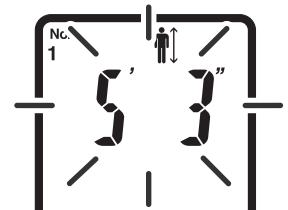

SETTING THE HEIGHT

Set the height between 3'4" and 6'6 3/4".

(Display range in metric display mode: 100.0 cm to 199.5 cm)

1) Press the **▲UP** or **▼DOWN** button to change the height.

2) Press the **SET** button.

The height is set.

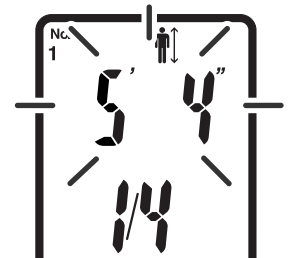

The current settings for age, gender, and height appear in this sequence on the display.

The 0.0 lb symbol appears on the display. You can now take a measurement using the Personal Profile Number you selected or the Guest Mode.

Refer to page 26, HOW TO TAKE A MEASUREMENT.

CHANGING PERSONAL DATA

If your personal data changes, the information in the Personal Profile Number you selected must be changed for measurement results to be calculated correctly.

1. Press the **Power Switch** to turn the monitor ON.

The CAL symbol blinks on the display, then the display changes to 0.0 lb.
Wait until 0.0 lb appears on the display.

2. Lift the **Display Unit** out of the **Display Unit Holder**.

SETTING PERSONAL DATA

3. Select the Personal Profile Number you want to change.

- 1) Press the Personal Profile Number button (1 through 4).
The selected Personal Profile Number flashes once on the display.
- 2) Press the SET button.
The Personal Profile Number is set.
The current SETTING for age blinks on the display.

4. Refer to page 23, enter your personal data to begin changing the personal data.

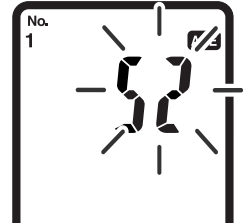

DELETING PERSONAL PROFILE

1. Press the Power Switch to turn the monitor ON.

The CAL symbol blinks on the display, then the display changes to 0.0 lb. Wait until 0.0 lb appears on the display.

2. Select the Personal Profile Number you want to delete.

- 1) Press the Personal Profile Number button to select a Personal Profile Number.
The display of the selected Personal Profile Number flashes once.
- 2) Press the SET button.
The Personal Profile Number is confirmed and the selected age setting blinks on the display.

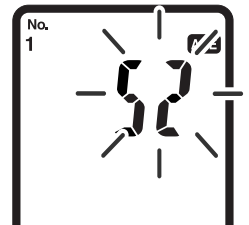

3. Press the Guest/Memory button for 2 seconds.

The personal data and measurement values are deleted from the memory. The Clr symbol appears on the display followed by the Personal Profile Number and the symbols for gender, age and height as illustrated below.

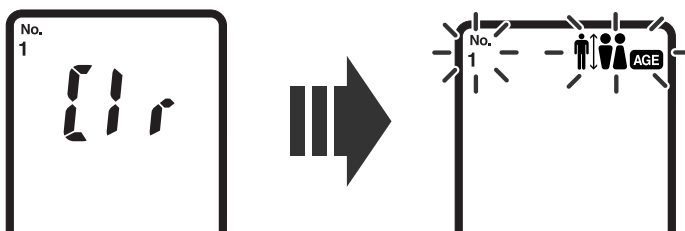
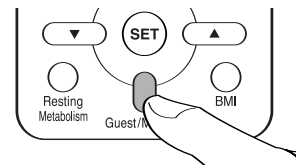

HOW TO TAKE A MEASUREMENT

YOUR PERSONAL DATA MUST BE ENTERED BEFORE TAKING A MEASUREMENT.

⚠ CAUTION:

Consult your physician before using this monitor when pregnant.

⚠ CAUTION:

Persons with disabilities or persons that are physically frail should be assisted by another person when using this monitor or use a handrail, a walker, or other support device to prevent falling when stepping on and off the monitor.

CORRECT POSTURE FOR MEASUREMENT

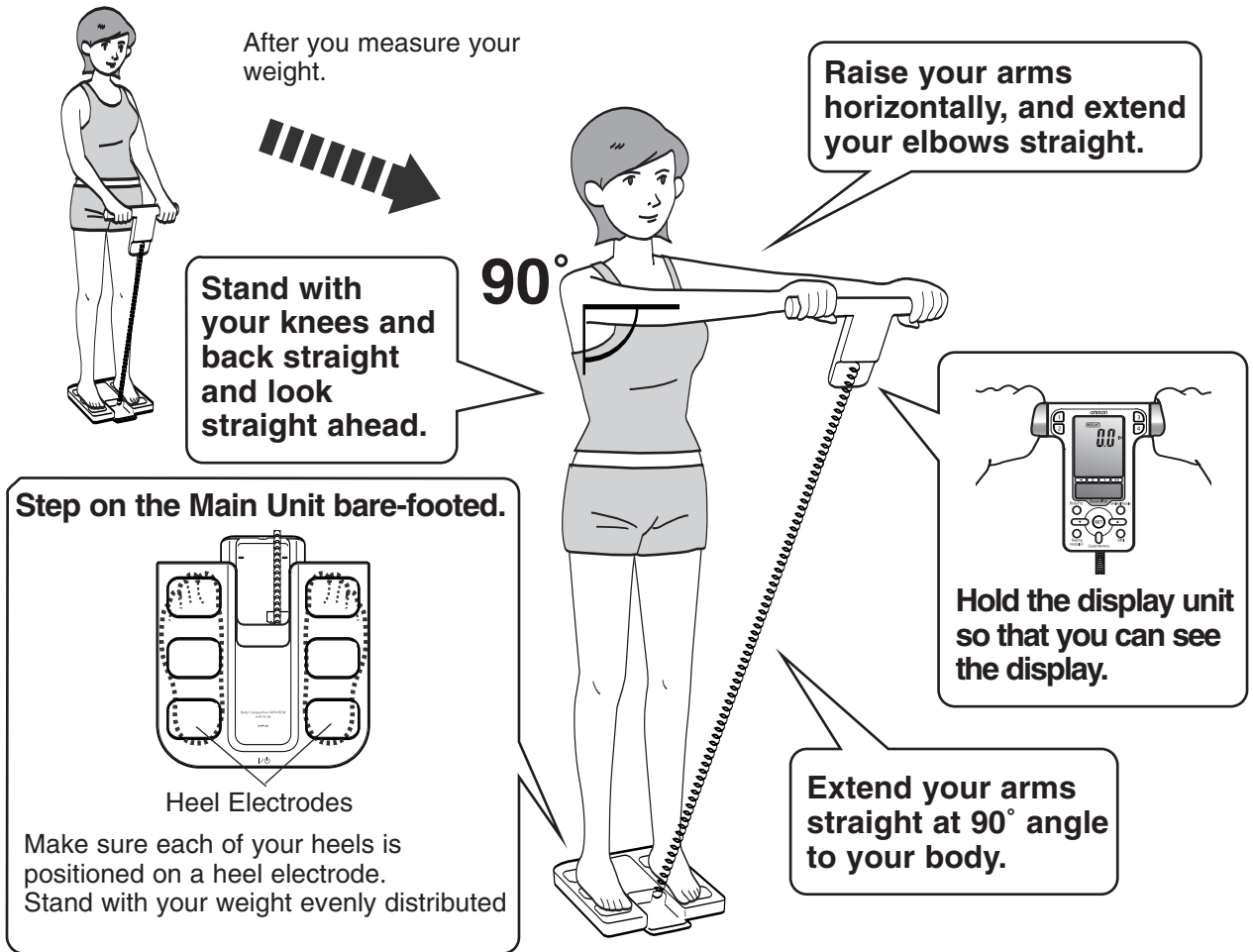

POSTURES TO AVOID DURING MEASUREMENT

Incorrect posture may result in inaccurate measurement of Body Composition.



Movement during measurement



Arms bent

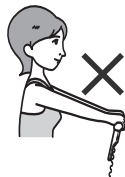

Arms too low or high



Display facing upwards

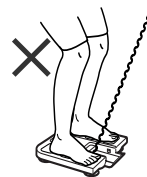

Knees bent

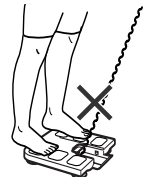

Standing on edge of monitor

HOW TO TAKE A MEASUREMENT

HOW TO MEASURE BODY COMPOSITION

1. Press the Power Switch to turn the monitor ON.

The CAL symbol blinks on the display, then the display changes to 0.0 lb.

Wait until 0.0 lb appears on the display.

NOTES:

- If you step onto the monitor before 0.0 lb appears on the display, an error message “Err” will appear.
- This monitor can be set to either the US or Metric System. Personal Profile and Memory will be displayed by selected mode. To change the US/Metric mode:

1) Keep the ▲ UP button pressed until “lb” and “kg” blink on the display.



2) Press the ▲ UP or ▼ DOWN button to select the mode, “lb” or “kg”.

3) Press the SET button to confirm the change.

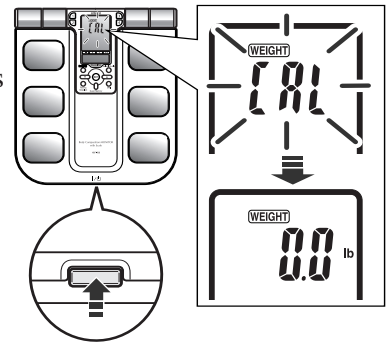

2. When the 0.0 lb appears on the display, lift the Display Unit out of the Display Unit Holder.

NOTE: Do not take out the display unit until 0.0 lb appears on the display.

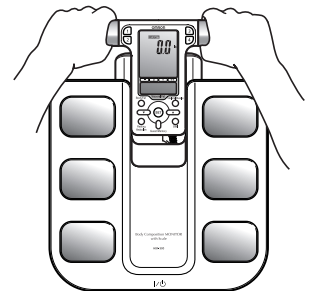

How to Hold the Grip Electrodes

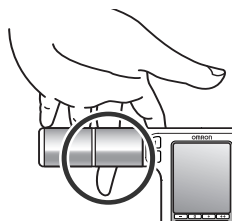

Place both middle fingers along the dents of the grip electrodes.

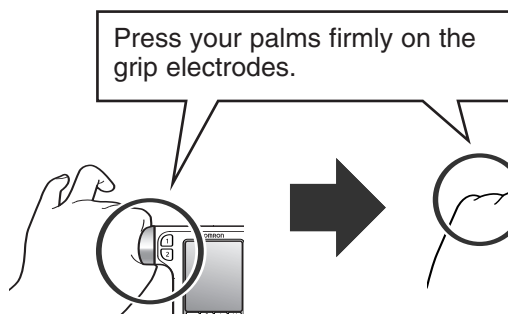

Hold the inner grip electrodes firmly with your thumb and index finger.

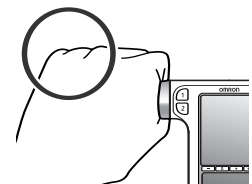

Hold the outer grip electrodes with your ring finger and small finger.

HOW TO TAKE A MEASUREMENT

3. Select the Personal Profile Number button or the Guest/Memory button.

A. Personal Profile Number

Press the button for the Personal Profile Number you selected while holding the display unit. The Personal Profile Number will appear after blinking once.

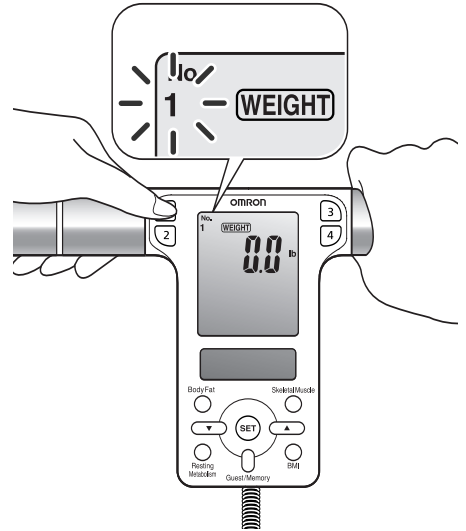

Ex.: To select Personal Profile Number "1", press button .

NOTE:

If the following appears on the display no personal data was entered for the number you selected. Refer to SETTING PERSONAL DATA on page 22.

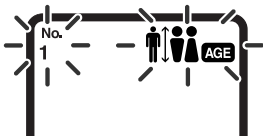

B. GUEST

1) Press the Guest/Memory button while holding the Display Unit.

"G" will be indicated at the top of the display while "AGE" data flashes.

2) Enter your personal data. Refer to SETTING PERSONAL DATA on page 22.

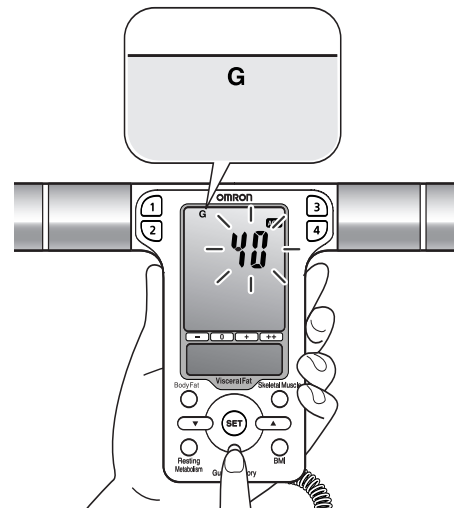

HOW TO TAKE A MEASUREMENT

4. Start the measurement.

- 1) Step onto the measurement platform and place your feet on the foot electrodes with your weight evenly distributed.

Remain still and do not move until the weight measurement is complete.

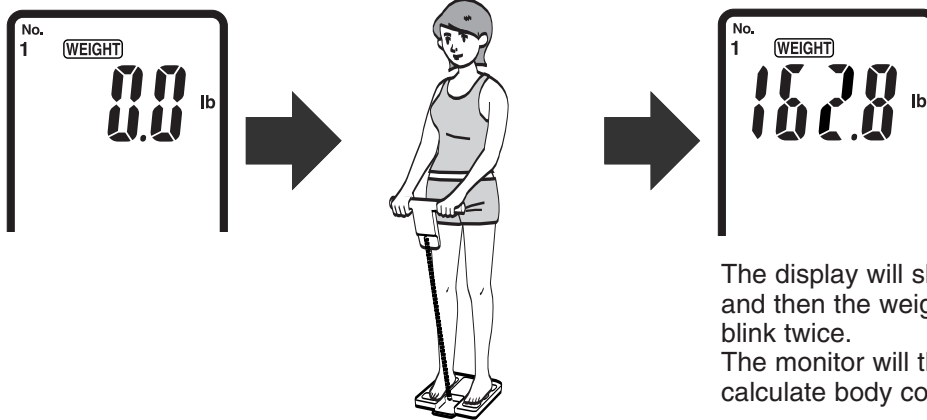

The display will show your weight and then the weight result will blink twice. The monitor will then start to calculate body composition.

- 2) When "START" appears on the display extend your arms straight at a 90° angle to your body.

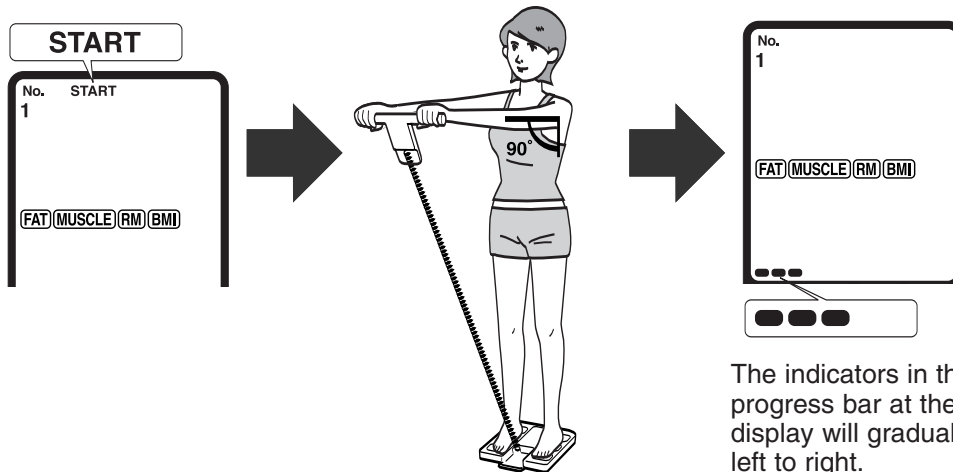

The indicators in the measurement progress bar at the bottom of the display will gradually appear from left to right.

- 3) When the measurement is completed, your weight is displayed again. Step off the measurement platform.

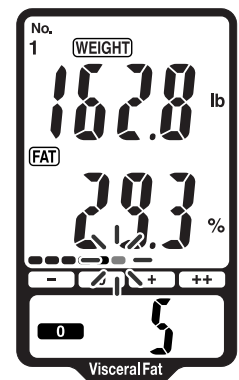

HOW TO TAKE A MEASUREMENT

5. Check the measurement results.

Press the appropriate button to view the measurement results.

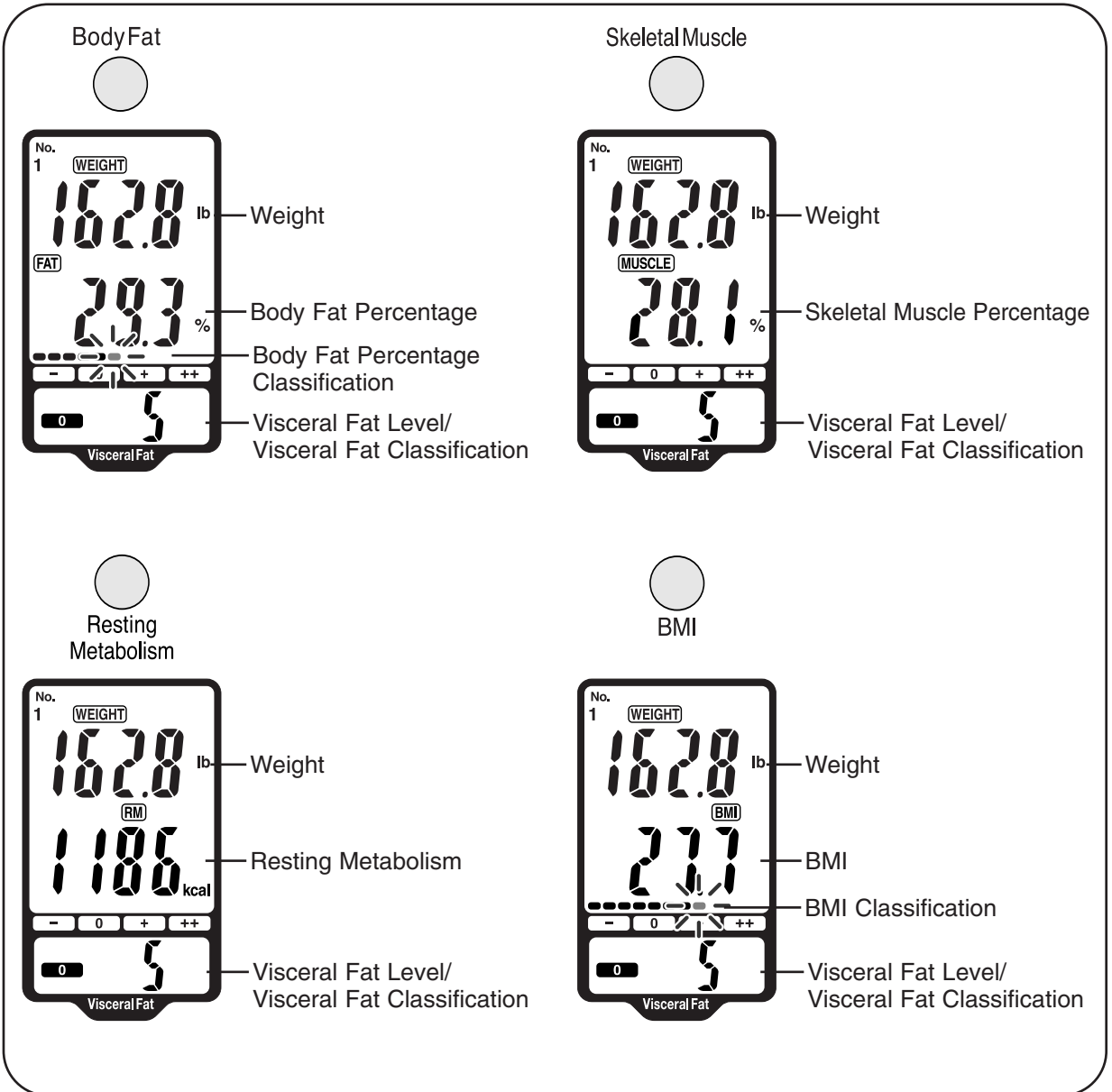

NOTES:

- The age range for the skeletal muscle percentage, resting metabolism and visceral fat level is 18 to 80 years old.
- The age range for the body fat percentage classification is 20 to 79 years old.

HOW TO TAKE A MEASUREMENT

Interpreting the BMI Result

BMI	BMI (Designation by the WHO)	BMI Classification Bar				BMI Rating
		-	0	+	++	
Less than 18.5	- (Underweight)					7.0 - 10.7 10.8 - 14.5 14.6 - 18.4
18.5 or more and less than 25	0 (Normal)					18.5 - 20.5 20.6 - 22.7 22.8 - 24.9
25 or more and less than 30	+ (Overweight)					25.0 - 26.5 26.6 - 28.2 28.3 - 29.9
30 or more	++ (Obese)					30.0 - 34.9 35.0 - 39.9 40.0 - 90.0

The above index refers to the values for obesity judgment proposed by WHO, the World Health Organization.

Interpreting the Body Fat Percentage Result

Gender	Age	Low (-)	Normal (0)	High (+)	Very High (++)
Female	20-39	< 21.0	21.0 - 32.9	33.0 - 38.9	\geq 39.0
	40-59	< 23.0	23.0 - 33.9	34.0 - 39.9	\geq 40.0
	60-79	< 24.0	24.0 - 35.9	36.0 - 41.9	\geq 42.0
Male	20-39	< 8.0	8.0 - 19.9	20.0 - 24.9	\geq 25.0
	40-59	< 11.0	11.0 - 21.9	22.0 - 27.9	\geq 28.0
	60-79	< 13.0	13.0 - 24.9	25.0 - 29.9	\geq 30.0

Based on NIH/WHO guidelines for BMI

Based on Gallagher et al., American Journal of Clinical Nutrition, Vol. 72, Sept. 2000

Interpreting the Visceral Fat Level Result

Visceral Fat Level \leq 9	Visceral Fat Level \geq 10
0 (Normal)	+ (High)

Visceral fat area (0 - Approx. 300 cm², 1 inch=2.54 cm) distribution with 30 levels.

* The data referenced by Omron Healthcare.

* Visceral fat levels are relative and not absolute values.

6. Turn the monitor off.

Press the Power Switch to turn the monitor off. Store the Display Unit in the Display Unit Holder.

HOW TO MEASURE WEIGHT ONLY

1. Press the Power Switch to turn the monitor ON.

The CAL symbol blinks on the display, then the display changes to 0.0 lb.

Wait until 0.0 lb appears on the display.

NOTES:

- If you step onto the monitor before 0.0 lb appears on the display, an error message “Err” will appear.
- This monitor can be set to either the US or Metric System. Personal Profile and memory will be displayed by selected system. To change the US/Metric mode:

1) Keep the ▲UP button pressed until “lb” and “kg” blink on the display.

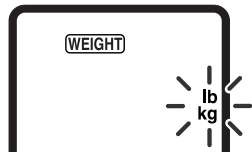

- 2) Press the ▲UP or ▼DOWN button to select the desired measurement unit, “lb” or “kg”.
3) Press the SET button to confirm the change.

2. Step onto the Measurement Platform.

Stand with your weight evenly distributed on the measurement platform.

Remain still and do not move until the measurement is complete.

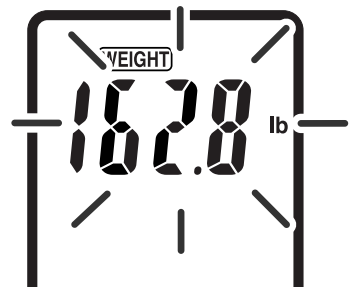

3. Step off the Measurement Platform.

4. Press the Power Switch to turn the monitor off.

HOW TO USE THE MEMORY FUNCTION

Measurement results are automatically stored in memory when you take a measurement using a Personal Profile Number button. You can view results for 1 day, 7, 30, and 90 days before. The monitor automatically stores up to 97 measurement values for each Personal Profile Number. When 97 sets of measurement values are stored in the memory for that Personal Profile Number, its oldest record is deleted to save the most recent measurement values.

NOTES:

- If a measurement was not taken on the exact day for 1, 7, 30 and 90 days ago measurement results stored in the memory as shown in the following chart will display.

1 day	Closest data stored from day 2 to day 6
7 days ago	Closest data stored from day 8 to day 14
30 days ago	Closest data stored from day 31 to day 37
90 days ago	Closest data stored from day 91 to day 97

- Only one set of measurement results is stored for each Personal Profile Number each day. If more than one measurement is taken during a day, the results from the last measurement are stored.

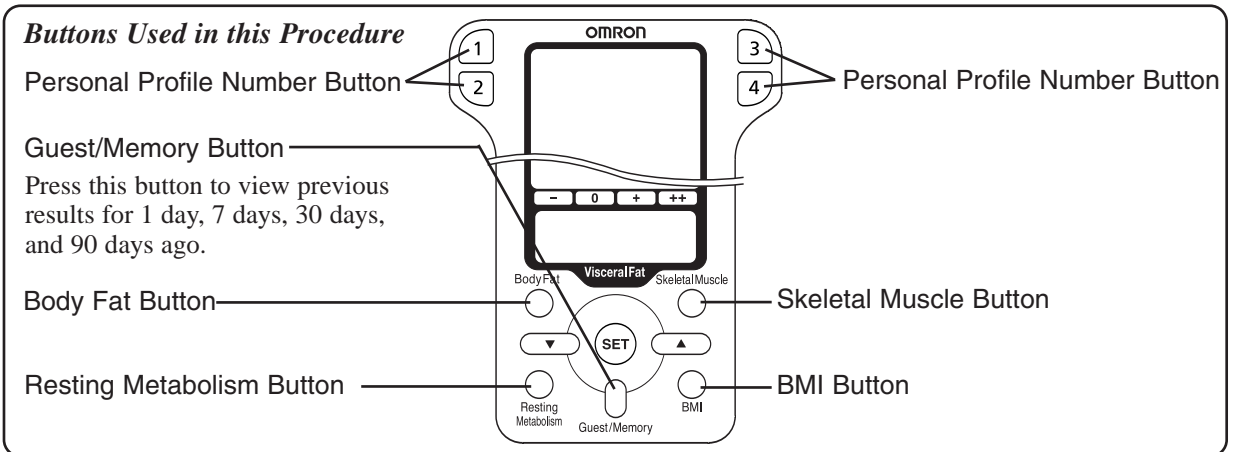

Comparing Results After Taking a Measurement

1. View the measurement results after taking a measurement.

- 1) Press the Guest/Memory button.
The results for the previous day are displayed.
- 2) Press the Guest/Memory button to cycle through the results from “1 day”, “7 days”, “30 days” and “90 days” ago.

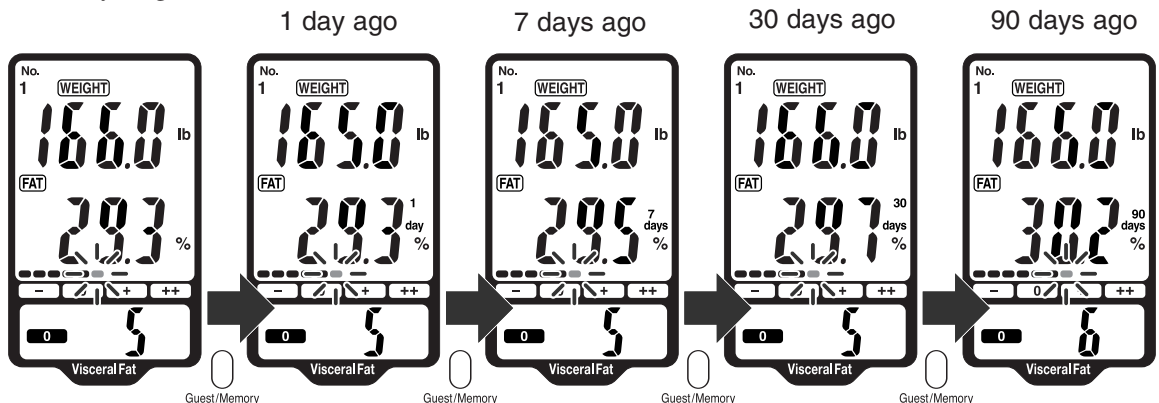

HOW TO USE THE MEMORY FUNCTION

NOTES:

- If there are no results for a selected memory, “- - - -” is displayed for that item.

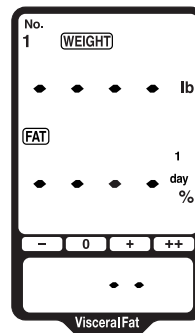

- To view previous results for other items, press the button for the desired item. The results for the selected item are displayed. Then press the Guest/Memory button to cycle through the previous results for that item.

BodyFat

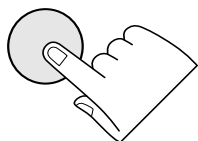

Previous Body Fat results for the currently selected period. Press the Guest/Memory button to cycle through the other previous results.

Resting Metabolism



Previous Resting Metabolism results for the currently selected period. Press the Guest/Memory button to cycle through the other previous results.

Skeletal Muscle



Previous MUSCLE results for the currently selected period. Press the Guest/Memory button to cycle through the other previous results.

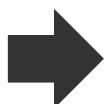
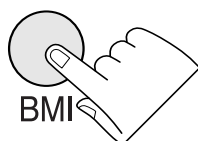

Previous BMI results for the currently selected period. Press the Guest/Memory button to cycle through the other previous results.

2. Press the Power Switch to turn the monitor off.

HOW TO USE THE MEMORY FUNCTION

Viewing Previous Measurement Results

Follow this procedure if you just want to view and compare previous measurement results, without taking a measurement.

1. Press the Power Switch to turn the monitor ON.

The CAL symbol blinks on the display, then the display changes to 0.0 lb.

Wait until 0.0 lb appears on the display.

NOTE: If you step onto the measurement platform before 0.0 lb appears on the display, an error message “Err” will appear.

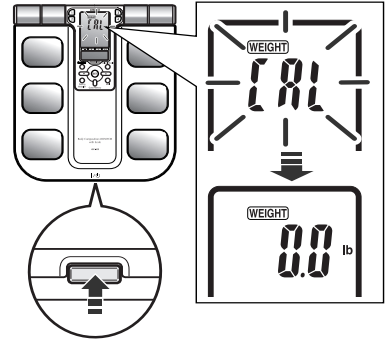

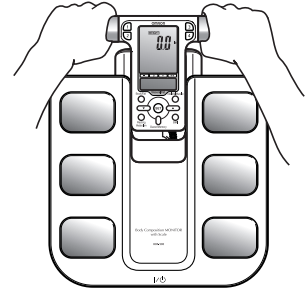

2. When the 0.0 lb appears on the display, lift the Display Unit out of the Display Unit Holder.

NOTE: Do not take out the display unit until 0.0 lb appears on the display.

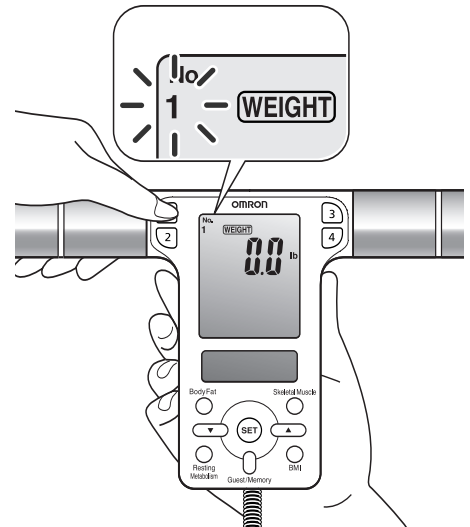

3. Press the desired Personal Profile Number button.



Ex.: To select Personal Profile Number “1”, press button .

HOW TO USE THE MEMORY FUNCTION

4. View the previous measurement results.

- 1) Press the Guest/Memory button once.

The results for the previous day are displayed.

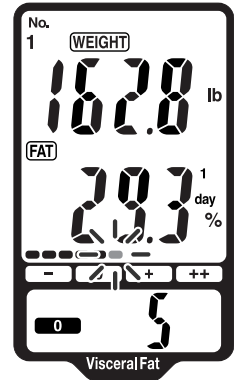

[Example]

- 2) Press the Guest/Memory button to cycle through the results from “1 day”, “7 days”, “30 days”, and “90 days” ago.

NOTE: To view previous results for Body Fat, Resting Metabolism, Skeletal Muscle and BMI, press the button for the desired item. The results for the selected item are displayed. (Refer to page 34.)

5. Press the Power Switch to turn the monitor off.

ERROR INDICATORS

ERROR DISPLAY	CAUSE	CORRECTION
Err 1	Your palms or feet are not positioned over the electrodes correctly.	Make sure you are barefoot. Make sure your palms or the soles of your feet are clean and dry. Make sure your feet are correctly positioned. Read "How to Take a Measurement" on page 26.
Err 2	The measurement position was not stable. Your palms or feet were not placed correctly.	Remain still and do not move until the measurement is complete. Read "How to Take a Measurement" on page 26.
Err 3	Feet are too dry.	Slightly moisten the soles of your feet with a damp towel and retake the measurement.
Err 4	The Body Composition values are outside the measurement range.	Check the settings entered for your personal data. Change the settings if needed. Retake the measurement. If this error occurs again and the settings are correct, measurements cannot be taken.
	Your palms or feet are not positioned over the electrodes correctly.	Make sure your palms or feet are correctly positioned.
Err 5	The monitor is not set up correctly.	Remove the batteries. Wait one minute. Reinstall the batteries. Refer to "Battery Installation" on page 18. Press the Power Switch and turn the monitor on. Retake the measurement.
Err	You stepped onto the measurement platform before 0.0 lb was displayed.	Wait until 0.0 lb is displayed before stepping onto the measurement platform.
	The monitor was moved before 0.0 lb was displayed.	Do not move the monitor until 0.0 lb is displayed.
	Movement during measurement.	Do not move until measurement is complete.
	Monitor detected weight over 300.0 lb.	This monitor can only be used by people weighing less than 300.0 lb.

TROUBLESHOOTING TIPS

PROBLEM	CAUSE AND SOLUTION
Low Battery Indicator No power No display appears on the unit	Check the battery installation for proper placement of the battery polarities. Replace all four worn batteries.
The weight value is displayed abnormally low or high.	Place the monitor on a hard, level floor.
The Body Composition value is displayed abnormally low or high.	Refer to “The reason calculated results may differ from actual body fat percentage” on page 14, and “Recommended Measurement Times” on page 13. Check the settings entered for your personal data.
Other conditions	Remove the batteries. Wait one minute. Reinstall the batteries. Refer to “Battery Installation” on page 18.

CARE AND MAINTENANCE

To keep your Body Composition MONITOR with Scale in the best condition and protect the monitor from damage follow the directions below:

Clean the monitor with a soft dry cloth. Do not use abrasive or volatile cleaners. The monitor is not waterproof.

⚠ CAUTION:

Do not submerge the device or any of the components in water.

Store the monitor in a safe and dry location. Do not expose the monitor to direct sunlight, extreme hot or cold temperatures or humidity. Thoroughly dry any moisture off the monitor before storing.

⚠ CAUTION:

Do not submerge the device or any of the components in water.

⚠ CAUTION:

Do not subject the monitor to strong shocks, such as dropping the unit on the floor.

Remove the batteries if the monitor will not be used for three months or longer.

Store the Display Unit in the Main Unit as shown in the figure.

As you place the lower portion of the Display Unit, it clicks and fits into the Display Unit Holder.

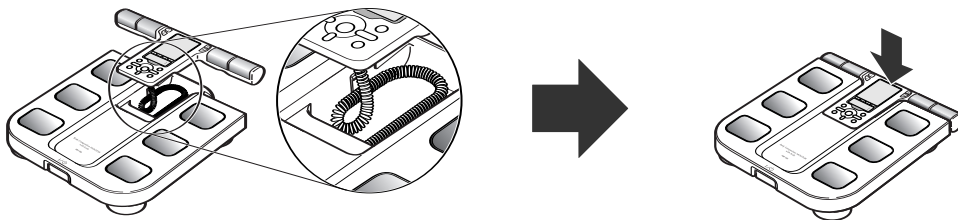

Do not crease the cord when storing in the Display Unit Holder.

Use the monitor consistent with the instruction provided in this manual.

⚠ CAUTION:

Do not disassemble or modify the unit. Changes or modifications not approved by Omron Healthcare will void the user warranty.

FCC STATEMENT

NOTE:

POTENTIAL FOR RADIO/TELEVISION INTERFERENCE (for U.S.A. only)

This product has been tested and found to comply with the limits for a Class B digital device, pursuant to part 15 of the FCC rules.

These limits are designed to provide reasonable protection against harmful interference in a residential installation. The product generates, uses, and can radiate radio frequency energy and, if not installed and used in accordance with the instructions, may cause harmful interference to radio communications. However, there is no guarantee that interference will not occur in a particular installation. If the product does cause harmful interference to radio or television reception, which can be determined by turning the product on and off, the user is encouraged to try to correct the interference by one or more of the following measures:

- Reorient or relocate the receiving antenna.
- Increase the separation between the product and the receiver.
- Connect the product into an outlet on a circuit different from that to which the receiver is connected.
- Consult the dealer or an experienced radio/TV technician for help.

POTENTIAL FOR RADIO/TELEVISION INTERFERENCE

(for Canada only)

This digital apparatus does not exceed the Class B limits for radio noise emissions from digital apparatus as set out in the interference-causing equipment standard entitled "Digital Apparatus", ICES-003 of the Canadian Department of Communications.

Cet appareil numérique respecte les limites de bruits radioélectriques applicables aux appareils numériques de Classe B prescrites dans la norme sur le matériel brouilleur: "Appareils Numériques", ICES-003 édictée par le ministre des communications.

Changes or modifications not expressly approved by the party responsible for compliance could void the user's authority to operate the equipment.

WARRANTY

Limited Warranty

Your HBF-500 Body Composition MONITOR with Scale, excluding the batteries, is warranted to be free from defects in materials and workmanship appearing within 1 year from the date of purchase, when used in accordance with the instructions provided with the unit. The above warranties extend only to the original retail purchaser.

We will, at our option, repair or replace without charge any monitor covered by the above warranties. Repair or replacement is our only responsibility and your only remedy under the above warranties. To obtain warranty service contact Omron Healthcare's Customer Service by calling **1-800-634-4350** for the address of the repair location and the return shipping and handling fee. Information for warranty service is available on our website at www.omronhealthcare.com.

Enclose the Proof of Purchase. Include a letter, with your name, address, phone number, and description of the specific problem. Pack the product carefully to prevent damage in transit. Because of possible loss in transit, we recommend insuring the product with return receipt requested.

ALL IMPLIED WARRANTIES, INCLUDING BUT NOT LIMITED TO THE IMPLIED WARRANTIES OF MERCHANTABILITY AND FITNESS FOR PARTICULAR PURPOSE, ARE LIMITED TO THE DURATION OF THE APPLICABLE WRITTEN WARRANTY ABOVE. Some states do not allow limitations on how long an implied warranty lasts, so the above limitation may not apply to you.

OMRON SHALL NOT BE LIABLE FOR LOSS OF USE OR ANY OTHER INCIDENTAL, CONSEQUENTIAL OR INDIRECT COSTS, EXPENSES OR DAMAGES. Some states do not allow the exclusion or limitation of incidental or consequential damages, so the above exclusions may not apply to you. This warranty gives you specific legal rights, and you may also have other rights which may vary from state to state.

FOR CUSTOMER SERVICE

Visit our web site at:

www.omronhealthcare.com

Call toll free:

1-800-634-4350

SPECIFICATIONS

Model	OMRON Body Composition MONITOR with Scale - HBF-500
Display	<p>Weight display: 0 to 300 lb with 0.2 lb increments (0 to 135 kg with 0.1 kg increments)</p> <p>Body fat percentage: 5.0 to 60.0% with 0.1% increments</p> <p>Skeletal muscle percentage: 5.0 to 50.0% with 0.1% increments</p> <p>BMI: 7.0 to 90.0 with 0.1 increments</p> <p>Resting metabolism: 385 to 5000 kcal with 1 kcal increments</p> <p>Visceral fat level: 30 levels with 1 level increments</p> <p>*The age range for the skeletal muscle percentage, resting metabolism and visceral fat level is 18 to 80 years old.</p> <p>*The age range for the body fat percentage classification is 20 to 79 years old.</p> <p>BMI classification: – (Underweight) / 0 (Normal) / + (Overweight) / ++ (Obese) with 12 levels of Bar display</p> <p>Body fat percentage classification: – (Low) / 0 (Normal) / + (High) / ++ (Very High) with 12 levels of Bar display</p> <p>Visceral fat classification: 0 (Normal) / + (High)</p> <p>Memory: 1 day / 7 days / 30 days / 90 days</p>
Set Ranges	<p>Height: 3' 4" to 6' 6 3/4" (100.0 to 199.5 cm)</p> <p>Age: 10 to 80 years old</p> <p>Gender: Male/Female</p>
Power Supply	4 AA batteries
Battery Life	Approximately 1 year (when used four times a day)
Operating Temperature /Humidity	+50°F to +104°F (+10°C to +40°C), 30 to 85% RH
Storage Temperature /Humidity/Air Pressure	-4°F to +140°F (-20°C to +60°C), 10 to 95% RH, 700 - 1060 hPa
External Dimensions	<p>Display Unit: Approximately 11 7/8" (W) x 1 3/8" (H) x 6 1/8" (D)</p> <p>Main Unit: Approximately 11 7/8" (W) x 2 1/4" (H) x 12 3/4" (D)</p>
Weight	Approximately 4.85 lb (including batteries)
Contents	Main Unit, 4 AA batteries, Instruction Manual, Graph Sheet
UPC Code	0 73796 26500 7

NOTE: Specifications are subject to change without prior notice.

NOTES

Distributed by:
OMRON HEALTHCARE, INC.
1200 Lakeside Drive
Bannockburn, Illinois 60015
www.omronhealthcare.com

Made in China
© 2006 Omron Healthcare, Inc.
HBF-500INST Rev.B

9054900-0B

Free Manuals Download Website

<http://myh66.com>

<http://usermanuals.us>

<http://www.somanuals.com>

<http://www.4manuals.cc>

<http://www.manual-lib.com>

<http://www.404manual.com>

<http://www.luxmanual.com>

<http://aubethermostatmanual.com>

Golf course search by state

<http://golfingnear.com>

Email search by domain

<http://emailbydomain.com>

Auto manuals search

<http://auto.somanuals.com>

TV manuals search

<http://tv.somanuals.com>