

# OMRON *NE U07*

---

**Instruction manual**  
**Page 2**

**Gebrauchsanweisung**  
**Seite 20**

**Mode d'emploi**  
**Page 38**

**Istruzioni per l'uso**  
**Pagina 56**

**Instrucciones de uso**  
**Página 74**

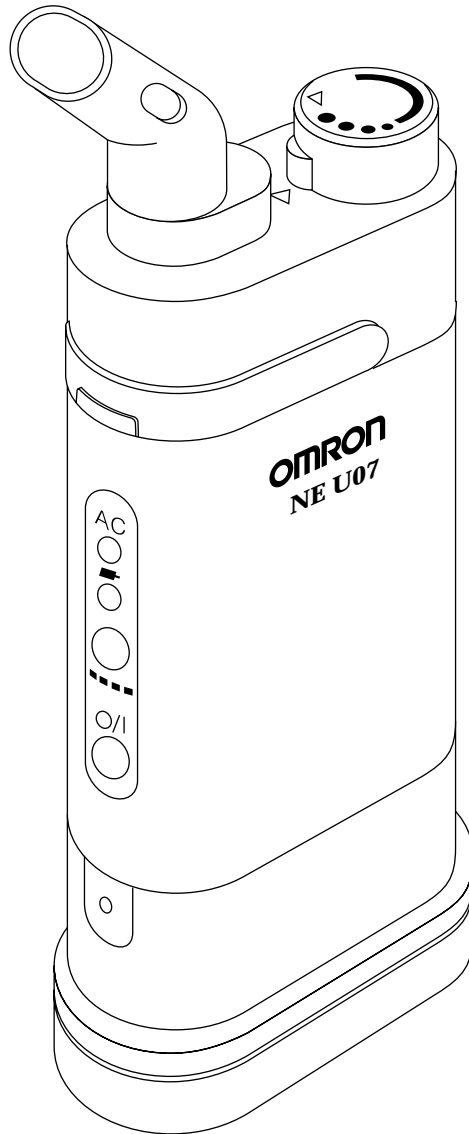

**Inhalationsgerät – Nebuliser**

## Table of contents

General Information .....	3
Components .....	4
Safety precautions .....	6
Information on inhalation .....	8
Preparation .....	9
Start the treatment .....	10
End of operation .....	11
Cleaning .....	11
Possible problems and how to solve them .....	14
Technical data .....	15
Spare parts .....	16
Guarantee card .....	17

## Dear Customer

Thank you for purchasing an OMRON product. You can be sure you have made a wise choice. By buying the OMRON NE U07 nebuliser, you have chosen a high-quality, innovative instrument. During its development, particular attention was given to reliability and easy, convenient handling. **Before using for the first time, please read through this manual carefully.** If you should still have any questions regarding its use, please contact the OMRON Customer Service at the address on the packaging and/or attached literature. They will be pleased to help you.

Best wishes for a healthy future.  
Yours sincerely,

OMRON HEALTHCARE Europe

## General Information

The OMRON NE U07 is a nebuliser for the inhalation of medical aerosols to treat asthma, chronic bronchitis and other respiratory tract disorders. This nebuliser is suitable for commonly used inhalation solutions. Use only the medication prescribed by your doctor. Type and duration of the inhalation must be carried out according to the recommendations of your doctor.

The OMRON NE U07 produces a very low particle size distribution and therefore a medication vapour that will reach effectively and reliably to the upper and lower respiratory passages.





The OMRON NE U07 can be used automatically with constant aerosol-delivery function or intermittently by an interrupt switch.

The OMRON NE U07 is suitable for inhalation both at home and in hospital or a doctor's practice.

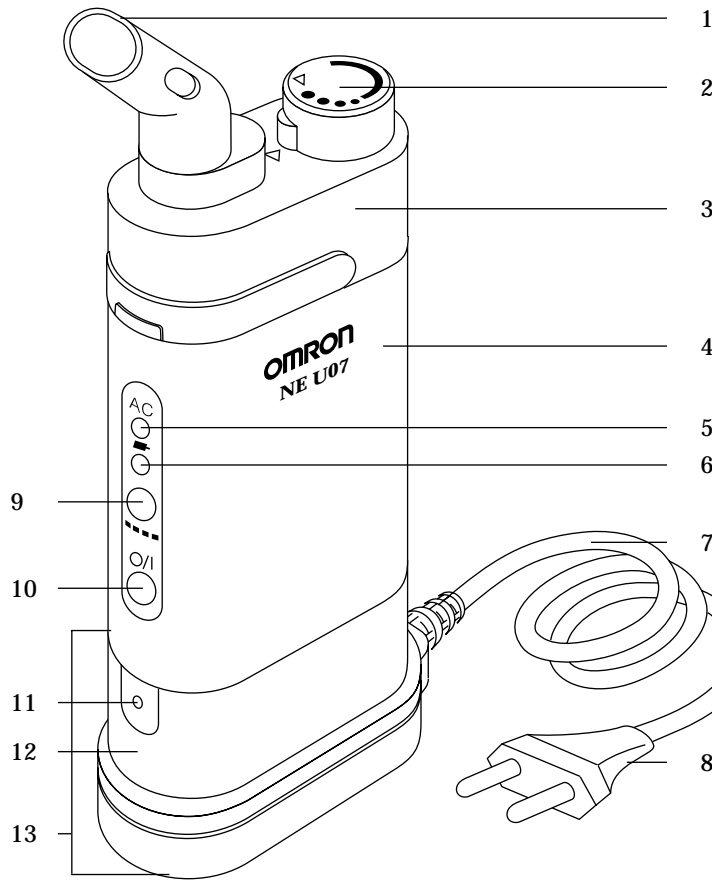
The OMRON NE U07 nebuliser corresponds to the appropriate CE regulations.

## Components of the OMRON NE U07 main unit



- 1 Mouthpiece
- 2 Aerosol rate adjust knob
- 3 Cover
- 4 Casing
- 5 Nebuliser lamp
- 6 Battery discharge lamp  (only if rechargeable batteries are used)
- 7 Power cord
- 8 Plug
- 9 Manual operation button    
- 10 Continuous operation button (O/I), OFF/ON
- 11 Unlock button
- 12 AC adapter
- 13 Bottom housing

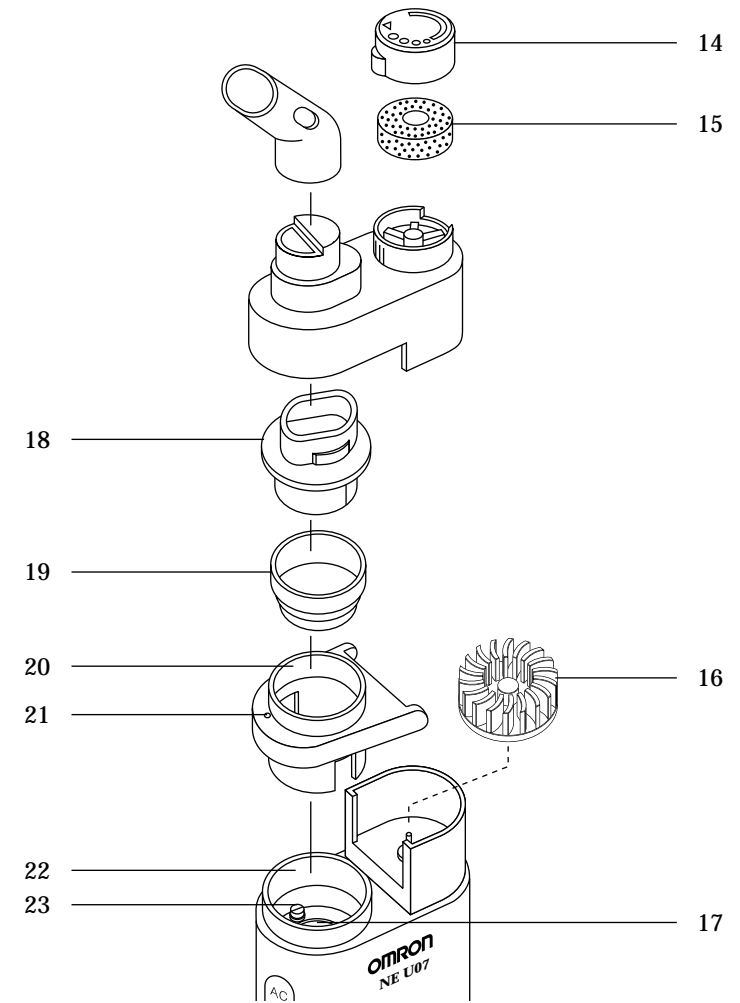

- 14 Aerosol delivery rate adjust knob
- 15 Air filter
- 16 Fan
- 17 Transducer
- 18 Nebuliser guide
- 19 Medication cup
- 20 Medication cup holder
- 21 Ventilation hole
- 22 Water tank
- 23 Water level detector

## Safety Precautions

Please read the following instructions carefully, as they contain important information concerning the setting up, use and maintenance of your new nebuliser.

- Keep this manual for future reference.
- As soon as you have unpacked the nebuliser, check it for visible damage or defects. In particular check for cracks in the plastic housing, which could expose electrical components. If this is the case or if you are in doubt, contact an authorized dealer or the OMRON Customer Service directly.
- Only use the nebuliser for its intended purpose, that means for inhalation therapy. Any other form of use constitutes an improper use and is therefore dangerous. The manufacturer cannot be held liable for any damage caused by improper or incorrect use.
- Never open the main unit.
- Do not use the nebuliser while you are in a bath or shower.
- Some parts of the unit are so small that they could be swallowed by small children. Do not let unattended children have access to the unit.
- Make sure that the electrical rating shown on the rating plate on the bottom of the unit corresponds to your mains voltage and frequency before plugging in the nebuliser.
- If the power plug provided with the nebuliser does not fit your wall socket, have the plug changed by an electrical appliance dealer. Do not use an adapter. If you use an extension cable mains adapter make sure not to connect too many appliances simultaneously so that the maximum load is not exceeded.
- Always disconnect the nebuliser from the power supply before commencing cleaning.

**This appliance is designed for short term operation only.  
The unit mustn't be operated for longer than 30 minutes.  
Please allow 30 minutes between two operations.**

When using any electrical appliance certain important safety measures must always be observed, which include the following:

- The unit is not protected against water penetration, so: Never submerge the nebuliser in water. Never touch the unit when your hands are wet or moist. If it falls into a filled bathtub or sink, first disconnect the power supply plug from the wall socket, before attempting to retrieve it. Immediately contact an authorized dealer or the OMRON Customer Service and have the unit inspected. Do not use the unit before this inspection and any necessary repairs have been carried out.
- Do not allow unsupervised children or infirm persons to use the unit.
- Do not disconnect the unit by simply pulling out the plug from the wall socket. Always switch the unit off first.
- Do not leave the nebuliser running unattended. Always switch the unit off and then unplug it when it is in use.
- Do not leave the unit outdoors or in a humid environment. Never store the unit in direct sunlight.
- Do not operate the unit in the presence of anaesthetic mixtures which are inflammable when they come into contact with air, oxygen or nitrous oxide.
- If you discover that the nebuliser is damaged or does not operate properly, switch it off immediately and stop using it. Any repairs must be carried out by an authorized dealer using only original OMRON spare parts. Any part of the unit may only be repaired or replaced by the manufacturer or the OMRON Customer Service.
- Keep the power cable away from heated or hot surfaces.
- The power cable should always be fully unwound in order to prevent dangerous overheating.
- If the power cable or the power supply plug become damaged, consult an authorized dealer / service agent or contact the OMRON Customer Service. Never operate the unit with a damaged power cable or plug.

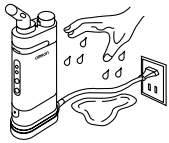

Never submerge or wet the AC power unit or cord. Doing so could result in electrical shock.

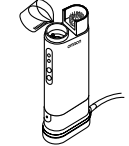

Never operate the unit with the water tank empty. Use only water in the tank. Solutions other than water may cause damage to the transducer.

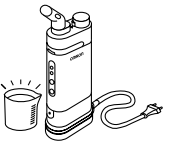

Change the water in the water tank after each use.

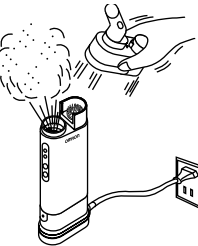

**Warning:** Never remove the cover during operation – severe injury could occur.

## Information on inhalation

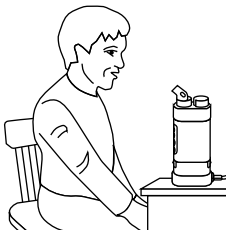

When inhaling you should sit upright and relaxed. You should sit at a table and not in an armchair as otherwise you will constrict your respiratory passages and impair the effect of inhalation. If you must be treated in bed, support yourself with pillows so that you will sit as upright as possible.

**One treatment should not last longer than 15 minutes.** Consult your doctor concerning the appropriate inhalation time.

Always be calm and relaxed when you inhale. Allow time for the inhalation to take effect after you have finished using the nebuliser.

Breathe in slowly and deeply so that the medication can reach deep into the fine bronchial tubes. Hold your breath for a short time, then breathe out slowly. Do not try to breathe too quickly. Take a pause when you feel like having it.

**Before using the nebuliser for the first time it must be cleaned according to the cleaning instructions.**

## Preparation

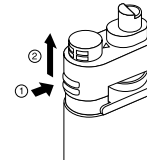

### ① Filling cooling water

Before filling cooling water or medication, be sure the power is OFF (○). (Nebuliser lamp is OFF and the power cord is unplugged).

Remove the cover by slightly pushing the rear part of the cover to move it upwards.

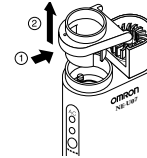

Lift the medication cup holder by slightly pushing the front panel of the tank holder and lifting it up.

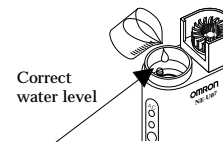

### ② Filling Medication

Place the nebuliser on a table or another flat and stable surface.

Fill the water tank (with tap water or distilled water) to the correct level. (In between the two lines).

#### Caution:

1. Never fill the water tank with solutions other than water. Damage to the transducer could occur.
2. Be sure to fill the water tank to the proper level. The unit will not operate if the water level is low.

Place medication directly into the medication cup.

- Never use more than 10 ml of solution.
- Be sure all parts are clean before operating.

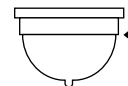
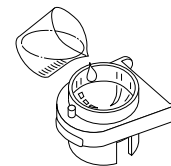

The medication cup has a 10 ml capacity. Never overfill.

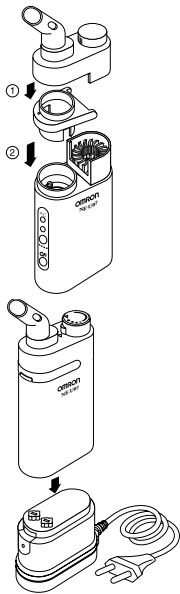

### ③ Assembling

Mount the medication cup holder and the cover onto the main unit.

Couple the main unit with the AC adaptor. (Fit them by pressing until it clicks).

Connect the plug to a wall-plug (AC 220V – 230V~).

**Caution:**

Before plugging the unit in, make sure that the voltage rating on the back of the AC Adaptor and the supply voltage value match.

Press the ■■■■-button for intermittent operation. The nebuliser will not operate if it is not pressed. Press the OFF/ON (○/I)-button for continuous operation. The nebuliser will operate continuously until it is pressed again, which stops the unit.

**Notes:**

1. During operation a green power light will illuminate. This light must be lit for the unit to operate.
2. The unit is equipped with a heat sensor. If, during operation, excessive heat occurs, the unit will automatically shutoff. The unit will operate properly when normal operating temperature is reached. Store the unit in a well ventilated location (near an open window for example). Please wait at least 30 minutes before restarting inhalation.

## Start the treatment

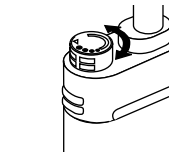
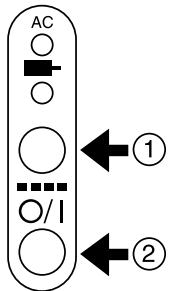

Aerosol output is adjustable by rotating the delivery rate adjust knob placed on the cover. Rotate the knob counterclockwise to increase the rate, or clockwise to reduce the rate. Adjust it to your requirements.

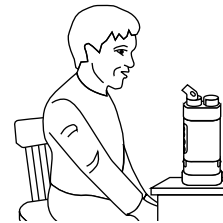

Sit relaxed at a table and breathe in the aerosol delivered through the mouthpiece or air tube (optional part).

## End of operation

Press the continuous operation button (○/I) after use. (Nebuliser lamp goes out).

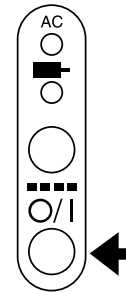

## Cleaning

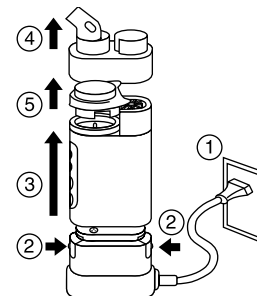

- ① Remove the plug from the mains socket. (Do not pull the power cord. Be sure to pull it out by holding the power plug).
- ②, ③ Lift the casing up, while pressing the front and rear unlock buttons of the AC adaptor. Remove the main unit.
- ④, ⑤ Remove the cover and the medication cup holder from the main unit.

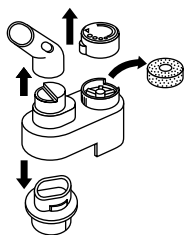

Remove the nebuliser guide, mouthpiece and aerosol volume adjust knob from the cover.

- How to remove the delivery rate volume adjust knob: Rotate the knob counterclockwise, adjust the "▼" mark with the matching mark "△" of the cover and pull it upwards.

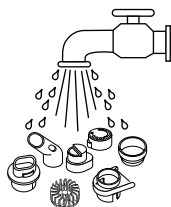

Pour the medication out of the cup, clean and sterilise the cover, nebuliser guide, medication cup holder, mouthpiece, aerosol volume adjust knob, removable parts.



Drain water from the water tank. Wipe out remaining water with soft, dry cloth.

- Never use abrasive material on transducer.
- Be sure that the unit is disconnected from the power source before cleaning.

### Replacing and cleaning of the air filter

Remove the aerosol volume adjust knob from the cover ①, ② and remove the filter ③.

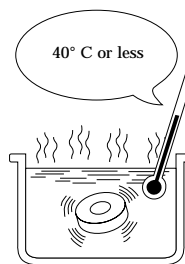
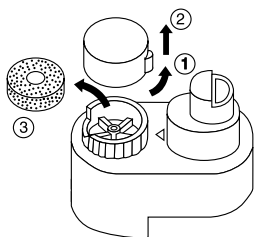

Wash the air filter in lukewarm water (40° C or less) or with diluted neutral cleanser to reuse. After washing, make sure the filter is completely dry before attaching it to the unit.

- If soiling can no longer be washed out, replace the filter with a new air filter (U07-4).

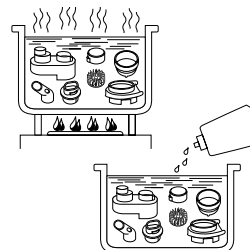

### Other parts

Wash the medication cup, medication cup holder, cover, nebuliser guide, mouthpiece, aerosol delivery rate adjust knob and fan in commercial cleaning solution (eg. Milton). Do not use soap. All parts can be placed in boiling water for 5 to 10 minutes. Do not allow the water to boil dry.

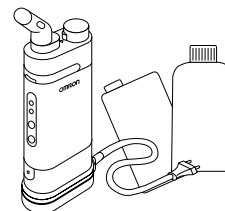

### Unit maintenance

Clean the unit using a cloth moistened with water and a few drops of neutral cleanser, and then wipe dry with a cloth.

- Never use benzene, thinner, a volatile chemical.

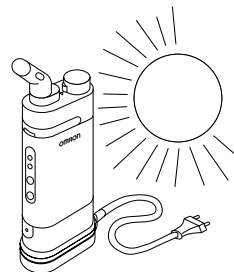

### Storage

Do not store the unit in direct sunlight or in areas of high humidity. The unit should be kept in a safe place.

## Possible problems and how to solve them

Symptom	Check	Remedy
Operation button lamp (AC) does not light up. • With AC adaptor in use.	① Check that the plug of the AC adaptor is inserted correctly. ② Check that the main unit is mounted correctly onto the AC adaptor. ③ Check that the level of water in the water tank is normal.	Correctly insert it.  Correctly mount it.  Fill water up to proper level.
No nebulisation	① Check that standard volume of the medication is in the cup.	Fill the medication cup and switch on the power by pressing OFF/ON (O/I).
Low nebulisation rate	① Be sure the medication cup is not broken. ② Check the medication level in cup. ③ Check aerosol volume adjust knob. ④ Check battery light. ⑤ Check preparation of medication.	Replace the medication cup.  Remove the excess medication.  Increase delivery rate.  Go to AC operation. Eventually read information supplied with medication or consult your doctor.

If you find unsolvable problems please contact your authorised OMRON Customer Service. For address see packaging and/or attached literature.

## Technical data

This device fulfills the provisions of the EC directive 93/42/EEC (Medical Device Directive).

Model:	OMRON NE U07
Electrical rating:	AC 220V – 230V~, 50/60 Hz
Power consumption:	Approx. 20 Watts
Particle size:	3.5 µm (MMD *)
Ultrasonic frequency:	2.4 MHz
Nebulisation rate:	Approx. 1.0 ml/min.
Water tank:	Approx. 21 ml
Fuse:	⊖ = T 0.1 A
Medication cup:	maximum 10 ml
Dimensions:	Approx. 62 mm (W) x 110 mm (D) x 254 mm (H)
Weight:	approx. 940 g
Operating conditions:	0 °C – 40 °C; 30% RH – 85% RH
Storage conditions:	0 °C – 40 °C; 30% RH – 85% RH
Electrical safety:	□ - Class II, ⚡ - Type B
Symbol explanation:	■ ■ ■ ■ = Manual operation AC = Alternating current O/I = OFF/ON

Technical data subject to change

Manufacturer:  
OMRON HEALTHCARE Europe

### CE 0197

\* Mass Median Diameter  
Data independently obtained by:  
Malvern Instruments GmbH, Germany  
on Malvern Master Sizer System



## Spare parts

Use only OMRON spare parts.

The medication cup, mouthpiece and air filter will deteriorate with time. They must be changed from time to time.



Medication cup (5 pcs.) 7588620-3



Mouthpiece 7588624-6



Air filters (5 pcs.) 7588623-8

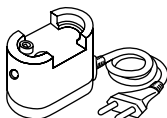

AC adapter (230V) 1944686-1

### Accessories optional:

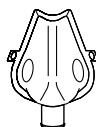

Mask (large) 7572540-4

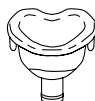

Mask (small) 7572540-4



Inhalation hose S (30 cm)  
20 mm Ø with cuffs 7572543-9



Nosepiece 1925162-9

All spare parts are obtainable through your dealer or the OMRON Customer Service. For address see packaging and/or attached literature.

## Free Manuals Download Website

<http://myh66.com>

<http://usermanuals.us>

<http://www.somanuals.com>

<http://www.4manuals.cc>

<http://www.manual-lib.com>

<http://www.404manual.com>

<http://www.luxmanual.com>

<http://aubethermostatmanual.com>

Golf course search by state

<http://golfingnear.com>

Email search by domain

<http://emailbydomain.com>

Auto manuals search

<http://auto.somanuals.com>

TV manuals search

<http://tv.somanuals.com>