

**BF500**

# Body Composition Monitor

- **Instruction Manual**
- **Mode d'emploi**
- **Gebrauchsanweisung**
- **Manuale di istruzioni**
- **Manual de instrucciones**
- **Gebruiksaanwijzing**
- **РУКОВОДСТВО ПО ЭКСПЛУАТАЦИИ**

EN

FR

DE

IT

ES

NL

RU

Thank you for purchasing the OMRON Body Composition Monitor. Before using this unit for the first time, please be sure to read this Instruction Manual carefully and use the unit safely and properly. Please keep this Instruction Manual at hand all the time for future reference.

# Contents

## Before using the unit

Notes on Safety .....	3
Features of the Product.....	5
What You Should Know When Using This Unit.....	6

## Operating instructions

1. Know Your Unit .....	10
2. Inserting and Replacing the Batteries .....	13
3. How to Set the Date and Time.....	14
4. Setting and Storing Personal Data .....	16
5. Taking a Measurement .....	20
6. Measuring Weight Only .....	27
7. Using the Memory Function.....	28

## Care and maintenance

8. Error Displays .....	33
9. Troubleshooting .....	34
10.How to Care and Store the Unit .....	35
11.Technical Data .....	36

## Understanding the Results .....

## Quick Reference Guide .....

# Notes on Safety

## **Danger:**

Never use this unit in combination with medical electronic devices such as:

(1) Medical electronic implants such as pacemakers.



(2) Electronic life support systems such as an artificial heart/lung.

(3) Portable electronic medical devices such as an electrocardiograph.

• This unit may cause the above mentioned medical electronic devices to malfunction.

## **Warning:**

- Never start weight reduction or exercise therapy without the instructions of a doctor or specialist.
- Do not use the unit on slippery surfaces, such as a wet floor.
- Keep the unit out of the reach of young children.
- Do not jump onto the unit, or hop up and down on the unit.
- Do not use this unit when your body and/or feet are wet, such as after taking a bath.
- Stand on the main unit bare-footed. Attempting to stand on it with socks on may cause you to slip and result in injury.
- Do not step on the edge or display area of the main unit.
- People with disabilities, or who are physically frail, should always be assisted by another person when using this unit. Use a handrail or so when stepping on the unit.
- If battery fluid should get in your eyes, immediately rinse with plenty of clean water. Consult a doctor immediately.

## **Caution:**

- Do not disassemble, repair, or remodel the display unit or the main unit.
- Do not use a cellular phone near the display unit or the main unit.
- Take care when storing the display unit. Your fingers may be trapped between the grip and the main unit if you press it too strongly.
- Do not use batteries not specified for this unit. Do not insert the batteries with the polarities in the wrong direction.
- Replace worn batteries with new ones immediately.
- Do not dispose of batteries in fire.
- If battery fluid should get on your skin or clothing, immediately rinse with plenty of clean water.
- Remove the batteries from this unit when you are not going to use it for a long period of time (approximately three months or more).
- Do not use different types of batteries together.
- Do not use new and worn batteries together.

## **General Advice:**

- Do not place this unit on a cushioned floor surface such as on a carpet or a mat. Correct measurement may not be possible.
- Do not place this unit in highly humid environments and protect it from splashing water.
- Do not place this unit near heat sources or below air conditioners and avoid direct sunlight.
- Do not use this unit for purposes other than described in this manual.

- Do not pull the cord of the display unit attached to the main unit with force.
- As this unit is a precision instrument, do not drop, vibrate, or apply strong shock.
- Disposal of used batteries should be carried out in accordance with the national regulations for the disposal of batteries.
- Do not wash the display unit or the main unit with water.
- Do not wipe the unit with benzene, gasoline, paint thinner, alcohol, or other volatile solvents.
- Do not place this unit where it will be exposed to chemicals or corrosive vapors.

Medical electrical equipment is subject to special safety measurement regarding electromagnetic compatibility.

The documentation in accordance with EN60601-1-2:2001 is available.

Don't use mobile telephones, microwave and other devices, which generate strong electrical or electromagnetic fields, near the medical device. This may result in incorrect operation of the unit.

**Save these instructions for future reference.**

# Features of the Product

## More accurate measurement of the entire body

As measurement is conducted between both upper and lower limbs, the measurement values are less affected by the variation of physique as compared to traditional body fat monitors.

## Visceral fat is displayed in 30 levels

Visceral fat is closely related to lifestyle-related diseases, such as hypertension, diabetes, and hyperlipidemia.

\* OMRON BF500 can help you check your visceral fat level easily.

## Easily check skeletal muscle percentage

Skeletal muscle is displayed as a percentage.

The unit only measures skeletal muscle, muscle connected to bone and used to move the body. It does not include smooth muscle, found in internal organs.

## Display of BMI and resting metabolism

In addition to calculating body fat percentage, it can also access your health using the BMI method<sup>\*1</sup>, while taking your physique into consideration. It estimates the resting metabolism from personal data input and the measured body weight. Use those calculated values as reference for planning your weight reduction program.

\*1 BMI: Body Mass Index = Body weight (kg) / (height (m))<sup>2</sup>

## Memory function to store up to four users' personal data

For the measurement of body composition, it is necessary to set personal data such as age, gender, and height. Once you set and store the data, the unit is ready for use by pressing the personal profile number button. This unit can be shared as it can store up to four different users' data.

## Comparison with previous results to monitor progress

The unit stores the measurement results, so you can easily monitor any changes. You can display measurements for 1 day, 7, 30, and 90 days before.

## The display unit can be operated easily and is easy to read.

For additional information, please see Section "Understanding the Results".

EN

# What You Should Know When Using This Unit

## Principle of body composition calculation

### ***Body fat has low electric conductivity***

The BF500 estimates the body fat percentage by the Bioelectrical Impedance (BI) method. Muscles, blood vessels and bones are body tissues with a high water content that conducts electricity easily. Body fat is tissue that has little electric conductivity. The BF500 sends an extremely weak electrical current of 50 kHz and less than 500  $\mu\text{A}$  through your body to determine the amount of fat tissue. This weak electrical current is not felt while operating the BF500.

In order for the scale to determine body composition, it uses the electrical impedance, along with your height, weight, age and gender information to generate results based on OMRON's data of body composition.

### ***Measures the whole body to avoid the influence of fluctuations***

During the course of a day, the amount of water in the body tends to gradually shift to the lower limbs. This is why there is a tendency for the legs and ankles to swell in the evening or at night. The ratio of water in the upper body and lower body is different in the morning and evening, and this means that the electrical impedance of the body also varies. Since the BF500 uses electrodes for both hands and feet to take measurements, it can reduce the influence of these fluctuations on measurement results.

### ***What is the Bioelectrical Impedance method?***

Muscles, blood vessels and bones are body tissues having a high water content that conduct electricity easily. Body fat is tissue that has little electric conductivity. The BF500 sends an extremely weak electrical current of 50 kHz and less than 500  $\mu\text{A}$  through your body to determine the amount of fat tissue. This weak electrical current is not felt while operating the BF500. The Bioelectrical Impedance Method safely combines the electric resistance with the distance of the electricity conducted. Correct posture and consistent measuring conditions need to be maintained for the best results.

### ***Uses the best methods to measure different aspects of body composition***

OMRON has conducted research using exhalation and MRI analysis to develop an algorithm by which the bio impedance method of the BF500 works.

**Body Fat Percentage:** This is based on the DXA (Dual Energy X-Ray Absorptiometry) method, which has been the established method for accurate evaluation of body composition. OMRON has used research information from several hundred people using the DXA method to develop the formula by which the BF500 works. The body fat mass and body fat percentage is calculated by a formula that includes five factors: electric resistance, height, weight, age and gender.

The DXA method uses two different frequency X-Rays and rates of absorption of the body and determines the value based on the difference between the two.

**Resting Metabolism:** This is based on exhalation analysis, where the composition of exhaled air is analysed. This makes it possible to calculate the resting metabolism by measuring the consumption of oxygen in exhaled air.

**Visceral Fat Level:** This is based on MRI (Magnetic Resonance Imaging) analysis, which uses nuclear magnetic resonance that take non-intrusive images of the body. This makes it possible to calculate the area of visceral fat in the body.

**Skeletal Muscle Percentage:** This is based on MRI (Magnetic Resonance Imaging) analysis, which uses nuclear magnetic resonance that take non-intrusive images of the body. This makes it possible to calculate the amount of skeletal muscle in the body.

***The reason calculated results may differ from actual body fat percentage***

There are certain conditions, such as with dialysis patients, when significant differences may occur between the estimated and actual body fat values.

These differences may be related to changing ratios of body fluid and/or body composition.

### **Recommended measurement times**

Understanding the normal changes in your body fat percentage can help you in preventing or reducing obesity. Being aware of the times when the body fat percentages shift within your own daily schedule will assist you in obtaining an accurate trending of your body fat. It is recommended to use this unit in the same environment and daily circumstances. (See chart)

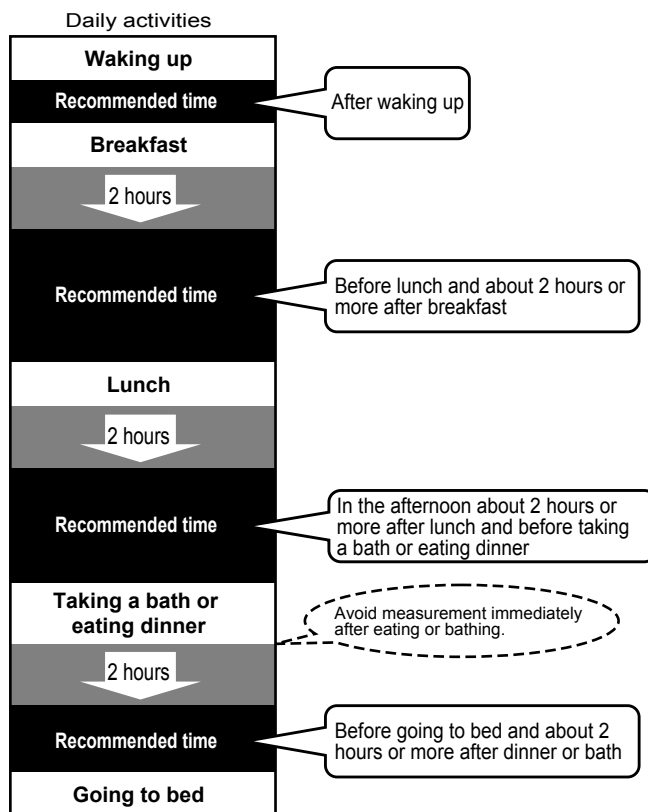

### **Avoid taking measurements under the following conditions**

If a measurement is made under the following physical conditions, the estimated body fat percentage may differ significantly from the actual one because the water content in the body is changing.

Avoid taking measurements:

- immediately after vigorous exercise

Please wait for 1 to 2 hours:

- after a bath or sauna
- after drinking alcohol
- after drinking lots of water
- after eating a meal

### **Measurement should be taken on a hard, level surface**

To ensure accurate measurement results, measurements should be taken on a hard, level surface.



### Long-term planning for successful weight loss

Ignoring a balanced diet and simply reducing food intake to lose weight can lead to a decline in muscle and bone. This may result in weight loss but not in the reduction in fat levels. So even though your weight goes down, your resting metabolism is reduced making the body more prone to putting on fat.

Example comparing the same loss of 10 kg

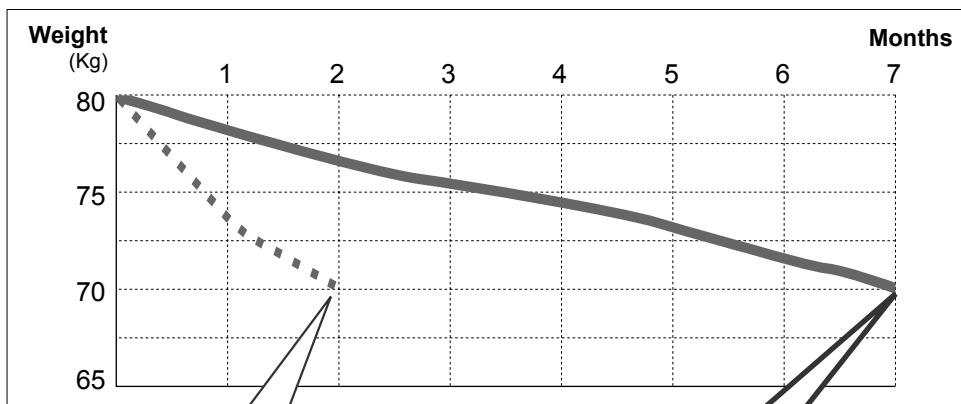

**A starvation-like diet produces rapid weight loss of 10 kg, but disrupts body mass...**

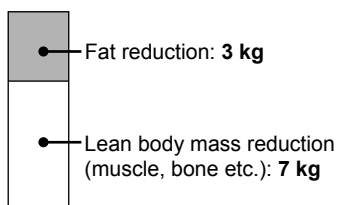

**Change in body fat percentage**

Body fat percentage  
 Before diet: **36.0%**  
 ↓  
 After diet: **36.9%**

Lean body mass (muscle, bone etc.) is greatly reduced, while the body fat percentage has not changed.

**A healthy diet with weight loss of 10 kg...**

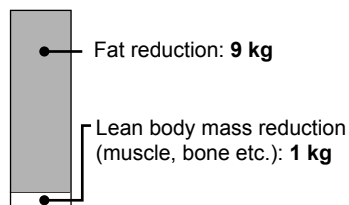

**Change in body fat percentage**

Body fat percentage  
 Before diet: **36.0%**  
 ↓  
 After diet: **28.3%**

Body fat percentage reduced to a normal level.

### Repeated dieting and regaining weight leads to increased visceral fat levels

It is easy to regain weight after sudden diets. This regained weight tends to appear as visceral fat rather than subcutaneous fat. Increased visceral fat levels are thought to increase the likelihood of common diseases. Repeated dieting and subsequent regaining of weight leads to increased visceral fat levels.

EN

# 1. Know Your Unit

## Display Unit

## Main Unit (Measurement Platform)

## Front View

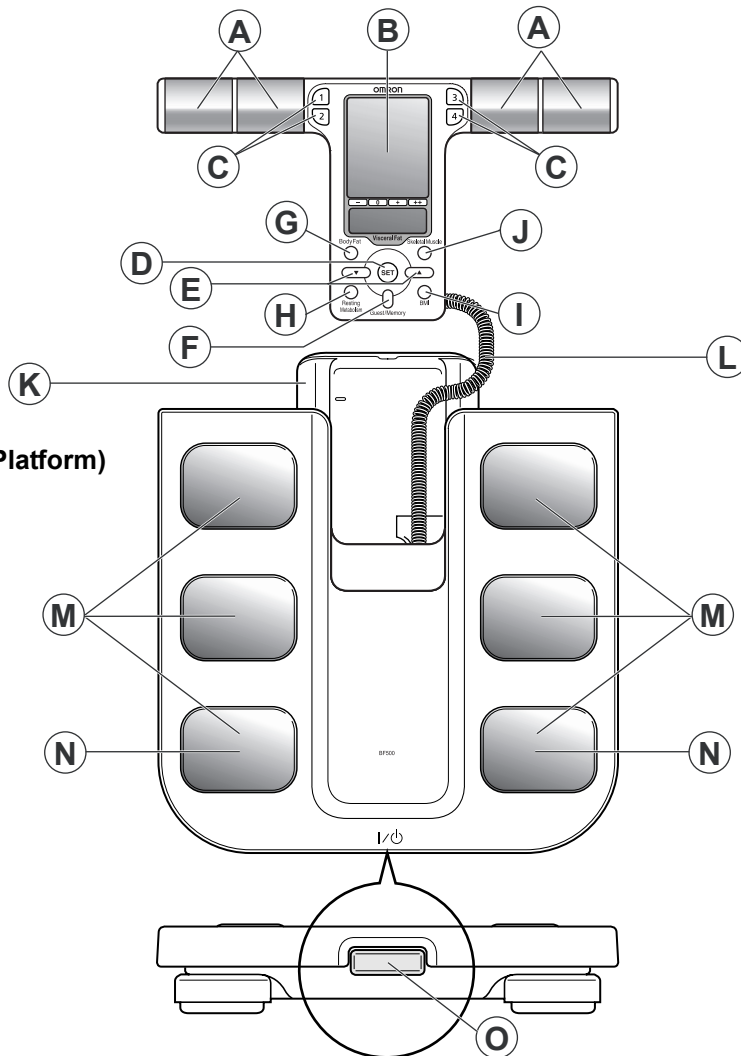

A. Grip Electrodes

B. Display

C. Personal Profile Number Button

D. SET Button

Use this button to confirm the personal data or move to the next item after confirming the set item.

E. Up/Down Buttons

Use these buttons to set the value or the gender for personal data. These are also used to select the measurement units used for the height and weight display.

F. Guest/Memory Button

Use this button to set the personal data for each measurement or to view measurement results stored in memory.

G. Body Fat Button

H. Resting Metabolism Button

I. BMI Button

J. Skeletal Muscle Button

K. Display Unit Holder

L. Cord

M. Foot Electrodes

N. Heel Electrodes

O. Power Switch

## Display

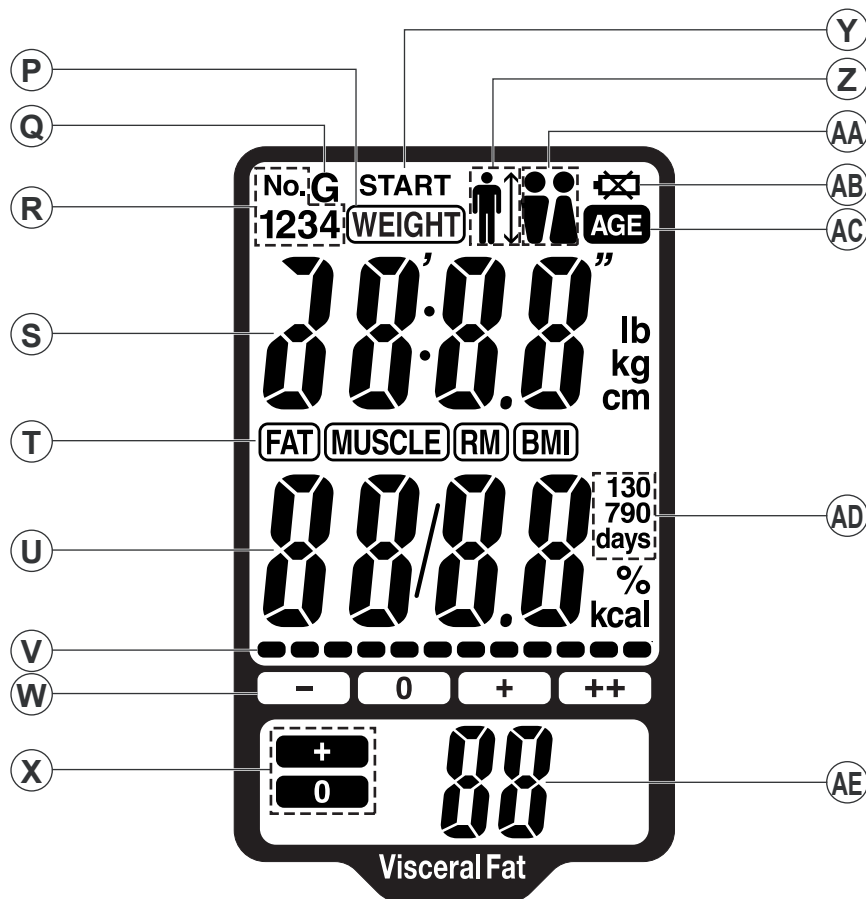

P. Weight Indicator

Q. Guest Indicator

R. Personal Profile Number

S. Weight Results

T. Display Mode Indicator

U. Body Composition Results

V. Body Fat Percentage and BMI Assessment 12 Levels Bar

W. Body Fat Percentage and BMI Classification Indicator

X. Visceral Fat Classification Indicator

Y. Measurement Start Indicator

Z. Height Indicator

AA. Gender Indicator

♂ (male)

♀ (female)

AB. Battery Low Indicator

AC. Age Indicator

AD. Memory Indicator

AE. Visceral Fat Results

EN

## Storing the Display Unit

Extend the cord and store the display unit as described below.

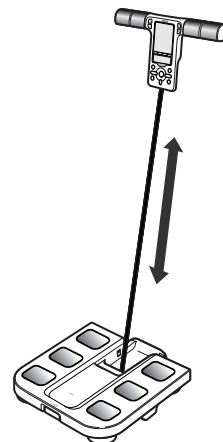

### 1. Coil the cord into the display unit holder.

**Note:** Make sure that the cord does not stick out of the holder and that the cord is coiled evenly.

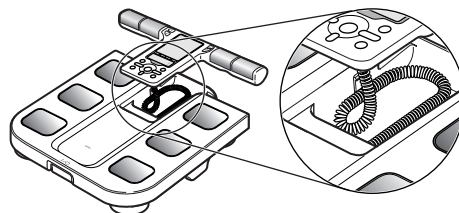

### 2. Push the display unit into the holder.

Push the display unit until it clicks into place.

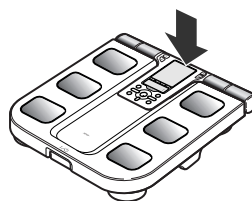

## About the Auto Power Off Function

The power will be automatically switched off in the following conditions:

- If the unit is not used within one minute of 0.0 kg appearing on the display.
- If no information is entered for 5 minutes when entering personal data.
- If the unit is not used for 5 minutes after measurement results are displayed.
- 5 minutes after the result is displayed when measuring weight only.

## 2. Inserting and Replacing the Batteries

1. Remove the battery cover on the rear side of the main unit.

- 1) Press the tab of the battery cover in the direction of the arrow to release the cover.
- 2) After releasing the battery cover, pull the tab of the cover upwards.

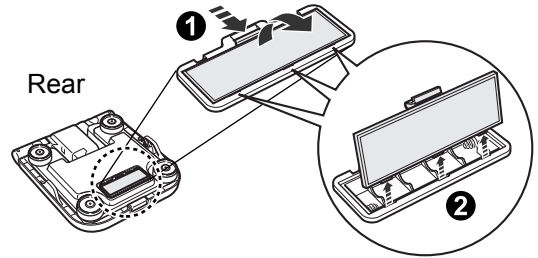

2. Insert the batteries by aligning them as indicated.

Make sure that their polarity (+/-) is aligned with the polarity (+/-) indicated in the battery compartment.

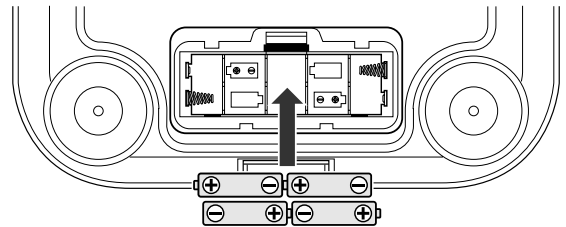

3. Close the battery cover.

- 1) Align the hooks on the battery cover with the slots in the battery compartment.
- 2) Push the battery cover until the tab clicks into place.

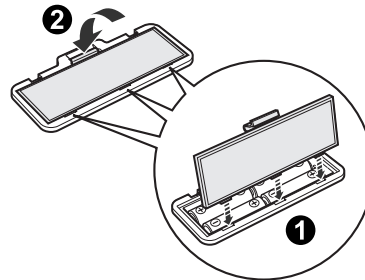

### Battery Life and Replacement

When the battery low indicator (  ) appears, replace all four batteries with new ones.

Items stored in memory are retained even if the batteries are removed. However, if the batteries are removed or replaced, you will be prompted to set the date and time the next time the unit is turned on.

- Replace the batteries after turning off the power.
- Disposal of used batteries should be carried out in accordance with the national regulations for the disposal of batteries.

### Battery life

- Four AA batteries will last approximately 1 year (when measurements are made four times a day).
- Because the supplied batteries are for trial use only, they may have a shorter life.

Battery low indicator

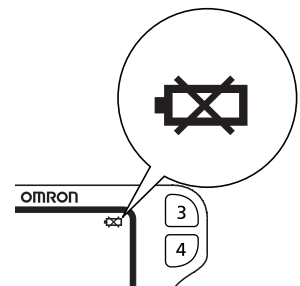

EN

### 3. How to Set the Date and Time

When the power is turned on for the first time, it is necessary to set the date and time.

**Buttons Used in this Procedure**

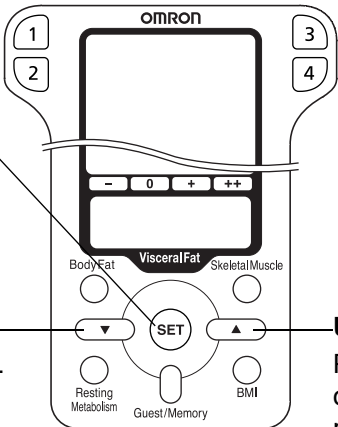

**SET button**  
Use this button to confirm the setting or move to the next item after confirming the set item.

**Down (▼) button**  
Press this button to go back one. Press continuously to rapidly decrease.

**Up (▲) button**  
Press this button to advance one. Press continuously to rapidly advance.

1. Press the power switch to turn the unit on.

If this is the first time that the unit has turned on, the year setting flashes.

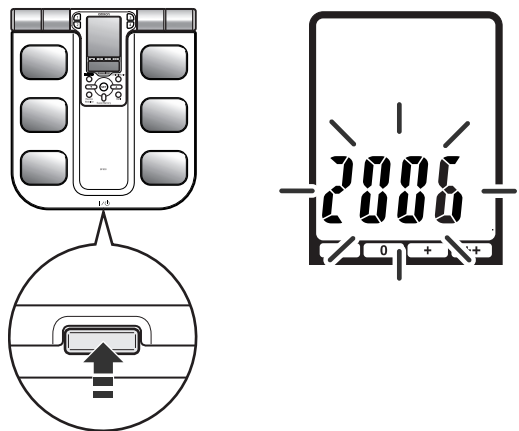

[TO SET THE YEAR]

2. Press the ▲ or ▼ button to adjust the year setting to the desired year.

3. Press the SET button.

The year setting is confirmed and the month flashes on the display.

[TO SET THE MONTH]

4. Press the ▲ or ▼ button to adjust the month setting to the desired month.



**5.** Press the SET button.

The month setting is confirmed and the day flashes on the display.

**[TO SET THE DAY]**

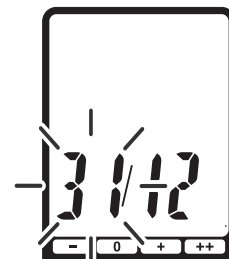
**6.** Press the ▲ or ▼ button to adjust the day setting to the desired day.**7.** Press the SET button.

The day setting is confirmed and the hour flashes on the display.

**[TO SET THE HOUR]**

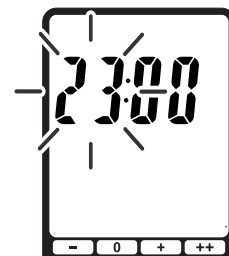
**8.** Press the ▲ or ▼ button to adjust the hour setting to the desired hour.**9.** Press the SET button.

The hour setting is confirmed and the minute flashes on the display.

**[TO SET THE MINUTE]**

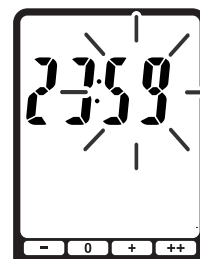
**10.** Press the ▲ or ▼ button to adjust the minute setting to the desired minute.**11.** Press the SET button.

The minute setting is confirmed.

After the settings for year, month, day, hour and minute are displayed in that sequence, the power is automatically turned off.

EN

## 4. Setting and Storing Personal Data

For the measurement of body fat percentage and visceral fat level, it is necessary to set your personal data (age, gender, height).

This section describes setting the personal profile setting for number 1 as an example.

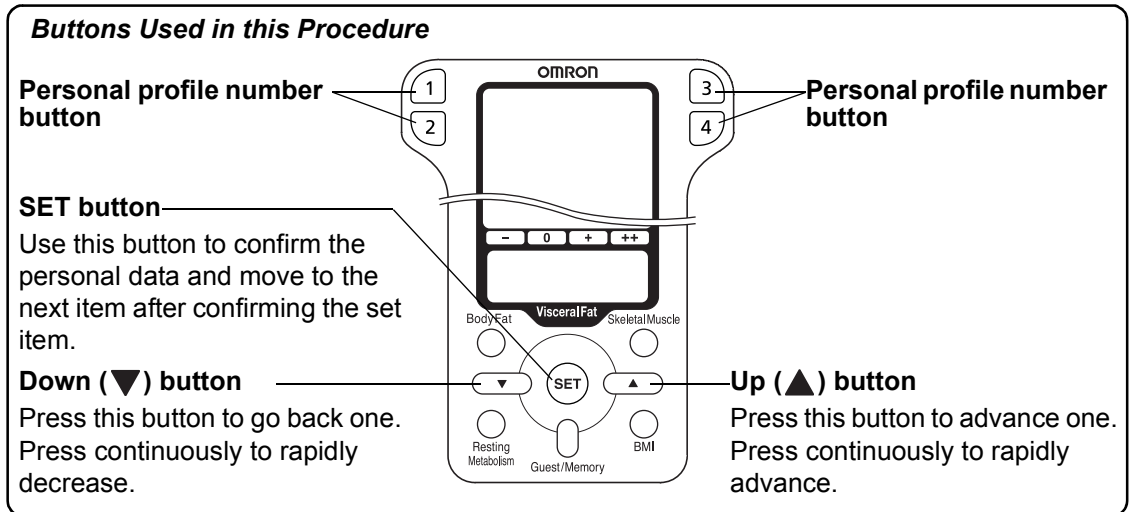

### 1. Push the power switch to turn on the unit.

“CAL” blinks on the display, then the display changes to 0.0 kg.  
Wait until 0.0 kg appears on the display.

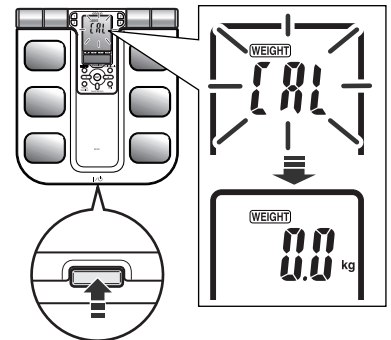

### 2. Take out the display unit.

**Note:** You can change the measurement units used for the height and weight settings. All height and weight measurements are displayed using the new measurement units. The change remains in effect until you change the measurement unit setting again. To change the measurement unit:

- 1) Keep the ▲ button pressed until “lb” and “kg” blink on the display.

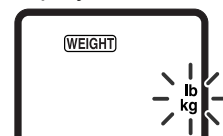

- 2) Press the ▲ or ▼ button to select the desired measurement unit, “lb” or “kg”. This will automatically change “cm” and “in”.
- 3) Press the SET button to confirm the change.



### 3. Select the personal profile number to store the personal data.

- 1) Press the personal profile number button to select a personal profile number.

The display of the selected personal profile number flashes.

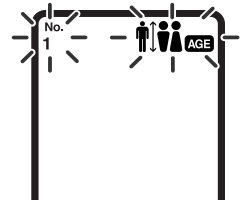

- 2) Press the SET button.

The personal profile number is confirmed and the default age setting blinks on the display.

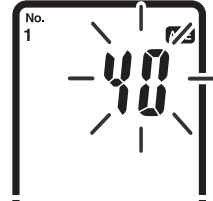

### 4. [TO SET THE AGE]

Setting range: 10 to 80 years old

- 1) Press the ▲ or ▼ button to adjust the age setting to the desired age.

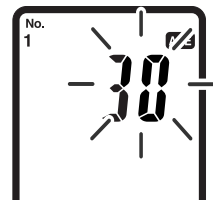

- 2) Press the SET button.

The age setting is confirmed, and the gender icons blink on the display.



### 5. [TO SET GENDER]

- 1) Press the ▲ or ▼ button to adjust the gender setting to the desired gender.

To select Gender ♂(male) or ♀(female), press the ▲ or ▼ button.

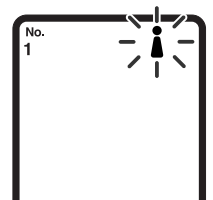

- 2) Press the SET button.

The gender setting is confirmed, and the default height setting blinks on the display.

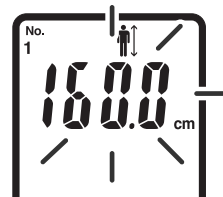

## 6. [TO SET HEIGHT]

Setting range: 100.0 to 199.5 cm (Display range in inch display mode: 3' 4" to 6' 6 3/4")

- 1) Press the ▲ or ▼ button to adjust the height setting to the desired height.
- 2) Press the SET button to confirm the settings.

After the settings for age, gender, and height are displayed in that sequence, then 0.0 kg appears on the display. You can now start taking measurements. (Proceed to Step 3 in Section 5 "Taking a Measurement".)

When using GUEST mode, the unit starts measurement after the height setting has been confirmed. Refer to Section 5.

The personal data has been stored in selected personal profile number.

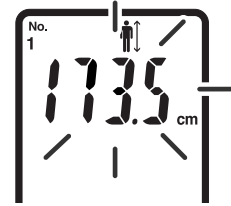

## Changing the Information for a Personal Profile Number

If the personal data stored for any of the personal profile numbers (1-4) changes, the settings for that personal profile number will need to be modified.

1. Push the power switch to turn on the unit.  
"CAL" blinks on the display, then the display changes to 0.0 kg. Wait until 0.0 kg appears on the display.
2. Take out the display unit.
3. Select the personal profile number for which you want to modify the personal data.
  - 1) Press the personal profile number button to select a personal profile number.  
The display of the selected personal profile number flashes once.
  - 2) Press the SET button.  
The personal profile number is confirmed and the selected age setting blinks on the display.

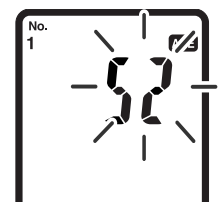

4. Change the stored data.
  - 1) Modify the age setting.
    - a) Press the ▲ or ▼ button to adjust the age setting to the desired age.
    - b) Press the SET button.  
The age setting is confirmed, and the gender icon blinks on the display.

- 2) Modify the gender setting.
  - a) Press the ▲ or ▼ button to adjust the gender setting to the desired gender.
  - b) Press the SET button.  
The gender setting is confirmed, and the height setting blinks on the display.
- 3) Modify the height setting.
  - a) Press the ▲ or ▼ button to modify the height setting.
  - b) Press the SET button to confirm the change.  
If you are going to change other data, repeat this procedure.

## Deleting a Personal Profile Number

1. Push the power switch to turn on the unit.  
“CAL” blinks on the display, then the display changes to 0.0 kg.  
Wait until 0.0 kg appears on the display.
- 
2. Select the personal profile number for which you want to delete the personal data.

- 1) Press the personal profile number button to select a personal profile number.  
The display of the selected personal profile number flashes once.
- 2) Press the SET button.  
The personal profile number is confirmed and the selected age setting blinks on the display.

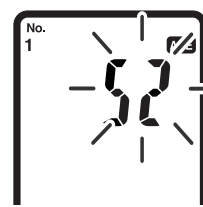

3. Delete the personal data.

Press the Guest/Memory button for two seconds or longer.

“Clr” will appear in the display and the personal data and measurement values are deleted from memory.

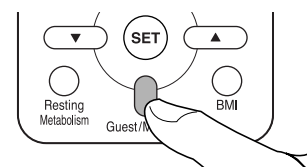
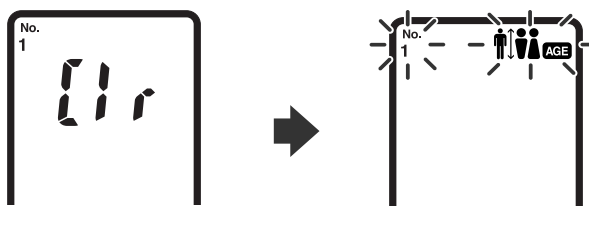

EN

4. Turn off the unit.

Press the power switch to turn off the power.

## 5. Taking a Measurement

### How to Measure Body Composition

Please see Step 4 on this section for correct posture.

1. Turn on the power, by pressing the power switch.  
“CAL” blinks on the display, then the display changes to 0.0 kg.

#### Notes:

- If you step onto the unit before 0.0 kg appears on the display, an error message “Err” will appear.
- You can change the measurement units used for the height and weight settings. To change the measurement unit:
  - 1) Keep the ▲ button pressed until “lb” and “kg” blink on the display.

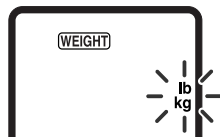
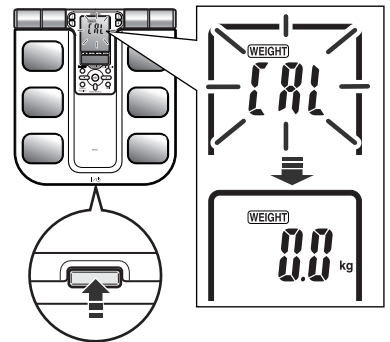

- 2) Press the ▲ or ▼ button to select the desired measurement unit, “lb” or “kg”. This will automatically change “cm” and “in”.
- 3) Press the SET button to confirm the change.

2. When the 0.0 kg appears on the display, take out the display unit.

**Note:** Do not take out the display unit until 0.0 kg appears on the display. The weight of the display is then added to your body weight which causes an incorrect result.

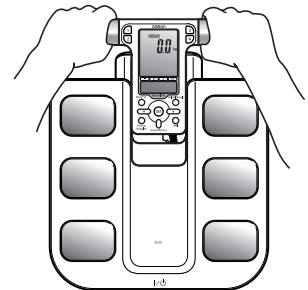

### How to Hold the Grip Electrodes

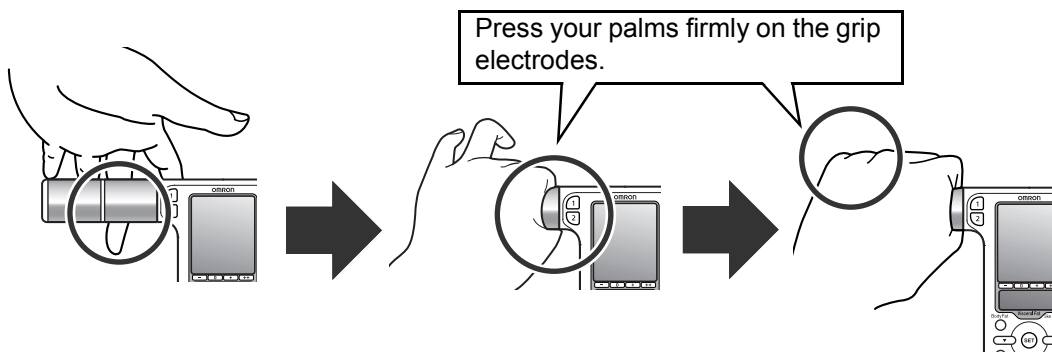

Place both middle fingers along the dents of the grip electrodes.

Hold the inner grip electrodes firmly with your thumb and index finger.

Hold the outer grip electrodes with your ring finger and small finger.

### 3. Select the personal profile number button or the Guest/Memory button.

#### **If you have personal data (Personal profile number) stored on the unit:**

Press the stored personal profile number button while holding the display unit. The stored personal profile number will appear after blinking once.

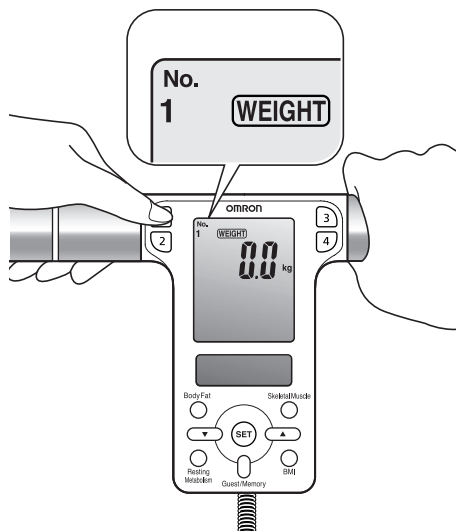

Ex.: To select personal profile number "1", press button **1**.

#### **If the following display is indicated:**

Your personal data is not stored in the personal profile number you have selected. Please see Section 4 to store personal data.

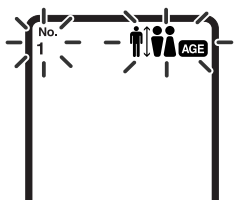

#### **If you do not have personal data stored on the unit (GUEST mode):**

Even if you do not have personal data stored on the unit, you can measure your body composition by entering your age, gender, and height before taking a measurement.

- 1) Press the Guest/Memory button while holding the display unit.

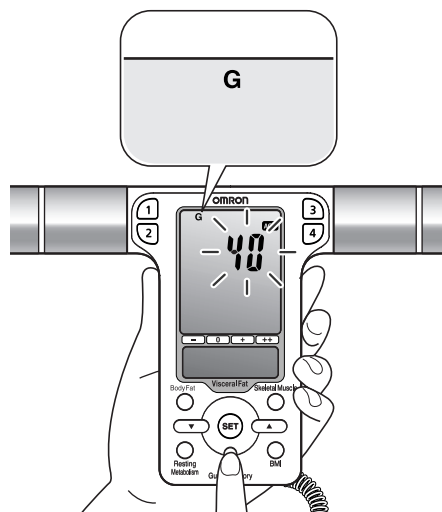

"G" will be indicated at the top of the display while "AGE" data flashes.

- 2) Set the personal data (age, gender, and height). Read steps 4 through 6 in Section 4 "Setting and Storing Personal Data".

EN

#### 4. Start measurement.

- 1) Step on the main unit and place your feet on the foot electrodes with your weight evenly distributed.

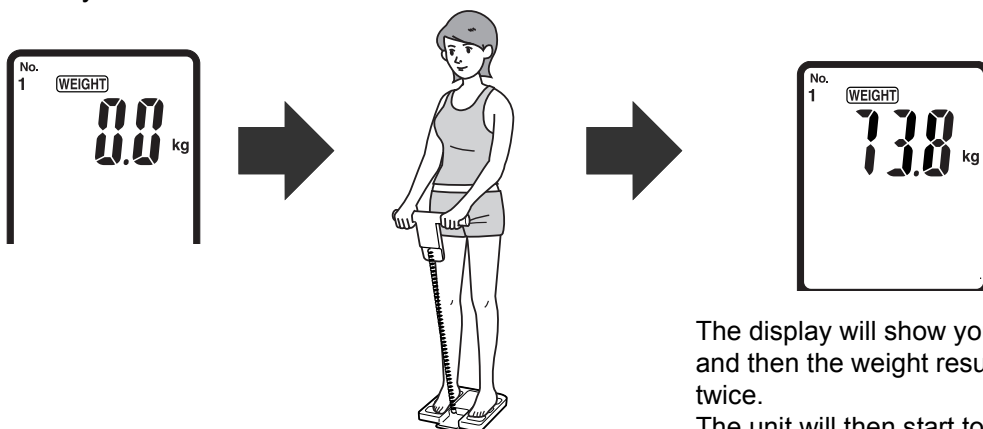

Step onto the unit.  
Distribute weight evenly.

The display will show your weight and then the weight result will blink twice.

The unit will then start to measure your body fat percentage and visceral fat level.

- 2) When "START" appears on the display extend your arms straight at a 90° angle to your body.

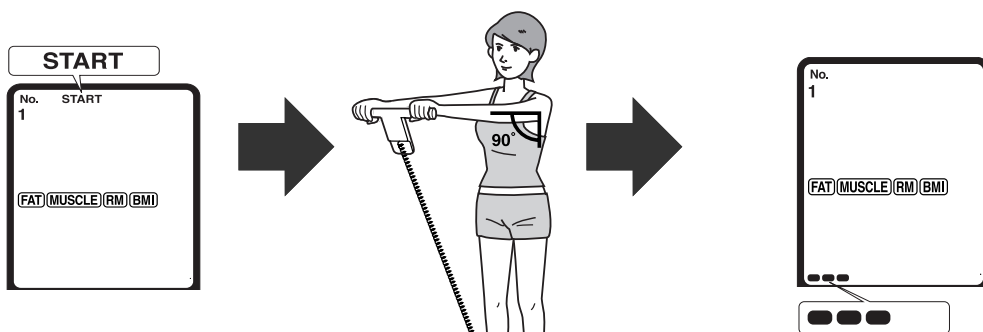

The indicators in the measurement progress bar at the bottom of the display will gradually appear, from left to right.

- 3) After measurement completes, your weight is displayed again. At this point you may step off the unit.

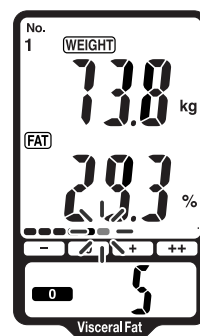

### Correct Posture for Measurement

When taking a measurement using a personal profile number, you need to store the personal data before hand. (Refer to Section 4.)

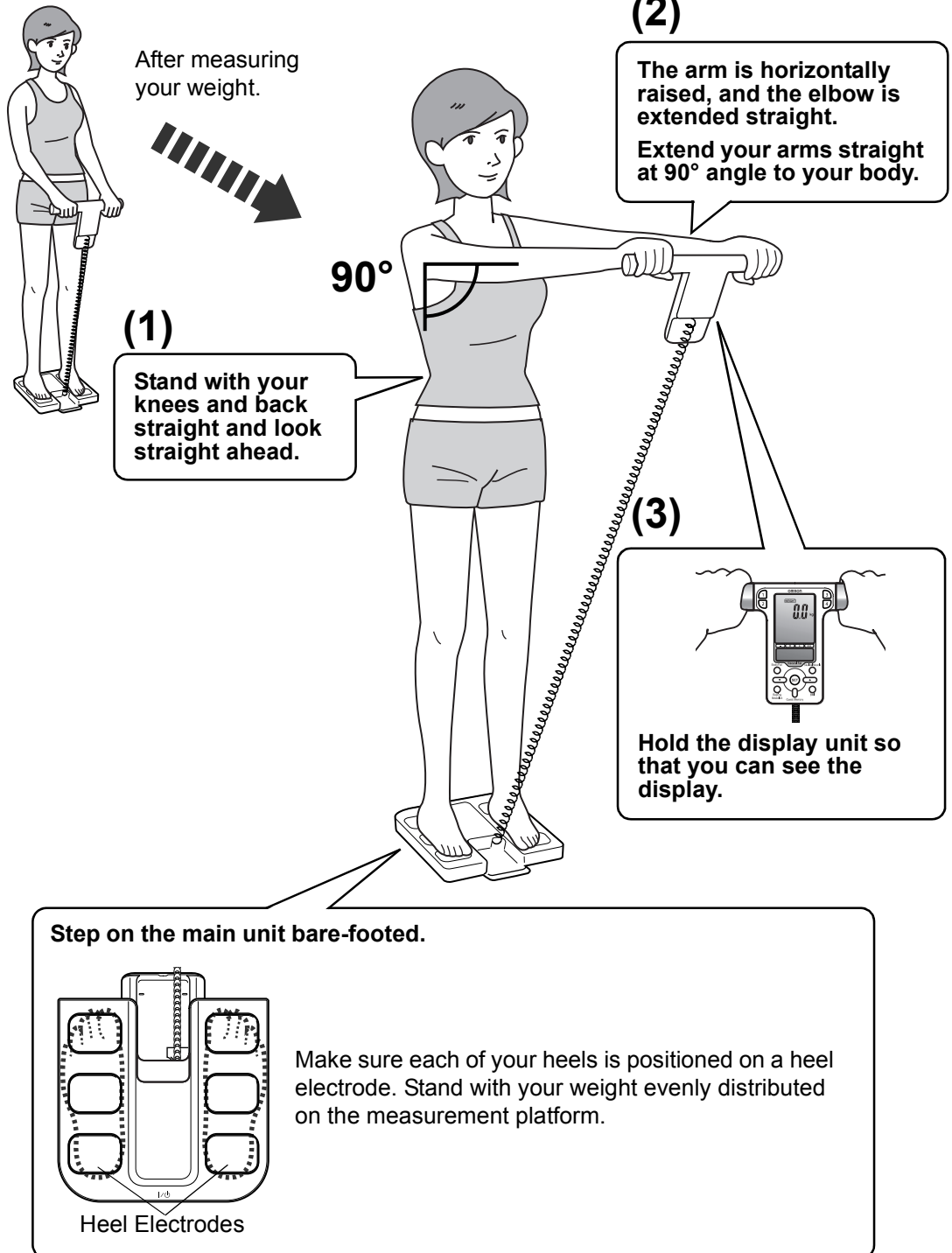

EN

### POSTURES TO AVOID DURING MEASUREMENT

Incorrect posture may result in inaccurate measurement of body composition.

Movement during measurement

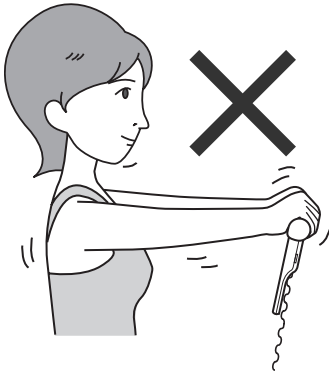

Arms bent

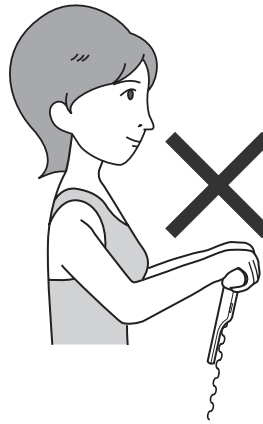

Arms too low or high

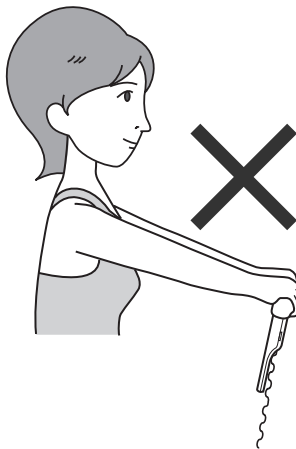

Display facing upwards

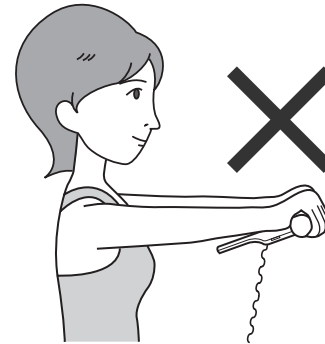

Knees bent

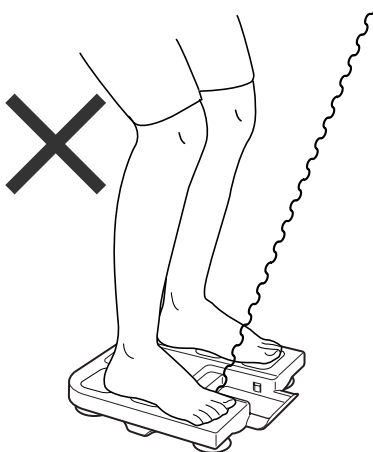

Standing on edge of unit

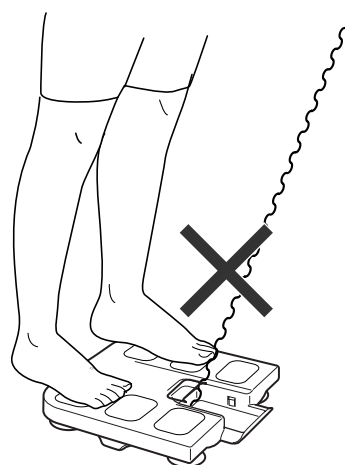



## 5. Check the measurement results.

Press the appropriate button to view the desired measurement results.

For an explanation of the body composition results, see "Understanding the Results".

### BodyFat

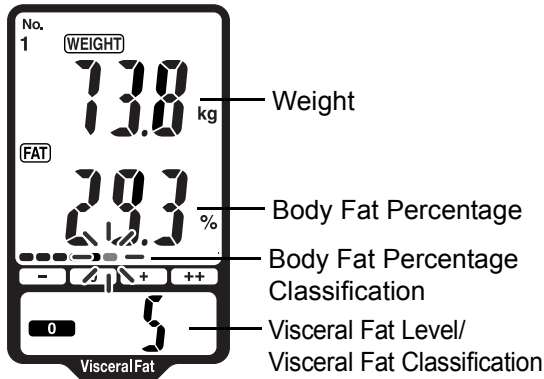

### SkeletalMuscle

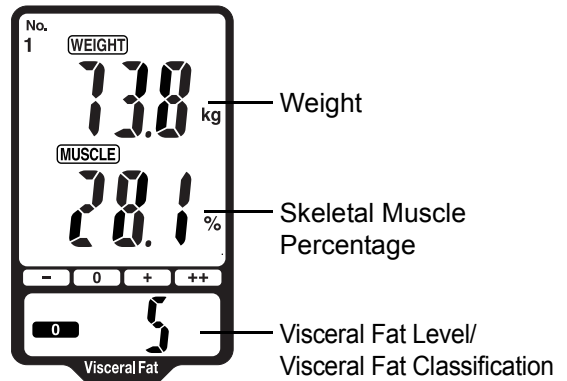

### Resting Metabolism



### BMI

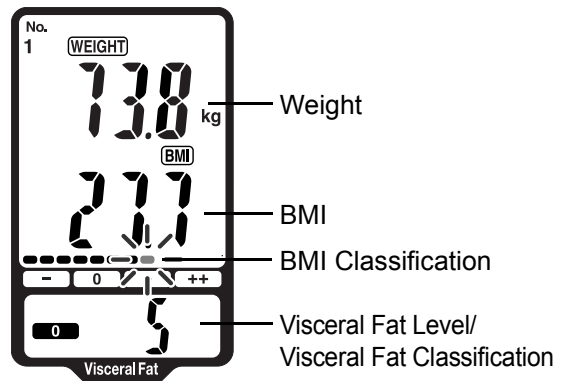

EN

### Interpreting the BMI Result

BMI	BMI (Designation by the WHO)	BMI Classification Bar				BMI Rating
		-	0	+	++	
Less than 18.5	- (Underweight)	█				7.0 - 10.7 10.8 - 14.5 14.6 - 18.4
18.5 or more and less than 25	0 (Normal)	█████	█			18.5 - 20.5 20.6 - 22.7 22.8 - 24.9
25 or more and less than 30	+ (Overweight)	█████████	█████	█		25.0 - 26.5 26.6 - 28.2 28.3 - 29.9
30 or more	++ (Obese)	██████████	██████████	█████	█	30.0 - 34.9 35.0 - 39.9 40.0 - 90.0

The above-mentioned indices refer to the values for obesity judgment proposed by the WHO, the World Health Organization.

### Interpreting the Body Fat Percentage Result

- (Low)	0 (Normal)	+	++ (Very High)

### Interpreting the Visceral Fat Result

Visceral Fat Level $\leq 9$	Visceral Fat Level $\geq 10$
0 (Normal)	+

Visceral fat area (0 - approx. 300 cm<sup>2</sup>, 1 inch=2.54 cm) distribution 30 levels.

Example level determined

0: 1 - 9 level

+: 10 - 30 level

\* The data referenced by Omron Healthcare.

- When the measurement is completed, step off from the main unit and turn off the power.

Press the power switch to turn the power off.

#### Notes:

- If you forget to turn the power off, the unit will be turned off automatically after 5 minutes.
- Store the display unit in the display unit holder.

For additional information, please see Section "Understanding the Results".

## 6. Measuring Weight Only

1. Turn on the power, by pressing the power switch.

“CAL” blinks on the display, then the display changes to 0.0 kg.

### Notes:

- If you step onto the unit before 0.0 kg appears on the display, an error message “Err” will appear.
- You can change the measurement units used for the height and weight settings. To change the measurement unit:

- 1) Keep the ▲ button pressed until “lb” and “kg” blink on the display.

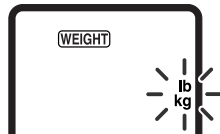

- 2) Press the ▲ or ▼ button to select the desired measurement unit, “lb” or “kg”. This will automatically change “cm” and “in”.

- 3) Press the SET button to confirm the change.

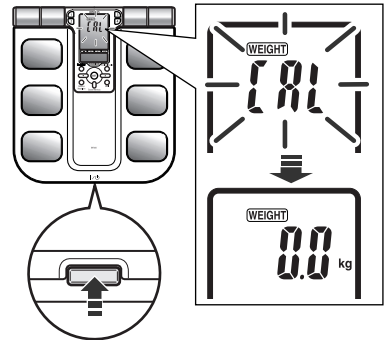

2. When the 0.0 kg appears on the display, step onto the unit.



3. Check the measurement results.

Your weight is displayed on the display and blinks twice to indicate that measurement is complete.

**Note:** You can also check the measurement result by taking out the display unit.

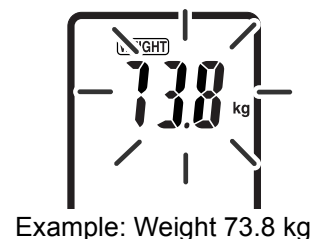

4. When the measurement is completed, step down from the unit and turn off the power.

## 7. Using the Memory Function

Measurement results are automatically stored in memory when you take a measurement using a personal profile number button. In order to assist your tracking of measurements, the device has stored 97 memories, and allows you to view the results for only 1 day, 7, 30, and 90 days before.

When 97 sets of measurement values are stored in the memory, the oldest record is deleted to save the most recent measurement values.

### Notes:

- If you did not take a measurement on the exact date for 1, 7, 30, or 90 days before, the results for the previous day are displayed. If there is no measurement result for the previous day, then the results for the day before that are displayed. For example, when viewing the 7 days before result, if there are no results for 7, 8, or 9 days before, then the result for 10 days before is used. This is done for up to 14 days before the appropriate date.
- Only one set of measurement results is stored for each personal profile number each day. If more than one measurement is taken during a day, the results from the last measurement are stored.

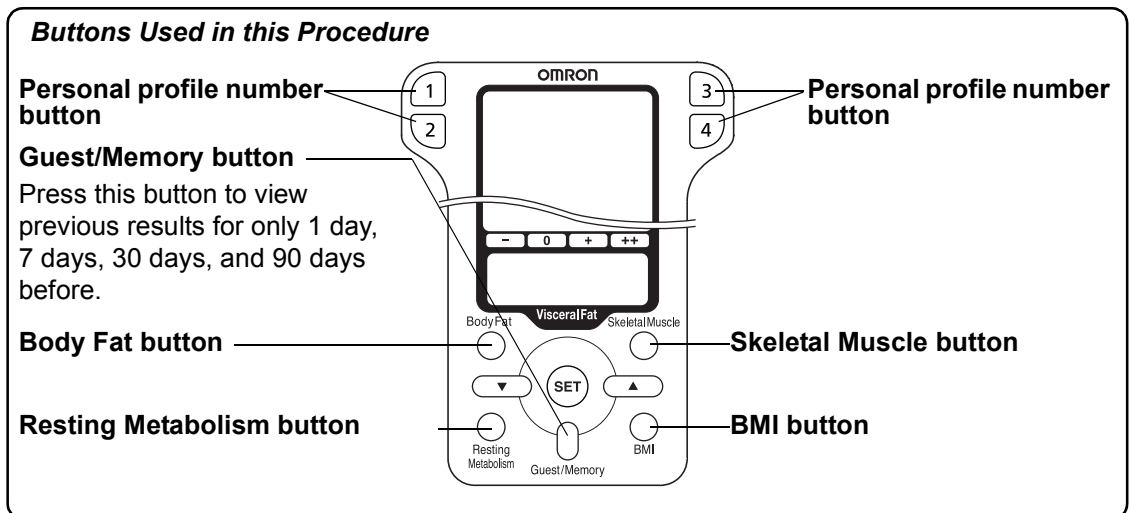

### Comparing Results After Taking a Measurement

1. View the measurement results after taking a measurement.

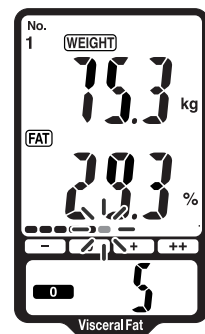

Current weight/Body Fat Percentage

- Press the Guest/Memory button once to compare with the result from the previous day.

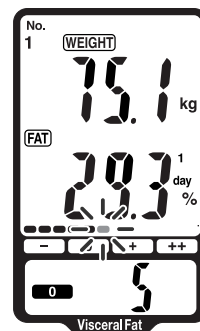

Weight and Body Fat Percentage  
- 1 day ago -

- Press the Guest/Memory button again to compare it with the result from 7 days ago.

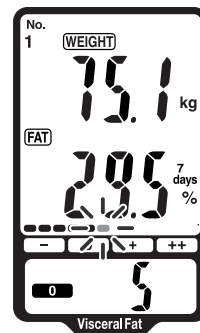

Weight and Body Fat Percentage  
- 7 days ago -

- Press the Guest/Memory button a third time to compare with the result from 30 days ago.

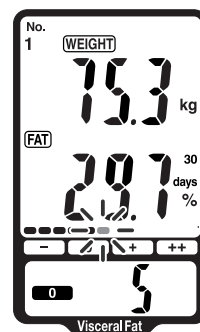

Weight and Body Fat Percentage  
- 30 days ago -

- Press the Guest/Memory button a fourth time to compare with the result from 90 days ago.

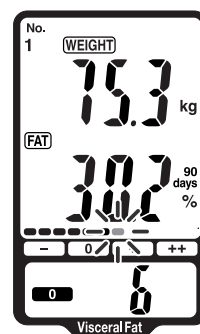

Weight and Body Fat Percentage  
- 90 days ago -

**Notes:**

- If there are no results for a selected memory, “- - - -” is displayed for that item.

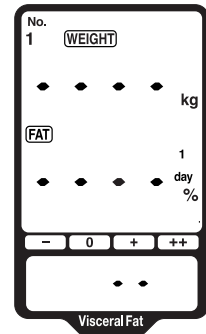

[Example only. The screen for the item selected will be displayed.]

- To view previous results for other items, press the button for the desired item. The results for the selected item are displayed. Then press the Guest/Memory button to cycle through the previous results for that item in the same way as for weight and body fat percentage.

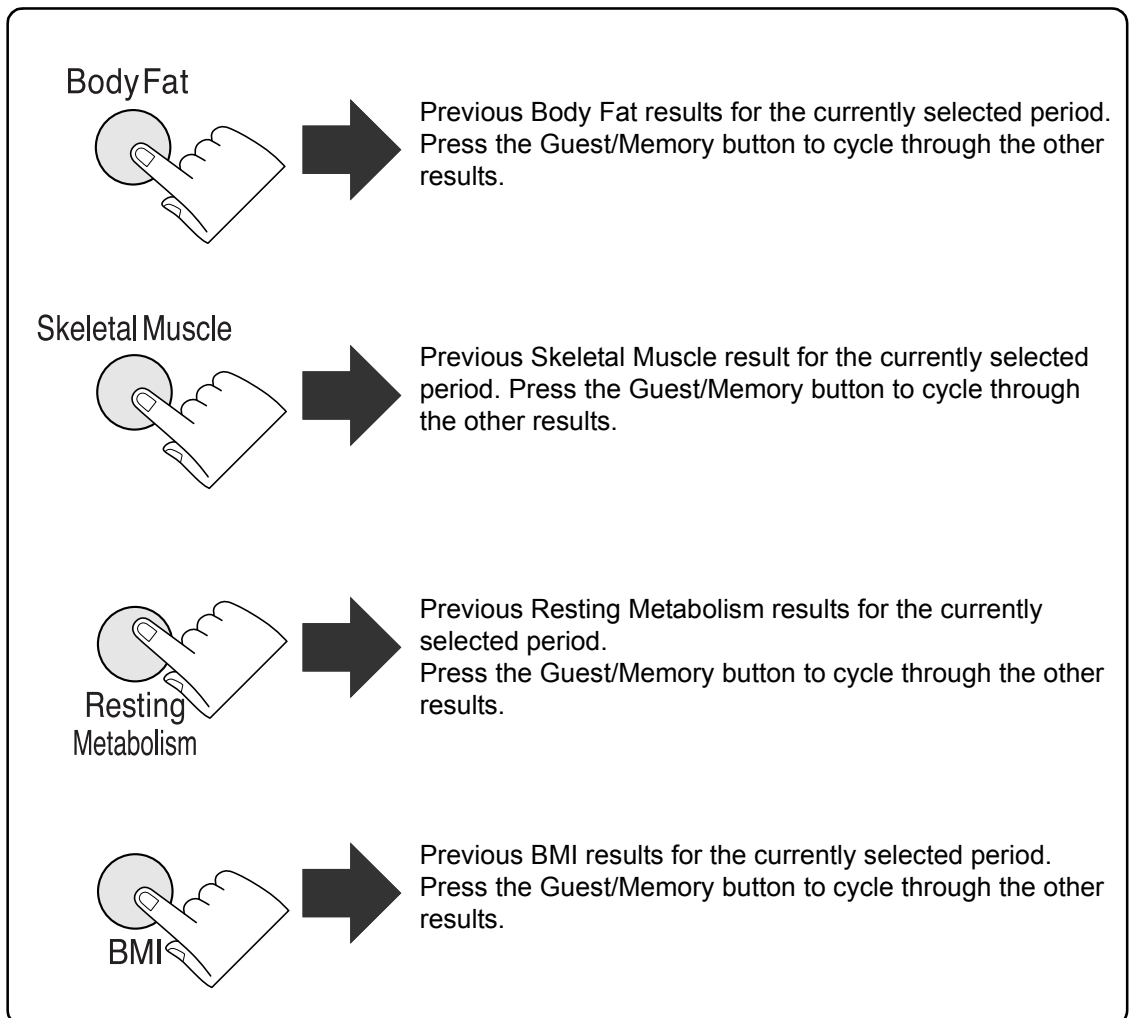

## 6. Press the power switch to turn the display off.

## Viewing Previous Measurement Results

Follow this procedure if you just want to view and compare previous measurement results, without taking a measurement.

1. Turn on the power, by pressing the power switch.

“CAL” blinks on the display, then the display changes to 0.0 kg.

**Note:** Do not step on the unit to view previous measurements.

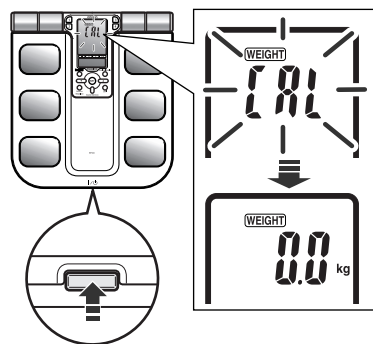

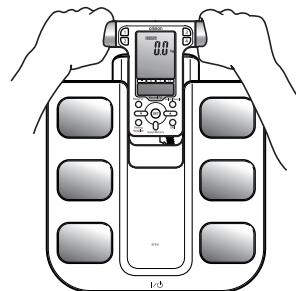

2. When the 0.0 kg appears on the display, take out the display unit.

**Note:** Do not take out the display unit until 0.0 kg appears on the display.

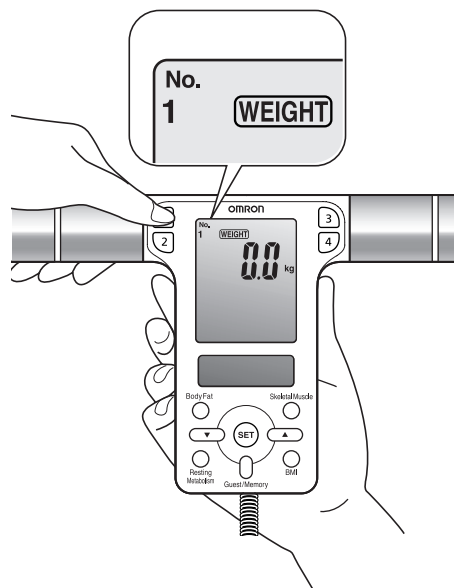

3. Press the desired personal profile number button.



Ex.: To select personal profile number “1”, press button .

EN

**4.** View the previous measurement results.

- 1) Press the Guest/Memory button once.

The results for the previous day are displayed.

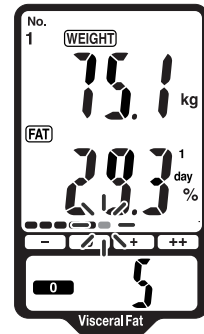

[Example]

- 2) Press the Guest/Memory button to cycle through the results from “1 day”, “7 days”, “30 days”, and “90 days” ago.

---

**5.** Press the power switch to turn the display off.



## 8. Error Displays

Error Display	Cause	Correction
<b>Err 1</b>	Your palms or soles are not in firm contact with the electrodes.	Press your palms or soles firmly to the electrodes, then measure. (Refer to Section 5.)
<b>Err 2</b>	The posture for measurement is wrong or the palms or soles are not in firm contact with the electrodes.	Measure without moving the hands or soles. (Refer to Section 5.)
<b>Err 3</b>	The palms or soles are too dry.	Moisten the palms or soles with a wet towel, then repeat measurement. (Refer to Section 5.)
<b>Err 4</b>	Values of body composition are out of measurable range.	Please ensure that your personal data is within the measurable range of the device. (see Section 11).
<b>Err 5</b>	Abnormal operation.	Insert the batteries again and repeat measurement. If this error still occurs, consult your OMRON service representative.
<b>Err</b>	You stepped on the unit before the display indicated 0.0 kg.	Step on the main unit after the display indicates 0.0 kg.
	You moved the main unit before the display indicated 0.0 kg.	Do not move the main unit until the display indicates 0.0 kg.
	You moved your body while measuring body weight.	Do not move while measuring body weight.
	Your weight is 135 kg or over.	Body weight of 135 kg or over is out of the measuring range of this unit. You cannot use this unit.

## 9. Troubleshooting

Problem	Cause	Correction
The displayed value of body composition is abnormally high or low.	Refer to "The reason calculated results may differ from actual body fat percentage" and "Recommended measurement times" in "What You Should Know When Using This Unit".	
The power turns off approximately 10 seconds after the body weight is confirmed and before your body fat percentage and visceral fat level is measured.	You did not press the correct personal profile number or the Guest/Memory button.(The personal profile number or "G" is not displayed on the display unit.)	Press the correct personal profile number or the Guest/Memory button. (Refer to Section 5.)
Nothing is displayed when the power is turned on.	Batteries are not inserted.	Insert the batteries.
	The polarities of batteries are not aligned correctly.	Insert the batteries in correct alignment.
	The batteries are worn out.	Replace all four batteries with new ones. (Refer to Section 2.)
	The cord connecting the main unit and the display unit is damaged or worn.	Contact the nearest OMRON service representative.

# 10. How to Care and Store the Unit

## How to Clean the Unit

- Always keep the unit clean before use.
- Wipe the main unit with a soft dry cloth. If necessary, use a cloth moistened with water or detergent and squeeze it well before wiping the unit, then wipe dry with a dry cloth.

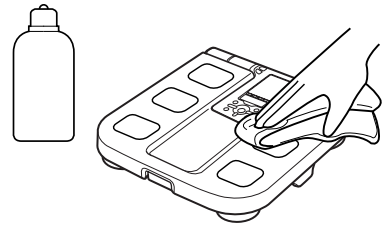

- Please make sure water does not get into the main unit.
- Do not use benzene, thinner, or gasoline to clean the unit.

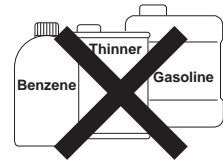

## Care and Storage

- Store the display unit in the main unit as shown in the figure. As you push the lower portion of the display unit, it clicks and fits into the holder.
- When storing the display unit, be careful not to crease the cord.

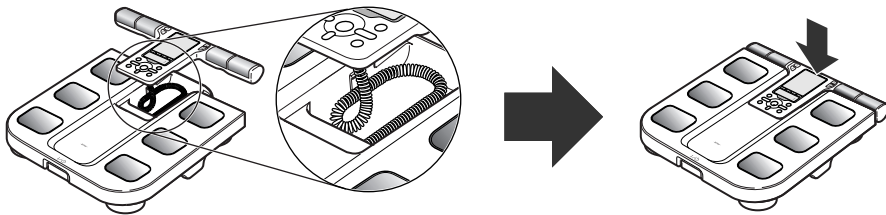

- Do not store the unit in the following conditions:
  - Humidity, where moist or water may get in the unit
  - High temperatures, direct sunlight and dusty places
  - Places with the risk of sudden shocks or vibrations
  - In storage places of chemicals or where corrosive gas is present.

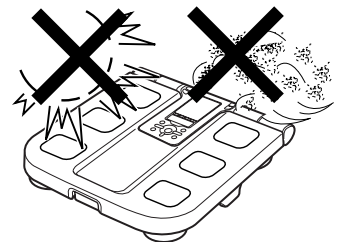

- Do not carry out repairs of any kind yourself. If a defect occurs, consult the OMRON distributor or Customer Services as mentioned on the packaging.

EN

# 11. Technical Data

<b>Name</b>	<b>BF500</b>
<b>Product</b>	Body Composition Monitor
<b>Model</b>	<b>HBF-500-E</b>
<b>Display</b>	<b>Display of minimum body weight:</b> 0 to 135 kg with an increment of 100 g <b>Body Fat percentage:</b> 5.0 to 60.0% with an increment of 0.1% <b>Skeletal Muscle percentage:</b> 5.0 to 50.0% with an increment of 0.1% <b>BMI:</b> 7.0 to 90.0 with an increment of 0.1 <b>Resting Metabolism:</b> 385 to 5000 kcal with an increment of 1 kcal <b>Visceral Fat Level:</b> 30 levels with an increment of 1 level <b>BMI classification:</b> – (Underweight) / 0 (Normal) / + (Overweight) / ++ (Obese) with 12 levels of Bar display <b>Body fat percentage classification:</b> – (Low) / 0 (Normal) / + (High) / ++ (Very High) with 12 levels of Bar display <b>Visceral fat classification:</b> 0 (Normal) / + (High) <b>Memory:</b> 1 day ago / 7 days ago / 30 days ago / 90 days ago
<b>Set Items</b>	<b>Height:</b> 100.0 to 199.5 cm (3' 4" to 6' 6 3/4") <b>Age:</b> 10 to 80 years old <b>Gender:</b> Male/Female <small>* Height and the contents of a memory are displayed in the unit. *The age range for the skeletal muscle percentage, resting metabolism and visceral fat level is 18 to 80 years old. The age range for the body fat percentage classification is 20 to 79 years old.</small>
<b>Weight Accuracy</b>	0.0 kg to 40.0 kg: ± 400 g 40.1 kg to 135.0 kg: ± 1%
<b>Accuracy (S.E.E.)</b>	<b>Body Fat percentage:</b> 3.5% <b>Skeletal Muscle percentage:</b> 3.5% <b>Resting Metabolism:</b> 120 kcal <b>Visceral Fat Level:</b> 3 levels
<b>Power Supply</b>	4 AA batteries (R6) (You may also use AA alkaline batteries (LR6).)
<b>Battery Life</b>	Approximately 1 year (when manganese batteries are used with four measurements a day)
<b>Operating Temperature /Humidity</b>	+10°C to +40°C, 30% to 85% RH
<b>Storage Temperature/ Humidity/Air Pressure</b>	-20°C to +60°C, 10% to 95% RH, 700 hPa - 1060 hPa
<b>Weight</b>	Approximately 2.2 kg (including batteries)
<b>External Dimensions</b>	<b>Display unit:</b> Approx. 300 (W) × 35 (H) × 155 mm (D) <b>Main unit:</b> Approx. 300 (W) × 57 (H) × 325 mm (D)
<b>Package Contents</b>	4 AA manganese batteries (R6), instruction manual
<b>Note:</b>	Subject to technical modification without prior notice.



= Type BF

CE 0197

 Please read the instruction manual carefully before using the device.



**Correct Disposal of This Product  
(Waste Electrical & Electronic Equipment)**

This marking shown on the product or its literature, indicates that it should not be disposed of, with other household wastes at the end of its working life. To prevent possible harm to the environment or human health from uncontrolled waste disposal, please separate this from other types of wastes and recycle it responsibly to promote the sustainable reuse of material resources.

Household users should contact either the retailer where they purchased this product, or their local government office, for details of where and how they can take this item for environmentally safe recycling.

Business users should contact their supplier and check the terms and conditions of the purchase contract. This product should not be mixed with other commercial wastes for disposal.

This product does not contain any hazardous substances.

Disposal of used batteries should be carried out in accordance with the national regulations for the disposal of batteries

**Important information regarding Electro Magnetic Compatibility (EMC)**

With the increased number of electronic devices such as PC.s and mobile (cellular) telephones, medical devices in use may be susceptible to electromagnetic interference from other devices. Electromagnetic interference may result in incorrect operation of the medical device and create a potentially unsafe situation.

Medical devices should also not interfere with other devices.

In order to regulate the requirements for EMC (Electro Magnetic Compatibility) with the aim to prevent unsafe product situations, the EN60601-1-2 standard has been implemented. This standard defines the levels of immunity to electromagnetic interferences as well as maximum levels of electromagnetic emissions for medical devices.

This medical device manufactured by OMRON Healthcare conforms to this EN60601-1-2:2001 standard for both immunity and emissions.

Nevertheless, special precautions need to be observed:

- Do not use mobile (cellular) telephones and other devices, which generate strong electrical or electromagnetic fields, near the medical device. This may result in incorrect operation of the unit and create a potentially unsafe situation. Recommendation is to keep a minimum distance of 7 m. Verify correct operation of the device in case the distance is shorter.

Further documentation in accordance with EN60601-1-2:2001 is available at OMRON Healthcare Europe at the address mentioned in this instruction manual.

Documentation is also available at [www.omron-healthcare.com](http://www.omron-healthcare.com).

<b>Manufacturer</b>	<b>OMRON HEALTHCARE CO., LTD.</b> 24, Yamanouchi Yamanoshita-cho, Ukyo-ku, Kyoto, 615-0084, Japan			
<b>EU-representative</b>	<b>OMRON HEALTHCARE EUROPE B.V.</b> Kruisweg 577, 2132 NA Hoofddorp, The Netherlands <a href="http://www.omron-healthcare.com">www.omron-healthcare.com</a>	<table border="1" data-bbox="1094 233 1277 311"> <tr> <td data-bbox="1094 233 1185 311">EC</td> <td data-bbox="1185 233 1277 311">REP</td> </tr> </table>	EC	REP
EC	REP			
<b>Subsidiary</b>	<b>OMRON HEALTHCARE UK LTD.</b> Opal Drive Fox Milne, Milton Keynes MK15 0DG, United Kingdom			
	<b>OMRON Medizintechnik Handelsgesellschaft mbH</b> John-Deere-Str. 81a, 68163 Mannheim, Germany <a href="http://www.omron-medizintechnik.de">www.omron-medizintechnik.de</a>			
	<b>OMRON SANTÉ FRANCE SAS</b> 14, rue de Lisbonne, 93561 Rosny-sous-Bois Cedex, France			

Made in China

# Understanding the Results

BF500

## Body Composition Monitor

Making the Best Use of Your BF500

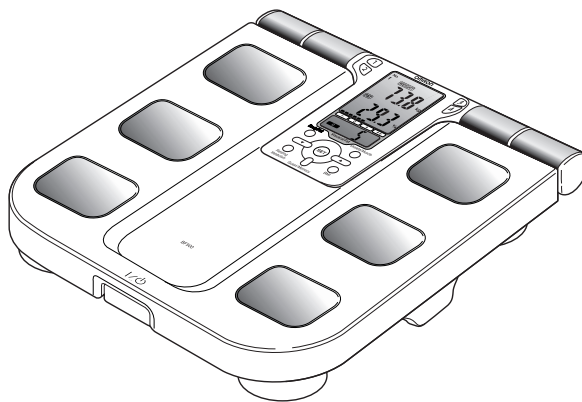

### Contents

Weight & BMI .....	40
Body Fat Ratio & Visceral Fat Level .....	42
Resting Metabolism & Skeletal Muscle .....	44

EN

**Note:** The body fat percentage measured by this unit may significantly differ from the actual body fat percentage in the following situations:

- Elderly people
- People with a fever
- Body builders or highly trained athletes
- Patients undergoing dialysis
- Patients with osteoporosis who have very low bone density
- Pregnant women
- Post-menopausal women
- People with swelling



# BMI & IDEAL WEIGHT

Everybody is concerned about their weight. But what is the basis for determining your ideal weight?

The key is BMI.

### What is BMI?

BMI is short for Body Mass Index. This index uses the following simple formula to indicate the ratio between weight and height of a person.

$$\text{BMI} = \text{weight (kg)} / \text{height (m)} / \text{height (m)}$$

The OMRON BF500 uses the Height information stored in your personal profile number to calculate your BMI classification.

### Let's look at an example

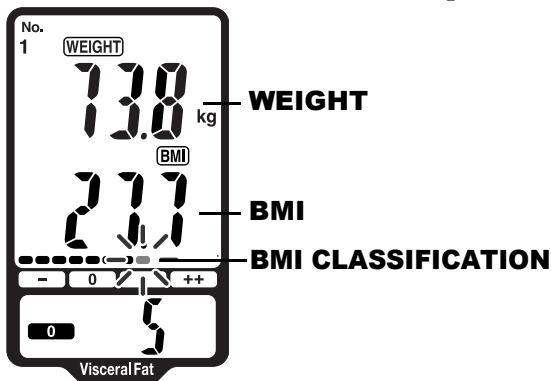

Example of display:

- Weight: 73.8 kg
- BMI: 27.7
- BMI Classification: +



### Hidden Fat Not Revealed by BMI

Although BMI calculates a simple obesity level, there is also hidden fat levels that is not revealed by a BMI designation.

The examples below show two cases that were revealed by OMRON's research.

Although both cases are for people of almost the same height and weight, and their BMI designation is normal, the body fat percentage (p. 42) for case B is high.

That is, although case B has normal body weight, the actual fat level is high, revealing the "hidden fat". This hidden fat indicates high levels of visceral fat (p. 43) 71664040-3C, even though the BMI designation is normal.

#### Examples of hidden fat

CaseA		CaseB	
F	Gender	F	F
34	Age	34	34
172.1cm	Height	171.1cm	171.1cm
65.3kg	Weight	63.9kg	63.9kg
22.0 (Normal)	BMI	21.8 (Normal)	21.8 (Normal)
19.2% <b>Normal</b>	Body fat percentage	35.2% <b>High</b>	35.2% <b>High</b>

#### Interpreting the BMI Result

BMI	BMI (Designation by the WHO)	BMI Classification Bar				BMI Rating
		-	0	+	++	
Less than 18.5	- (Underweight)	■				7.0 - 10.7 10.8 - 14.5 14.6 - 18.4
18.5 or more and less than 25	0 (Normal)	■■■				18.5 - 20.5 20.6 - 22.7 22.8 - 24.9
25 or more and less than 30	+ (Overweight)	■■■■■				25.0 - 26.5 26.6 - 28.2 28.3 - 29.9
30 or more	++ (Obese)	■■■■■■■	■■■■■■■	■■■■■■■	■■■■■■■	30.0 - 34.9 35.0 - 39.9 40.0 - 90.0

The above-mentioned indices refer to the values for obesity judgment proposed by the WHO, the World Health Organization.



## BODY FAT RATIO & VISCERAL FAT LEVEL

# BODY FAT ANALYSIS

Body fat is classified as subcutaneous fat and visceral fat etc., depending on where it is located in the body. In particular, visceral fat level is known to have a close connection to susceptibility common diseases.

### What is Body Fat Percentage?

Body fat percentage refers to the amount of body fat mass in regards to the total body weight expressed as a percentage.

The BF500 uses BI(Bioelectrical Impedance) to calculate your body fat percentage using the following simple formula.

$$\text{Body fat percentage (\%)} = \{\text{Body fat mass (kg)} / \text{Body weight (kg)}\} \times 100$$

The BF500 uses body fat percentage to measure your body fat percentage using the above simple formula.

### Let's look at an example



Example of display:

- Body Fat Percentage: 29.3%
- Body Fat Percentage Classification: 0

### Body fat percentage classification differs for men and women

When most people think of body fat, they have a negative image of it. However, it serves a vital role in storing energy, protecting internal organs, etc. While too much body fat is unhealthy for you, having too little is also unhealthy.

The distribution of body fat in men and women is different, so the basis of classifying the body fat percentage for male and female is different.

### Interpreting the Body Fat Percentage Result

Gender	Age	- (Low)	0 (Normal)	+ (High)	++ (Very High)
Female	20-39	< 21.0	21.0 - 32.9	33.0 - 38.9	≥ 39.0
	40-59	< 23.0	23.0 - 33.9	34.0 - 39.9	≥ 40.0
	60-79	< 24.0	24.0 - 35.9	36.0 - 41.9	≥ 42.0
Male	20-39	< 8.0	8.0 - 19.9	20.0 - 24.9	≥ 25.0
	40-59	< 11.0	11.0 - 21.9	22.0 - 27.9	≥ 28.0
	60-79	< 13.0	13.0 - 24.9	25.0 - 29.9	≥ 30.0

Based on NIH/WHO guidelines for BMI

Based on Gallagher et al., American Journal of Clinical Nutrition, Vol. 72, Sept. 2000

## Let's look at an example

No. 1

(WEIGHT) 73.8 kg

(BMI) 27.7

0 5

Visceral Fat

Example of display:

- Visceral Fat Level: 5
- Visceral Fat Classification: 0

Visceral fat area (0 - Approx. 300 cm<sup>2</sup>, 1 inch=2.54 cm) distribution 30 levels.  
 Example level determined  
 0: 1 - 9 level  
 +: 10 - 30 level  
 \* The data referenced by Omron Healthcare.

Visceral fat area (0 - Approx. 300 cm<sup>2</sup>, 1 inch=2.54 cm) distribution 30 levels.

Example level determined

0: 1 - 9 level

+: 10 - 30 level

\* The data referenced by Omron Healthcare.

### What is Visceral Fat Level?

#### Visceral fat = fat surrounding internal organs

Too much visceral fat is thought to be closely linked to increased levels of fat in the bloodstream, which can lead to common diseases such as hyperlipidemia and diabetes, which impairs the ability of insulin to transfer energy from the bloodstream and using it in cells. In order to prevent or improve conditions of common diseases, it is important to try and reduce visceral fat levels to an acceptable level. People with high visceral fat levels tend to have large stomachs. However, this is not always the case and high visceral fat levels can lead to hidden fat.

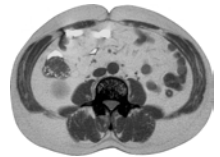

### What is Subcutaneous fat?

#### Subcutaneous fat = fat below the skin

Subcutaneous fat not only accumulates around the stomach but also around the upper arms, hips and thighs, and can cause a distortion of the body's proportions. Although not directly linked to increased risk of disease, it is thought to increase pressure on the heart and other complications. Subcutaneous fat is not displayed in this unit, but is included in the body fat percentage.

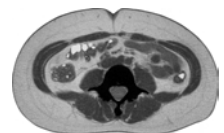

EN



## RESTING METABOLISM & SKELETAL MUSCLE

# INCREASING SKELETAL MUSCLE THROUGH EXERCISE

Skeletal muscle is muscle that is connected to bone and used to move parts of the body. The maintenance and increase of this skeletal muscle is closely linked to resting metabolism. This section describes resting metabolism and skeletal muscle.

### What is Resting Metabolism?

Regardless of your activity level, a minimum level of energy is required to sustain the body's everyday functions. Resting metabolism, the amount of calories needed to supply the body with the minimum level of energy, differs between individuals depending on variables such as age, weight, body composition, and energy expenditure.

#### Let's look at an example

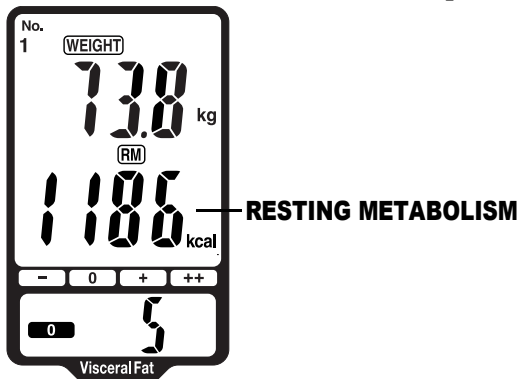

Example of display:

- Resting Metabolism: 1186 kcal

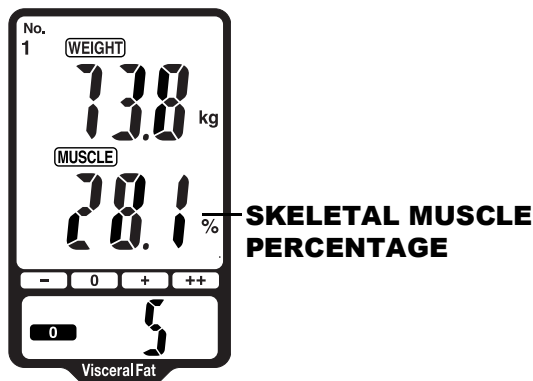

Example of display:

- Skeletal Muscle Percentage: 28.1%

### 60-70% of daily energy use is for resting metabolism

The total amount of energy burned by the body in a typical day is as follows.

Resting metabolism	Energy required to maintain vital functions.
Daily activity metabolism	Energy used for daily activities such as commuting to work, household chores, hobbies etc.
Diet-induced thermogenesis	Energy emitted after eating a meal.

The ratio of these is 60%-70% for resting metabolism, 20%-30% for daily activity, and 10% for diet induced thermogenesis. This means that resting metabolism accounts for most of our daily energy consumption.

If our daily food intake exceed the amount of energy required for these activities, the additional energy is stored as fat.

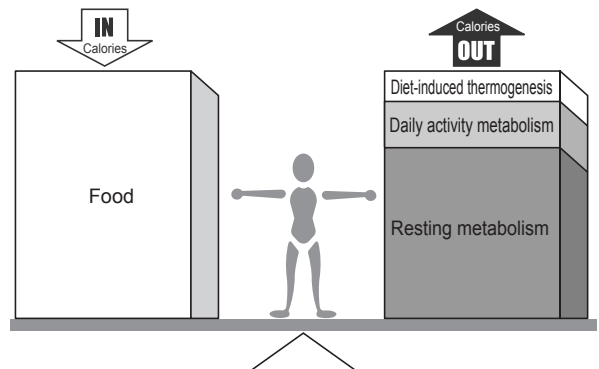

## What is Skeletal Muscle?

Muscle is divided into two types, muscle in internal organs, such as the heart, and muscle attached to bones that is used to move the body. Skeletal muscle can be increased through exercise and other activity.

### ***Resting metabolism reduces as we get older***

Resting metabolism level peaks in the late teenage years and then gradually reduces over the years. This leads to reductions in the body's functions as we get older and in particular, it is one of the main causes for muscle reduction as we get older.

Even when not being used to move parts of the body, muscles burn energy throughout the day to generate heat for the body which is part of the resting metabolism. As the amount of muscle decreases, so does the amount of energy burned. If people continue to eat the same amount of food as when they are younger, then they develop an increasing abdominal circumference.

In order to avoid this, it is important to know your resting metabolism and maintain muscles through exercise.

### ***Skeletal Muscle Percentage (average value for all ages)***

<b>Average Female</b>	Approximately 28%*
<b>Average Male</b>	Approximately 37%*

\* According to Omron Healthcare figures.



# Quick Reference Usage Guide

Use this as a quick reference guide only. If you are using this device for the first time, please carefully read the full instruction manual.

## 1. Insert the batteries. (Refer to Section 2.)

Make sure that their polarity (+/-) is aligned with the polarity (+/-) indicated in the battery compartment.

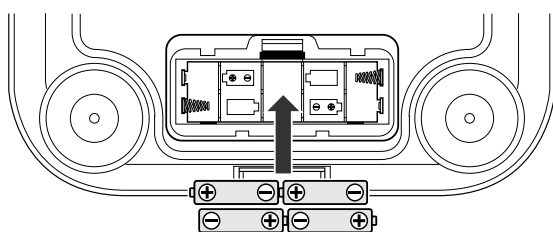

## 2. Set the date and time. (Refer to Section 3.)

## 3. Set a personal profile number. (Refer to Section 4.)

In order to measure body composition, personal data for age, gender, and height, needs to be set.

### **IF USING A PERSONAL PROFILE NUMBER...**

Once you have stored the personal data, you do not need to set the personal data each time you take a measurement. Press the personal profile number button for future measurements.

### **FOR GUEST USERS**

For guest users, set the personal data with each measurement. When using the Guest/Memory button, set the personal data for every measurement.

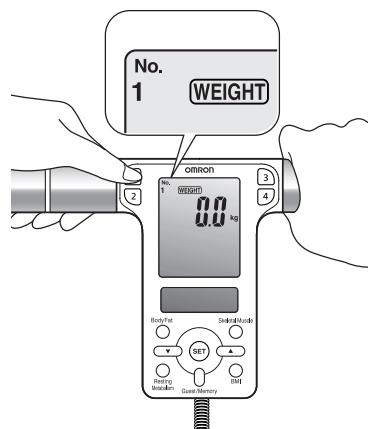

## 4. Measure body composition. (Refer to Section 5.)

## 5. Check the measurement results. (Refer to Section 5.)

To view the measurement results, press the Body Fat, Resting Metabolism, Skeletal Muscle or BMI buttons.

Body Fat



Skeletal Muscle



Resting Metabolism



BMI

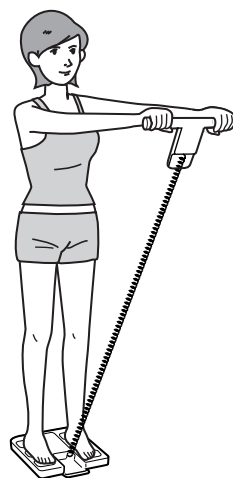
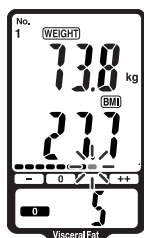
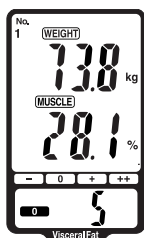
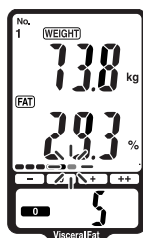

EN

## Free Manuals Download Website

<http://myh66.com>

<http://usermanuals.us>

<http://www.somanuals.com>

<http://www.4manuals.cc>

<http://www.manual-lib.com>

<http://www.404manual.com>

<http://www.luxmanual.com>

<http://aubethermostatmanual.com>

Golf course search by state

<http://golfingnear.com>

Email search by domain

<http://emailbydomain.com>

Auto manuals search

<http://auto.somanuals.com>

TV manuals search

<http://tv.somanuals.com>