

# NT-series Programmable Terminal Operation Manual

Cat. No. V022-E3-1

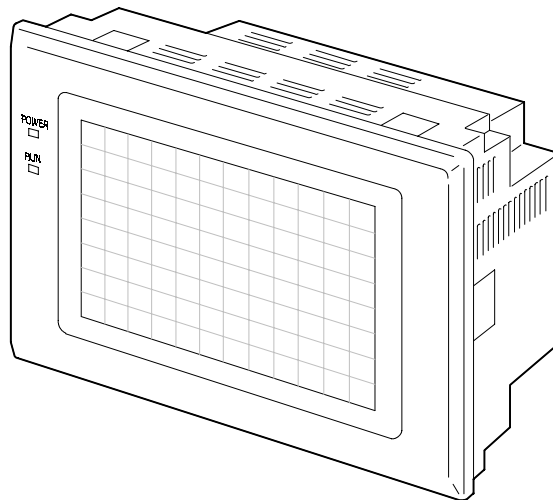



## **OMRON Product References**

All OMRON products are capitalized in this manual. The word "Unit" is also capitalized when it refers to an OMRON product, regardless of whether or not it appears in the proper name of the product.

The abbreviation "Ch," which appears in some displays and on some OMRON products, often means "word" and is abbreviated "Wd" in documentation in this sense.

The abbreviation "PC" means Programmable Controller and is not used as an abbreviation for anything else.

The abbreviation "Host" means a controller such as an FA computer which controls a PT (programmable terminal).

## **Visual Aids**

The following headings appear in the left column of the manual to help you locate different types of information.

- |                   |   |
|-------------------|---|
| <b>Note</b>       | Indicates information of particular interest for efficient and convenient operation of the product. |
| <b>1, 2, 3...</b> | 1. Indicates lists of one sort or another, such as procedures, checklists, etc.                     |

### **• OMRON, 1997**

All rights reserved. No part of this publication may be reproduced, stored in a retrieval system, or transmitted, in any form, or by any means, mechanical, electronic, photocopying, recording, or otherwise, without the prior written permission of OMRON.

No patent liability is assumed with respect to the use of the information contained herein. Moreover, because OMRON is constantly striving to improve its high-quality products, the information contained in this manual is subject to change without notice. Every precaution has been taken in the preparation of this manual. Nevertheless, OMRON assumes no responsibility for errors or omissions. Neither is any liability assumed for damages resulting from the use of the information contained in this publication.



# TABLE OF CONTENTS

<b>PRECAUTIONS</b> .....	<b>xi</b>
1 Intended Audience .....	xii
2 General Precautions .....	xii
3 Safety Precautions .....	xii
<b>SECTION 2</b>	
<b>Functions of the NT600S</b> .....	<b>2</b>
2-1 Role and Operation of NT600S .....	2
2-2 Functions of NT600S .....	4
2-3 System Configuration .....	10
2-4 Direct Connection Function .....	13
2-5 Functions of the Allocated Bits and Words .....	16
2-6 Communications by RS-232C .....	19
2-7 Before Operating .....	20
<b>SECTION 3</b>	
<b>Hardware Settings and Connections</b> .....	<b>23</b>
3-1 Description of Parts and Settings .....	24
3-2 Installation .....	27
3-3 Connecting to the Support Tool .....	30
3-4 Connection to a PC by the Host Link .....	31
3-5 Connection to a PC by the NT Link (1:1) .....	43
3-6 Connection to a PC by the NT Link (1:N) .....	47
3-7 Connecting to the PC with C200H Direct Communication .....	56
3-8 Host Connections by RS-232C .....	63
<b>SECTION 4</b>	
<b>System Menu Operation</b> .....	<b>65</b>
4-1 Operation Flow by the System Menu .....	66
4-2 Starting the NT600S .....	67
4-3 Operation Modes and the System Menu .....	68
4-4 Initializing Memory .....	72
4-5 Registering the Screen Data .....	79
4-6 Setting the Conditions of Communications with the PC/Host by Using the Memory Switches .....	83
4-7 Starting the Operation .....	92
4-8 Various System Settings .....	93
4-9 System Maintenance .....	101
<b>SECTION 5</b>	
<b>NT600S Functions</b> .....	<b>113</b>
5-1 Creating and Transmitting Screen Data .....	114
5-2 Outline of Functions .....	119
5-3 Screen Display .....	124
5-4 Memory Tables .....	128
5-5 Bar Graphs .....	131
5-6 Lamps .....	135

5-7	Touch Switches .....	138
5-8	Numeral Setting .....	143
<b>SECTION 6</b>		
<b>Using Host Link/NT Link/C200H Direct .....</b>		<b>153</b>
6-1	Outline of Host Link / NT Link/C200H Direct Operation .....	154
6-2	Memory Tables and Bar Graph .....	164
6-3	Lamps, Touch Switches, and Numeral Setting .....	180
6-4	NT600S Status Control .....	192
6-5	Notification of the Operating Status to the PC (Determining the NT600S Operating Status) .....	197
<b>SECTION 7</b>		
<b>Using the RS-232C Interface Unit .....</b>		<b>201</b>
7-1	RS-232C Interface Unit Communications .....	202
7-2	Commands Sent by the Host .....	208
7-3	Commands Sent by the NT600S .....	218
7-4	Terminal Commands .....	222
7-5	Key to Programs .....	228
7-6	EXAMPLE PROGRAM .....	229
<b>SECTION 8</b>		
<b>Troubleshooting and Maintenance .....</b>		<b>241</b>
8-1	Hardware Faults .....	242
8-2	Responding to Displayed Error Messages .....	244
8-3	Maintenance of the NT600S .....	247
8-4	Inspection and Cleaning .....	252
<b>APPENDICES .....</b>		<b>255</b>
A.	Specifications .....	255
B.	Dimensions .....	260
C.	Handling the RS-232C/RS-422 Converter Unit .....	262
D.	NT600S Installation Environment .....	264
E.	Method for Making the Cable for Connection to the PC/Host .....	266
F.	Connecting to an RS-232C/RS-422 Converter Unit (1:1) .....	278
G.	Function Restrictions Depending on the Support Tool .....	280
H.	Making the Cable for Connection to the Support Tool .....	281
I.	NT600S Internal Processing .....	283
J.	Model List .....	286
K.	Option List .....	291
L.	PC Memory Map .....	294
M.	Special Characters .....	295
<b>INDEX .....</b>		<b>299</b>

## ***About this Manual:***

This manual describes the installation and operation of the NT600S Programmable Terminals (PTs) and includes the sections described below. Further information is provided in manuals on the Host Interface Units and Support Tool. Refer to the list in *Section 1 Introduction*.

Please read this manual completely and be sure you understand the information provide before attempting to install and operate a Programmable Terminal.

**Section 1** introduces the PTs, describes the terminology used in this manual, and provides examples of system configurations for programming and operation.

**Section 2** provides procedures and specifications required to set up a PT system, including hardware switch settings and installation.

**Section 3** provides steps required for initial PT operation.

**Section 4** describes functions used to create screens and control display attributes on the PT. Included is automatic transfer of data from the host computer via character string and numeral tables.

**Section 5** describes functions used to input data on-screen and transfer it to the host computer via the numeral table.

**Section 6** describes basic data transfer and maintenance functions.

**Section 7** describes transferring screens online to and from the host computer.

**Section 8** provides troubleshooting and basic maintenance methods, including battery replacement.

Appendices of OMRON products used with PTs, PT specifications, and a memory check table are provided at the back of the manual.

# **Manuals:**

The related manuals are indicated below.

The □ symbol at the end of the manual number is the revision history symbol.

## **Operating the Programmable terminal and Communicating with the Host**

- NT600S Programmable Terminal Operation Manual  
V022-E1-□ (this manual)

This operation manual is the manual for the NT600S itself.

The NT600S is a unit which integrates a programmable terminal body and host interface unit. However, note that a C200H interface unit is required for communications using the C200H direct communication function. This operation manual describes the functions and handling of both the programmable terminal body and the host interface function.

## **Creating and Transferring Screen Data**

- NT Series Support Tool Ver.2□ Operation Manual  
V028-E1-□

The screens displayed on the NT600S are created with the support tool and transferred to the NT600S. This manual describes how to create and transfer screen data.



# PRECAUTIONS

This section provides general precautions for using the Programmable Terminal.

**The information contained in this section is important for the safe and reliable application of the Programmable Terminal. You must read this section and understand the information contained before attempting to set up or operate a Programmable Terminal.**

1	Intended Audience .....	xii
2	General Precautions .....	xii
3	Safety Precautions .....	xii

# 1 Intended Audience

This manual is intended for the following personnel, who must also have knowledge of electrical systems (an electrical engineer or the equivalent).

- Personnel in charge of installing FA systems.
- Personnel in charge of designing FA systems.
- Personnel in charge of managing FA systems and facilities.

# 2 General Precautions

The user must operate the product according to the performance specifications described in the operation manuals.

Before using the product under conditions which are not described in the manual or applying the product to nuclear control systems, railroad systems, aviation systems, vehicles, combustion systems, medical equipment, amusement machines, safety equipment, and other systems, machines, and equipment that may have a serious influence on lives and property if used improperly, consult your OMRON representative.

Make sure that the ratings and performance characteristics of the product are sufficient for the systems, machines, and equipment, and be sure to provide the systems, machines, and equipment with double safety mechanisms.

This manual provides information for using the Programmable Terminal. Be sure to read this manual before attempting to use the software and keep this manual close at hand for reference during operation.

 **WARNING** It is extremely important that Programmable Terminals and related devices be used for the specified purpose and under the specified conditions, especially in applications that can directly or indirectly affect human life. You must consult with your OMRON representative before applying Programmable Terminals to the above mentioned applications.

 **WARNING** Do not use input functions such as PT touch switches for applications where danger to human life or serious damage is possible, or for emergency switch applications.

# 3 Safety Precautions

Read these safety precautions carefully and make sure you understand them before using the Programmable Terminal so that you can use it safely and correctly.

**Safety Conventions and their Meanings:** This operation manual uses the following conventions and symbols to indicate cautions, warnings, and dangers in order to ensure safe use of the PT. The cautions, warnings, and dangers shown here contain important information related to safety. The instructions in these cautions, warnings, and dangers must be observed. The conventions used and their meanings are presented below.

 **DANGER!** Indicates information that, if not heeded, is likely to result in loss of life or serious injury.

 **WARNING** Indicates information that, if not heeded, could possibly result in loss of life or serious injury.

 **CAUTION** Indicates information that, if not heeded, could result in relatively serious or minor injury, damage to the product, or faulty operation.

## Safety Precautions (continued)

### WARNING:

- Do not attempt to take the NT600S apart and do not touch any internal parts while the power is being supplied. Doing either of these may result in electrical shock.
- Switch off the power before replacing the backlight, or you could sustain an electric shock.

### Caution:

- Select a proper location referring to Appendix D Installation Environment (page 262).  
Always switch OFF the power before assembling equipment or connecting cables. Otherwise you could sustain an electric shock or equipment could be damaged.
- Fit crimp-style terminals to the power cable. Connecting the wires of the cable to the terminal block directly after merely twisting them together could cause fire and other hazards.
- The combined lengths of each of the I/O connecting cables must not exceed a total of 12 m (or 6 m for C□□H models).
- Do not use input functions such as PT touch switches for applications where danger to human life or serious damage is possible, or for emergency switch applications.
- On unpacking the NT600S, check its external appearance and confirm that there is no damage. Also confirm that there is no abnormal noise on shaking the unit lightly. The product may malfunction if it is damaged.
- If the DIP switch settings have been changed when the NT600S is powered, reset the power to the NT600S. The changes with the DIP switches become effective only after the power supply is reset.
- In order to ensure system safety, be sure to periodically read the PT operating status bit at the host during operation to confirm that the PT is always operating correctly.
- During work at the panel, take care to ensure that no metal scraps enter the unit. Otherwise, the product may malfunction.
- For the connection to the power supply terminal block, twisted wires of 2 mm<sup>2</sup> or greater cross sectional area and M 3.5 size crimp terminals must be used. Use crimp terminals to connect the power supply to the power input terminals. Recommended crimp terminals for M3.5 are given below. Tighten the screws on the terminal block to a torque of 0.8 N-m. Otherwise fire may occur.
- After connecting a communication cable, always secure it with the screws, or the cable may disconnect, causing operation to fail.

## Safety Precautions (continued)

- The cable's tensile load is 30 N. Do not subject it to loads greater than this. Otherwise a discontinuity may occur, causing operation to fail.
- Do not install the NT600S at sites subject to the following conditions, or the product may malfunction:
  - Severe temperature variations
  - Temperatures or humidities outside the ranges stated in the specifications
  - High humidity, condensation
  - Splashing chemical agents
  - Severe oil splashing
  - Corrosive or flammable gases
  - Strong vibrations or shocks
  - Direct exposure to wind and rain (outdoor sites)
  - Strong ultra-violet irradiation
- Take adequate measures to ensure shielding if the NT600S is used at a location subject to any of the following conditions, or the product may malfunction:
  - Static electricity, or noise from other equipment
  - Strong electromagnetic fields
  - Nearby power cables
  - Potential exposure to radioactivity.
- Carry out grounding correctly in order to prevent misoperation due to noise.
- Confirm system safety before turning the power ON/OFF or resetting. Otherwise the system may operate unpredictably.
- Carefully check the operation of all screen data and host programs before using them. If incorrect, the system may operate unpredictably. Otherwise the system may operate unpredictably.
- Turn off the NT600S power supply when connecting or disconnecting connectors.
- Check that the current capacity of the equipment to be supplied is within 150 mA before using the +5V output of pin No.6, or the product may malfunction. The current capacity of +5 V output of NT600S is:
  - +5 V  $\pm$  5%, 150 mA max. with ST211(B)-V□, and
  - +5 V  $\pm$  5%, 100 mA max. with ST121(B)-V□.
- Press touch switches with a force of no greater than 20 N. Applying higher force may cause glass to break, cause injuries, and prevent operation.
- Do not press touch switches carelessly while the backlight is off or while nothing is displayed on the screen, or the system may operate unpredictably. Only press touch switches after confirming system safety.
- In a system where the user program operates according to the PC cycle time, the system operation may not be constant because of cycle time fluctuations. Consider this point when designing the system.

## Safety Precautions (continued)

- Do not disassemble for repairs or modification, or the product may malfunction.
- The disposal of the NT600S (and used backlights) may be regulated by national or local authorities. Dispose of them in accordance with the laws and regulations of the relevant country and local authority.
- Never short the + and – terminals of the battery. Do not recharge, take apart, deform, or discharge it into open flame. Attempting any of these will lead to hazards such as fire, leakage of electrolyte, rupture, etc.
- Depending on how the power is switched ON/OFF, the entire system may stop. Follow the correct procedure when switching the power ON/OFF. Otherwise the system may operate unpredictably.
- Always turn off the power at both the PC and PT before connecting the C200H interface cable. Otherwise the system may operate unpredictably. Switch off the power to the NT600S and PC before disconnecting/connecting the cable.
- Set so that there is no overlap between the PT status control area and PT status notify area. Otherwise the system may operate unpredictably.
- When transferring the data in units of screens, if there are changes in memory table and/or direct connection, transfer such data along with the screen data. Otherwise the system may operate unpredictably.



# SECTION 2

## Functions of the NT600S

NT600S is a new programmable terminal (PT) which incorporates a host interface unit and a RS-232C interface unit in a programmable terminal body. It can be easily installed and used.

This section gives the operation examples and characteristics of the NT600S so that you will understand the applications of the NT600S.

2-1	Role and Operation of NT600S .....	2
2-1-1	Operations of NT600S .....	3
2-2	Functions of NT600S .....	4
2-2-1	Features .....	4
2-2-2	Principal Functions of NT600S .....	6
2-2-3	Comparison between NT600S and NT600M .....	7
2-2-4	Differences Between Existing Models and NT600S-ST121/ST211-EV3 .....	8
2-2-5	Displays .....	9
2-3	System Configuration .....	10
2-4	Direct Connection Function .....	13
2-4-1	What is the NT Link (1:N) .....	14
2-4-2	C200H Direct Communication .....	15
2-5	Functions of the Allocated Bits and Words .....	16
2-6	Communications by RS-232C .....	19
2-7	Before Operating .....	20

## 2-1 Role and Operation of NT600S

NT600S is a programmable terminal used to display and transmit the information in an FA site. The following gives a general description of the role and operation of the NT600S for those who use a programmable terminal (PT) for the first time.

### Production Line Status Monitoring

The NT600S displays real-time information about the system and equipment operating status, etc.

Production Control		1994/1/25
Product	NT20M	NT600M
Today's target	560 units	441 units
Current Production	305 units	275 units
% achieved	54.5 %	63.0 %

### Messages

The NT600S warns of system or equipment failures and prompts the appropriate remedial action.

# Alarm

Assembly line B - Positioning pin

is defective.

### Panel Switch Functions

Setting touch switches on the NT600S allows workers to use the NT600S as an operating panel. Production data input to the NT600S can be transmitted to a PC.

Electroplating Control

---

Transport

↑

←

→

↓

Clamp

UnClamp



## 2-1-1 Operations of NT600S

### Displays Screens

The information to be displayed (screen data) can be created on a computer by using support tools and stored in the NT600S. The screen data can be displayed on the NT600S in response to the instructions from a PC/Host or touch switch operation.

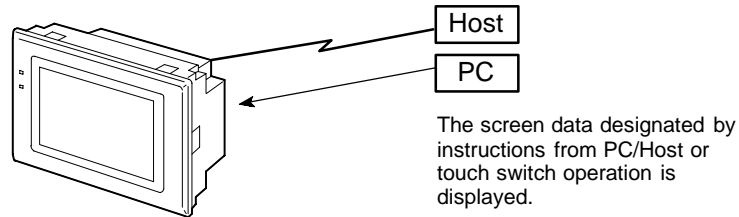

### Receives Data from a PC/ Host

The NT600S can be connected to a PC/Host, and receive necessary data from it, by using the host link function, the NT link function, the C200H direct communication function, or RS-232C.

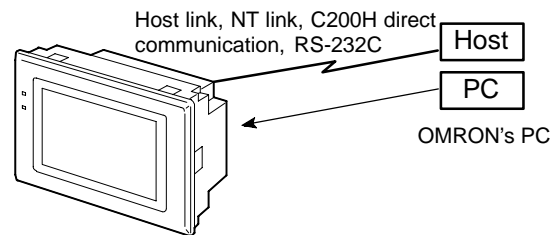

### Sends Data to a PC

Data input through a touch panel can be sent to a PC.

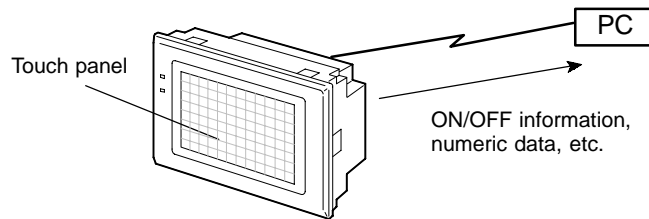

### Screen Data

The screen data to be displayed on the NT600S can be created by a computer by using support tools. Connect the NT600S to a PC/AT with an RS-232C cable so that the screen data are transferred to the NT600S.

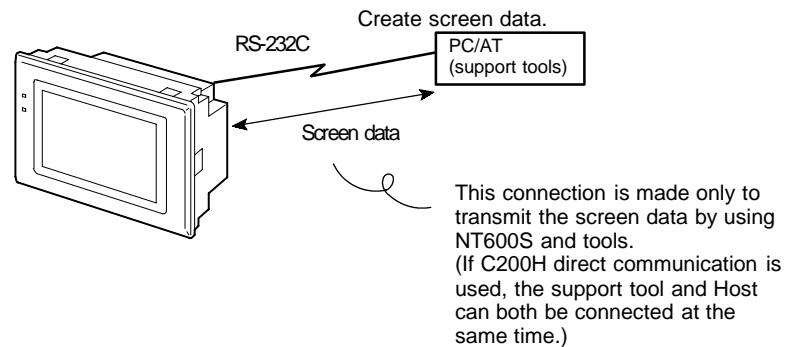

## 2-2 Functions of NT600S

The NT600S has the following features which are different from those of existing NT600M;

### 2-2-1 Features

#### Downsized Body

- The NT600S has thin depth (64 mm or less in the panel) in the NT series.
- The width is shorter by 50 mm, maintaining the existing display area.
- The tool connectors are located at the rear of the unit.
- The communication cable connectors are housed in the unit so that they do not protrude from the unit.
- The tool connectors and the PC/Host communication connectors are used in common.

#### Construction Best Suited to the FA Environment

- Easy-to-read screen even in direct sunlight.
- Two types of panel are available: the STN LCD panel with backlight and the amber EL display panel.
- Its backlight unit and battery can be replaced at the operation site.
- Waterproofed to a standard equivalent to IP65 and NEMA 4.

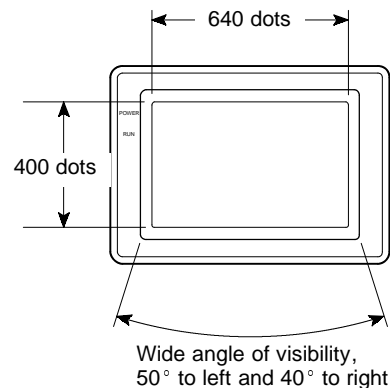

#### 1:1 and 1:N Communications Possible with “NT Link” Method

- Connection in 1:1 and 1:N NT link systems is possible.
- All you have to do is connect to the host; no complicated installation work is necessary.
- A flash memory is used for the screen data memory, making battery backup unnecessary.
- The following communication methods are standard: host link (direct), NT link (1:1, 1:N), and RS-232C.

**Availability of the C200H Direct Communication Function**

The C200H direct communication function can be used if the C200H interface unit (NT-LB122), which must be purchased separately, is mounted to the NT600S.

**Touch Switch Operation**

The System Menu can be displayed by using the touch switches located in four corners of the screen.

**Compatibility with NT600M**

Existing screen data, user programs, and support tools are compatible.

## 2-2-2 Principal Functions of NT600S

### Functions Related to the Data Display

- Character display  
Characters of various sizes can be displayed. Characters can flash or be highlighted.
- Figure display  
Straight lines, circles, and other graphic figures can be displayed.
- Memory data display  
Contents of the character-string memory table and the numeral memory table can be displayed. The memory table contents can be changed from the PC/Host.
- Bar graph display  
Bar graphs corresponding to the contents of the numeral table can be displayed.
- Lamp display  
Lamps which turn on or flash as controlled by the PC/Host can be displayed.

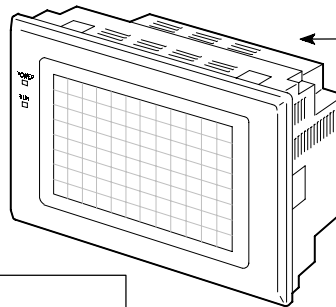

### Functions Related to the Data Input

- Input by the touch switch  
Data can be input by simply touching the screen.
- Numeric setting function  
The touch keys can be assigned with numeric values so that the numeric values can be input at the operation site and sent to the PC.

### Other Functions

- Buzzer  
A built-in buzzer can be used.
- Communications with a PC/Host

The NT600S can be connected to a PC/Host to enable data to be received and touch switch information to be sent by using the host link function, NT link function, C200H direct communication function, or RS-232C.

- System function

The system setting and maintenance can be executed by using the System Menu on the screen.

- Screen data creation

The screen data can be created by using support tools on the computer and stored in the unit.

### 2-2-3 Comparison between NT600S and NT600M

The NT600S is a unitary PT which incorporates a system ROM, screen memory, and a host I/F unit (host link, NT link, and RS-232C) as the standard equipment in one body.

The NT600S has the following features which are different from those of existing NT600M;

Function	NT600S-ST121/-ST211-EV□		NT600M-DT122
Communication	Host link/NT link/NT Link (1:1, 1:N)/RS-232C incorporated. The C200H direct communication function can be used if the separately purchased C200H interface unit (NT-LB122) is mounted on the rear of the NT600S.		Host I/F units are required.
Communication connector	The communication connector (9-pin) for a PC/Host is shared with that for a support tool. When using the C200H direct communication function, there are separate connectors for communications with the support tool and PC/Host.		Both the support tool connector (9-pin) and PC connector (25-pin) are located on the back side.
Host RUN input terminal/ Alarm output terminal	Not provided		Provided
System keys	Not provided		Provided
Contrast control	Back side (ST121)	None (ST211)	Front side
Expanded I/O unit	Expanded not possible		Possible with DN type
Waterproof performance	NEMA4		Conforms to IP52F.
Visibility in direct sunlight	Good (ST121)	None (ST211)	Barely visible
Power supply	24 VDC, more than 15 W (ST121(B))	24 VDC, more than 25 W (ST211(B))	100/200 VAC
Allowable momentary power interruption time	Not guaranteed		5 msec
System ROM	Built in (512 KB, not replaceable)		System ROM compatible with host I/F unit is required.
Resume function	Provided (if optional battery is mounted)		Provided
History retaining function	Provided (if optional battery is mounted)		Provided
Screen transfer	✓		✓
Screen data compatibility	✓ (Note 1)		–
PC ladder compatibility	✓		–
Backlight replacement	✓ (ST121 (B))		×
Screen data memory	Built in (flash memory only)		Optional (select from EP-ROM, SRAM, and EEP-ROM)
Screen data memory capacity	128 KB		256 KB max.
Outside dimensions	275 × 192 × 71mm		325 × 198 × 105mm

**Note**

1. If a system key function is required on continuous screens or for numerical setting or buzzer stop, use a support tool and set the touch switches which have the system key function in such screens.  
For details, refer to “System Key Functions” on page 142.  
128 KB of screen data memory capacity is equivalent to 200 screens consisting mainly of messages, or 70 screens consisting mainly of figures.

## **2-2-4 Differences Between Existing Models and NT600S-ST121/ST211-EV3**

### **Difference between direct connection Ver.4 and Ver.5**

Ver.5 of the direct connection function has the following additional functions in comparison with Ver.4.

- “Thumbwheel” type setting possible with the numeral setting function.
- Upper and lower limit check can be set with the numeral setting function.
- The type of operation (alternate, set, reset) can be selected for touch switch input notification.
- Indirect specification possible for numeral display and character string display functions.

## 2-2-5 Displays

The NT600S can display various kinds of elements such as characters, numeric value, lamps, touch switches, and bar graphs on a screen. The screen data displayed on the NT600S are created by using support tools on a computer.

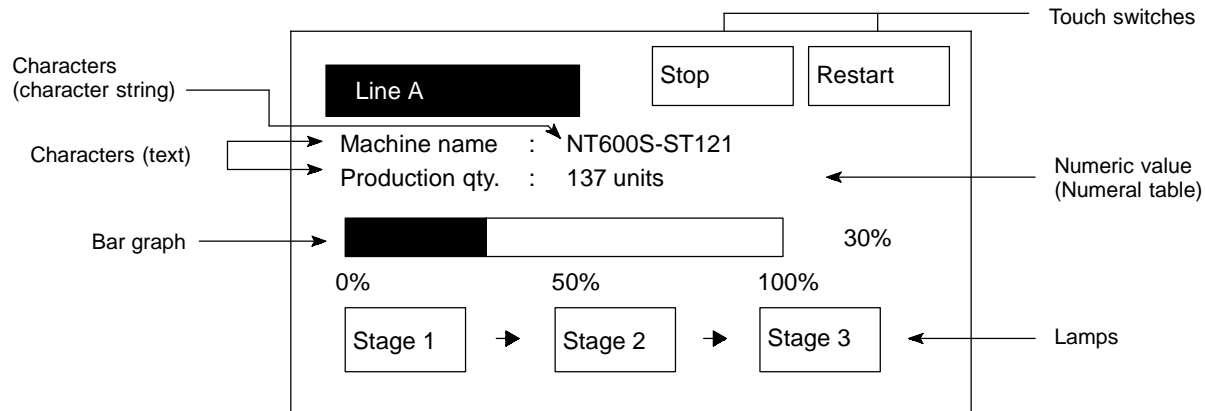

**Characters (text)** Characters and marks which do not need to be changed can be written directly to the screen.

**Characters (character-string memory table)** Character-strings stored in the character-string memory table are displayed. The display characters can be changed by changing the data stored in the character-string memory table.

**Numeric Values (numeral memory tables)** Numbers stored in the numeral memory table are displayed. The display numbers can be changed by changing the data stored in the numeral table. Hexadecimal values can also be displayed.

**Lamps** Lamps indicate the operating status. They are controlled by the PC/Host and can be lit (reversed) or made flash (alternates normal with reversed displays).

**Touch Switches** Touch switches can be set anywhere on the screen. Touching the screen at a touch switch location can switch the display (stand-alone function or display switch function) or notify the PC/Host (notification function). The touch switches can be lit or made flash by controlling from the PC/Host in the same way as the lamps.

**Numeric Keys/Thumb wheel** These are the touch switches used to input numeric values.

**Bar Graphs** The bar graph extends and contracts in proportion to the data stored in the numeral memory table. A percentage value can also be displayed simultaneously.

**Marks** Marks can be designed, created, and handled like characters by the user.

## 2-3 System Configuration

This section gives the basic configuration of a system which uses an NT600S. Refer to the manual for individual device for information on the equipment other than the NT600S in the system.

- Reference**
- The following four communication methods are supported for communications between the NT600S and PC/Host: host link, NT link, RS-232C, and C200H direct. For the setting procedure, refer to Section 4-6 Setting the Conditions of Communications with the PC/Host by Using the Memory Switches (page 83). It is impossible to connect a personal computer used to drive the support tool and a PC/Host at the same time.
  - Typical option devices for the NT600S include the following.
 

Backlight (spare for LCD type)	NT600S-CFL01 (white lamp)
Reflection-suppressing protective sheet	NT600M-KBA04 (5 sheets/pack)
Battery	C500-BAT08
Chemical-resistant cover	NT600S-KBA01 (made of silicone rubber)
C200H I/F Unit	NT-LB122
  - It is also possible to use the NTM support tool Ver.4.2. However, some restrictions apply when the NTM support tool is used. Refer to 4-8-5 Setting the Support Tool Mode (page 99) and Appendix G (page 277).

### When using the Host Link/NT Link (1:1) Function

Use an RS-232C cable for connection to the PC/Host

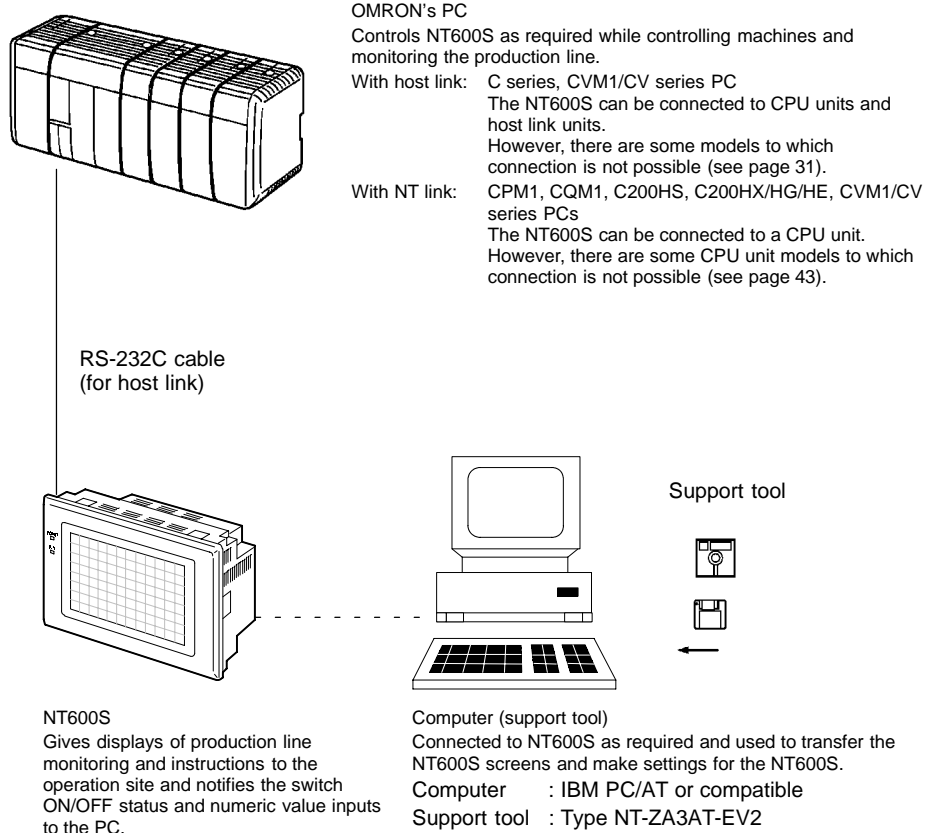



**Reference** Host link and NT link (1:1) communications can be performed with RS-422A by using an RS-232C/RS-422A converter unit (type NT-AL001), but communications with RS-485 are not possible. For details on the wiring for RS-422A, refer to “Appendix F Connecting to an RS-232C/RS-422A Converter Unit” (page 275 of the appendix).

**NT Link (1:N) Systems**

When NT600S is connected to a PC in a 1:N connection, use an RS-232C cable and RS-422A/485 cables.

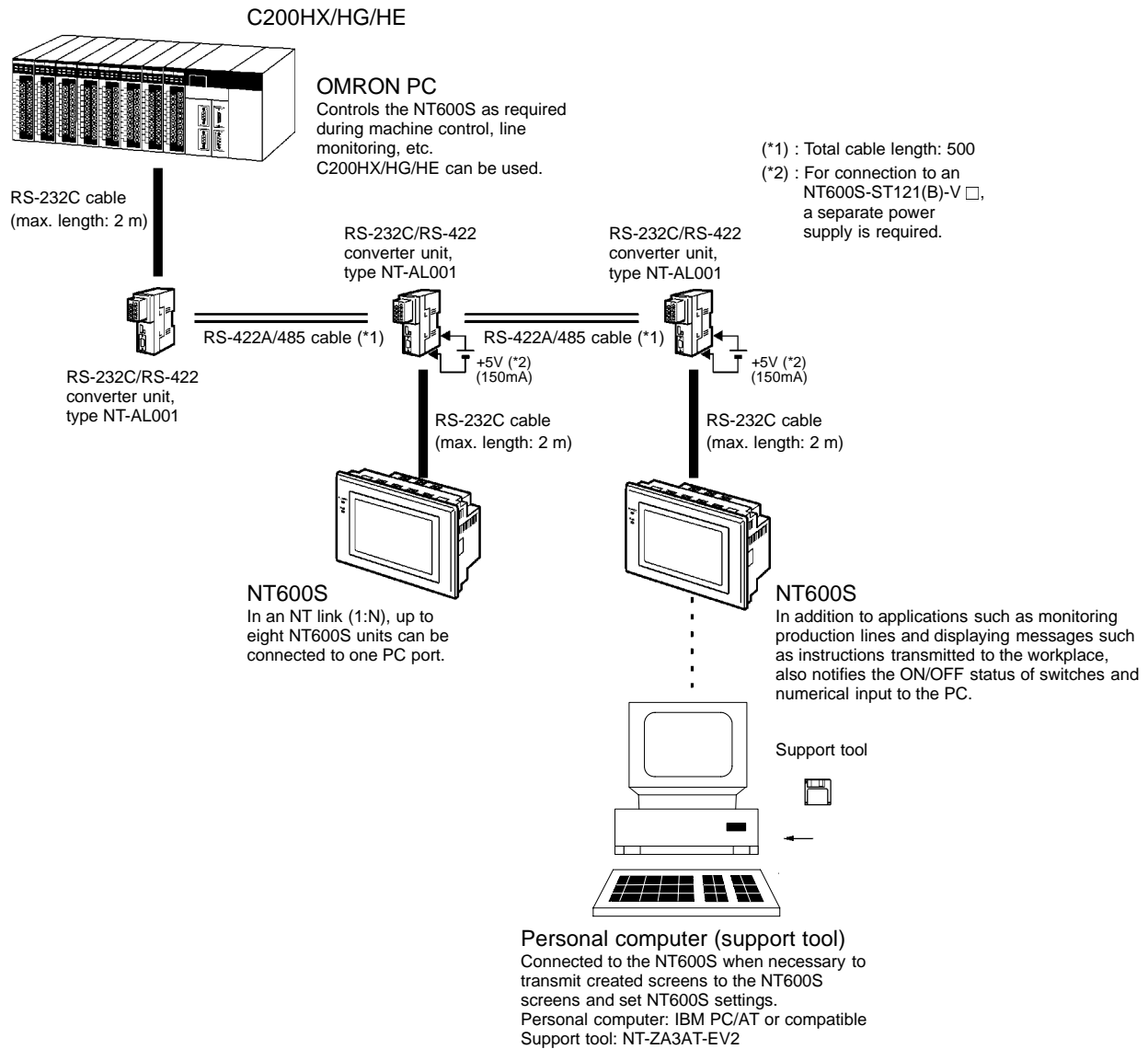

**Reference** When connecting the C200HX/HG/HE and an RS-232C/RS-422 converter unit, use a converter unit whose lot number is 15Y5 or later. Converter units of lot numbers previous to 15Y5 cannot be connected.

When using the C200H Direct Communication Function

Use an I/O connecting cable for the connection to the PC, and an RS-232C cable for connection to the Host.

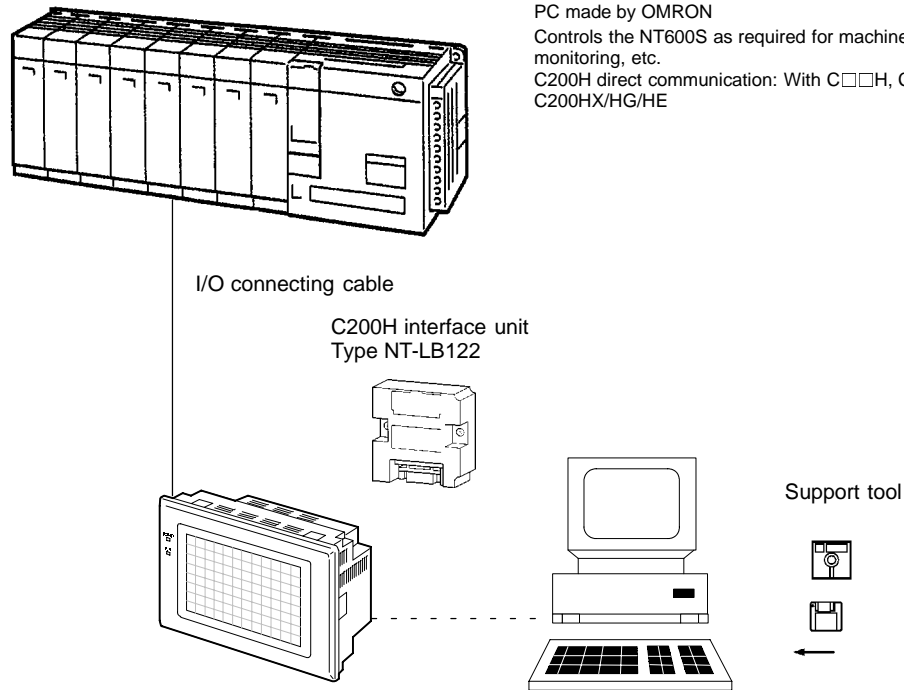

PC made by OMRON  
 Controls the NT600S as required for machine control, line monitoring, etc.  
 C200H direct communication: With C□□H, C200H, C200HS, C200HX/HG/HE

**NT600S**  
 In addition to applications such as monitoring production lines and displaying messages such as instructions transmitted to the workplace, also notifies the ON/OFF status of switches and numeral input to the PC.

**Personal computer (support tool)**  
 Connected to the NT600S when necessary to transmit created screens to the NT600S, and to set NT600S settings.  
 Personal computer : IBM PC/AT or compatible  
 Support tool : Type NT-ZA3AT-EV2

## 2-4 Direct Connection Function

The communication method applied between the NT600S and the PC is either a host link or NT link or C200H or RS232C direct.

The following deals with the "direct access" available when a host link, NT link, or C200H direct is used, and the communication with a PC.

**Reference** For the communication through RS-232C, refer to "2-6 Communications by RS-232C" (page 19)

The NT600S can be used to refer to the contents necessary for the display information or to allocate the bits and words used for storing the input data to any area in the PC. The NT600S can directly write and read such allocated bits and words so as to change the display elements, control the operating status, and notify the status.

This function is called the "direct connection function". The NT600S is designed exclusively for use with the direct connection.

The bits and words allocated by the direct connection function are called "allocated bit" and "allocated word" respectively.

This function allows to read the information to be displayed on the NT600S from the memory area in the PC and to write it to the memory table in the NT600S. Also, the data input on the NT600S can be written to the PC's memory area. The NT600S screen status can be switched according to the PC's memory area, and the NT600S's status data can be written to the PC's memory area.

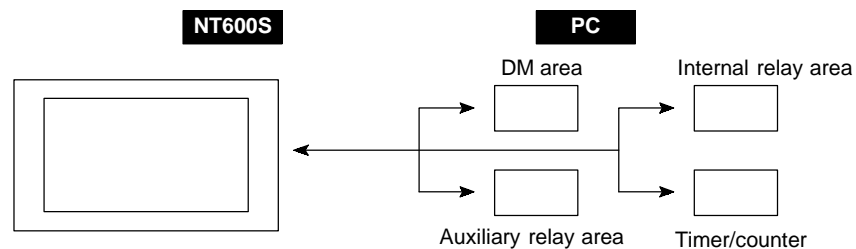

### Features of the Direct Connection Function

- The bits and words referring to operating status and work instruction information and those for storing input data can be freely allocated to almost any part of the PC memory. Bits and words in the PC can be referenced from any memory table.
- The NT600S can directly refer to PC bit and word data so that it can be connected to a PC without changing the PC program which controls currently running production line.
- The area to control and notify the NT600S status, including display screens, ON/OFF of the backlight/EL display screen, and buzzers can be freely allocated to any part of the PC memory.

The direct connection function allows the NT600S to directly read and write almost all bits and words in the PC and to automatically change the NT600S screen display. This function can reduce the load on the PC so that the program development efficiency of the PC improves.

## 2-4-1 What is the NT Link (1:N)

The NT link uses the direct connection function and can execute high-speed communications with the CPU units (with built-in host link) of the CPM1, CQM1, C200HS, C200HX/HG/HE, or CVM1/CV series.

When using the NT600S in an NT link, two communications modes are possible: a single NT600S can be connected to one PC (1:1 NT link), or alternatively, up to eight NT600S units can be connected to a single PC port (1:N NT link).

However, the 1:N connection NT link can be used with C200HX/HG/HE only. In the following sections, the NT link communication mode in general will be indicated by the term "NT link", a 1:1 connection NT link will be indicated by "NT link (1:1)", and a 1:N connection NT link will be indicated by "NT link (1:N)".

### Features of the NT Link

The NT link method has the following features.

- It allows high-speed communications with a specific PC.
- Data can be written to the memory area of the PC in bit units.  
This means that different bits of the same word to which a touch switch is allocated can be used for different applications (for example the allocation of a lamp).  
However, since data is written to the DM area in word units, it is not possible to use the other bits of words to which touch switches have been allocated for other applications in the case of this area.
- Can be used even while the PC is in the run mode. When using a host link, the NT600S switches from the run mode to the monitor mode.
- With NT link (1:N), up to eight NT600S units can be connected to a single PC port and used simultaneously.
- When using C200HX/HG/HE, by installing an expansion communication board in the option slot of the CPU unit, it is possible to connect up to three NT link (1:N) systems (comprising a total of 24 NT600S units). For details on communication boards, refer to the "SYSMAC C200HW-COM01 to C200HW-COM06-E Communication Board OPERATION MANUAL" (W304-E1-□).

Since there is compatibility between the NT link and host link, the host link direct connection data can be used without alteration for the NT600S screen data and PC programs.

<b>Reference</b>	When communication is conducted in a 1:N NT link, RS-232C/RS-422 converter units (NT-AL001) must be used for the connections to the individual PTs.
<b>Note</b>	When an NT600S-ST121(B)-EV□ is connected, a +5 V (150 mA) power supply is required for the converter. Do not draw the power supply from the PT.

## 2-4-2 C200H Direct Communication

C200H direct communication allows communication with C□□H, C200H, and C200HS CPU units by using the “direct connection” function.

### Advantage of C200H Direct Communication

- Since an I/O connecting cable is used for connection to each CPU unit, high-speed communication is possible.
- Data can be written to the PC memory area in bit units, This means that the unused bits of words allocated to touch switches can be used for other applications (for example, lamp allocations.)

The C200H direct communication function is compatible with the host link and NT link functions. This means that NT600S screen data and PC programs handled with the host link and NT link functions can also be used with the C200H direct communication function as they are.

 **Caution** In a system where the user program operates according to the PC cycle time, the system operation may not be constant because of cycle time fluctuations. Consider this point when designing the system.

## 2-5 Functions of the Allocated Bits and Words

Elements displayed on the NT600S and the NT600S status can be allocated to the bits and words of the PC. By changing the contents of the bits and words, the NT600S can be controlled by the PC. It is also possible to send data to the PC by pressing the touch switches on the NT600S.

- Controlling the NT600S by a PC

The following NT600S functions can be controlled by a PC.

Screens	: Display of designated screens, confirmation of screen numbers, etc.
Memory tables	: Writing to a memory table, copying from a memory table to another memory table, etc.
Lamps and touch switches	: Display instructions, confirmation of display status, setting of input prohibition, etc.
System control	: Buzzer ON/OFF, ON/OFF of backlight or EL display, and other NT600S status

- Notifying from the NT600S to a PC

Data in the NT600S is sent to a PC when a touch switch is pressed. The following types of data are sent to a PC.

- NT600S status
- Touch switch status
- Numeric values input by the numeral keys by using the touch switches
- Changes in a memory table after copying between memory tables

### Functions of Display Elements

- Lamps

Allocation destination: Bit

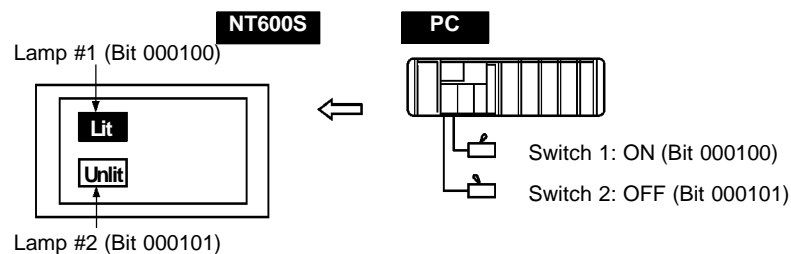

PC's bit status is displayed by the "Lamp" on the NT600S.

The lamp comes on (flashes) when the PC's bit status is ON (1), and goes off when it is OFF (0).

- Touch switches

Allocation destination: Bit

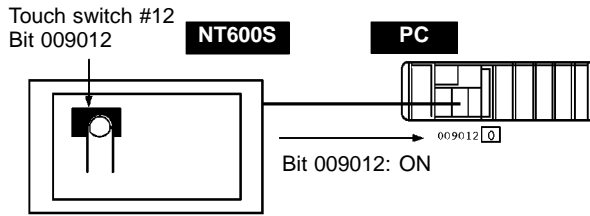

The lamp comes on (flashes) when the PC's control bit is ON (1) and goes off when it is OFF (0). While the touch switch is pressed, the PC's notification bit turns ON (1), and when it is released, the bit turns OFF (0).

- Numeral memory table

Allocation destination: Word

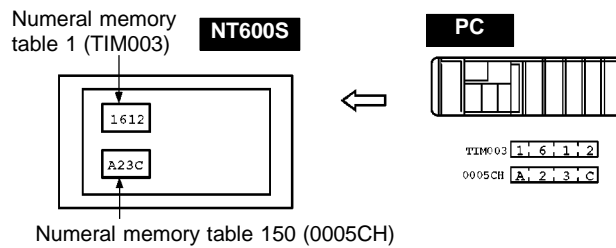

Allocate numeral memory tables to arbitrary words in the PC. If word contents change when corresponding numeral memory table is displayed on the screen, the value on the screen will also change. Monitoring of words can also be made easily.

Reading and writing are executed so that the contents of allocated words are always the same as those of the numeral memory tables.

- Character-string memory table

Allocation destination: Word

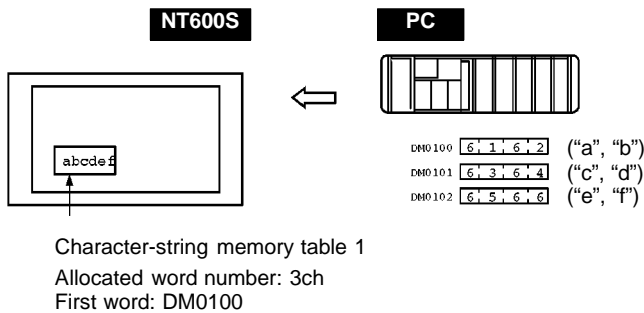

Allocate character-string memory tables to arbitrary words in the PC. If word contents change when corresponding character-string memory table is displayed on the screen, the value on the screen will also change. Messages can be displayed easily.

Reading and writing are executed so that the contents of allocated words are always the same as those of the character-string memory tables.

**Functions of the PT Status Control Area (PC to NT600S)**

The “PT status control area” is used to control the NT600S status. When data is written to this area in the PC, the NT600S reads the contents and operates according to the contents.

**[Example of the PT status control area application]**

When data is written to the PT status control area, the NT600S will operate as given below.

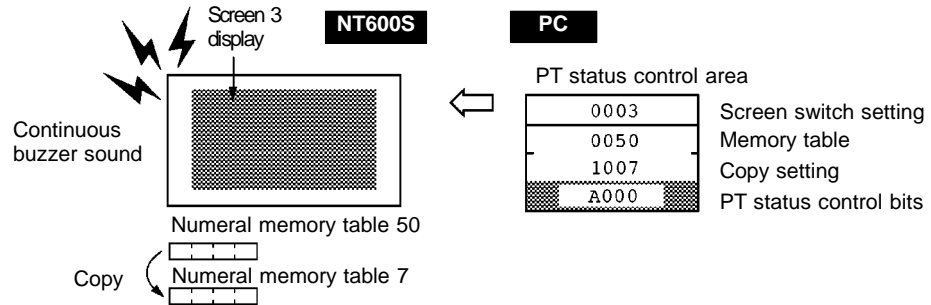

**Functions of the PT Status Notify Area (NT600S to PC)**

The “PT status notify area” is used to notify the changes of the NT600S status. When a change is made in the NT600S status, the change is written to this area in the PC. By reading the data from the area, the NT600S status can be checked.

**[Example of the PT status notify area application]**

When a change is made in the NT600S status, such change will be notified to the PT status notify area as mentioned below.

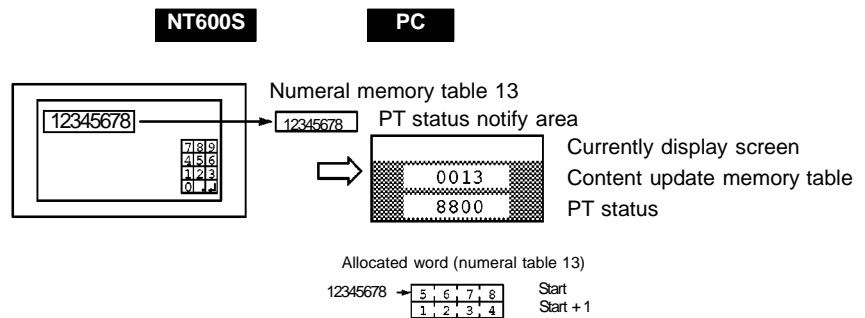



## 2-6 Communications by RS-232C

Control of the NT600S by a Host is executed by two kinds of commands supported by the RS-232C interface which is built into the NT600S.

### Operation commands

Operation commands are used to control the display and status of the running NT600S as well as to notify information.

Screen display, data writing, data inquiries, etc.

Notification of the NT600S operation contents to the Host.

### Terminal commands

Terminal commands are used to use the NT600S as a display terminal of the Host.

When the NT600S is used as a display terminal, it can display characters and figures in accordance with instructions given by the Host, independently of the screens registered to the NT600S.

These commands are also used if unexpected problems occur.

## 2-7 Before Operating

Follow the procedure given below to start the system of the NT600S.

### When using Host Link/NT Link/RS-232C

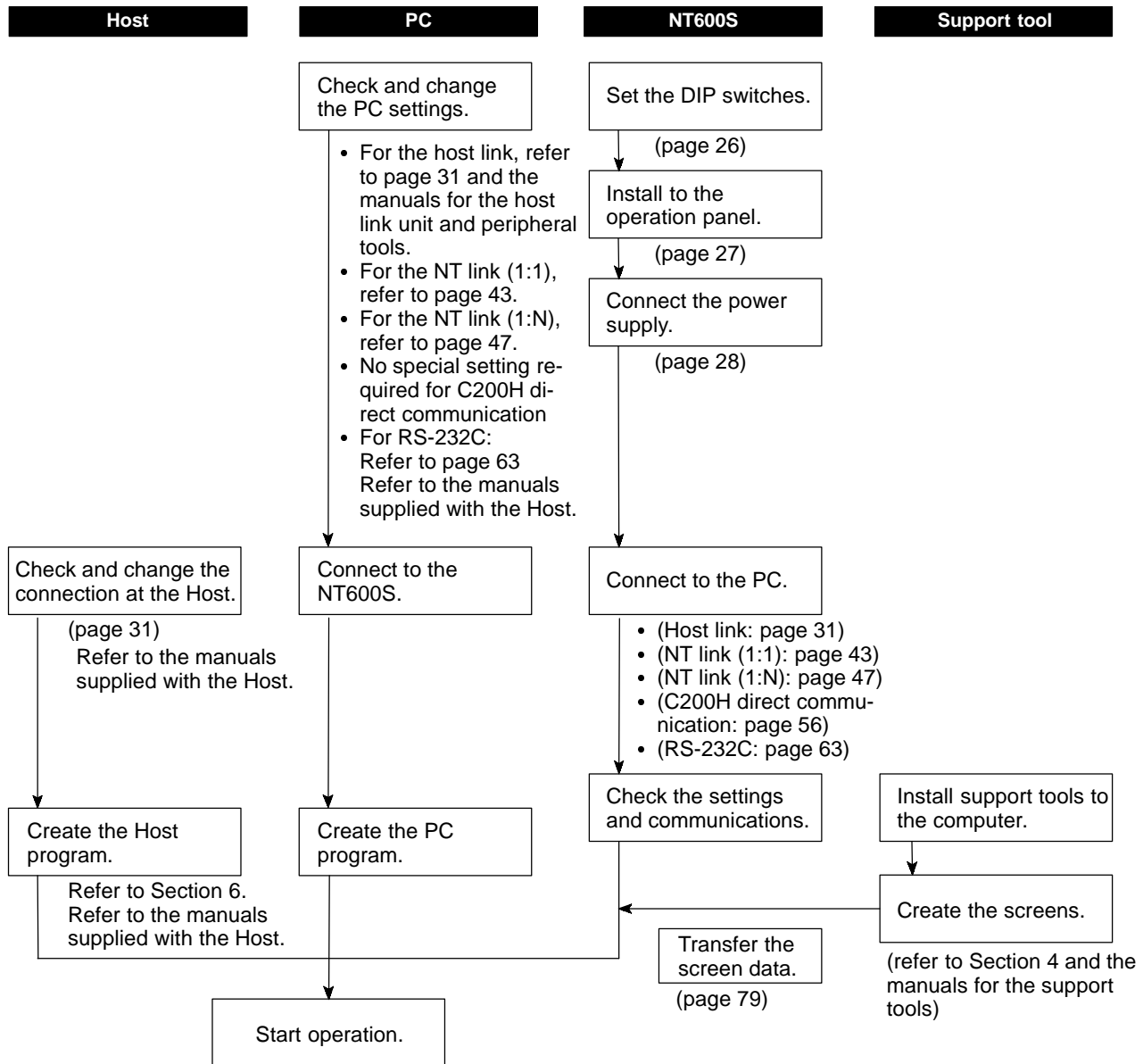

**Note** Before starting actual operation, check the screen data and the program to be run at the Host completely for its operation.

**Reference** For usable support tools, refer to Appendix H Making the Cable for Connection to the Support Tool (page 278)

Refer to the following manuals for the equipment and software.

Equipment or Software	Manual Title	Manual Number
Support tools	NT-series Support Tool Operation Manual	V028-E1-□
PCs	SYSMAC C20H/C28H/C40H/C60H Operation Manual (Programming/RS-232C Interface)	W176-E1-□
	SYSMAC C120/C500 User's Manual (Programming)	W060-E1-□
	SYSMAC C200H Operation Manual	W130-E1-□
	SYSMAC C200HS Installation Guide	W236-E1-□
	SYSMAC C200HS Operation Manual	W235-E1-□
	SYSMAC C200HX/HG/HE Installation Guide	W302-E1-□
	SYSMAC C200HX/HG/HE Operation Manual	W303-E1-□
	SYSMAC C1000H/C2000H Operation Manual	W140-E1-□
	SYSMAC CQM1 Operation Manual	W226-E1-□
	SYSMAC CQM1-CPM1 Programming Manual	W228-E1-□
	SYSMAC CV500/CV1000/CV2000 Operation Manual (Ladder) * For a PC of the CVM1 series, refer to the SYSMAC CV500/CV1000/CV2000 User's Manual.	W202-E1-□
Peripheral tools	SYSMAC C-series and CVM1 PCs SYSMAC Support Software Operation Manual:C-series PCs	W248-E1-□
	SYSMAC C-series and CVM1 PCs SYSMAC Support Software Operation Manual: CVM1 PCs	W249-E1-□
Host link Unit	SYSMAC C Series Host Link Unit System Manual	W143-E1-□
	SYSMAC CVM1/CV Series Host Link Operation Manual	W205-E1-□



# SECTION 3

## Hardware Settings and Connections

This section describes the settings of the NT600S, connections to a PC/Host, and other hardware settings.

3-1	Description of Parts and Settings .....	24
	3-1-1 Description of Parts .....	24
	3-1-2 DIP Switch Settings .....	26
3-2	Installation .....	27
	3-2-1 Installation to the Operation Panel .....	27
	3-2-2 Power Supply Connection .....	28
	3-2-3 Grounding .....	29
3-3	Connecting to the Support Tool .....	30
3-4	Connection to a PC by the Host Link .....	31
	3-4-1 Compatible PCs .....	31
	3-4-2 Connecting the NT600S .....	32
	3-4-3 PC Switch Settings .....	34
3-5	Connection to a PC by the NT Link (1:1) .....	43
	3-5-1 Compatible PCs .....	43
	3-5-2 Connecting the NT600S .....	44
	3-5-3 PC Switch Settings .....	45
3-6	Connection to a PC by the NT Link (1:N) .....	47
	3-6-1 Compatible PCs .....	47
	3-6-2 Connecting the NT600S Units .....	47
	3-6-3 PC Switch Settings .....	55
3-7	Connecting to the PC with C200H Direct Communication .....	56
	3-7-1 Compatible PCs .....	56
	3-7-2 Connection Method .....	59
3-8	Host Connections by RS-232C .....	63
	3-8-1 Host Computer Communication Settings .....	63
	3-8-2 Connector Pin Arrangement .....	63

## 3-1 Description of Parts and Settings

Before getting to the operation, confirm the names and functions of parts. Also set the DIP switches on the NT600S.

**⚠ Caution** On unpacking the NT600S, check its external appearance and confirm that there is no damage. Also confirm that there is no abnormal noise on shaking the unit lightly. The product may malfunction if it is damaged.

### 3-1-1 Description of Parts

#### Front View

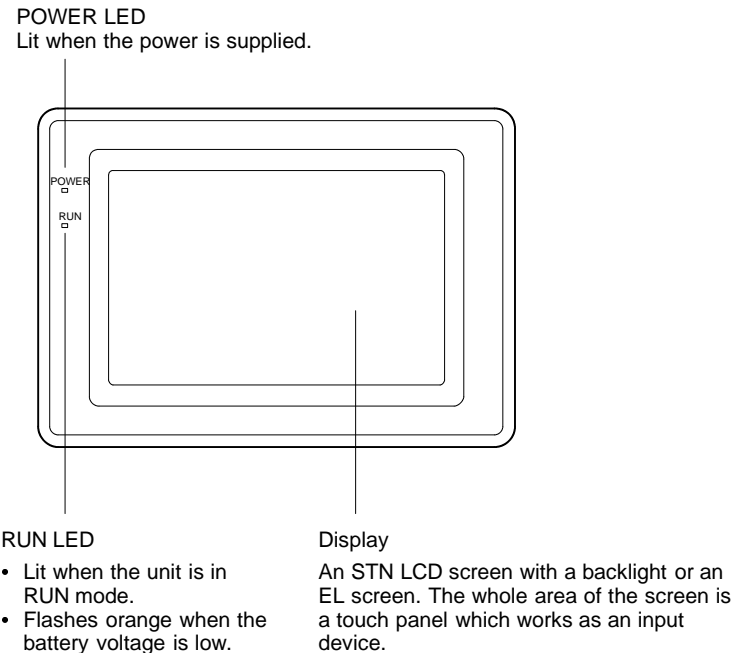

	Battery Normal	Battery Abnormal
RUN mode	Lit in green	Lit in orange
Other modes	Not lit	Lit in red

**Reference** The NT600S comes in two body colors.

- NT600S-ST121/ST211-EV□: beige
- NT600S-ST121B/ST211B-EV□: Black

## Rear View

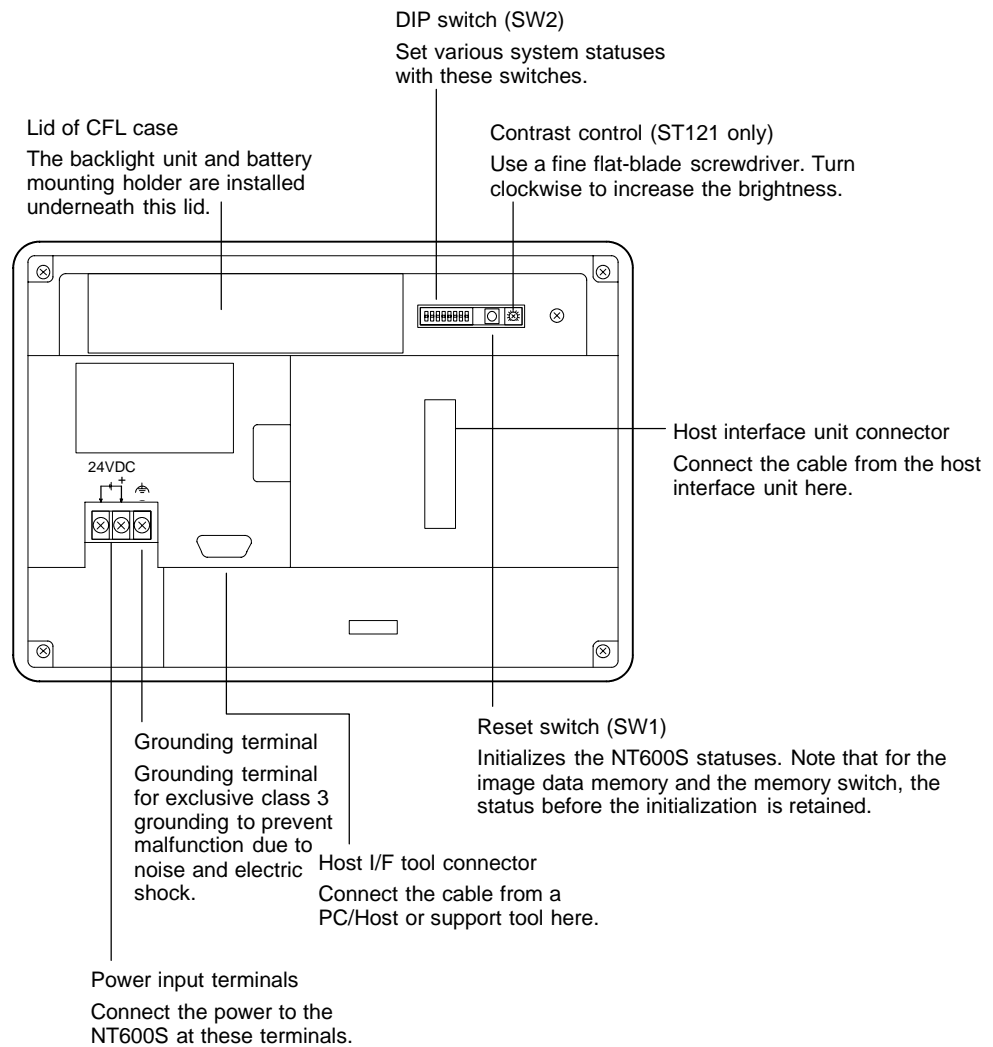

**Reference** Contrast control is available only for the following models:

- NT600S-ST121-EV□
- NT600S-ST121B-EV□

### 3-1-2 DIP Switch Settings

Set the NT600S operation status with the DIP switches located in the bottom right corner on the rear side of the body.

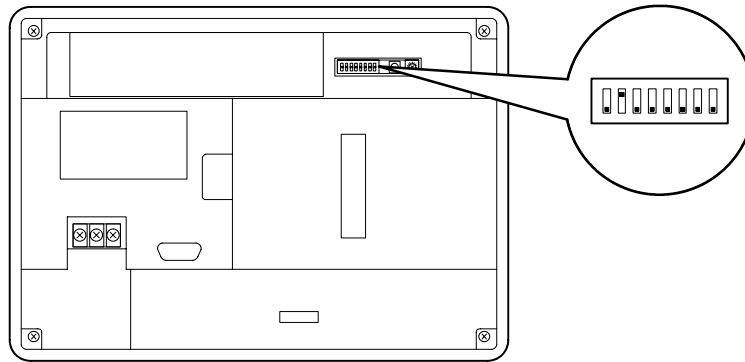

Switch #	Function	
SW2-1	Screen data forced initialize effective/ineffective	
	ON	The NT600S will start in a special RUN mode in which the screen data memory is initialized. When it is started, the memory initialization menu will be displayed. For the initialization procedure, refer to Section 4-4 Initializing Memory (page 72).
	[OFF]	The NT600S will start in normal RUN mode.
SW2-2	Screen display language mode	
	[ON]	Messages are displayed in English.
	OFF	Always set at ON.
SW2-3	Switching to the System Menu enabled/disabled	
	ON	The System Menu cannot be displayed. If an error occurs during a start-up, the System Menu will be automatically displayed. However, "RUN Mode" cannot be entered.
	[OFF]	The System Menu can be displayed.
SW2-4 ~ SW2-7	Not used.	
	ON	
	[OFF]	This switch must be set to the OFF position.
SW2-8	Low battery voltage detection effective/ineffective	
	ON	Low battery voltage is detected.
	[OFF]	Low battery voltage is not detected.

[ ] indicates factory setting.

- Reference**
- In addition to the DIP switches, set also the "Comm. Method", "Host Link Speed", "Automatic Reset", etc. at the memory switches. For these settings, refer to Section 4-6 "Setting the Conditions of Communications with the PC/Host by Using the Memory Switches" (page 83)
  - It may be necessary to change the DIP switch settings after installing the NT600S in an operation panel. Bear this in mind when deciding the installation position.

**Caution** If the DIP switch settings have been changed when the NT600S is powered, reset the power to the NT600S. The changes with the DIP switches become effective only after the power supply is reset.



## 3-2 Installation

Install the NT600S to the operation panel and connect the power to the NT600S as described below.

**⚠ Caution** Select a proper location referring to Appendix D Installation Environment (page 262).

Always switch OFF the power before assembling equipment or connecting cables. Otherwise you could sustain an electric shock or equipment could be damaged.

### 3-2-1 Installation to the Operation Panel

The NT600S can be flush mounted to an operation panel.

Use the panel fittings and tools included in the product package and follow the procedure below.

**⚠ Caution** During work at the panel, take care to ensure that no metal scraps enter the unit. Otherwise, the product may malfunction.

#### Note

- The thickness of applicable operation panel is 1.6 mm to 4.8 mm.
- All fittings must be tightened uniformly to a torque of 0.5 to 0.6 N·m in order to ensure water- and dust- resistance. The panel must not be soiled or warped, and must be able to support an installation that will remain secure and strong.

- (1) Open a hole, shown below, in the panel and install the NT600S from the front side of the panel.

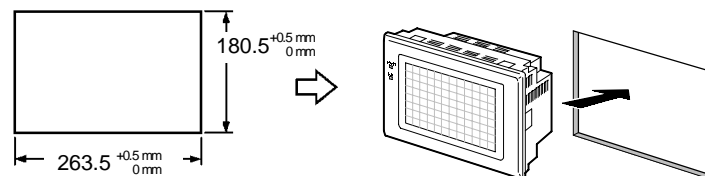

- (2) Attach the panel fittings at four positions for the upper/lower sides and at two positions for the right and left sides, shown below, on the rear side of the NT600S.

Fit the hook of the fitting in the square hole in the body and tighten the screw with a Phillips head screwdriver while lightly pulling the fitting.

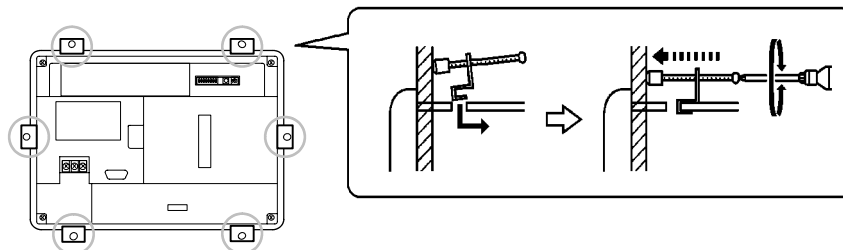

### 3-2-2 Power Supply Connection

Connect a 24 VDC power supply to the power input terminals.

**Note**

Use 2 mm<sup>2</sup> or thicker wires to prevent voltage drop. Twist the wires together for wiring.

- Make sure you connect the power supply wires with the correct polarity.
- Do not connect AC power to the DC terminals.
- If the power supply voltage does not conform to the stipulated rating, it could destroy the terminal or burn internal circuits.
- If complying with EC directives (low voltage directives), observe the following points:
  - ① Use a power supply with reinforced insulation to supply power to the PT.
  - ② If using the EL display type, embed the rear part of the PT in a control panel so that, after the product has been made ready for installation, the user cannot touch any part of it apart from the part where PT operations are performed (the front panel).

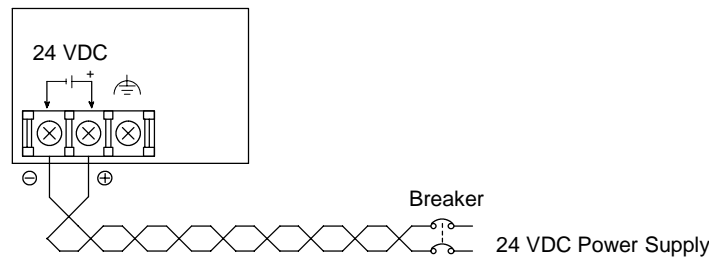

**Reference**

When using an C200H direct communication the NT600S must be started up before the host. For details, refer to “Switching the Power ON/OFF When Using C200H Direct” (page 62). When not using C200H direct communication, there are no restrictions on the order in which power supplies are switched ON and OFF.

- Noise prevention

The NT600S has a noise preventive feature against the power supply line noise. To further reduce noise, connect a noise filter to the power line. This will drastically reduce the ground noise.

- Power supply

In order to comply with EC directives, use a SELV power supply.

Applicable power supply specifications are as follows.

Item	Value	
Power supply voltage	24 VDC	
Allowable power supply voltage fluctuation range	20.4 VDC to 26.4 VDC (24 VDC -15%, +10%)	
Power supply capacity	ST121(B)-EV□ 15W over	ST211(B)-EV□ 25W over

- Parts used for connection

**⚠ Caution** For the connection to the power supply terminal block, twisted wires of 2 mm<sup>2</sup> or greater cross sectional area and M 3.5 size crimp terminals must be used. Use crimp terminals to connect the power supply to the power input terminals. Recommended crimp terminals for M3.5 are given below. Tighten the screws on the terminal block to a torque of 0.8 N·m.

**⚠ Caution** Fit crimp-style terminals to the power cable. Connecting the wires of the cable to the terminal block directly after merely twisting them together could cause fire and other hazards.

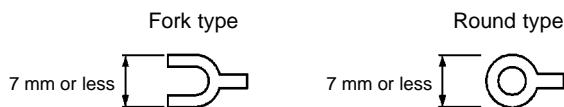

[Recommended terminals]

Maker	Type (fork type)	Type (round type)	Applicable Wire (stranded wire)
Japan Solderless Terminal MFG	2-YS3A	2-3.5	1.04 to 2.63 mm <sup>2</sup>
Fuji Terminal	2-YAS3.5	V2-S3.5	
Nichifu Terminal	2Y-3.5	2-3.5	

### 3-2-3 Grounding

The NT600S has a Grounding terminal .

**Note** To prevent malfunctions due to excessive noise, and to prevent electric shock, carry out class 3 grounding (grounding resistance of 100 Ω or less) using a special-purpose grounding cable (wire of at least 2 mm<sup>2</sup>).

Grounding wire length should be less than 20 m.

Note that if grounding wire is used in common with other equipment, or if it is connected to a beam of a building, for example, the NT600S might be adversely affected by this grounding.

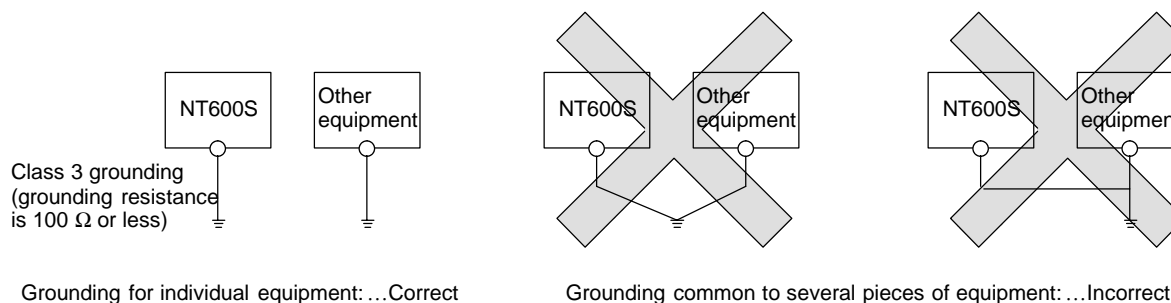

**⚠ Caution** Carry out class 3 grounding (grounding wire must be less than 100Ω) before connecting the power supply. Otherwise there will be a danger of electric shock.

### 3-3 Connecting to the Support Tool

Connect the NT600S to a computer with an RS-232C cable to transfer the screen data created by using a support tool to the NT600S.

In other than C200H direct communications, it is impossible to connect a computer and the Host that are used to run the support tool at the same time. Connect a computer only for transferring the screen data.

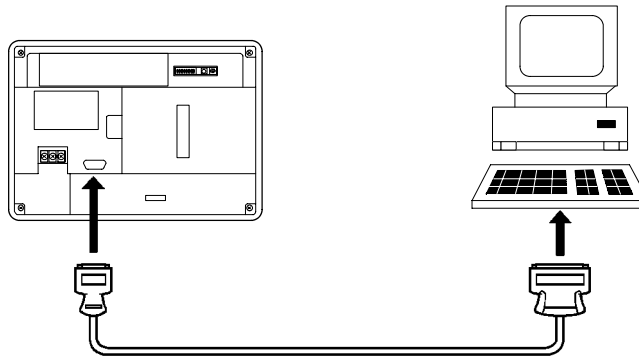

- Communication conditions

Communication conditions are set when a support tool is started.

---

**Reference**

- It is impossible to connect a computer and a PC/Host at the same time to the NT600S. Connect a computer only to transfer the screen data.
  - To make a connector cable, refer to Appendix H Making the Cable for Connection to the Support Tool (page 278).
-

### 3-4 Connection to a PC by the Host Link

Connect the NT600S to an OMRON PC by the host link method.

**Reference** To connect the NT600S to a PC by the host link method, the NT600S memory switch for “Comm. Method” must be set for the host link. For the “Comm. Method” setting, refer to “Selecting the Host Communication Method” (page 85).

#### 3-4-1 Compatible PCs

Some models and series of OMRON PCs have the host link function built in. Check the model and series of the PC against the type of host link unit before making the connections.

The compatible PCs are listed in the table below.

PC Series	Units with Built-in Host Link Function		CPU Units Connectable Using an Expansion Communication Board	Connectable to
	Host Link Unit	CPU Unit		
C series		C20H/C28H/ C40H/C60H		C□□H
	C120-LK201-V1			C120 C200H C500 (F) C1000H C2000 (H)
	C200H-LK201			C200H
	C200H-LK201-V1	C200HS-CPU21-E C200HS-CPU23-E C200HS-CPU31-E C200HS-CPU33-E		C200HS
	C200H-LK201-V1	C200HE-CPU42-E	C200HE-CPU32-E C200HE-CPU42-E	C200HE
	C200H-LK201-V1	C200HG-CPU43-E C200HG-CPU63-E	C200HG-CPU33-E C200HG-CPU43-E C200HG-CPU53-E C200HG-CPU63-E	C200HG
	C200H-LK201-V1	C200HX-CPU44-E C200HX-CPU64-E	C200HX-CPU34-E C200HX-CPU44-E C200HX-CPU54-E C200HX-CPU64-E	C200HX
	C500-LK201-V1 C500-LK203			C500 C1000H
		CQM1-CPU21-E CQM1-CPU41-E CQM1-CPU42-E CQM1-CPU43-E CQM1-CPU44-E		CQM1
		CPM1-10CDR-□ CPM1-20CDR-□ CPM1-30CDR-□		CPM1

PC Series	Units with Built-in Host Link Function		CPU Units Connectable Using an Expansion Communication Board	Connectable to
	Host Link Unit	CPU Unit		
CV series (*)	CV500-LK201	CV500-CPU01-EV1		CV500
	CV500-LK201	CV1000-CPU01-EV1		CV1000
	CV500-LK201	CV2000-CPU01-EV1		CV2000
CVM1 series (*)	CV500-LK201	CVM1-CPU01-EV1 CVM1-CPU11-EV1 CVM1-CPU11-EV2 CVM1-CPU21-EV1		CVM1

\* : Connection is not possible to the CPU units of CVM1/CV series PCs that do not have the suffix “-EV□”. In the case of these CPU units, make the connection to NT600S by using a host link unit.

### 3-4-2 Connecting the NT600S

Refer to the illustrations below to select the appropriate cable for the unit connectors and connect the NT600S to the PC.

To make a connector cable, refer to Appendix E Method for Making the Cable for Connection to the PC/Host (page 264).

- Caution**
- After connecting a communication cable, always secure it with the screws. Otherwise the cable may disconnect, causing operation to fail.
  - The cable’s tensile load is 30 N. Do not subject it to loads greater than this. Otherwise a discontinuity may occur, causing operation to fail.

#### Connecting to a PC with a 25-pin Connector

Use a connector cable with a 25-pin connector on one end and a 9-pin connector on the other end (NT600S side) to connect the NT600S to a PC with a 25-pin connector.

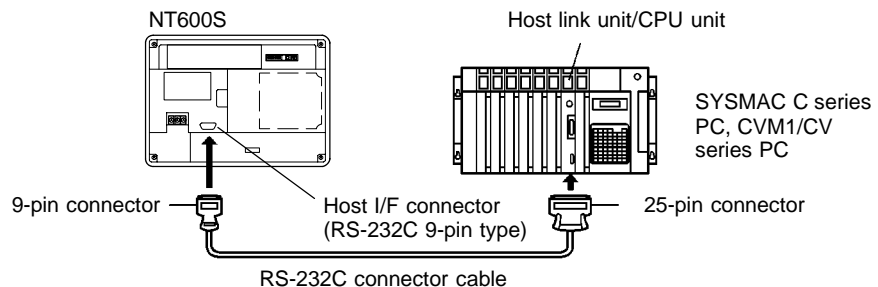

Use the following recommended cables (OMRON);

Connector Specification	Type	Cable Length	Applicable Host Link Unit
25-pin to 9-pin	XW2Z-200S	2m	C500-LK203 C500-LK201-V1 C120-LK201-V1
	XW2Z-500S	5m	C200H-LK201 CV500-LK201

**Connecting to a PC with a 9-pin Connector**

Use a connector cable with a 9-pin connector on both ends to connect the NT600S to a PC with a 9-pin connector.

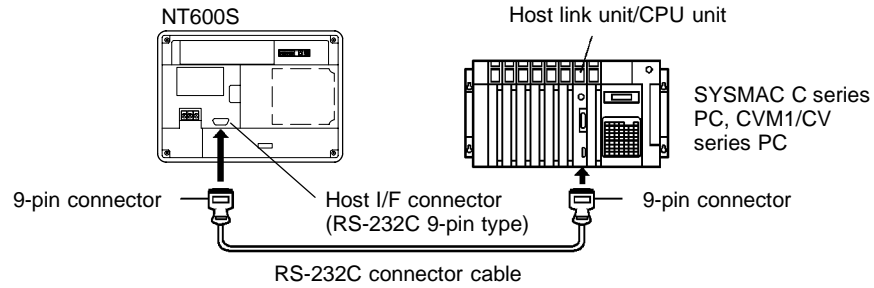

**Note**

The connector cable wiring for the C series CPU unit (C□□H) is different from that for the other PCs. For details, refer to Appendix E Method for Making the Cable for Connection to the PC/Host (page 264).

**Connecting the NT600S to a CVM1/CV Series Host Link Unit**

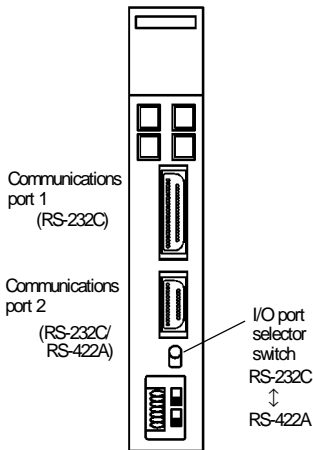

Two types of connectors are provided to CV500-LK201 host link unit. Both of these connector types can connect to the NT600S with an RS-232C connector cable. Select the connector cable which matches the connector type.

- To connect to communication port 1  
This is a 25-pin RS-232C connector. Use a connector cable with a 25-pin connector on one end and a 9-pin connector on the other end (NT600S side).
- To connect to communication port 2  
This is a 9-pin RS-232C/RS-422A connector. Use a connector cable with a 9-pin connector on both ends.  
Set the I/O port selector switch to the RS-232C side (upper side) to use this port.

**Connecting the NT600S to a C Series CQM1 Unit**

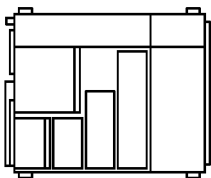

CQM1 can connect to the NT600S by the RS-232C method. Use an RS-232C 9-pin type connector cable.

- To connect to the RS-232C port  
This is a 9-pin RS-232C connector. Use a connector cable with a 9-pin connector on both ends.

**Connecting to C Series C200HX/HG/HE**

When using C series C200HX/HG/HE models, the NT600S can be connected to the standard port of the CPU unit, or to ports A and B of the expansion communication board. Procure an RS-232C type connection cable for the connection. For details on the specifications, installation method, etc., of the communication board used for the connection, refer to the "SYSMAC C200HX/HG/HE Installation Guide" (W302-E1-□).

**Connecting to C Series CPM1**

The CPM1 is connected via an RS-232C adapter (type CPM1-CIF01). Procure an RS-232C 9-pin type connection cable for the connection.

**When a connector cable of 5 m or longer is required**

When a connector cable of 5 m or longer is required, please make the cable. However, note that the maximum transmission distance is 15 m.

To make a connector cable, refer to Appendix E Method for Making the Cable for Connection to the PC/Host (page 264).

**When Long-Distance Transmission is Required**

When transmission over a distance exceeding the RS-232C specification is required, it can be achieved by using an RS-232C/RS-422A converter unit (type NT-AL001) to switch to RS-422A communication (RS-485 communication cannot be used).

For details, refer to "Appendix F Connecting to an RS-232C/RS-422A converter unit" (page 275 of the appendix).

**3-4-3 PC Switch Settings**

When the NT600S and PC are connected to each other, set the conditions at the PC host link unit or the CPU as given in the table below.

The following is a general description of switch settings.

Refer to the manual for respective units for the details of the switch settings.

Item	Switch Setting
I/O port	RS-232C
Baud rate	Set the same baud rate as the NT600S. (*1)
Transfer code	ASCII 7 data bits, 2 stop bits
Parity	Even
1-to-1/1-to-N	1-to-N (*2)
Instruction level	Level 1, 2, 3
Unit #	00

**Note** \*1. Set the host link baud rate at 9600 bps or 19200 bps with the memory switch for "host link baud rate". For the details, refer to "Selecting the Host Link Communication Speed" (page 86).

\*2. The 1-to-N setting enables BCC (Block Check Character). The 1-to-N connection cannot be used to connect the NT600S to a host link unit.

**Reference** When using CVM1/CV series, always set "CPU execution processing (execution control 2)" in the PC system settings to "Simultaneous processing".



**Connecting to a Host Link Unit**

Two types of host link units are available: a rack-mounting type and a CPU-mounted type. The switch settings differ according to the type of host link unit. Set the switches according to the unit type.

- C200H rack-mounting type: C200H-LK201(-V1)

**[Setting the front switches]**

Set each switch with a flat blade screwdriver so that the values or symbols in the setting value window agree with the following.

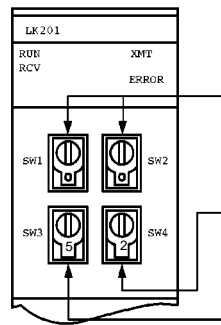

- Unit # (SW1, SW2)  
Set these switches to "0".
- Instruction level, parity, and transfer code (SW4)  
Set this switch to "2".
- Baud rate (SW3)  
Set this switch to "5" to select 9600 bps.  
Set this switch to "6" to select 19200 bps.

**[Setting the rear switches]**

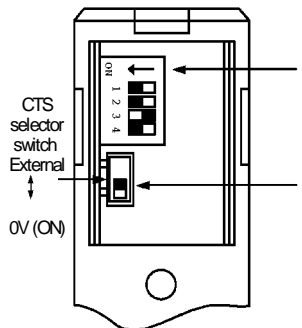

- 1-to-1/1-to-N selection (DIP switch)  
Set #3 to "ON".
- CTS selection (selector switch)  
Set this always to "0V" (ON).

- C500/C1000H rack-mounting type: C500-LK201-V1

**[Setting the front switches]**

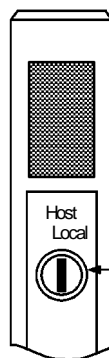

- Mode control (key switch)  
Set this to "host link".

[Setting the rear switches]

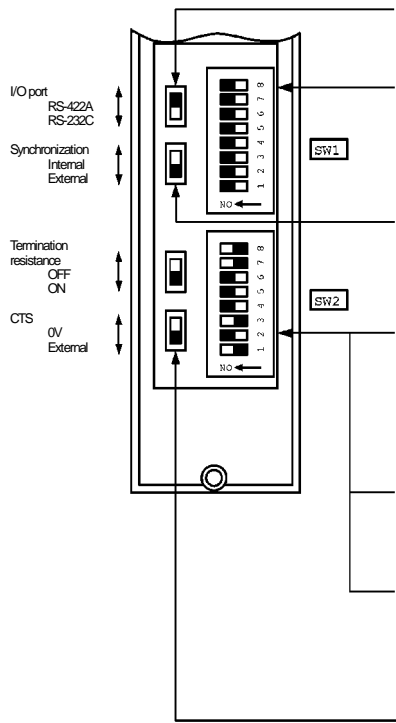

- I/O port selection (selector switch)  
Set this to "RS-232C".
- Unit # (DIP SW1)  
Set SW1-1 to SW1-5 to "OFF" ("0").
- Synchronization (selector switch)  
Set this to "Internal".
- Baud rate (DIP SW2-1 to SW2-4)  
Set these switches to "1010" to select 9600 bps.  
Set these switches to "0010" to select 19200 bps.
- 1-to-1/1-to-N selection (DIP SW2-6)  
Set SW2-6 to "0" (1-to-N).
- Instruction level (DIP SW2-7, SW2-8)  
Set these switches to "1".  
(Levels 1, 2, and 3 are enabled.)
- CTS selection (selector switch)  
Set this always to "0V" (ON).

- C500/C1000H rack-mounting type: C500-LK203

**[Setting the rear switches]**

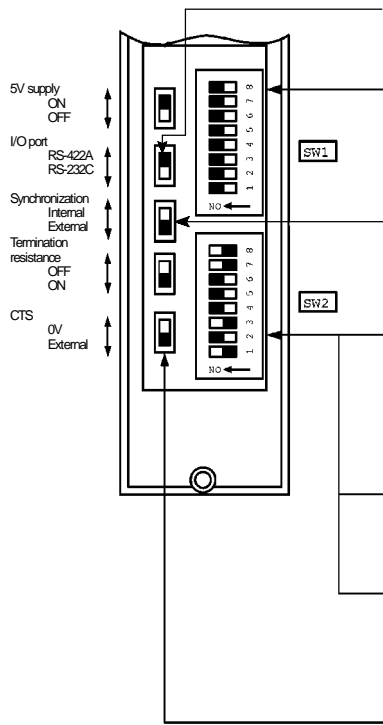

- I/O port selection (selector switch)  
Set this to "RS-232C".
- Unit #, parity, and transfer code (DIP SW1-1 to SW1-7)  
Set SW1-1 to SW1-7 to "OFF" ("0").
- Synchronization (selector switch)  
Set this to "Internal".
- Baud rate (DIP SW2-1 to SW2-4)  
Set these switches to "1010" to select 9600 bps.  
Set these switches to "0010" to select 19200 bps.
- 1-to-1/1-to-N selection (DIP SW2-6)  
Set SW2-6 to "0" (1-to-N).
- Instruction level (DIP SW2-7, SW2-8)  
Set these switches to "1".  
(Levels 1, 2, and 3 are enabled.)
- CTS selection (selector switch)  
Set this always to "0V" (ON).

- CPU-mounted type: C120-LK201-V1

**[Setting the rear switches]**

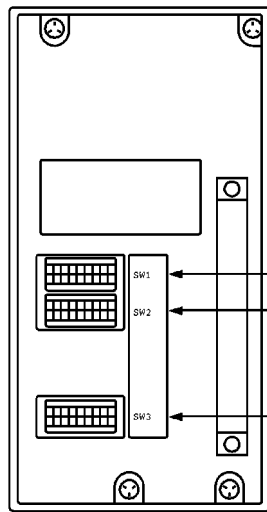

- Unit #, parity, and transfer code (DIP SW1-1 to SW1-5)  
Set SW1-1 to SW1-5 to "OFF" ("0").  
\* Parity is fixed at Even Parity. Transfer code is fixed at ASCII 7 data bits and 2 stop bits.
- Baud rate (DIP SW2-1 to SW2-4)  
Set these switches to "1010" to select 9600 bps.  
Set these switches to "0010" to select 19200 bps.
- 1-to-1/1-to-N selection (DIP SW2-6)  
Set SW2-6 to "0" (1-to-N).
- Instruction level (DIP SW2-7, SW2-8)  
Set these switches to "1".  
(Levels 1, 2, and 3 are enabled.)
- CTS selection (DIP SW3-1 and SW3-2)  
Set SW3-1 to "ON" (1) and SW3-2 to "OFF" (0). (Set this always to "0V".)
- Synchronization (DIP SW3-3 to SW3-6)  
Set SW3-3, SW3-5, and SW3-6 to "ON" (1), and SW3-4 to "OFF" (0). (Set these to "Internal".)

- CVM1/CV series backplate mounted type: CV500-LK201

**[Setting the front switches]**

Set the operating conditions with the PC System Setting functions when a CVM1/CV series host link unit is connected to the NT600S. The PC system settings can be made directly from the peripheral tool (LSS etc.) or the PC system setting information created with a peripheral tool can be transferred to the CPU.

The following describes the switch settings so as to enable the PC system settings. For the details of the PC system settings, refer to the “SYSMAC CVM1/CV Series Support Software Operation Manual (Details)” (W196-E1-□).

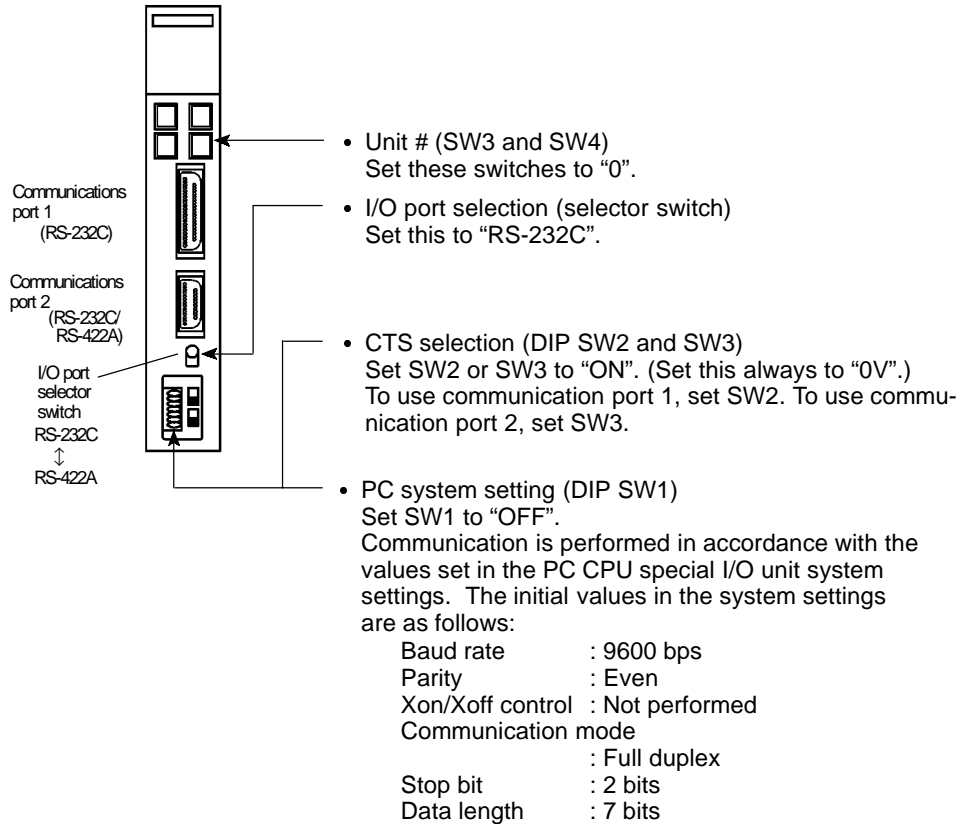

Connecting to a CPU

- C-series C□□H, CVM1/CV-series (-EV□)

**Reference** Only CVM1/CV series CPU units designated “-EV1” or higher can be connected.

Set the operating conditions with the PC System Setting functions when a C□□H, CVM1/CV-series host link unit is connected to the NT600S. The PC system settings can be made directly from the peripheral tool (LSS etc.) or the PC system setting information created with a peripheral tool can be transferred to the CPU.

The following describes the switch settings so as to enable the PC system settings. For the details of the PC system settings, refer to the “SYSMAC C□□H User’s Manual (Programming)” (W176-E1-□) and the “SYSMAC CVM/CV-Series Support Software Operation Manual (Details)” (W196-E1-□).

- (1) C-series C□□H : C20H/C28H/C40H/C60H

No switch settings are required when connecting to a C-series C□□H CPU.

- (2) CVM1/CV-series : CV500-CPU01-EV1  
 CV1000-CPU01-EV1  
 CV2000-CPU01-EV1  
 CVM1-CPU01-EV1  
 CVM1-CPU11-EV1  
 CVM1-CPU11-EV2  
 CVM1-CPU21-EV1

Only CVM1/CV series CPU units designated “-EV1” or higher can be connected.

When connecting to a CVM1/CV-series CPU, set the switches as given below.

**[Setting the front switches]**

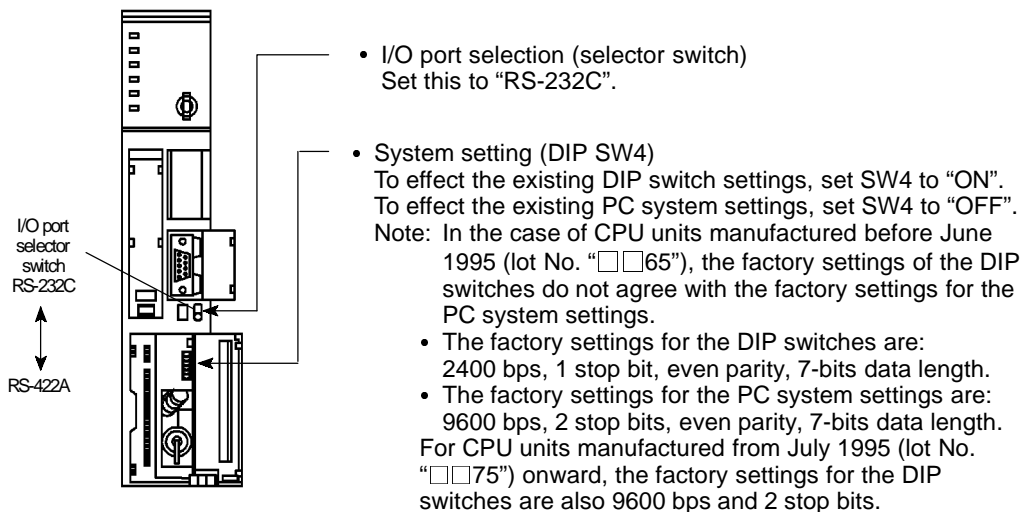

**[Making the PC system settings]**

The possible settings and existing settings which can be set by the PC system setting are as given below.

Item	Possible Setting	Existing Setting
Baud rate	2400/4800/9600/19200 bps	9600 bps
Stop bit	1 or 2 stop bits	2 stop bits
Parity	Even/odd/non-parity	Even parity
Data length	ASCII 7 bits	ASCII 7 bits
Unit #	00 to 31	Unit #00

- C-series C200HS, C200HX/HG/HE, CPM1, CQM1

Set the operating conditions to the PC system setting area when a C200HS or CQM1 CPU is connected to the NT600S. The PC system setting area (data memory) can be directly accessed from the peripheral tool (LSS etc.).

The following describes the switch settings so as to enable the PC system settings. For the details of the operation with the PC system setting area, refer to the "SYSMAC CQM1 Reference Manual" (W228-E1-□).

**[Switch settings] (C200HS, C200HX/HG/HE, CQM1)**

CPU unit DIP switch settings

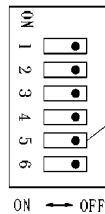

- RS-232C port communication condition settings  
Set DIP switch 5 to OFF (right side) to enable the PC system settings.

**[Switch settings] (CPM1)**

- Set the mode setting switch to the "HOST" (upper) position.

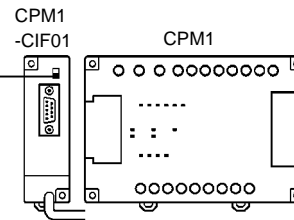

**[PC system setting area settings]**

Write settings to the PC system setting area (data memory) according to the port used to connect to the NT600S.

Channel #	Writing Value	Settings
DM6645	0001	Host link mode and conditions are set.
DM6646	0303	Data length: 7 bits, 2 stop bits, even parity, baud rate: 9600 bps
	0304	Data length: 7 bits, 2 stop bits, even parity, baud rate: 19200 bps
DM6648	0000	Unit No. 0

- When using port A of C200HX/HG/HE

Channel #	Writing Value	Settings
DM6555	0001	Host link mode Set the conditions with the contents of DM.
DM6556	0303	Data length: 7 bits, 2 stop bits, even parity, baud rate: 9600 bps
	0304	Data length: 7 bits, 2 stop bits, even parity, baud rate: 19200 bps
DM6558	0000	Unit No. 0

- When using port B of C200HX/HG/HE

Channel #	Writing Value	Settings
DM6550	0001	Host link mode Set the conditions with the contents of DM.
DM6551	0303	Data length: 7 bits, 2 stop bits, even parity, baud rate: 9600 bps
	0304	Data length: 7 bits, 2 stop bits, even parity, baud rate: 19200 bps
DM6553	0000	Unit No. 0

- When using CPM1

Channel #	Writing Value	Settings
DM6650	0001	Host link mode Set the conditions with the contents of DM.
DM6651	0303	Data length: 7 bits, 2 stop bits, even parity, baud rate: 9600 bps
	0304	Data length: 7 bits, 2 stop bits, even parity, baud rate: 19200 bps
DM6653	0000	Unit No. 0



### 3-5 Connection to a PC by the NT Link (1:1)

Connect the NT600S to an OMRON PC by the NT link method.

**Reference** To connect the NT600S to a PC by the NT link method, the NT600S memory switch for “host communication” must be set for the NT link. For the “host communication” setting, refer to “Selecting of the Host Communication Method” (page 85).

#### 3-5-1 Compatible PCs

With OMRON PCs, the unit that has the built-in NT link function varies depending on the models and series. For C200HX/HG/HE, the CPU unit to be connected in the NT link by adding a communication board is available.

Check the model and series of the PC against the type of host link unit before making the connections.

The compatible PCs are listed in the table below.

PC Series	CPU Unit	CPU Units Connectable Using an Expansion Communication Board	Connectable to
C series	CQM1-CPU41-E CQM1-CPU42-E CQM1-CPU43-E CQM1-CPU44-E		CQM1
	C200HS-CPU21-E C200HS-CPU23-E C200HS-CPU31-E C200HS-CPU33-E		C200HS
	C200HE-CPU42-E	C200HE-CPU32-E C200HE-CPU42-E	C200HE
	C200HG-CPU43-E C200HG-CPU63-E	C200HG-CPU33-E C200HG-CPU43-E C200HG-CPU53-E C200HG-CPU63-E	C200HG
	C200HX-CPU44-E C200HX-CPU64-E	C200HX-CPU34-E C200HX-CPU44-E C200HX-CPU54-E C200HX-CPU64-E	C200HX
CV series	CV500-CPU01-EV1		CV500
	CV1000-CPU01-EV1		CV1000
	CV2000-CPU01-EV1		CV2000
CVM1 series	CVM1-CPU01-EV□ CVM1-CPU11-EV□ CVM1-CPU11-EV□ CVM1-CPU21-EV□		CVM1

### 3-5-2 Connecting the NT600S

Refer to the illustrations below to select the appropriate cable for the unit connectors and connect the NT600S to the PC.

A host link connector cable can also be used. To make a connector cable, refer to Appendix E Method for Making the Cable for Connection to the PC/Host (page 264).

- Caution**
- After connecting a communication cable, always secure it with the screws. Otherwise the cable may disconnect, causing operation to fail.
  - The cable's tensile load is 30 N. Do not subject it to loads greater than this. Otherwise a discontinuity may occur, causing operation to fail.

**Note** Before inserting or removing the connectors, make sure that the NT600S and the PC are turned OFF.

Use a connector cable with a 9-pin connector on both ends to connect the NT600S to a PC with a 9-pin connector.

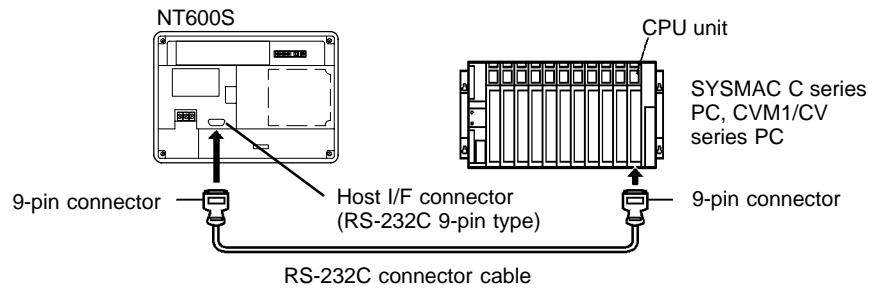

The following are the recommended cables (manufactured by OMRON).

Connector Specification	Model	Cable Length
9pin ↔ 9pin	XW2Z-200T	2 m
	XW2Z-500T	5 m

#### If a Cable Longer Than 5 m is Required

If a cable longer than 5 m is required, a connector cable will have to be made. Refer to Appendix E Method for Making the Cable for Connection to the PC/Host (page 264).

The maximum transmission distance is 15 m.

#### When Long-Distance Transmission is Required

When transmission over a distance exceeding the RS-232C specification is required, it can be achieved by using an RS-232C/RS-422A converter unit (type NT-AL001) to switch to RS-422A communication (RS-485 communication cannot be used).

For details, refer to “Appendix F Connecting to an RS-232C/RS-422 Converter Unit” (page 275 of the appendix).

### 3-5-3 PC Switch Settings

When the NT600S and PC are connected to each other, set the conditions at the PC CPU so as to enable the NT link communications.

The following is a general description of switch settings.

- C-series C200HS, C200HX/HG/HE, CPM1, CQM1

Set the operating conditions to the PC system setting area when a C200HS or CQM1 CPU is connected to the NT600S. The PC system setting area (data memory) can be directly accessed from the peripheral tool (LSS etc.).

The following describes the switch settings so as to enable the PC system settings. For the details of the operation with the PC system setting area, refer to the "SYSMAC CQM1 Reference Manual" (W228-E1-□).

#### [Switch setting] (C200HS, C200HX/HG/HE, CQM1)

CPU unit DIP switch settings

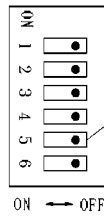

- RS-232C port communication condition settings  
Set DIP switch 5 to OFF (right side) to enable the PC system settings.

#### [PC system setting area settings] (C200HX/HG/HE, CPM1, CQM1)

Write values to the PC system setting area (data memory) in accordance with the CPU unit and port used for connection to the NT600S.

PC Side	Channel #	Writing Value	Settings
RS-232 port of C200HX/HG/HE, CQM1	DM6645	4000	Use NT link (1:1)
Port A of C200HX/HG/HE	DM6555		
Port B of C200HX/HG/HE	DM6550		
CPM1	DM6650		

- CVM1/CV-series (-EV□)

When connecting to a CVM1/CV-series (-EV□) CPU, set the switches as given below.

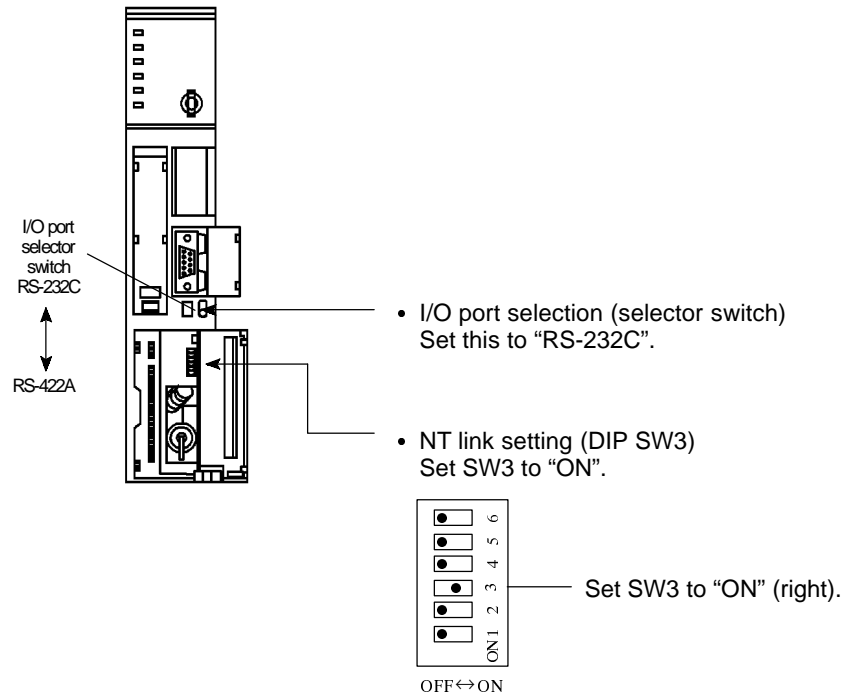

### 3-6 Connection to a PC by the NT Link (1:N)

Connect the NT600S to an OMRON PC by the NT link method.

To connect the NT600S to a PC by the NT link (1:N) method, the communication conditions must be set with the memory switches.

- Setting NT link (1:N)  
(Refer to “Selecting the Host Communication Method” (page 85))
- Setting the unit No. of the connected NT20S  
(Selecting Unit Numbers (page 87))

#### 3-6-1 Compatible PCs

The only OMRON PCs that can be connected in an NT link (1:N) are the C series C200HX/HG/HE models. When making a connection, check the series and model of the PC to which the connection is being made, and the type of host link unit that is installed.

The following is a list of the PCs that can be connected to the NT600S via a host link (1:N).

PC Series	CPU Unit with Built-in NT Link Function	CPU Units Connectable Using an Expansion Communication Board	Connectable to
C series	C200HE-CPU42-E	C200HE-CPU32-E C200HE-CPU42-E	C200HE
	C200HG-CPU43-E C200HG-CPU63-E	C200HG-CPU33-E C200HG-CPU43-E C200HG-CPU53-E C200HG-CPU63-E	C200HG
	C200HX-CPU44-E C200HX-CPU64-E	C200HX-CPU34-E C200HX-CPU44-E C200HX-CPU54-E C200HX-CPU64-E	C200HX

#### 3-6-2 Connecting the NT600S Units

Referring to the illustrations below and using a cable appropriate for the CPU unit’s connector, connect the NT600S units and the PC using RS-232C/RS-422A converter units (type NT-AL001).

An NT link connection cable can be used as the RS-232C cable. For details on making a connection cable, refer to Appendix E “Method for Making the Cable for Connection to the Host” (page 264).

- ⚠ Caution**
- After connecting the communication cable, be sure to lock the connectors with the screws.  
Otherwise the cable may disconnect, causing operation to fail.
  - The cable’s tensile load is 30 N. Do not subject it to loads greater than this.  
Otherwise a discontinuity may occur, causing operation to fail.

Connection Diagram

As shown in the figure below, connect multiple NT600S units to one PC. In an NT link (1:N), up to eight NT600S units can be connected to one PC port.

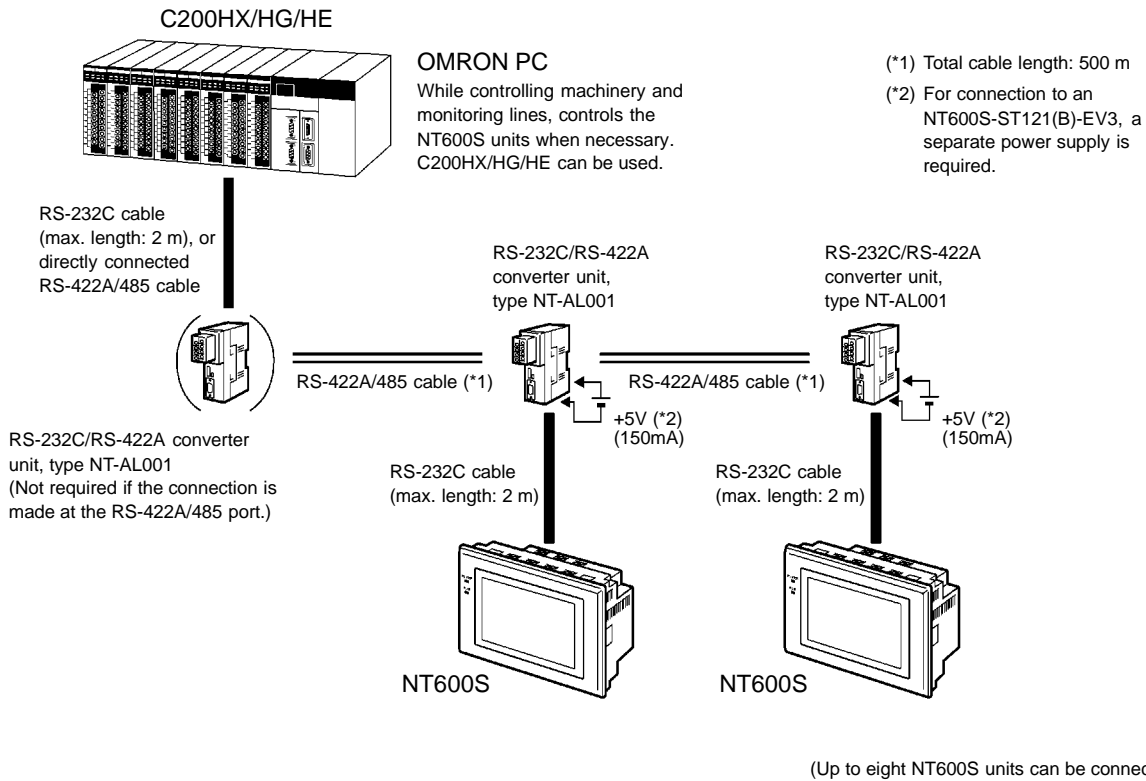

[Maximum Number of NT600Ss Connectable to One Port]

The maximum number of NT600S units that can be connected to the RS-232C port (built in the CPU) and the A and B ports in the communication board is indicated below.

- C200HE :Up to 4 NT600S units per port (unit Nos. 0 to 3)
- C200HG, C200HX :Up to 8 NT600S units per port (unit Nos. 0 to 7)

Reference

- When NT600S-ST121(B)-EV3 is connected in the configuration shown in the figure above, a separate +5 V (150 mA) power supply is required to drive the RS-232C/RS-422 converter units (NT-AL001). When NT600S-ST211(B)-EV3 is connected, the power to the converter unit can be supplied from the PT itself, so no separate power supply is required.
- When connecting the C200HX/HG/HE and an RS-232C/RS-422A converter unit, use a converter unit whose lot number is 15Y5 or later. Converter units of lot numbers previous to 15Y5 cannot be connected.

**Converter Unit Connector Specifications**

The terminal block specifications of the RS-232C/RS-422A converter unit are indicated here. For details on the method for making the connection cable, refer to "Making the Cable" (page 272).

NT-AL001 RS-422A terminal block specifications

- Connected terminal block RS-422A terminal block (M3 screws)
- Electrical characteristics Conform to EIA RS-422A
- Signal direction Signal input and output is relative to the NT-AL001.

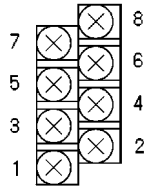

Terminal Block Pin No.	Signal Name	Abbreviation	Signal Direction	
			Input	Output
8	Request to send ( - )	CSA		○
7	Request to send ( + )	CSB		○
6	Receive data ( - )	RDA	○	
5	Receive data ( + )	RDB	○	
4	Send data ( - )	SDA		○
3	Send data ( + )	SDB		○
2	Signal ground	SG (GND)	-	-
1	Functional ground		-	-

\* The CSA and CSB signals are for special applications.

**Converter Unit Terminal Screws and Crimp Terminals**

The terminal screws are M3 screws. Use M3 size crimp terminals. Tighten the terminal screws with a torque of 0.5 N·m.

**Note**

**During wiring, crimp terminals must be used for connections.**

[Recommended crimp terminals]

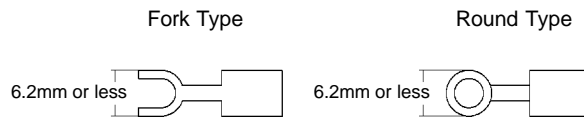

Maker	Type	Recommended Wire Size
Japan Solderless Terminal MFG	1.25-N3A (Fork)	AWG22 to 18 (0.3 to 0.75mm <sup>2</sup> )
Molex	Y1.25-3.5L (Fork)	

Wiring Method

For the connections between the PC and NT600S units, wire as shown below. The wiring method differs depending on the cables used for connection.

- RS-422A connection

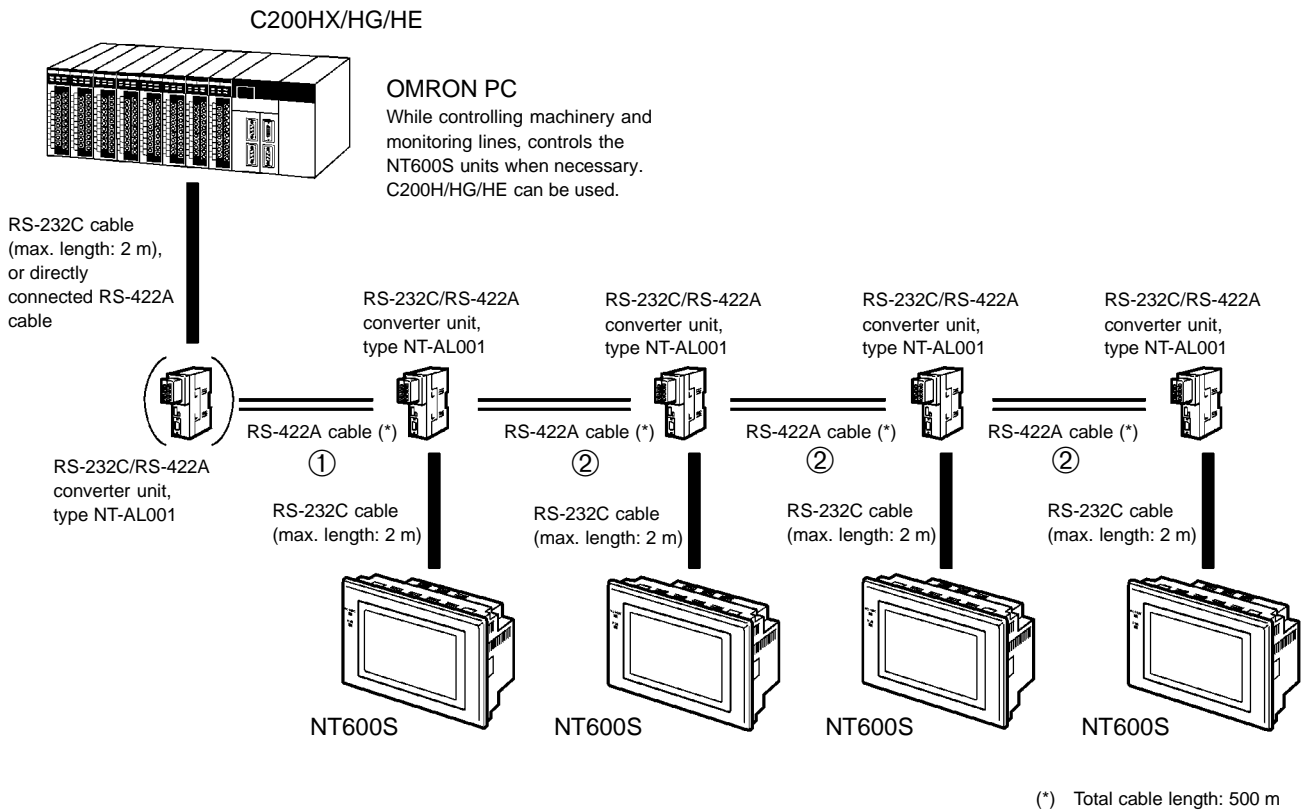

[RS-232C Cable Wiring] (NT600S-ST211(B)-EV□)

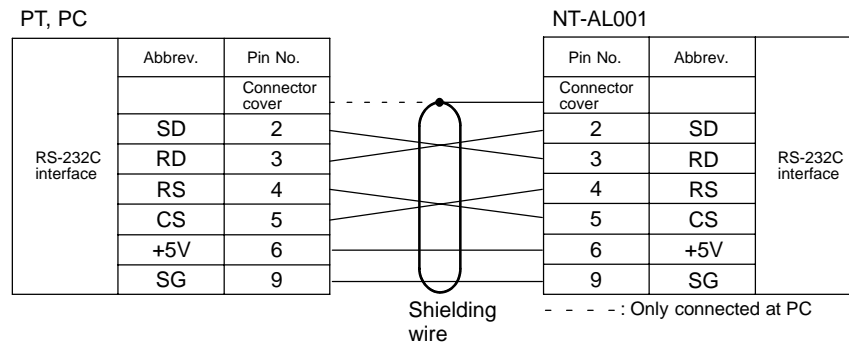

The pin numbers are the numbers at the NT600S. For the pin numbers at the PC, refer to the manual for the PC used.



[RS-232C Cable Wiring] (NT600S-ST121(B)-EV□)

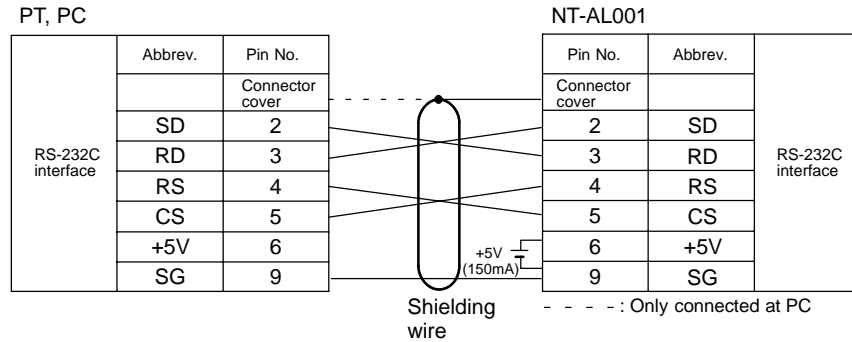

The pin numbers are the numbers at the NT600S.  
For the pin numbers at the PC, refer to the manual for the PC used.

[RS-422A Cable Wiring ( ① )]

- RS-232C connection at the PC side

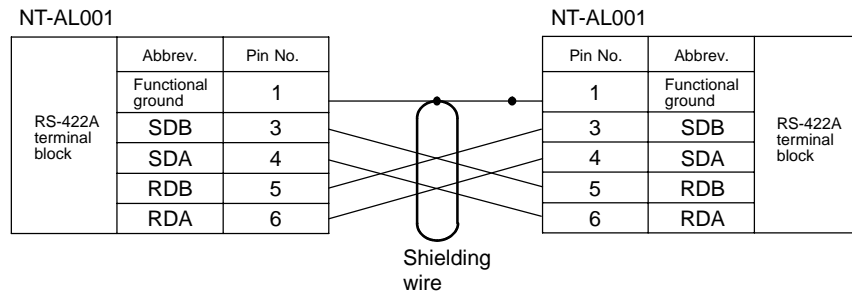

- RS-422A connection at the PC side

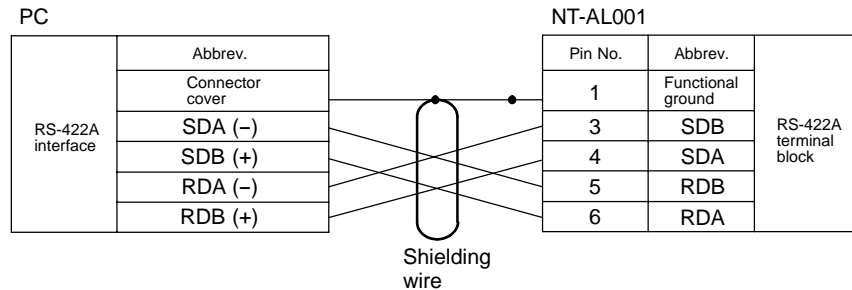

[RS-422A Cable Wiring ( ② )]

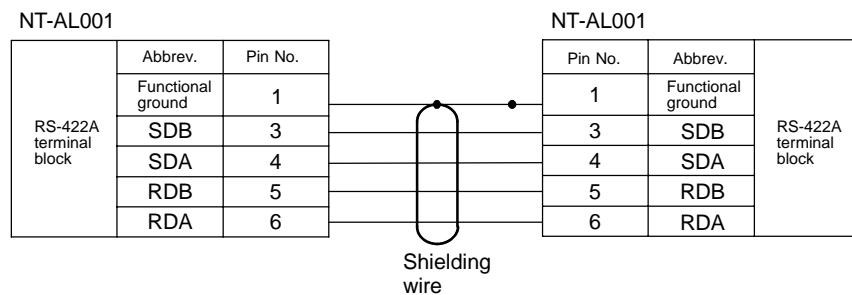

- RS-485 connection

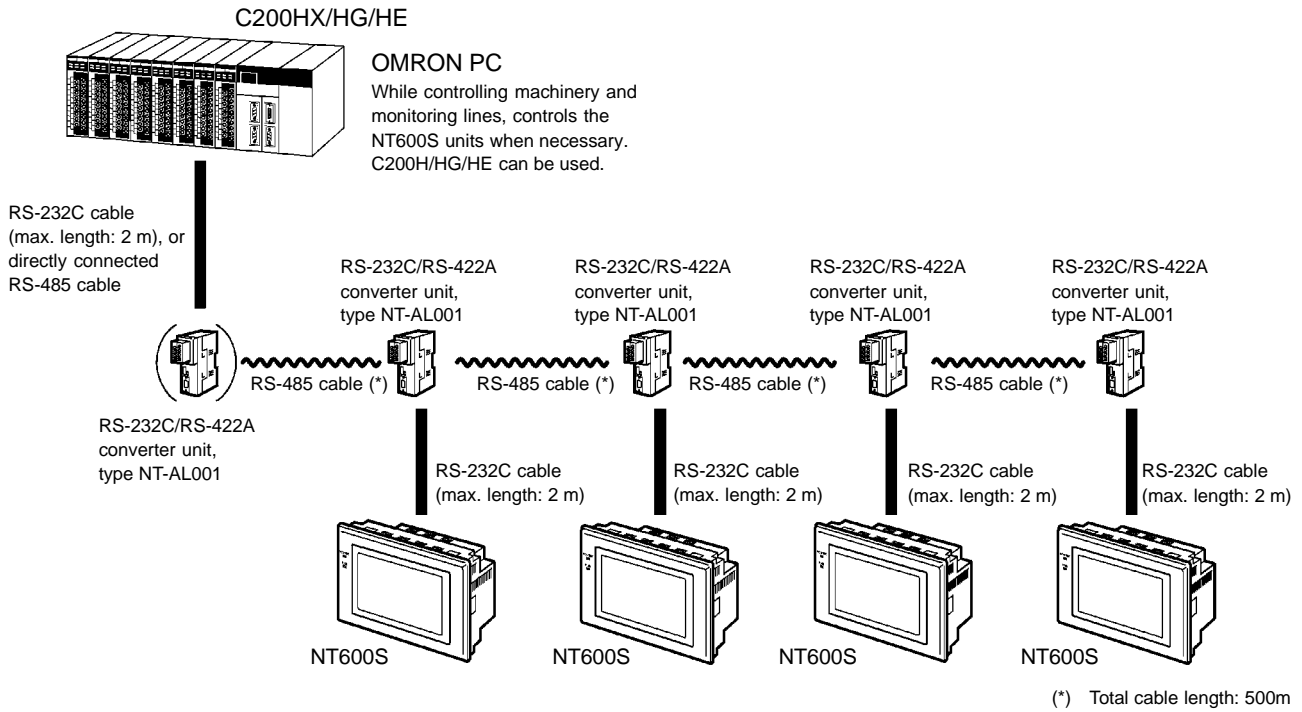

[RS-232C Cable Wiring]

Same as for an RS-422A connection. Refer to “RS-422A connection” (page 50).

[RS-485 Cable Wiring]

- NT-AL001 to NT-AL001

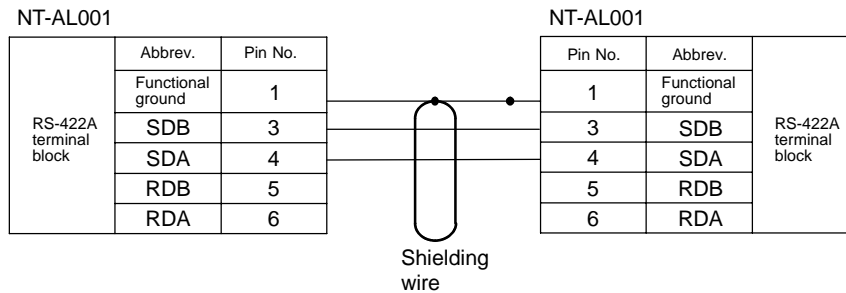

- PC to NT-AL001

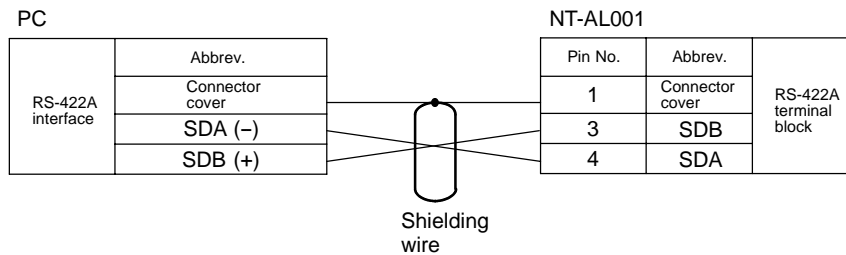

**NT-AL001 Converter Unit DIP Switch Settings**

The DIP switch settings to be made at an NT-AL001 used in the wiring depend on whether it is connected part way along the RS-422A/485 cable or is at the end of the RS-422A/485 cable.

- RS-422A connection, RS-232C at the PC side

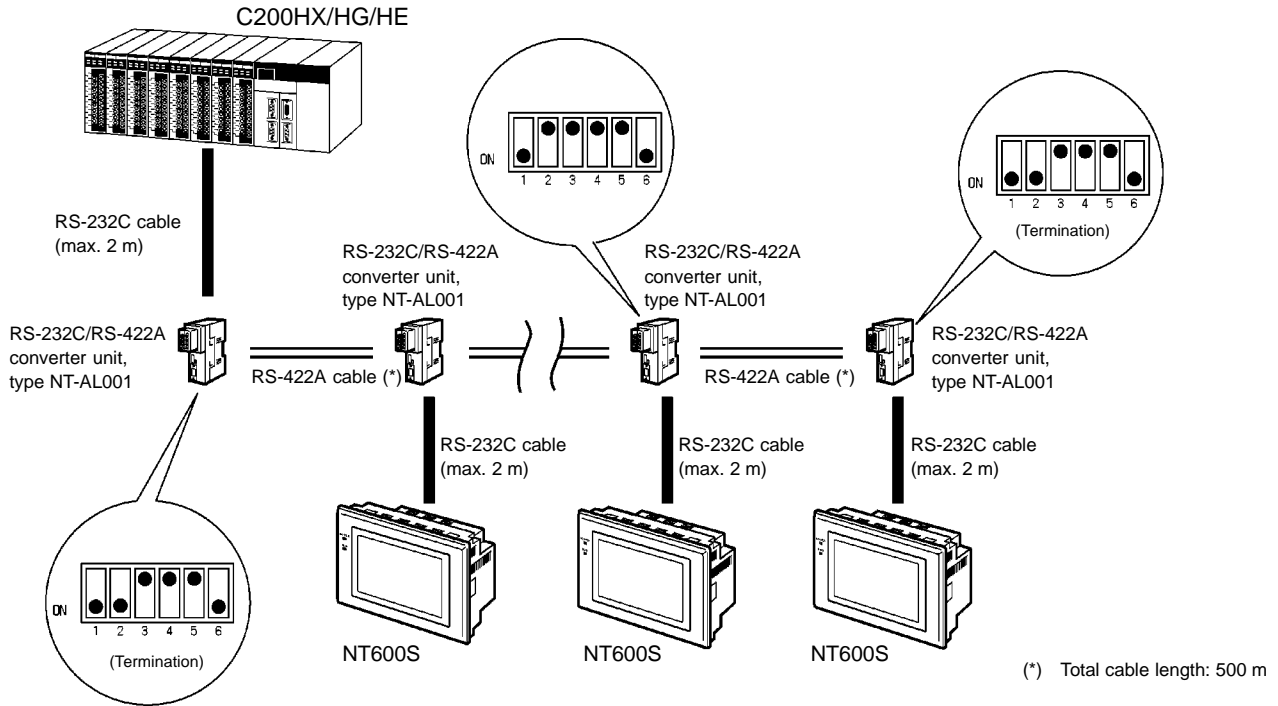

- RS-485 connection, RS-232C at the PC side

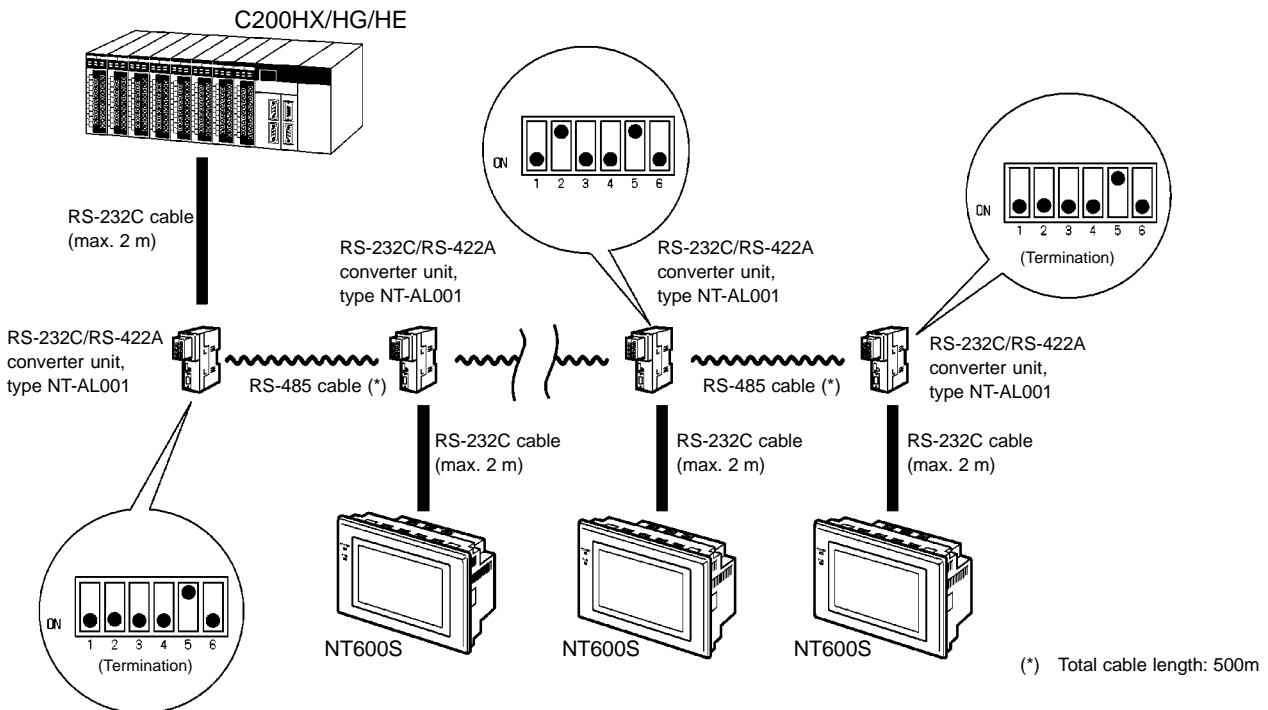

- RS-422A connection, RS-422A at the PC side

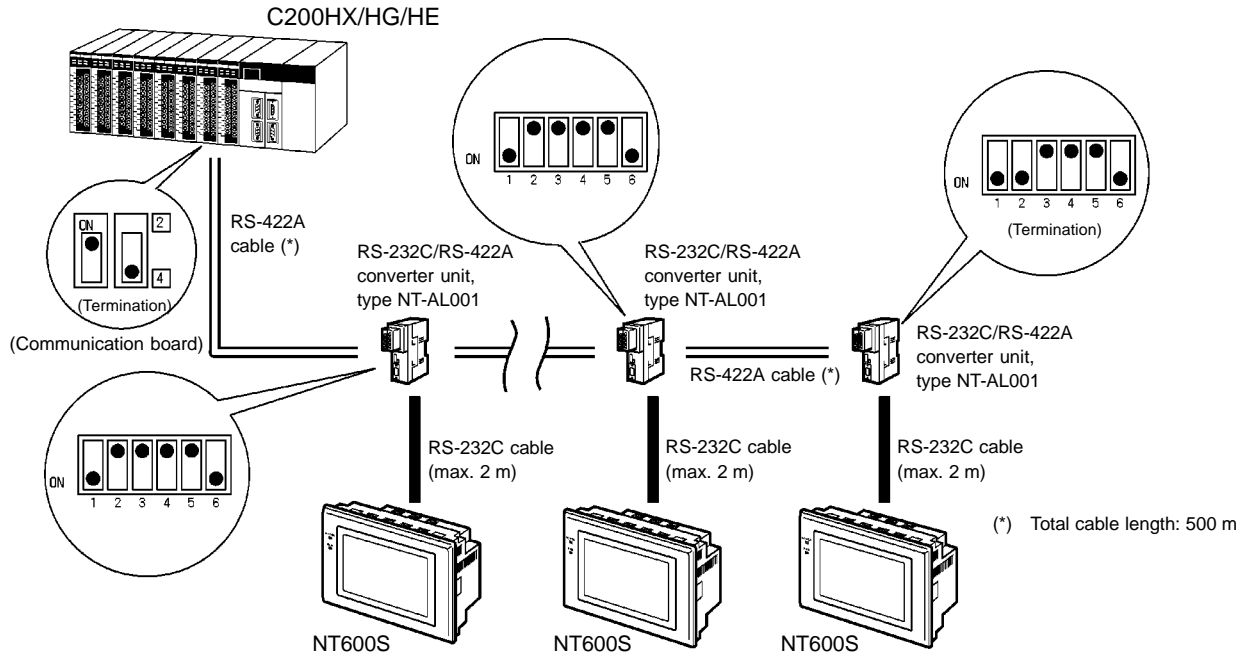

- RS-485 connection, RS-485 at the PC side

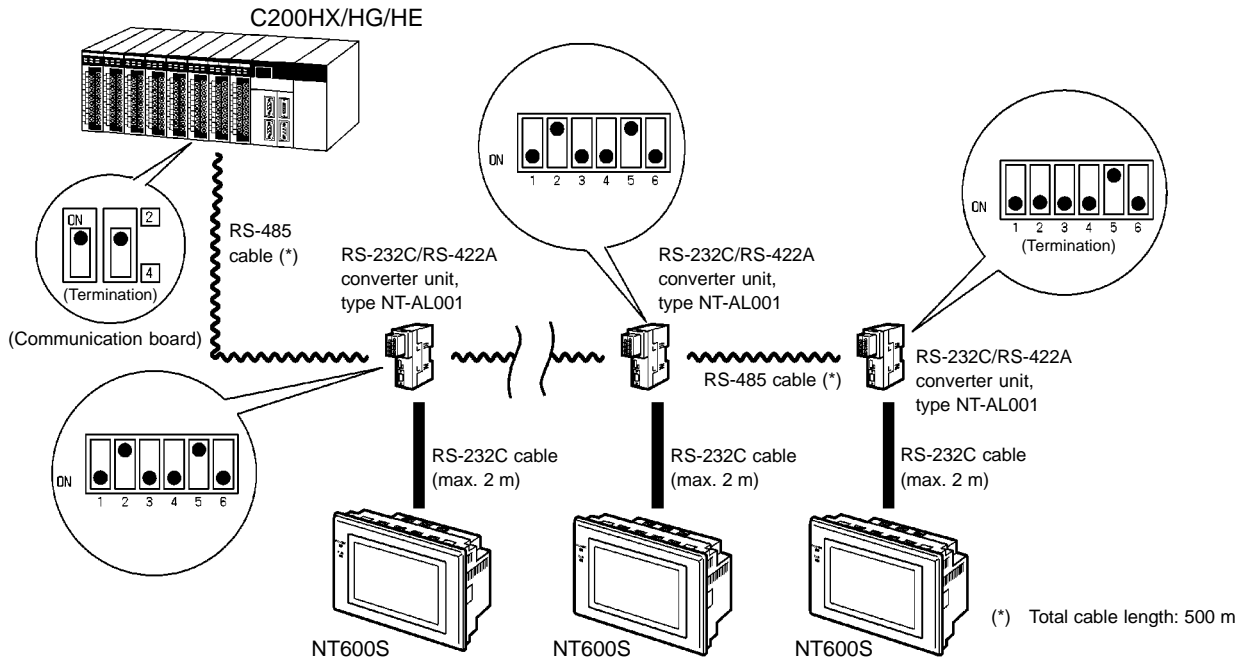

### 3-6-3 PC Switch Settings

When the PC and NT600S units have been connected, set the switches at the CPU module at the PC side in order to enable communication using the NT link method.

- C series, C200HX/HG/HE

Write the communication conditions directly to the "PC system area" (data memory) using a peripheral tool (e.g., SYSMAC support software). For details on the operation for setting the "PC system area", refer to the "SYSMAC C200HX/HG/HE Installation Guide" (W302-E1-□).

[PC system setting area setting]

With C200HX/HG/HE, the setting area differs according to the standard port of the CPU module used for the connection or the port of the expansion communication board.

Port	Channel #	Writing Value	Settings
C200HX/HG/HE RS-232C port	DM6645	5□00	Use NT link (1:N) □ = highest unit No. in the maximum number of connectable PTs (1 to 7). (*)
C200HX/HG/HE port A	DM6555		
C200HX/HG/HE port B	DM6550		

(\*) When using C200HE, the PT unit No. range is 1 to 3.

## 3-7 Connecting to the PC with C200H Direct Communication

This is the procedure for connecting the NT600S to an OMRON PC by using the C200H direct communication method.

### 3-7-1 Compatible PCs

Some models and series of OMRON PCs have the direct communication function built in. Check the model and series of the PC to which the connection is to be made, and the type of CPU unit installed before making the connections.

The PCs that can be connected to the NT600S by using C200H direct communication are listed below.

CPU Unit	Model Name
C20H/C28H/C40H/C60H	C□□H
C200H-CPU01-E	C200H
C200H-CPU03-E	
C200H-CPU11-E	
C200H-CPU21-E	
C200H-CPU23-E	
C200H-CPU31-E	
C200HS-CPU01-E	C200HS
C200HS-CPU03-E	
C200HS-CPU21-E	
C200HS-CPU23-E	
C200HS-CPU31-E	
C200HS-CPU33-E	C200HE
C200HE-CPU11-E	
C200HE-CPU32-E	
C200HE-CPU42-E	C200HG
C200HG-CPU33-E	
C200HG-CPU43-E	
C200HG-CPU53-E	
C200HG-CPU63-E	C200HX
C200HX-CPU34-E	
C200HX-CPU44-E	
C200HX-CPU54-E	
C200HX-CPU64-E	

**⚠ Caution** In a system where the user program operates according to the PC cycle time, the system operation may not be constant because of cycle time fluctuations. Consider this point when designing the system.

### C200H Interface Unit Part Names and Functions

This section gives the names and functions of the parts of the C200H interface unit for your information before you mount the C200H interface unit to the NT600S.

C200H interface unit: NT-LB122

Front of C200H interface unit

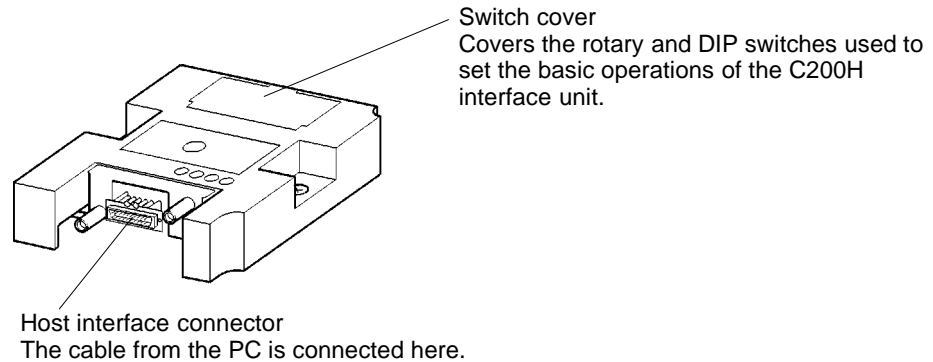

---

**Reference** When the C200H interface unit is mounted or removed from the NT600S, the memory switches are initialized.

---

### Mounting and Setting the C200H Interface Unit

This section explains how to mount the C200H interface unit on the NT600S, and how to set the DIP switches.

#### Mounting the Unit to the NT600S

Mount the C200H interface unit by inserting it fully home so that there is no clearance between it and the NT600S, then tightening the screws securely. If it is difficult to make the connection, shift the position of the unit and try inserting it again.

---

**Note** Be sure to switch off the power to the NT600S before mounting or removing the unit.

---

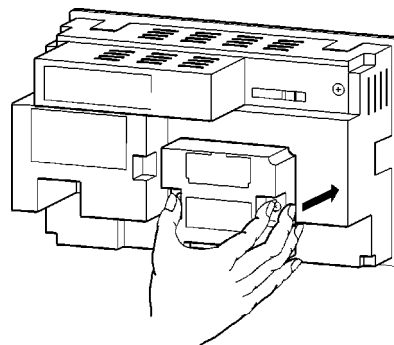

**Removing the unit**

As shown in the figure below, grasp the unit by the cutouts at either side, then pull it out while keeping a firm grip.

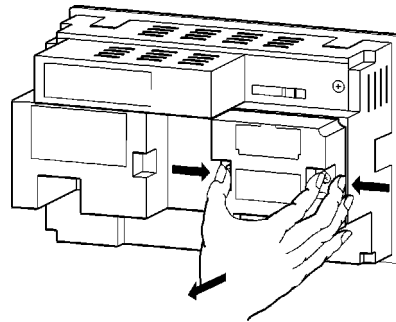

**C200H Interface Unit Switch Settings**

Set all the DIP switches (SW1, SW2) of the C200H interface unit to “OFF” (reserved for system use) and set the unit number to 0 with the rotary switch (SW3).

It is necessary to set a machine number for NT600S since it operates as a high-level function I/O unit of C200H. Make sure that the machine number to be allocated is unique.

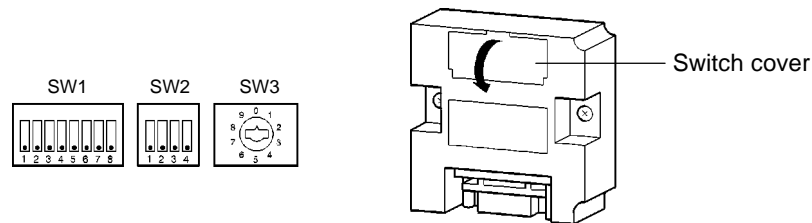

The DIP switches are located under the switch cover on the front of the interface unit.

When using C200H/HS, or C200HX/HG/HE, the words corresponding to the channel numbers indicated below are occupied for each unit number set. However, since the NT600S uses the allocated bits and words for processing, it does not use these words.

These words are used as internal auxiliary relays.

Unit No.	Channel #
0	100 to 109
1	110 to 119
2	120 to 129
3	130 to 139
4	140 to 149
5	150 to 159
6	160 to 169
7	170 to 179
8 (*)	180 to 189
9 (*)	190 to 199

(\*) Cannot be set with C□□H.



- Reference**
- If unit numbers 8 and 9 are set with a C□□H, a “special I/O unit error” occurs.
  - When an NT600S is connected to a C□□H, I/O expansion equipment cannot be connected. In other words, it will not be possible to connect other special I/O units, and therefore whatever unit numbers are specified there will be no duplication of numbers.

### 3-7-2 Connection Method

Using the I/O connecting cable, connect the C200H interface unit mounted to the NT600S and the PC unit.

- ⚠ Caution**
- Always turn off the power at both the PC and PT before connecting the C200H interface cable.  
Otherwise the system may operate unpredictably.
  - Switch off the power to the NT600S and PC before disconnecting/connecting the cable.

#### [I/O connecting cable]

Use one of the following models of I/O connecting cable.

	Model	Cable length (L)
For connecting C200H/ HS/HE/HG/HX	C200H-CN311	30cm
	NT20M-CNP711 C200H-CN711	70cm
	NT20M-CNP221 C200H-CN221	2m
	NT20M-CNP521 C200H-CN521	5m
	NT20M-CNP131 C200H-CN131	10m
For connecting C□□H	C20H-CN312	30cm
	NT20M-CNP712 C20H-CN712	70cm
	NT20M-CNP222 C20H-CN222	2m

In the case of NT20M-CNP□□□ models, the connector at the C200H interface side is a compact one.

- ⚠ Caution**
- The combined lengths of each of the I/O connecting cables must not exceed a total of 12 m (or 6 m for C□□H models).
  - The cable’s tensile load is 30 N. Do not subject it to loads greater than this.  
Otherwise a discontinuity may occur, causing operation to fail.

- Note**
- If the I/O connecting cable is passed through a hole, this hole must have a diameter of at least 53 mm  $\phi$ . If the top cover is removed the cable can be passed through a minimum hole size of 33 mm  $\phi$ . Replace the cover before mounting the unit.
  - If a C200H-CN□□□ or C20H-CN□□□ is used as the I/O connection cable, the connector will project beyond the bottom face of the NT600S.

**Connection to a C200H/C200HS, C200HX/HG/HE**

Make the connection to the CPU unit or I/O extension unit with an I/O connecting cable. The following restrictions apply to this connection:

- Only one CPU unit, and one I/O extension unit, can be connected. Connection to two I/O extension units is not possible.
- Connection to remote I/O slave units is not possible.
- The C200H interface unit only has one interface connector. It is not possible to connect a C200H interface unit between a CPU unit and an I/O extension unit. It must be connected as the final element in the system.

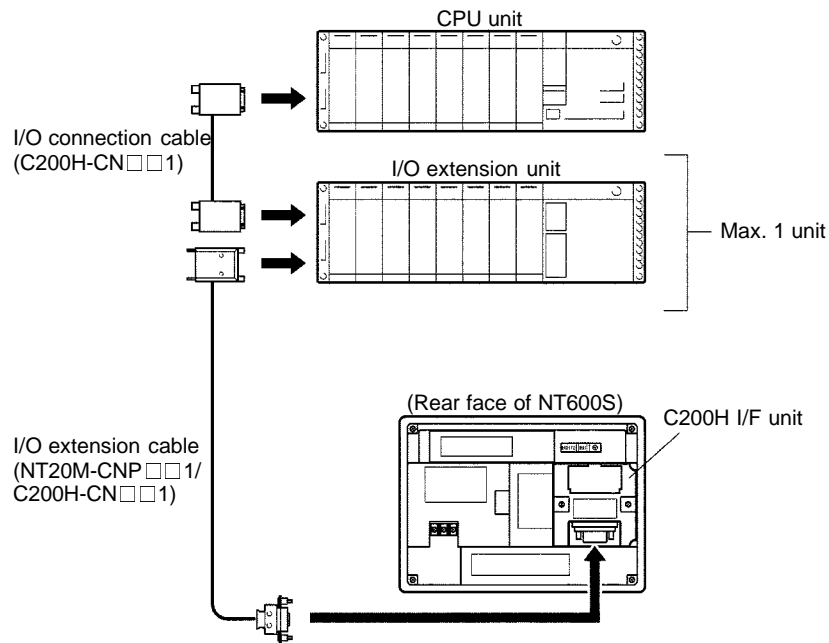

**Connection to a C□□H**

Make the connection to the CPU unit with an I/O connecting cable. The following restrictions apply to this connection.

- Only one CPU unit can be connected.
- Up to two I/O units can be connected to one CPU unit. However, it is not possible to connect an I/O extension unit.
- It is not possible to connect a C□□H I/O unit after a C200H interface unit. The C200H interface unit must be the final element in the system.

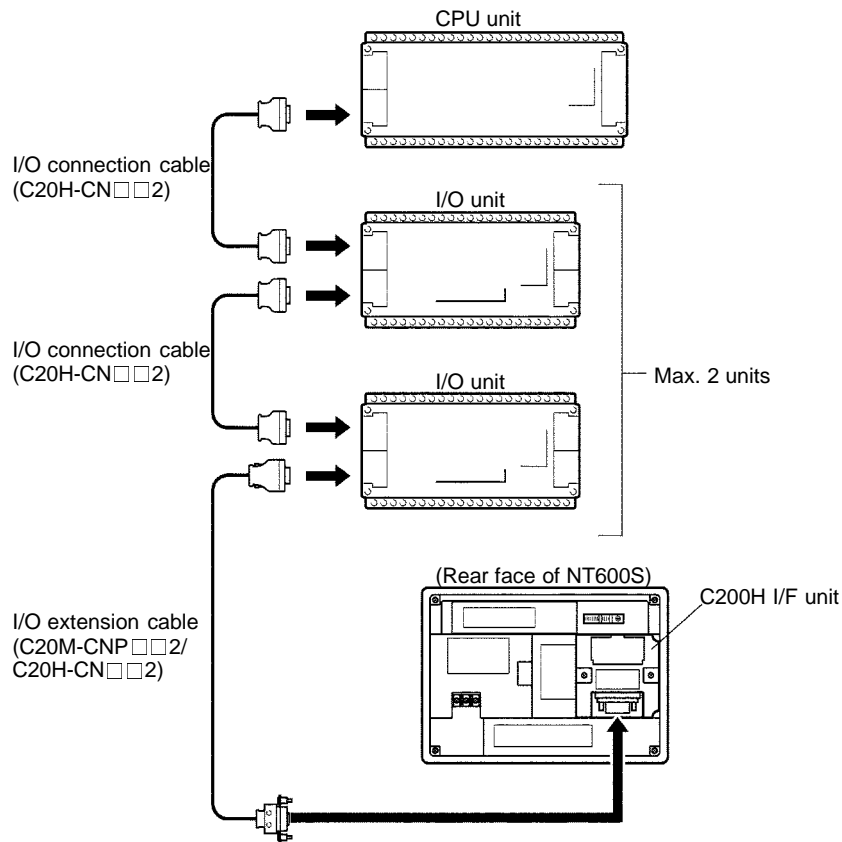

**Note**

When making a connection to a C□□H, a noise filter must be installed.

1. Insert the noise filter in the power supply line of the C□□H.
2. Make the distance between the noise filter and the C□□H as short as possible, and separate it from the power supply line.
3. Connect the case of the noise filter to the FG face.
4. For the noise filter, use a ZGB2202-01U made by TDK or equivalent.

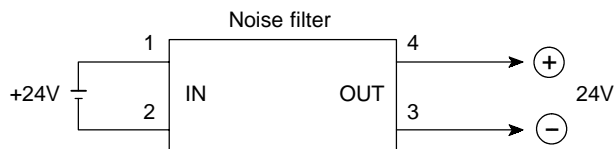

**Switching the power ON/OFF when using C200H direct communication**

The C200H interface unit has the function of a C200H I/O extension unit. The power should be switched ON/OFF in the way explained below.

- ⚠ Caution** Depending on how the power is switched ON/OFF, the entire system may stop. Follow the correct procedure when switching the power ON/OFF. Otherwise the system may operate unpredictably.

**Power ON**

Switch the power ON in the following sequence.

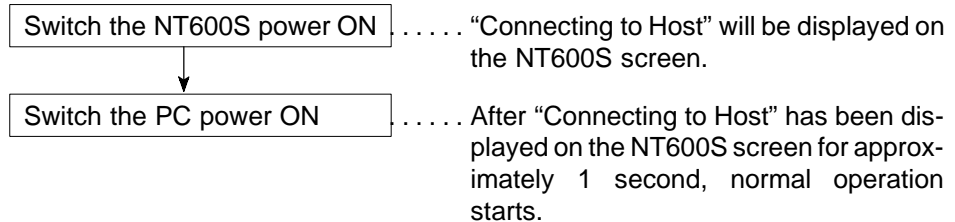

- Reference**
- If the power supply to the PC/Host is switched on first, the CPU of the PC/Host is subject to a system reset, disabling PC/Host operation. If the power to the NT600S is then switched ON, "Connecting to Host" will be displayed on the NT600S screen for approximately one second and then normal operation will commence.
  - If the I/O connecting cable is disconnected during system operation, an I/O bus error will occur at the PC/Host side and operation will stop. If this happens, connect the I/O connecting cable and clear the error.

**Power OFF**

Switch the power OFF in the following way.

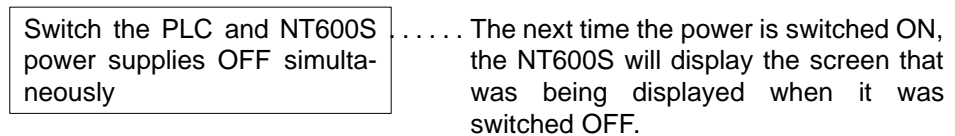

- Reference**
- If the power supply to the NT600S is switched OFF first, the CPU of the PC/Host is subject to a system reset, disabling PC operation.
  - The system must be stopped before replacing a defective NT600S or C200H interface unit. If only the power to the NT600S is switched OFF, the system will stop suddenly, causing accidents or damage to machinery.

## 3-8 Host Connections by RS-232C

Connect NT600S with an RS-232C Interface Unit installed to the host computer with an RS-232C cable.

RS-232C connection allows a single NT600S to be connected to the host.

A computer or other control device with a built-in RS-232C interface is a suitable host for connection to the NT600S.

**Reference** To connect the NT600S to a Host by the RS-232C method, the NT600S memory switch for "Comm. Method" must be set to "RS-232C" and the communication settings must be set for RS-232C communications. For the "Comm. Method" setting, refer to "Selecting the Host Communication Method" (page 85), and for the memory switch setting for RS-232C communication, refer to "Setting the RS-232C Communication Conditions" (page 89).

### 3-8-1 Host Computer Communication Settings

Set the host communication conditions according to the following table.

Item	Setting
Baud rate	Set to the same baud rate as the NT600S: 2400, 4800, 9600, 19200
Data bits	7 bits/8 bits
Stop bits	1 bit/2 bits
Parity	Even, Odd, None
Flow control	RS/CS control XON/XOFF control None

**Reference** Set the same communication conditions at the NT600S and Host.

Refer to the appropriate instruction manuals for the method of setting the Host communication conditions.

You are recommended to set the maximum baud rate supported by both the NT600S and Host.

### 3-8-2 Connector Pin Arrangement

The RS-232C connection between the NT600S and Host is described below.

#### RS-232C Interface Unit

The connector and cable specifications are described below.

Electrical characteristics: Conforms to EIA RS-232C specifications.

Signal direction: Signal input and output are relative to the host computer.

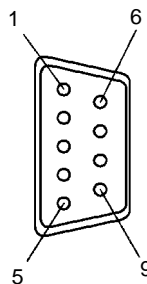

Connector pin #	Signal name	Abbreviation	Signal direction	
			Input	Output
1	Frame ground	FG	---	---
2	Send data	SD (TXD)	---	Yes
3	Receive data	RD (RXD)	Yes	---
4	Request to send	RS (RTS)	---	Yes
5	Clear to send	CS (CTS)	Yes	---
6	+5V 150mA Max. (ST211(B)-EV□) 100mA Max. (ST121(B)-EV□)	+5 V	---	Yes
9	Signal ground	SG (GND)	---	---

**Note**

1. FG is not connected internally in the NT600S.
2. Unlisted pins are not used.

For cable parts and the wiring method, refer to APPENDIX E Method for Making the Cable for Connection to the PC/Host (page 264).

**Connecting to the Host Computer**

Use a cable that is compatible with the RS-232C connector of the host to connect the NT600S and the host.

In the example shown here, the cable connects the 9-pin connector of the NT600S and 25-pin connector of the host. If the host has a 9-pin RS-232C connector, use an RS-232C cable with 9-pin connectors at both ends.

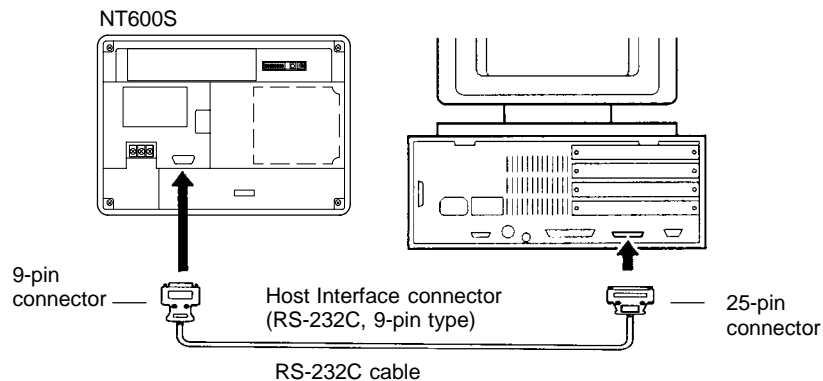

- ⚠ Caution**
- Turn off the NT600S power supply when connecting or disconnecting connectors.
  - After connecting a communication cable, always secure it with the screws.
  - Check that the current capacity of the equipment to be supplied is within 150 mA before using the +5V output of pin No.6. Otherwise, the product may malfunction.

The current capacity of +5 V output of NT600S is:

- +5 V  $\pm$  5%, 150 mA max. with ST211(B)-EV□, and
- +5 V  $\pm$  5%, 100 mA max. with ST121(B)-EV□.

# SECTION 4

## System Menu Operation

This section describes the operation of the System Menu focusing on the procedure to start up the NT600S.

Functions which will be convenient to use the NT600S and those which are useful for the system maintenance are also explained here.

4-1	Operation Flow by the System Menu .....	66
4-2	Starting the NT600S .....	67
4-2-1	Changing the System Settings etc. ....	67
4-3	Operation Modes and the System Menu .....	68
4-3-1	System Menu and the Operation Modes .....	68
4-3-2	Menu Tree .....	69
4-3-3	Operations with the System Menu .....	70
4-4	Initializing Memory .....	72
4-4-1	Initialization of the Screen Data .....	72
4-4-2	Initialization by Using the DIP Switch (Forced Initialization) .....	74
4-5	Registering the Screen Data .....	79
4-6	Setting the Conditions of Communications with the PC/Host by Using the Memory Switches	
83		
4-6-1	Selecting the Host Communication Method .....	85
4-6-2	Baud Rate Selection (Host Link Only) .....	86
4-6-3	Setting Unit Numbers (NT Link 1:N Only) .....	87
4-6-4	Setting the RS-232C Communication Conditions .....	89
4-6-5	Selecting the Automatic Reset Function .....	90
4-7	Starting the Operation .....	92
4-8	Various System Settings .....	93
4-8-1	Setting the Key Press Sound .....	93
4-8-2	Using the Buzzer .....	94
4-8-3	Backlight OFF / EL Screen OFF Function .....	96
4-8-4	Resume Function (Featured with Battery Unit Only) .....	98
4-8-5	Setting the Support Tool Mode .....	99
4-9	System Maintenance .....	101
4-9-1	I/O Check .....	101
4-9-2	Checking the NT600S DIP Switch Settings .....	107
4-9-3	Checking the PT Setting Status .....	108
4-9-4	Display History .....	110

## 4-1 Operation Flow by the System Menu

Follow the procedure below when using the NT600S for the first time or when changing the system.

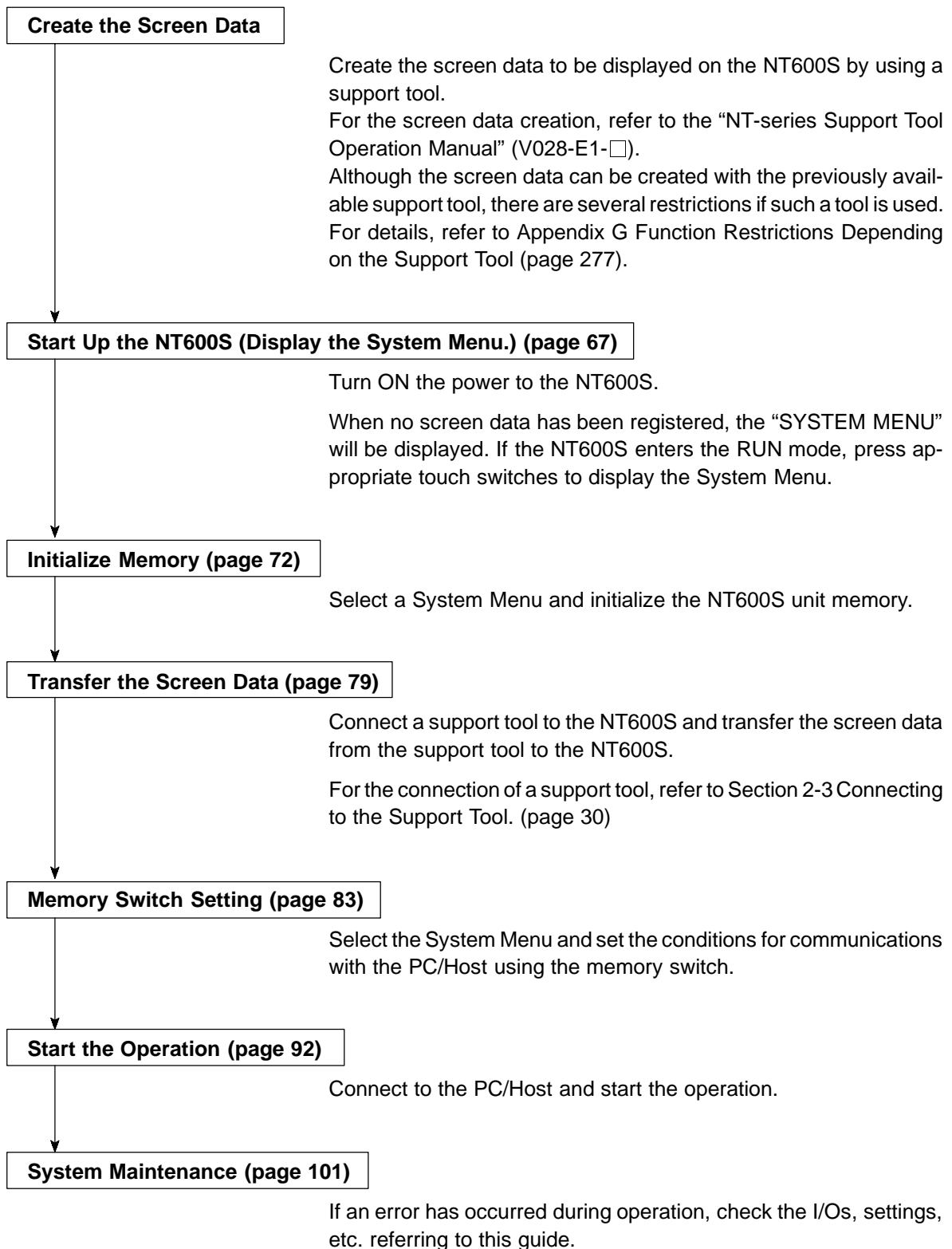



## 4-2 Starting the NT600S

When the NT600S is started, it will enter the RUN mode if system settings and screen data registration have been completed. If no screen data has been registered or the screen data are destroyed, the System Menu will be displayed.

Before turning ON the power, check the following DIP switch settings on the NT600S.

- SW2-3 “Switch to the System Menu enabled/disabled” is set to OFF (enabled).
- SW2-1 “Screen data forced initialize Yes/No” is set to No (ineffective).

For the DIP switch settings of the unit, refer to the “DIP switch settings” (page 26).

### 4-2-1 Changing the System Settings etc.

Follow the procedure below to change the system settings or screen data contents.

**Procedure** 1. Turn ON the power to the NT600S.

The NT600S will enter the RUN mode and the start-up screen will be displayed. The start-up screen varies according to registered screen data.

2. Press appropriate touch switches to display the System Menu, and change system settings. For the method for calling the System Menu, refer to the “Operations with the System Menu” (page 70).

**Note**

---

If the NT600S has failed to start up normally; an error message is displayed or no screen is displayed, memory needs to be initialized.

For the memory initializing procedure, refer to Section 3-4 Initializing memory (page 72).

---

## 4-3 Operation Modes and the System Menu

The NT600S operates in either “RUN”, “Transmit”, or “Maintenance” mode. The operation modes can be switched by using the System Menu.

### 4-3-1 System Menu and the Operation Modes

Select an operation mode by pressing the corresponding touch switch in the System Menu. The operation modes with respect to the System Menu are related to each other as shown below.

For the operations with the System Menu, refer to the “Operations with the System Menu” (page 70).

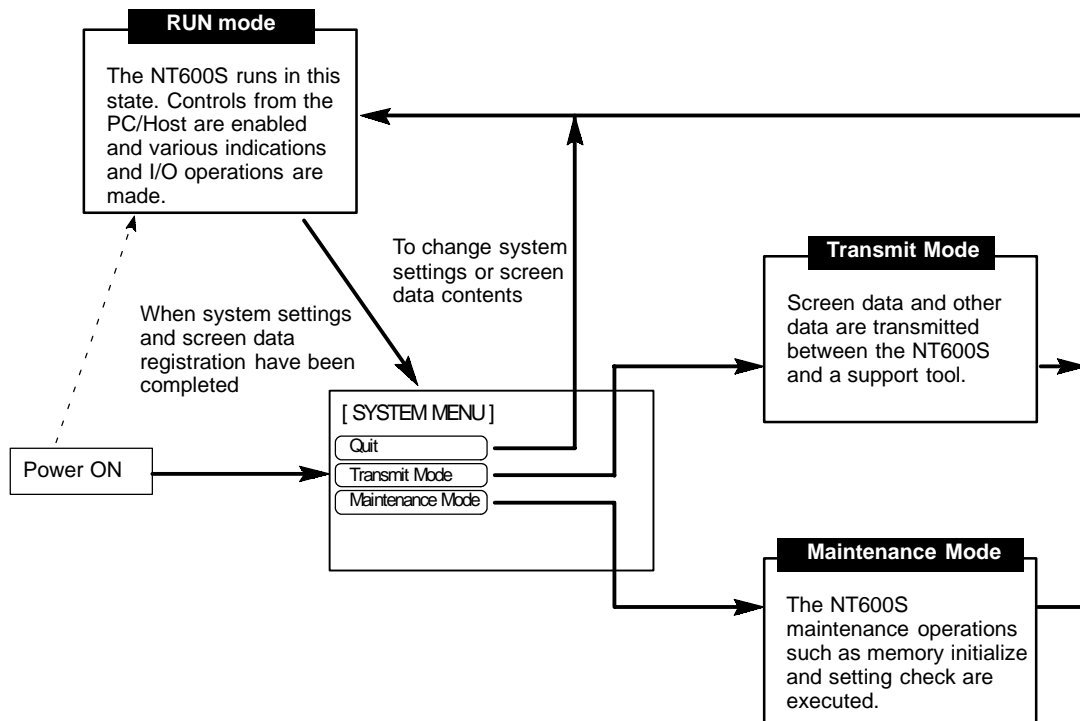

### 4-3-2 Menu Tree

The System Menu allows to effect various NT600S functions by using the touch switches. The NT600S's functions with respect to the System Menu are related as shown below.

For the operations with the System Menu, refer to the "Operations with the System Menu" (page 70).

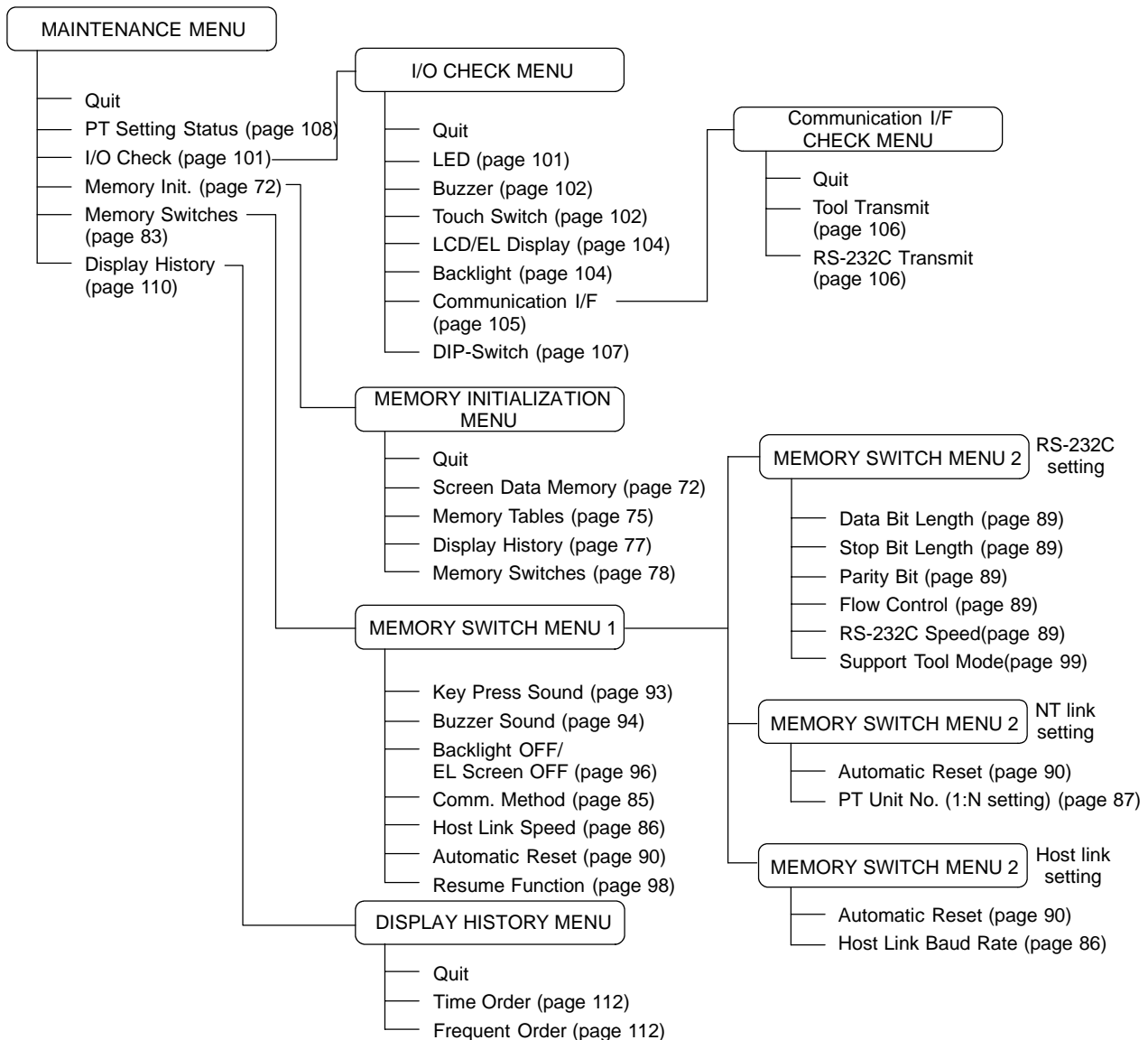
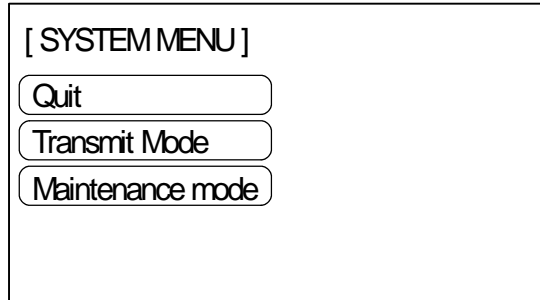

### 4-3-3 Operations with the System Menu

The following gives the procedure to call the System Menu, select the menu items, and other operations with the System Menu.

**Reference** Make sure that DIP SW2-3 “Switch to the System Menu enabled/disabled” is set to OFF (enabled). If the setting is ON (disabled), the System Menu will not be displayed by following the procedure given below.

**Displaying the System Menu** Press appropriate touch switches to display the System Menu as mentioned below. The “RUN” LED goes off when the System Menu is displayed.

The NT600S display screen has four touch switches to display the System Menu in the four corners (about 14 mm x 11 mm size). Press any two of these switches at the same time to call the System Menu screen.

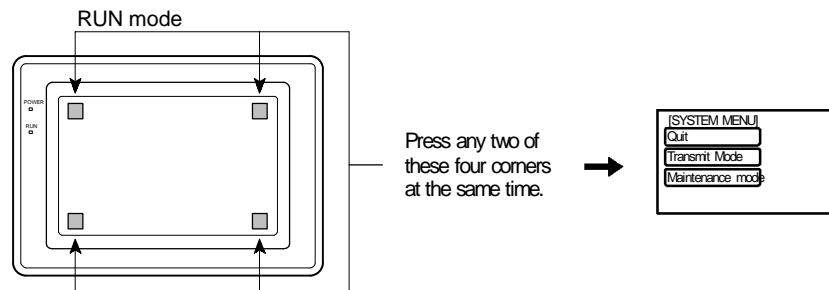

Note that the touch switches used to call the System Menu are not displayed on the screen. If a touch switch displayed in a corner is pressed first, the touch switch will function and the System Menu will not be displayed. To successfully call the System Menu, first press a corner where no touch key is displayed, and then, press any other corner regardless of the presence of a touch key.

**Reference**

- If a screen has the touch switches registered at all of the four corners, it is impossible to call the System Menu from the screen. In this case, switch to a screen that does not have touch switches at its four corners.
- A “system key” function can be assigned to a touch switch. Pressing the touch switch so assigned on the screen can easily display the System Menu. For the relationship between the system key and the touch switch, refer to the “System key functions” (page 142).

**Selecting the Menu Items**

Press (touch) a menu item on the screen to select the item.

Menu items allow to make the ON/OFF selection or to call subsequent menu or screen.

**Example :**

To call the “Maintenance Mode Menu” by pressing the “Maintenance Mode” on the System Menu screen:

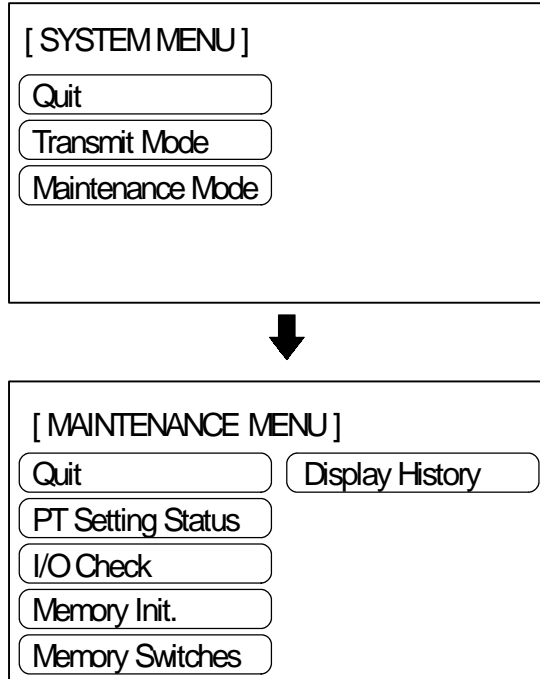

**System Menu Items**

The System Menu items and the functions are as given below.

Menu Item	Function
Quit	The System Menu screen is cleared and the NT600S will return to the RUN mode.
Transmit Mode	The Transmit Mode screen will be displayed to allow the transmission of the screen data between the NT600S and the support tool. For the transmission of the screen data, refer to Section 3-5 Registering the Screen Data (page 79).
Maintenance Mode	The Maintenance Mode menu will be displayed to allow the maintenance of the NT600S system.

**Switching from the System Menu to the RUN mode**

The NT600S will exit the System Menu and switch to the RUN mode in the cases mentioned below.

- Selecting “Quit” in the System Menu.
- The screen (touch switches) is not pressed for over 10 seconds.

## 4-4 Initializing Memory

If the NT600S is used for the first time or if the screen data is ruined and the NT600S cannot be normally started, the memory needs to be initialized.

The memory initialization is required in the cases mentioned below.

- When the NT600S is used for the first time or when an error message indicating that the screen data is ruined etc. when the NT600S is started.
  - ➔ Use the “Maintenance Mode” – “Init. Memory” in the System Menu.
- When the NT600S has made a buzzer sound and the screen has disappeared during the start-up or operation.
  - ➔ Use the NT600S DIP SW2-1 “Screen data forced initialize effective/ineffective”.

---

**Reference** When an error has occurred, the error messages such as “Screen data corrupted” will be displayed. For the error messages displayed on the screen, refer to Section 7-2 “Responding to Displayed Error Messages” (page 242).

---

The following memory data can be initialized.

- Image data memory
- Memory tables
- Display history
- Memory switch

The image data memory can be initialized regardless of the setting for the resume function (page 98).

---

**Reference**

- After initializing one type of data, if it is necessary to initialize another type, display the System Menu again and follow the initialization operation from the beginning.
- If the image data memory is initialized, all the screen data stored in the NT600S is cleared. Therefore, before initializing the image data memory, make sure that the created screen data has been saved in a floppy disk.

---

### 4-4-1 Initialization of the Screen Data

The screen data can be initialized by either of the following two methods.

- Initialization by using the System Menu
- Initialization by using the DIP switch

Initialization by using the System Menu

Initialize the image data memory by following the procedure given below.

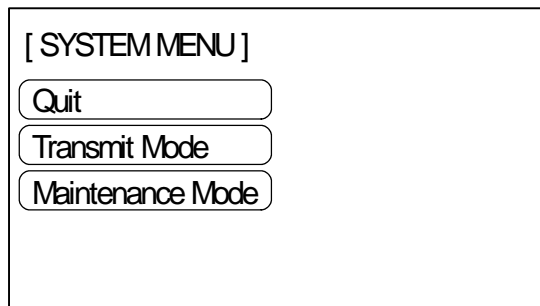

Select "Maintenance Mode".

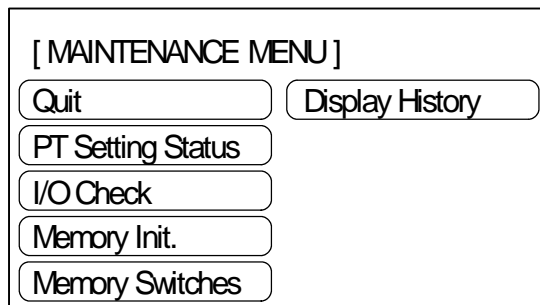

Select "Memory Init.".

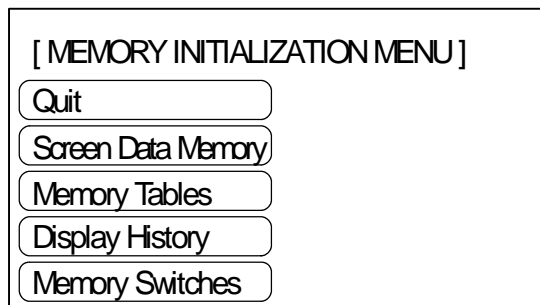

Select "Screen Data Memory".

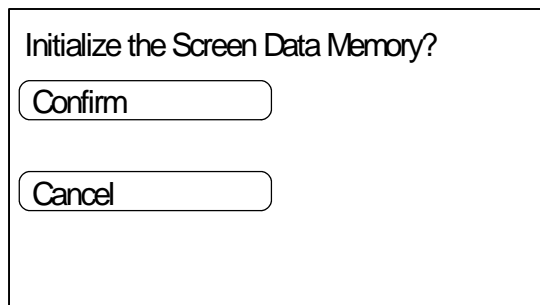

Select "Confirm".



The screen data memory is initialized. During the initialization, the "Initializing ..." message will be displayed.

**Reference** If “No” is selected, the memory initialization will be canceled and the NT600S returns to the “Memory initialization”.

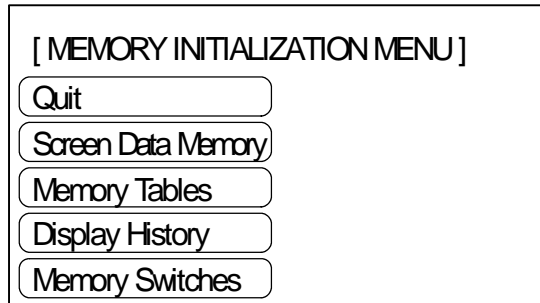

Upon completion of image data memory initialization, the NT600S returns to the “Memory Initialization Menu”.

After initialization of the screen data memory, the system enters the operation mode. At this point, nothing is displayed on the screen of the NT600S.

When the screen data memory initialization has been completed, transfer the screen data from the support tool.

If the screen data cannot be initialized for any reason, the message “An Error Occur Initializing Memory” is displayed.

### 4-4-2 Initialization by Using the DIP Switch (Forced Initialization)

**Note** Be sure to turn the power OFF before setting the NT600S DIP switch.

Set the DIP switch as follows to initialize the screen data memory.

**Operation** 1. Set DIP SW2-1 on the NT600S to ON and turn the power ON.

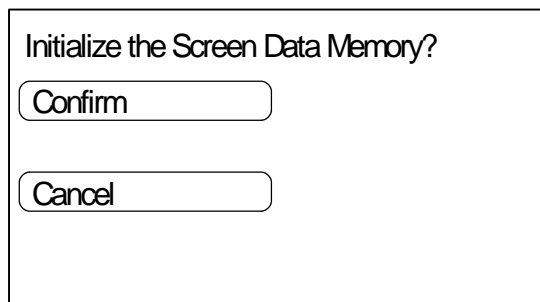

Select “Confirm”. The screen data memory is initialized. During the initialization, the “Initializing ...” message will be displayed.

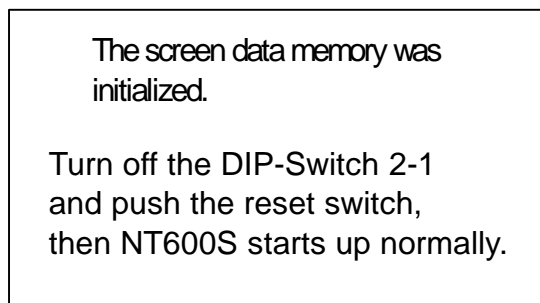

2. Turn the NT600S power to OFF.
3. Set NT600S DIP SW2-1 to OFF and turn the power ON.



- Reference**
- Selecting “No” will cancel the memory initialization. To change the system settings or to register the screen data, set DIP SW2-1 to OFF and start the NT600S, and then, call the System Menu screen.
  - The NT600S DIP SW2-1 is used to set “Screen data forced initialize effective/ineffective”. Setting this to ON selects “effective”, and OFF “ineffective”.

**Initialization of the Memory Tables**

It is possible to initialize the numeral memory tables and character-string memory tables in the NT600S. When these tables are initialized, the values are returned to those set by the support tool.

If a memory table is initialized in the Maintenance Mode, it is initialized regardless of the setting for the resume function (resume function: page 98)

If “Effective” is set for the “Resume Function” memory switch, the initial values set with the support tool will not be reflected in the present values of the memory tables unless the memory tables are initialized.

- Reference**
- If “Ineffective” is set for the “Resume Function” memory switch, the memory tables can be initialized just by switching the NT600S power off and back on again, or by resetting it, (page 98)

Using the System Menu, initialize the memory tables by following the procedure given below.

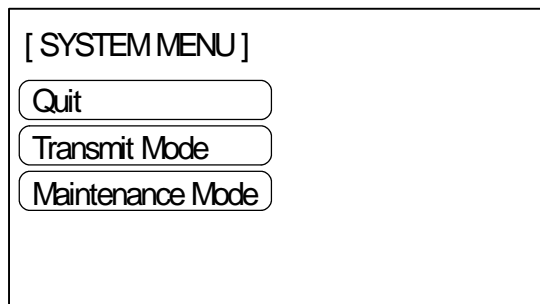

Select “Maintenance Mode”.

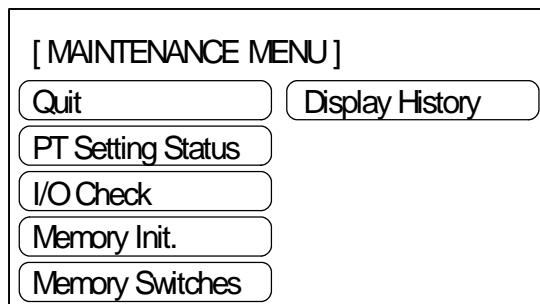

Select “Memory Init.”.

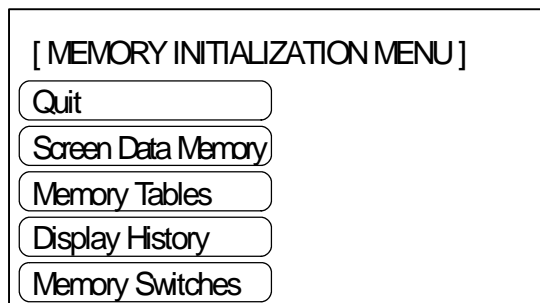

Select “Memory Tables”.



Initialize the Memory Tables?

Confirm

Cancel

Select "Confirm".  
The memory table is initialized.

- Reference**
- If "Cancel" is selected instead of "Confirm", the NT600S returns to the "Memory Initialization Menu" without initializing the memory.
  - If a memory table is initialized in the Maintenance Mode, it is initialized regardless of the setting for the resume function (resume function: page 98).

**Initialization of the Display History Data Memory**

The display history (page 110) is stored in the order of occurrence (time order) or the order of frequency (frequent order). Since no more display history data can be stored if the memory becomes full, the memory has to be initialized at regular intervals.

- Reference**
- The display history data memory can be initialized by a command given from the Host.

Using the System Menu, initialize the display history data memory by following the procedure given below.

[ SYSTEM MENU ]

Quit

Transmit Mode

Maintenance Mode

Select "Maintenance Mode".



[ MAINTENANCE MENU ]

Quit

PT Setting Status

I/O Check

Memory Init.

Memory Switches

Display History

Select "Memory Init.".



[ MEMORY INITIALIZATION MENU ]

Quit

Screen Data Memory

Memory Tables

Display History

Memory Switches

Select "Display History".



Initialize the Display History?

Confirm

Cancel

Select "Confirm".



The display history data memory is initialized.

---

**Reference** If "Cancel" is selected instead of "Confirm", the NT600S returns to the "Memory Initialization Menu" without initializing the memory.

---

### Initialization of the Memory Switch

It is possible to initialize the settings of the NT600S memory switch to the settings made before shipping.

- Key Press Sound : ON
- Buzzer Sound : ON
- Screen Saver : 10 min
- Comm. Method : Host Link
- Host Link Speed : 9600 bps
- Automatic Reset : OFF
- Resume Function : OFF
- Data bit length : 8 bits
- Stop bit length : 1 bit
- Parity bits : None
- Flow control : None
- Baud Rate : 2400 bps
- Tool Mode : NT600S
- Unit No. : 0

Using the System Menu, initialize the memory switch by following the procedure given below.

[ SYSTEM MENU ]

Quit

Transmit Mode

Maintenance Mode

Select "Maintenance Mode".



[ MAINTENANCE MENU ]

Quit      Display History

PT Setting Status

I/O Check

Memory Init.

Memory Switches

Select "Memory Init.".



[ MEMORY INITIALIZATION MENU ]

Quit

Screen Data Memory

Memory Tables

Display History

Memory Switches

Select "Memory Switches".



Initialize the Memory Switches?

Confirm

Cancel

Select "Confirm".



The memory switch settings are initialized to the settings made before shipping. While the memory switch is being initialized, "Initializing ..." is displayed.

**Reference** If "Cancel" is selected instead of "Confirm", the NT600S returns to the "Memory Initialization Menu" without initializing the memory.

## 4-5 Registering the Screen Data

The screen data is created by using the support tool and registered to the NT600S screen data memory. This section describes the procedure to register the screen data to the NT600S. For the screen data creation and the support tool operation, refer to the NT-series Support Tool Operation Manual (V028-E1-□).

**Reference** The screen data transmission speed can be increased by setting “Hispeed” for “Communication Mode” on the Tool Settings screen of the support tool.

### Transmission – Transmission in File Units

The NT600S uses several screens which are switched on its display. The screen data of one NT600S unit corresponds to the files created by using the support tool. Select a file which contains the screen data to be transmitted when selecting the screen data to be transmitted to the NT600S so that the required screen data can be transmitted to the NT600S.

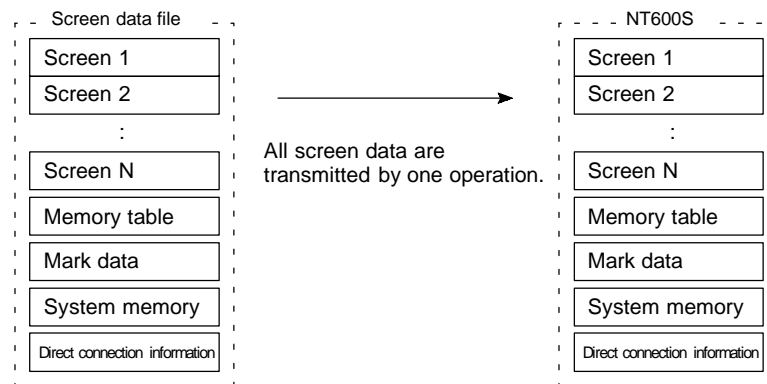

**Reference**

- If an error message and the System Menu are displayed immediately after the NT600S has been started, the screen data memory needs to be initialized.
- Before transferring the screen data to the NT600S, initialize the image data memory.

## Transmission in Screen Units

The NT600S allows the transmission of data for individual screens. The screen number of the screen to be transmitted can be specified with the support tool to transmit this screen only to the NT600S (it is also possible to transmit multiple screens in a batch).

If, when executing screen data transmission in screen units, there are also changes to data other than screen data, for example memory table or direct access data, transmit this changed data to the NT600S also.

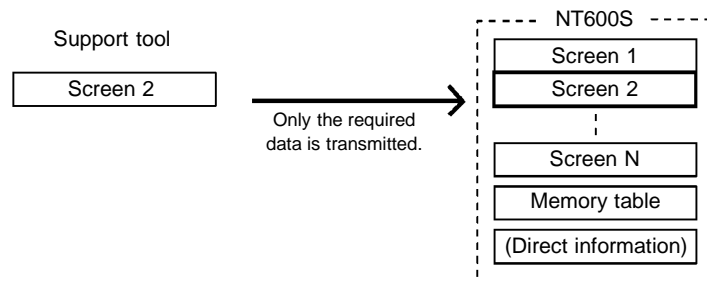

**Caution** When screen data transmission is in screen units, if data other than screen data changes – for example memory table or direct access data – transmit this new data also.

**Reference** When screen data is transmitted to the NT600S, it does not overwrite existing screen data; it is written to a free area of the memory. Consequently, if data is transmitted frequently in screen units, the free area of the memory will not be sufficient and transfer will become impossible. If this happens, transmit the data in file units to bring the memory of the NT600s back to order.

## Transmitting the Screen Data from the Support Tool

To transmit the screen data from the support tool to the NT600S, connect the NT600S to the computer on which the support tool is being used, and follow the procedure below.

**Reference** The NT600S (Host link/NT link/RS-232C method) uses one connector for the connection to both a PC/Host and a computer. If it has been connected to a PC/Host, disconnect the PC and connect the support tool (computer) to the NT600S, and then, transmit the screen data.

- Operation**
1. Connect the NT600S to the computer on which the support tool is being used, and turn ON the NT600S.
  2. Turn ON the computer and start up the support tool.
  3. Set the [Support Tool Mode] memory switch setting to match the support tool being used.

**Reference** By setting the Support Tool Mode to “NT600M”, the NT600S is made compatible with the existing NTM support tool. For details on setting the Support Tool Mode, refer to page 99.

4. Enter the “Transmit Mode” by operating the menu of the NT600S as mentioned below.

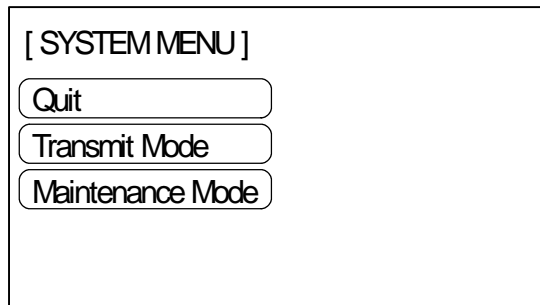

Select “Transmit Mode”.

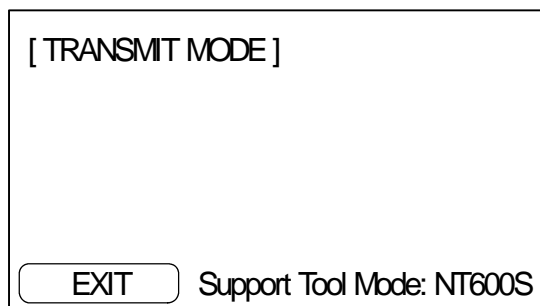

5. Select a screen data to be transmitted to the NT600S in the File Selection screen of the support tool, and press the Send key.
6. The NT600S will display the following screen when the screen data is being transmitted.

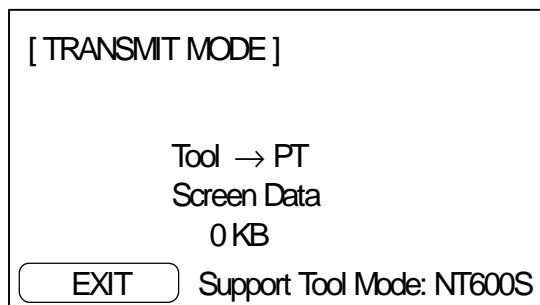

7. When the screen data transmission is completed, the support tool will display the following screen.

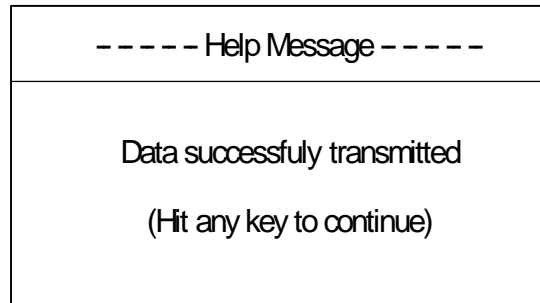

8. Press any key on the support tool to return to the File Selection screen.
9. Pressing the “EXIT” touch switch in the Transmit Mode screen of the NT600S will exit the Transmit Mode and enter the System Menu.

**Reference** Press the “EXIT” touch switch on the NT600S when the screen data transmission is completed. Unless this touch switch is pressed, the screen data will not be correctly registered. If the “EXIT” touch switch is pressed during transmission, the screen data will not be correctly registered.

If screen data cannot be transmitted from the support tool properly, check whether communication between the NT600S and support tool (personal computer) is normal.

To check communication with the support tool, use the “Tool Transmit” function in the maintenance mode of the NT600S. See “Checking the Communications with the Support Tool/Host” (page 105).

### Precautions to be Observed During the Screen Data Transmission

When any of the following or a system error occurs during the screen data transmission, the transmitted screen data will not be registered correctly to the NT600S. If an error message is displayed in the System Menu and the Transmit Mode cannot be selected, the screen data memory needs to be initialized.

- The power to the NT600S is interrupted or the NT600S is reset.
- The power to the computer on which the support tool is running is interrupted or the computer is reset.
- The cable connecting the NT600S to the computer on which the support tool is running is disconnected or has a broken wire.
- The Cancel touch switch on the NT600S screen is pressed to end the transmission during screen data transfer.
- The ESC key on the support tool is pressed to end the transmission.

When the power to the NT600S is turned ON or reset, the screen data is checked. However, if any of the above occurs during the screen data transmission, the screen may disappear and other unexpected problems may occur.

In the case of such problems, set DIP SW2-1 to ON to initialize the memory.

For the memory initialization by using the DIP switch, refer to the “Initialization by using the DIP switch” (page 74).



## 4-6 Setting the Conditions of Communications with the PC/Host by Using the Memory Switches

The communications between the NT600S and a PC/Host are called the host communications.

The NT600S can be connected to a PC/Host by the host link, NT link (1:1, 1:N), C200H direct, or RS-232C. The link can be selected by setting the memory switch. Also, the host link baud rate, automatic reset function, RS-232C communication conditions, etc. are set with the memory switches.

This section describes the communications condition settings by using the memory switches.

### Memory Switches

The NT600S has the memory areas used to store the PC/Host connection method, communications conditions, system settings, etc. which can be used as the switches and called the “memory switches”. Since the memory switches use the flash memory, the stored data can be held even when the power supply is turned OFF.

If for any reason the set memory switch data is destroyed, a message will be displayed on switching to the run mode. If this happens, press the [Write] touch switch to initialize the memory switches.

### Setting Functions and the Memory Switch Menu

The memory switches can be set easily by using the memory switch menu in the System Menu.

The functions that can be selected (memory switch menu) differ according to the communication method selected, as shown on the next page. For details on each function, refer to the next section onward and to 3-8 “Various System Settings” (page 93).

[MEMORY SWITCH MENU 1 (When LCD display screen is used.)]

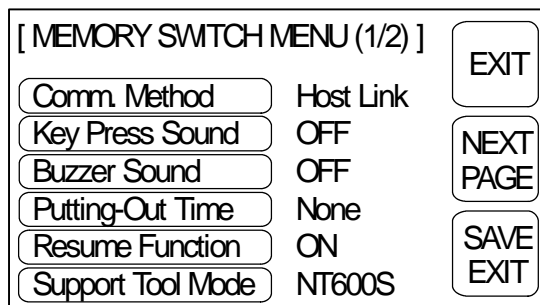

Comm. Method	Selecting the Host Communication Method (page 85)
Key Press Sound	3-8 Various System Settings (page 93)
Buzzer Sound	3-8 Various System Settings (page 94)
Putting-Out Time	3-8 Various System Settings (page 96)
Resume Function	3-8 Various System Settings (page 98)
Support Tool Mode	3-8 Various System Settings (page 99)

[MEMORY SWITCH MENU 2]

Host Link method

[ MEMORY SWITCH MENU (2/2) ]		EXIT
Automatic Reset	ON	PREV. PAGE
Host Link Speed	19200bps	
		SAVE EXIT

NT Link method (1:1)

[ MEMORY SWITCH MENU (2/2) ]		EXIT
Automatic Reset	ON	PREV. PAGE
		SAVE EXIT

NT Link method (1:N)

[ MEMORY SWITCH MENU (2/2) ]		EXIT
Automatic Reset	ON	PREV. PAGE
PT UNIT No.	7	
		SAVE EXIT

C200H direct method

[ MEMORY SWITCH MENU (2/2) ]		EXIT
Automatic Reset	ON	PREV. PAGE
		SAVE EXIT

RS-232C method

[ MEMORY SWITCH MENU (2/2) ]		EXIT
Automatic Reset	ON	PREV. PAGE
Data Bit Length	7bits	
Stop Bit Length	2bits	SAVE EXIT
Parity Bit	Odd	
Flow Control	XON/XOFF	
RS-232C Speed	19200bps	

- Automatic Reset      Selecting the Automatic Reset Function (page 90)
- Host Link Speed      Selecting the Host Link Communication Speed (page 86)
- PT UNIT No.          Setting the PT UNIT No. (page 87)
- Data Bit Length      Setting the RS-232C Communication Conditions (page 89)
- Stop Bit Length      Setting the RS-232C Communication Conditions (page 89)
- Parity Bit            Setting the RS-232C Communication Conditions (page 89)
- Flow Control         Setting the RS-232C Communication Conditions (page 89)
- RS-232C Speed      Setting the RS-232C Communication Conditions (page 89)

### 4-6-1      **Selecting the Host Communication Method**

The NT600S can be connected to a PC/Host by the host link, NT link (1:1, 1:N), C200H direct, or RS-232C. Either link can be selected by setting the “Comm. Method” memory switch. The factory setting has been made to the “Host link”.

Select the host communication method by the menu operation from the System Menu as mentioned below.

[ SYSTEM MENU ]
Quit
Transmit Mode
Maintenance Mode

Select “Maintenance Mode”.



[ MAINTENANCE MENU ]	
Quit	Display History
PT Setting Status	
I/O Check	
Memory Init.	
Memory Switches	

Select “Memory Switches”.



[ MEMORY SWITCH MENU (1/2) ]		EXIT
Comm. Method	Host Link	NEXT PAGE
Key Press Sound	OFF	
Buzzer Sound	OFF	SAVE EXIT
Putting-Out Time	None	
Resume Function	ON	
Support Tool Mode	NT600S	

Each time the “Comm. Method” touch switch is pressed, the setting option changes to the next item in the sequence “Host Link”, “NT Link”, “NT Link 1:N”, “RS-232C”.

When a C200H interface unit is connected, the setting is fixed as “C200H”.

To set and quit the menu, press the [SAVE EXIT] touch switch. To quit without setting, press [EXIT].

### 4-6-2 Baud Rate Selection (Host Link Only)

When using the host link, the baud rate for the communication method must be set. “9600 bps” or “19200 bps” can be selected.

The factory setting has been made at 9600 bps.

Select the baud rate of the communication with the PC by the menu operation from the System Menu shown below.

[ SYSTEM MENU ]
Quit
Transmit Mode
Maintenance Mode

Select “Maintenance Mode”.



[ MAINTENANCE MENU ]	
Quit	Display History
PT Setting Status	
I/O Check	
Memory Init.	
Memory Switches	

Select “Memory Switches”.



[ MEMORY SWITCH MENU (1/2) ]		EXIT
Comm. Method	Host Link	NEXT PAGE
Key Press Sound	OFF	
Buzzer Sound	OFF	SAVE EXIT
Putting-Out Time	None	
Resume Function	ON	
Support Tool Mode	NT600S	

Select "NEXT PAGE".  
If the communication method is not displayed as host link, press "Comm. Method" to select "Host Link".



[ MEMORY SWITCH MENU (2/2) ]		EXIT
Automatic Reset	ON	PREV. PAGE
Host Link Speed	19200bps	
		SAVE EXIT

Each time the "Host Link Speed" touch switch is pressed, the setting option "9600 bps" alternates with "19200 bps".

To set and quit the menu, press the [SAVE EXIT] touch switch. To quit without setting, press [EXIT].

### 4-6-3 Setting Unit Numbers (NT Link 1:N Only)

When using NT600S with the NT link (1:N) communication method, set unit numbers.

When using NT link (1:N), unit numbers are used to identify each of the multiple PTs connected to a single PC port. Set a different unit number for each of the PTs connected to the port.

The unit numbers that can be set differ in accordance with the type of host PC as follows.

- C200HE :Unit Nos. 0 to 3
- C200HG, C200HX :Unit Nos. 0 to 7

Set the unit numbers by following the menu operation from the System Menu described below.

[ SYSTEM MENU ]
Quit
Transmit Mode
Maintenance Mode

Select "Maintenance Mode".



[ MAINTENANCE MENU ]	
Quit	Display History
PT Setting Status	
I/O Check	
Memory Init.	
Memory Switches	

Select "Memory Switches".



[ MEMORY SWITCH MENU (1/2) ]		EXIT
Comm. Method	Host Link	NEXT PAGE
Key Press Sound	OFF	
Buzzer Sound	OFF	SAVE EXIT
Putting-Out Time	None	
Resume Function	ON	
Support Tool Mode	NT600S	

Press the "NEXT PAGE".  
If "NT link 1:N" is not displayed as the communication method, press "Comm. Method" to display it.



[ MEMORY SWITCH MENU (2/2) ]		EXIT
Automatic Reset	ON	PREV. PAGE
UNIT No.	7	
		SAVE EXIT

Repeatedly pressing the "UNIT No." touch switch cycles through the numbers that can be set.

To set and quit the menu, press the [SAVE EXIT] touch switch. To quit without setting, press [EXIT]. The run mode will be established.

### 4-6-4 Setting the RS-232C Communication Conditions

When connecting the NT600S to the host by the RS-232C method, set the following communication conditions.

Item	Setting	Factory-Setting
RS-232C Speed	2400/4800/9600/19200bps (to be set to the same value as set for the Host)	2400bps
Data bit length	7 bits/8 bits	8 bits
Stop bit length	1 bit/2 bits	1 bit
Parity bit	Even/odd/none	None
Flow control	RS/CS control XON/XOFF control None	None

Select the required menu option from the System Menu by following the procedure given below.

[ SYSTEM MENU ]

Quit

Transmit Mode

Maintenance Mode

Select "Maintenance Mode".



[ MAINTENANCE MENU ]

Quit      Display History

PT Setting Status

I/O Check

Memory Init.

Memory Switches

Select "Memory Switches".



[ MEMORY SWITCH MENU (1/2) ]

Comm. Method	RS-232C	EXIT
Key Press Sound	OFF	NEXT PAGE
Buzzer Sound	OFF	
Putting-Out Time	None	SAVE EXIT
Resume Function	ON	
Support Tool Mode	NT600S	

Press "NEXT PAGE".  
If the RS-232C has been selected, the host link speed setting does not make any effect.



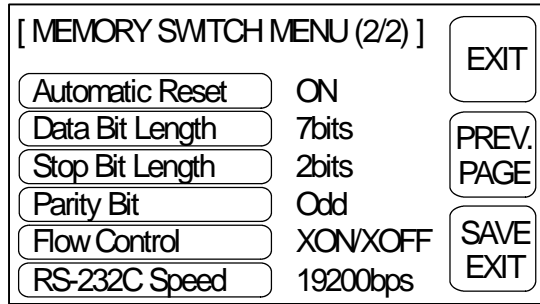

The setting changes when each of the touch switches is pressed are indicated below.

“Automatic Reset”	Alternates between “OFF” and “ON”
“Data Bit Length”	Alternates between “8 bits” and “7 bits”
“Stop Bit Length”	Alternates between “2 bits” and “1 bit”
“Parity Bit”	Changes among “None”, “Even” and “Odd”
“Flow Control”	Changes among “None”, “RS/CS” and “XON/XOFF”
“RS-232C Speed”	Changes among “2400 bps”, “4800 bps”, “9600 bps” and “19200 bps”

To set and quit the menu, press the [SAVE EXIT] touch switch. To quit without setting, press [EXIT].

#### 4-6-5 Selecting the Automatic Reset Function

The “Automatic Reset” memory switch in MEMORY SWITCH MENU 2 selects whether or not operation is automatically restarted after the occurrence of a communication error.

The factory setting for the automatic reset function is “OFF”.

Select whether the automatic reset function is off or on by operation from the System Menu as described below.

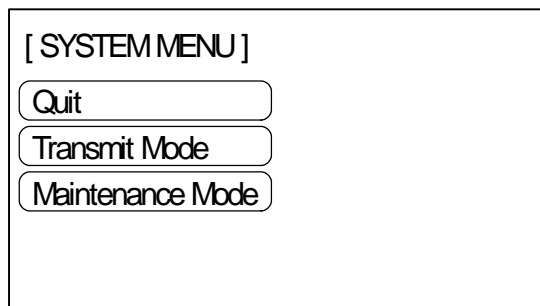

Select “Maintenance Mode”.





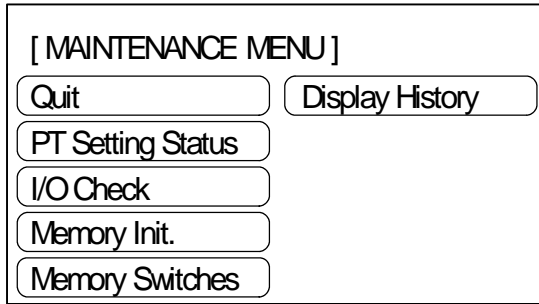

Select "Memory Switches".

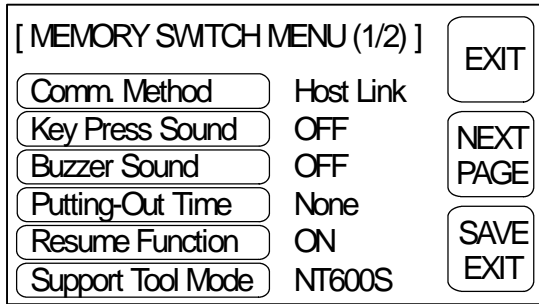

Select "NEXT PAGE".

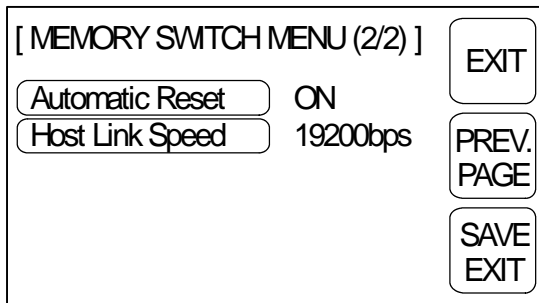

Each time the "Automatic Reset" touch switch is pressed, the setting option changes from "ON" to "OFF" or from "OFF" to "ON".

The menu display differs according to the communication method (see page 83).

To set and quit the menu, press the [SAVE EXIT] touch switch. To quit without setting, press [EXIT].

- "OFF": If a communication error has occurred, corresponding error message is displayed and the operation stops.
- "ON": If a communication error has occurred, corresponding error message will not be displayed and the operation will be automatically reset.

## 4-7 Starting the Operation

After completing the screen data transmission, connect the NT600S to the PC/Host and start the operation.

**⚠ Caution** Carefully check the operation of all screen data and host programs before using them. If incorrect, the system may operate unpredictably. Otherwise the system may operate unpredictably.

**Switching to the RUN mode** Press the Quit touch switch in the System Menu. The start-up screen in the RUN mode will be displayed.

---

**Note** If the NT600S has failed to start correctly; e.g., the start-up screen is not displayed, an error message is displayed, or the screen is not displayed at all, refer to Section 7-2 "Responding to Displayed Error Messages" (page 242) and take appropriate action.

---

**Reference** In the case of direct connection, the screen designated as "Screen Switch Setting" of the area by the PT status control at the start up is displayed as the start-up screen.

In the case of RS-232C, the start-up screen is designated when the screen data is created by using the support tool. If the start-up screen has not been designated, the screen with screen number 1 will be displayed. If no screen data has been registered at screen number 1, the "Specified Screen Cannot Be Saved." error message will be displayed. For the screen number setting, refer to Section 5-3 Screen Display (page 124).

---

### Confirming the Communications between the NT600S and the PC/Host

If RS-232C communication is used, confirm that communications are normally executed between the NT600S and the PC/Host using the RS-232C communication check function in the maintenance mode. Refer to "Checking the Communications with the Support Tool/Host" (page 105).

If the direct access is used, execute the PC/Host program and confirm that the following operations are normally performed.

- Confirm that the NT600S screens switch according to the PC/Host program execution.

If the screens do not switch correctly, check the connection between the NT600S and the PC/Host and also check the settings.

Refer to Section 2 Hardware Settings and Connections.

- Confirm that the information selected by the NT600S touch switches has been set in the PC/Host by displaying the contents of the words and bits using a peripheral tool (LSS etc.) or at the Host. If the information sent from the NT600S has not been correctly received by the PC, check the screen data settings (specifically the switch settings).

For the details of the screen data creation, refer to the NT-series Support Tool Operation Manual (V028-E1-01).

## 4-8 Various System Settings

The NT600S can set a variety of functions to the memory switches which are convenient during the operation. This section describes the memory switch settings related to the operation environment.

### 4-8-1 Setting the Key Press Sound

Whether or not the key press sound is given when the NT600S touch switch is pressed can be set with the memory switch.

The factory setting has been set to give the key press sound when the touch key is pressed.

Set the key press sound by the menu operation from the System Menu as mentioned below.

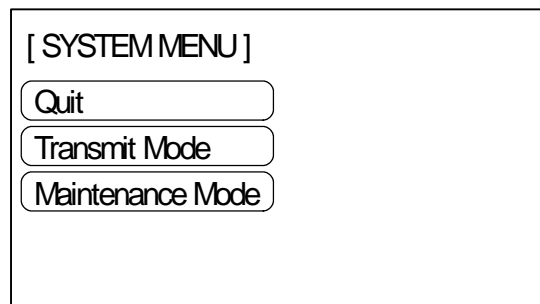

Select "Maintenance Mode".

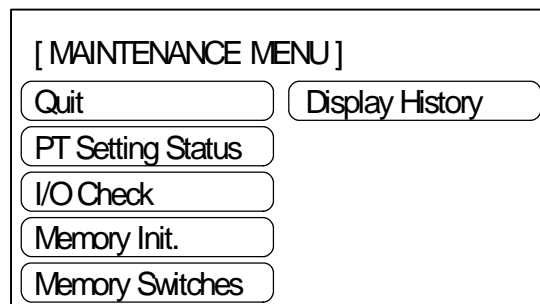

Select "Memory Switches".

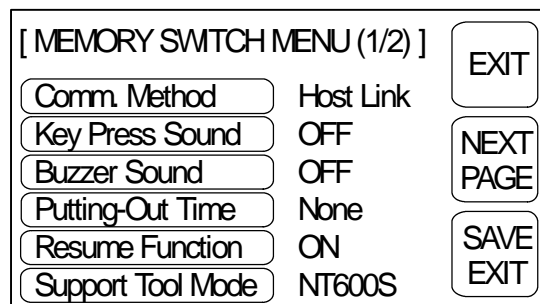

Each time the "Key Press Sound" touch switch is pressed, the setting option "ON" alternates with "OFF".

To set and quit the menu, press the [SAVE EXIT] touch switch. To quit without setting, press [EXIT].

- ON: The key press sound will be given for 0.2 second when a touch switch is pressed.
- OFF: The key press sound will not be given when a touch key is pressed.

## 4-8-2 Using the Buzzer

The NT600S can set a buzzer to indicate the occurrence of an emergency or an NT600S error.

### Setting the Buzzer

Except when the buzzer has been set so as not to sound at all, the buzzer will sound when an error occurs. The buzzer can be made to sound in other cases by using the two following methods.

- Sounding under control of the host (when using RS-232C communication)

It is possible to control the NT600S from the host to sound the buzzer during operation.

See “7-2 Commands Sent by the Host” (page 207).

- Set buzzer sounding as a screen data attribute with the support tool

When creating the screen data by using the support tool, set buzzer sounding as a screen attribute so that the buzzer will sound. When a screen for which this attribute has been set is displayed, the NT600S buzzer sounds.

If the control by the host and the display of the screen in which the buzzer attribute has been set are executed simultaneously, the priority is given to the control by the host. Refer to the NT-series Support Tool Operation Manual (V028-E1-□).

### To Stop the Buzzer Sound

The buzzer sound can be stopped by the following operation.

- Control by the Host
- Switch the screen to a screen which does not have a buzzer attribute.
- Press the touch switch to which the buzzer stop attribute has been set.

### Reference

If a buzzer stop attribute has been set to a touch switch created on the screen in which the buzzer attribute has been set, such touch switch can be used to stop the buzzer sound. For details on setting buzzer stop attributes to touch switches, refer to “Allocating of system key functions” (page 142).

**Types of the Buzzer Sounds** The following buzzer sounds can be set.

- Continuous sound: The buzzer continues to sound.
- Intermittent sound: The buzzer sounds intermittently at constant intervals.

**Reference** If both the continuous buzzer and the intermittent buzzer are instructed by the Host, the continuous buzzer will sound.

**Setting the Buzzer**

Use the memory switches to set whether or not the buzzer sounds when the buzzer sound has been instructed by the Host or with a screen attribute or when an error has occurred.

The factory setting has been made at “ON” so that the buzzer will sound when a command is received from the Host or when a screen attribute setting error has occurred.

Set the buzzer sound by the menu operation from the System Menu as mentioned below.

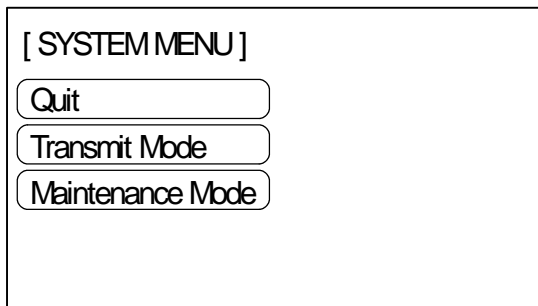

Select “Maintenance Mode”.

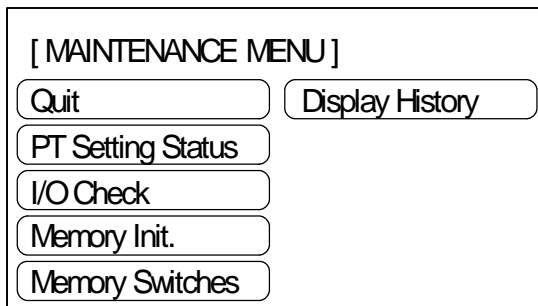

Select “Memory Switches”.

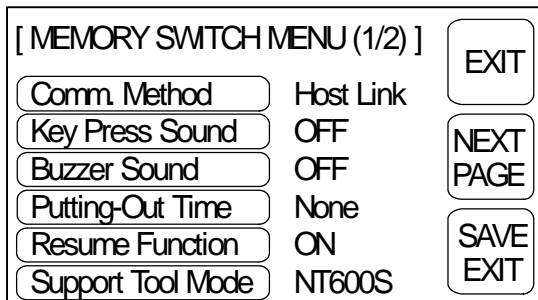

Repeatedly pressing the “Buzzer Sound” touch switch cycles through the setting options “ON”, “ERR ON”, and “OFF”.

To set and quit the menu, press the [SAVE EXIT] touch switch. To quit without setting, press [EXIT].

- When “OFF” is set, the buzzer does not sound during operation.
- ON: The buzzer will sound when a command from the Host is given, the screen attribute has been set, or an error has occurred.
- When “ERR ON” has been set, the buzzer will sound only when an error has occurred.

---

**Reference** The buzzer will sound when “Buzzer check” is selected in the Maintenance Mode regardless of the buzzer setting.

---

### 4-8-3 Backlight OFF / EL Screen OFF Function

The NT600S has a function that turns off the backlight of the LCD panel or turns off the EL screen if no operation is performed for a certain period of time in order to maximize the service life of the backlight and prevent the formation of an afterimage on the EL screen.

An afterimage may occur if the same screen contents are kept displayed for a long period. What is meant by “afterimage” is that previously displayed screen contents are not cleared and are left on the screen.

- Turning ON the Backlight / Redisplaying the Turned OFF Screen

When a touch switch on the NT600S is pressed, or when a screen is switched or redisplayed by the host after the backlight or EL screen has been switched OFF by the backlight OFF or EL screen OFF function, the backlight will turn on or the EL screen will be redisplayed. Changes of numerals or characters displayed on the screen will not cause the backlight to turn back on or the EL screen to be redisplayed.

- Setting the backlight OFF / EL screen OFF Function

Use the memory switches to set whether or not the backlight OFF function and EL screen OFF function are used, and the length of time that the backlight or the EL screen is turned off.

The factory setting specifies that the backlight or EL screen will turn off if no operation is performed for 10 minutes.

Set the backlight OFF function or EL screen OFF function by operation from the System Menu as described below.

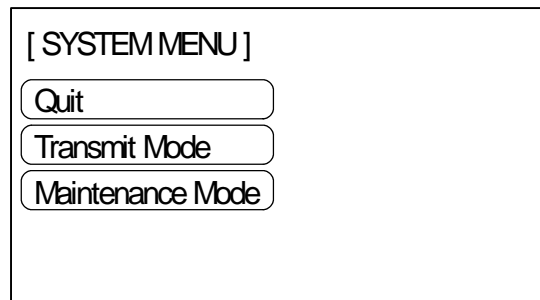

Select “Maintenance Mode”.



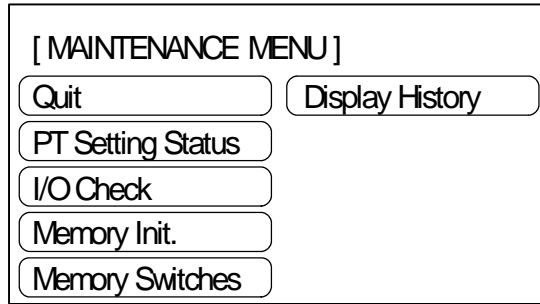

Select "Memory Switches".

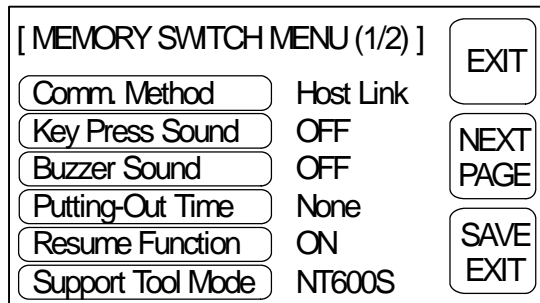

Each time the "Putting-Out Time" touch switch is pressed, the setting option will switch among "10 min", "1 hour", and "None".

To set and quit the menu, press the [SAVE EXIT] touch switch. To quit without setting, press [EXIT].

- When "None" is set, the backlight OFF/EL screen OFF function is not effective and the same screen will therefore remain displayed indefinitely even if no operation is performed.
- When "10 min" is set, the backlight or the EL screen will be turned off when no operation has been performed for 10 minutes.
- When "1 hour" is set, the backlight or the EL screen will be turned off when no operation has been performed for 1 hour.

**Caution** Do not press touch switches carelessly while the backlight is off or while nothing is displayed on the screen. Otherwise the system may operate unpredictably. Only press touch switches after confirming system safety.

**Note** Continuous display of the same pattern for an extended time (as a guide, about 1 hour) will lead to the formation of an afterimage. In order to prevent this, either periodically switch screens or use the EL screen OFF function.

### 4-8-4 Resume Function (Featured with Battery Unit Only)

The resume function is used to maintain the data contents of numeral/character-string memory tables when the power is switched off or the reset switch is pressed.

If the resume function is set "ON", the memory table is not initialized even when the power is switched off, the reset switch is pressed, or the mode is changed from the system menu to the transmit mode.

It is possible to redisplay the screen contents displayed before switching off the power when restarting the operation next using the values stored to the memory table before the switching off of the power.

The memory table is always initialized disregarding of the ON or OFF setting of the resume function if the memory table is initialized using the "Memory Init." of the MAINTENANCE MENU. For the procedure for initializing the memory table, refer to Initialization of the Memory Tables (page 75).

**Reference** The resume function can be used only when an optional battery unit is installed. However, if the battery voltage is low, the contents of the memory table cannot be retained even when the resume function is set "ON".

Whether or not the resume function is used is set by the Memory Switch.

The factory setting for the resume function is "OFF".

Select the setting for the resume function by the menu operation from the System Menu shown below.

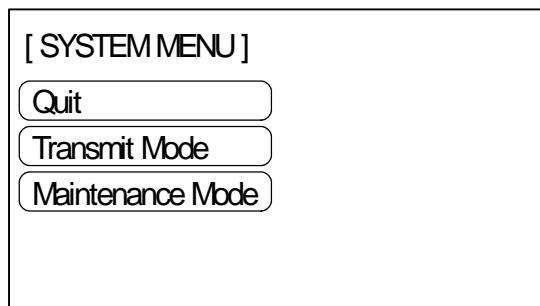

Select "Maintenance Mode".

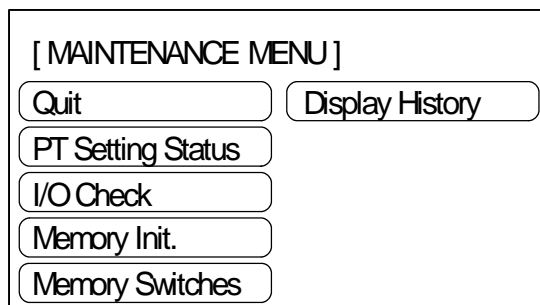

Select "Memory Switches".





[ MEMORY SWITCH MENU (1/2) ]		EXIT
Comm. Method	Host Link	NEXT PAGE
Key Press Sound	OFF	
Buzzer Sound	OFF	SAVE EXIT
Putting-Out Time	None	
Resume Function	ON	
Support Tool Mode	NT600S	

Each time the “Resume Function” touch switch is pressed, the setting option changes from “ON” to “OFF” or “OFF” to “ON”.

To set and quit the menu, press the [SAVE EXIT] touch switch. To quit without setting, press [EXIT].

- When “OFF” is set, the resume function is ineffective, and the memory tables are initialized when the NT600S is switched ON or reset, and on switching to the run mode. When new memory table data (initial settings) is transmitted from the support tool, the contents of the memory tables are also updated.
- When “ON” is set, the resume function is effective, and even when the NT600S is switched ON or reset, or switched to the run mode, the memory tables retain their existing data.

When NT600S operation starts, the contents of the memory tables are also written to the allocated words at the host. In addition, when new memory table data (initial settings) is written from the support tool, the initial settings are updated, but the memory tables themselves retain their original contents. To initialize with new initial settings, carry out memory table initialization (page 75).

#### 4-8-5 Setting the Support Tool Mode

By setting the “Support Tool Mode” to “NT600M”, the NT600S can be used in the same way as the existing NT600M model, and is made compatible with the NT20M/NT2000M/NT600M support tool (Ver.4).

However, the following restrictions apply when the “NT600M” setting option is selected.

- Version 5 of the direct connection function cannot be used.
- The “PT type” setting must be set to “NT600M”.
- High-speed transmissions with respect to the support tool are not possible.
- Transmissions consisting of direct information only are not possible.
- When screen data transmission is in screen units, simultaneous transmission of multiple screens is not possible. An attempt to transmit multiple screens may destroy the screen data.
- When screen data transmission is in screen units, transmission with verification set is not possible.
- Before transmitting data in file units, the screen data memory must be initialized.
- It is not possible to create screen data for RS-232C communication.

Starting from the system menu, make the following menu selections to set the Support Tool Mode.

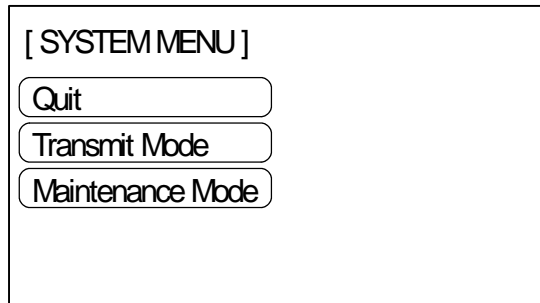

Select "Maintenance Mode".

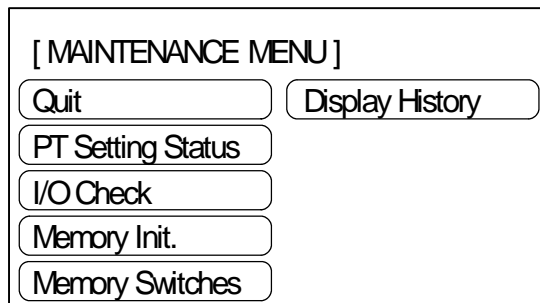

Select "Memory Switches".

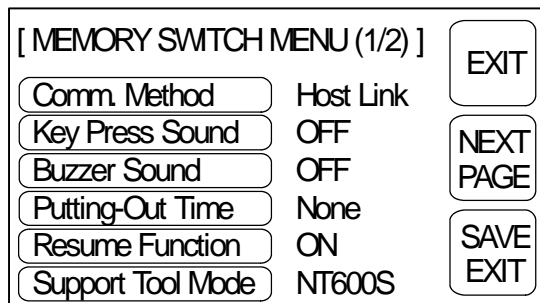

Each time the "Support Tool Mode" touch switch is pressed, the setting option changes from "NT600S" to "NT600M" or from "NT600M" to "NT600S".

To set and quit the menu, press the [SAVE EXIT] touch switch. To quit without setting, press [EXIT].

- When "NT600M" is set, the NT600M compatible mode is established and the NT600S can be used as if it were an NT600M.
- When "NT600S" is set, the NT600S can be used as an NT600S.

## 4-9 System Maintenance

The NT600S has the self maintenance functions such as I/O check and setting status check.

### 4-9-1 I/O Check

The I/O operations for the following items of the NT600S are checked by the I/O check function.

- LED
- Buzzer
- Touch Switch
- LCD/EL
- Backlight
- Communication I/F
- DIP-Switch

#### Checking the LED

Check the LED by using the menu operation from the System Menu as mentioned below.

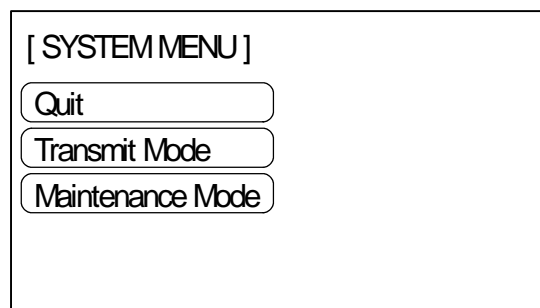

Select "Maintenance Mode".

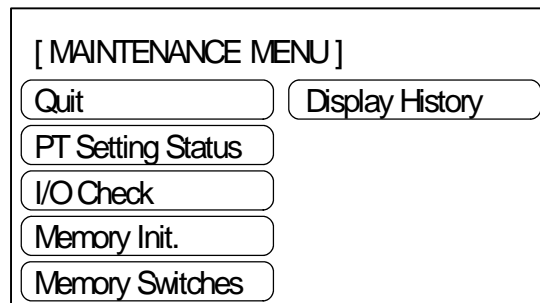

Select "I/O Check".

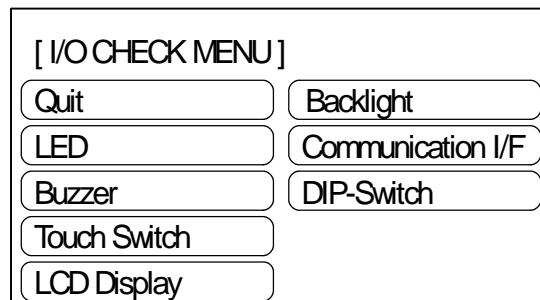

Select "LED".

The "RUN" LED on the front face of the NT600S will flash. The "POWER" LED remains lit.

- To quit the LED check, press the "EXIT" touch switch. The I/O Check Menu will be redisplayed.

**Checking the Buzzer**

Check the NT600S buzzer by using the menu operation from the System Menu as mentioned below.

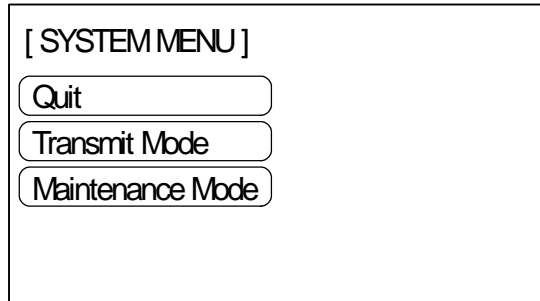

Select "Maintenance Mode".

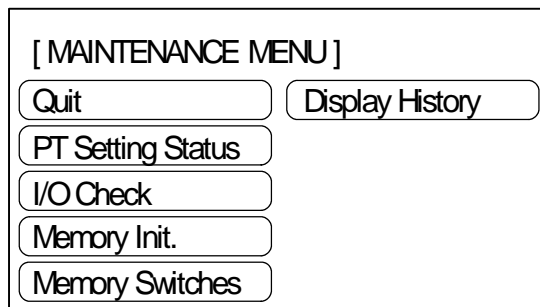

Select "I/O Check".

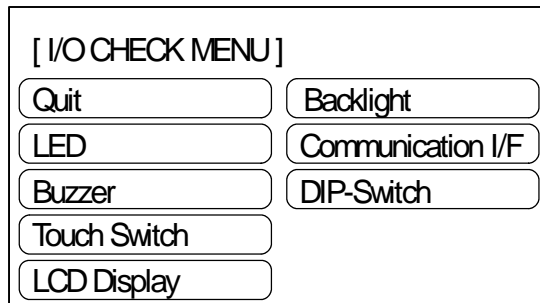

Select "Buzzer".

- If the buzzer function is normal, the continuous buzzer sound will be made.
- To stop the buzzer, press "EXIT" in the buzzer check screen.

---

**Reference** Though memory switch setting for the buzzer has been made for OFF, the buzzer will sound when the buzzer check is executed.

---

**Checking the Touch Switches**

Execute a touch switch check by the menu operation from the System Menu as mentioned below.

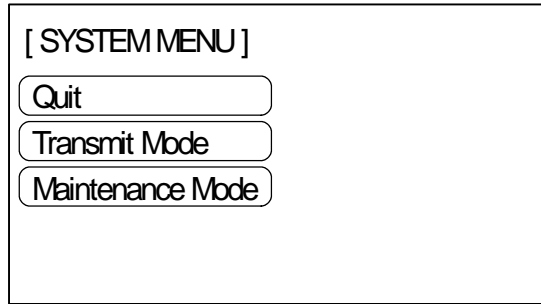

Select "Maintenance Mode".

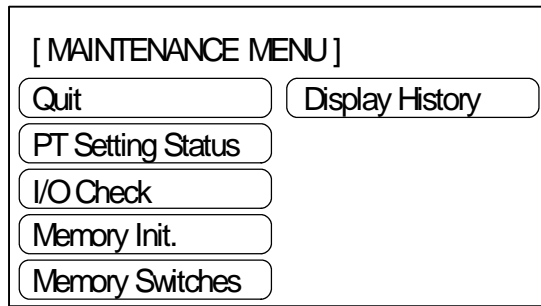

Select "I/O Check".

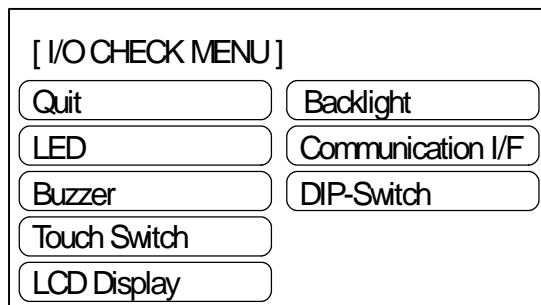

Select "Touch Switch".

A panel of 8-row x 16-column touch switches, each switch sized 39 dots x 49dots cm, will be displayed.

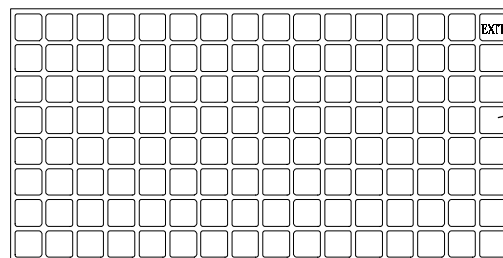

"EXIT" switch to exit the touch switch check menu.

The touch switch is normal if it is highlighted while it is pressed.

- Press a touch switch on the screen. If the touch switch is highlighted while it is pressed, the touch switch is normally functioning.
- When the check is finished, press the "EXIT" touch switch. The I/O check menu will be redisplayed.

**Reference** If memory switch setting for the key press sound has been made for ON, the key press sound will be made when a touch switch is pressed. The number of pressed touch switch will not be notified to the PC/Host.

**Checking the LCD/EL display**

Check the NT600S LCD/EL display by using the menu operation from the System Menu as mentioned below.

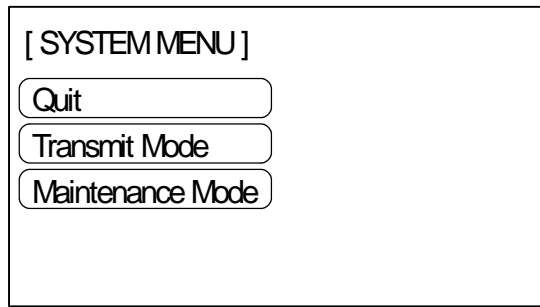

Select "Maintenance Mode".

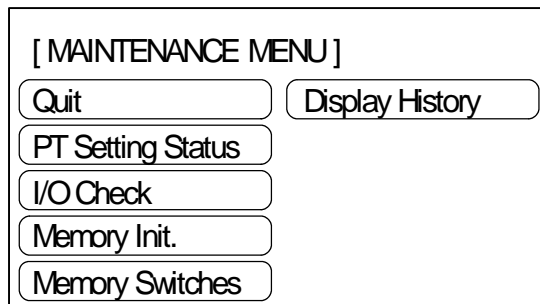

Select "I/O Check".

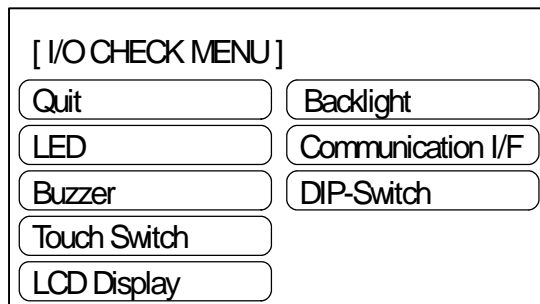

Select "LCD" or "EL".

- The LCD/EL displays dots (segments of the screen) line by line beginning with the top left corner. When all dots are normally displayed, the I/O Check Menu will be redisplayed.
- To cancel the LCD/EL indication check, press any touch switch (anywhere) on the screen. The I/O Check Menu will be redisplayed.

**Checking the Backlight (NT600S-ST121 Only)**

Check the Backlight by using the menu operation from the System Menu as mentioned below.

[ SYSTEM MENU ]
Quit
Transmit Mode
Maintenance Mode

Select "Maintenance Mode".



[ MAINTENANCE MENU ]	
Quit	Display History
PT Setting Status	
I/O Check	
Memory Init.	
Memory Switches	

Select "I/O Check".



[ I/O CHECK MENU ]	
Quit	Backlight
LED	Communication I/F
Buzzer	DIP-Switch
Touch Switch	
LCD Display	

Select "Back light".

- When the backlight is operating correctly, it should flash.
- To end the check function, press the [EXIT] touch switch. The NT600S returns to the "I/O Check Menu".
- The EL type does not feature the backlight check function.

### Checking the Communications with the Support Tool/Host

Execute a NT600S-to-support tool/Host communication check by the menu operation from the System Menu as mentioned below.

This check can be executed only for RS-232C communications.

In direct connection other than the C200H communications, the same connector is used for the connection of a support tool and the Host. To execute communication check with the support tool, if the Host is connected to the NT600S, first disconnect the cable that connects the Host and connect the support tool to the same connector. Execute the check after that.

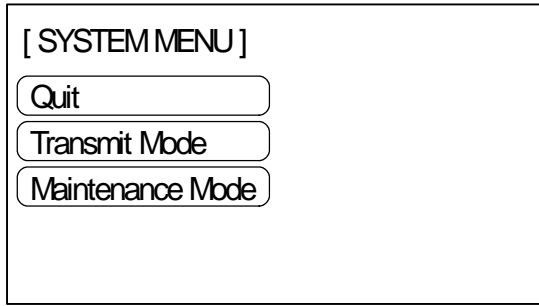

Select "Maintenance Mode".

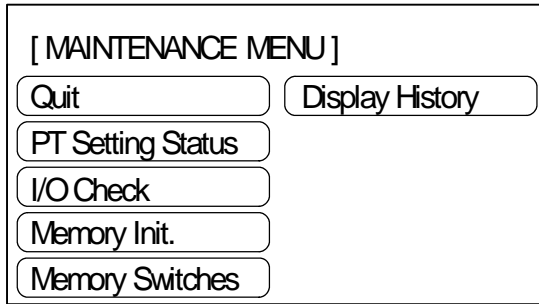

Select "I/O Check".

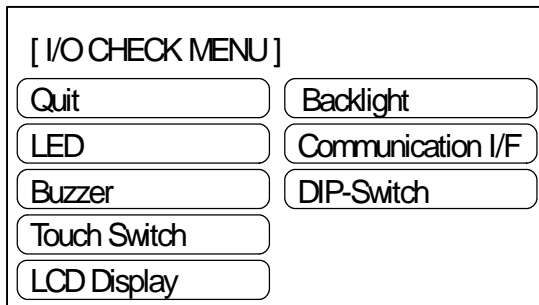

Select "Communication I/F".

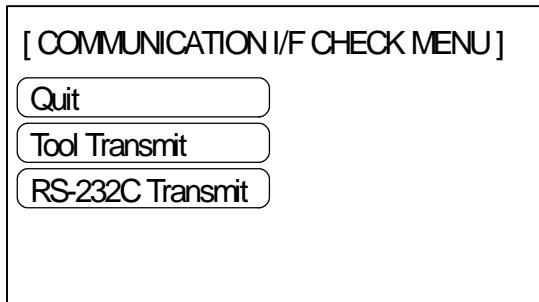

Select "Tool Transmit" or "RS-232C Transmit".

(Select "Tool Transmit")





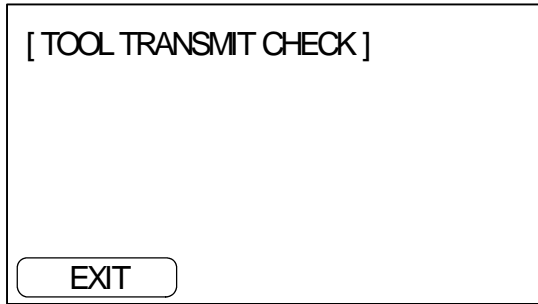

- The data received from the connected support tool/Host are displayed in hexadecimal numbers.
- When the check is finished, press the “EXIT” touch switch. Communication I/F check menu will be redisplayed.

**Note**

The NT600S uses one connector for connection to both the Support tool and the PC/Host. If it is connected to other equipment, remove the connecting cable from the connector and connect the cable to the connector for the Support tool/Host. Then perform a communication check.

**4-9-2 Checking the NT600S DIP Switch Settings**

Display the NT600S DIP switch settings by using the menu operation from the System Menu as mentioned below.

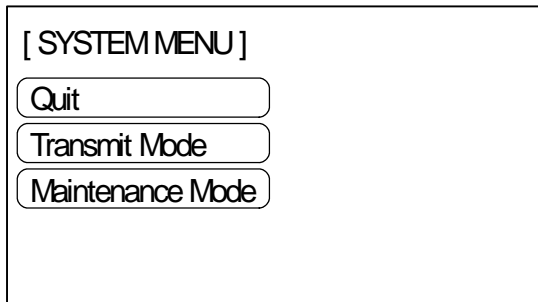

Select “Maintenance Mode”.

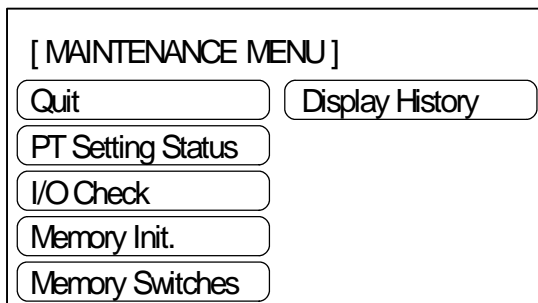

Select “I/O check”.



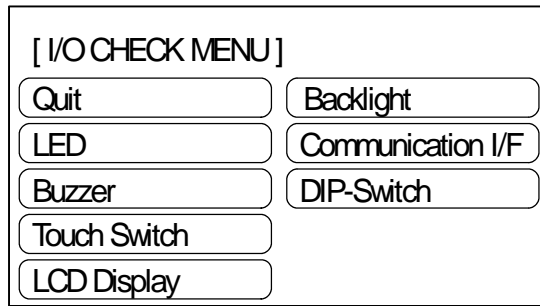

Select "DIP-Switch".

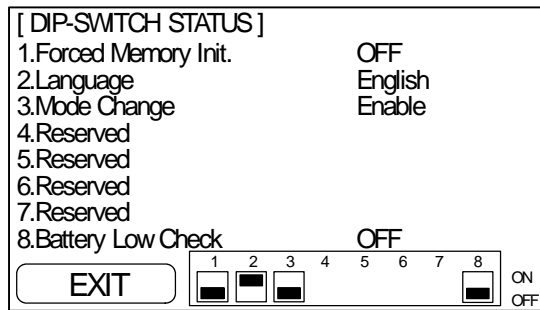

The NT600S DIP switch statuses are displayed.

- To exit the DIP switch settings display, press the "EXIT" touch switch.

**Note**

If the DIP switch settings have been changed when the NT600S is powered, reset the power to the NT600S. The changes with the DIP switches become effective only after the power supply is reset.

### 4-9-3 Checking the PT Setting Status

#### Checking the PT setting Status

Display the NT600S settings by using the menu operation from the System Menu as mentioned below.

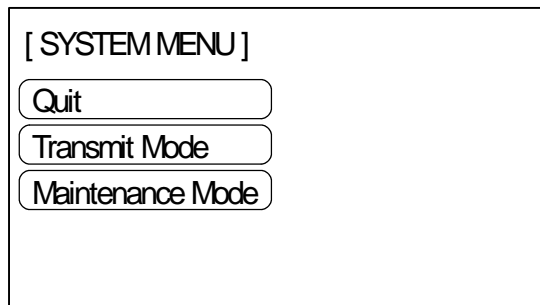

Select "Maintenance Mode".



[ MAINTENANCE MENU ]

Quit      Display History

PT Setting Status

I/O Check

Memory Init.

Memory Switches

Select "PT Setting Status".



<Host link>

[ PT SETTING STATUS ]

Communication Method	Host Link
PT Control Area	DM0010
PT Notification Area	DM0020
Automatic Reset	OFF
Resume Function	OFF
Host Link Speed	19200bps

EXIT

<NT link (1:1)>

[ PT SETTING STATUS ]

Communication Method	NT Link
PT Control Area	DM0010
PT Notification Area	DM0020
Automatic Reset	OFF
Resume Function	OFF

EXIT

<NT link (1:N)>

[ PT SETTING STATUS ]

Communication Method	NT Link (1:N)
PT Control Area	DM0010
PT Notification Area	DM0020
Automatic Reset	OFF
Resume Function	OFF
PT UNIT No.	7

EXIT

\* If no unit is set at the PC, "0" will be displayed.

<C200H direct communication>

[ PT SETTING STATUS ]

Communication Method	C200H
PT Control Area	DM0010
PT Notification Area	DM0020
Automatic Reset	OFF
Resume Function	OFF
UNIT No.	9

EXIT

<RS-232C>

[ PT SETTING STATUS ]

Communication Method	RS-232C
Automatic Reset	ON
Resume Function	ON
Data Bit Length	7 bits
Stop Bit Length	1 bit
Parity Bit	Even
Flow Control	XON/XOFF
RS-232C Speed	2400bps

EXIT

\* If no unit is set at the PC, "0" will be displayed.

- The current NT600S setting status will be displayed.
- Pressing the [EXIT] touch switch will exit the "PT Setting Status 1" display and cause the NT600S to return to the "Maintenance Menu".

## 4-9-4 Display History

The display history function records the number of times that screens for which a display history attribute has been set by the support tool are displayed, and displays the accumulated occurrence data either in order of occurrence or order of frequency format.

- Recording the Display History

The display history is recorded using the procedure given below.

**Operation** 1. Setting the screen attribute

When creating a screen using the support tool, set the display history recording attribute for the screen if its display history should be recorded. When setting the attribute, register a message no longer than 24 characters expressing the contents of the screen.

A display history is recorded only for screens for which the display history recording attribute is set.

2. Initializing the display history data memory

Before starting to record the display history, initialize (clear) the display history data memory either by sending the display history data memory initialization command from the Host (page 76) or by selecting the "Screen Data Memory" initialization menu in the Maintenance Mode (page 72).

If the memory becomes full of history data, the history data for new occurrences cannot be recorded.

3. Executing the display history recording

If a screen for which the display history recording attribute has been set is displayed during operation, the display history data is recorded in the NT600S.

- In the display history, the following data relating to the displayed screen is stored in the memory.
  - Screen number
  - Message expressing the contents of the screen

Each time a screen number for which the display history recording attribute has been set is specified by the PC/Host, the data indicated above is recorded in the corresponding data area.

The data recording capacity is 1023 screens if the display history is recorded in the order of occurrence and 255 times per screen if it is recorded in the order of frequency. Note that only the screen number and the message are recorded.

---

**Reference** The recorded data is retained even when the power is turned off since it is backed up by battery. However, if no battery is installed, the recorded data is lost when the power is turned off.

---

- Reading the Recorded Display History

Before starting to record the display history, initialize (clear) the display history data memory, either by sending the display history data memory initialization command from the Host (page 76) or selecting “Screen Data Memory” initialization menu in the Maintenance Mode (page 72).

If the memory becomes full of history data, the history data for new occurrences cannot be recorded.

Display the recorded display history using the following menu operation starting from the System Menu.

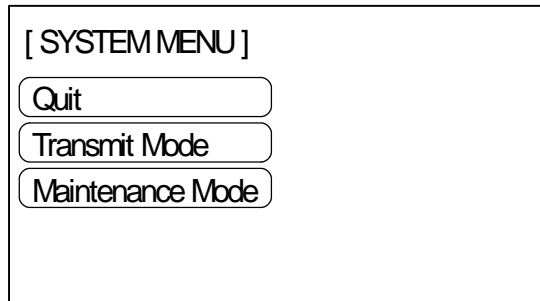

[ SYSTEM MENU ]

Quit

Transmit Mode

Maintenance Mode

Select “Maintenance Mode”.

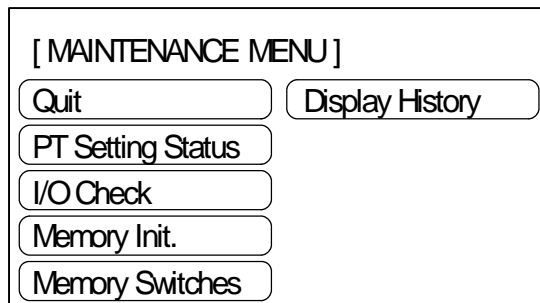

[ MAINTENANCE MENU ]

Quit

Display History

PT Setting Status

I/O Check

Memory Init.

Memory Switches

Select “History Display”.

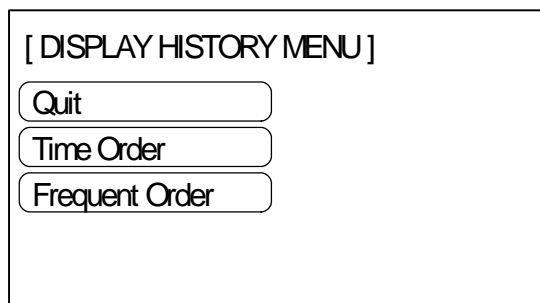

[ DISPLAY HISTORY MENU ]

Quit

Time Order

Frequent Order

Select either “Time Order” or “Frequent Order”.

- Display in time order

The recorded display history is displayed in the order the screens were displayed.

No.	Freq.	Message	No.	Freq.	Message
24	( )	Workpiece misalignment A.2			
24	( )	Workpiece misalignment A.2			
4	( )	Valve abnormality			
26	( )	Workpiece misalignment B.1			
25	( )	Workpiece misalignment A.3			
35	( )	Frequent stop			
26	( )	Workpiece misalignment B.1			
35	( )	Frequent stop			
26	( )	Workpiece misalignment B.1			
26	( )	Workpiece misalignment B.1			
35	( )	Compressor pressure upper limit			
35	( )	Compressor pressure upper limit			
4	( )	Valve abnormality			
23	( )	Workpiece misalignment A.1			
25	( )	Workpiece misalignment A.3			
35	( )	Frequent stop			

Page. 1/1

Screen number

- Up to 40 items of recorded data are displayed in one screen.
- If the recorded data cannot be displayed in one screen, it is possible to scroll the screen by pressing the [NEXT] or [PREV.] touch switch.

**Reference** If there is no display history recorded, the following message is displayed.  
 “Display History not Found”

- Pressing the [EXIT] touch switch causes the NT600S to return to the “Display History Menu”.
- If the display history is displayed in time order (order of occurrence), the display frequency data is not displayed.

- Display in frequent order

No.	Freq.	Message	No.	Freq.	Message
26	( 4 )	Workpiece misalignment B.1			
35	( 3 )	Frequent stop			
4	( 2 )	Valve abnormality			
35	( 2 )	Compressor pressure upper limit			
24	( 2 )	Workpiece misalignment A.2			
25	( 2 )	Workpiece misalignment A.3			
23	( 1 )	Workpiece misalignment A.1			

Page. 1/1

Frequency data

Screen number

- If the same message appears more than once, the message is displayed in ascending order of the screen numbers.
- Up to 40 items of recorded data are displayed on one screen.
- If the recorded data cannot be displayed on one screen, scroll the screen by pressing the [NEXT] or [PREV.] touch switch.

**Reference** If there is no display history recorded, the following message is displayed.  
 “Display History not Found”

- Pressing the [EXIT] touch switch will cause the NT600S to return to the “Display History Menu”.

## SECTION 5

# NT600S Functions

This section describes the functions of the NT600S.

5-1	Creating and Transmitting Screen Data .....	114
5-1-1	Setting the Support Tool for Use with the NT600S .....	114
5-1-2	Creating Screen Data .....	115
5-2	Outline of Functions .....	119
5-2-1	NT600S Screen .....	119
5-2-2	Characters and Figures Which can be Displayed .....	120
5-2-3	Communication with the Host .....	122
5-3	Screen Display .....	124
5-3-1	Classification of Screens .....	124
5-3-2	Screen Attributes .....	126
5-4	Memory Tables .....	128
5-4-1	Character-String Memory Table .....	128
5-4-2	Numeral Memory Table .....	129
5-5	Bar Graphs .....	131
5-5-1	Bar Graph Functions .....	131
5-6	Lamps .....	135
5-6-1	Lamp Functions .....	135
5-7	Touch Switches .....	138
5-7-1	Functions of Touch Switches .....	139
5-7-2	Standalone Function .....	141
5-7-3	System Key Functions .....	142
5-8	Numeral Setting .....	143
5-8-1	Function of Numeral Keys .....	143
5-8-2	Types of Numeral Setting .....	144
5-8-3	Creating Numeric Keys .....	146
5-8-4	Using Numeric Keys .....	148
5-8-5	Using Thumb Wheel Keys (Only When Direct Connection Ver.5 is Specified) ..	150

## 5-1 Creating and Transmitting Screen Data

This section describes briefly the support tool settings required for creating screen data and the screen data creation procedure.

**Reference** For the details of the support tool and screen data creation, refer to the "NT-series Support Tool Operation Manual" (V028-E1-01).

### 5-1-1 Setting the Support Tool for Use with the NT600S

To create the screen data for the NT600S, make settings with the support tool for use with the NT600S.

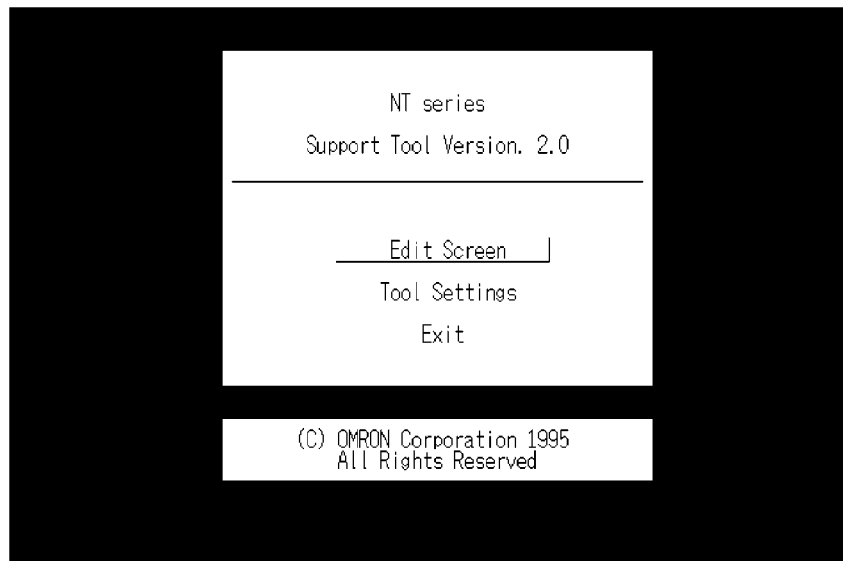

Select "Tool Settings".

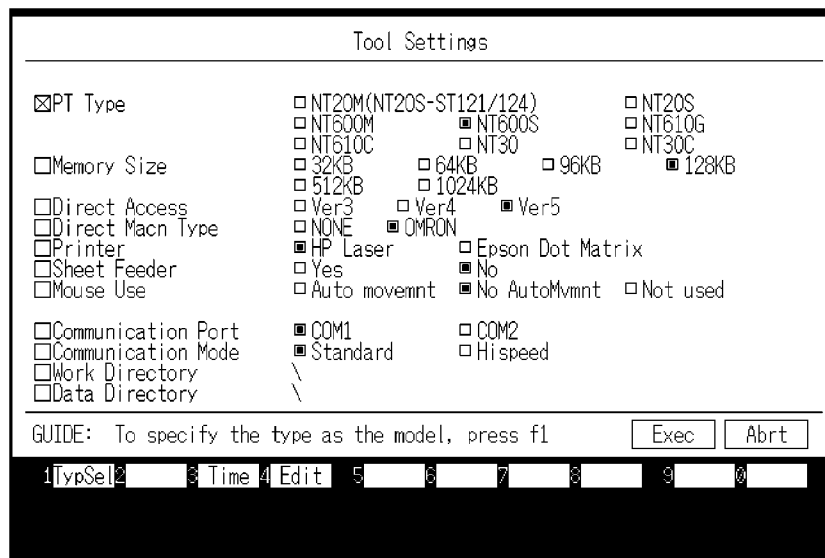



<b>Note</b>	To create the NT600S screen data, make settings in the “Tool Settings” screen as follows. PT Type :NT600S Memory Size :128 KB Direct Access :When using Host link/NT link/C200H direct communication: Ver.4 or Ver.5. When using RS-232C: “None” Direct Macn Type:OMRON
-------------	---

## 5-1-2 Creating Screen Data

**Screen Data Creation Method** The screen data is created by using the support tool. The support tool registers the screen data used with one NT600S to one file.

Screen data can be created by one of the following three methods:

- creating a new file;
- editing an existing file;
- reading and editing selected screens from an existing file.

### Screen Data Creation Procedure

The following gives the basic screen data creation procedure. Required settings and reference pages are given for each step of the procedure.



- ➔ Select “Tool Settings” in the Main Menu to display the “Tool Settings” screen. Settings of PT type, memory size, direct connection are made in this screen. Refer to “Setting the support tool for use with the NT600S” on the previous page.



Select "Edit Screen".

FileName	Title
NEW_FILE	Creation of New File
INPT_SCR	For Line Input
PROC_B	Process control backup
PROC_C	Production Qty Check
SAMPLE	
LINE_A	Process control Line A
INPT_SCR	For Line Input
PROC_B	Process control backup
PROC_C	Production Qty Check
PROC_CTL	For process A

➔ Select a file used for storing the screen data for the NT600S in the "File List" screen.

To create a new file, select "New File".

To edit an existing file, select a file to edit.

Select "New File" and press [Enter]. Enter filename on completion of creation.



Select "Screen Creation".

No.	Status	Comment
1		
2		
3		
4		
5		
6		
7		
8		
9		
10		
11		
12		
13		
14		
15		
16		

Select a screen number to edit in the selected file in the "Screen List" screen.

To read the screen data from other file, press the [F5] (Read) function key.

When using host link/NT link/C200H direct communication, set the direct connection information before selecting the screen number.

➔ While in the "Screen List" screen, press the [F10] (Next page) key, and then, the [F4] (Direct) key to display the "Direct Connection Data Setting" window in which the head words in the PC used to allocate the following areas.

- PT status control area: Section 5-4 NT600S Status Control (page 192)
- PT status notify area: Section 5-5 Notification of the Operating Status to the PC (page 197)
- Numeral memory table: 5-2 Memory Tables and Bar Graph (page 164)
- character-string memory table: 5-2 Memory Tables and Bar Graph (page 164)



Select a screen number and press [Enter].

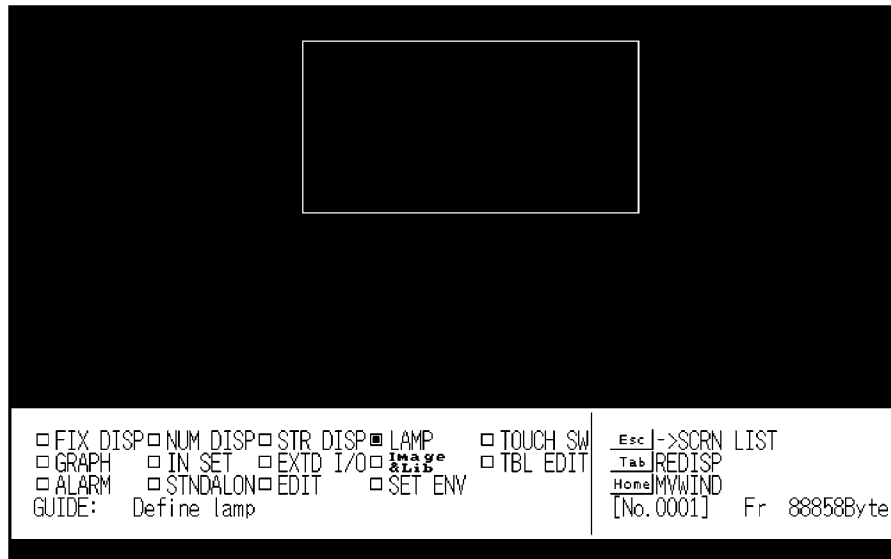

Create screen data in the Edit screen of the support tool. Data of one screen can be created by registering (laying out) the following display elements and attributes on the screen.

- Numeral display:  
Set numbers in the numeral memory table. .... "Numeral Memory Table" (page 129)
- Character-string display:  
Set numbers in the character-string memory table. .... "Character-String Memory Table" (page 128)
- Lamp:  
Host link/NT link/C200H direct ..... Specify allocated bits.  
RS-232C ..... Specify lamp address. .... Section 4-6 Lamps (page 135)
- Touch switch:  
Host link/NT link/C200H direct  
..... Specify allocated bits for control and notification.  
RS-232C ..... Specify touch switch number. .... Section 4-7 Touch Switches (page 138)
- Bar graph:  
Set numbers in the numeral memory table. .... Section 4-5 Bar Graphs (page 131)
- Numeral setting:  
Set numbers in the numeral memory table. .... Section 4-8 Numeral Setting (page 143)
- Character input: Input fixed character-strings.



[Exiting the Edit screen]

Return to the "Screen List".

No.	Status	Comment
1	B F !	Display1
2	B D F !	Display2
3		
4		
5		
6		
7		
8		
9		
10		
11		
12		
13		
14		
15		
16		



[To the File Selection]

Enter filename to newly created screen data.

Return to the "File List".

FileName	Title
NEW_FILE	Creation of New File
SAMPLE	
INPT_SCR	For Line Input
PROC_B	Process control backup
PROC_C	Production Qty Check
LINE_A	Process control Line A
INPT_SCR	For Line Input
PROC_B	Process control backup
PROC_C	Production Qty Check
PROC_CTL	For process A

Pressing the [F8] (Start-up screen) key allows setting of the screen number to be displayed when the NT600S is booted. (Only effective when using RS-232C)

**Transmitting Screen Data to the NT600S**

Transmit the screen data created by using the support tool to the NT600S screen data memory.

Connect the NT600S to the support tool and set the NT600S to Transmit Mode. Then, press the [F6] (Transmit) key in the "File List" screen to transmit the created screen data to the NT600S.

It is also possible to transmit the data in screen units by pressing [F10] (Next), then [F6] (Transmit) on the "Screen List" screen. However, the memory table data and direct information are not transferred when this function is used. Use the transmission screen to change and add this information and transmit it with the other information.

For the connection procedure to the support tool, refer to Section 2-3 Connecting to the Support Tool (page 30). For the transmission of the screen data, refer to Section 3-5 Registering the Screen Data (page 79).

**⚠ Caution** When transferring the data in units of screens, if there are changes in memory table and/or direct connection, transfer such data along with the screen data. Otherwise the system may operate unpredictably.

## 5-2 Outline of Functions

### 5-2-1 NT600S Screen

This section gives the outline of the screen which is the basis of all NT600S functions.

For specific operation procedure using Host/NT link or C200H direct such as screen switching, refer to Section 4-3 Screen Display" (page 124).

For actual operations such as displaying the specified screen using RS-232C, refer to Section 6-2 Commands Sent by the Host (page 207).

**Composition of the Screen** The NT600S screen is composed of horizontal 640 dots x vertical 400 dots. Each dot is set by the combination of the X (horizontal) and Y (vertical) coordinates. The origin of coordinates (0, 0) is set at the top left corner of the screen.

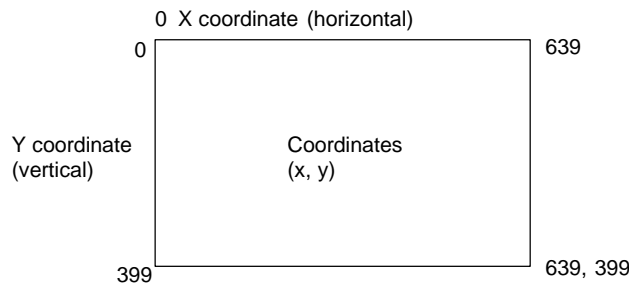

#### Screen Management

The screens displayed on the NT600S are managed by the screen numbers.

Screen numbers are set when the screen data are created by using the support tool. Up to 1000 screens can be set by allocating arbitrarily selected numbers 1 to 1000.

The display screens can be switched or the start-up screen can be set by designating the screen number from the PC/Host.

#### Special Screen Number

Screen number "0" is reserved for the system as the no-display screen. Select this to display nothing on the NT600S screen

## 5-2-2 Characters and Figures Which can be Displayed

The NT600S screen can display characters, figures, and other various elements.

This section describes the types and attributes of the characters and figures which can be displayed and do not need to be changed at all.

For the settings, display, and use of the characters, numeric values, and graphs which change according to the system operation status and other conditions, refer to Section 4-4 Memory Table (page 128) and Section 5-2 Memory Tables and Bar Graph (page 164).

The power of expression of the screen can be increased by giving various attributes such as the enlarged or reverse display to the characters and figures.

The character and figure attributes can be set in the edit screen when creating the screen data by using the support tool.

When displaying the characters using a command from a Host, character attributes are displayed in accordance with the enlarged size, which is obtained by executing the command, and the display attribute.

### Types and Attributes of Characters and Figures

The following types of characters can be input by using the support tool and be displayed during operation.

Character Type	Dots (vertical x horizontal)	Character Set	Maximum Number of Characters Displayed in One Screen (without overwriting)
Half height character	8 x 8	Alphanumerics and symbols	80 characters x 50 lines (4000 characters)
Normal characters	8 x 16	Alphanumerics and symbols	80 characters x 25 lines (2000 characters)
Marks	16 x 16	Create by using the support tool	

When displaying characters by sending a command from a Host, only half size characters and normal size characters can be displayed.

- Marks

A mark is a graphic pattern created by combining 16 x 16 dots by using the support tool. Marks can be handled the same as the wide size characters. Up to 64 patterns can be defined within the total screen area using 2-byte codes (FF20 to FF5F).

- Enlarged display of the characters and marks

The characters and marks can be enlarged to the following scales.

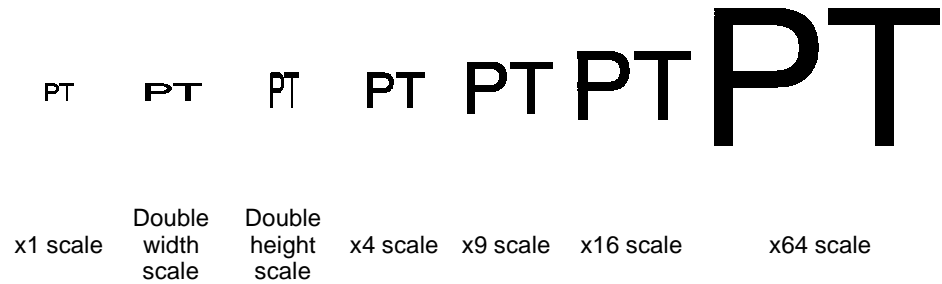

**Reference** Smoothing

The characters and marks enlarged to the x4 scale or larger are displayed with the outline automatically smoothed. This function is called “smoothing”. Note that smoothing processing is not performed if characters are displayed at x4 or a larger scale by giving an enlarging scale specifying command from a Host.

- Reverse and flashing display

Reverse display: The display brightness of the character and the background is reversed comparing with the normal display.

Flashing display: Characters are displayed as they flash. The normal display alternates with no-display.

Reverse and flashing display: The reverse display alternates with the normal display.

**Types and Attributes of the Figures**

The following types of figure can be input either by using the support tool or by giving a command from the Host, and be displayed during operation. Continuous straight lines including up to 256 vertexes can be drawn (up to 255 straight lines can be connected).

Continuous straight lines

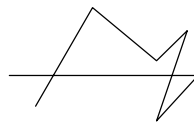

Circle



## 5-2-3 Communication with the Host

### Communication with Host Link, NT Link, and C200H Direct Communication

Using the direct communication function, bits and words can be allocated without restriction to the PC memory area, and data can then be directly written to and read from these bits and words. This makes the following possible:

- Control and notification of display elements
- Control and notification of NT600S statuses
- Screen switching
- Ascertainment of the screen number of the displayed screen
- Memory table operations

For details on the actual operations involved, refer to Section 5 “Using Host Link/NT Link/C200H Direct”.

### Communication Using RS-232C

In RS-232C communication, by sending and receiving commands via an RS-232C interface, the following functions of the NT600S can be utilized from various types of host.

- Control and notifications of display elements
- Control and notification of NT600S statuses
- Memory table operations
- Display/deletion of characters and graphics

For details on the actual operations involved, refer to Section 6 “Using the RS-232C Interface Unit”.

### Controllable NT600S Functions

The following statuses of the NT600S can be controlled.

Screen display	:Displays and clears screens
Continuous and intermittent buzzers	:Sounds and stops the buzzer
Backlight mode	:Switches on the backlight on/causes the backlight to flash

For details on the actual procedures used for these types of control, refer to Section 5-4 “NT600S Status Control” (page 192), and also “Screen Display Control” (page 214) and “Buzzer Control” (page 214).



**Ascertainable NT600S Statuses**

The following NT600S statuses can be ascertained.

PT operating status	:Whether the NT600S is operating or stopped
Screen number	:Screen number of the currently displayed screen
Numeral setting input	:Whether a numerical value has been input by numeral setting

For details on the actual method for detecting these operating statuses, refer to Section 5-5 “Notification of the Operating Status to the PC (Determining the NT600S Operating Status)” (page 197), and also “Screen Number Response” (page 217) and “Notifying Input to the Numeral Memory Table” (page 217).

 **Caution** In order to ensure system safety, be sure to periodically read the PT operating status bit at the host during operation to confirm that the PT is always operating correctly.

## 5-3 Screen Display

This section describes the screen information required for the operation with the NT600S.

### 5-3-1 Classification of Screens

The NT600S is provided with the following types of screens which are classified by the display method.

- Normal screen
- Overlapping screen
- Continuous screen

The screen type is set with each screen in the "Screen Selection" screen of the support tool. Select a screen type according to the purpose, and create characters and figures on the screen. The details of each screen type are given below.

#### Normal Screen

A normal screen is the basic screen of the NT600S. It is not necessary to select a screen type (overlapping or consecutive) when to create the screen data on a normal screen.

When a normal screen is selected, existing screens will be erased and a normal screen will be displayed.

#### Overlapping Screen

Several normal screens can be overlapped and displayed as one screen. A group of overlapped screens is called an "overlapping screen".

Several normal screens are displayed in the order of screen numbers which have been designated to each screen and form an overlapping screen. Up to eight screens can be overlapped to form one overlapping screen. The base screen used for making an overlapping screen is called a "parent screen", and a bunch of screens which are laid over the parent screen are called "child screens".

All display elements can be used on a parent screen.

**Reference** The screen attributes such as a buzzer attribute set in the parent screen become effective in an overlapping screen.

#### [Example overlapping screen]

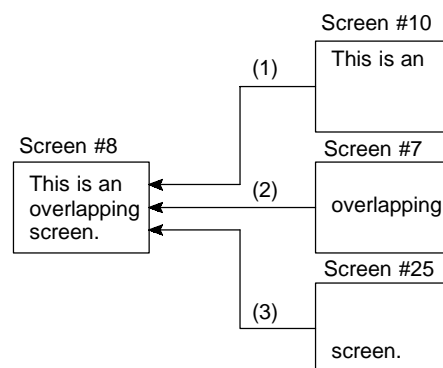

- Parent screen: #8
- Child screens: #10, #7, and #25

When screen #8 is designated, screen #8 becomes the parent screen and the child screens #10, #7, and #25 are displayed over the parent screen in that order.

- Reference**
- Only one numeral setting screen which allows numeric values to be set on the NT600S screen can be registered as a child screen. For the numeral setting, refer to Section 4-8 Numeral Setting (page 143).
  - Make sure that the touch switches and numbers set in the normal screens do not overlap in an overlapping screen. If the set positions of the touch switches and/or numbers in the normal screens overlap with each other, such settings may sometimes not be effective as intended. Use the support tool and make sure that the set positions do not overlap with each other.

**Continuous Screens**

A group of normal screens which are related in series and can be switched consecutively is called the “continuous screens”. Up to eight screens can be registered to one screen as a group of continuous screens.

The base screen used for registering the continuous screens is called a “parent screen”, and the registered continuous screens are called “child screens”.

The current screen number and the total number of continuous screens can be displayed in the top right corner of the screen. This is called the “page number display”.

- Reference**
- The page number is set when creating the screen data by using the support tool. Refer to the “NT-series Support Tool Operation Manual” (V028-E1-□).

All display elements except “numeral setting” can be used in the continuous screens.

- Reference**
- The screen attributes set in the parent screen become effective in the continuous screens.

**[Example continuous screens]**

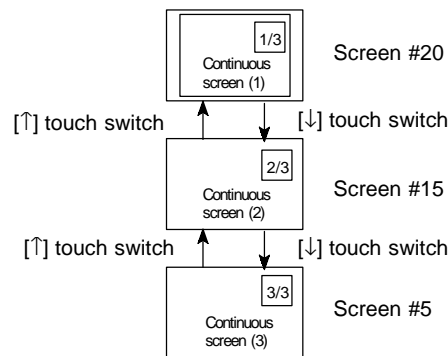

- Parent screen: #10
- Child screens: #20, #15, and #5

When screen #10 (continuous screen) is designated, screen #20 which is page 1 of the continuous screens will be displayed. Screen #15 or #5 can be displayed by using the touch switches. Since screen #10 has been set for the continuous screens, that screen cannot be displayed as an individual screen.

### Switching the Continuous Screens by Using the Touch Switches

Continuous screens can be switched by using the [↓] and [↑] touch switches which have the system key functions.

When creating the screen, create touch switches [↓] and [↑] to which the system key functions are allocated. (Refer to “System key functions” (page 142).)

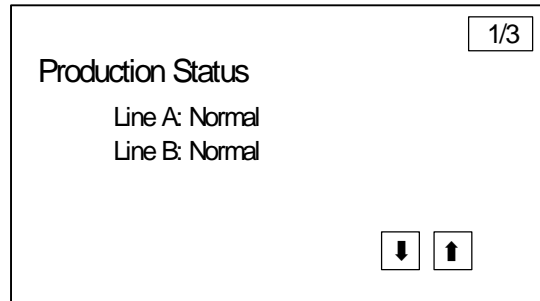

### 5-3-2 Screen Attributes

Each screen can be set with a specific function by designating a screen attribute, so that the specific function can be executed by displaying the screen. For example, by displaying a screen to which a “buzzer attribute” has been set, the buzzer of the NT600S starts sounding.

---

**Reference** Use the support tool to set the screen attributes.

---

The following several attributes can be set with one screen.

#### Buzzer Attribute

This attribute will become effective to sound the buzzer in the NT600S when the screen to which this attribute has been set is displayed. The buzzer sound can be set as follows:

- No: Buzzer does not sound when the screen is displayed.
- Continuous sound: Buzzer sounds continuously.
- Intermittent sound: Buzzer sounds intermittently at constant intervals.

---

**Reference** The buzzer sound is set with the NT600S memory switch. The buzzer can also be set by using the PC/Host. Refer to “Using the buzzer” (page 94) for the buzzer setting using the memory switch.  
To stop the buzzer by using the screen operation, create a [buzzer stop] system key as a touch switch.

---

#### Numeral Setting Attribute

Select whether the numeric keys are automatically displayed or the numeric keys are created at arbitrary positions on the numeral setting screen. The following two numeral setting attributes are used.

- System: The numeric keys registered to the system are automatically displayed.
- User: The numeric keys can be created at any arbitrary positions.

- Reference**
- The screen attributes are set for each screen by using the “screen selection” screen of the support tool.
  - The support tool displays “alarm”, “backlight color”, etc. which are not used with the NT600S.  
If the numeral setting attribute on the NT600S has been set for “system”, the touch switches [ENT], [↓], and [↑] which are allocated to the system besides the numeric keys need to be created. (System key functions (page 142))

#### **Bit input attributes (RS-232C communication only)**

Select whether the touch switch number or bit information is notified to the host when a touch switch is pressed. There are two types of bit input attribute in the screen attributes, as indicated below.

Off :Bit control when a touch switch is pressed is invalid.  
The status of the touch switch is notified using its number.

Touch SW :Bit control when a touch is pressed is valid.  
The status of the touch switch is notified using bit information.

#### **Backlight attributes (NT600S-ST121 only)**

Select whether the backlight is lit or flashes when the screen is displayed. There are two types of backlight attribute in the screen attributes, as indicated below:

Lit :Backlight is lit when the screen is displayed.

Flashing :Backlight flashes when the screen is displayed.

This attribute is invalid with the EL display type NT600S-ST211.

## 5-4 Memory Tables

The NT600S has the “character-string memory table” for the character data and the “numeral memory table” for numeric data which can be written and updated by the PC/Host.

**Reference** The contents of the memory tables can be set by using the support tool when displaying the memory tables on the screen or by editing the table.

### 5-4-1 Character-String Memory Table

The character-string memory table is an NT600S internal memory used to store the character data. Up to 256 character-string memory tables can be used, and up to 20 full size characters (40 bytes) can be stored in one memory table. The character-string memory tables at up to 50 positions can be registered in one screen.

#### Displaying a Character-string

The character-string memory tables are registered with table numbers 0 to 255.

When creating the screen data by using the support tool, set the position on the screen to display a character-string and also set a character-string number to be displayed.

When the NT600S is operated, the screen displays the contents of the character-string memory table.

In the direct connection of Ver. 5, it is possible to display the character-string by designating the number of the character-string memory table using the numeric memory table instead of directly changing the contents of the character-string memory table. (indirect designation)

For the procedure for changing the character-string in the table, refer to “Changing Displayed Numerals or Character Strings (Changing the Contents of Allocated Words)” (page 170, 172) or “Write Character-string Memory Table” (page 208).

If the RS-232C communication is used, it is possible to display the character-string by the Host instruction disregarding of the screen presently displayed (terminal function). Refer to “Specify Displayed Characters” (page 225).

#### Characters and Figures Which can be Displayed

The power of expression of the screen can be increased by giving various attributes such as the enlarged or reverse display to the characters of the character-string memory table.

The character attributes can be set in the edit screen when creating the screen data by using the support tool.

The following types of characters can be displayed on the NT600S:

Character Type	Dots (vertical x horizontal)	Character Set	Maximum Number of Characters Displayed in One Screen (without overwriting)
Half height character	8 x 8	Alphanumerics and symbols	80 characters x 50 lines (4000 characters)
Normal characters	8 x 16	Alphanumerics and symbols	80 characters x 25 lines (2000 characters)
Marks	16 x 16	Create by using the support tool	

- Enlarged display of the characters and marks

The characters and marks can be enlarged to the following scales.

Double width scale, Double height scale, x4 scale, x9 scale, x16 scale, x64 scale

- Smoothing

The characters and marks enlarged to the x4 scale or larger are displayed with the outline automatically smoothed. This function is called “smoothing”.

- Reverse and flashing display

Reverse display: The display brightness of the character and the background is reversed comparing with the normal display.

Flashing display: Characters are displayed as they flash. The normal display alternates with no-display.

Reverse and flashing display: The reverse display alternates with the normal display.

## 5-4-2 Numeral Memory Table

The numeral memory table is an NT600S internal memory used to store the numeral data. Up to 512 numeral memory tables can be used, and up to eight digits (four bytes) of numeral data (including signs) can be stored in one numeral memory table. The numeral memory tables at up to 50 positions can be registered in one screen.

### Displaying a Numeral

The numeral memory tables are registered with table numbers 0 to 511.

When creating the screen data by using the support tool, set the position on the screen to display a numeral and also set a numeral number to be displayed.

When the NT600S is operated, the screen displays the contents of the numeral memory table.

Also, by relating the numeral memory tables with the bar graphs, the bar graphs corresponding to the data of the numeral memory tables can be displayed.

### Numerals Which can be Displayed

The power of expression of the screen can be increased by giving various attributes such as the enlarged or reverse display to the numerals of the numeral memory table.

---

**Reference** The numeral attributes can be set in the edit screen when creating the screen data by using the support tool.

---

The following types of numerals can be displayed on the NT600S:

- Digits of the whole numbers: 1 to 8 digits
- Digits of the decimal fraction: 0 to 7 digits
- Character sizes: Half, normal
- Enlarged display: Double width, double height, x4, x9, x16, x64

The characters enlarged to the x4 scale or larger are displayed with the outline automatically smoothed. This function is called "smoothing".

- Sign display setting
- Decimal/hexadecimal display setting
- Zero suppress setting

---

**Reference** Zero suppress setting

The numeral data are displayed in designated display areas as right-aligned. If the number of digits of a numeral data is smaller than that of the display area, number "0"s will be displayed at the vacant digits. These "0"s will not be displayed if the zero suppress setting is made for "Yes".

---



## 5-5 Bar Graphs

The contents of the numeral memory tables of the NT600S can be displayed as bar graphs as well as numeral data.

Setting for bar graphs is made when creating the screen data using the support tool.

The following describes the kinds of bar graphs that can be displayed.

The display data of bar graph can be changed by changing the contents of the numeral memory table.

For the procedure for changing the data of the bar graph presently displayed, refer to "Upgrading Bar Graphs (Changing the Contents of Allocated Words)" (page 179) or "Write Numeral Memory Table" (page 209).

### 5-5-1 Bar Graph Functions

The bar graph function displays a value in a bar graph form as a percentage to the specified value according to the contents of a numeral memory table. Up to 50 bar graphs can be registered in one screen.

- Reference table

The numeral memory table used as the reference for the bar graph display can be set.

---

**Reference** The support tool has the "direct" and "indirect" options for the reference method of the numeral memory table. However, the NT600S recognizes the "direct" method only.

The bar graph display cannot use hexadecimal numbers. If hexadecimal numbers are set in the reference numeral table, the bar graph cannot be displayed. Use caution not to write hexadecimal numbers except the minus sign "F" to the reference numeral table.

---

#### Bar Graph Attributes

The following attributes can be set with the NT600S for the bar graph display:

---

**Reference** Use the support tool to make settings for the bar graph display when creating the screen data.

---

- Position and size

The display position and size (length) of a bar graph can be set.

The width of the bar graph can be set in the range of 2 to 255 dots.

- Orientation and incremental direction

The orientation and incremental direction of the bar graph can be selected from those mentioned below.

↑ (up): The bar graph increments upward in the vertical orientation.

↓ (down): The bar graph increments downward in the vertical orientation.

← (left): The bar graph increments to the left in the horizontal orientation.

→ (right): The bar graph increments to the right in the horizontal orientation.

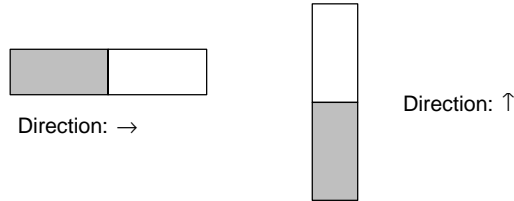

- Graph frame

Select whether or not the graph frame (boundary line of a graph display area) which indicates the effective display range is displayed.

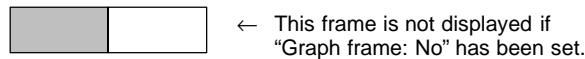

- Setting the 100 % value and % display

Set a value which corresponds to 100 % for the “100 % value”. The available value range is “0 to 99999999” (max. eight digits). For the “% display”, whether or not the proportion (percentage) of the reference numeral memory table value to the “100 % value” is displayed in a numeral can be selected. The display value is calculated as follows:

$$\text{“% display” value} = \text{Numeral memory table value} \div \text{“100 % value”} \times 100$$

For the font and attributes used for the numeral display, refer to “Numerals which can be displayed” (page 130).

- Sign display and display method

Select whether or not the bar graph which indicates a value below 0 % is displayed.

**[To display a value below 0 %: Sign display “Yes”]**

The bar graph is displayed in the range of -100 % to 100 %. The middle of the bar graph indicates 0 %.

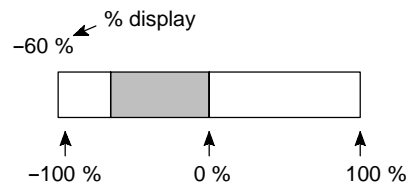
**[Not to display a value below 0 %: Sign display “No”]**

The bar graph is displayed in the range of 0 % to 100 %. The end of the bar graph indicates 0 %. Values below 0 % are indicated as 0 %.

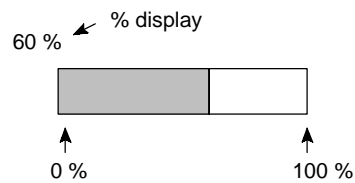

- Differences in the bar graph display method according to the % values

The bar graph display method varies according to the % value range.

- (1) When the % value is in the minus range

The display varies as follows according to the sign display setting:

Sign display “No”: Displayed as 0 %.

Sign display “Yes”: Displayed in the minus range.

- (2) When the absolute value of the % value is in the range of 100 % to 999 %

The % value is displayed as it is.

Sign display "No": The display will be as mentioned below according to the graph frame setting.

When the frame is displayed:

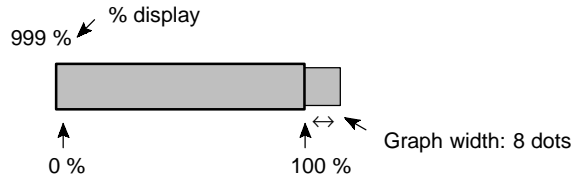

When the frame is not displayed:

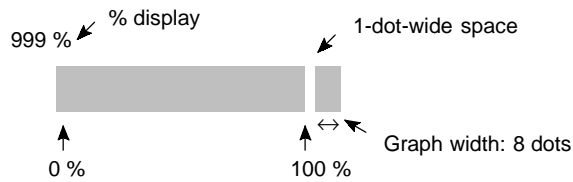

Sign display "Yes": A value below -100 % will be displayed in the minus direction as shown above.

- (3) When the absolute value of the % value is above 1000 %

The bar graph will be displayed the same as (2) above.

The % value is displayed as follows according to the sign display setting:

Sign display "No": \* \* \* %

Sign display "Yes": \* \* \* \* %

## 5-6 Lamps

The NT600S has the “lamp” function used to simply display the PC bit status.

Set the lamp function when creating the screen data using the support tool.

The following describes the kinds of lamps that can be displayed.

The status of the lamps (lit (flashing) or unlit) can be changed by the Host instructions.

### 5-6-1 Lamp Functions

The lamps are the graphic areas whose method of display can be changed by using the PC/Host. Available display methods are “lit”, “unlit”, and “flash”. Up to 255 lamps can be registered in one screen.

The display status (lit, unlit, and flash) which are registered when creating the screen data can be switched according to the ON/OFF of the PC bit status.

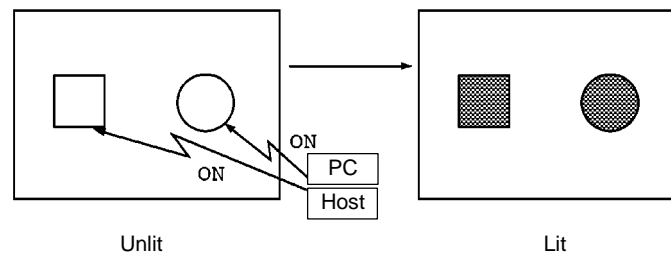

#### Lamp Attributes

The following attributes can be set with the lamp. Use the support tool to set the lamp attributes.

- Shape

Select from the square and circle shapes. The display size can be freely selected.



- Frame

Select whether or not the boundary line (frame) of the lamp display area is displayed. If the frame is not set, only the guide display message for the lamp is displayed when the lamp is not lit (or flashing). If the guide display message is not set, nothing is displayed.

- Lit and flashing

Select whether the lamp is lit (reverse display) or flashing (reverse flashing) when the lamp is turned ON by the PC/Host.

- Guide display message

Lamps can be displayed with the guide display messages.

- ➔ The guide display message attributes are the same as that for the “character display”. Refer to “Characters and Figures which can be Displayed” (page 128).

- Frame and lit/flashing

The display method of “lit/flashing” varies according to the frame setting.

Frame is set: Only the area in the frame will be lit/flashing.

Frame is not set: The area including the frame will be lit/flashing.

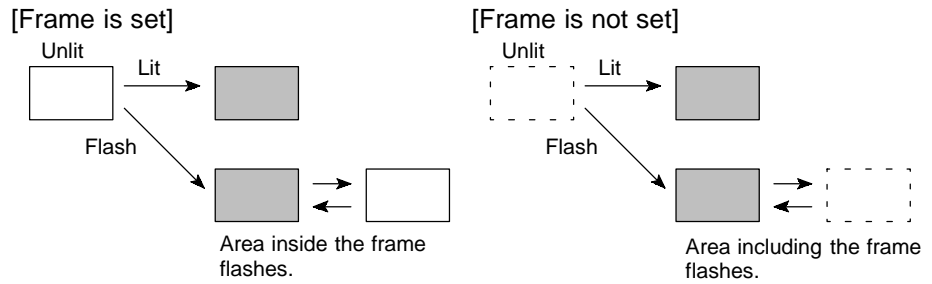

### Controlling lamps in a batch

Multiple lamps can be lit or flashed in a batch by registering multiple lamp allocations to the same screen.

[Example of batch lighting]

Set the same bit number or lamp number for lamps L1 to L5.

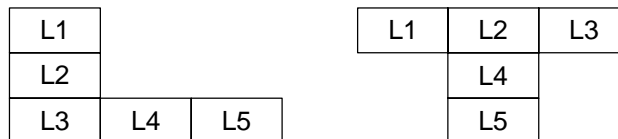

**When a lamp is overlapped with a memory table display**

The guide display message for a lamp is a fixed character-string. If you want to change the lamp guide display in accordance with some condition, overlap the display area of a numeral memory table or character-string memory table with the lamp. However, note that – as shown below – different results will be achieved depending on the timing of the lighting of the lamp and the updating of the memory table. Bear this in mind when creating the control program.

Example 1 :Lamp lit after the memory table is updated

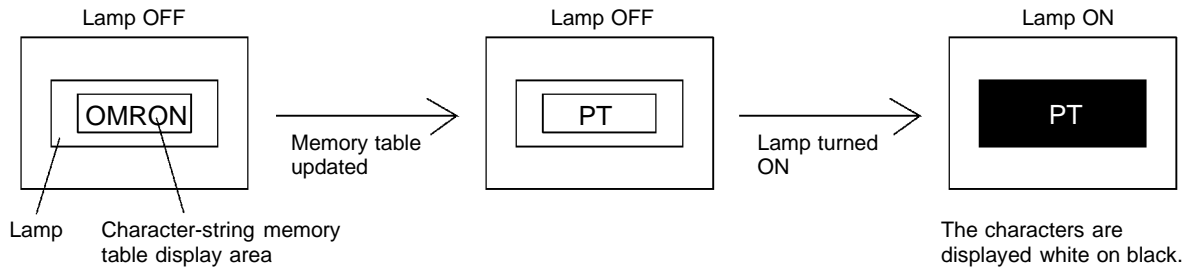

Example 2 :Memory table updated while lamp is lit

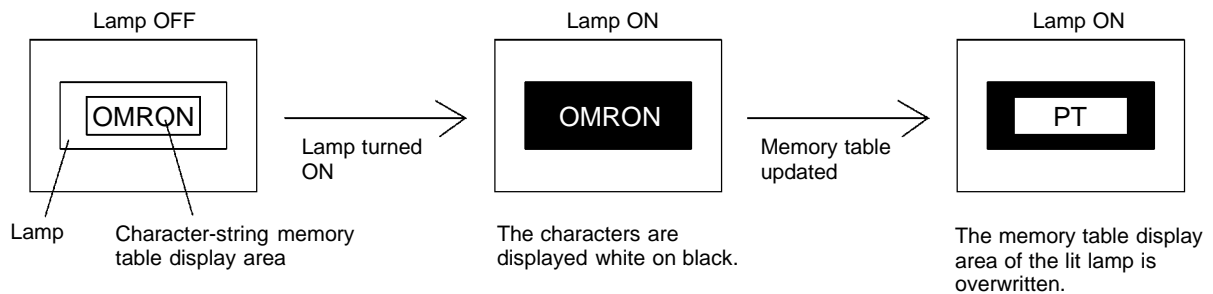

## 5-7 Touch Switches

The NT600S has a function whereby input operations can be performed by using touch panels displayed on the screen. NT600S screens can be switched, or bit information sent to the PC, by pressing (lightly touching) the “touch switches” in a panel.

The touch switches can also be made to light up (or flash) and go off like lamps.

Touch switches are set when creating the screen data with the support tool.

This section describes the touch switches that can be displayed, and explains the screen switching function and the system key function.

For details on how the status of the currently displayed touch switch is notified to the Host, refer to “Lit (Flashing) and Unlit Touch Switch Statuses (Changing the Status of Allocated Bits)” on page 185, “Lamp and Touch Switch Display (Bit Specification)” on page 211, and “Lamp and Touch Switch display (Number Specification)” on page 212.

For details on how the statuses of touch switches are ascertained by the Host, refer to “Notifying the Host that a Switch has been Pressed (Determining Touch Switch Status)” on page 185, and “Lamp and Touch Switch Display Status Enquiry” on page 212.

-  **Caution**
- Do not use input functions such as PT touch switches for applications where danger to human life or serious damage is possible, or for emergency switch applications.
  - Press touch switches with a force of no greater than 20 N.  
Applying higher force may cause glass to break, cause injuries, and prevent operation.
  - Do not press touch switches carelessly while the backlight is off or while nothing is displayed on the screen.  
Otherwise the system may operate unpredictably.  
Only press touch switches after confirming system safety.

---

**Correct use** If touch switches are pressed in rapid succession, their inputs may not be successfully received.  
Confirm that the input of a touch switch has been successfully received before moving on to the next operation.

---



- Reference**
- Caution on pressing touch switches at 3 points  
When multiple touch switches are created at the relative positions indicated in the example below, malfunctions may occur due to the characteristics of this switch configuration.  
Be careful about the positioning when setting touch switches.  
Example 1 :When switches are created at positions A and B and at the points where the vertical and horizontal lines extending from these two points intersect, i.e. points C and D:

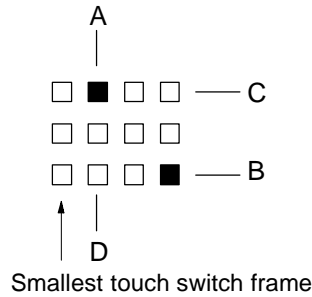

- When switches A, B, and C are switched on at the same time, switch D is also assumed to have been switched on due to the configuration of the touch switches.
- When switches A, B, and D are switched on at the same time, switch C is also assumed to have been switched on due to the configuration of the touch switches.

### 5-7-1 Functions of Touch Switches

Touch switches are created using rectangular elements measuring 39 dots horizontally by 49 dots vertically. A touch switch can comprise more than one touch switch element. Up to 128 touch switches (16 horizontally x 8 vertically) can be registered on one screen.

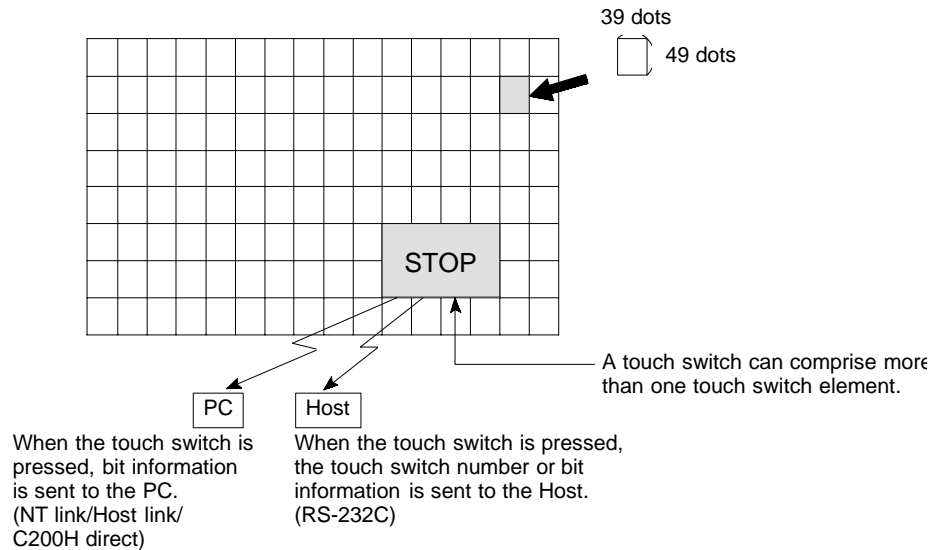

- Functions of touch switches

Touch switches can have the following functions:







- PC notification function
  - Direct connection (page 181)
  - RS-232C communication (page 205)
- Screen switch (standalone) function (page 141)
- System key function (page 142)
- Numeral setting function (page 146)
  - Direct connection (page 189)
  - RS-232C communication (page 205)

**Touch Switch Attributes**

The following attributes can be set for touch switches.

- Display frame

The area that will respond as a touch switch is displayed in the form of a frame, as shown in the table below. One of three types of frame - standard, 3-D, and none - can be selected.

Type of Display Frame	Switch OFF	Switch ON
Standard		
3-D		
None		

If “none” is selected, only the touch switch’s guide display message (or nothing, if there is none) are displayed until a “light” or “flash” designation is sent from the PC/Host or the touch switch is pressed.

- Inverse display on input

It is possible to set a touch switch so that its display will be inverted when it is pressed.

- Lighting and flashing

When using host link/NT link/C200H direct communication, it is possible to specify whether a touch switch will be lit continuously or flash when the bit allocated to it is turned ON by an instruction from the PC.

When using RS-232C, it is possible to specify whether a touch switch will be lit continuously or flash in response to an instruction from the Host.

- Presence/absence of a guide display

A guide display message can be displayed at a touch switch location.

## 5-7-2 Standalone Function

The NT600S has a function that allows screens to be switched by pressing touch switches on its screen, rather than by designation from the PC. This function is called the “standalone function”.

The screen number of the screen that will be displayed when a touch switch is pressed is set for that touch switch when the screen data is created using the support tool.

If the touch switch is pressed during operation, the screen whose number was designated will be displayed. Simultaneously, the PC will be notified of the screen number of the screen selected for display.

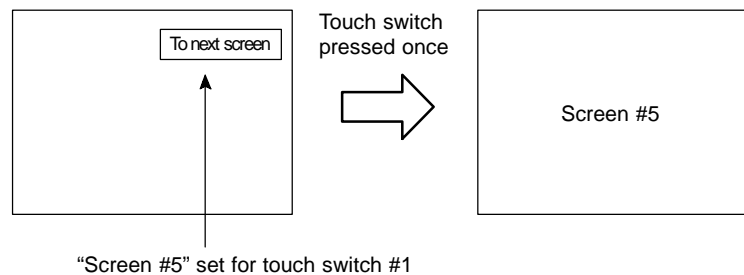

- 
- Reference**
- To set a screen number for a touch switch, use “Touch SW”, “Bit specification” and “Screen switch” of the support tool.
  - Only one screen number can be set for one touch switch within one screen (or within one overlapping screen).
-

### 5-7-3 System Key Functions





The NT600S allows the allocation of “system key” functions to touch switches. The system key functions can then be used during operation by pressing the touch switches to which they have been allocated.

For example, if, when a screen for which buzzer sounding has been set is displayed, a “” touch switch is also displayed, the buzzer can be stopped by pressing this touch switch.



**Reference** To set a system key function for a touch switch, use “Touch SW”, “Bit specification” and “Numeric key” of the support tool.

#### Allocation of System Key Functions

The system key functions are allocated to touch switch numbers 227 to 230 and 255, as shown below. When a touch switch with one of these numbers is displayed on the screen, it has the same function as the corresponding system key.

System Key	Key Symbol	Touch Switch No.
System menu display	MENU	227
[↑]		228
[↓]		229
[Buzzer stop]		230
[ENT]		255

**Reference** When a touch switch to which a system key function has been allocated is pressed, the touch switch bit information is not notified to the PC.

The , , and  keys are not displayed among the system numeric keys. Accordingly, when using the system numeric keys, create the [ENT], [↑], and [↓] keys. Alternatively, create user numeric keys.

## 5-8 Numeral Setting

The NT600S has a “numeral setting” function to enable numerical values to be input from the screen. This function inputs numerical values to numeral memory tables in response to touch switch operations, displays these numerical values on the screen, and sends them to the host.

This section outlines the numeral setting function and the method for creating the ten keys required to set numerical values on the screen, and explains how to use ten keys during operation.

Numeral setting screens cannot be registered as child screens of continuous screens. In the case of overlapping screens, only one of the screens can be set as a numeral setting screen.

**Caution** In order to input numerical values using touch switches, apart from the display area for the numeral setting, the numeric keys must also be created. For details on how to create numeric keys, see “Creating Numeric Keys” (page 146). Ensure the safety of the system before changing the monitor data.

### 5-8-1 Function of Numeral Keys

#### Basic Procedure

The procedure for numeral setting is as follows.

- (1) Input the numerical value using touch switches (numeric keys).
- (2) The input numerical value is displayed in the numeral setting area on the screen.
- (3) Confirm the input numerical value (by pressing the [ENT] key); it will be written to the numeral memory table, and simultaneously notified to the PC/Host.

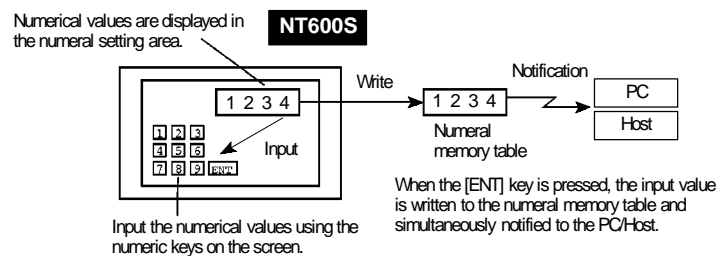

If there is more than one numeral setting area, the one in which the numerical value is to be input can be selected by using a touch switch (numeric key).

#### Restrictions on Numerical Value Input and Attribute Setting

Numerical values of up to 8 digits (7 if there is a minus sign) can be input in either decimal or hexadecimal format.

- Decimal input

When the display attribute is set for decimal display, values are input in the decimal format.

- Numerical value range

The range for numerical values that can be input differs according to whether or not there is a sign display.

When there is no sign display :0 to 99999999 (8 digits)

When there is a sign display :–9999999 to +9999999  
(7 digits for negative numbers, 8 digits for positive numbers)

If a sign is displayed when using the thumbwheel type of numeral setting, the maximum number of digits for both positive and negative numbers is 7.

- Decimal point

A maximum of 7 digits can be input after the decimal point (or 6 for negative numbers).

- Hexadecimal input

When the display attribute is set for hexadecimal display, values are input in the hexadecimal format.

- Numerical value range

Numerical values can be input in the range 0 to FFFFFFFF (8 digits).

- Attributes that can be set

The attributes of the numerical values displayed in the input field are the same as for numeral displays. See “Numerals Which can be Displayed” (page 130).

### Upper/Lower Limit Check (Ver.5 Direct Connection Only)

When Ver.5 direct connection is used, upper and lower limits can be set for input numerical values to prevent erroneous values that are outside the valid range being stored in the numeral memory table or notified to the PC.

The upper/lower limit check is executed when the input numerical value has been confirmed: if the value is outside the valid range, the screen returns to its status before input.

---

**Correct use** To use the numerical value input function safely, always use the upper/lower limit check function. Since this function is not featured with Ver.4 and previous versions of the direct connection function, a similar check should be implemented by using the user application software.

---

## 5-8-2 Types of Numeral Setting

There are two types of numeral setting: the numeric key type, and the thumbwheel type.

The basic function of these two types is the same, but the screen displays and input methods are different.

A maximum of 50 input fields, including both numeric key and thumbwheel types, can be registered on one screen.

The thumbwheel type of numeral setting can only be used when using Ver.5 direct connection with an NT600S-ST121/ST211-EV□.

**Numeric Key Type**

When a numerical value is input using touch switches to which numeric key functions have been allocated, the input numerical value is displayed on the screen. On pressing the return key after completing input, the input numerical value is written to the numeral memory table and notified to the host.

If there is more than one numeral setting input field, the field in which the input is to be made can also be selected with the numeric keys.

In order to perform numeric key input, it is necessary not only to create a numeral setting input field on the screen, but also to create the numeric keys to be used for input (see page 146).

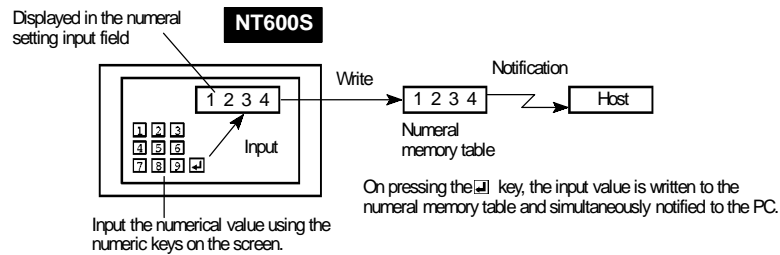

**Thumbwheel Type (Ver.5 Direct Connection Only)**

When using an NT600S-ST121/ST211-EV□ with Ver.5 direct connection, numerical values are input directly at the numeral setting input field using touch switches that increment or decrement each of the digits in the display when pressed. Each time the displayed numerical value is changed, the new displayed value is written to the numeral memory table and simultaneously notified to the host.

This means that, when using the Thumbwheel type of numeral setting, all that is required to input numerical values is to create the numeral setting input field on the screen.

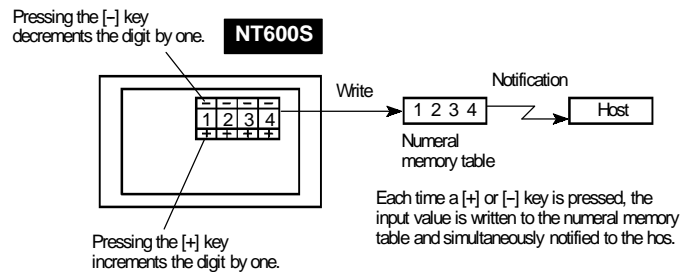

### 5-8-3 Creating Numeric Keys

In order to input numerical values using the numeral setting function, apart from the display area for the numeral setting, the numeric keys must also be created.

#### Setting Screen Attributes

The type of numeric keys can be selected using the numeral setting attributes of the screen attributes. There are two numeral setting attributes: "system" and "user".

- Screen when "system" is specified

When a numeral setting area is created, numeric keys are automatically displayed. The display position and arrangement of the numeric keys are fixed. On this screen, only the types of numeric key shown in the figure below (system keys) are used.

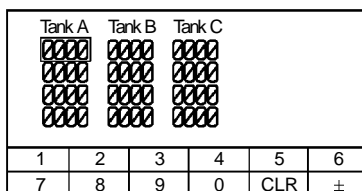

When using the NT600S with the numeral setting attribute set to "system", apart from the numeric keys provided by the system, the touch switches allocated to system keys ( , , ) also have to be created (system key function). To enable input of hexadecimal values, it is also necessary to create numeric keys A through F.

With the NT600S, if the numeral setting attribute is set to "system", apart from the numeric keys prepared by the system, the touch switches allocated to system keys ( , , ) have to be created. ("System key functions", page 142)

- When the numeral setting attribute is "user"

The type, position, etc., of numeric keys can be set as required. The numeric keys that can be created are shown below.

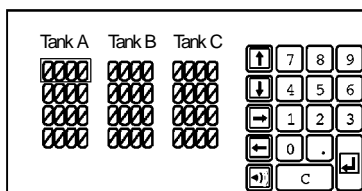



**Numeric Key Allocations**

The following special touch switch numbers (numeric key numbers) are allocated to the numeric keys.

Touch Switch Number	Numeric Key	Touch Switch Number	Numeric Key	Touch Switch Number	Numeric Key
227 (*)	Menu display	237	6	247	CLR
228	↑	238	7	248	±
229	↓	239	8	249	.
230	☞	240	9	250	HOME
231	0	241	A	251	↑
232	1	242	B	252	↓
233	2	243	C	253	←
234	3	244	D	254	→
235	4	245	E	255	☒
236	5	246	F		

(\*) Numeric key number 227 (formerly “buzzer stop” + [↓] + [↑]) is the system menu display key.

To create a touch switch for a user-defined numeric key, select “Numeric key” from the “Touch SW - Bit setting” menu of the support tool, then designate a touch switch number at “Numeric key #”.

**Reference**

When a touch switch allocated as a numeric key is pressed, the touch switch status is not notified to the PC. Consequently, touch switches 227 to 255 cannot be used as ordinary touch switches.

- Continuous screens and overlapping screens

Numeral setting screens cannot be registered as child screens of continuous screens. If a numeral setting screen is displayed part way through a continuous screen, the system keys created as touch switches - [↑] and [↓] - function as keys for numeral setting, making it impossible to switch screens.

In the case of overlapping screens, only one of the screens can be set as a numeral setting screen.

### 5-8-4 Using Numeric Keys

To input numerical data at a numeral setting area during operation, first select the numeral setting at which the data is to be input, and then input the numerical value by pressing the numeric keys (touch switches).

#### Selecting the Numeral Setting Area for Data Input

Select the numeral setting area into which the numerical value is to be input by using either the numeric keys or the system keys.

- Selection with the numeric keys

Use the [HOME], [→], [←], [↑] and [↓] keys. By using these keys, the cursor can be shifted between numeral setting areas in the way shown in the figure below.

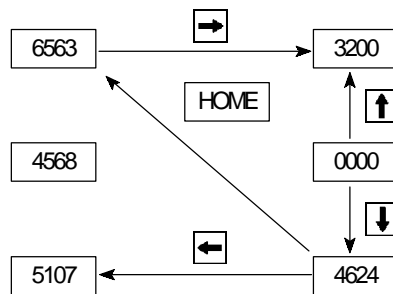

Pressing the [HOME] key will shift the cursor to the area whose top left corner has the smallest XY coordinate sum (the top left numeral setting input field in the example above).

- Selection with the system keys

When the [↑] and [↓] system keys on the touch panel are pressed, the cursor moves between the numeral setting areas by following the order in which they were created using the support tool.

For example, if three numeral setting areas have been created, the cursor can be moved between them following the order of creation as follows.

[↑] key: 1st area → 2nd area → 3rd area → 1st area

[↓] key: 1st area → 3rd area → 2nd area → 1st area

If the “numeral setting” screen attribute is set to “system”, the order of cursor motion when the [↑] and [↓] system keys are used can be changed. For details, refer to the NT series support tool operation manual (V028-E1-□).

**Inputting Numerical Values** Input numerical values using the following numeric keys (touch switches): numerals (0 to 9), decimal point (.), sign (+,-), clear (CLR), and return (  ).

- Inputting the integer and decimal fraction parts

When inputting a numeric value including a decimal point, input the integer and decimal fraction separately. First input the integer, then press the decimal point key (.) and input the decimal fraction.

If the integer or decimal fraction exceed their respective allowable numbers of display digits, they are shifted to the left.

Note that the system keys do not have a decimal point (.) key. Accordingly, it is necessary to make a decimal point key in addition to the system keys to input numeric values including a decimal point.

- Changing the sign

When there is a sign display, pressing the sign ( $\pm$ ) key changes minus to plus or plus to minus.

- Confirming input numerical values

Always press the return key as the final step when inputting a numerical value. When the return key is pressed, the displayed numerical value is written to the numeral memory table and at the same time notified to the host.

- Initial operation of input keys

The return key (  ), sign key ( $\pm$ ), decimal point key (.), operate as follows on initial use (first use after displaying the screen or first use after key input).

- Return key (  )

The display is cleared to zero (assuming decimal input width sign display).

- Sign key ( $\pm$ )

The display is cleared to zero (assuming decimal input with sign display).

- Decimal point key (.)

The display is cleared to zero, after which input starts from the decimal fraction digits (assuming decimal input with sign display).

- Alphabet (A to F) key

The display is cleared to zero (assuming decimal input).

**Upper/lower limit check (only when using direct connection)**

By setting a maximum value and minimum value for input numerical values, the storage of erroneous values outside the applicable range in numeral memory tables and their notification to the PC/Host can be prevented.

The upper/lower limit check is executed when an input numerical value is confirmed.

**5-8-5 Using Thumb Wheel Keys (Only When Direct Connection Ver.5 is Specified)**

Using thumb wheel switches, numerical values can be input during operation by pressing the incrementing/decrementing (+/-) keys.

**Numerical value input**

Input numerical values by using the incrementing/decrementing (+/-) keys provided for each digit.

- Numerical value specification

When an incrementing/decrementing (+, -) key is touched, the numeral at the corresponding digit is incremented or decremented by one. Whenever a plus or minus key is touched, the changed value is notified to the host. There is no need to press the return key as is the case when using the numeric key type of numeral setting.

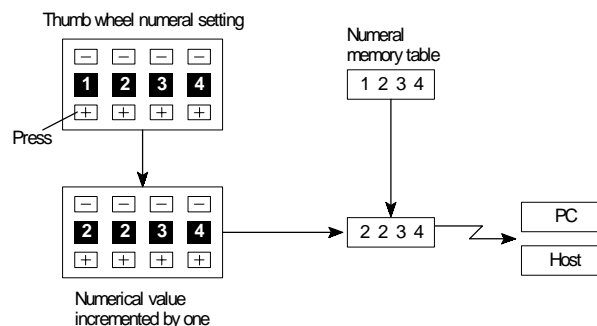

---

**Reference** Numerical values cannot be set in thumb wheel type numeral setting fields by using numeric keys.

---

- Changing the sign

In settings with a sign display, touching the incrementing/decrementing (+, -) keys at the digit where the sign is displayed will change plus to minus and minus to plus.

- Upper/lower limit check

An upper/lower limit check is executed when the incrementing/decrementing (+, -) keys are pressed. If the input numerical value is outside the valid range, the data in the numeral memory table before the key was pressed is redisplayed and notified to the host.

However, with thumbwheel type numeral setting, if the situation is such that with an upper limit of 1n..n, and a lower limit of 0m..m (where n and m are the values of each digit),  $n..n < m..m$ , it is not possible to carry digits upward or downward.

Example:

When the upper limit value is 1200 and the lower limit value is 201, if the initial value has three digits the value can be changed within the range 201 to 999, and if the initial value has four digits it can only be changed within the range 1000 to 1200.

This is because if an attempt is made to change the leftmost digit from 0 to 1, or from 1 to 0, an upper/lower limit value check is always performed.

In order to avoid this, either set the values so that  $n..n \leq m..m$ , or create another touch switch and write values to the host when digits are carried up or down.

### Restrictions and Additional Settings for Thumb Wheel Type Numeral Settings

There are the following restrictions and additional items to set when creating thumb wheel type numeral settings.

- Number of input digits for positive values when there is a sign display

When a sign display is set for a thumb wheel type numeral setting, a maximum of 7 digits can be input for positive values.

- Display size

The only size that can be specified is “medium” (two touch switch areas combined to make each digit).

Note that since the touch switch mesh overlaps with the numeral display, touching the numeral display will cause the numerical value to be updated.

- Shape (end plates)

Set which of the two shapes shown below will be used. One has “end plates” at right and left sides and the other does not.



- Restrictions on display attributes

The following restrictions apply to display attributes.

- Character type : Wide size only (16 × 16 dots)
- Character enlargement : Standard only
- Zero suppress : No zero suppression only

See “Numerals Which can be Displayed” (page 130).



## SECTION 6

# Using Host Link/NT Link/C200H Direct

This section describes how the NT600S can be used when using the Host link/NT link/C200H direct.

6-1	Outline of Host Link / NT Link / C200H Direct Operation .....	154
6-1-1	Equipment and Settings Used in This Chapter .....	154
6-1-2	Allocatable Bits and Words .....	154
6-1-3	NT600S Status Control and Notification to PC .....	155
6-1-4	Switching the Screen Display .....	160
6-1-5	Notifying the Display Screen to the PC (To Display the Number of Currently Displayed Screen) .....	162
6-2	Memory Tables and Bar Graph .....	164
6-2-1	Allocation Words and Display of the Memory Tables .....	167
6-2-2	Changing Displayed Numerals or Character Strings (Changing the Contents of Allocated Words ..... Direct Specification) .....	170
6-2-3	Changing Displayed Numerals or Character-Strings (Changing the Contents of Allocated Words ..... Indirect Specification) .....	172
6-2-4	Copying the Memory Table .....	175
6-2-5	Upgrading Bar Graphs (Changing the Contents of Allocated Words) .....	179
6-3	Lamps, Touch Switches, and Numeral Setting .....	180
6-3-1	Allocation Bits and Display of Lamps .....	180
6-3-2	Turning ON (lit) and OFF (unlit) the Lamps (Changing the Contents of Allocated Bits) .....	181
6-3-3	Allocated Bits, and Display, of Touch Switches .....	183
6-3-4	Lit (Flashing) and Unlit Touch Switch Statuses (Changing the Status of Allocated Bits) .....	185
6-3-5	Notifying the PC that a Switch has been Pressed (Determining Touch Switch Status) .....	185
6-3-6	Notification of Numbers to the PC .....	189
6-4	NT600S Status Control .....	192
6-4-1	Controllable NT600S Functions .....	192
6-4-2	How to Control NT600S Functions .....	195
6-5	Notification of the Operating Status to the PC (Determining the NT600S Operating Status) .....	197
6-5-1	Ascertainable NT600S Statuses (Notified Operating Statuses) .....	197
6-5-2	Reading the NT600S Operating Statuses .....	198

## 6-1 Outline of Host Link / NT Link / C200H Direct Operation

This section describes the basics for operating the NT600S through communications with the PC using the Host link/NT link/C200H direct.

### 6-1-1 Equipment and Settings Used in This Chapter

The following equipment and settings are used in the examples in this Chapter:

[Equipment] PT : NT600S-ST121-EV3  
 PC : CQM1  
 Support tool : NT-series Support Tool Ver. 2.□

[Support tool settings]

NT Model : NT600S  
 Memory capacity : 128 KB  
 Direct Access : Ver.5  
 Direct Macn Type: OMRON

### 6-1-2 Allocatable Bits and Words

The following bits and words are allocated to the PC and used for the NT600S operation. The range of respective area varies with the type of PC. Refer to Appendix L PC Memory Map (page 291).

The allocations must be made without exceeding respective area range.

[OMRON PCs]

Symbol	C Series PCs				CVM1/CV Series PCs			
	Area Name	Allocated Bit	Allocated Word		Area Name	Allocated Bit	Allocated Word	
			Numeral	Character String			Numeral	Character String
DM	Data Memory	✓	✓	✓	Data Memory	✓	✓	✓
CH	Internal/Special Relay	✓	✓	✓	Internal/Special Relay	✓	✓	✓
TIM	Timer	×	△	×	Timer	×	△	×
CNT	Counter	×	△	×	Counter	×	△	×
HR	Holding Relay	✓	✓	✓	-			
AR	Auxiliary Relay	✓	✓	✓	Auxiliary Relay	✓	✓	×
LR	Link Relay	✓	✓	✓	-			

✓ : OK    △ : 1 word only    × : NG

**Reference** One allocation word of the memory table can use continuous areas of up to 2 words in the case of numeral memory table or 20 words in the case of character-string memory table.

**Reference** When allocating a memory table to words, the allocation must not exceed the word area.

Since the special auxiliary relays of the CV series PCs are allocated to the system, they cannot be used for purposes other than the system use. However, reading from them is possible.



### 6-1-3 NT600S Status Control and Notification to PC

This section describes the fundamentals of the display elements, NT600S status control, and notification which are the basics of the NT600S functions.

For the detail method of use of the PT status control area and the PT status notify area, refer to Sections 5-4 NT600S Status Control (page 192) and 5-5 Notification of the Operating Status to the PC (page 197).

#### Controlling the Display Elements by Using Allocated Bits and Words

The NT600S will operate as follows in the display element control operation.

##### [NT600S operation]

- (1) The NT600S checks the allocation bits and words of the display elements and makes an inquiry to the PC.
- (2) The PC answers the NT600S about the bit and word data.
- (3) The NT600S changes the display status according to the bits and words obtained from the PC.

##### [NT600S operation example]

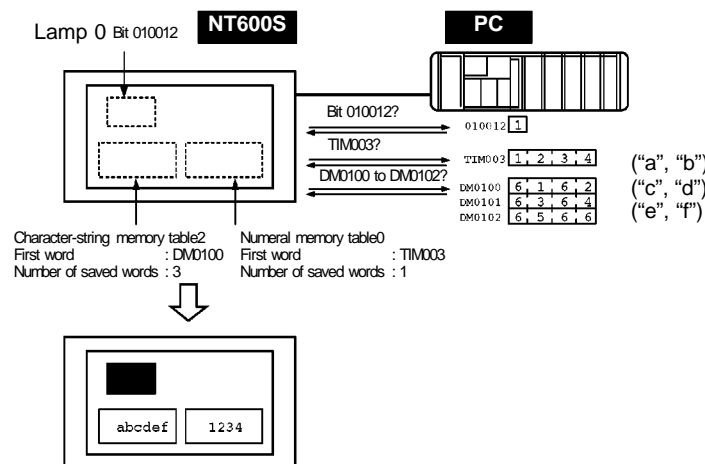

**Controlling the NT600S Status by Using Allocated Bits and Words ..... PT Status Control Area (PC to PT)**

The PT status control area (PC to PT) is provided to control the NT600S status from the PC. When data is written to this area in the PC, the NT600S will read the data and operates according to the data. The PT status control area is configured as four consecutive words as shown below.

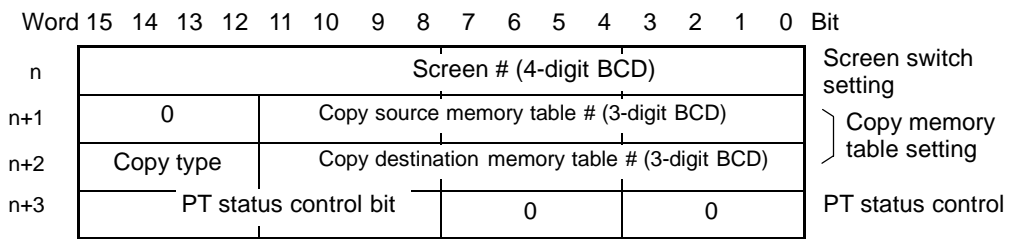

**Reference** The first word (word n) of the PT status control area must be set with the support tool.

- Screen switch settings (refer to page 160)  
Specify the screen # to switch the screen displayed on the NT600S.
- Copy memory table settings (refer to page 175)  
Specify the memory table # to copy the contents of a memory table internally in the NT600S.  
Set the copy type to match the type of memory table to be copied:  
0: Character-string memory table  
1: Numeral table
- PT status control bits (refer to page 192)  
Turn this bit ON and OFF to control the buzzer and backlight of the NT600S.

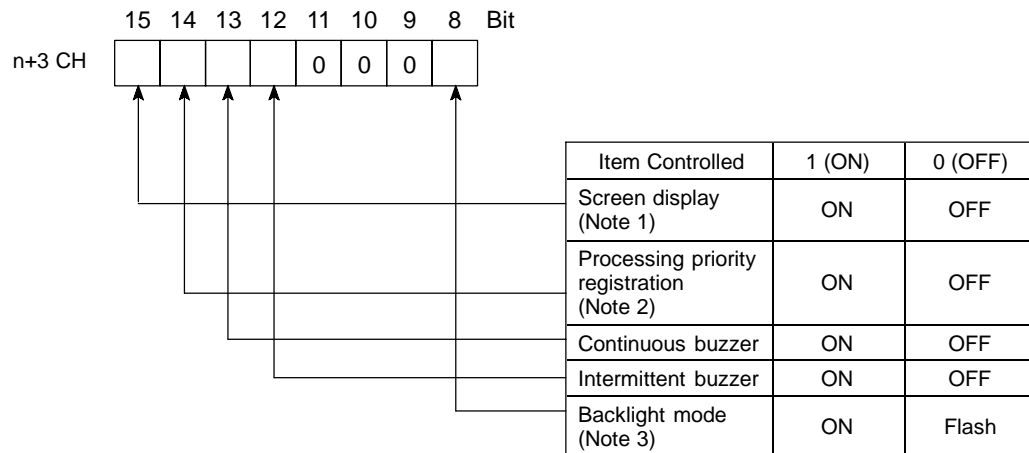

Note 1: When "ON" is set for screen display, the backlight/EL display is on; when "OFF" is set for screen display, the backlight is off.  
 Note 2: Priority registration is only valid when NT link (1:N) is set.  
 Note 3: Cannot be used with NT600S-ST211.

The PT status control area (PC to PT) can be allocated to the following PC areas.

Symbol	C Series PCs	Allocated	CVM1/CV Series PCs	Allocated
DM	Data memory	✓	Data memory	✓
CH	Internal/Special Relay	✓	Internal/Special Relay	✓
TIM	Timer	×	Timer	×
CNT	Counter	×	Counter	×
HR	Holding Relay	✓	-	
AR	Auxiliary Relay	✓	Auxiliary Relay	×
LR	Link Relay	✓	-	

✓: OK    ×: NG

Since the special auxiliary relays of the CV series PCs are allocated to the system, they cannot be used for purposes other than the system use.

**Caution** Set so that there is no overlap between the PT status control area and PT status notify area. Otherwise the system may operate unpredictably.

**Reference** When NT link (1:N) is set, the PT status control area must be set for each connected PT.

**Notifying the Display Elements by Using Allocated Bits and Words**

The NT600S will operate as follows in the display element notification operation.

**[NT600S operation]**

The NT600S will write any changes in the contents of the numeral or character-string memory table being displayed or pressing of a touch switch to the bits and words area in the PC.

**[NT600S operation example]**

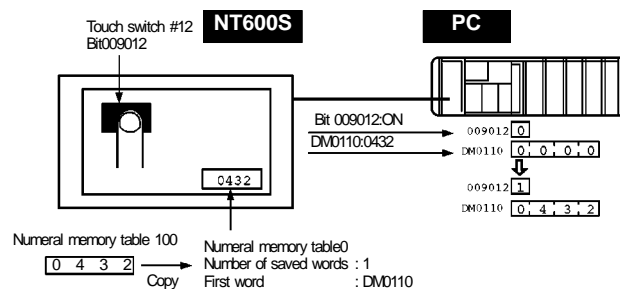

**Notifying the NT600S Status by Using Allocated Bits and Words ..... PT Status Notify Area (PT to PC)**

The PT status notify area (PT to PC) is provided to notify the NT600S status changes to the PC. When any NT600S status has changed, such change is written to this area in the PC, and the PC will read the data from this area to check the NT600S status.

The PT status notify area is configured as three consecutive words as shown below.

Word	15	14	13	12	11	10	9	8	7	6	5	4	3	2	1	0	Bit
m	Screen # (4-digit BCD)																Screen being displayed
m+1	0			Numeral memory table # (3-digit BCD)													Content upgrade memory table
m+2	PT status						0			0						PT status	

---

**Reference** The first word (word m) of the PT status notify area must be set with the support tool.

---

- Currently displayed screen (refer to page 162)

The screen number displayed on the NT600S is written to this word.

Simultaneously, the PT status screen switch strobe flag is set to ON (1). After this is notified to the PC, this flag reverts to OFF (0). Checking the status of this flag will provide a simple method of checking if the NT600S display has switched.

- Content upgrade memory table (refer to page 189)

The number of the numeral table is written to the word when the numeral memory table contents change due to the touch switch operation on the NT600S.

---

**Reference** The contents of the word to which the numeral table has been allocated also change.

---

As the number of the numeral table is written, the PT status numeral setting strobe flag is simultaneously set ON (1). After this is notified to the PC, this flag reverts to OFF (0). Checking the status of this flag will provide a simple method of checking if a number has been input from the NT600S.

Note that this function is not available with the character-string memory table.

- PT status (refer to page 197)

The NT600S operation status and other information are written with the ON or OFF of the bits as shown below.

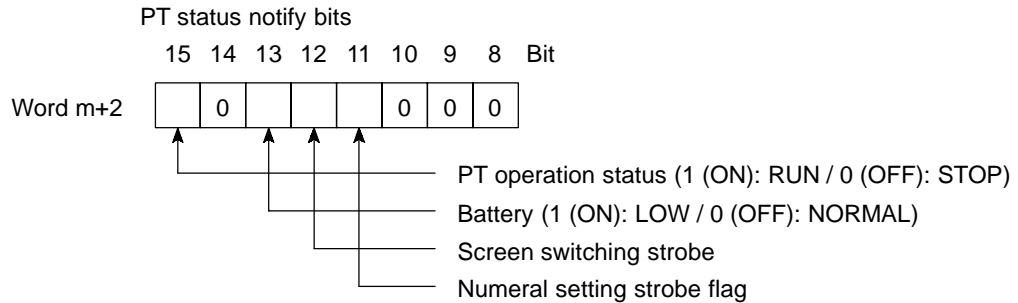

The PT status control area (PC to PT) can be allocated to the following PC areas.

Symbol	C Series PCs	Allocated	CVM1/CV Series PCs	Allocated
DM	Data Memory	✓	Data Memory	✓
CH	Internal/Special Relay	✓	Internal/Special Relay	✓
TIM	Timer	×	Timer	×
CNT	Counter	×	Counter	×
HR	Holding Relay	✓	-	
AR	Auxiliary Relay	✓	Auxiliary Relay	×
LR	Link Relay	✓	-	

✓: OK    ×: NG

**Reference** Since the special auxiliary relays of the CVM1/CV series PCs are allocated to the system, they cannot be used for purposes other than the system use.

**Caution** Set so that there is no overlap between the PT status control area and PT status notify area. Otherwise the system may operate unpredictably.

**Reference** When NT link (1:N) is set, the PT status notify area must be set for each connected PT.

## 6-1-4 Switching the Screen Display

The following describes the procedure used to switch the NT600S screen display by controlling from the PC.

**Reference** The display screen can be switched also by pressing a touch switch during the operation after registering a screen number to the touch switch. For this function, refer to the “Standalone Function” (page 141).

To switch the NT600S screen display by controlling from the PC, write a screen number at the “screen switch setting” in the PT status control area.

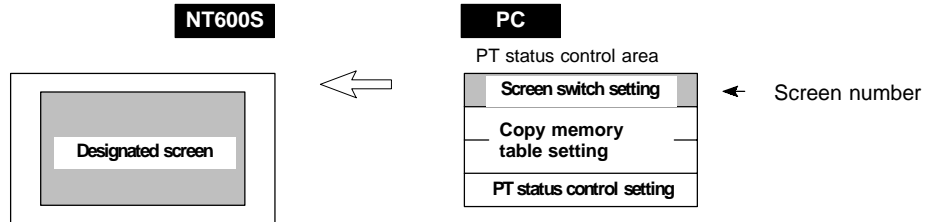

### [Screen switch setting in the PT status control area]

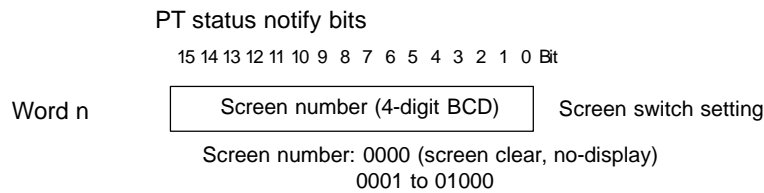

**Reference** Since the special auxiliary relays of the CVM1/CV series PCs are allocated to the system, they cannot be used for purposes other than the system use.

The range of respective area varies with the type of PC. Refer to Appendix L PC Memory Map (page 291).

- Procedure**
1. Use the support tool to allocate the PT status control area (PC to PT) to the PC memory.
  2. Create a PC program to write the number of the displayed screen to the “screen switch setting word” in the PT status control area.

**Reference** Use a 4-digit BCD (binary-coded decimal) value to set a screen number. If a screen has been switched by operating the PT status control area (PC to PT), the contents of the “currently displayed screen word” in the PT status notify area (PT to PC) also change.

- Screen switching timing

The NT600S screen switches when the contents of the “screen switch setting” have changed. To re-specify the number of the currently specified screen, first write the value 0000 to clear the screen before writing the appropriate screen number.

- Use of the screen switching strobe

Create a program to read the number of the currently displayed screen and to write the number to the “screen switch setting word” at the leading edge of the “screen switching strobe” of the PT status notify area. This program enables screen switching by using the touch switches on the NT600S and eliminates repeated setting of the same screen number. If the screen switching is not executed on the NT600S, the screen switching strobe does not need to be checked.

**Reference** For the screen switching strobe, refer to the “notifying the displayed screen to the PC” mentioned below.

- Continuous screens and overlapping screens

Continuous or overlapping screens can be displayed by designating the parent screen. If a child screen is designated, only the child screen is displayed.

**Reference** For the continuous and overlapping screens, refer to the “Classification of screens” (page 124).

### Example of Display Screen Switching

This example operates the PC switch (bit) to switch the NT600S display screen.

- Support tool settings

Make the following settings with the support tool:

PT status control area: Word 0100

PT status notify area: Word 0110

Screen number to be created: Screen #2 and #3

- PC ladder program

Create a PC ladder program as follows:

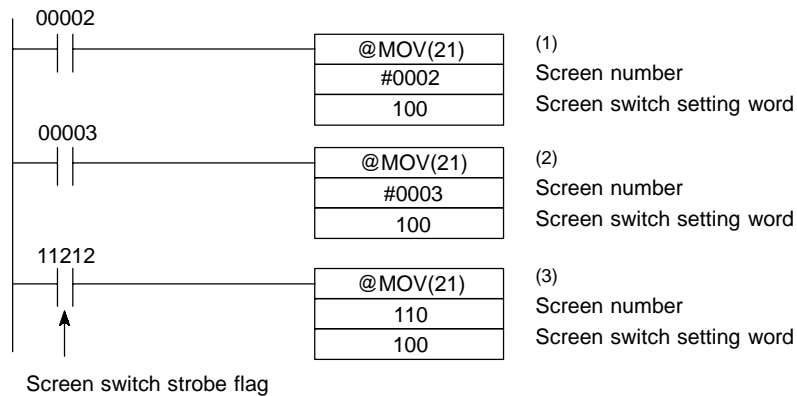

- Program operation

- (1) Screen #2 is displayed on the NT600S when bit 00002 turns ON.
- (2) Screen #3 is displayed on the NT600S when bit 00003 turns ON.
- (3) When the screen switch strobe flag turns ON, the number of the currently displayed screen is read and written to the currently displayed screen word in the PT status notify area. In this case, the NT600S will not write the same screen twice.

### 6-1-5 Notifying the Display Screen to the PC (To Display the Number of Currently Displayed Screen)

The following describes the processing to display the number of currently displayed screen of the NT600S.

This processing reads the data from the PC status notify area.

To indicate that the screen has switched, use the screen switch strobe flag.

To display the number of the currently displayed screen, use the currently displayed screen word.

When the screen has switched, the NT600S notifies the following to PT status notify area (PT to PC) allocated to the PC.

Screen switch notification: Screen switch strobe flag of the PT status word

New screen number: Currently displayed screen word

By reading the currently displayed screen word when the screen switch strobe flag has turned ON, the number of the currently displayed screen on the NT600S is displayed.

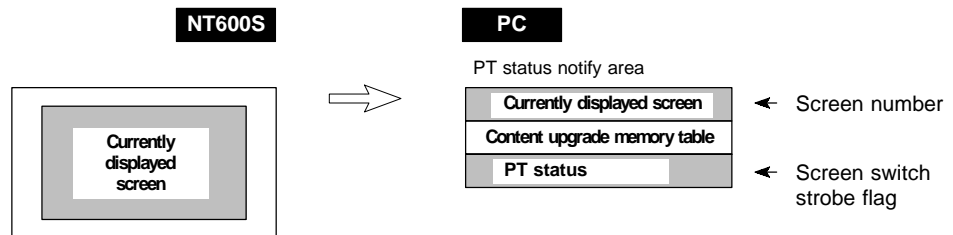

#### [Currently displayed screen] and [PT status] words in the PT status notify area

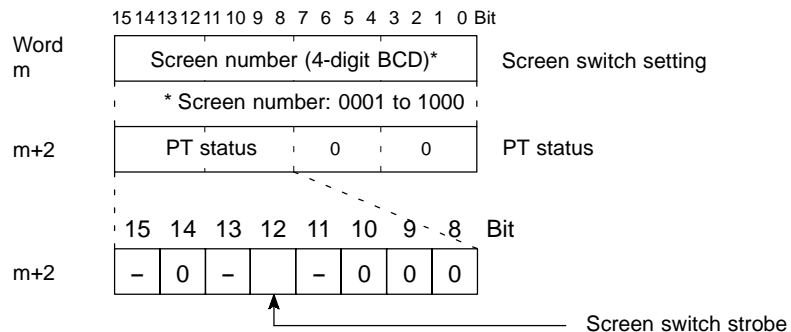

Use a 4-digit BCD (binary-coded decimal) value to set a screen number.

The screen switch strobe bit reverts to OFF (0) after this is notified to the PC.

**Reference** Since the special auxiliary relays of the CV series PCs are allocated to the system, they cannot be used for purposes other than the system use.

The range of respective area varies with the type of PC. Refer to Appendix L PC Memory Map (page 291).



- Procedure**
1. Use the support tool to allocate the PT status notify area (PT to PC) to the PC memory.
  2. Create a PC program to read the “currently displayed screen word” in the in the PT status notify area when the “screen switch strobe flag” in the PT status notify area has turned ON.

- Reference**
- The contents of the “currently displayed screen word” are updated also by switching the screen by pressing a touch switch on the NT600S.
  - For this function (standalone function or screen switch function), refer to the “Standalone Function” (page 141).

- Continuous screens and overlapping screens

When a continuous or overlapping screen is displayed, the number of the parent screen is written to the “currently displayed screen word”.

For the continuous and overlapping screens, refer to the “Classification of screens” (page 124).

### Example of Reading the Number of Currently Display Screen

This example gives a PC program that reads the screen number each time the screen is switched. In this example, the number of the previous screen is also stored.

- Support tool settings

Make the following settings with the support tool:

PT status notify area: Word 0110

- PC ladder program

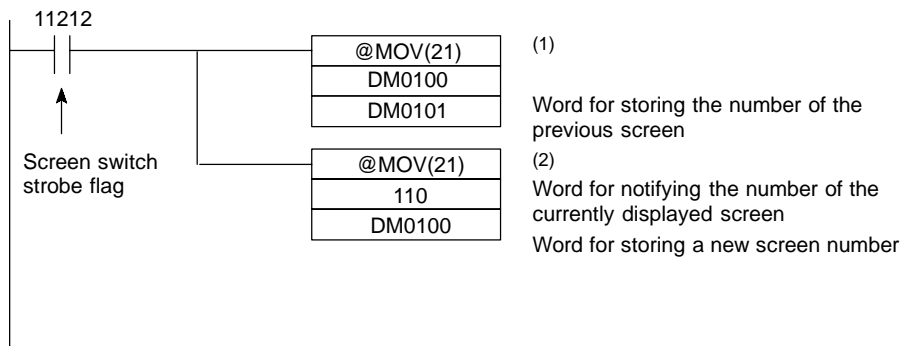

- Program operation

- (1) When the NT600S screen display switches and the screen switch strobe flag (bit 11212) turns ON, the contents of DM0100 are transferred to DM0101. The number of the previously displayed screen is stored in word 0101.
- (2) The new screen number notified by the NT600S is read and transferred to DM0100. The number of the currently displayed screen is stored in DM0100.

## 6-2 Memory Tables and Bar Graph

This section describes allocation of the memory table to PC words, and changes to the contents of words necessary to display characters, numerals, and graphs by communicating with the PC using the Host link/NT link.

**Reference** For the functions relating to memory tables and bar graphs, refer to 4-4 Memory Tables (page 128) and 4-5 Bar Graphs (page 131), respectively.

### Writing Words to the Character-String Memory Table

Since the character-string memory tables can be allocated to the words in the PC, the PC can write data to the character-string memory tables or the initial values can be set when creating the screen data.

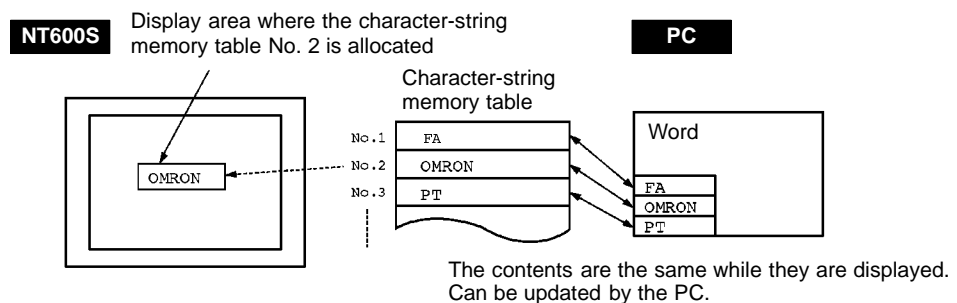

During the operation, the display contents are automatically updated so that the contents of the character-string memory table being displayed are the same as that of the PC word.

### Displaying and Referencing Character String Memory Table Contents

Since the character-string memory tables can be allocated to the words in the PC, the PC can write data to the character-string memory tables or the initial values can be set when creating the screen data.

Automatic updating is performed to ensure that the currently displayed NT600S character string memory table contents and PC word contents always match each other.

There are two methods for referencing character string memory tables used for character string display, as follows:

- Direct specification
- Indirect specification (with Ver.5 direct connection only)

- Direct specification

Direct specification is a method of specification in which the contents of displayed memory tables are directly correlated with the contents of the allocated words.

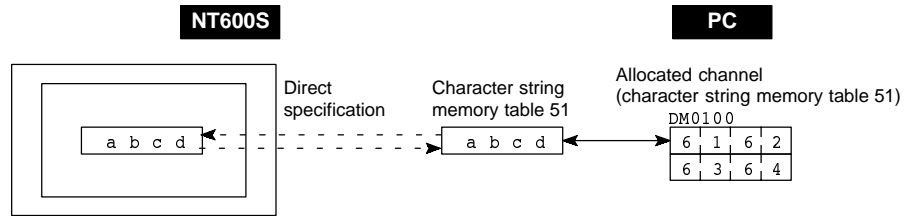

- Indirect specification (with Ver.5 direct connection only)

In indirect specification, even if the displayed data is a character string, the display is correlated with a numeral memory table. The contents (numerical value) of this numeral memory table are regarded as a character string memory table number and the contents of the table with this number are displayed.

Up to 50 numeral displays and 50 character string displays can be specified on one screen by using indirect specification.

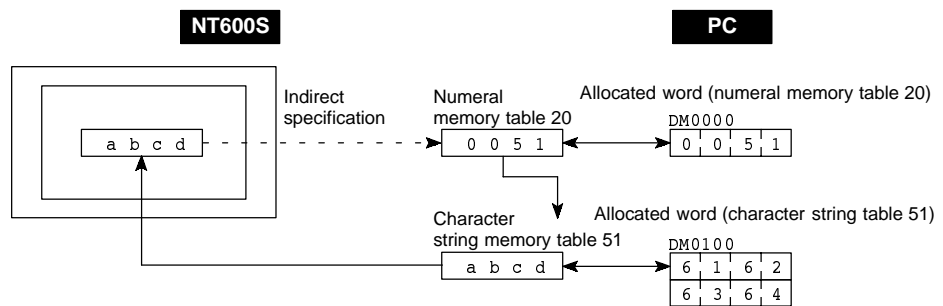

This specification method is a little complex, but it allows the display to be changed more easily according to the circumstances. In the example above, if 1 were added to the contents of memory table 20 to give 52, the contents of memory table 52 would be displayed instead.

The memory tables used for display can also be allocated to areas in the PC, so that the display can also be changed in response to changes in the data to be displayed (i.e., the contents of character string memory table 51 in the example above).

However, in comparison with direct specification, indirect specification requires more time for processing.

### Setting the Words of the Character-String Memory Table

When creating the screen data by using the support tool, make the following settings for each numbered character-string:

- Initialization setting

Set whether or not the PC words are initialized with the character-string memory table initial value registered to the screen data memory when the main power supply is turned ON or reset.

- Number of registration words

Set the number of words within 20 words required for registering the character-string data. One word can store two half-size characters or one full-size character.

- Setting the words for the character-string memory tables

The character-string memory tables can be allocated to the following PC words. Set the word type and the first word.

Symbol	C Series PCs	Allocated	CVM1/CV Series PCs	Allocated
DM	Data memory	✓	Data memory	✓
CH	Internal/Special Relay	✓	Internal/Special Relay	✓
TIM	Timer	×	Timer	×
CNT	Counter	×	Counter	×
HR	Holding Relay	✓	–	
AR	Auxiliary Relay	✓	Auxiliary Relay	×
LR	Link Relay	✓	–	

✓ : OK    × : NG

**Note**

1. Since the special auxiliary relays of the CVM1/CV series PCs are allocated to the system, they cannot be used for purposes other than the system use.
2. If the “number of registration words x 2” (“word setting window”) set with the support tool is larger than the “number of character digits” (“character-string display setting” window), the character-string may be broken halfway.

The range of respective area varies with the type of PC. Refer to Appendix L PC Memory Map (page 291).

**Writing Numerals to the Numeral Memory Table**

Since numeral memory tables can be allocated to PC words, data can be written from the PC to a numeral memory table, and initial values can be set when creating screen data.

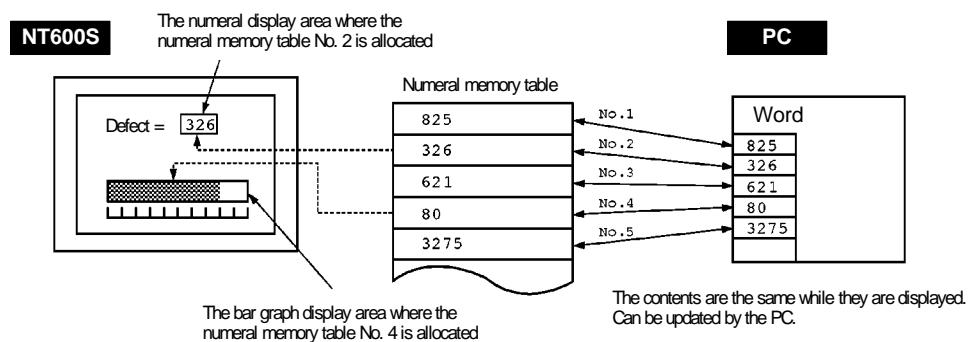

During the operation, the display contents are automatically updated so that the contents of the numeral memory table being displayed are the same as that of the PC word.

### Setting the Words of the Numeral Memory Table

When creating the screen data by using the support tool, make the following settings for each numbered numeral:

- Initialization setting

Set whether or not the PC words are initialized with the numeral memory table initial value registered to the screen data memory when the main power supply is turned ON or reset.

- Number of registration words

Set the number of words within 2 words required for registering the numeral data. One word can store up to 4 digits. Two words can store up to 8 digits.

- Setting the words for the numeral memory tables

The numeral memory tables can be allocated to the following PC words. Set the word type and the first word.

Symbol	C Series PCs	Allocated	CVM1/CV Series PCs	Allocated
DM	Data Memory	✓	Data Memory	✓
CH	Internal/Special relay	✓	Internal/Special relay	✓
TIM	Timer	△	Timer	△
CNT	Counter	△	Counter	△
HR	Holding Relay	✓	–	
AR	Auxiliary Relay	✓	Auxiliary Relay	×
LR	Link Relay	✓	–	

✓ : OK    △ : 1 word only    × : NG

#### Note

Since the special auxiliary relays of the CVM1/CV series PCs are allocated to the system, they cannot be used for purposes other than the system use.

The range of respective area varies with the type of PC. Refer to Appendix L PC Memory Map (page 291).

## 6-2-1 Allocation Words and Display of the Memory Tables

The character-string memory table and numeral memory tables can be allocated to the following PC words.

Set the word type and the first word. The number of words required for allocating a memory table and the areas to which a memory table can be allocated vary between the character-string memory table and the numeral memory table.

- Number of words required for the allocation

The number of words used for allocating one memory table is as mentioned below.

Numeral memory table:            1 word (max. 4 digits) or 2 words (max. 8 digits)

Character-string memory table: 1 to 20 words (2 to 40 normal-size characters)

- Available allocation words

The memory tables can be allocated to the following PC areas:

Symbol	C Series PCs			CVM1/CV Series PCs		
	Area Name	Allocation		Area Name	Allocation	
		Numeral	Character		Numeral	Character
DM	Data Memory	✓	✓	Data Memory	✓	✓
CH	Internal/Special Relay	✓	✓	Internal/Special Relay	✓	✓
TIM	Timer	△	×	Timer	△	×
CNT	Counter	△	×	Counter	△	×
HR	Holding Relay	✓	✓	-		
AR	Auxiliary Relay	✓	✓	Auxiliary Relay	×	×
LR	Link Relay	✓	✓	-		

✓ : OK    △: 1 word only    × : NG

**Note**

Since the special auxiliary relays of the CVM1/CV series PCs are allocated to the system, they cannot be used for purposes other than the system use.

The range of respective area varies with the type of PC. Refer to Appendix L PC Memory Map (page 291).

- Contents of the numeral memory tables

Numerals are stored in the allocated words as shown below.

**[Stored as a single word]**

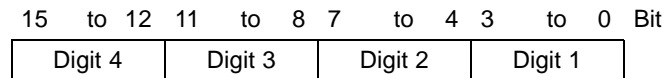

Example: 1234

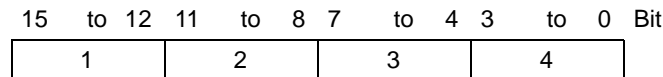

**[Stored as a double words]**

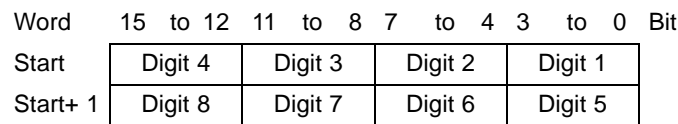

Example: 12345678

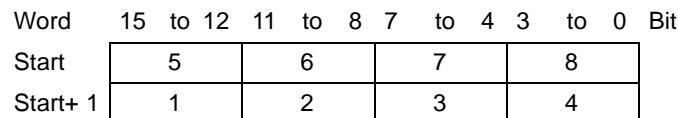

- Displaying the numeral memory table

Numerals can be displayed in three different ways according to the contents of the numeral memory table, as mentioned below.

The most significant digit (digit 4 of a single word or digit 8 of a double word) is processed in different ways.

Hexadecimal display: All digits are handled as stored in the allocated words.

Decimal display without signs: If the most significant digit is “F”, it is handled as “0”, and the most significant digit other than “F” and other digits are handled as stored in the allocated words.

Decimal display with signs: If the most significant digit is “F”, it is handled as “-” (minus sign), and the most significant digit other than “F” and other digits are handled as stored in the allocated words.

### [Numeral memory table display examples]

- When the data are numeral data (0 to 9)

Start	3   4   5   6	→	Decimal without sign	123456
Start + 1	F   0   1   2		Decimal with sign	-123456
			Hexadecimal	F0123456

- When the data contain characters (A to F)

Start	3   B   5   6	→	Decimal without sign	123B56
Start + 1	F   0   1   2		Decimal with sign	-123B56
			Hexadecimal	F0123B56

If the hexadecimal data (A to F) are stored when the decimal display has been set, the alphabets are displayed.

### Reference

- If the number of display digits has been set to be smaller than the maximum number of digits of the registration words (4 digits for 1 word; 8 digits for 2 words), the contents of the allocated words are not displayed and “\*” symbols will be displayed at all digits.
- If the most significant digit is “F” when “decimal with signs” has been set, the numeral is handled as a negative number. The maximum number of digits of the negative number becomes smaller than that of the positive number by 1 digit.
- The actual display will vary according to the “zero suppress” setting and decimal fraction setting as well as the contents mentioned above. Refer to the “NT-series Support Tool Operation Manual” (V028-E1-01).

- Contents of the character-string memory table

A character-string is stored in the allocated words beginning with the first word in half-size or normal-size characters.

Two half-size characters or two normal-size character is stored in one word. One memory table can store up to 16 words (32 characters).

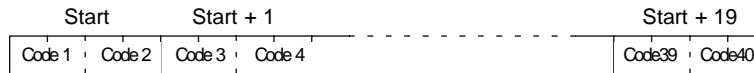

**[Character-string memory table display example]**

To display the characters in order, allocate the characters as follows.

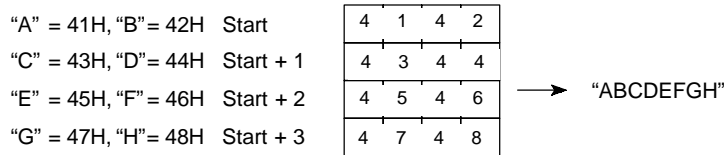

- Character allocation bestriding two words.

Provided the order is correct, it is possible to assign two digits each of a four-digit character code to successive words.

**[Example of character code bestriding words]**

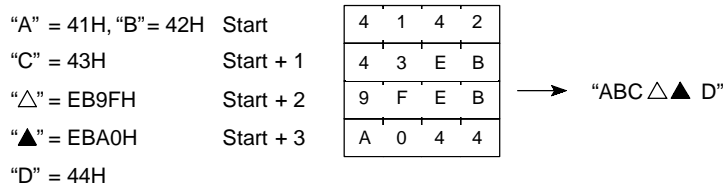

**Reference** Characters with 8-bit codes (00 to 1FH) are displayed on the screen as a one-byte space (20H). 00H is converted to 20H.

## 6-2-2 Changing Displayed Numerals or Character Strings (Changing the Contents of Allocated Words...Direct Specification)

The following describes the procedure to change displayed numerals or character-strings by changing the contents of the allocated words.

**Reference** Numerals and character-strings can be changed also by making a copy of the memory tables. Refer to "Copying the memory table" explained later.

To change the numerals or character-strings displayed on the NT600S, make changes with the numeral or character-string memory table. To make changes with the numeral or character-string memory table of the NT600S, change the contents of words by the PC.

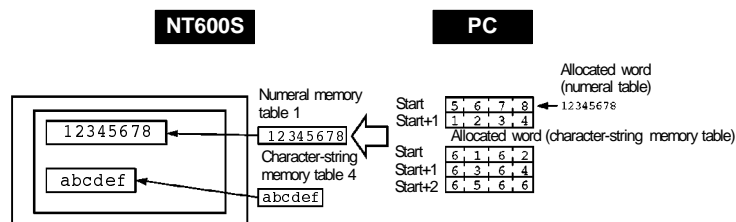



**Reference** When it is necessary to display changing data such as monitored data of words in the PC, use the numeral and character-string memory tables. This must be used to change the display contents (contents of memory table and words).

**Procedure** 1. Use the support tool to allocate the numeral and character-string memory tables to the PC memory.

2. Register the memory tables for the numerals and character-strings to be displayed when creating the screen data by using the support tool.

To display a character-string, use "character display" and specify the character-string memory table by using the support tool.

To display numerals, use "numeral display" and specify the numeral memory table by using the support tool.

3. Create a PC program to write the contents of numerals and character-strings to be displayed on the NT600S to the PC words.

- Important points when writing a character-string

If the character font for character-strings displayed on the NT600S screen is set as half height and a normal character-string is written after displaying a 2-byte code (mark), part of the mark will remain displayed, as shown below.

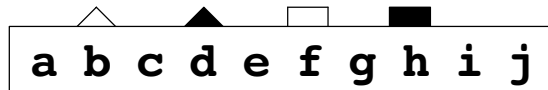

In this case, first write a 2-byte code (FF20 to FF5F) for which nothing is registered, then write a normal-size character-string.

**Application Example of the Numeral Memory Tables Allocated to the PC Words**

This example gives the procedure to directly display the contents of the words allocated as the numeral memory tables in the PC memory. The NT600S screen display will change as the contents of the PC word change.

- Support tool settings

Allocate the memory as shown below by using the support tool.

Numeral memory table entry #1: DM0000 (allocated words: 2 words)

Numeral memory table entry #2: DM0002 (allocated words: 1 word)

Screen numbers to be created: #1 and #2

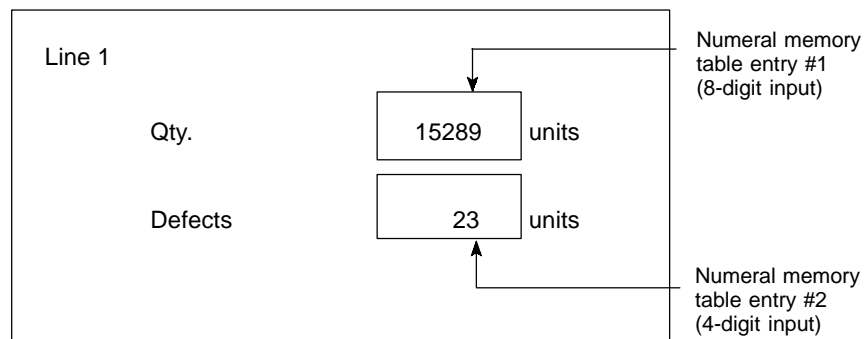

- PC ladder program

Create a PC ladder program as follows:

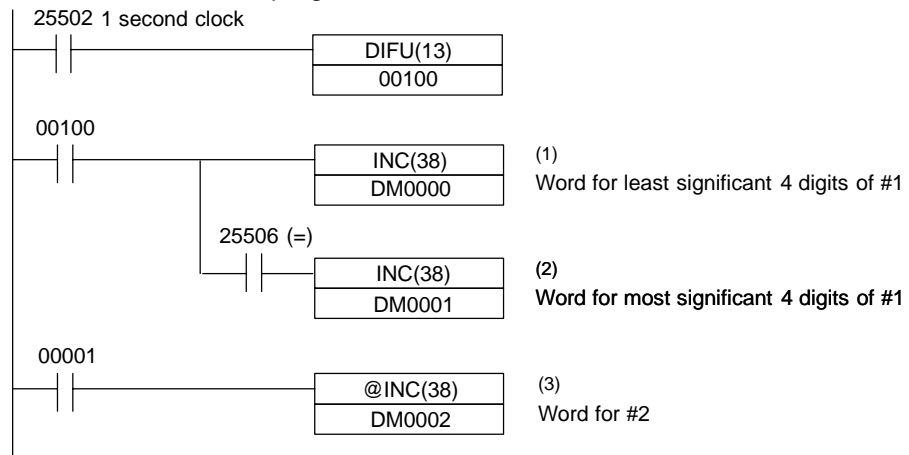

- Program operation

- (1) The contents of word DM0000 are incremented by 1 each second. The value displayed on the NT600S in numeral table entry #1 increases by 1 each second.
- (2) When the counter in (1) above causes an increase in the most significant digits, the contents of word DM0001 are incremented by 1 each second. The value displayed on the NT600S in numeral memory table entry #1 most significant digits increases by 1.
- (3) When bit 00001 turns ON, the contents of DM0002 are incremented by 1. The value displayed on the NT600S in numeral memory table entry #2 increases by 1.

### 6-2-3 Changing Displayed Numerals or Character-Strings (Changing the Contents of Allocated Words .... Indirect Specification)

When displaying numerals or character-strings, it is possible to change them indirectly by specifying a numeral memory table. The contents of the specified numeral memory table (39 in the following example case) is regarded as the memory table number used for display.

Either of the following two methods can be used to change the contents of the display.

- (1) Changing the memory table number to be displayed  
(To change the contents of numeral memory table 41, in the following example case)
- (2) Changing the contents of the memory table used for display  
(To change the contents of character-string memory table 39, in the following example case)

In this section, the procedure for changing the display contents by using method (1) is explained.

Method (2) involves changing the contents of the allocated table. For details, refer to the sections on memory table copy (page 175) and changing displayed numerals or character-strings (direct specification) (page 170).

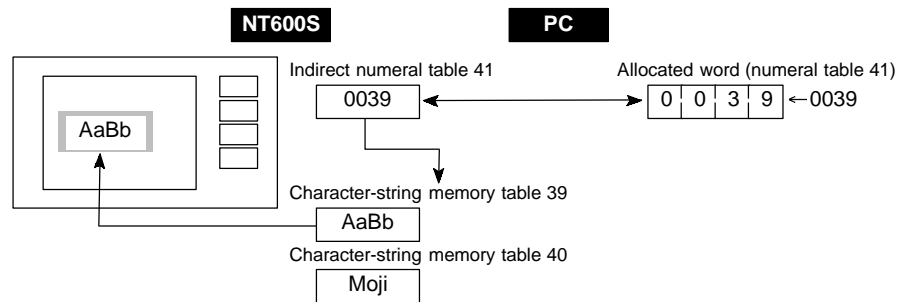

**Reference** This method is convenient when switching the display at the same location, for example when monitoring a series of words, or when using unique codes to specify individual character strings, etc.

- Procedure**
1. Set the PC area for allocation of the numeral memory table to be referenced in indirect specification using the support tool.
  2. When using the support tool to create screen data, register on the screen the numeral memory table referenced in indirect specification. Specify the “indirect” option for the reference method.  
In the case of a character string, use the “character display” function of the support tool to specify the numeral memory table.  
In the case of a numerical value, use the “numeral display” function of the support tool to specify the numeral memory table.
  3. Use the “table edit” function of the support tool to write the actually displayed data to the memory table for display. If displaying a numerical value, use a numeral memory table and if displaying a character string use a character string memory table.
  4. Create a PC program to change the contents of the word allocated to the numeral memory table referenced in the indirect specification.

- Notes on writing memory table numbers

When writing the number of the memory table for display to the numeral memory table referenced in indirect specification, always specify it in BCD. Also, be sure to specify a number within the range of memory table numbers that actually exist (Numeral memory table : 0 to 511, Character string memory table : 0 to 255). If the contents of the numeral memory table for indirect specification are specified in hexadecimal format, or the number specified is outside the valid range for memory table numbers, the display is not updated.

- Notes on writing character strings

The points to note when displaying character strings are the same as those described for direct specification. See “Important points when writing a character string” (page 171).

**Example of Changing a Character-String in Indirect Specification**

An example in which the character-strings being displayed are changed by adding the contents of the word allocated to the numeral memory table which is used in indirect specification is given below.

- Setting by the support tool

Perform the following setting with the support tool.

Numeral memory table number 51: DM0000 (registration word: 1 word)

Contents to be registered for the screen:

Numeral memory table number used for indirect specification ..... 51

Initial value of numeral memory table number 51 ..... 100

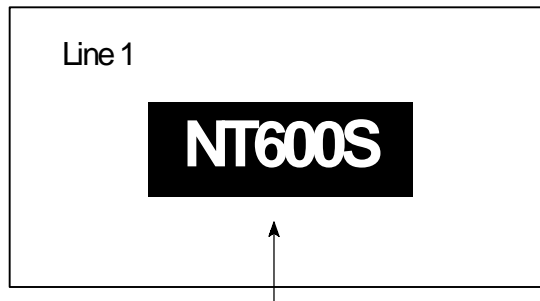

Display of character-string (specification of numeral memory table number 51 in indirect specification)

Character-string memory table settings

#	Contents	Number of Character Digits
100	NT20S	6 digits
101	NT600S	6 digits
102	NT610G	6 digits
103	NT610C	6 digits

(no word allocation)

- PC program

Create the following PC ladder program.

Make sure that the contents of the numeral table used for indirect specification will not be outside the range of table numbers used for display.

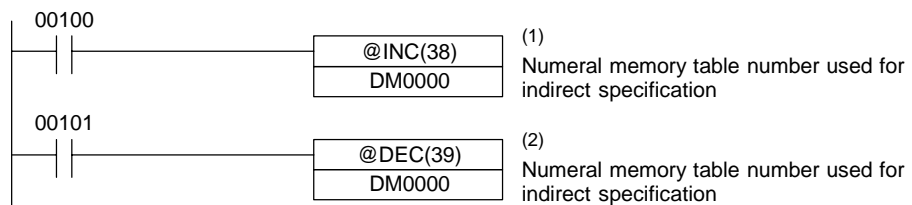

- Program operation

When the program is executed by displaying the screen on the PT, the following operation is performed.

- (1) Each time contact 00100 comes ON, the display on the NT600S changes to the next item in the following sequence.

NT20S → NT600S → NT610G → NT610C

- (2) Each time contact 00101 comes ON, the display on the PT changes to the next item in the following sequence.

NT610C → NT610G → NT600S → NT20S

## 6-2-4 Copying the Memory Table

The following describes the procedure to change displayed numerals or character-strings by copying the contents of the memory table.

**Reference** Numerals and character-strings can be changed also by changing the contents of the allocated words. Refer to “Changing displayed numerals or character-strings” explained before.

To change the numerals or character-strings displayed on the NT600S, copy the data between the numeral or character-string memory tables by using the “copy memory table setting” of the PT status control area.

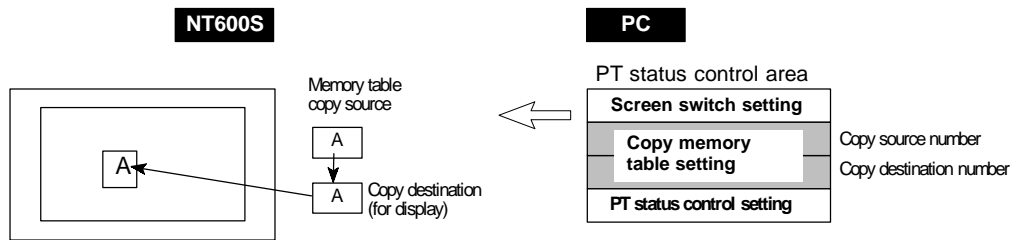

Write a memory table number etc. to the copy memory table setting area in the PT status control area in the PC memory. Data will be copied between the memory tables in the NT600S and the displayed value will change accordingly.

**Reference** This procedure is convenient to switch predetermined values or character-strings according to the situation. By preparing several units of contents, various contents can be displayed by switching them to suit the situation.

### ["Copy memory table setting" of the PT status control area]

	15	14	13	12	11	10	9	8	7	6	5	4	3	2	1	0	Bit
Word n+1	0		Copy source memory table # (3-digit BCD)														
Word n+2	Copy type		Copy destination memory table # (3-digit BCD)														

) Copy memory table setting

Copy type:

- 0: Copy between the character-string memory tables
- 1: Copy between the numeral memory tables

Copy source and destination memory table numbers: 000 to 127

Character-string memory table: 000 to 255

Numeral memory table: 000 to 511

- Available allocation words

The PT status control area can be allocated to the following PC areas:

Symbol	C Series PCs	Allocated	CVM1/CV Series PCs	Allocated
DM	Data memory	✓	Data memory	✓
CH	Internal/Special Relay	✓	Internal/Special Relay	✓
TIM	Timer	×	Timer	×
CNT	Counter	×	Counter	×
HR	Holding Relay	✓	-	
AR	Auxiliary Relay	✓	Auxiliary Relay	×
LR	Link Relay	✓	-	

✓: OK    ×: NG

**Reference** Since the special auxiliary relays of the CVM1/CV series PCs are allocated to the system, they cannot be used for purposes other than the system use.

The range of respective area varies with the type of PC. Refer to Appendix L PC Memory Map (page 291).

- Procedure**
1. Use the support tool to allocate the PT status control area (PC to PT) to the PC memory.
  2. Register the memory tables for the numerals and character-strings to be displayed when creating the screen data by using the support tool.  
 To display a character-string, use “character display” and specify the character-string memory table by using the support tool.  
 To display numerals, use “numeral display” and specify the numeral memory table by using the support tool.
  3. Set the copy source data to the memory table when creating the screen data by using the support tool.  
 Use “table edit”.
  4. Create a PC program to write the copy type, copy destination memory table number, and copy source memory table number to the “copy memory table” setting word in the PT status control area.

- Order for writing to the PT status control area (PC to PT)  
 First write the “copy destination memory table number”, and then, write the “copy source memory table number” to the PT status control area (PC to PT).  
 The NT600S reads the area sometimes when the PC is writing the settings. If the “copy source memory table number” has been written first and is changed, unexpected memory table may possibly be changed.
- Allocated words that the NT600S reads  
 The NT600S reads the allocated words in the PC for the memory tables which need to be displayed. If the copy source memory table is allocated to a PC word, it may sometimes be used at the initialization only.
- Use of the “copy type”  
 Copy will not be executed when the “copy type” is other than “0” or “1”. The memory table copy is executed only when the contents of the area are changed. To repeat copying of the same copy source and same copy destination, write a value other than “0” or “1” for the copy type, and then, write a correct value again.
- Copying a numeral memory table  
 If the display method or the number of registered words include discrepancies, a numeral memory table may not be copied and displayed correctly.

**Application Example of Copying of a Character-String Memory Table**

This example gives a PC program to switch the character-string display on the screen by using the memory table copy operation as the allocated bit is turned ON and OFF.

- Support tool settings  
 Allocate the memory as shown below by using the support tool.  
 PT status control area allocation: Word 0100  
 Contents registered to the screen: Character-string memory table #4

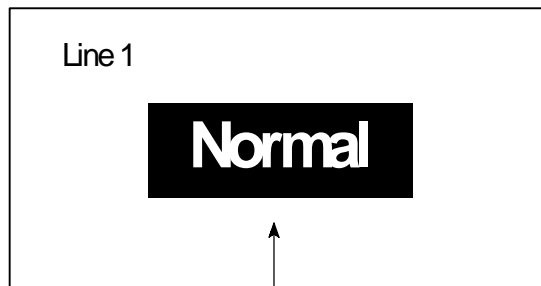

Character-string memory table #4

Character-string memory table settings

#	Contents	Number of Character Digits
4	Normal	6 digits
10	Error	6 digits
11	Normal	6 digits

• PC ladder program

Create a PC ladder program as follows:

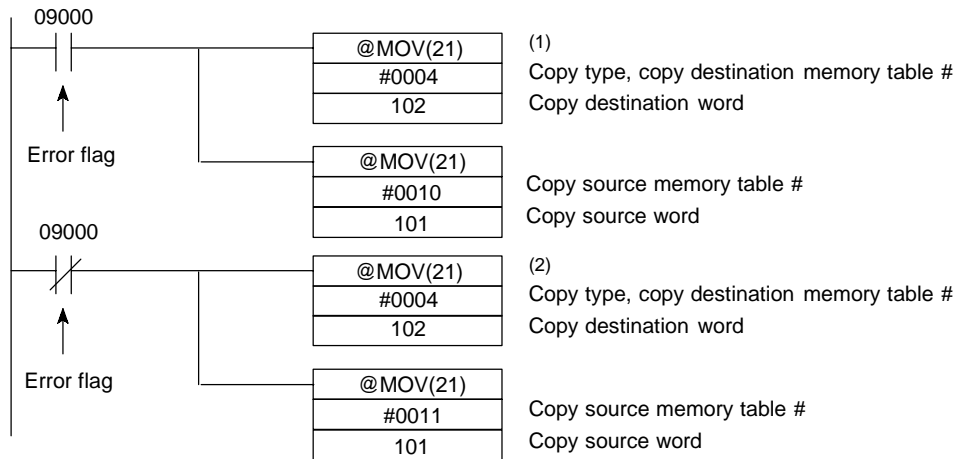

• Program operation

- (1) When an error occurs (bit 09000 turns ON), the NT600S displays the message "Error".
- (2) When the error is cleared (bit 09000 turns OFF), the NT600S display message reverts to "Normal".



## 6-2-5 Upgrading Bar Graphs (Changing the Contents of Allocated Words)

The following describes the procedure to upgrade the bar graph display on the NT600S by changing the contents of the allocated words.

To change the bar graph display on the NT600S, change the contents of the PC words to which the numeral memory tables have been allocated.

- Available allocation words

The numeral memory tables can be allocated to the following PC areas:

Symbol	C Series PCs	Allocation	CV Series PCs	Allocation
DM	Data Memory	✓	Data Memory	✓
CH	Internal/Special Relay	✓	Internal/Special Relay	✓
TIM	Timer	△	Timer	△
CNT	Counter	△	Counter	△
HR	Holding Relay	✓	–	
AR	Auxiliary Relay	✓	Auxiliary Relay	×
LR	Link Relay	✓	–	

✓ : OK    △: 1 word only    × : NG

**Reference** Since the special auxiliary relays of the CVM1/CV series PCs are allocated to the system, they cannot be used for purposes other than the system use.

The range of respective area varies with the type of PC. Refer to Appendix L PC Memory Map (page 291).

**Reference**

- The bar graph display cannot use hexadecimal numbers. If hexadecimal numbers are set, the bar graph will not be displayed.  
By writing a negative number (whose most significant digit is “F”) to the allocated word of a graph set as “Sign display “No””, the graph display will become 0 % and the % display will show “ \* \* \* %”.
- For the procedure to write numeral values to the allocated words of the numeral memory tables, refer to “Allocation Words and Display of the Memory Tables” (page 167).
- For the procedure to change the contents of the numeral memory table (PC words), refer to “Changing Displayed Numerals or Character Strings (Changing the Contents of Allocated Words)” (page 170, 172).

## 6-3 Lamps, Touch Switches, and Numeral Setting

This section describes bit allocation for lamps and touch switches and the method used to find the numeral input using the numeral setting function, when communicating with the PC using the Host link/NT link/C200H direct.

**Reference** For details on lamps, touch switches and the numeral setting function, refer to 5-6 Lamps (page 135), 5-7 Touch Switches (page 138), and 5-8 Numeral Setting (page 143).

### 6-3-1 Allocation Bits and Display of Lamps

Lamps are controlled by allocating them to the PC bits. Set the area and bit number.

- Available allocation bits

The lamps can be allocated to the following PC areas:

Symbol	C Series PCs	Allocated	CVM1/CV Series PCs	Allocated
DM	Data memory	✓	Data memory	✓
CH	Internal/Special Relay	✓	Internal/Special Relay	✓
TIM	Timer	×	Timer	×
CNT	Counter	×	Counter	×
HR	Holding Relay	✓	–	
AR	Auxiliary Relay	✓	Auxiliary Relay	×
LR	Link Relay	✓	–	

✓ : OK    × : NG

To set the data memory (DM), specify the word number and then the bit number (00 to 15).

**Reference** Since the special auxiliary relays of the CVM1/CV series PCs are allocated to the system, they cannot be used for purposes other than the system use.

The range of respective area varies with the type of PC. Refer to Appendix L PC Memory Map (page 291).

- Controlling the lamps in batch

More than one lamp can be lit or flashing in batch by registering those lamps to the same bit.

#### [Example of batch lighting]

Set the lamps L1 to L5 to the same bit number.



## 6-3-2 Turning ON (lit) and OFF (unlit) the Lamps (Changing the Contents of Allocated Bits)

The following describes the procedure to change the lamp display status on the NT600S by changing the contents of the allocated bits.

To change the lamp display status on the NT600S, turn ON and OFF the lamp control bit allocated in the PC.

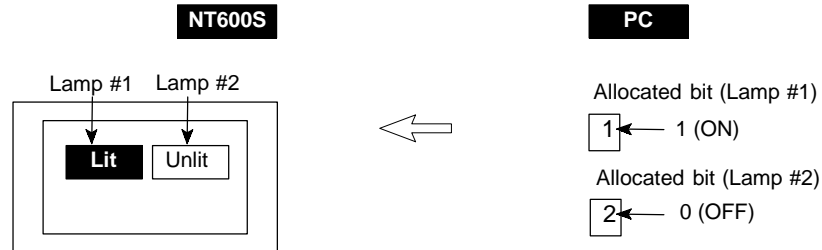

The lamp control bit indicates the lamp status as follows:

0 (OFF): Unlit

1 (ON): Lit (reverse display) or flashing

- Procedure**
1. Use the support tool to set the PC memory area where the lamp control bit is to be allocated to.
  2. Register the lamps to the screen when creating the screen data by using the support tool.
  3. Create a PC program to turn ON/OFF the lamp control bit.

**Reference** Use the support tool to set the lamp display attributes whether the lamp is lit or flashing when the lamp control bit is turned ON.

### Application Example to Make the Lamp Light or Flash

This example gives a procedure to control the bits to move a robot arm and turning the lamps ON and OFF.

- Support tool settings

Allocate the memory as shown below by using the support tool.

Lamp #0: Word 000200 (output bit to raise robot arm), guide display message "UP"

Lamp #1: Word 000201 (output bit to lower robot arm), guide display message "DOWN"

Lamp #2: Word 000202 (output bit to rotate robot arm counterclockwise), guide display message "C/CLOCK"

Lamp #3: Word 000203 (output bit to rotate robot arm clockwise), guide display message "CLOCK"

Lamp #4: Word 000204 (output bit to clamp rotate robot arm), guide display message "CLAMP"

Lamp #5: Word 000205 (output bit to unclamp rotate robot arm), guide display message "UNCLAMP"

Contents registered to the screen: Lamp #0 to #5

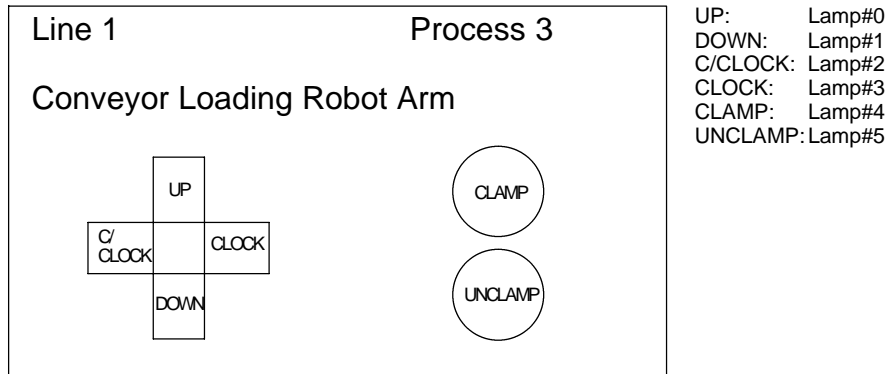

- PC ladder program

No PC ladder program is required to control the NT600S. Only a program to control the robot arm movements is required.

- Program operation

When the ladder program to control the robot arm is executed, the lamps on the NT600S screen turn ON and OFF in synchronization with the robot arm movement.

For example, lamp #0 lights when the robot arm moves up and goes out when it stops moving up.

### 6-3-3 Allocated Bits, and Display, of Touch Switches

#### Method for PC Notification and NT600S Control

Two types of bit can be allocated to touch switches: notify bits - which serve to notify statuses to the PC - and control bits, lamp bit, which control the lighting (flashing) of the touch switches. (For other types of function, only lamp bits can be allocated.) When a touch switch is pressed the notify bit status changes and, when the lamp bit is ON, the touch switch lights (or flashes).

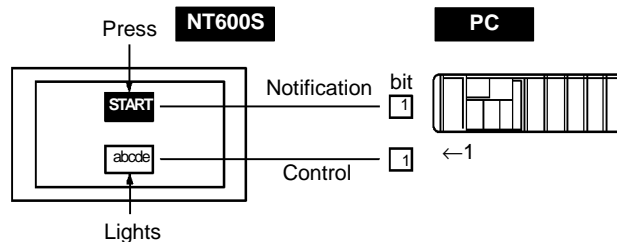

In order to notify the status of a touch switch to the PC, the touch switch must be allocated to a specified PC bit so that it can be managed. Designate the area and bit number.

To use touch switches for notification to the PC, the following settings must be made using the support tool: "touch switch" – "bit setting" – "notify bit".

- Types of notification operation

When using Ver.5 of the direct connection function, the notification operation when the touch switch is pressed can be selected from the following four types (with Ver.4 direct connection, the type is fixed as "momentary"):

- Momentary

When the touch switch is pressed the bit comes ON; when it is released the bit goes OFF.

- Alternate

Each time the touch switch is pressed, the bit status changes from ON to OFF or OFF to ON.

- Set

When the touch switch is pressed, the bit comes ON and remains ON even if the switch is pressed again.

- Reset

When the touch switch is pressed, the bit goes OFF and remains OFF even if the switch is pressed again.

- Notes on the Notification Operation

The touch switch notification operations are as follows:

Type of Notification Operation	When Using Host Link or NT Link with DM Area	When Using C200H Direct Communication or NT Link with other than DM Area
Momentary	(1)Notification in word units (other bits go OFF)	(3)Notification in bit units
Alternate Set Reset	(2)Notification in word units (however, the word contents are read on display and notification is based on this reading)	(4)Notification in bit units

When using touch switch input notification, note the following points:

- In the case of (1), the other bits in the same word as the notification bit are turned OFF by the notification operation.
- In the case of (2), notification is executed on the basis of the contents of the word before display, which means that the other bits are not rewritten. However, if the word contents are changed at the PC side, they will be rewritten based on the contents before display.
- If the screen is switched while a momentary key is being pressed, the touch switch itself disappears, so the status "OFF" is notified. In the case of (1) this means that the other bits in the word will also be turned OFF.
- When using the host link, or NT link with the DM area, do not allocate momentary touch switches and other types of touch switch to the same word, since the notification operations are different.

In the case of (3) and (4), the notification operation has no influence on the other bits in the word.

- Possible bit allocations

Notify bits and lamp bits for touch switches can be allocated to the areas of the PC memory listed in the following table.

Symbol	C Series PCs	Allocated	CVM1/CV Series PCs	Allocated
DM	Data Memory	✓	Data Memory	✓
CH	Internal/Special Relay	✓	Internal/Special Relay	✓
TIM	Timer	×	Timer	×
CNT	Counter	×	Counter	×
HR	Holding Relay	✓	-	
AR	Auxiliary Relay	✓	Auxiliary Relay	×
LR	Link Relay	✓	-	

✓ : OK    × : NG

Since all the CVM1/CV-series special auxiliary relays are allocated to the system, they cannot be used for applications not related to the system.

The range of each memory area differs according to the PC type. See "Appendix M PC Memory Map" (page 292 of the APPENDICES) for more details.

When making a data memory (DM) specification, specify the bit number (00 to 15) following the word number.

### 6-3-4 Lit (Flashing) and Unlit Touch Switch Statuses (Changing the Status of Allocated Bits)

This section describes how to change the statuses of allocated bits and thereby the statuses of the touch switches displayed by the NT600S.

The statuses of touch switches displayed by the NT600S are changed by switching the control bits allocated in the PC memory ON and OFF.

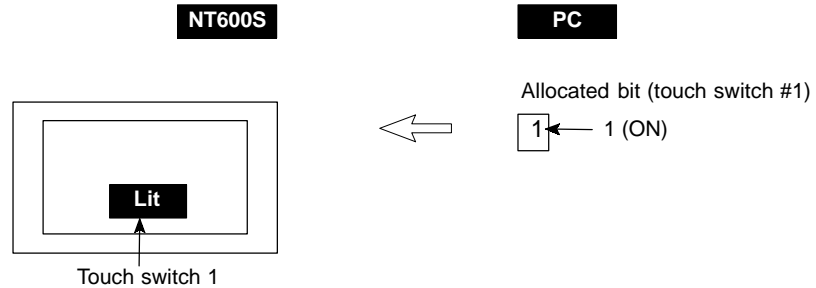

The status of the control bit reflects the touch switch status, as follows:

0 (OFF): Unlit

1 (ON): Lit (inverse display) or flashing

- Procedure**
1. Use the support tool to allocate the touch switch control bits to the PC memory.
  2. When creating the screen data using the support tool, register the touch switch for a screen.
  3. Create the PC program to switch the control bit of the touch switch ON and OFF.

**Reference** Set whether a touch switch will be continuously lit or blink when its bit has been turned ON by setting the support tool touch switch display attributes.

### 6-3-5 Notifying the PC that a Switch has been Pressed (Determining Touch Switch Status)

This section describes how the status of a touch switch (whether it has been pressed or not) is ascertained.

With the NT600S, when a touch switch is pressed, the notify bit allocated to that touch switch in the PC memory is automatically notified.

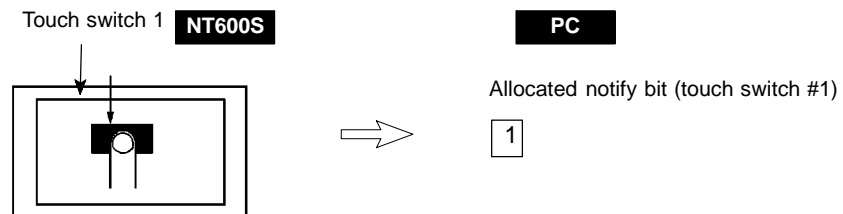

The status of the notify bit reflects the touch switch status, as follows:

Momentary: 0 (OFF) ... Not pressed  
1 (ON) ... Pressed

Alternate : The bit allocated for notification is set to 1 (ON) if currently 0, and to 0 (OFF) if currently 1.

Set : The bit allocated for notification is forcibly set to 1 (ON).

Reset : The bit allocated for notification is forcibly set to 0 (OFF).

The status of a touch switch is determined by checking the ON/OFF status of its notify bit.

The touch switch notify bits can be allocated to the following areas of the PC memory.

Symbol	C Series PCs	Allocated	CVM1/CV Series PCs	Allocated
DM	Data memory	✓	Data memory	✓
CH	Internal/Special Relay	✓	Internal/Special Relay	✓
TIM	Timer	×	Timer	×
CNT	Counter	×	Counter	×
HR	Holding Relay	✓	–	
AR	Auxiliary Relay	✓	Auxiliary Relay	×
LR	Link Relay	✓	–	

✓: OK    ×: NG

When making a data memory (DM) specification, specify the bit number (00 to 15) following the word number.

- Reference**
- It is not possible to allocate a momentary switch to the same word as an alternate/set/reset switch.
  - Since all the CVM1/CV-series special auxiliary relays are allocated to the system, they cannot be used for applications not related to the system.

The range of each memory area differs according to the PC type. See “Appendix L PC Memory Map” (page 291) for more details.

- Procedure**
1. Use the support tool to allocate the touch switch notify bits to the PC memory.
  2. When creating the screen data using the support tool, register the touch switch for a screen.
  3. Create the PC program to switch the notify bit of the touch switch ON and OFF.



• Important Points

Type of Notification Operation	When Using Host Link or NT Link with DM Area	When Using C200H Direct Communication or NT Link with other than DM Area
Momentary	(1)Notification in word units (other bits go OFF)	(3)Notification in bit units
Alternate Set Reset	(2)Notification in word units (however, the word contents are read on display and notification is based on this reading)	(4)Notification in bit units

When using touch switch input notification, note the following points:

- In the case of (1), the other bits in the same word as the notification bit are turned OFF by the notification operation.

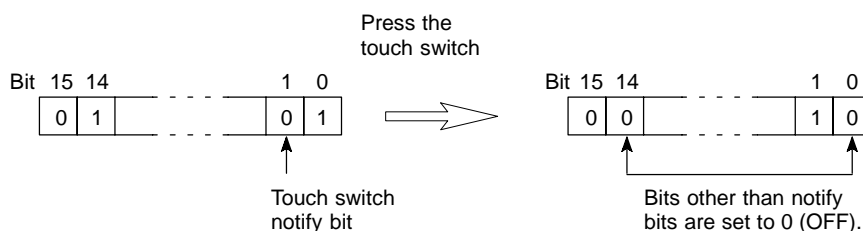

- In the case of (2), notification is executed on the basis of the contents of the word before display, which means that the other bits are not rewritten. However, if the word contents are changed at the PC side, they will be rewritten based on the contents before display.
- If the screen is switched while a momentary key is being pressed, the touch switch itself disappears, so the status "OFF" is notified. In the case of (1) this means that the other bits in the word will also be turned OFF.
- When using the host link, or NT link with the DM area, do not allocate momentary touch switches and other types of touch switch to the same word, since the notification operations are different.

In the case of (3) and (4), the notification operation has no influence on the other bits in the word.

**Application**

This example uses the touch switches as normal switches (bits) in order to use the NT600S as an operating panel.

• Support Tool Settings

Make the following settings using the support tool.

Touch switch #10:

Function "Notify Bit"

Display attribute "Light"

Control bit CH05000 (Run flag) ... Guide message: "RUN"

Notify bit CH 06000

Touch switch #11:

Function "Notify Bit"

Display attribute "Light"

Control bit CH 05001 (Stop flag) ... Guide message: "STOP"

Notify bit CH 06001

Data registered for the screen: touch switch #10, touch switch #11

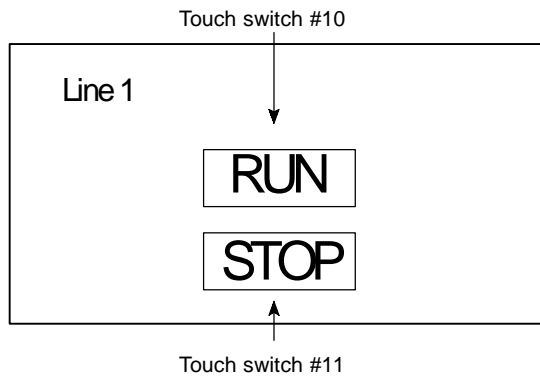

- PC program

Create the following ladder program.

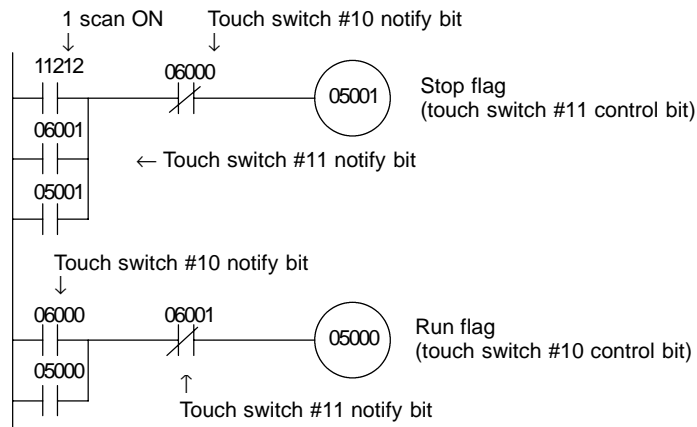

- Program operation

The operation when the program is executed is presented below.

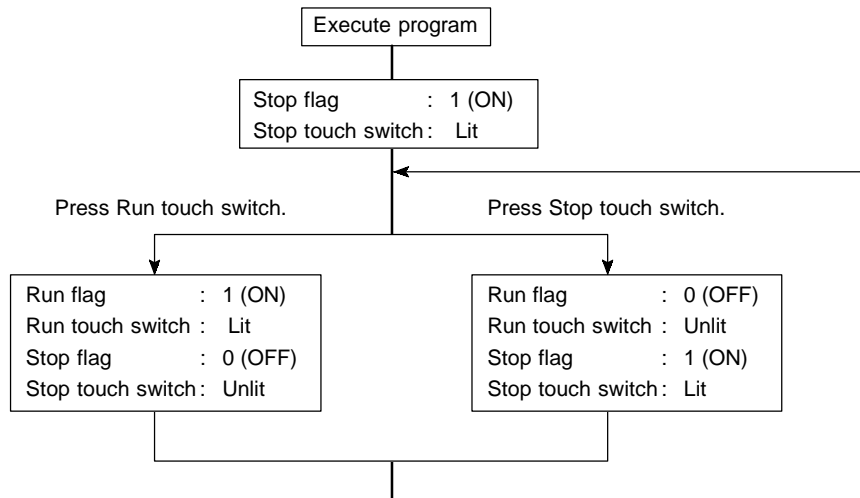

### 6-3-6 Notification of Numbers to the PC

This section describes how the numerical data input at an NT600S is ascertained by the PC.

In order to determine when numerical data has been input at the NT600S, the numeral setting strobe flag in the PT status notify area is used. In order to determine the upgraded numeral memory table number, the “content upgrade memory table” in the PT status notify area is used.

When numerical data is input at the NT600S, this is automatically notified to the PT status notify area (PT → PC) allocated in the PC memory as follows.

Notification of upgrade: PT status numeral setting strobe flag turned ON (1)

Upgraded numeral table number: Stored in the “content upgrade memory table”

When the PC reads the “content upgrade memory table” at the leading edge of the numeral setting strobe flag, it determines the numeral memory table number in which the numerical data that was changed at the NT600S is stored.

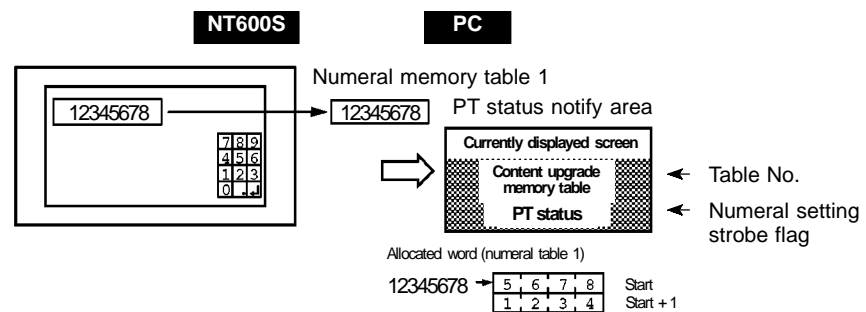

["Content upgrade memory table" in the PT status notify area and PT status]

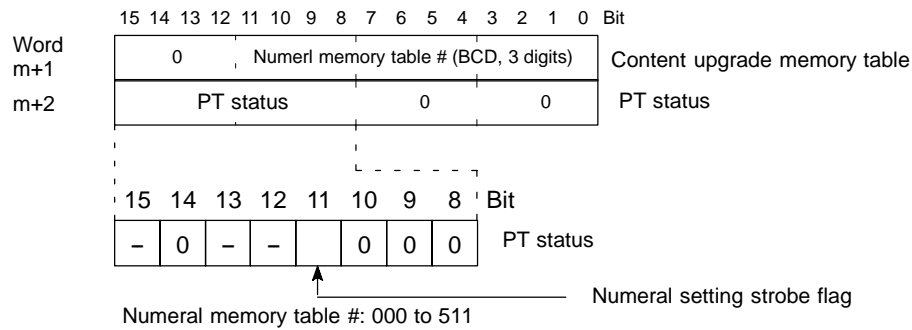

Data is written to the content upgrade memory table as three digits of BCD (binary coded decimal) data.

When the numeral setting strobe flag bit has been notified to the PC it returns to the OFF (0) status.

For details on the method for storing a number in the word allocated for the numeral table, see "Allocation Words and Display of the Memory Tables" (page 167).

• Restrictions on allocating words

The PT status notify area can be allocated to the PC memory areas listed in the following table.

Symbol	C Series PCs	Allocated	CVM1/CV Series PCs	Allocated
DM	Data memory	✓	Data memory	✓
CH	Internal/Special Relay	✓	Internal/Special Relay	✓
TIM	Timer	×	Timer	×
CNT	Counter	×	Counter	×
HR	Holding Relay	✓	-	
AR	Auxiliary Relay	✓	Auxiliary Relay	×
LR	Link Relay	✓	-	

✓: OK    ×: NG

**Reference** Since all the CVM1/CV-series special auxiliary relays are allocated to the system, they cannot be used for applications not related to the system.

The range of each memory area differs according to the PC type. See "Appendix L PC Memory Map" (page 291) for more details.

- Procedure**
1. Use the support tool to allocate the PT status notify area (PT → PC) to the PC memory.
  2. Using the support tool, create a numeral setting screen and allocate the numeral memory table to the PC memory.
  3. Create a PC program for reading the "content upgrade memory table" in the PT status notify area when the numeral setting strobe flag in the PT status notify area comes ON (1).
  4. Read the allocated word for the numeral memory table number read in step 3.

**Application Example**

This example shows the reading of the numeral memory table number after a value has been changed by inputting numerical data at the NT600S.

- Setting at the support tool

Make the following settings using the support tool.

Allocated word for the PT status notify area : CH0110

Numeral memory table entry No.3: DM 0005 (saved word: One)

Numeral memory table entry No.4: DM 0006 (saved word: One)

Data registered for the screens:

Numeral setting 1 ... Reference table "numeral memory table #3"

Numeral setting 2 ... Reference table "numeral memory table #4"

Numeral memory table entry number 3 (4-digit input)

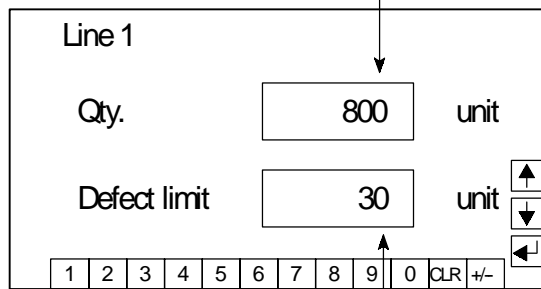

Numeral memory table entry number 4 (4-digit input)

- PC program

Create the following PC ladder program.

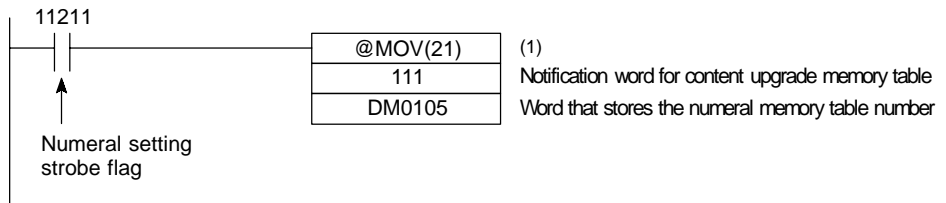

- Program operation

(1) When the numeral setting strobe flag (bit 11211) comes ON (1), the contents of CH-0111 (the word where the content upgrade memory table is located) are transferred to DM 0105. The number of the numeral memory table that contains the upgraded data is stored in DM 0105 (in this case it is 003 or 004).

If the numeral memory table is allocated to a PC word, the value input to it can be read easily by referring to the allocated word.

In this case, the contents of numeral memory table #3 are stored in DM 0005 and the contents of numeral memory table #4 are stored in DM 0006.

## 6-4 NT600S Status Control

The statuses of the NT600S can be controlled from the PC by writing control data to the "PT status control bits" of the PT status control area allocated in the PC memory.

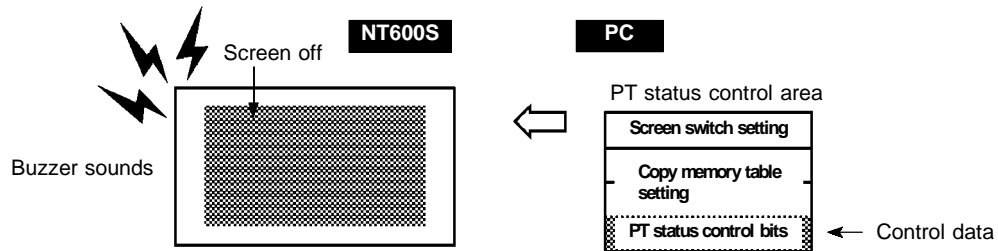

### 6-4-1 Controllable NT600S Functions

[“PT status control bits” of the PT status control area]

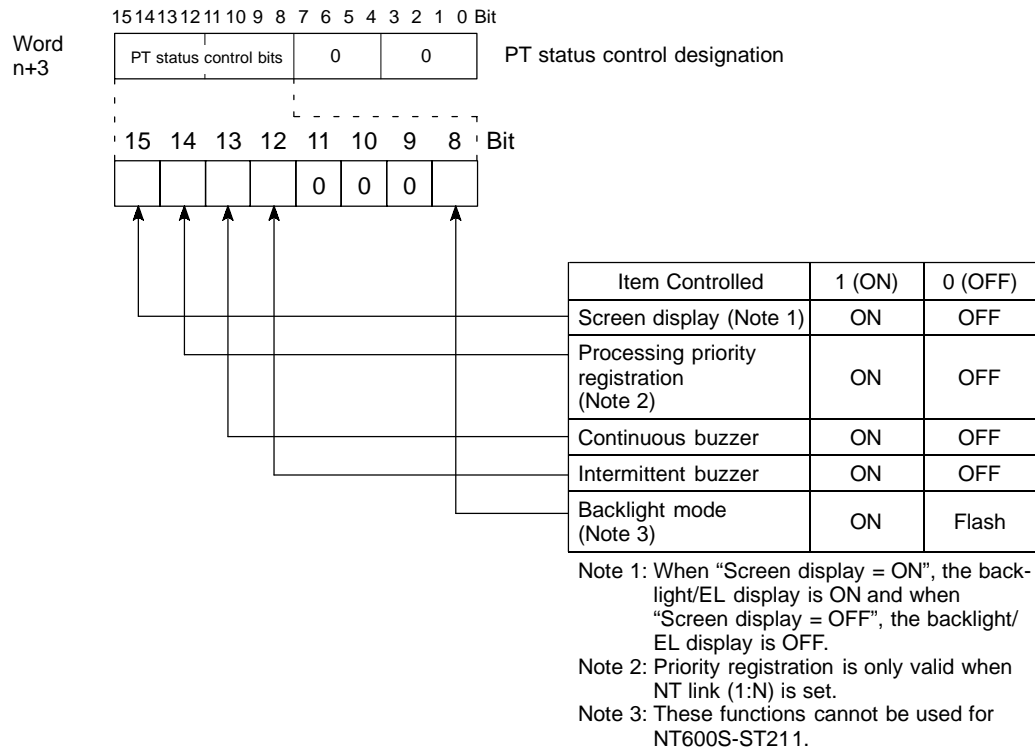

The PC status control bits remain unchanged if the NT600S status is changed with the screen attributes or memory switches, which means that the statuses of the PT status control bits do not match the actual status of the NT600S. For example, the buzzer may sound even though the setting for continuous buzzer bit 13 is "OFF".

In this kind of case, control the NT600S by using the PT status control bits.

- Screen display (bit 15)

The screen display bit is used to display and clear the screen to prevent “burn-in” on the CRT. Set bit 15 to 0 (OFF) to clear the screen. (When the LCD display unit is used, the backlight will also go OFF at the same time.)

When the screen has been cleared, the last displayed screen can be redisplayed either by turning Bit 15 ON, or by pressing a touch switch. (When the LCD display unit is used, The backlight will also light at the same time.)

**Reference** Instead of turning Bit 15 ON, a screen can be displayed by specifying its screen number. For details on screen switching, see “Switching the Screen Display” (page 160).

- Priority registration for processing (NT link 1:N connections only) (bit 14)

It is possible to register one of the multiple PTs connected by the 1:N NT link method to have processing priority. The PT for which bit 14 is set ON (1) is given priority over the other PTs and has a higher response speed for display, touch switches, etc.

When bit 14 is turned OFF (0), this registration is canceled and the normal response speed is reinstated. If priority registration is set for more than one PT, the one for which the registration was made last will have priority.

By word monitoring with C200HX/HG/HE, the unit number of the PT for which priority registration has been set can be confirmed. For details on the monitoring operation at the PC side, refer to the manual for the PC used.

**[Connection to RS-232C port of C200HX/HG/HE]**

Channel	Bit	Function
CIO265CH (standard port) CIO284CH (port A) (*) CIO285CH (port B) (*)	0	Unit No.0 Communication in progress flag, ON when connected
	1	Unit No.1 Communication in progress flag, ON when connected
	2	Unit No.2 Communication in progress flag, ON when connected
	3	Unit No.3 Communication in progress flag, ON when connected
	4	Unit No.4 Communication in progress flag, ON when connected
	5	Unit No.5 Communication in progress flag, ON when connected
	6	Unit No.6 Communication in progress flag, ON when connected
	7	Unit No.7 Communication in progress flag, ON when connected
	8	Unit No.0 Priority registration lamp, ON when registered
	9	Unit No.1 Priority registration lamp, ON when registered
	10	Unit No.2 Priority registration lamp, ON when registered
	11	Unit No.3 Priority registration lamp, ON when registered
	12	Unit No.4 Priority registration lamp, ON when registered
	13	Unit No.5 Priority registration lamp, ON when registered
	14	Unit No.6 Priority registration lamp, ON when registered
15	Unit No.7 Priority registration lamp, ON when registered	

(\*) This is the port of the communication board.

- Continuous buzzer (bit 13) and intermittent buzzer (bit 12)

In the case of both buzzers, when the respective bit is ON the buzzer sounds and when it is OFF the buzzer does not sound.

The “continuous buzzer” sounds continuously without interruption.

The “intermittent buzzer” sounds for 0.5 seconds at 0.5 second intervals.

If both Bit 13 and Bit 12 are turned ON simultaneously, Bit 13 takes priority and the continuous buzzer is selected.

- 
- Reference**
- Another way to stop a buzzer sounding is to use a touch switch to which the buzzer stop attribute function is allocated.
  - Whether or not the buzzer actually sounds also depends on the setting of the “buzzer” memory switch of the NT600S. For details on this setting, see “Using the buzzer” (page 94).
    - Besides operations with the PT status bits, the buzzer status can also be controlled using the screen attributes.
    - The screen attributes are set with the support tool.
    - Buzzer attribute: The setting for this attribute determines whether the buzzer is sounded or not and the type of buzzer sound if it is sounded.
- 

- Backlight mode (bit 8) (NT600S-ST121 only)

If bit 8 is turned ON when the screen is displayed (bit 15 = ON), the screen is made to flash using the backlight. When bit 8 is turned OFF, normal display is resumed.

When the screen is not displayed (bit 15 = OFF), the backlight mode is invalid.

- 
- Reference**
- It is possible to use NT600S switch settings to make the backlight go off automatically after a set time during which there have been no operations.
  - Besides using PT status control bit operations, the NT600S status can also be controlled by the screen attributes. The screen attributes are set by using the support tool. The functions that can be set using the screen attributes are the following:
    - Buzzer attribute: Set whether or not the buzzer will sound when the screen is displayed and, if it sounds, the type of buzzer.
-



## 6-4-2 How to Control NT600S Functions

This section describes how to control the functions of the NT600S.

- Restrictions on allocating words

The PT status control area (PC → PT) can be allocated to the PC memory areas listed in the following table.

Symbol	C Series PCs	Allocated	CVM1/CV Series PCs	Allocated
DM	Data memory	✓	Data memory	✓
CH	Internal/Special Relay	✓	Internal/Special Relay	✓
TIM	Timer	×	Timer	×
CNT	Counter	×	Counter	×
HR	Holding Relay	✓	-	
AR	Auxiliary Relay	✓	Auxiliary Relay	×
LR	Link Relay	✓	-	

✓ : OK    × : NG

**Reference** Since all the CVM1/CV-series special auxiliary relays are allocated to the system, they cannot be used for applications not related to the system.

The range of each memory area differs according to the PC type. See “Appendix L PC Memory Map” (page 291) for more details.

- Procedure**
1. Use the support tool to allocate the PT status control area (PC → PT) to the PC memory.
  2. Create a PC program to write control data to the “PT status control bits” of the PT status control area.
- Control timing of PT status control bits

The PT status control area (PC → PT) is not read when the NT600S starts up. It is only read, and control is only executed, when the contents of the PT status control area are changed after the NT600S has been started up.

Since control of the NT600S statuses is executed after the bits corresponding to the PT status control bits have changed, to execute control again the corresponding bits must be specified again.

### Application

This example is of the NT600S being used as a warning lamp by using PT status control bits.

- Support Tool Settings

Make the following setting using the support tool.

Allocated word for the PT status control area: 0100

• PC program

Create the following PC ladder program.

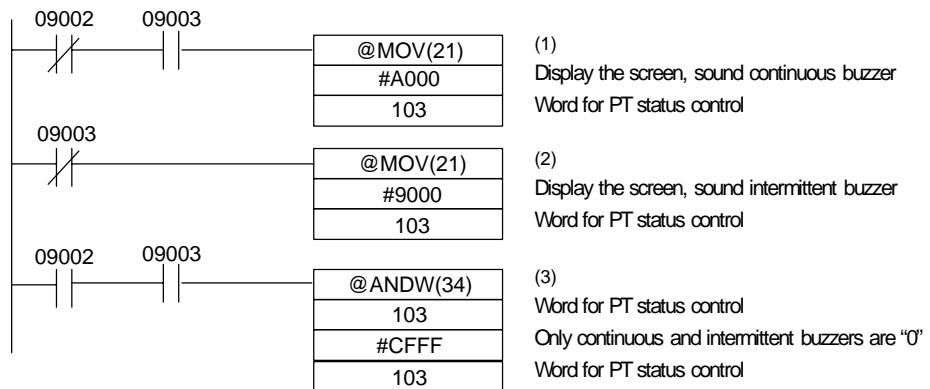

• Program operation

- (1) The PT status control bits are set as shown below when bit 09002 turns OFF. This command block is not executed when bit 09003 is ON.

Screen display (bit 15)	1 (ON)
Continuous buzzer (bit 13)	1 (ON)

The NT600S continuous buzzer sounds.

- (2) The PT status control bits are set as shown below when bit 09003 turns OFF.

Screen display (bit 15)	1 (ON)
Intermittent buzzer (bit 12)	1 (ON)

The NT600S intermittent buzzer sounds.

- (3) The PT status control bits are set as shown below when both bits 09002 and 09003 turn ON.

Continuous buzzer (bit 13)	0 (OFF)
Intermittent buzzer (bit 12)	0 (OFF)

The NT600S buzzer stops.

## 6-5 Notification of the Operating Status to the PC (Determining the NT600S Operating Status)

The status (operating statuses, etc.) of the NT600S can be determined from the PC by reading the "PT status" word in the PT status notify area allocated in the PC memory.

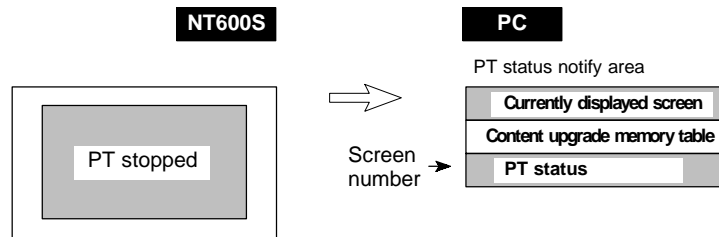

### 6-5-1 Ascertainable NT600S Statuses (Notified Operating Statuses)

["PT status notification bits" of the PT status notify area]

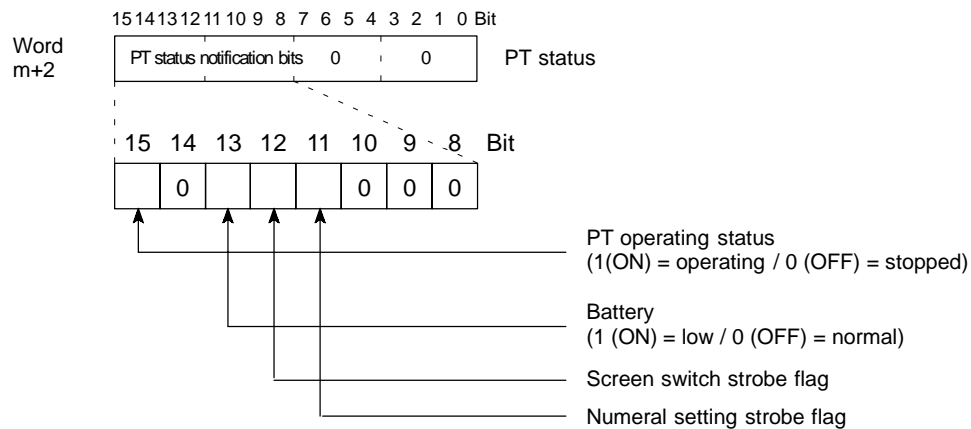

The NT600S statuses that the PC can determine are listed below.

Low voltage of battery installed in NT600S (battery: option)

NT600S operating/stopped status

Screen switches

Data input

- PT operating status (bit 15)

When the NT600S is in the RUN mode this bit is set to ON (1). In other modes and while the system menu is displayed it is OFF (0). When this bit is OFF allocated bits and words cannot be read or written to.

During the run mode, ON (1) is periodically written into this bit. In order to check whether the NT600S is operating normally or not, write OFF (0) to this bit : if it is ON (1) 30 seconds later the NT600S is running, and if it is OFF (0), the NT600S is stopped.

**⚠ Caution** In order to ensure system safety, be sure to periodically read the PT operating status bit at the host during operation to confirm that the PT is always operating correctly.

- Battery (bit 13)

If the voltage of the backup battery for the NT600S memory becomes low, this bit is set to ON (1).

- This bit is valid only when DIP switch 2-8 is ON (1).

- Backup battery is optional.

- Screen switch strobe flag (bit 12)

When the screen displayed on the NT600S is switched by a designation from the PC or by the standalone function, the screen switch strobe flag comes ON (1). On notification to the PC, it returns to the OFF (0) status.

For details on how the screen switch strobe flag is used, see “Notifying the display screen to the PC” (page 162).

- Numeral setting strobe flag (bit 11)

When numerical data is input to a numeral table using the NT600S numeral setting function, the numeral setting strobe flag comes ON (1). On notification to the PC, it returns to the OFF (0) status.

For details on how the numeral setting strobe flag is used, see “Notification of Numbers to the PC” (page 189).

## 6-5-2 Reading the NT600S Operating Statuses

This section explains how to determine the status of the NT600S, and ascertain its operating status.

To ascertain the operating status of the NT600S, “PT status” is used.

The NT600S automatically notifies information such as the operating status to the PT status word of the PT status notify area (PT → PC) allocated to the PC memory as shown below.

Notification of operation mode:	PT operating status
Notification of low battery voltage:	Battery
Notification of screen switching:	Screen switch strobe flag
Notification of numerical data upgrade:	Numeral setting strobe flag

- Restrictions on allocating words

The PT status notify area (PT → PC) can be allocated to the PC memory areas listed in the following table.

Symbol	C Series PCs	Allocated	CVM1/CV Series PCs	Allocated
DM	Data memory	✓	Data memory	✓
CH	Internal/Special Relay	✓	Internal/Special Relay	✓
TIM	Timer	×	Timer	×
CNT	Counter	×	Counter	×
HR	Holding Relay	✓	-	
AR	Auxiliary Relay	✓	Auxiliary Relay	×
LR	Link Relay	✓	-	

✓: OK    ×: NG

**Reference** Since all the CVM1/CV-series special auxiliary relays are allocated to the system, they cannot be used for applications not related to the system.

The range of each memory area differs according to the PC type. See “Appendix L PC Memory Map” (page 291) for more details.

- Procedure**
1. Use the support tool to allocate the PT status notify area (PT → PC) to the PC memory.
  2. Write a PC program to read the “PT status” word of the PT status notify area and check each bit status.

- Report timing of PT status notify bit

The information in the PC status notify area (PT → PC) is written to the PC when the NT600S status is changed during operation.

**Example of Using the PT Status Notify Bit**

An operation example in which the NT600S status is checked by operating the PT status notify bit is explained below.

- Setting by the support tool

Perform the following setting with the support tool.

PT status notify area allocated word: CH0110

PT error storage area allocated word: DM0001

- PC program

Create the following PC ladder program.

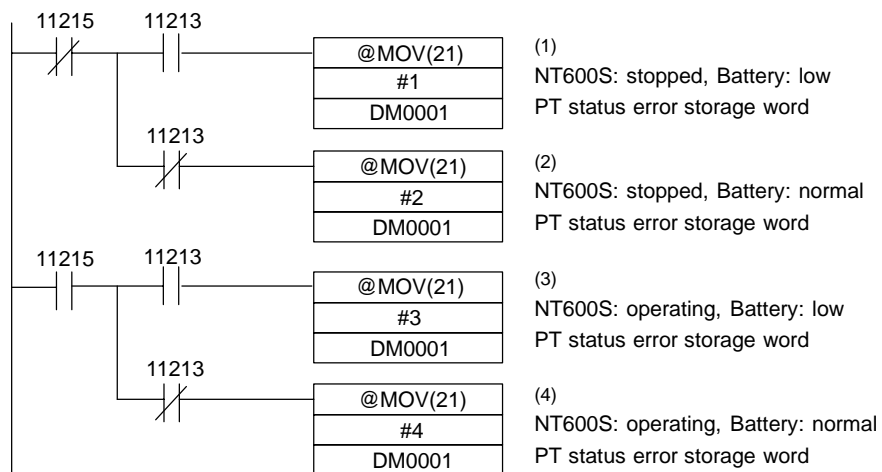

- Program operation
  - (1) If PT operating status (contact 11215) is turned OFF (0) and battery (contact 11213) is turned ON (1), "1" (NT600S stop, low battery voltage) is transmitted to DM0001.
  - (2) If PT operating status (contact 11215) is turned OFF (0) and battery (contact 11213) is turned OFF (0), "2" (NT600S stop, normal battery voltage) is transmitted to DM0001.
  - (3) If PT operating status (contact 11215) is turned ON (1) and battery (contact 11213) is turned ON (1), "3" (NT600S running, low battery voltage) is transmitted to DM0001.
  - (4) If PT operating status (contact 11215) is turned ON (1) and battery (contact 11213) is turned OFF (0), "4" (NT600S running, normal battery voltage) is transmitted to DM0001.

# SECTION 7

## Using the RS-232C Interface Unit

This section describes how to use the NT600S when it is connected to a Host using the RS-232C interface.

7-1	RS-232C Interface Unit Communications .....	202
	7-1-1 Communication Procedure .....	202
	7-1-2 Precautions .....	204
	7-1-3 Notification and Control of Touch Switches .....	205
	7-1-4 Table of Commands .....	206
7-2	Commands Sent by the Host .....	208
	7-2-1 Displaying the Screen .....	208
	7-2-2 Memory Tables .....	209
	7-2-3 Lamps and Touch Switches .....	212
	7-2-4 Controlling the NT600S Status .....	215
7-3	Commands Sent by the NT600S .....	218
	7-3-1 Screen Display .....	218
	7-3-2 Memory Table .....	218
	7-3-3 Lamps and Touch Switches .....	219
7-4	Terminal Commands .....	222
	7-4-1 Clearing the Screen .....	222
	7-4-2 Displaying a Character-String .....	222
	7-4-3 Displaying Figures .....	226
7-5	Key to Programs .....	228
	7-5-1 Use of Programs .....	228
7-6	EXAMPLE PROGRAM .....	229

## 7-1 RS-232C Interface Unit Communications

The communication procedure through the RS-232C circuit and the program flow using examples in BASIC are described below.

### 7-1-1 Communication Procedure

The Host and NT600S communicate according to the following procedure.

- 1, 2, 3... 1. The RS-232C circuit must be opened (i.e., communication enabled) before communication can start.
2. Commands are used to control the PT and to receive notification from the NT600S.
3. Close the RS-232C circuit again after communication is complete.

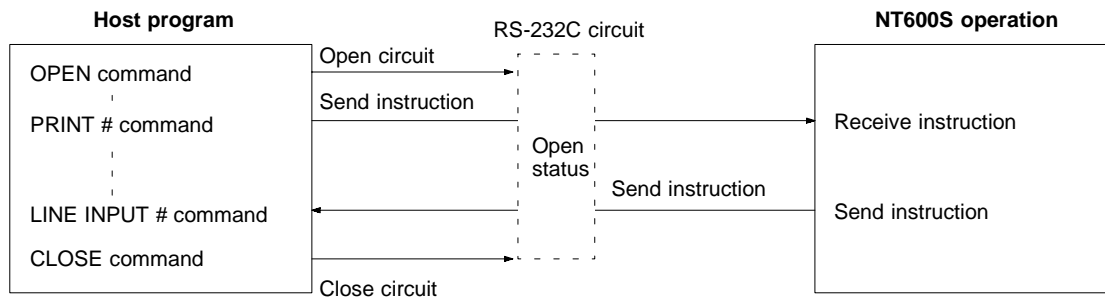

After a circuit has been opened, it can be used until it is closed again.

#### OPEN

Opens the RS-232C circuit. The Host communication conditions are also set. Refer to 4-6-4 *Setting the RS-232C Communication Conditions*.

#### PRINT #

Sends an instruction via the RS-232C circuit to the NT600S.

#### LINE INPUT #

Receives a command from the NT600S. This command is used because commands from the NT600S are not delimited by commas or double-quotation marks.

#### CLOSE

Closes the RS-232C circuit.

**Reference** Refer to the Host's BASIC Manual for more details about the commands.



### Operation by Operating Commands

The following describes control of the NT600S using the operating commands, and the flow of notifications from the NT600S.

For the actual procedure for using the operating commands, refer to 7-2 Commands Sent by the Host (page 208) and 7-3 Commands Sent by the NT600S (page 218).

The operating commands display monitored data from the production line and messages to the factory workers. They are also used for NT600S control and management.

The communication flow between the Host and NT600S differs according to the following three cases:

#### Message from Host to NT600S

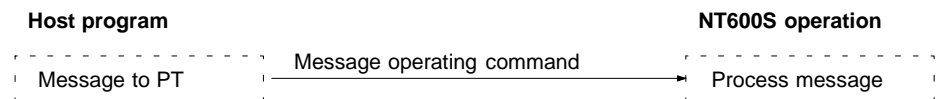

#### Enquiry from Host to NT600S

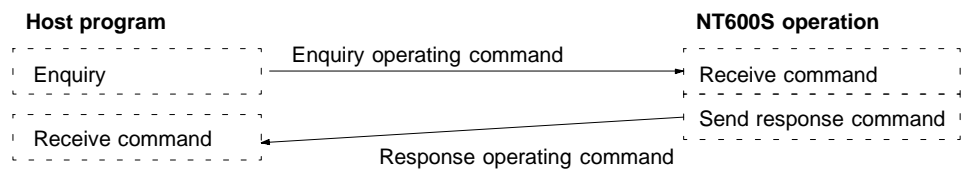

#### Notification of Operation at NT600S to the Host

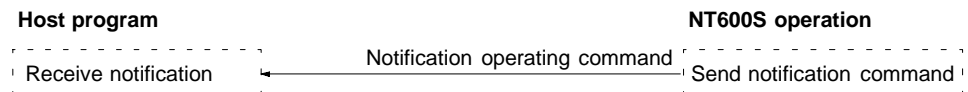

### Operation by Terminal Commands

The following describes control of the NT600S using the terminal commands.

For the actual procedure for using the terminal commands, refer to 7-4 Terminal Commands (page 222).

The terminal commands allow the NT600S to be used as a terminal of the Host to display text and graphics independently of the screens stored in the NT600S.

The Host sends a command and the NT600S processes the message. The NT600S does not send back a response to the Host.



## 7-1-2 Precautions

Some important points to consider when using commands are listed below.

### Command Length

If a mistake during command specification results in a command being too long, the correct length of the command is executed and the remainder is ignored.

A timeout error results if a mistake during command specification results in a command being too short.

### Interval Between Transmitted Commands

As a small number of bytes is transmitted by the Host, the interval between transmissions should not exceed 5 seconds if a command is divided up for transmission. A timeout error occurs if the interval between transmissions exceeds 5 seconds.

When commands are sent too frequently, a buffer overflow error may occur if the NT600S cannot keep up with the command processing.

### Controlling PT Status with Operating Commands

Control of the NT600S status by the operating commands is restricted by the NT600S memory switch settings as listed below.

Operating command	Restriction from memory switch setting
Buzzer control command [ESC] T	Effective when buzzer turned on

### Coordinate Specification with the Terminal Commands

The entire command is ignored if any point specified at coordinates X, Y with the Terminal commands lies outside the screen.

### Reference

If the "automatic reset after communication" memory switch of the NT600S is set to ON, no message is displayed when a communication error occurs.

### 7-1-3 Notification and Control of Touch Switches

If a touch switch is pressed, the corresponding touch switch number or bit information is sent to the Host. Conversely, to turn ON a touch switch or cause it to flash, the touch switch number or bit information is sent from the Host.

The type of data relating to the touch switch notification is specified with the “bit input attribute” in the screen attributes when creating the screen data with the support tool. It is not permissible to use both notification and control by a touch switch number and notification and control by bit information on the same screen.

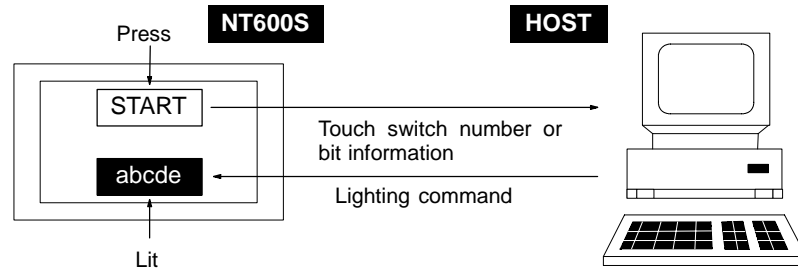

- Bit touch switch method (bit input permitted setting)  
If a touch switch is pressed, bit information is sent in accordance with the position of the touch switch. When this method is used, if more than one touch switch is pressed at the same time, the information of all the pressed touch switches (0 to 63) is reported to the Host.
- Touch switch number method (bit input not-permitted setting)  
If the touch switch status is changed, the touch switch number set when the touch switch is created is sent as a 3-digit hexadecimal number.

**Note** If the touch switches are set in the following positions using the support tool while the setting is “bit input permitted”, the following operations will occur due to the configuration of the touch switches.

Take this into consideration when setting touch switch areas.

**Example 1:**  
Touch switches are set at positions A, B, C, and D using the minimum switch setting unit.

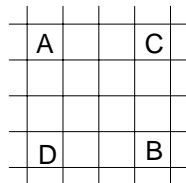

- If switches A, B, and C are turned ON at the same time, switch D is also set ON.
- Similarly, if switches A, B, and D are turned ON at the same time, switch C is also set ON.

**Example 2:**  
Touch switch areas E, F, and G are set.

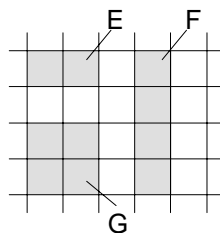

- If switches E and F are turned ON at the same time, switch G is also set ON.

## 7-1-4 Table of Commands

### Operating Commands

Type	Command	Name	Page
Screen control	[ESC] 0	Display Specified Screen	208
	[ESC] X	Request Screen Number	209
Memory table operation	[ESC] B	Write Character-string Memory Table	209
	[ESC] C	4-digit Write Numeral Memory Table	210
	[ESC] D	8-digit Write Numeral Memory Table	210
	[ESC] /	Copy Memory Table	211
Lamp and Touch Switch Display	[ESC] K	Lamp and Touch Switch Display (Bit Specification)	212
	[ESC] Q	Lamp and Touch Switch Display (Number Specification)	213
	[ESC] R	Lamp and Touch Switch Display Status Enquiry	213
Touch Switch and Function Key Input	[ESC] U	Touch Switch Disable	214
	[ESC] V	Touch Switch Enable	214
System Control	[ESC] P	Screen Display Control	215
	[ESC] T	Buzzer Control	215
	[ESC] W	System Menu Display Permission	216
	[ESC] Z	PT Status Enquiry	216
	[ESC] ]	Initialize Display History	216
	[ESC] _	Display Mode Control	217
Notification	[ESC] Y	Screen Number Response	218
	[ESC] E	4-digit Number Input Notify	218
	[ESC] F	8-digit Number Input Notify	219
	[ESC] S	Lamp and Touch Switch Display Status Response	219
	[ESC] J	Touch Switch Bit Output (from NT600S to Host)	220
	[ESC] H	Touch Switch Number Output (from NT600S to Host)	221
	[ESC] [	PT Battery Status Response	221

### Terminal Commands

Type	Command	Name	Page
Delete	[ESC] &	Clear Screen	222
Character Size	[ESC] )	Character Specify Size	222
	[ESC] *	Specify Character Enlargement	223
Character Display Attributes	[ESC] !	Normal Display	223
	[ESC] "	Set Inverse Display	224
	[ESC] #	End Inverse Display	224
	[ESC] \$	Set Flashing Display	224
	[ESC] %	End Flashing Display	225
Character String Display	[ESC] +	Set Cursor Position	225
	[ESC] 4	Specify Displayed Characters	226
Graphic Display	[ESC] 7	Draw Polyline	226
	[ESC] 8	Draw Circle	227

## 7-2 Commands Sent by the Host

The operating commands sent by the Host are described below.

**Note** All data values must be sent in ASCII code.

**Example:**

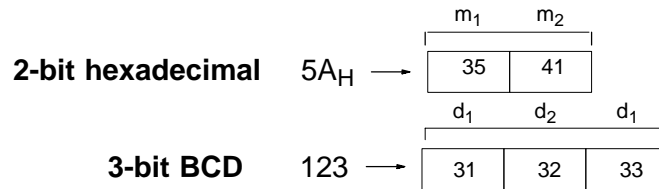

### 7-2-1 Displaying the Screen

This section describes the procedure for screen display by the Host and also that for checking the displayed screen. For details on the screen display function of the NT600S, refer to 5-2 Outline of Functions (page 119) and 5-3 Screen Display (page 124).

#### Switching the Display Screen

By sending a command from the Host, the specified screen is displayed.

If a screen number is specified by the Host using the following command, the display screen is switched to the corresponding screen (screen number: 1 to 1000). Screen number 0 is a white screen (no display).

- Continuous screens and overlapping screens
  - To display continuous screens or overlapping screens, it is necessary to specify a parent screen. If a child screen is specified, only the specified screen is displayed.

**Reference** For continuous screens and overlapping screens, refer to 5-3 Screen Display (page 124).

#### Display Specified Screen

##### Format

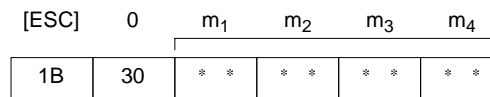

**m<sub>1</sub>m<sub>2</sub>m<sub>3</sub>m<sub>4</sub>:** Number of displayed screen (4-digit hexadecimal)  
 0000: No display  
 0001 to 03E8<sub>H</sub>: Screen #1 to #1000

##### Description

The specified screen is displayed on the NT600S when a screen number is sent from the Host with this command.

**Inquiry of the displayed screen**

A screen number can be inquired using the following command to know the number of the displayed screen.

**Request Screen Number**

**Format**

[ESC] x

1B	58
----	----

**Description**

Enquires what number screen is displayed on the NT600S. The NT600S returns the number of the displayed screen using the Screen Number Response Command (refer to 7-3 *Screen Number Response*).

**7-2-2 Memory Tables**

The procedure used for writing character-strings/numerals to memory tables from the Host is described below.

For the functions of memory tables, refer to 5-4 Memory Tables (page 128).

**Writing Character-Strings**

A character-string can be written to a character-string memory table in the NT600S using the following command.

**Write Character-string Memory Table**

**Format**

[ESC]	B	n <sub>1</sub>	n <sub>2</sub>	d <sub>1</sub>	d <sub>2</sub>	c <sub>1</sub>	c <sub>2</sub>	c <sub>3</sub>	---	c <sub>n</sub>
1B	42	* *	* *	* *	* *	* *	* *	* *	{ }	* *

**n<sub>1</sub>n<sub>2</sub>:** Character string length as a number of normal characters (2-digit hexadecimal)  
01 to 28<sub>H</sub> (1 to 40)

**d<sub>1</sub>d<sub>2</sub>:** Character-string memory table address of write destination (2-digit hexadecimal)  
00 to FF<sub>H</sub> (0 to 255)

**c<sub>1</sub>c<sub>2</sub>c<sub>3</sub> to c<sub>n</sub>:** Character-string data

**Description**

Writes the character-string data to the character-string memory table. The character-string data can contain a mixture of normal alphanumeric characters and marks. When determining the character string length, count each mark as two normal characters.

**Reference** If the actual character string is longer than the specified character string length, the specified number of characters is written and the remainder are discarded. A timeout error message is displayed if the actual character string is shorter than the specified character string length.

**Writing Numerals** A numeral (4 digits or 8 digits) can be written to a numeral table in the NT600S using the following commands.

### 4-digit Write Numeral Memory Table

**Format**



**d<sub>1</sub>d<sub>2</sub>d<sub>3</sub>**: Numeral memory table address of write destination (3-digit hexadecimal)  
000 to 1FF<sub>H</sub> (0 to 511)

**n<sub>1</sub>n<sub>2</sub>n<sub>3</sub>n<sub>4</sub>**: Number data (4-digit BCD or 4-digit hexadecimal)

**Description**

- Writes 4-digit number data (decimal or hexadecimal) to the specified numeral table.
- If a 4-digit number data is written while an 8-digit numeral is displayed, the lower 4 digits are updated.

### 8-digit Write Numeral Memory Table

**Format**

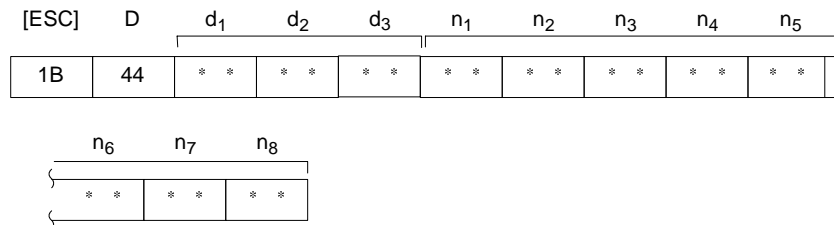

**d<sub>1</sub>d<sub>2</sub>d<sub>3</sub>**: Numeral memory table address of write destination (3-digit hexadecimal)  
000 to 1FF<sub>H</sub> (0 to 511)

**n<sub>1</sub>n<sub>2</sub>n<sub>3</sub>n<sub>4</sub>n<sub>5</sub>n<sub>6</sub>n<sub>7</sub>n<sub>8</sub>**: Number data (8-digit BCD or 8-digit hexadecimal)

**Description**

- Writes the 8-digit number data (decimal or hexadecimal) to the specified numeral memory table
- To write a negative numeral (decimal), specify “F” for “n<sub>1</sub>” (in this case, a 7-digit numeral is written.)



**Copying the Memory Table** Use the following command to change numerals or character-strings to be displayed on the NT600S after copying the contents of a memory table.

**Copy Memory Table**

**Format**

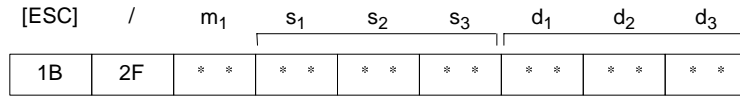

**m<sub>1</sub>**: Type of memory table  
 0 (30<sub>H</sub>): Character-string memory table  
 1 (31<sub>H</sub>): Numeral memory table

**s<sub>1</sub>s<sub>2</sub>s<sub>3</sub>**: Copy source memory table address (see table below)

**d<sub>1</sub>d<sub>2</sub>d<sub>3</sub>**: Copy destination memory table address (see table below)

Character-string memory table address	Numeral memory table address
000 to 255 (3-digit BCD)	000 to 511 (3-digit BCD)

**Description**

Copies the contents of the copy source memory table to the copy destination memory table. The memory table contents are copied to a memory table of the same type: character-string memory table to character-string memory table or numeral table to numeral memory table.

- Operation**
1. Register the memory table - which contains the numerals or character-string to be displayed - for the screen when creating the screen data using the support tool.  
  
 In the case of a character-string, use the “character-string display” mode of the support tool to specify the character-string memory table.  
  
 In the case of a numeral, use the “numeral display” mode of the support tool to specify the numeral memory table.
  2. When creating the screen data using the support tool, set the copy source data in the memory table.  
  
 Use the “table edit” mode.

**Reference** This method can be conveniently used to switch the numeral or character-string display according to the operating status. If several sets of copy source data are prepared in advance, it is possible to display the data that matches the operating status.

### 7-2-3 Lamps and Touch Switches

The procedure for changing/checking the display status of lamps and touch switches, and that for disabling input from the touch switches using commands from the Host are described below.

For the functions of lamps and touch switches, refer to 5-6 Lamps (page 135) and 5-7 Touch Switches (page 138), respectively.

**Changing the Display Status** It is possible to turn lamps and touch switches on or cause them to flash using commands from the Host.

Two methods can be used to turn specified lamps and touch switches ON/OFF using the Host: bit specification and number specification. (page 205).

The commands are described below.

#### Lamp and Touch Switch Display (Bit Specification)

**Format**

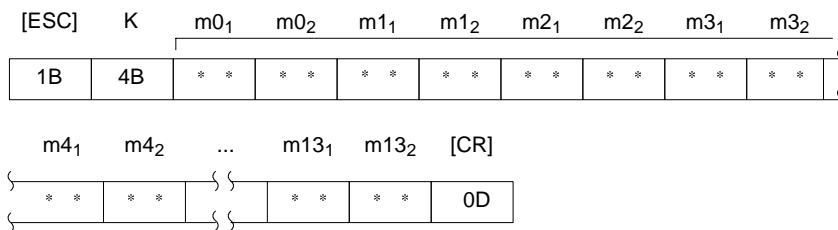

**m0,...m13:** Specification of lamps and touch switches (2-digit hexadecimal)  
 The relationship between the lamp and touch switch number and an expression of m0 to m13 in bits is given in the following table.

Parameter \ Bit	mx <sub>1</sub>				mx <sub>2</sub>			
	7	6	5	4	3	2	1	0
m0	07	06	05	04	03	02	01	00
m1	15	14	13	12	11	10	09	08
m2	23	22	21	20	19	18	17	16
m3	31	30	29	28	27	26	25	24
m4	39	38	37	36	35	34	33	32
m5	47	46	45	44	43	42	41	40
m6	55	54	53	52	51	50	49	48
m7	63	62	61	60	59	58	57	56
m8	71	70	69	68	67	66	65	64
m9	79	78	77	76	75	74	73	72
m10	87	86	85	84	83	82	81	80
m11	95	94	93	92	91	90	89	88
m12	103	102	101	100	99	98	97	96
m13	111	110	109	108	107	106	105	104

mx1: Higher 4 bits of mx (x: 0 to 13)  
 mx2: Lower 4 bits of mx

Bit ON: The lamp or touch switch is turned on (or caused to flash).

Bit OFF: The lamp or touch switch is turned off.

**Example**

To turn on lamps and touch switches with the numbers 1, 5, 6, 7, and 26

$m_0m_0m_0m_1m_1m_1m_2m_2m_2m_3m_3m_3\dots m_{13}m_{13}m_{13}$   
**E20000040000000000000000000000000**

**Description**

- Changes the display status of the lamps or touch switches.
- Whether the lamp or touch switch which corresponds to the specified bit is turned on or flashes is determined by the setting made using the support tool.

**Lamp and Touch Switch Display (Number Specification)**

**Format**

[ESC]	Q	$m_1$	$n_1$	$n_2$	$n_3$
1B	51	* *	* *	* *	* *

$m_1$ : Display status

$m_1$	Display Status
0 (30 <sub>H</sub> )	Not lit (normal display)
1 (31 <sub>H</sub> )	Lit
2 (32 <sub>H</sub> )	Flashing inverse
3 (33 <sub>H</sub> )	All not lit

$n_1n_2n_3$ : Lamp or touch switch address (3-digit hexadecimal)  
 000 to 0FF<sub>H</sub> (0 to 255)

**Description**

Changes the lamp or touch switch lighting status. Specify the display status as 3 (all not lit) to turn off all the lamps and touch switches. In this case, specify the lamp or touch switch number to any number in the permitted range.

**Reference** The display attributes set with the Support Tool determine if lamps #0 to #111 light continuously or flash. The display status set with this command is ignored.

**Enquiry of the Display Status** Use the following command to enquire whether a lamp or touch switch is displayed continuously lit or flashing by specifying its number.

**Lamp and Touch Switch Display Status Enquiry**

**Format**

[ESC]	R	$n_1$	$n_2$	$n_3$
1B	52	* *	* *	* *

$n_1n_2n_3$ : Lamp or touch switch address (3-digit hexadecimal)  
 000 to 0FF<sub>H</sub> (0 to 255)

**Description** Enquires the status of a lamp or touch switch specified by its address.  
 The NT600S returns the Lamp and Touch Switch Display Status Response Command (refer to 7-3 Lamp and Touch Switch Display Status Response) to report the display status.

**Disabling/Enabling the Touch Switch Input**

It is possible to enable or disable input from the touch switches on the displayed screen.  
 The following commands are used for this control.

**Touch Switch Disable**

**Format**

[ESC] U m<sub>1</sub>

1B	55	* *
----	----	-----

**m<sub>1</sub>:** Switch whose input is to be disabled.  
 0 (30<sub>H</sub>): Touch switches  
 2 (32<sub>H</sub>): Touch switches

**Description** Disables touch switch and function key input and notification to the Host.

**Reference** Use the Touch Switch Enable Command (refer to 7-2-3 Touch Switch Enable) to use a disabled touch switch again. Disabled touch switches are also enabled when the NT600S power is turned off.

**Touch Switch Enable**

**Format**

[ESC] V m<sub>1</sub>

1B	56	* *
----	----	-----

**m<sub>1</sub>:** Switch whose input is to be enabled.  
 0 (30<sub>H</sub>): Touch switches  
 2 (32<sub>H</sub>): Touch switches

**Description** Enables input and notification to the Host of a disabled touch switch or function key.

**Reference** Disabled touch switches are also enabled when the NT600S power is turned off.

## 7-2-4 Controlling the NT600S Status

The NT600S status can be controlled by the Host.

### Turning OFF the Backlight / Preventing Afterimage

By turning off the backlight or the screen using the following command, the backlight service life can be maximized when using the LCD model NT600S and the generation of afterimages can be prevented when using the EL model NT600S.

### Screen Display Control

#### Format

[ESC] P m<sub>1</sub>

1B	50	* *
----	----	-----

**m<sub>1</sub>:** Display on or off  
 0 (30<sub>H</sub>): on  
 1 (31<sub>H</sub>): off

#### Description

Turns off the backlighting of LCD model PTs; turns off the entire display of EL model PTs.

#### Reference

The display is switched back on when any point on the NT600S's screen is pressed.  
 The specified screen is displayed when the Display Specified Screen Command (refer to 7-2-1 *Display Specified Screen*) is transferred.

### Turning the Buzzer ON/OFF

By using the following command, it is possible to control the ON/OFF status of the buzzer built into the NT600S from the Host.

Two buzzer modes are provided; continuous beep and short intermittent beep.

### Buzzer Control

#### Format

[ESC] T m<sub>1</sub>

1B	54	* *
----	----	-----

**m<sub>1</sub>:** Buzzer status  
 0 (30<sub>H</sub>): Buzzer off  
 1 (31<sub>H</sub>): Continuous buzzer  
 2 (32<sub>H</sub>): Short intermittent buzzer  
 3 (33<sub>H</sub>): Long intermittent buzzer

#### Description

Controls the NT600S buzzer.

#### Reference

The buzzer turned on with this command can be stopped with a stop command, by displaying a screen with no buzzer attributes.  
 It is also possible to stop the buzzer using the "buzzer stop key (230)", which is one of the system keys.

**Displaying the System Menu** By using the following command, it is possible to enable or disable display of the NT600S system menu.

### System Menu Display Permission

**Format**

[ESC] W m<sub>1</sub>

1B	57	* *
----	----	-----

**m<sub>1</sub>:** System menu display permission/inhibition  
 0 (30<sub>H</sub>): Display permitted  
 1 (31<sub>H</sub>): Display inhibited

**Description**

System menu is displayed when “display permitted” is set, and from the system menu, selection of transmit mode or maintenance mode is possible. If “display inhibited” is set, the system menu is not displayed.

### Enquiry of the Battery Voltage Status

To check the voltage status of the built-in NT600S battery, use the following command.

**Reference** The battery is optional.

---

### PT Status Enquiry

**Format**

[ESC] Z

1B	5A
----	----

**Description**

Determines if the built-in PT battery voltage is low. The PT returns the PT Battery Status Response Command (see 7-3 *PT Battery Status Response*) to report the battery status.

Whether or not report is made is determined by the ON/OFF setting of DIW SW2-8.

### Initializing the Display History Data Memory

The display history record stored in the NT600S can be cleared (initialized) by giving the following command from the Host.

For details of the display history function, refer to Display History (page 110).

### Initialize Display History

**Format**

[ESC] ]

1B	5D
----	----

**Description**

- Deletes the entire contents of the display history.

**Controlling the LCD Screen** When the LCD screen is used, the normal or inverse display mode can be selected by using the following command.

**Display Mode Control**

**Format**

[ESC] \_ m<sub>1</sub>

1B	5F	* *
----	----	-----

**m<sub>1</sub>**: Specifies the display mode:  
 0(30<sub>H</sub>): Normal display (white background)  
 1(31<sub>H</sub>): Inverse display (black background)

**Description**

- Controls the display mode of the LCD (liquid crystal display) screen.

**Reference**

This command is only valid for the following PTs:  
 NT600S-ST121-V□  
 NT600S-ST121B-V□

## 7-3 Commands Sent by the NT600S

The operating commands sent by the NT600S to the Host are described below.

### 7-3-1 Screen Display

**Notifying the Display Screen** The screen number of the screen currently displayed on the NT600S is sent to the Host on execution of the following command.

#### Screen Number Response

Format

[ESC]	Y	m <sub>1</sub>	m <sub>2</sub>	m <sub>3</sub>	m <sub>4</sub>	[CR]
1B	59	* *	* *	* *	* *	0D

**m<sub>1</sub>m<sub>2</sub> m<sub>3</sub>m<sub>4</sub>:** Number of displayed screen (4-digit hexadecimal)  
0000 to 03E8<sub>H</sub> (0 to 1,000)

Description

- The NT600S returns this command to report the currently displayed screen number to the Host in response to the Request Screen Number Command (refer to 7-2-1 Request Screen Number) sent from the Host.
- The new screen number is report to the Host with this command after the displayed screen is switch with the Stand-alone functions (screen switch function).
- If the screen is switched by pressing a touch switch, the screen number of the newly displayed screen is sent to the Host by executing this command.

### 7-3-2 Memory Table

**Notifying Input to the Numeral Memory Table**

The 4-digit or 8-digit number data input to the numeral memory table of the NT600S is sent to the Host by executing the following commands.

#### 4-digit Number Input Notify

Format

[ESC]	E	d <sub>1</sub>	d <sub>2</sub>	d <sub>3</sub>	n <sub>1</sub>	n <sub>2</sub>	n <sub>3</sub>	n <sub>4</sub>	[CR]
1B	45	* *	* *	* *	* *	* *	* *	* *	0D

**d<sub>1</sub>d<sub>2</sub>d<sub>3</sub>:** Numeral memory table address to which number was input (3-digit hexadecimal)  
000 to 1FF<sub>H</sub> (0 to 511)

**n<sub>1</sub>n<sub>2</sub>n<sub>3</sub>n<sub>4</sub>:** Input number data (4-digit BCD)



**Description** A number with 4 transferred digits set with the NT600S number setting function is reported to the Host with this command.

**8-digit Number Input Notify**

**Format**

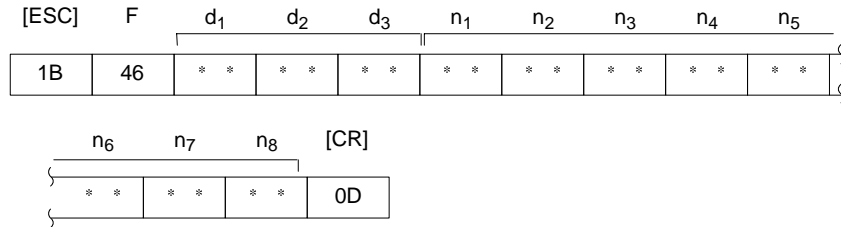

**d<sub>1</sub>d<sub>2</sub>d<sub>3</sub>**: Numeral memory table address to which number was input (3-digit hexadecimal)  
000 to 1FF<sub>H</sub>

**n<sub>1</sub>n<sub>2</sub>n<sub>3</sub>n<sub>4</sub>n<sub>5</sub>n<sub>6</sub>n<sub>7</sub>n<sub>8</sub>**: Input number data (8-digit BCD)

**Description** A number with 8 transferred digits set with the PT number setting function is reported to the Host with this command.

**7-3-3 Lamps and Touch Switches**

**Notifying the Display Status** The lit/flashing status of the lamps and touch switches which are set on the screen currently displayed on the NT600S is sent to the Host by executing the following command.

**Lamp and Touch Switch Display Status Response**

**Format**

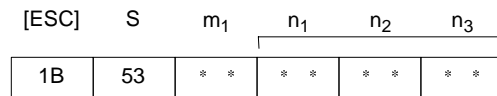

**m<sub>1</sub>**: Display status

m <sub>1</sub>	Display status
0 (30 <sub>H</sub> )	Not lit (normal display)
1 (31 <sub>H</sub> )	Lit
2 (32 <sub>H</sub> )	Flashing inverse

**n<sub>1</sub>n<sub>2</sub>n<sub>3</sub>**: Lamp or touch switch address (3-digit hexadecimal)  
000 to 0FF<sub>H</sub> (0 to 255)

**Description** The NT600S returns this command to report the lamp or touch switch number display status to the Host in response to the Lamp and Touch Switch Display Status Enquiry Command (see 7-2-3) sent from the Host.

**Reference** Lamps 0 to 111 are reported as being lit when in the “flashing inverse” status.

**Notifying that a Touch Switch Has Been Pressed**

When “On” is set for “Bit In” when setting the screen attribute with the support tool, the “touch switch pressed” status is sent to the Host in the bit information.

If “Off” is set for “Bit In”, the address corresponding to the touch switch is sent to the Host in a 3-digit hexadecimal value when the touch switch is pressed.

The commands used for this report are described below.

**Touch Switch Bit Output (from NT600S to Host)**

**Format**

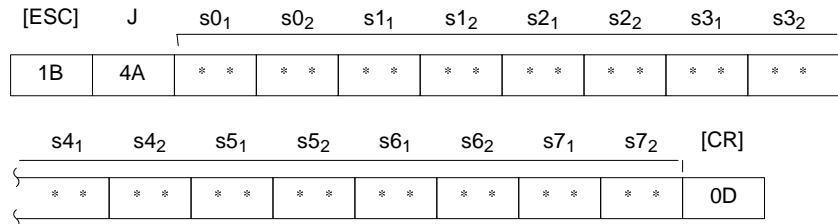

**s0,...s7:** Status of the touch switch (2-digit hexadecimal value for each switch)  
 The relationship between the touch switch number and an expression of s0 to s7 in bits is given in the following table.

Parameter \ Bit	sX <sub>1</sub>				sX <sub>2</sub>			
	7	6	5	4	3	2	1	0
s0	07	06	05	04	03	02	01	00
s1	15	14	13	12	11	10	09	08
s2	23	22	21	20	19	18	17	16
s3	31	30	29	28	27	26	25	24
s4	39	38	37	36	35	34	33	32
s5	47	46	45	44	43	42	41	40
s6	55	54	53	52	51	50	49	48
s7	63	62	61	60	59	58	57	56

sx1: Higher 4 bits of sx (x: 0 to 7)  
 sx2: Lower 4 bits of sx

Bit ON: The touch switch is on.  
 Bit OFF: The touch switch is off.

**Example**

Touch switches at addresses 0, 3, 21, and 27 are ON

**s0<sub>1</sub>s0<sub>2</sub>s1<sub>1</sub>s1<sub>2</sub>s2<sub>1</sub>s2<sub>2</sub>s3<sub>1</sub>s3<sub>2</sub>...s7<sub>1</sub>s7<sub>2</sub>=0900200800000000**

**Description**

- If the touch switch status is changed while the screen for which the “Bit Input, Touch Switch” attribute is set is displayed, the status of the corresponding bit is reported to the Host.
- This report is made each time a touch switch is turned ON or OFF.

### Touch Switch Number Output (from NT600S to Host)

**Format**

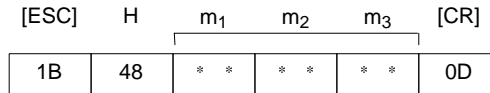

**m<sub>1</sub>m<sub>2</sub> m<sub>3</sub>:** Address of the pressed touch switch (3-digit hexadecimal)  
 000 to 0E2<sub>H</sub>, 0E7 to 0FE<sub>H</sub> (0 to 226, 231 to 254)

**Description**

If a touch switch is pressed while the screen for which the “Bit In = Off” attribute is set is displayed, the address of the pressed touch switch is reported to the Host.

**Reference**

- If more than one touch switch is pressed at the same time, only the address of the touch switch which was pressed first is reported to the Host.
- When a touch switch which is set as a ten key switch (231 to 254) is pressed, it is not reported to the Host.
- When a touch switch which is set as a system key (227 to 230, 255) is pressed, it is not reported to the Host.

**Notifying Low Battery Voltage**

The status of the battery in the NT600S is sent to the Host by executing the following command.

### PT Battery Status Response

**Format**

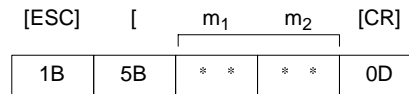

**m<sub>1</sub>m<sub>2</sub>:** Battery voltage status (2-digit hexadecimal)  
 00 (30<sub>H</sub> 30<sub>H</sub>): Normal voltage  
 01 (30<sub>H</sub> 31<sub>H</sub>): Low voltage

**Description**

The NT600S returns this command to report the battery voltage status to the Host in response to the PT Battery Status Enquiry Command (refer 7-2-4 *PT Battery Status Enquiry*) sent from the Host.

Whether or not report is made is determined by the ON/OFF setting of DIW SW2-8.

## 7-4 Terminal Commands

Terminal commands allow the display of information from the Host as text and graphics, independently of the screen stored in the NT600S.

**Reference** All data values must be sent in ASCII code.

**Example:**

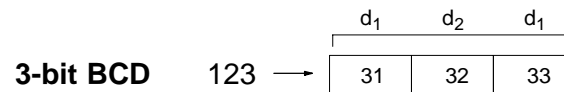
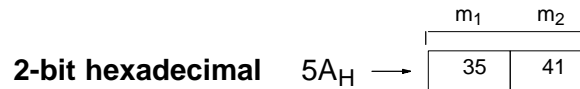

### 7-4-1 Clearing the Screen

The screen displayed on the NT600S can be cleared by the following command.

#### Clear Screen

**Format**

[ESC]    &

1B	26
----	----

**Description**

Clears all text and graphics on the NT600S screen.

**Reference** After the display of number, text, lamps or touch switches is upgraded, only the upgraded parts are re-displayed.

### 7-4-2 Displaying a Character-String

**Specifying the Character Size**

The size (normal or 1/2 size) of characters to be displayed can be specified by the following command.

#### Character Specify Size

**Format**

[ESC]    )     $m_1$

1B	29	* *
----	----	-----

**$m_1$ :** Character size

0 ( $30_H$ ): Normal size, 16 x 8 dots (H x W)

1 ( $31_H$ ): 1/2 size, 8 x 8 dots (H x W)

**Description**

Specifies if 1-byte alphanumeric characters sent subsequently are displayed as normal characters or 1/2-size characters.

- 
- Reference**
- The character string is specified with the Specify Displayed Characters Command (refer to 7-4-2 *Specify Displayed Characters*).
  - Both normal characters and 1/2-size characters are enlarged as specified by the Specify Character Enlargement Command (refer to 7-4-2 *Specify Character Enlargement* below).
  - The character size specified with this command remains valid until the screen display is switched or another character size is specified with the command. The default character size is normal characters.
- 

### Specifying the Character Scale

The enlargement scale for displaying the characters or marks on the screen can be specified by the following command.

### Specify Character Enlargement

#### Format

[ESC] \* m<sub>1</sub>

1B	2A	* *
----	----	-----

**m<sub>1</sub>:** Character enlargement

0 (30<sub>H</sub>): No enlargement

1 (31<sub>H</sub>): Enlarge height x 2

2 (32<sub>H</sub>): Enlarge width x 2

3 (33<sub>H</sub>): 2 x 2 enlargement

4 (34<sub>H</sub>): 3 x 3 times enlargement

5 (35<sub>H</sub>): 4 x 4 times enlargement

6 (36<sub>H</sub>): 8 x 8 times enlargement

9 (39<sub>H</sub>): 8 x 8 times enlargement

#### Description

All text and marks sent after this command are displayed in the specified size.

- 
- Reference**
- The character string is specified with the Specify Displayed Characters Command (refer to 7-4-2 *Specify Displayed Characters*).
  - The enlargement specified with this command remains valid until the screen display is switched or another enlargement is specified with the command. The default enlargement is no enlargement.
- 

### Canceling the Inverse/Flashing Display

The set display mode (inverse, flashing, flashing inverse) is canceled by the following command, returning the screen to the normal display.

### Normal Display

#### Format

[ESC] !

1B	21
----	----

#### Description

Cancels all display attribute settings (inverse, flashing, flashing inverse) for characters and marks so that all characters are displayed as "normal" characters (not inverse or flashing).

## Specifying the Inverse Display

Use the following command to set the inverse display mode.

### Set Inverse Display

#### Format

[ESC] "

1B	22
----	----

#### Description

Sets the display attribute to inverse so that all characters and marks sent subsequently are highlighted. Other attributes remain unchanged.

- 
- Reference**
- The Set Inverse Display Command is cancelled by the End Inverse Display Command or the Normal Display Command.
  - The setting with this command remains valid until the screen display is switched or another display attribute setting is made. The default display attributes are set to a normal display when a screen is initially displayed.
  - Use this command with the Set Flashing Display Command (refer 7-4-2 *Set Flashing Display*) to produce a flashing inverse display.
- 

## Canceling the Inverse Display

Use the following command to cancel the inverse display mode.

### End Inverse Display

#### Format

[ESC] #

1B	23
----	----

#### Description

Clears the inverse display attribute so that all characters and marks sent subsequently are not highlighted. Other attributes remain unchanged.

- 
- Reference**
- The inverse display attribute is set with the Set Inverse Display Command.
  - The setting with this command remains valid until the screen display is switched or another display attribute setting is made. The default display attributes are set to a normal display when a screen is initially displayed.
- 

## Specifying the Flash Display

Use the following command to set the flash display mode.

### Set Flashing Display

#### Format

[ESC] \$

1B	24
----	----

#### Description

Sets the display attribute to flashing so that all characters and marks sent subsequently are displayed flashing. Other attributes remain unchanged.

- Reference**
- The Set Flashing Display Command is cancelled by the End Flashing Display Command or the Normal Display Command (refer to 7-4-2 *Normal Display* and 7-4-2 *End Flashing Display*).
  - The setting with this command remains valid until the screen display is switched or another display attribute setting is made. The default display attributes are set to a normal display when a screen is initially displayed.
  - Use this command with the Set Inverse Display Command (refer to 7-4-2 *Set Inverse Display*) to produce a flashing inverse display.

### Canceling the Flash Display

Use the following command to cancel the flash display mode.

### End Flashing Display

#### Format

[ESC] %

1B	25
----	----

#### Description

Clears the flashing display attribute so that all characters and marks sent subsequently are not flashing. Other attributes remain unchanged.

- Reference**
- The flashing display attribute is set with the Set Flashing Display Command.
  - The setting with this command remains valid until the screen display is switched or another display attribute setting is made. The default display attributes are set to a normal display when a screen is initially displayed.

### Specifying the Display Position

The display position of a character-string can be specified by the following command.

### Set Cursor Position

#### Format

[ESC]	+	x <sub>1</sub>	x <sub>2</sub>	x <sub>3</sub>	y <sub>1</sub>	y <sub>2</sub>	y <sub>3</sub>
1B	2B	* *	* *	* *	* *	* *	* *

**x<sub>1</sub>x<sub>2</sub>x<sub>3</sub>**: X coordinate (3-digit BCD)

**y<sub>1</sub>y<sub>2</sub>y<sub>3</sub>**: Y coordinate (3-digit BCD)

#### Description

X coordinate	Y coordinate
000 to 639	000 to 399

Before displaying a character string with the Terminal commands, use this command to set the bottom-left point of the first character to be displayed.

- Reference**
- The cursor position set with this command is also the bottom-left point of the first character displayed if the displayed characters are enlarged.

## Specifying the Character-string

The character-string to be displayed can be specified by the following command.

### Specify Displayed Characters

#### Format

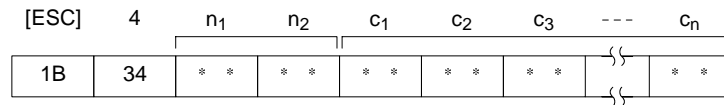

**n<sub>1</sub>n<sub>2</sub>**: Character string length as a number of normal characters (2-digit hexadecimal)

01 to 50H (1 to 80)

**c<sub>1</sub>c<sub>2</sub>c<sub>3</sub> to c<sub>n</sub>**: Character-string to display

#### Description

- The character string is displayed from the cursor position.
- The character-string data can contain a mixture of normal (alphanumeric) characters and marks. Refer to *Appendix M Special Characters* for details.
- The character string is displayed according to the enlargement and display attributes set with commands.

#### Reference

- The character string continues on the next line if it cannot fit into a single line.
- Set the position where the character string is displayed with the Set Cursor Position Command (refer to *7-4-2 Set Cursor Position*).

## 7-4-3 Displaying Figures

### Displaying the Line

Use the following command to display a polyline.

### Draw Polyline

#### Format

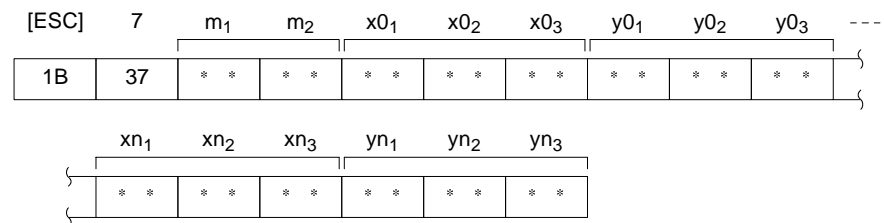

**m<sub>1</sub>, m<sub>2</sub>**: Number of lines to draw (2-digit hexadecimal)

01 to 28H (1 to 40)

**x<sub>01</sub>x<sub>02</sub>x<sub>03</sub> to xn<sub>1</sub>xn<sub>2</sub>xn<sub>3</sub>**: X coordinates of line end points (3-digit BCD)

**y<sub>01</sub>y<sub>02</sub>y<sub>03</sub> to yn<sub>1</sub>yn<sub>2</sub>yn<sub>3</sub>**: Y coordinates of line end points (3-digit BCD)

X coordinate	Y coordinate
000 to 639	000 to 399

#### Description

Draws the specified number of lines between the specified points.



**Displaying the Circle**

Use the following command to display a circle.

**Draw Circle****Format**

[ESC]	8	x <sub>1</sub>	x <sub>2</sub>	x <sub>3</sub>	y <sub>1</sub>	y <sub>2</sub>	y <sub>3</sub>	r <sub>1</sub>	r <sub>2</sub>	r <sub>3</sub>
1B	38	* *	* *	* *	* *	* *	* *	* *	* *	* *

**x<sub>1</sub>x<sub>2</sub>x<sub>3</sub>**: X coordinate of circle center (3-digit BCD)

**y<sub>1</sub>y<sub>2</sub>y<sub>3</sub>**: Y coordinate of circle center (3-digit BCD)

X coordinate	Y coordinate
000 to 639	000 to 399

**r<sub>1</sub>r<sub>2</sub>r<sub>3</sub>**: circle radius in dots (3-digit BCD)  
000 to 199

**Description**

Draws a circle of the specified radius around the circle center point.

## 7-5 Key to Programs

The following programs include all the commands that can be used with the NT600S.

### 7-5-1 Use of Programs

The sample program appears as follows on the screen.

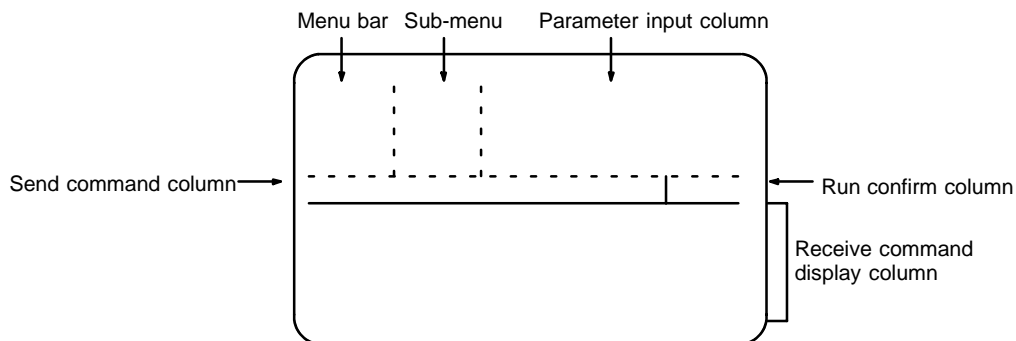

Use the program as shown below.

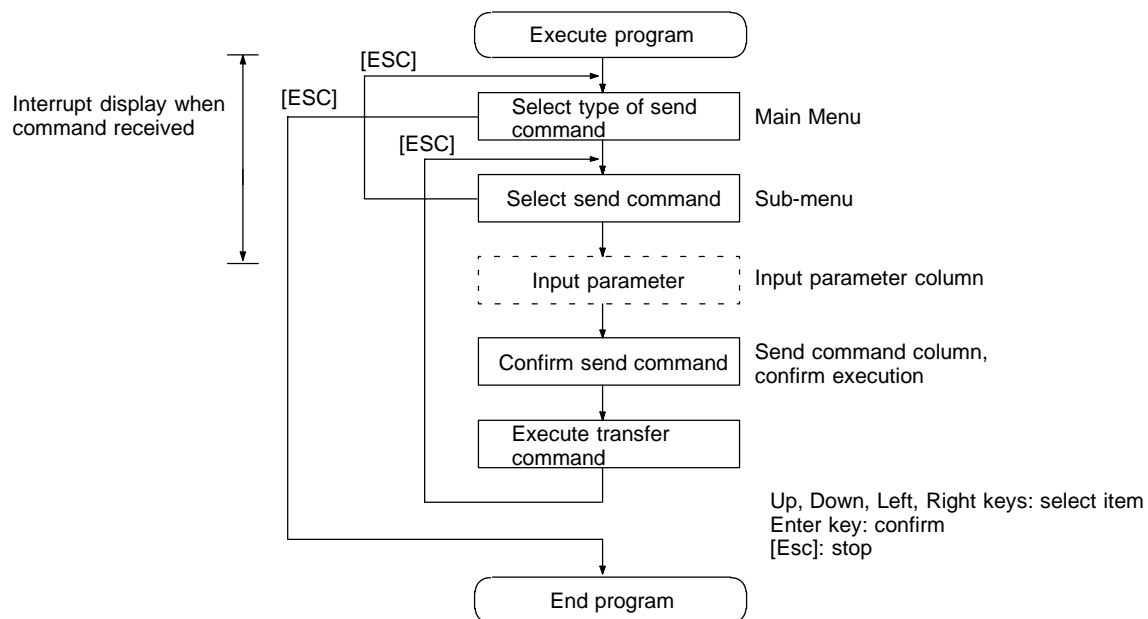

#### Note

- This sample program is written in N88BASIC (86) (NEC) for a PC-9801 computer. Modify this program for use with any other computer language or computer such as an IBM PC/AT or compatible.
- The interval between parameter input and command transmission is a hold interval for interrupt processing of the received command. If an interrupt is permitted between the interval of parameter input and a command is received, all subsequent receive interrupts are displaced. If this occurs, send an enquiry command to read all the accumulated receive data.
- When a parameter is input, no check is made that the parameter is in the permitted range. Make sure that parameters are input within the permitted range.

## 7-6 EXAMPLE PROGRAM

```

1000 ' *****
1010 ' * OPERATION COMMAND EXAMPLE PROGRAM (NT600S-ST121) *
1020 ' *****
1030 ' ..... Draw screen frame
1040 SECT=9
1050 DIM CMND$(SECT,10,1),CMND(SECT),TS.B(31)
1060 SCREEN 3:CLS 3:CONSOLE 15,10,0,0
1070 LINE (0,176)-(639,176),7,,&HF0F0
1080 LINE (159,0)-(159,176),7,,&HF0F0
1090 LINE (300,0)-(300,176),7,,&HF0F0
1100 LINE (0,16)-(159,16),7,,&HF0F0
1110 LINE (0,96)-(159,96),7,,&HF0F0
1120 LINE (0,112)-(159,112),7,,&HF0F0
1130 LINE (520,176)-(520,224),7,,&HF0F0
1140 LINE (0,223)-(639,224),7,B
1150 COLOR 0:LOCATE 2,0:PRINT "OPERATING COMMANDS"
1160 COLOR 0:LOCATE 2,6:PRINT "TERMINAL COMMANDS"
1170 CMND(0)=SECT ' ..... Set display character strings
1180 FOR I=1 TO SECT
1190   READ CMND$(0,I,0)
1200 NEXT I
1210 FOR I=1 TO SECT
1220   READ CMND(I)
1230   FOR J=1 TO CMND(I)
1240     READ CMND$(I,J,0),CMND$(I,J,1)
1250     IF CMND$(I,J,1) = "#####" THEN CMND$(I,J,1) = "[ESC]"+CHR$(&H22)
1260   NEXT J
1270 NEXT I
1280 '
1290 RY=15
1300 ON COM(1) GOSUB *RECV ' ..... Set receive interrupt routine
1310 OPEN "COM1:E81NN" AS #1 ' ..... Open communication port
1320 ' NT600S_SETTING OF ST121
1330 ' DATA BIT LENGTH 8 BITS
1340 ' STOP BIT LENGTH 1 BIT
1350 ' PARITY ODD
1360 ' FLOW CONTROL RS/CS
1370 ' BAUD RATE (VALUE SET BY SWITCH COMMAND)
1380 COM(1) ON
1390 '
1400 *LV0 ' ..... Main Menu
1410 LV=0:SECT.NO=0:SEL.NO=1
1420 GOSUB *SELECT
1430 IF SEL.NO=0 THEN GOTO *PRO.END

```

```
1440 SECT.NO = SEL.NO
1450 '
1460 *LV1 ' ..... Sub-menu
1470 LV=1:SEL.NO=1
1480 GOSUB *SELECT
1490 IF SEL.NO=0 THEN GOTO *LV0
1500 *LV2 ' ..... Branch according to command (parameter input)
1510 COM(1) STOP
1520 LV=2:SEND$=CMND$(SECT.NO,SEL.NO,1)
1530 *SECT1
1540 IF SECT.NO<>1 THEN GOTO *SECT2
1550   ON SEL.NO GOSUB *ESC.0,*ESC.X
1560 *SECT2
1570 IF SECT.NO<>2 THEN GOTO *SECT3
1580   ON SEL.NO GOSUB *ESC.B,*ESC.C,*ESC.D,*ESC.2F
1590 *SECT3
1600 IF SECT.NO<>3 THEN GOTO *SECT4
1610   ON SEL.NO GOSUB *ESC.K,*ESC.Q,*ESC.R
1620 *SECT4
1630 IF SECT.NO<>4 THEN GOTO *SECT5
1640   ON SEL.NO GOSUB *ESC.U,*ESC.V
1650 *SECT5
1660 IF SECT.NO<>5 THEN GOTO *SECT6
1670   ON SEL.NO GOSUB *ESC.P,*ESC.T,*ESC.W
1680 *SECT6
1690 IF SECT.NO<>6 THEN GOTO *SECT7
1700   ON SEL.NO GOSUB *ESC.26,*ESC.29,*ESC.2A
1710 *SECT7
1720 IF SECT.NO<>7 THEN GOTO *SECT8
1730   ON SEL.NO GOSUB *ESC.21,*ESC.22,*ESC.23,*ESC.24,*ESC.25
1740 *SECT8
1750 IF SECT.NO<>8 THEN GOTO *SECT9
1760   ON SEL.NO GOSUB *ESC.2B,*ESC.4
1770 *SECT9
1780 IF SECT.NO<>9 THEN GOTO *LV2.END
1790   ON SEL.NO GOSUB *ESC.7,*ESC.8
1800 *LV2.END ' ..... Confirm transmission
1810 LOCATE 0,12:PRINT LEFT$(SEND$,56);
1820 IF LEN(SEND$)>56 THEN PRINT "... "
1830 LOCATE 66,12:PRINT "OK?";
1840 YN=1
1850 *YN.KY.IN
1860 LOCATE 74,12:COLOR 2+2*YN:PRINT "Y";:COLOR 2-2*YN:PRINT "N";
1870 A$=INKEY$:IF A$="" THEN GOTO *YN.KY.IN
1880 IF A$=CHR$(&H1C) OR A$=CHR$(&H1D) THEN YN=YN*(-1):GOTO *YN.KY.IN
1890 IF A$<>CHR$(&HD) THEN GOTO *YN.KY.IN
```

```
1900 LOCATE 66,12:COLOR 0:PRINT SPACE$(14);
1910 IF YN=-1 THEN GOTO *LV3.END
1920 GOSUB *SEND ' ..... Send command
1930 COM(1) ON
1940 LOCATE 43,9:COLOR 4:PRINT "Press ESC Key";:COLOR 0
1950 *SND.KY.IN
1960 A$=INKEY$:IF A$<>CHR$(&H1B) THEN *SND.KY.IN
1970 *LV3.END
1980 LOCATE 0,12:PRINT SPACE$(79);
1990 FOR I=0 TO 10
2000 LOCATE 39,I:PRINT SPACE$(40);
2010 NEXT I
2020 GOTO *LV1 ' ..... Return to Sub-menu
2030 '
2040 *PRO.END ' ..... End routine
2050 COM(1) OFF:CLOSE ' ..... Close communication port
2060 CONSOLE 0,25,0,1:CLS 3
2070 END
2080 '
2090 *SEND ' ..... Send command routine
2100 SND$=CHR$(&H1B)+MID$(SEND$,6)
2110 PRINT #1,SND$
2120 RETURN
2130 '
2140 *RCV ' ..... Receive interrupt routine
2150 IF LOC(1)=0 THEN GOTO *NORCV
2160 SX=POS(0):SY=CSRLIN
2170 LINE INPUT #1,RCV$
2180 LOCATE 0,RY:COLOR 0
2190 PRINT "[ESC]";MID$(RCV$,2)
2200 R.CODE$=MID$(RCV$,2,1)
2210 *ESC.Y ' ..... Notify screen number
2220 IF R.CODE$<>"Y" THEN GOTO *ESC.E
2230 PRINT "Screen Number : ";VAL("&H"+MID$(RCV$,3,4))
2240 PRINT:GOTO *RCV.END
2250 *ESC.E ' ..... Notify 4-digit number
2260 IF R.CODE$<>"E" THEN GOTO *ESC.F
2270 PRINT "Numeral table # : ";VAL("&H"+MID$(RCV$,3,3))
2280 PRINT "Input decimal value";VAL(MID$(RCV$,6,4))
2290 PRINT:GOTO *RCV.END
2300 *ESC.F ' ..... Notify 8-digit number
2310 IF R.CODE$<>"F" THEN GOTO *ESC.H
2320 PRINT "Numeral table # : ";VAL("&H"+MID$(RCV$,3,3))
2330 IF MID$(RCV$,6,1)="F" THEN NN=0-VAL(MID$(RCV$,7,7)) ELSE
    NN=VAL(MID$(RCV$,6,8))
2340 PRINT "Input decimal value : ";NN
```

```

2350 PRINT:GOTO *RCV.END
2360 *ESC.H ' ..... Notify touch switch (number)
2370 IF R.CODE$<>"H" THEN GOTO *ESC.J
2380 PRINT "Pressed touch switch number : ";VAL("&H"+MID$(RCV$,3,3))
2390 PRINT:GOTO *RCV.END
2400 *ESC.J ' ..... Notify touch switch (bit)
2410 IF R.CODE$<>"J" THEN GOTO *ESC.S
2420 PRINT "Pressed touch switch number : ";
2430 TS=0
2440 FOR I=0 TO 13
2450   S=VAL("&H"+MID$(RCV$,3+I*2,2))
2460   FOR J=0 TO 7
2470     IF (S MOD 2)=1 THEN PRINT TS;" ";
2480     S=S\2:TS=TS+1
2490   NEXT J,I
2500 PRINT:PRINT:GOTO *RCV.END
2510 *ESC.S ' ..... Notify lamp and touch switch status
2520 IF R.CODE$<>"S" THEN GOTO *RCV.ERR
2530 PRINT "Lamp/touch switch number : ";VAL("&H"+MID$(RCV$,4,3))
2540 M=VAL(MID$(RCV$,3,1))
2550 IF M=0 THEN M$="OFF" ELSE IF M=1 THEN M$="ON" ELSE M$="INVERSE"
2560 PRINT "Display status   : ";M$
2570 PRINT:GOTO *RCV.END
2580 '
2590 *RCV.ERR
2600 PRINT "Receive data error"
2610 PRINT
2620 '
2630 *RCV.END
2640 RY=CSRLIN
2650 LOCATE SX,SY
2660 *NORCV
2670 RETURN
2680 '
2690 *ESC.0 ' ..... Display specified screen
2700 LOCATE 43,0:INPUT "Screen number : ",M
2710 M$=RIGHT$("000"+HEX$(M),4)
2720 SEND$=SEND$+M$
2730 RETURN
2740 *ESC.X ' ..... Screen # enquiry
2750 RETURN
2760 *ESC.B ' ..... Write character screen
2770 ' LIMIT IS 32 CHARACTERS DUE TO DISPLAY RESTRICTIONS BY BASIC
2780 LOCATE 43,0:INPUT "Character-screen memory table number : ",M
2790 LOCATE 43,1:PRINT "Write character string (MAX 32 CHARACTERS) -->"
2800 LOCATE 43,2:INPUT C$

```

```

2810 M$=RIGHT$("0"+HEX$(M),2)
2820 C$=LEFT$(C$,32):L$=RIGHT$("0"+HEX$(LEN(C$)),2)
2830 SEND$=SEND$+L$+M$+C$
2840 RETURN
2850 *ESC.C ' ..... Write 4-digit number
2860 LOCATE 43,0:INPUT "Numeral table #      : ",M
2870 *NAGAIN
2880 LOCATE 43,1:INPUT "Write 1 to 4-digit number : ",N%
2890 IF N%<0 OR N%>9999 THEN GOTO *NAGAIN
2900 M$=RIGHT$("00"+HEX$(M),3)
2910 N$=STR$(N%):N$=RIGHT$(N$,LEN(N$)-1)
2920 N$=RIGHT$("000"+N$,4)
2930 SEND$=SEND$+M$+S$+N$
2940 RETURN
2950 *ESC.D ' ..... Write 8-digit number
2960 LOCATE 43,0:INPUT "Numeral table #      : ",M
2970 *N8AGAIN
2980 LOCATE 43,1:PRINT SPACE$(36)
2990 LOCATE 43,1:INPUT "Write 1 to 8-digit number : ",N#
3000 N#=INT(N#)
3010 IF N#<-99999999# OR N#>999999999# THEN GOTO *N8AGAIN
3020 IF N#<0 THEN S$="F" ELSE S$=""
3030 M$=RIGHT$("00"+HEX$(M),3)
3040 N#=ABS(N#)
3050 N$=STR$(N#):N$=RIGHT$(N$,LEN(N$)-1)
3060 IF S$<>"F" THEN N$=RIGHT$("0000000"+N$,8) ELSE N$=RIGHT$("0000000"+N$,7)
3070 SEND$=SEND$+M$+S$+N$
3080 RETURN
3090 *ESC.2F ' ..... Copy memory table
3100 LOCATE 43,0:INPUT "0: character string/1 : number ",M$
3110 IF M$<>"0"AND M$<>"1" THEN *ESC.2F
3120 LOCATE 43,1:INPUT "Copy source memory table number : ",S%
3130 LOCATE 43,2:INPUT "Copy destination memory table number : ",D%
3140 S$=STR$(S%):S$=RIGHT$(S$,LEN(S$)-1):S$=RIGHT$("00"+S$,3)
3150 D$=STR$(D%):D$=RIGHT$(D$,LEN(D$)-1):D$=RIGHT$("00"+D$,3)
3160 SEND$=SEND$+M$+S$+D$
3170 RETURN
3180 *ESC.K ' ..... Display lamps and touch switches (bits)
3190 ' ONLY LAMPS 0 - 31 ARE CONTROLLED DUE TO RESTRICTIONS BY BASIC
3200 ' LAMPS 32 - 111 ARE TURNED OFF BY THIS COMMAND
3210 FOR I=0 TO 31:TS.B(I)=-1:NEXT I
3220 FOR I=0 TO 31
3230   LOCATE 65-(I MOD 8)*3,I¥8:PRINT RIGHT$(STR$(I),2)
3240 NEXT I
3250 LOCATE 43,5:PRINT "Input # : Inverse Input : Run input 99 : Execute"
3260 *ESC.K.2

```

```

3270 COLOR 0:LOCATE 43,6:PRINT SPACE$(36)
3280 LOCATE 43,6:INPUT "Lamp/touch switch number : ";N
3290 IF N=99 THEN GOTO *ESC.K.3
3300 IF N<0 OR N>31 THEN GOTO *ESC.K.2
3310 TS.B(N)=TS.B(N)*(-1)
3320 COLOR 2+TS.B(N)*2
3330 LOCATE 65-(N MOD 8)*3,N%8:PRINT RIGHT$(STR$(N),2)
3340 GOTO *ESC.K.2
3350 *ESC.K.3
3360 FOR I=0 TO 3
3370     M=0
3380     FOR J=0 TO 7
3390         IF TS.B(I*8+J)=1 THEN M=M+2^J
3400     NEXT J
3410     SEND$=SEND$+RIGHT$("0"+HEX$(M),2)
3420 NEXT I
3430 SEND$=SEND$+"00000000000000000000"
3440 COLOR 0
3450 RETURN
3460 *ESC.Q ' ..... Display lamps and touch switches (number)
3470 LOCATE 43,0:PRINT "Display specification"
3480 LOCATE 43,1:PRINT " 0 : OFF"
3490 LOCATE 43,2:PRINT " 1 : ON"
3500 LOCATE 43,3:PRINT " 2 : Inverse flashing (lamps only)"
3510 LOCATE 43,4:PRINT " 3 : All ON"
3520 *QAGAIN
3530 LOCATE 43,5:INPUT " : ",M$
3540 IF M$<>"0" AND M$<>"1" AND M$<>"2" AND M$<>"3" THEN GOTO *QAGAIN
3550 LOCATE 43,6:INPUT "Lamp/touch switch number : ",N
3560 N$=RIGHT$("00"+HEX$(N),3)
3570 SEND$=SEND$+M$+N$
3580 RETURN
3590 *ESC.R ' ..... Enquire lamp and touch switch status
3600 LOCATE 43,0:INPUT "Lamp/touch switch number : ",N
3610 N$=RIGHT$("00"+HEX$(N),3)
3620 SEND$=SEND$+N$
3630 RETURN
3640 *ESC.U ' ..... Disable inputs
3650 SEND$=SEND$+"0"
3660 RETURN
3670 *ESC.V ' ..... Enables inputs
3680 SEND$=SEND$+"0"
3690 RETURN
3700 *ESC.P ' ..... Display screen
3710 LOCATE 43,0:PRINT "Controlled item"
3720 LOCATE 43,1:PRINT " 0 : Display"

```



```
3730 LOCATE 43,2:PRINT " 1 : No display
3740 *PAGAIN
3750 LOCATE 43,3:INPUT " : ",M$
3760 IF M$<>"0" AND M$<>"1" THEN GOTO *PAGAIN
3770 SEND$=SEND$+M$
3780 RETURN
3790 *ESC.T ' ..... Buzzer control
3800 LOCATE 43,0:PRINT "Controlled item"
3810 LOCATE 43,1:PRINT " 0 : Stop buzzer"
3820 LOCATE 43,2:PRINT " 1 : Continuous buzzer"
3830 LOCATE 43,3:PRINT " 2 : Intermittent buzzer"
3840 *TAGAIN
3850 LOCATE 43,4:INPUT " : ",M$
3860 IF M$<>"0" AND M$<>"1" AND M$<>"2" THEN GOTO *TAGAIN
3870 SEND$=SEND$+M$
3880 RETURN
3890 *ESC.W ' ..... System menu display
3900 LOCATE 43,0:PRINT "Controlled item"
3910 LOCATE 43,1:PRINT " 0:MENU TRANSFER ENABLE"
3920 LOCATE 43,2:PRINT " 1:MENU TRANSFER DISABLE"
3930 *WAGAIN
3940 LOCATE 43,3:INPUT " : ",M$
3950 IF M$<>"0" AND M$<>"1" THEN GOTO *WAGAIN
3960 SEND$=SEND$+M$
3970 RETURN
3980 '
3990 *ESC.26 ' ..... Clear screen
4000 RETURN
4010 *ESC.29 ' ..... Specify 1-byte character
4020 LOCATE 43,0:PRINT "Character specify size"
4030 LOCATE 43,1:PRINT " 0:NORMAL SIZE (16x8)"
4040 LOCATE 43,2:PRINT " 1:HALF SIZE (8x8)"
4050 *E26AGAIN
4060 LOCATE 43,3:INPUT " : ",M$
4070 IF M$<>"0" AND M$<>"1" THEN GOTO *E26AGAIN
4080 SEND$=SEND$+M$
4090 RETURN
4100 *ESC.2A ' ..... Specify character enlargement
4110 LOCATE 43,0:PRINT "Specify character enlargement"
4120 LOCATE 43,1:PRINT " 0:NO ENLARGEMENT"
4130 LOCATE 43,2:PRINT " 1:ENLARGE HEIGHT"
4140 LOCATE 43,3:PRINT " 2:ENLARGE WIDTH"
4150 LOCATE 43,4:PRINT " 3:2X2 ENLARGEMENT"
4160 LOCATE 43,5:PRINT " 4:3X3 TIMES ENLARGEMENT"
4170 LOCATE 43,6:PRINT " 5:4X4 TIMES ENLARGEMENT"
4180 *E2AAGAIN
```

```

4190 LOCATE 43,7:INPUT " : ",M$
4200 IF M$="0" OR M$="1" OR M$="2" THEN GOTO *E2ASEND
4210 IF M$="3" OR M$="4" OR M$="5" THEN GOTO *E2ASEND
4220 GOTO *E2AAGAIN
4230 *E2ASEND
4240 SEND$=SEND$+M$
4250 RETURN
4260 *ESC.21 ' ..... Normal display
4270 RETURN
4280 *ESC.22 ' ..... Set inverse display
4290 RETURN
4300 *ESC.23 ' ..... End inverse display
4310 RETURN
4320 *ESC.24 ' ..... Set flashing display
4330 RETURN
4340 *ESC.25 ' ..... End flashing display
4350 RETURN
4360 *ESC.2B ' ..... Set cursor position
4370 *E2B.X
4380 LOCATE 43,0:PRINT SPACE$(36)
4390 LOCATE 43,0:INPUT "X COORDINATE(000-639)",BX
4400 IF BX>639 OR BX<0 THEN *E2B.X
4410 *E2B.Y
4420 LOCATE 43,1:PRINT SPACE$(36)
4430 LOCATE 43,1:INPUT "Y COORDINATE(000-399)",BY
4440 IF BY>399 OR BY<0 THEN *E2B.Y
4450 BX$=STR$(BX):BX$=RIGHT$(BX$,LEN(BX$)-1):BX$=RIGHT$("00"+BX$,3)
4460 BY$=STR$(BY):BY$=RIGHT$(BY$,LEN(BY$)-1):BY$=RIGHT$("00"+BY$,3)
4470 SEND$=SEND$+BX$+BY$
4480 RETURN
4490 *ESC.4 ' ..... Specify Displayed Characters
4500 ' LIMIT IS 32 CHARACTERS DUE TO DISPLAY RESTRICTIONS BY BASIC
4510 LOCATE 43,0:PRINT "Write character string (MAX. 32 CHARACTERS) -->|"
4520 LOCATE 43,1:INPUT C$
4530 C$=LEFT$(C$,32):L$=RIGHT$("0"+HEX$(LEN(C$)),2)
4540 SEND$=SEND$+L$+C$
4550 RETURN
4560 *ESC.7 ' ..... Draw Polyline
4570 LN=0:SL$=""
4580 *E7.X
4590 LOCATE 41,8:PRINT SPACE$(38)
4600 LOCATE 41,9:PRINT SPACE$(38)
4610 LOCATE 41,8:INPUT "X COORDINATE(END AT 999) : ",LX
4620 IF LX=999 THEN *E7.E
4630 IF LX<0 OR LX>639 THEN GOTO *E7.X
4640 *E7.Y

```

```

4650 LOCATE 41,9:PRINT SPACE$(38)
4660 LOCATE 41,9:INPUT "Y COORDINATE : ",LY
4670 IF LY<0 OR LY>399 THEN GOTO *E7.Y
4680 LX$=STR$(LX):LX$=RIGHT$(LX$,LEN(LX$)-1):LX$=RIGHT$("00"+LX$,3)
4690 LY$=STR$(LY):LY$=RIGHT$(LY$,LEN(LY$)-1):LY$=RIGHT$("00"+LY$,3)
4700 LOCATE 39+(LN MOD 5)*8,LN%5:PRINT LX$;" , ";LY$;
4710 SL$=SL$+LX$+LY$
4720 LN=LN+1
4730 IF LN<40 THEN GOTO *E7.X
4740 *E7.E
4750 LN$=HEX$(LN-1):LN$=RIGHT$("0"+LN$,2)
4760 SEND$=SEND$+LN$+SL$
4770 RETURN
4780 *ESC.8 ' ..... Draw circle
4790 *E8.X
4800 LOCATE 43,0:PRINT SPACE$(36)
4810 LOCATE 43,0:INPUT "X COORDINATE OF CENTER OF CIRCLE : ",CX
4820 IF CX>639 OR CX<0 THEN *E8.X
4830 *E8.Y
4840 LOCATE 43,1:PRINT SPACE$(36)
4850 LOCATE 43,1:INPUT "Y COORDINATE OF CENTER OF CIRCLE : ",CY
4860 IF CY>399 OR CY<0 THEN *E8.Y
4870 *E8.R
4880 LOCATE 43,2:PRINT SPACE$(36)
4890 LOCATE 43,2:INPUT "?????#####",CR
4900 IF CR>199 OR CR<0 THEN *E8.R
4910 CX$=STR$(CX):CX$=RIGHT$(CX$,LEN(CX$)-1):CX$=RIGHT$("00"+CX$,3)
4920 CY$=STR$(CY):CY$=RIGHT$(CY$,LEN(CY$)-1):CY$=RIGHT$("00"+CY$,3)
4930 CR$=STR$(CR):CR$=RIGHT$(CR$,LEN(CR$)-1):CR$=RIGHT$("00"+CR$,3)
4940 SEND$=SEND$+CX$+CY$+CR$
4950 RETURN
4960 '
4970 *SELECT ' ..... Item selection routine
4980 IF LV=0 THEN LX=3 ELSE LX=LV*20+1
4990 IF LV=0 THEN LY=1 ELSE LY=0
5000 COLOR 4:LOCATE LX,LY:PRINT CMND$(SECT.NO,1,0)
5010 COLOR 0
5020 FOR I=2 TO CMND(SECT.NO)
5030   IF LV=0 AND I<=5 THEN LY=I
5040   IF LV=0 AND I>5 THEN LY=I+1
5050   IF LV=1 THEN LY=I-1
5060   LOCATE LX,LY:PRINT CMND$(SECT.NO,I,0)
5070 NEXT I
5080 *KY.IN
5090 A$=INKEY$:IF A$="" THEN GOTO *KY.IN
5100 IF A$<>CHR$(&H1B) THEN GOTO *KY 1

```

```
5110  COLOR 0
5120  FOR I=1 TO CMND(SECT.NO)
5130    IF LV=0 AND I<=5 THEN LY=I
5140    IF LV=0 AND I>5 THEN LY=I+1
5150    IF LV=1 THEN LY=I-1
5160    LOCATE LX,LY:PRINT SPACE$(20)
5170  NEXT I
5180  SEL.NO=0
5190  GOTO *SEL.RET
5200  *KY1
5210  IF A$<>CHR$(&H1E) AND A$<>CHR$(&H1F) THEN GOTO *KY2
5220    IF LV=0 AND SEL.NO<=5 THEN LY=SEL.NO
5230    IF LV=0 AND SEL.NO>5 THEN LY=SEL.NO+1
5240    IF LV=1 THEN LY=SEL.NO-1
5250    COLOR 0:LOCATE LX,LY:PRINT CMND$(SECT.NO,SEL.NO,0)
5260    IF A$=CHR$(&H1E) THEN SEL.NO=SEL.NO-1 ELSE SEL.NO=SEL.NO+1
5270    IF SEL.NO=0 THEN SEL.NO=CMND(SECT.NO)
5280    IF SEL.NO>CMND(SECT.NO) THEN SEL.NO=1
5290    IF LV=0 AND SEL.NO<=5 THEN LY=SEL.NO
5300    IF LV=0 AND SEL.NO>5 THEN LY=SEL.NO+1
5310    IF LV=1 THEN LY=SEL.NO-1
5320    COLOR 4:LOCATE LX,LY:PRINT CMND$(SECT.NO,SEL.NO,0)
5330    GOTO *KY.IN
5340  *KY2
5350  IF A$<>CHR$(&HD) THEN GOTO *KY.IN
5360  *SEL.RET
5370  COLOR 0
5380  RETURN
5390  DATA "SCREEN CONTROL","MEMORY TABLE OPERATION","LAMP, TOUCH SWITCH OPERATION"
5400  DATA "TOUCH SWITCH INPUT","SYSTEM CONTROL","CHARACTER SIZE"
5410  DATA "CHARACTER DISPLAY ATTRIBUTE","CHARACTER-STRING DISPLAY","FIGURE DIS-
      PLAY"
5420  DATA 2
5430  DATA "Display specified screen","[ESC]0"
5440  DATA "Request screen number","[ESC]X"
5450  DATA 4
5460  DATA "Write character-string memory table","[ESC]B"
5470  DATA "4-digit write numeral table","[ESC]C"
5480  DATA "8-digit write numeral table","[ESC]D"
5490  DATA "Copy memory table","[ESC]/"
5500  DATA 3
5510  DATA "Lamp and touch switch display (bit specification)","[ESC]K"
5520  DATA "Lamp and touch switch display (address specification)","[ESC]Q"
5530  DATA "Lamp and touch switch display status enquiry","[ESC]R"
5540  DATA 2
5550  DATA "Touch switch disable","[ESC]U"
```

```
5560 DATA "Touch switch enable", "[ESC]V"
5570 DATA 3
5580 DATA "Screen display control", "[ESC]P"
5590 DATA "Buzzer control", "[ESC]T"
5600 DATA "System menu display", "[ESC]W"
5610 DATA 3
5620 DATA "Clear screen", "[ESC]&"
5630 DATA "Character specify size", "[ESC])"
5640 DATA "Specify character enlargement", "[ESC]*"
5650 DATA 5
5660 DATA "Normal display", "[ESC]!"
5670 DATA "Set inverse display", "@@@@@@"
5680 DATA "End inverse display", "[ESC]#"
5690 DATA "Set flashing display", "[ESC]$"
5700 DATA "End flashing display", "[ESC]%"
5710 DATA 2
5720 DATA "Set cursor position", "[ESC]+"
5730 DATA "Specify displayed characters", "[ESC]4"
5740 DATA 2
5750 DATA "Draw polyline", "[ESC]7"
5760 DATA "Draw circle", "[ESC]8"
```

---

## **SECTION 8**

# **Troubleshooting and Maintenance**

This section describes the action to take when NT600S errors occur, and how to carry out maintenance and inspections to prevent the occurrence of errors.

8-1	Hardware Faults .....	242
8-2	Responding to Displayed Error Messages .....	244
8-2-1	Errors Occurring when the Power is Turned ON .....	244
8-2-2	Errors Occurring During Operation .....	244
8-2-3	Errors Occurring on Screen Data Initialization and Transfer .....	244
8-2-4	Communication Errors .....	245
8-3	Maintenance of the NT600S .....	247
8-4	Inspection and Cleaning .....	252

## 8-1 Hardware Faults

When a fault relating to the operation of the NT600S occurs, find the symptoms in the table below and respond by following the corresponding "Remedy" indicated in the table.

- ⚠ Caution**
- Confirm system safety before turning the power ON/OFF or resetting. Otherwise the system may operate unpredictably.
  - Do not disassemble for repairs or modification. Otherwise the product may malfunction.

NT600S Symptoms	Cause	Remedy
POWER LED fails to come ON	Power is not being supplied.	Check the connections and make sure that power is supplied correctly. (Refer to "2-2-2 Power Supply Connection", page 28.)
	Power supply fuse has blown	Contact your OMRON service center.
Nothing is displayed on the screen (it is completely white/LCD or black/EL).	Screen #0 has been read at the host side.	This is not an error. Change the screen number. (Refer to "4-3 Screen Display", page 124.)
	In communication with the Host, screen data is not transferred to the NT600S through RS-232C.	Transfer the screen data to the PT using the support tool.
Meaningless characters are displayed.	The DIP switches at the rear of the terminal have been left at their factory setting (SW2-2 is OFF).	Set DIP switch SW2-2 on the rear of the PT to ON and switch the power back on.
Communication with the support tool not possible.	The Transmit Mode has not been established.	Display the system menu and select the Transmit Mode. (Refer to "4-5 Registering the Screen Data", page 79.)
	Not connected to the support tool.	Check the installation of the connector cable. (Refer to "2-3 Connecting to the Support Tool", page 30.)
	PT type setting and direct connection setting at the support tool do not match the NT600S.	Using the "Tool Settings" of the support tool, set the PT type and direct connection settings that match the NT600S.
	The NT600S Support Tool Mode setting does not match the support tool used.	Match the setting for the "Support Tool Mode" option in the memory switch menu of the Maintenance mode with the support tool being used.
Cannot communicate with the PC /Host.	Memory switch settings do not match.	Check the communication setting in the "Memory Switch" menu of the Maintenance Mode, and match the PC and NT600S settings. (Refer to "4-6 Setting the Conditions of Communications with the PC/Host by Using the Memory Switches", page 83.)
	NT600S and PC/HOST are not correctly connected.	Check that the type, length and installation of the connector cable match the specifications. (Refer to "2-4 Connection to a PC by the Host Link", page 31, "2-5 Connection to a PC by the NT Link", page 43, "3-7 Connection to a PC by C200H Direct", page 56, "3-8 Host Connection by RS-232", page 63.)
	When NT link (1:N), there is unit number duplication.	Set again with no duplication.
	In a host link connection, the PC termination resistance setting is incorrect.	Set the PC termination resistance correctly. (Refer to "2-4 Connection to a PC by the Host Link", page 31.)
	Power not supplied to the NT600S, PC, or host	Check the power supply.

NT600S Symptoms	Cause	Remedy
Buzzer sounds, RUN LED is OFF.	Malfunction due to external noise.	Distance the communication cable from the source of the noise and insert a noise filter in the power supply line.
Touch panel does not respond	Malfunction due to external noise	Distance the communication cable from the source of the noise and insert a noise filter in the power supply line.
	Touch panel is broken.	Check the touch panel by performing the touch panel test in the I/O check in the maintenance mode.
PC mode changes to monitor mode.	The NT600S changes the mode during host link communication.	This is normal with the NT600S specification. When using a PC that can also be connected using the NT link, connect it with the NT link (the mode is not changed when using the NT link).



## 8-2 Responding to Displayed Error Messages

When the NT600S displays an error message, find the corresponding symptoms in the appropriate table below and respond by following the “Remedy” indicated in the table.

### 8-2-1 Errors Occurring when the Power is Turned ON

The table below shows the errors that can occur when the power supply to the NT600S is turned ON, and their remedies.

Message	Cause	Remedy
The Screen Data Corrupted	There is an error in the registered screen data.	After initializing the screen data memory in the Maintenance Mode, transmit the screen data once more with the support tool.
The Mark Data Corrupted	There is an error in the registered mark data.	After initializing the screen data memory in the Maintenance Mode, transmit the screen data once more using the support tool.
Screen data is not registered.	There is no screen data.	Transmit screen data from the support tool.
The counters of memory switches were corrupted.	There is an error in the memory switch settings.	Press the [Confirm] touch switch. The NT600S restores the normal state, with the memory switch settings reset to the initial settings.
An error occurred in the unit.	There is an error at the C200H interface unit.	Contact your OMRON service center.

### 8-2-2 Errors Occurring During Operation

The table below shows the errors that can occur during operation of the NT600S, and their remedies.

Message	Cause	Remedy
Setting Error	Bits or words allocated to the PC memory cannot be found in the screen data.	Check the memory area in the PC used and correct the bit and word allocations in the screen data.
I/O register command is not available or switch settings are wrong.	The PC model is one that does not allow connection of the NT600S.	Check the model of the PC currently used to determine whether the NT600S can be connected to it or not; select a model to which the NT600S can be connected.
	Settings of the Host link unit are wrong.	Check the setting of the switches on the Host link unit.

### 8-2-3 Errors Occurring on Screen Data Initialization and Transfer

The table below shows the errors that can occur when data is written to the NT600S screen data memory, and their remedies.

Message	Cause	Remedy
Screen Initialization Error	Hardware fault or screen data memory life reached	If the same message is displayed even after executing screen data memory initialization or screen data transmission several times, contact your OMRON service center.

### 8-2-4 Communication Errors

This section describes the errors relating to communication with the PC that can occur during operation, and their remedies.

- Operation when a communication error occurs

When a communication error occurs, the error message is displayed at the NT600S, and the buzzer sounds. Error messages are displayed when the “Automatic Reset” memory switch is not set (OFF).

**Note**

Some error messages are displayed even if the “Automatic Reset” memory switch is set (ON).

- Procedure when a communication error occurs

When an error message is displayed, press the [confirm] touch switch displayed on the screen. The screen display will return to the RUN mode.

- Display of communication errors

As shown below, communication errors are displayed in the center of the screen, together with a classification indicating whether they are receive or send errors.

**[Screen when an error has occurred during reception]**

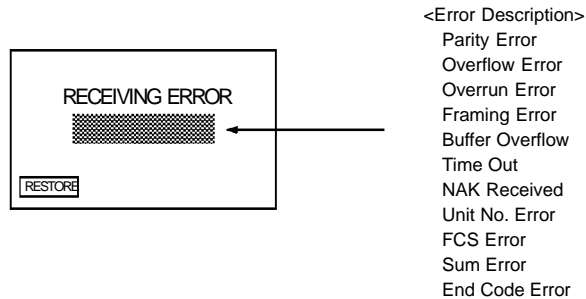

**[Screen when an error has occurred during sending]**

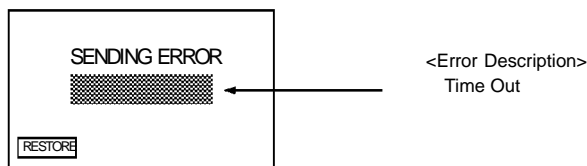

Message	Cause	Remedy
Parity Error Framing Error Overrun Error Overflow Error	Communication parameters set incorrectly.	Check whether the parity bit, data bit length, baud rate, stop bit length, and flow control settings of the PC/Host match the settings of the NT600S.
	Noise caused data corruption during communication.	Use a noise-resistant cable if communication occurs in an environment with high levels of noise.
	The connectors of the connecting cable are not connected correctly.	Reconnect the cable.
Buffer Overflow	The NT600S receive buffer is full.	Lengthen the command transmission intervals. If this error occurs frequently, set flow control for communications.
Time Out	The connectors of the connecting cable have become disconnected.	Reconnect the cable.
	The PC/Host is stopped.	Make sure the PC/Host is able to communicate with the NT600S.
	During transmission of one command, a time lapse exceeding 5 seconds is detected.	Confirm the proper command length. Check the cable connection.
NAK Received (end code simultaneously displayed)	Noise caused data corruption during communication.	Use a noise-resistant cable if communication occurs in an environment with high levels of noise. Check the end code by referring to the PC user's manual.
Unit No. Error	The unit No. does not match that set on the PC.	Set the PC unit No. to "0".
	The PC is transmitting incorrect data.	Check PC operation.
	Noise caused data corruption during communication.	Use a noise-resistant cable if communication occurs in an environment with high levels of noise.
FCS Error Sum Error	The PC is transmitting incorrect data.	Check PC operation.
	Noise caused data corruption during communication.	Use a noise-resistant cable if communication occurs in an environment with high levels of noise.
End Code Error	There is an error at the NT600S or the C200H interface unit.	Contact your OMRON service center.

- If an error occurs during the execution of a command, that command becomes invalid and it is not executed.

## 8-3 Maintenance of the NT600S

Carry out maintenance work in order to ensure that the NT600S is always used in its optimum condition.

 **WARNING** Do not attempt to take the NT600S apart and do not touch any internal parts while the power is being supplied. Doing either of these may result in electrical shock.

### Spare PT

It is advisable to have a spare NT600S available to minimize system downtime in the event of an NT600S failure or if the screen display becomes difficult to read due to deterioration of the display unit.

### Backlight

When the backlight in the display is getting dim and the screen cannot be read easily, replace the backlight. The backlight can be replaced at the rear of the NT600S while it is mounted in an operation panel.

- Models that use a backlight

NT600S-ST121-EV□

NT600S-ST121B-EV□

- Replaceable Backlight Model

NT600S-CFL01

- Guide to Backlight Replacement

Under normal conditions it can be assumed that the backlight will need to be replaced after about 20,000 hours. However, the life of the backlight does vary in accordance with the environment in which it is used and it should be replaced when it is getting dim and the screen is getting hard to read.

**Replacing the Backlight**

**⚠ WARNING** Switch off the power before replacing the backlight. Otherwise you could sustain an electric shock.

- Operation**
1. Turn off the power to the NT600S and remove the lid of the CFL case, located at the upper right part of the rear of the NT600S: remove the screw with a Philips head screwdriver, then open the CFL case lid.

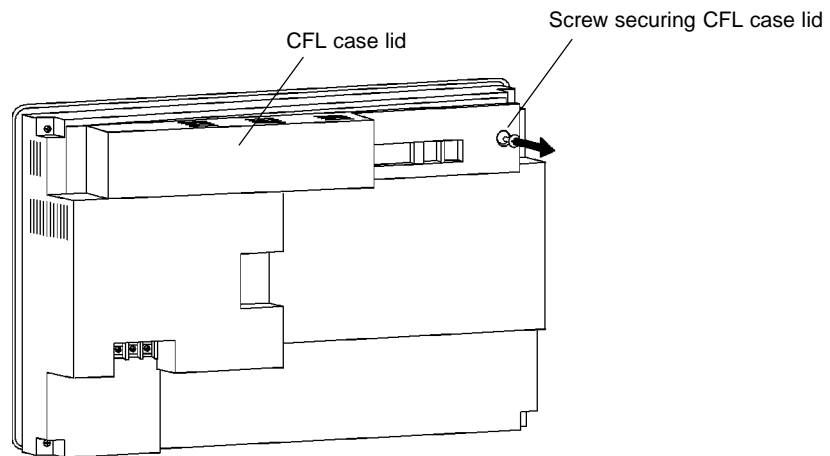

2. Disconnect the backlight connector from the NT600S.

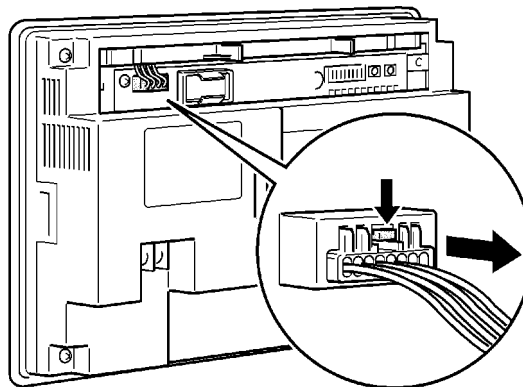

**3. Remove the backlight ( T-shaped).**

Remove the backlight, lifting it upward, by pulling the left handle after pushing the right handle to the right.

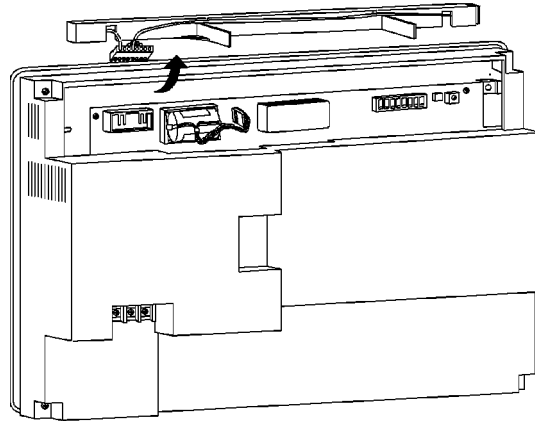
**4. Fit a new backlight.**

Hold the handle and insert the projection at the right side face of the unit into the hole in the NT600S. Then, push the right handle until it clicks. After confirming the click, check whether the backlight has been set correctly or not by viewing the NT600S from the top.

- The backlight is fitted in the correct position if the handle is upright.
- If the handle is tilted, it indicates that the backlight is not fitted correctly. Repeat the step above until the backlight is fitted correctly.

**5. Connect the backlight connector to the NT600S.**

Plug in the connector after making sure the polarity is correct. Take care to ensure that the connector cord will not be damaged while the connector is inserted. After connecting the connector, store the cord inside the NT600S properly.

**6. Close the CFL case lid and secure it with the screw.**

Tighten the screw securely after making sure that the connector cord is not caught by the lid.

**Replacing the Battery**

The NT600S uses a lithium battery to back up the memory contents.

The battery life is 5 years if the NT600S is used in a location where the ambient temperature is 25°C. If the temperature at the location of use is higher than this, the battery life will be shorter. Change the battery at suitable intervals in accordance with the operating environment of the NT600S.

It is advisable to keep a spare battery so that the battery can be replaced immediately if replacement becomes necessary.

**Battery Type** ..... **C500-BAT08**

**Battery Replacement Clues** Replace the battery in the following cases. The battery must be replaced within 5 days.

- When 5 years have passed since the installation of a new battery.
- When the RUN LED is lit.

• **Battery replacing method**

Replace the battery by following the procedure given below.

To protect the contents of the memory, the battery must be replaced in less than 5 minutes.

**Operation** 1. Keep the power ON for at least 1 minute and then turn it OFF.

**Note** Unless the power is kept ON for at least 1 minute, the memory contents cannot be retained for more than 5 minutes without a battery.

2. Turn off the power to the NT600S and remove the lid of the CFL case, located at the upper right part of the rear of the NT600S: remove the screw with a Philips head screwdriver, then open the CFL case lid.

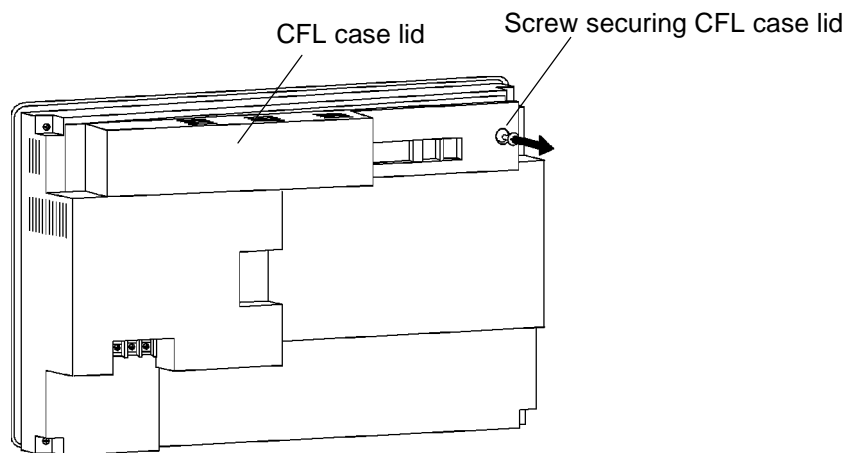

3. Pull out the battery together with the connector.

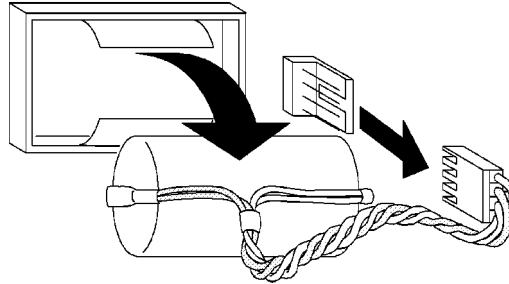

4. Install a new battery.  
Insert the battery connector, keeping it straight.

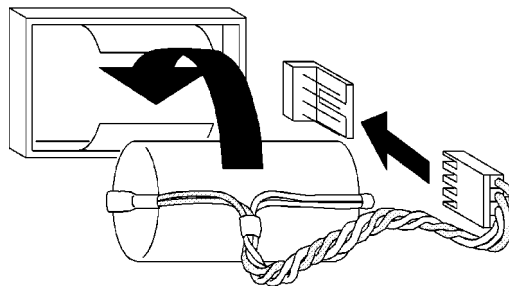

5. Close the CFL case lid and secure it with the screw.

---

**Reference** The battery may be replaced while the power is ON. In this case, there are no restrictions on battery replacement time.

---

**⚠ Caution** Never short the + and – terminals of the battery. Do not recharge, take apart, deform, or discharge it into open flame. Attempting any of these will lead to hazards such as fire, leakage of electrolyte, rupture, etc.

---

**Note** When replacing a battery, ensure that the battery terminal does not touch the board in the NT600S.

---



## 8-4 Inspection and Cleaning

Clean and inspect the NT600S regularly to ensure that it is always used in its optimum condition.

### Cleaning Method

If the display is dirty the screen is difficult to see. Clean the screen from time to time as follows.

- In daily cleaning, wipe the display with a soft dry cloth.
- If the soiling cannot be removed with a dry cloth, wet the cloth with diluted neutral detergent (2%), wring it out well and wipe the display with it.
- If rubber or vinyl products, tape, etc. are left stuck to the display for long periods they will cause staining. If such items are stuck to the display, remove them during cleaning.

### Note

Never use volatile solvents such as benzene or thinners, or chemical dusters. These could cause degeneration of the coatings of the NT600S display and body.

### Inspection Method

In normal environments, inspect the NT600S at intervals of between 6 months and a year. In environments that are extremely hot and humid, or very dusty environments, shorten the inspection interval.

- Items required for the inspection
  - Prepare the following items before starting the inspection.
  - The tools supplied with the NT600S
  - Screwdrivers (Philips, flat-head)
  - Tester (or digital voltmeter)
  - Industrial alcohol
  - 100% cotton cloth
  - Hygrometer (required in some cases)
  - Thermometer (required in some cases)
  - Synchroscope (required in some cases)
  - Pen-writing oscilloscope (required in some cases)

• Points inspected

Inspect the following points to determine if there is any divergence from the stated criteria. If there is, either improve the surrounding environment so that the values fall within the stated range, or adjust the NT600S.

Point Inspected	Inspection Details	Criterion	Inspection Instrument
Power supply voltage	Fluctuation in power supply terminal voltage	Permissible voltage fluctuation range (24 VDC -15% +10%)	Tester
Ambient environmental conditions	Ambient temperature (temperature in the operation panel)	0 to 50°C	Thermometer
	Ambient humidity (humidity in the operation panel)	35% to 85%RH	Hygrometer
	Presence/absence of dust	Dust must not be settled	Visual inspection
Mounting conditions	Looseness of mounting brackets etc.	To be no looseness	Accessory tools
	Connector connections of connecting cable	To be fully inserted and locked, with no looseness	
	Looseness of screws in external wiring	To be no looseness	Philips screwdriver
	Conditions of external connecting cables	Faults such as incipient disconnections.	Visual inspection
Components with limited lives	Brightness of the backlight	Must be sufficiently bright. Backlight life: Brightness is halved after about 20,000 hours in use.	Visual inspection
	Brightness of EL display unit	Must be sufficiently bright. EL display unit life: Brightness is reduced by 30% after about 30,000 hours in use.	Visual inspection

-  **Caution** • Do not disassemble for repairs or modification. Otherwise, the product may malfunction.
- The disposal of the NT600S (and used backlights) may be regulated by national or local authorities. Dispose of them in accordance with the laws and regulations of the relevant country and local authority.

**Cautions on replacing the NT600S**

When replacing the NT600S after discovering a fault during inspections, note the following points:

- Be sure to switch the power OFF before replacement.
- After replacement, check that the new NT600S is not subject to the same error.
- If a faulty unit is returned for repairs, write as detailed a description of the fault as possible and send this description together with the unit to the OMRON address indicated on the back cover of this book.



## APPENDIX A

### Specifications

#### General Specifications

Item	Specification
Power supply voltage	24 VDC
Allowable power supply voltage range	20.4 VDC to 26.4 VDC (24 VDC -15% +10%)
Power consumption	24V, less than 15W (ST121 (B)-EV□) 24V, less than 25W (ST211 (B)-EV□)
Inrush current	3 A max.
Ambient operating temperature	0 to +50°C (with no freezing)
Storage temperature	-20 to +70°C (with no freezing)
Ambient operating humidity	35 to 85% RH (with no condensation)
Operating environment	No corrosive gases.
Resistance to electrostatic discharge	Level 3 (IEC801-2) In air ±8 kV, contact ±6 kV, indirect ±7 kV
Electromagnetic field strength	10 V/m (IEC801-3)
Fast transient/burst noise	Power supply line: 2 kV (IEC801-4) I/O line: 0.25 kV
Damped oscillatory wave	Power supply line: 1 kV (IEC255-4)
Vibration resistance	10 to 22 Hz with 1.5 mm double amplitude for a total of 30 min. in X, Y, and Z directions.
	22 to 500 Hz with 1.5 G {14.7 m/s <sup>2</sup> } acceleration in X, Y, and Z directions.
Shock resistance	Durability: 30 G, 3 times each in X, Y, and Z directions.
	Malfunction: 20 G, 3 times each in X, Y, and Z directions.
Dimensions (mm)	275 (W) x 192 (H) x 71 (D) mm
Weight	1.8 kg max.
Enclosure ratings	Front panel: Equivalent to IP65 (front face waterproof construction).
	Rear case: IP20
	Terminals: IP00
Applicable standards	EN61131-2 (1994) EN50081-2 (1992)

## Performance Specifications

### Display Specifications

Item	Specification	
Dot matrix of STN liquid crystal display panel	Number of dots (resolution)	640 dots (vertically) x 400 dots (horizontally) (dot size: 0.30 mm)
	Effective display area	192 mm (vertically) x 120 mm (horizontally)
	View angle	Left direction: 50° Right direction: 40°
	Life expectancy	50,000 hours minimum
EL (electro luminescence) display panel	Number of dots (resolution)	640 dots (vertically) x 400 dots (horizontally) (dot size: 0.30 mm)
	Effective display area	192 mm (vertically) x 120 mm (horizontally)
	View angle	Left direction: 80° Right direction: 80°
	Life expectancy	30,000 hours minimum (till brightness becomes 30% weaker)
Backlight (white cold cathode tube)	Life expectancy	Average: 20,000 hours (the time taken for the brightness to decline to half its original value at normal temperature and humidity)
	Automatic turn-off	Can be set to turn off in 10 minutes or 1 hour, or to remain on.
Indicators	POWER indicator (Green LED)	Lit while power is being supplied.
	RUN indicator (Green, Orange, Red LED)	Lit during operation Lit in orange or red if the battery voltage becomes low.

### Panel Specifications

Item	Specification
Touch panel	Number of switches: Max. 128 registrable per screen (8 vertically x 16 horizontally)
	Input: Pressure-sensitive type
	Operating force: 100 gf min.
	Life expectancy: 1 million operations minimum

**Display Capacity**

Item		Specification
Display elements	Character displays	Fixed character data (character strings registered for each screen)
	Character string displays	256 strings per file (40 bytes (40 normal characters) per string), 50 positions per screen
	Numeral displays *	50 positions per screen, 8-digit display
	Graph displays *	50 per screen
	Graphic displays	Can be displayed wherever required
	Lamps	No restriction on total number, 255 per screen
	Touch switches	No restriction on total number, 128 per screen
	Numeral settings *	Display of set numerical values 50 per screen
Screen types	Normal screen	Displays screens registered as normal.
	Overlapping screens	A maximum of 8 registered screens can be displayed overlapped with each other.
	Continuous screens	A maximum of 8 screens can be displayed sequentially by scrolling. (The screen can be changed by pressing the $\uparrow$ and $\downarrow$ touch switches)
Screen attributes		Buzzer, numeral setting, bit input of lamps and touch switches, display history recording, backlight
Number of registered screens		1000 max.
Screen registration method		Transfer screen data created using the support tool to the NT600S.
Screen saving method (screen data memory)		Saved to flash memory (recording format unique to NT600S)

\* Number of numeral memory tables that can be used:

Number used for numeral display + number used for graphics + number used for numeral settings  $\leq$  512

**Display Element Specifications**

Item	Specification
Display characters	Half-size characters (8 x 8 dots): Alphanumerics and symbols
	Normal characters (8 x 16 dots): Alphanumerics and symbols
	Marks (16 x 16 dots): User-defined pictographs
Enlargement function	Horizontal and vertical magnifications of 4x, 9x, 16x, and 64x
Smoothing processing	Enlarged characters up to 4x
Character display attributes	Normal, inverse, flashing, inverse flashing
Graphics	Rectangles, circles

**Data Quantities**

Item	Specification	
	Direct Connection	RS-232C Communication
Strings	256 strings comprising 40 characters each	
Numeral data	512 max. (8 digits each)	
Marks	64 marks	
Touch switches	No limits if direct specification function is used.	Combined total of 256 for lamps and touch switches
Lamps		

## Special Features

Item	Specification
Buzzer	Two types: Continuous sound and intermittent sound Setting: Set "key press sound" in the "Memory Switch" menu of the Maintenance Mode ON. If "ERR ON" is set the buzzer only sounds when an error occurs. ON: The buzzer sounds on designation from the PC/Host, when a screen with a buzzer-ON specification is called, or on display of an error screen such as for a receive error. OFF: The buzzer is turned off on designation from the PC/Host, by touch switch input, or when a screen without a buzzer-ON specification is displayed. Sound pressure: Min. 80 dB, average 87 dB (measured 10 cm from front face)
Maintenance functions	<ul style="list-style-type: none"> <li>• Self-test for memory, switches, etc.</li> <li>• Status setting confirmation for communications and other conditions.</li> <li>• Simple communications confirmation.</li> </ul>
Backup by battery	<ul style="list-style-type: none"> <li>• Connecting an optional battery makes the display history recording and resume functions available. (Data retaining time: 5 years (at 25°C))</li> <li>• If battery voltage becomes low, the RUN LED on the front panel lights in orange and the communication flag (BAT LOW) to the Host is turned ON (set to "1").</li> <li>• The battery can be replaced at the rear of the NT600S while it is running.</li> </ul>
Key input sound setting	0.2 second input sound when a touch switch is pressed Setting: Set "key press sound" of the "Memory Switch" menu in the Maintenance mode ON.
Display history recording Resume function	Available only when the optional battery is installed. With the standard specification, these functions are not available since the battery is not installed.

## Communications Specifications

### [For a Host Link]

Item	Specification
Communications standard	EIA RS-232C
Communications settings	Start-stop synchronization Baud rate: 9600, 19,200 bps Data length: 7 bits Stop bit: 2 bits Parity: Even
Connector	9-pin, D-SUB connector (female)
Number of units connected	1 to 1
Transmission distance	Max. 15 m
Communications protocol	C-series SYSWAY (1:N)

### [For an NT Link (1:1)]

Item	Specification
Communications standard	EIA RS-232C
Connector	9-pin D-SUB connector (female)
Number of units connected	1 to 1
Transmission distance	Max. 15 m

### [For an NT Link (1:N)]

Item	Specification
Communications standard	EIA RS-232C
Connector	9-pin D-SUB connector (female)
Number of units connected	1:1 to 8
Transmission distance	<ul style="list-style-type: none"> <li>• RS-232C cable : Max. 2 m (*)</li> <li>• RS-422A/485 cable : Total length 500 m (*)</li> </ul>

(\*)When NT-AL001 used

### [For RS-232C]

Item	Specification
Communication standard	EIA RS-232C
Communication settings	Start-stop synchronization Baud rate: 2400/4800/9600/19200 (bps) Data length: 7, 8 Stop bit: 1, 2 Parity: Even/Odd/None Flow control: RS/CS control XON/XOFF control None
Connector	9-pin D-SUB (female)
Number of units connected	1-to-1
Transmission distance	Max. 15 m



# APPENDIX B

## Dimensions

[ Body ]

- NT600S-ST121(B)-V□
- NT600S-ST211(B)-V□

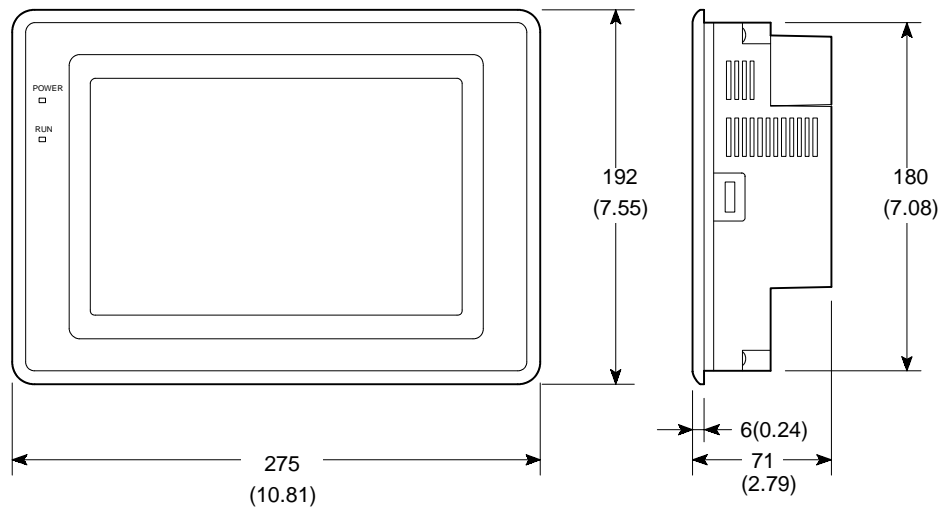
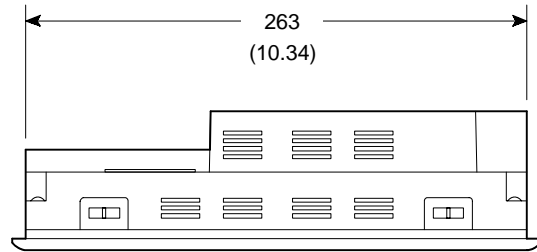

Unit : mm (inch)

[ Installation ]

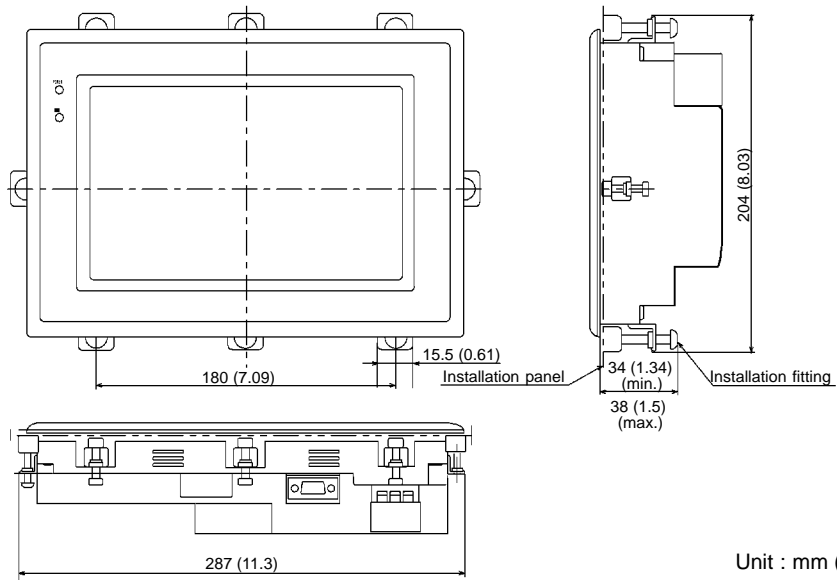

[ Cable Installation ]

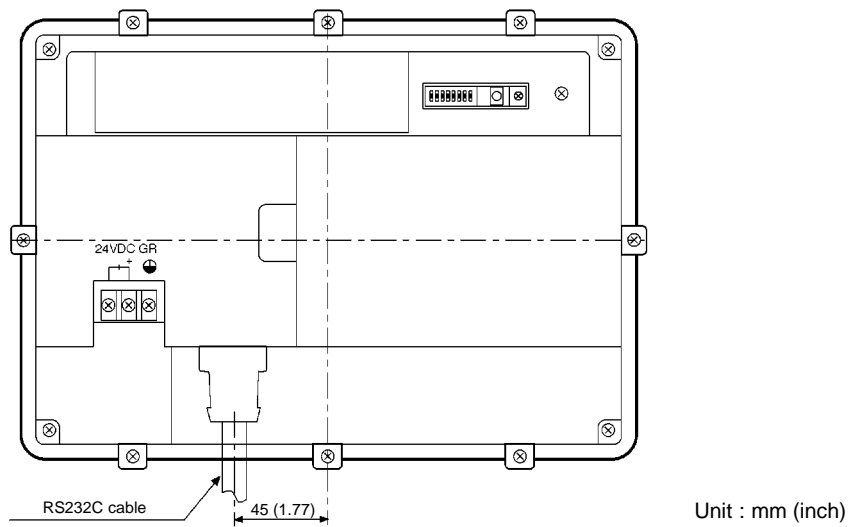

## APPENDIX C

### Handling the RS-232C/RS-422 Converter Unit

This section shows the dimensions of the RS-232C/RS-422 converter unit (NT-AL001), and describes the methods for installing and removing it. Refer to this information when designing the control panel.

#### Dimensions

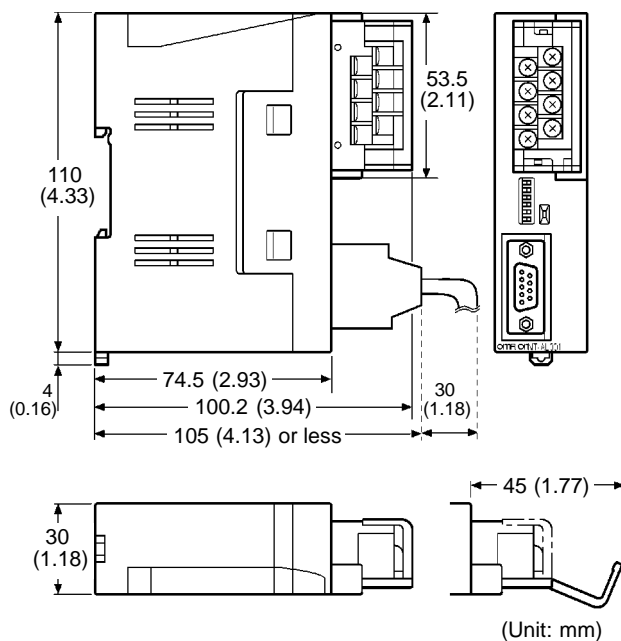

With RS-422A terminal block cover closed: 30 (W) x 114 (H) x 100.2 (D) mm

With RS-422A terminal block cover open: 30 (W) x 114 (H) x 119.5 (D) mm

#### Installation and Removal

The RS-232C/RS-422A converter unit (NT-AL001) is installed on a DIN rail or in an operation panel. The RS-422A terminal block of the converter unit can easily be removed.

**Installation on a DIN Rail**

Hook the top part of the rear of the converter unit ((a) in the figure) onto the top edge of the DIN rail, and push the unit in direction (b).

Then fit end plates on the right and left sides of the converter unit so that the unit cannot shift sideways.

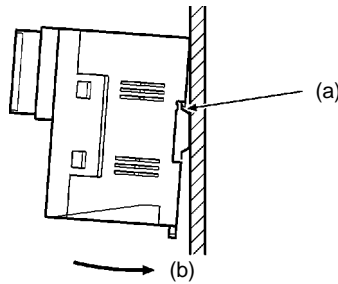

**Removal from the DIN Rail**

Remove the end plates at right and left, then insert a flat-tipped screwdriver into the rail stopper on the bottom of the unit and pry the unit away.

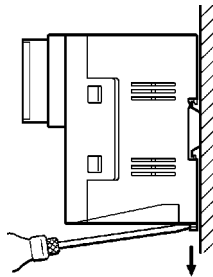

**Installation in an Operation Panel**

Make two screw holes in an operation panel wall at least 2 mm thick and secure the converter to the wall with screws.

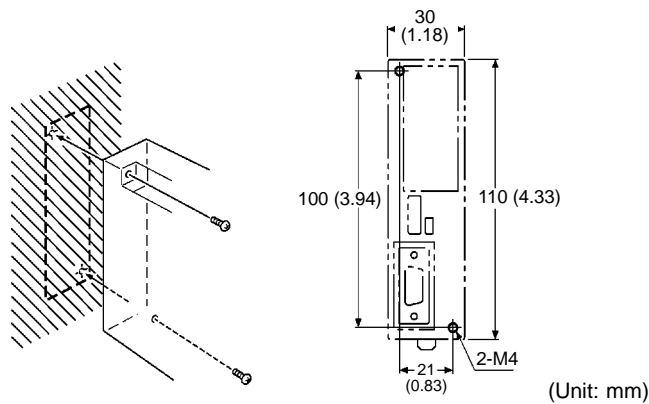

**Note**

In order to ensure a strong installation, the wall of the operation panel must be at least 2 mm thick.

## APPENDIX D

### NT600S Installation Environment

When installing the PT in the operation panel, observe the following points. See also the section "Getting Started".

- The view angle of the LCD screen is 50° to the left and 40° to the right. Install it at a position and height where operators will be able to see it well.
- Do not install the unit at locations where the ambient temperature goes outside the range 0 to 50°C or where the relative humidity goes outside the range 35 to 85% RH.

If the ambient temperature exceeds the range indicated above, install a fan or an air conditioner.

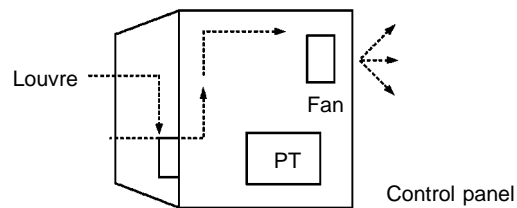

- Provide sufficient space for ventilation
- Do not install the unit directly above equipment that generates a lot of heat (heaters, transformers, large capacity resistors, etc.)
- To ensure that the unit can be operated and maintained without difficulty, install it at a distance from high-voltage equipment and power equipment.
- Install the unit as far as possible from personal computers, amateur radio equipment, radios, etc. The radio waves generated by the unit may cause interference that will affect these types of equipment.

**⚠ Caution** • Do not install the NT600S at sites subject to the following conditions. Otherwise, the product may malfunction.

- Severe temperature variations
- Temperatures or humidities outside the ranges stated in the specifications
- High humidity, condensation
- Splashing chemical agents
- Severe oil splashing
- Corrosive or flammable gases
- Strong vibrations or shocks
- Direct exposure to wind and rain (outdoor sites)
- Strong ultra-violet irradiation
- Take adequate measures to ensure shielding if the NT600S is used at a location subject to any of the following conditions. Otherwise, the product may malfunction.
  - Static electricity, or noise from other equipment
  - Strong electromagnetic fields
  - Nearby power cables
  - Potential exposure to radioactivity

- Take the following points into account in order to prevent noise
  - (1) Avoid installing the unit in panels in which high-voltage equipment is also installed.
  - (2) Install the unit at a distance of at least 200 mm from power lines.

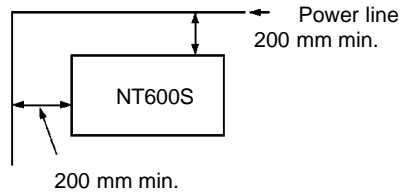

- (3) If the unit is installed next to equipment that generates a strong electric or magnetic field (solenoids, etc.), provide a gap of at least 40 mm.

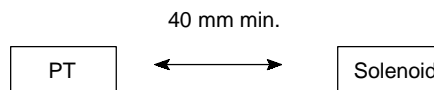
**Note**

When using the RS-232C +5V output, check the current capacity of the connected equipment. The maximum current value of the NT20S +5 V output is 150 mA.

## Transportation and Storage of the PT

### Note on transportation

Pack the PT in the packaging intended for it before transporting it.

### Note on storage

Maintain the storage ambient temperature ( $-20$  to  $70$  °C) and storage ambient humidity (35 to 85% RH).

## APPENDIX E

### Method for Making the Cable for Connection to the PC/Host

Explained below is the method for making the cable that connects the NT600S and the PC/Host.

Connect the wires to the connectors in accordance with the connector specification for each unit.

#### Making the Cable for Connection to the PC

##### Parts Required

Two connectors, two connector covers and one cable are required to make up a connecting cable. One connector and one connector cover is supplied with most PCs.

Name	Model	Delivered with	Remarks
Connector	XM2A-0901	C series CQM1, C200HS, C200HX/HG/HE CVM1/CV series CPU unit CV500-LK201	9-pin, manufactured by OMRON
	XM2A-2501	C500-LK203 C500-LK201 C200H-LK201	25-pin, manufactured by OMRON
	DB-25P	C500-LK201-V1 C120-LK201-V1	25-pin, manufactured by JAE
Connector Cover	XM2S-0911	C series CQM1, C200HS, C200HX/HG/HE CVM1/CV series CPU unit CV500-LK201	9-pin, manufactured by OMRON
	XM2S-2511	C500-LK203 C500-LK201 C200H-LK201	25-pin, manufactured by OMRON
	DB-C2-J9	C500-LK201-V1 C120-LK201-V1	25-pin, manufactured by JAE

##### Note

When connecting the NT600S to an OMRON PLC C□□H, the connector and the connector hood must be prepared separately since they are not supplied with the C□□H.

The connector provided in the CPU unit of the C□□H is a 9-pin connector. For the connection, the following connector and connector hood should be prepared.

- Connector: XM2A-0901 (9-pin type, OMRON)
- Connector hood: XM2S-0911 (9-pin type, OMRON)

Prepare the cable recommended by OMRON.

The recommended cables are indicated in the following table.

Name	Type	Remark
Cable	AWG28 × 5P IFVV-SB	Multiconductor shielded cable (FUJIKURA, Ltd.)
	CO-MA-VV-SB 5P × 28AWG	Multiconductor shielded cable (HITACHI Cable, Ltd.)

## Connector Specifications and Wiring for OMRON Units

The combination of pin numbers to which the connecting wires are connected differs according to the connector specifications for each unit. Check the connector specifications of the unit to be connected and make the wiring connections for the items in the connection combination indicated below which are applicable.

### [NT600S Connector Specifications (9-pin)]

- Electrical characteristics: Complies with EIA RS-232C
- Signal direction: Signal input and output is relative to NT600S.

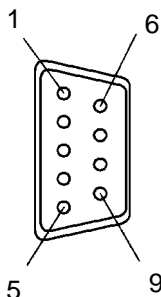

Connector Pin No.	Signal Name	Abbreviation
1	Frame ground	FG (*1)
2	Send data	SD (TXD)
3	Receive data	RD (RXD)
4	Request to send	RS (RTS)
5	Clear to send	CS (CTS)
6	+5V Output 150mA max. (211(B)-EV□) 100mA max. (121(B)-EV□)	+5V
9	Signal ground	SG

(\*1) FG is not used.

**Correct Use** Check the current capacity of the supplied equipment before using the No.6 pin (+5 V output). The +5 V output for NT600S is +5 V  $\pm$  5%, 150 mA max. in the case of ST211(B)-EV□ and +5 V  $\pm$  5%, 100 mA max. in the case of ST121(B)-EV□.

### Connecting an NT600S to a C-Series Host Link

- C-Series Host Link Unit 25-pin Connector Specifications

Applicable Host Link Unit: C200H-LK201-V1  
C500-LK201-V1  
C500-LK203  
C120-LK201-V1

- Electrical characteristics: Complies with EIA RS-232C
- Signal direction: Signal input and output is relative to the PC.

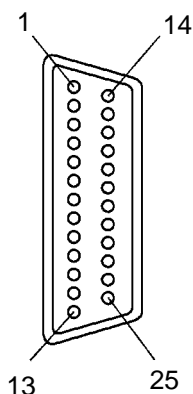

Connector Pin No.	Signal Name	Abbreviation	Signal Direction	
			Input	Output
1	Frame ground	FG	-	-
2	Send data	SD (TXD)		○
3	Receive data	RD (RXD)	○	
4	Request to send	RS (RTS)		○
5	Clear to send	CS (CTS)	○	
7	Signal ground	SG	-	-
14	Optical connector +5V (see note 2)	+5V	-	-
15	Send signal element timing 2 (see note 1)	ST2	○	
17	Receive signal element timing (see note 1)	RT	○	
20	Data terminal ready	ER (DTR)		○
24	Data signal element timing (see note 1)	ST1		○

Note 1. No element timing signals on C200H-LK201



2. C500-LK201 and C200H-LK201(-V1) only

• Wiring Connections

The NT600S does not use pin 4 (RS) or pin 5 (CS). Either short the RS and CS pins of the PC connector together or set the CTS setting selector switch at the rear face of the host link unit to "0V" (see \* in the figure).

Connect the cable shielding wire to the connector cover and pin 1 at the host link unit end of the cable only.

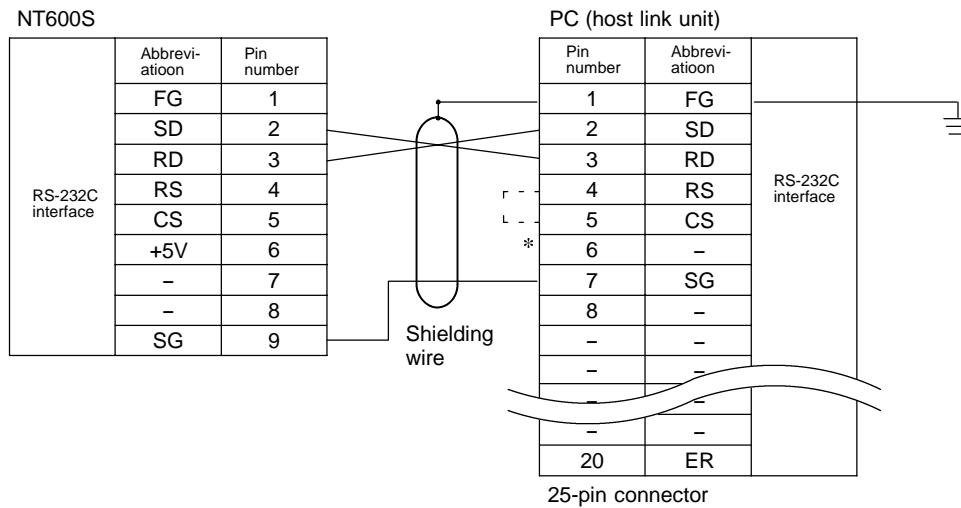

Connecting an NT600S to a C-Series CPU (C□□H)

• C-Series CPU Unit (C□□H) 9-pin Connector Specifications

- Applicable CPU: C20H/C28H/C40H/C60H
- Electrical characteristics: Complies with EIA RS-232C
- Signal direction: Signal input and output is relative to the PC.

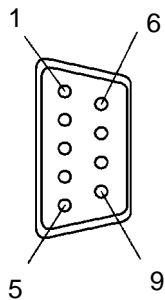

Connector Pin No.	Signal Name	Abbreviation	Signal Direction	
			Input	Output
1	Frame ground	FG	-	-
2	Send data	SD (TXD)		○
3	Receive data	RD (RXD)	○	
4	Request to send	RS (RTS)		○
5	Clear to send	CS (CTS)	○	
7	Signal ground	SG (GND)	-	-

• Wiring Connections

The NT600S does not use pin 4 (RS) or pin 5 (CS). Short the RS and CS pins of the PC connector together (see \* in the figure).

Connect the cable shielding wire to the connector cover and pin 1 at both the NT600S and CPU ends of the cable.

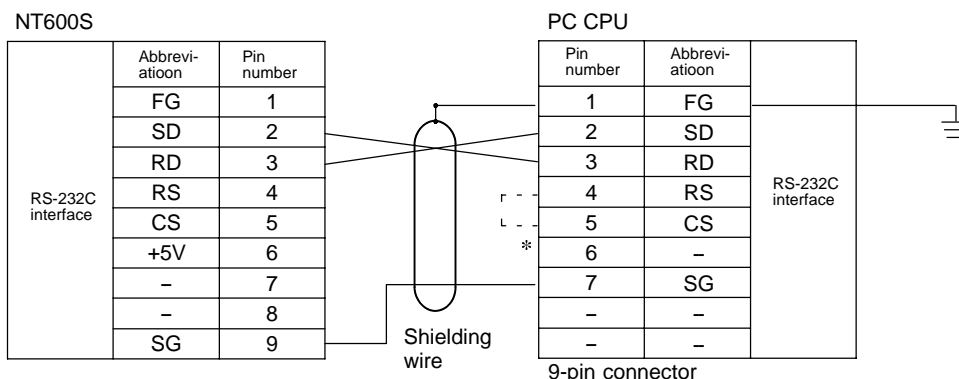

**Connecting an NT600S to a CVM1/CV-Series Host Link Unit**

• CVM1/CV-Series Host Link Unit Connector Specifications

- Applicable host link unit: CV500-LK201
- Electrical characteristics: Complies with EIA RS-232C
- Signal direction: Signal input and output is relative to the PC.

**Communication Port 1 (25-pin Connector)**

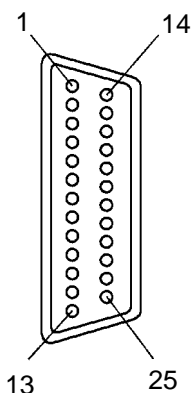

Connector Pin No.	Signal Name	Abbreviation	Signal Direction	
			Input	Output
Connector cover	Frame ground	FG	-	-
1	Frame ground	FG	-	-
2	Send data	SD (TXD)		○
3	Receive data	RD (RXD)	○	
4	Request to send	RS (RTS)		○
5	Clear to send	CS (CTS)	○	
7	Signal ground	SG (GND)	-	-
8	Carrier detected	CD (DCD)	○	
14	Optical connector +5V	+5V		○
20	Data terminal ready	ER (DTR)		○

**Communication Port 2 (9-pin Connector)**

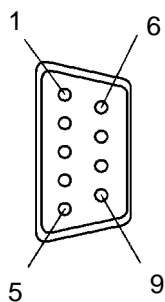

Connector Pin No.	Signal Name	Abbreviation	Signal Direction	
			Input	Output
Connector cover	Frame ground	FG	-	-
2	Send data	SD (TXD)		○
3	Receive data	RD (RXD)	○	
4	Request to send	RS (RTS)		○
5	Clear to send	CS (CTS)	○	
9	Signal ground	SG (GND)	-	-

• Wiring Connections

CVM1/CV-series host link units have two types of connector, which must be wired differently.

The NT600S does not use pin 4 (RS) or pin 5 (CS). Either short the RS and CS pins of the PC connector together or set the CTS setting selector switch at the rear face of the host link unit to "0V" (see \* in the figure).

Connect the cable shielding wire to the connector cover and pin 1 at the host link unit end of the cable only.

**Communication Port 1 (25-pin Connector)**

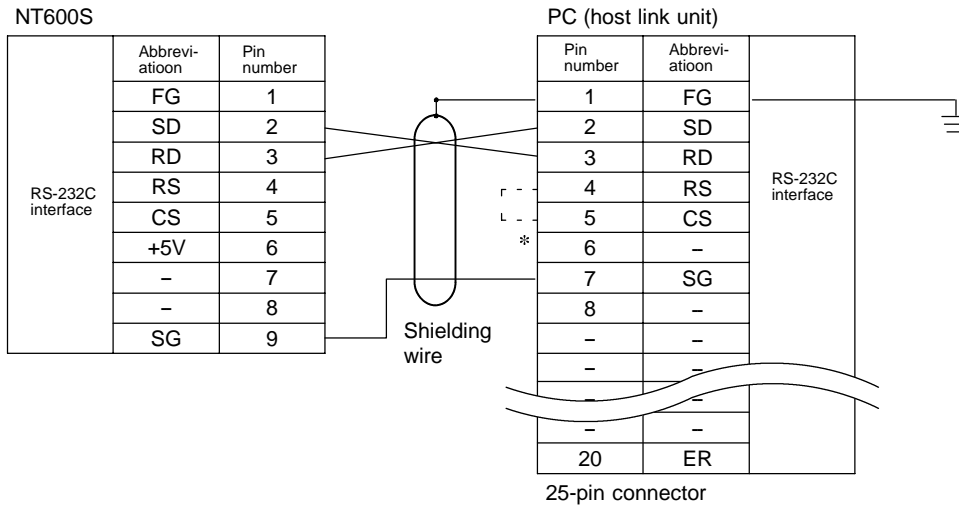

**Communication Port 2 (9-pin Connector)**

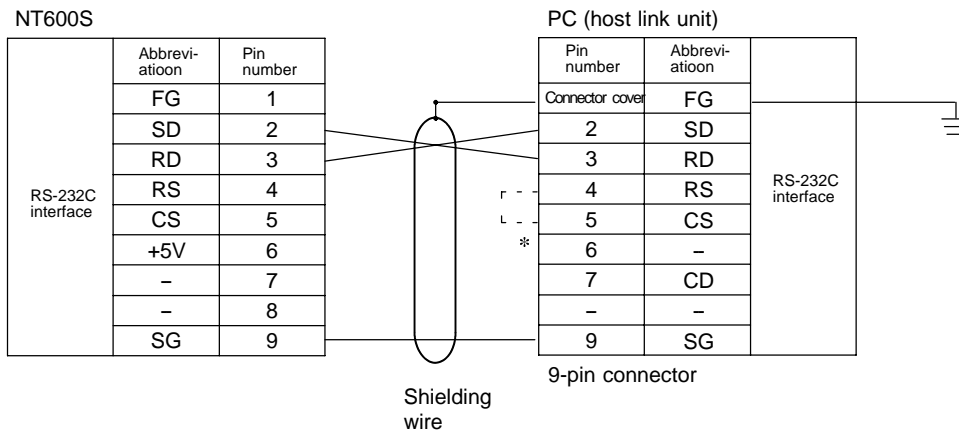

**Connecting an NT600S to a C Series C200HS, C200HX/HG/HE, or CPM1, CQM1, CVM1/CV Series (-V□) CPU Unit (Including Communication Port)**

- C-Series C200HS, C200HX/HG/HE, CPM1, CQM1, CVM1/CV-Series (-EV□) CPU Unit 9-pin Connector Specifications

Applicable CPU:

C200HS-CPU21-E	C200HE-CPU32-E	C200HG-CPU33-E	C200HX-CPU34-E
C200HS-CPU23-E	C200HE-CPU42-E	C200HG-CPU43-E	C200HX-CPU44-E
C200HS-CPU31-E		C200HG-CPU53-E	C200HX-CPU54-E
C200HS-CPU33-E		C200HG-CPU63-E	C200HX-CPU64-E
CPM1-10CDR-□	CQM1-CPU21-E	CV500-CPU01-EV1	
CPM1-20CDR-□	CQM1-CPU41-E	CV1000-CPU01-EV1	
CPM1-30CDR-□	CQM1-CPU42-E	CV2000-CPU01-EV1	
	CQM1-CPU43-E	CVM1-CPU01-EV□	
	CQM1-CPU44-E	CVM1-CPU11-EV□	
		CVM1-CPU21-EV□	

**Note**

The host link function incorporated in CV/CVM1 CPUs (with the exception of -EV□) cannot be used.

- Electrical characteristics: Complies with EIA RS-232C
- Signal direction: Signal input and output is relative to the PC.

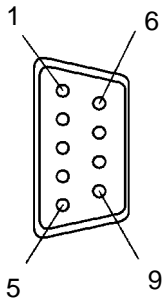

Connector Pin No.	Signal Name	Abbreviation	Signal Direction	
			Input	Output
Connector cover	Frame ground	FG	-	-
2	Send data	SD (TXD)		○
3	Receive data	RD (RXD)	○	
4	Request to send	RS (RTS)		○
5	Clear to send	CS (CTS)	○	
9	Signal ground	SG (GND)	-	-

• Wiring Connections

The NT600S does not use pin 4 (RS) or pin 5 (CS). Either short the RS and CS pins of the PC connector together or set the CTS setting selector switch at the rear face of the host link unit to "0V" (see \* in the figure).

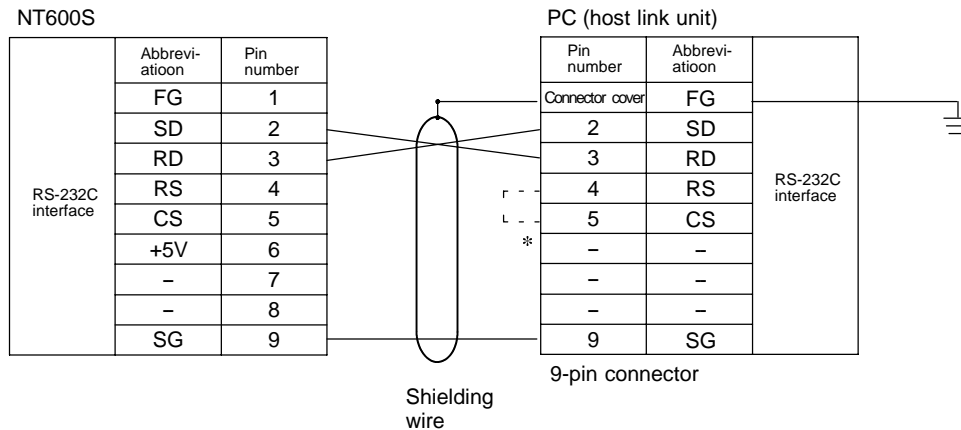

**Connecting an NT600S to an RS-232C/RS-422 Converter Unit (NT-AL001)**

Connecting to an RS-232C/RS-422 converter unit allows transmissions over distances greater than 15 m (maximum of 500 m).

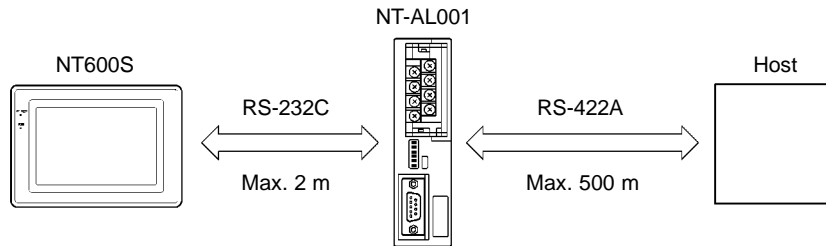

**Reference** When connecting a C200HX/HG/HE and an RS-232C/RS-422 converter unit, use a converter unit whose lot number is 15Y5 or later. Converter units of lot numbers previous to 15Y5 cannot be connected.

- NT-AL001 RS-232C Connector Specifications (9-pin Type)

Electrical characteristics: Conform to EIA RS-232C

Signal direction: Signal input and output is relative to the NT-AL001.

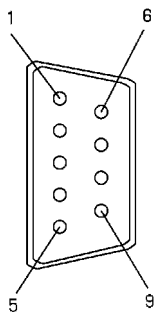

Connector Pin No.	Signal Name	Abbreviation	Signal Direction	
			Input	Output
Connector cover	Grounding or earth for safety purposes	FG	-	-
2	Send data	SD (TxD)		○
3	Receive data	RD (RxD)	○	
4	Request to send	RS (RTS)		○
5	Clear to send	CS (CTS)	○	
6	+5V input	+5V	○	
9	Signal ground	SG (GND)	-	-

**NT-AL001 RS-422A terminal block specifications**

Connected terminal block: RS-422A terminal block (M3 screws)

Electrical characteristics: Conform to EIA RS-422A

Signal direction: Signal input and output is relative to the NT-AL001.

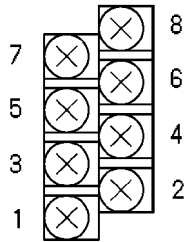

Terminal Block Pin No.	Signal Name	Abbreviation	Signal Direction	
			Input	Output
8	Request to send (-)	CSA		○
7	Request to send (+)	CSB		○
6	Receive data (-)	RDA	○	
5	Receive data (+)	RDB	○	
4	Send data (-)	SDA		○
3	Send data (+)	SDB		○
2	Signal ground	SG (GND)	-	-
1	Functional ground	FG	-	-

**Note** The CSB and CSA signals are for special applications.

**Wiring**

[For NT600S-ST211(B)-V□]

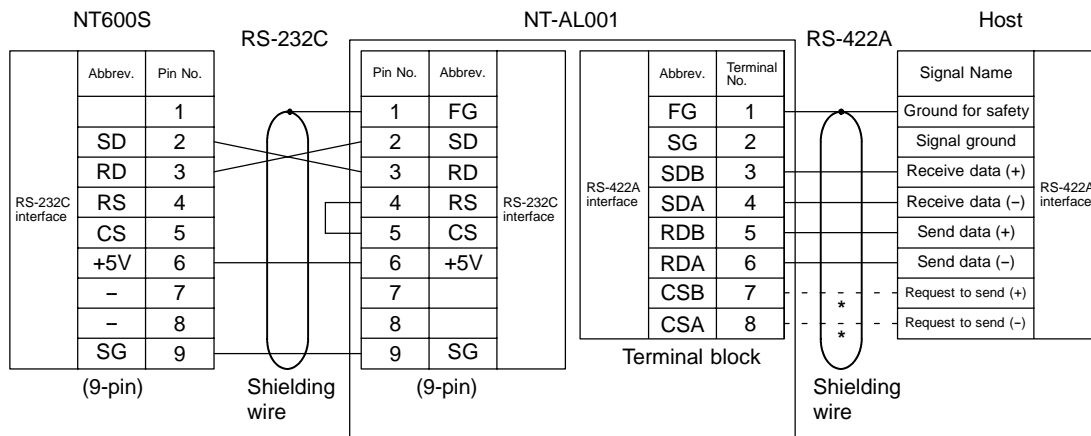

[For NT600S-ST121(B)-V□]

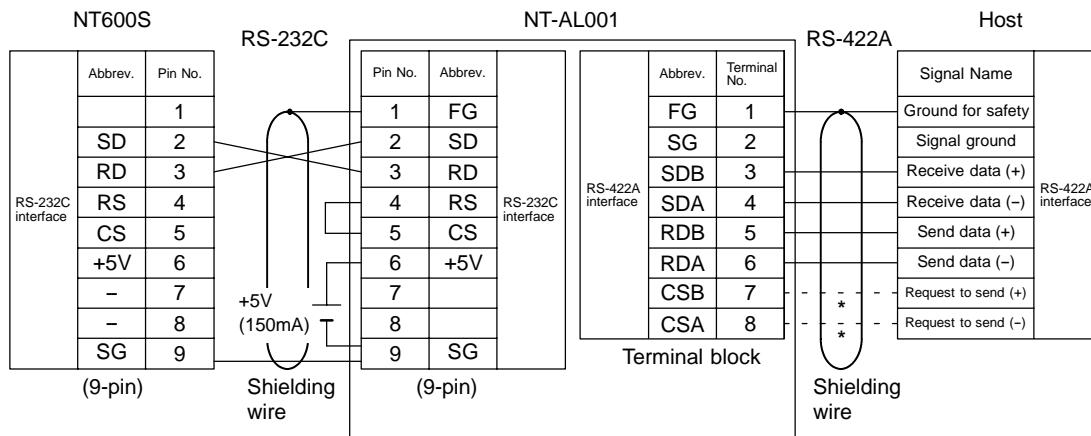

(\*) CSB and CSA are connected when the NT600S requires RS/CS control for the host control method.

## Making the Cable

The procedure to make up the cable is described below.

Refer to the following explanation when making an RS-422A cable also.

### Cable Preparation

The preparation of the cable differs according to whether or not the shielding wire is to be connected to the FG.

- Cable with Shielding Wire Connected to FG

- (1) Cut the cable to the required length.
- (2) Remove the external vinyl insulation from the cable with a razor blade. Take care not to damage the shielding underneath.
- (3) Cut back the shielding wire with scissors.
- (4) Use wire strippers to strip the insulation from each wire.
- (5) Fold back the shielding wire.
- (6) Wrap aluminum foil tape around the folded-back shielding wire.

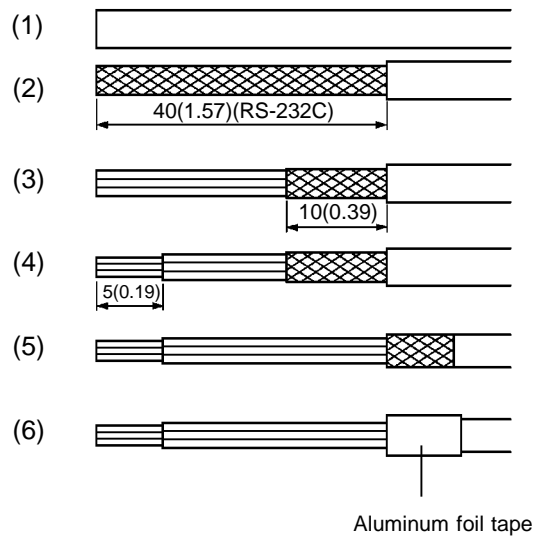

[Units: mm (in.)]



• Cable with Shielding Wire Not Connected to FG

- (1) Cut the cable to the required length.
- (2) Remove the external vinyl insulation from the cable with a razor blade. Take care not to damage the shielding underneath.
- (3) Cut back the shielding wire with scissors.
- (4) Use wire strippers to strip the insulation from each wire.
- (5) Wrap vinyl tape over the cut off end of the shielding wire.

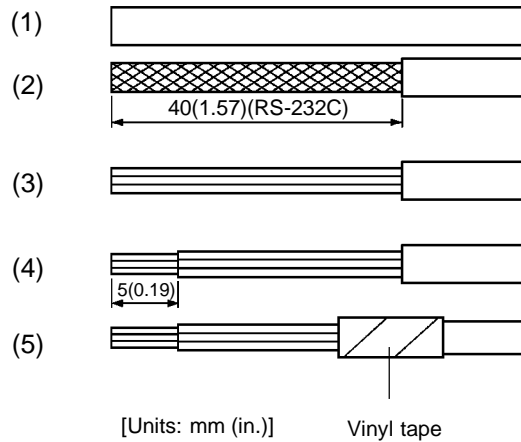

**Soldering**

- (1) Slide heat-shrink tube over each wire.
- (2) Pre-solder each wire and connector cable.
- (3) Solder each wire to the connector terminal.

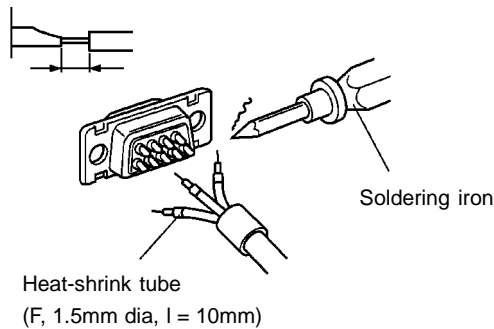

- (4) Push the heat-shrink tube over the soldered joint and heat the tube to shrink it in place.

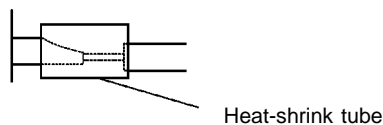

### Connector Cover Assembly

Assemble the connector covers as shown in the diagram below.

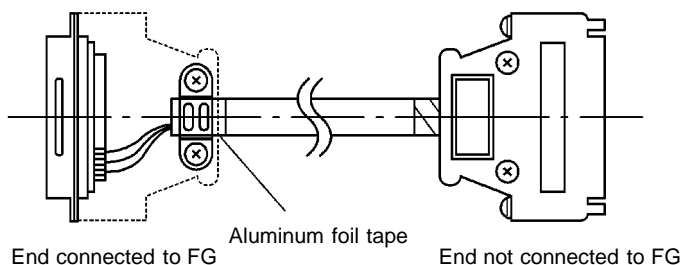

### Preparing RS-232C Connector Cables

Prepare a connector cable to connect a NT600S to a HOST separated by more than 5 m so that the supplied connector cable (XW2Z-500P) cannot be used. The maximum cable length is 15 m.

#### Recommended Parts

Name	Model	Remarks
Connector	XM2A-0901	9-pin, manufactured by OMRON
Connector cover	XM2S-0911	9-pin, manufactured by OMRON
Cable	AWG28 × 5P IFVV-SB	Multicore cable, manufactured by Fujikura, Ltd.
	CO-MA-VV-SB 5P × 28AWG	Multicore cable, manufactured by Hitachi Cable, Ltd.

On the other end of the cable use the type of connector and connector cover which matches the host computer connector type.

#### Connection For Host

Only the shielded wire on the host side is connected to the connector hood. The following diagram is for RS/CS control. If RS/CS control is not executed, RS and CS must be short-circuited (turned over) for both the NT600S and host side.

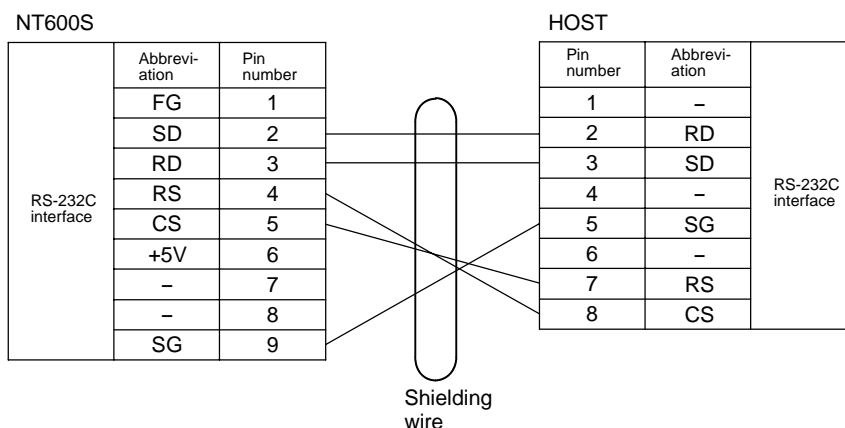

#### Note

For some host computers the combination of pin numbers and signal names may differ from those shown in the diagram above. Refer to the Host instruction manual before wiring the connector.

## APPENDIX F

### Connecting to an RS-232C/RS-422 Converter Unit (1:1)

By using an RS-232C/RS-422 converter unit (NT-AL001), RS-232C can be converted to RS-422A, allowing long-distance communication of up to 500 m.

#### Connection Method

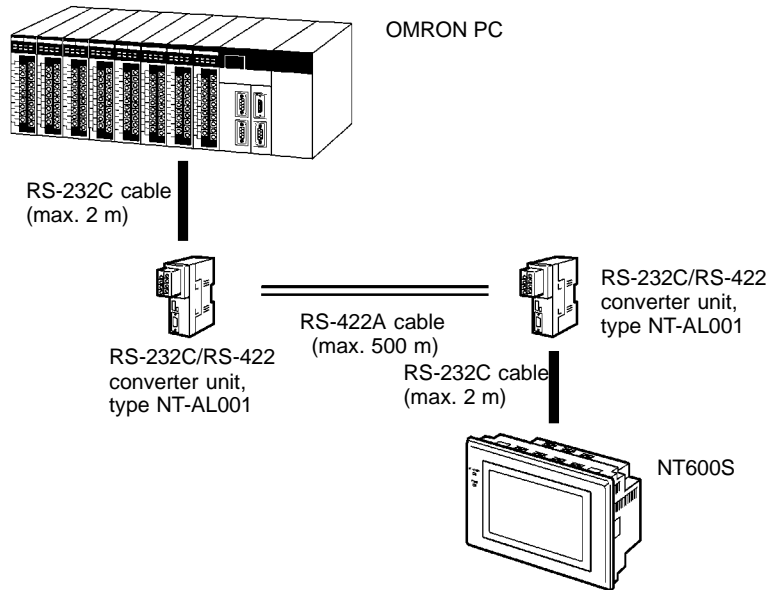

#### Wiring

- Wiring of RS-232C cable

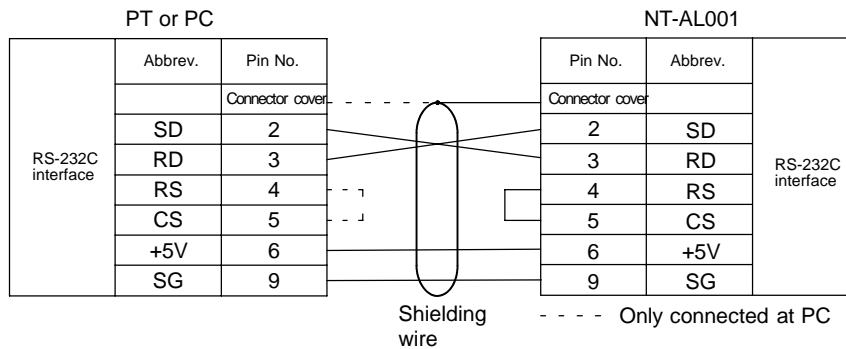

The pin numbers are the numbers at the NT600S.  
For the pin numbers at the PC, refer to the manual for the PC used.

• RS-422A Cable Wiring

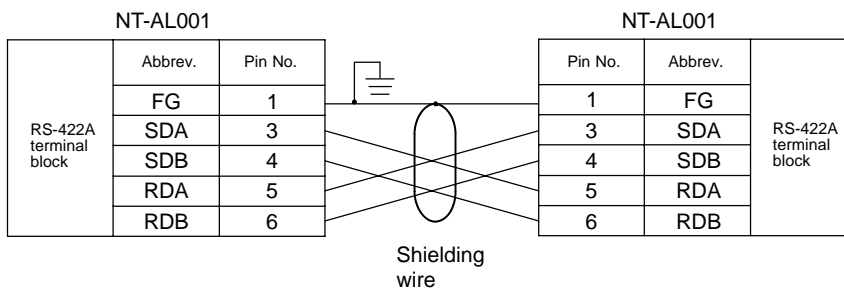

DIP Switch Settings at RS-232C/RS-422 Converter Unit

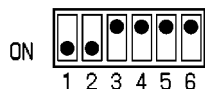

## APPENDIX G

### Function Restrictions Depending on the Support Tool

When using the direct connection function, screens can be created by using the conventional support tools indicated below.

- NT series NT20M/NT2000M/NT600M support tool (Ver.4.□)

In addition, the NT series support tool (Ver.2.□) can be used with Ver.4 of the direct connection function.

However, when the above support tools are used or Ver.4 direct connection is used, restrictions apply to some functions, as shown in the table below.

The expressions used for support tools in the table have the following meanings.

NTM V4 : NT series NT20M/NT2000M/NT600M support (Ver.4.□)

NT V2 : NT series support tool (Ver.2.□)

Support Tool	NT Model	Direct Connection	Communication Mode	Support Tool Mode (NT600S memory switch)	Restrictions
NTM V4	NT600M	OMRON	-(Standard)	NT600M	Thumbwheel numeral settings not possible, no upper/lower limits, hexadecimal input not possible, indirect specification not possible, touch switch input notification fixed as "momentary", data transmission in screen units not possible.
NT V2	NT600M	Ver. 4	Standard	NT600M	
	NT600S	Ver. 4	Standard/High-speed	NT600S	
	NT600S	Ver. 5	Standard/High-speed	NT600S	No restriction

The NT600S cannot be used with combinations of support tools and settings other than those indicated above.

**Reference** When using RS-232C communications, the NT series support tool (Ver.2.□). However, the NT series NT20M/NT200M/NT600M support tool (Ver.4.□) cannot be used.

The necessary support tool and "Tool Mode" (NT600S memory switch) settings in this case are as follows:

PT model	: NT600S
Direct setting	: No
Communication mode	: Standard/High-speed
Tool Mode	: NT600S

## APPENDIX H

### Making the Cable for Connection to the Support Tool

Make the connection cable for connection to the support tool by referring to the following explanation.

#### Parts Required

The table below indicates the recommended parts for making the connection cable.

Name	Model	Remarks
Connector	XM2A-2501	25-pin, manufactured by OMRON
	XM2A-0901	9-pin (Plug), manufactured by OMRON
	XM2D-0901	9-pin (Socket), manufactured by OMRON
Connector cover	XM2S-2511	25-pin, manufactured by OMRON
	XM2S-0901	9-pin, manufactured by OMRON
Cable	AWG28 × 5P IFVV-SB	Multicore cable, manufactured by Fujikura, Ltd
	CO-MA-VV-SB 5P × 28AWG	Multicore cable, manufactured by Hitachi Cable, Ltd

The recommended parts listed above are those applicable when the personal computer features a 25-pin DSub female connector. If the personal computer features another type of connector, prepare the appropriate parts by referring to its manual.

#### Wiring Connections

The connector at the NT600S used for connecting the support tool is also used as the connector for connecting the PC/Host.

For the pin configuration, refer to NT600S Connector Specifications (page 267).

The wiring connection is shown below.

- With a 25-pin Connector

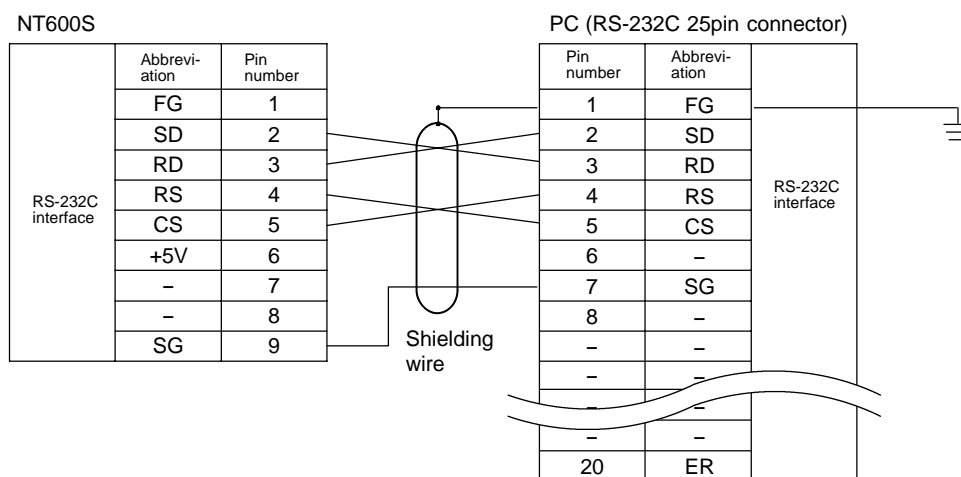

**Note**

For some host computers the combination of pin numbers and signal names may differ from those shown in the diagram above. Refer to the Host instruction manual before wiring the connector.

- With a 9-pin Connector

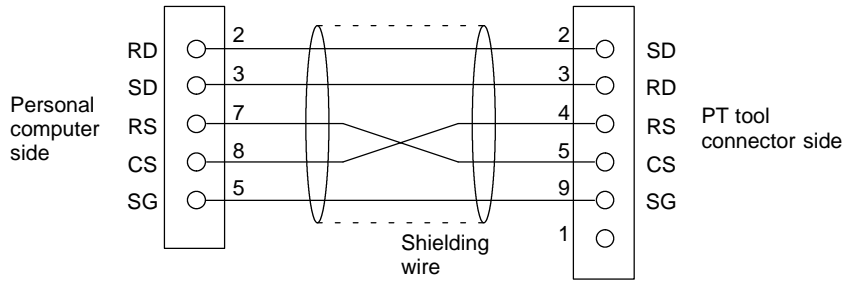

When making the connection cable, use the following recommended parts.

Name	Model	Remarks
Connector	XM2D-0901	9-pin type, made by OMRON (personal computer side)
	XM2A-0901	9-pin type, made by OMRON (PT side)
Connector cover	XM2S-0911	9-pin type, made by OMRON (two)
Cable	AWG28 × 5P IFVV-SB	Multi-core shielded cable (FUJIKURA, Ltd.)
	CO-MA-VV-SB 5P × 28AWG	Multi-core shielded cable (HITACHI cable, Ltd.)

# APPENDIX I

## NT600S Internal Processing

When Host/NT link or C200H direct is used, the following processing is executed inside the NT600S. Processing is divided into two types: periodic processing and event processing.

### Periodic Processing (When Using Direct Connection)

The following processing is executed inside the NT600S to enable high-speed control from the PC.

Usually, the only data read from the PC area the elements used for the currently displayed screen. Even if the contents of the PC words allocated to memory tables are changed, these contents are not updated at the PT unless the memory table is used for the displayed screen.

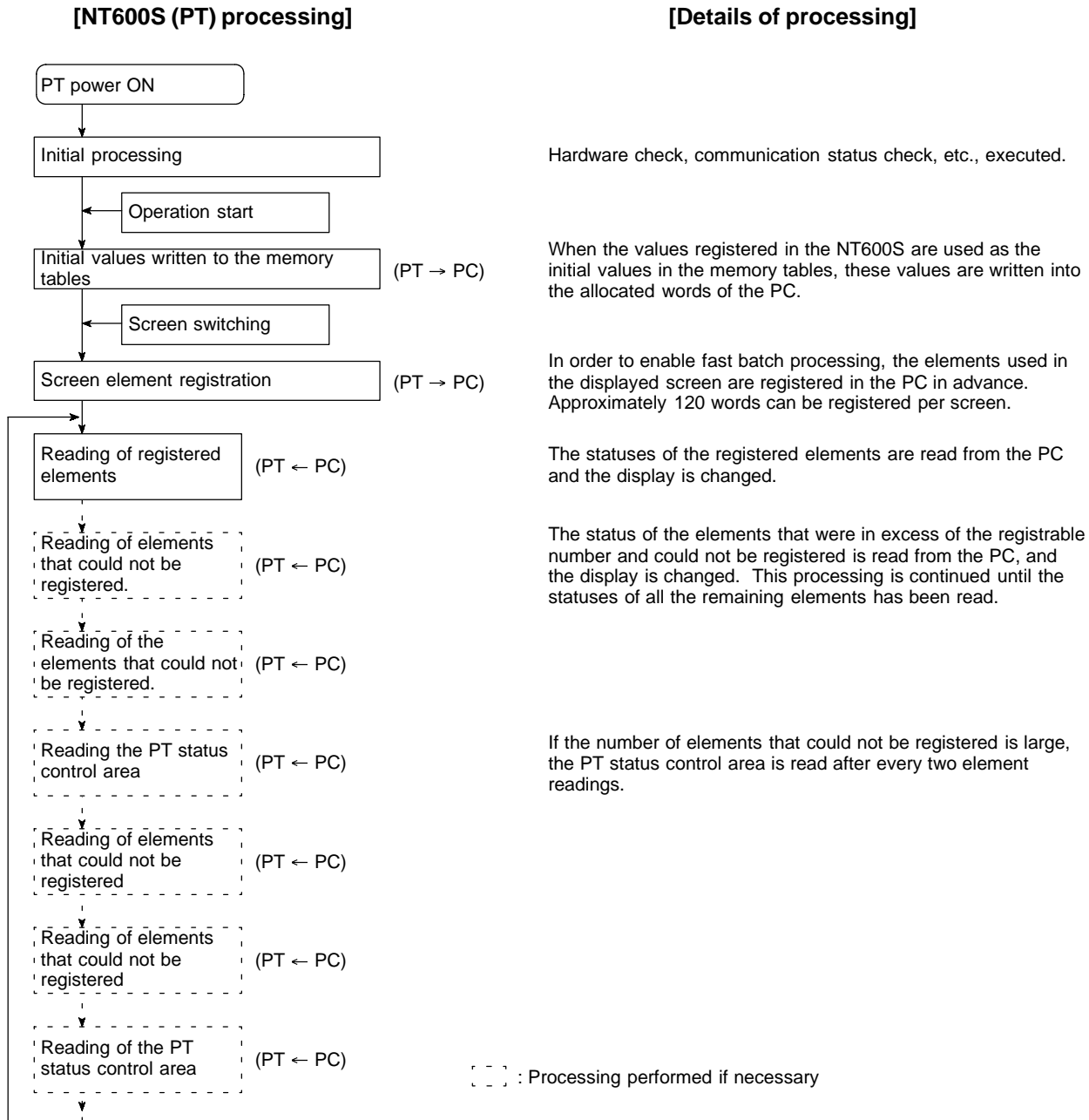



- Number of words for screen element registration

The number of words used for screen element registration is as follows.

Allocated words: Number of words

Allocated bits : Number of words calculated by summing the number of bits in each area and taking 1 word to be 16 bits.

[Example]

Character string memory tables : 3 of 12 allocated words each

Numeral memory tables : 4 of 2 allocated words each

Allocated bits for control : 19 I/O relays, 7 link relays (contiguous bits)

The number of words assigned to character string memory tables and numeral memory tables is as follows:

$$12 \text{ words} \times 3 + 2 \text{ words} \times 4 = 44 \text{ words}$$

The assignment for bits is as follows:

$$19 \text{ I/O relays} \div 16 = 1 \text{ word with a remainder of 3 bits} \rightarrow 2 \text{ words}$$

$$7 \text{ link relays} \div 16 = 0 \text{ words with a remainder of 7 bits} \rightarrow 1 \text{ word}$$

The total is therefore 44 words + 2 words + 1 word = 47 words

Elements occupying up to approximately 120 words, calculated in this way, can be registered. If the number of elements is larger than this, internal processing is increased in proportion to the excess number and this generates a delay in processing.

If the point where the registrable quantity is exceeded is in the middle of an element that spans several words (for example a character string memory table), registration is quit without registering that element.

- Order of priority for registration

Elements are registered in the following order of priority according to their type.

- (1) Allocated words of the PT status control area
- (2) Allocated bits for control (lamps, touch switches)
- (3) Allocated words of numeral memory tables
- (4) Allocated words of character string memory tables

If there is more than one element for each of (2) through (4), the elements are registered in accordance with the following priority of word and bit areas:

- (1) Data memory (DM)
- (2) I/O relays (CH)
- (3) Timers (TIM)
- (4) Counters (CNT)
- (5) Holding relays (HR)
- (6) Auxiliary relays (AR)

Within each area, words and bits are allocated from the smallest number up.

**Reference** Only the bit and numeral/character-string memory table data of elements currently being used in the screen display is written to the PC. If the contents of a numeral/character-string memory table that is not being used for display change, the new data is not written to the PC.

## Event Processing (When Using Direct Connection)

When the status of the NT600S changes during operation, the processing for writing the changed data to the relevant area of the PC memory is executed.

This kind of processing is only executed when statuses change. When changes occur simultaneously, the processes are executed in accordance with the order of priority.

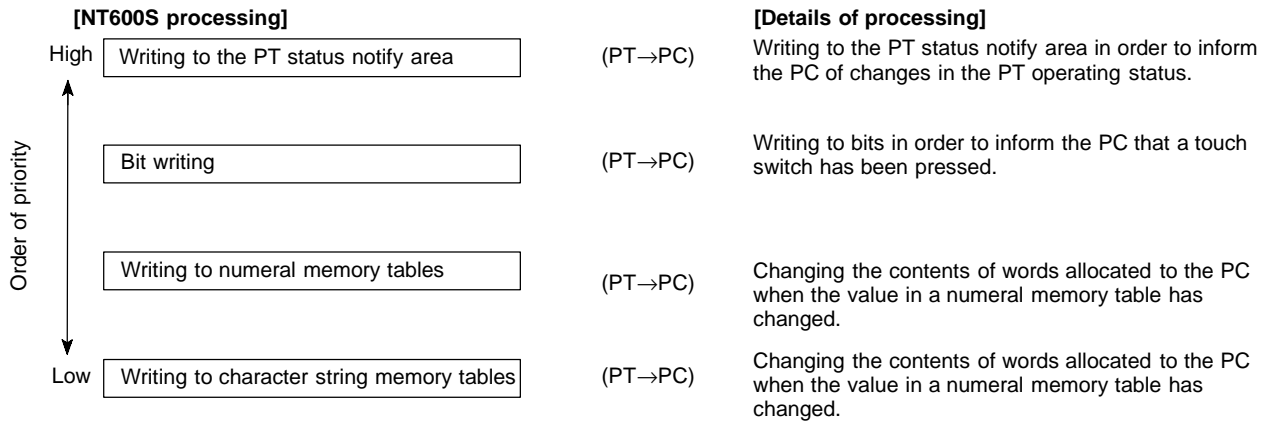

**Reference** Data is only written to PC bits and numeral/character string memory tables for elements in screens currently being displayed. If the contents of numeral/character string memory tables that are not being displayed change, the changed contents are not written to the PC.

## APPENDIX J

### Model List

#### PT

Model	Specification
NT600S-ST121-EV□	Beige, LCD type
NT600S-ST121B-EV□	Black, LCD type
NT600S-ST211-EV□	Beige, EL type
NT600S-ST211B-EV□	Black, EL type

#### Host Link Unit

Model	Specification	Applicable PC
C120-LK201-V1 3G2A6-LK201-EV1	CPU-mounted type with RS-232C connector	C-series C120 C200H
C120-LK202-V1 3G2A6-LK202-EV1	CPU-mounted type with RS-422 connector	C500(F) C1000H C2000 (H)
C200H-LK101-PV1	Rack-mounting Unit with optical-fiber cable connector for C200H	C-series
C200H-LK201-V1	Rack-mounting Unit with RS-232C connector for C200H	C200H C200HS C200HE
C200H-LK202-V1	Rack-mounting Unit with RS-422C connector for C200H	C200HG C200HX
C500-LK101-(P)V1 3G2A5-LK201-EV1	Features an optical-fiber cable connector	C-series
C500-LK103(-P)	Rack-mounting Unit for C500	C500(F) C1000(H) C2000(H)
C500-LK201-V1 3G2A5-LK101-(P)EV1	Features a selectable RS232C/RS-422 connector	
C500-LK203	Rack-mounting Unit for C500	
CV500-LK201	<ul style="list-style-type: none"> <li>• Features an RS-232C connector and a selectable RS-232C/RS-422 connector</li> <li>• Rack-mounting Unit for CVM1/CV</li> </ul>	CVM1/CV-series CV500 CV1000 CV2000 CVM1

## CPU's (For Connection Via a Host Link)

Model	Specification	PC Type
C20H C28H C40H C60H	Features a 9-pin connector for RS-232C connections	C-series C20H C28H C40H C60H
CPM1-10CDR-□ CPM1-20CDR-□ CPM1-30CDR-□	Connect an RS-232C adapter to the peripheral port.	C-series CPM1
CQM1-CPU21-E CQM1-CPU41-E CQM1-CPU42-E CQM1-CPU43-E CQM1-CPU44-E	Features a 9-pin connector for RS-232C connections	C-series CQM1
C200HS-CPU21-E C200HS-CPU23-E C200HS-CPU31-E C200HS-CPU33-E	Features a connector for RS-232C connections (selectable/9-pin)	C200HS
C200HE-CPU32-E(*) C200HE-CPU42-E	Features a connector for RS-232C connections (selectable/9-pin)	C-series C200HE
C200HG-CPU33-E(*) C200HG-CPU43-E C200HG-CPU53-E(*) C200HG-CPU63-E	Features a connector for RS-232C connections (selectable/9-pin)	C-series C200HG
C200HX-CPU34-E(*) C200HX-CPU44-E C200HX-CPU54-E(*) C200HX-CPU64-E	Features a connector for RS-232C connections (selectable/9-pin)	C-series C200HX
CV500-CPU01-EV1 CV1000-CPU01-EV1 CV2000-CPU01-EV1 CVM1-CPU01-EV□ CVM1-CPU11-EV□ CVM1-CPU21-EV□	Features a connector for RS-232C connections (selectable/9-pin)	CVM1/CV-series CV500 CV1000 CV2000 CVM1

**Note** For CPU units marked (\*), a communications port is required.

## CPUs (For Connection Via an NT Link (1:1))

Name	Model	PC Type
CPM1-10CDR-□ CPM1-20CDR-□ CPM1-30CDR-□	Connect an RS-232C adapter to the peripheral port.	C-series CPM1
CQM1-CPU41-E CQM1-CPU42-E CQM1-CPU43-E CQM1-CPU44-E	Features a 9-pin connector for RS-232C connections	C-series CQM1
C200HS-CPU21-E C200HS-CPU23-E C200HS-CPU31-E C200HS-CPU33-E	Features a 9-pin connector for RS-232C connections	C200HS
C200HE-CPU32-E(*) C200HE-CPU42-E	Features a connector for RS-232C connections (selectable/9-pin)	C-series C200HE
C200HG-CPU33-E(*) C200HG-CPU43-E C200HG-CPU53-E(*) C200HG-CPU63-E	Features a connector for RS-232C connections (selectable/9-pin)	C-series C200HG
C200HX-CPU34-E(*) C200HX-CPU44-E C200HX-CPU54-E(*) C200HX-CPU64-E	Features a connector for RS-232C connections (selectable/9-pin)	C-series C200HX
CV500-CPU01-EV1 CV1000-CPU01-EV1 CV2000-CPU01-EV1	Features a 9-pin connector for RS-232C connections	CV500 CV1000 CV2000
CVM1-CPU01-EV1 CVM1-CPU11-EV1 CVM1-CPU21-EV1	Features a 9-pin connector for RS-232C connections	CVM1-series

**Note** For CPU units marked (\*), a communications port is required.

## CPUs (For Connection Via an NT Link (1:N))

Model	Specification	PC Type
C200HE-CPU32-E(*) C200HE-CPU42-E	Features a connector for RS-232C connections (selectable/9-pin)	C-series C200HE
C200HG-CPU33-E(*) C200HG-CPU43-E C200HG-CPU53-E(*) C200HG-CPU63-E	Features a connector for RS-232C connections (selectable/9-pin)	C-series C200HG
C200HX-CPU34-E(*) C200HX-CPU44-E C200HX-CPU54-E(*) C200HX-CPU64-E	Features a connector for RS-232C connections (selectable/9-pin)	C-series C200HX

**Note** For CPU units marked (\*), a communications port is required.

## CPUs (For Connection Via a C200H Direct Communication)

Name	PC Type
C20H C28H C40H C60H	C-series C20H C28H C40H C60H
C200H-CPU01-E C200H-CPU03-E C200H-CPU11-E C200H-CPU21-E C200H-CPU23-E C200H-CPU31-E	C200H
C200HS-CPU01-E C200HS-CPU03-E C200HS-CPU11-E C200HS-CPU21-E C200HS-CPU23-E C200HS-CPU31-E	C200HS
C200HE-CPU11-E C200HE-CPU32-E C200HE-CPU42-E	C200HE
C200HG-CPU33-E C200HG-CPU43-E C200HG-CPU53-E C200HG-CPU63-E	C200HG
C200HX-CPU34-E C200HX-CPU44-E C200HX-CPU54-E C200HX-CPU64-E	C200HX

## Related Parts and Equipment for PT

Name	Model	Remarks
Support Tool	NT-ZA3AT-EV2	3.5 inch FD for NT Series
Options	NT600S-CFL01	Replaceable backlight
	NT600M-KBA04	Reflection-suppressing protective sheet
	NT600S-KBA01	Chemical-resistant cover
	3G2A9-BAT08	Battery
	NT-LB122	C200H I/F Unit

## RS-232C/RS-422 Converter Unit

Model	Specification
NT-AL001	RS-232C : 9-pin connector RS-422A : 8-pin connector

## RS-232C Adapter

Model	Specification
CPM1-CIF01	Connect the RS-232C port of the NT600S and the peripheral port of the CPM1.

## Parts Used for Connection

### Cables with connectors

Model	Cable Length	Applicable Units	Communication Method
XW2Z-200S	2 m	Host link units with 25-pin connectors	Host link
XW2Z-500S	5 m		
XW2Z-200T	2 m	Host link units and CPU units with 9-pin connectors	Host link, NT link (1 to 1)
XW2Z-500T	5 m		
C200H-CN311	30 cm	C200H, C200HS, C200HX/HG/HE	C200H direct communication
NT20M-CNP711 C200H-CN711	70 cm		
NT20M-CNP221 C200H-CN221	2 m		
NT20M-CNP521 C200H-CN521	5 m		
NT20M-CNP131 C200H-CN131	10 m		
C20H-CN312	30 cm		
NT20M-CNP712 C20H-CN712	70 cm		
NT20M-CNP222 C20H-CN222	2 m		

### Connection cable

Model	Remarks
AWG28 × 5P IFVV-SB	Multicore cable, manufactured by Fujikura, Ltd.
CO-MA-VV-SB 5P × 28AWG	Multicore cable, manufactured by Hitachi Cable, Ltd.

### Applicable connectors

Name	Model	Remark
Connector	XM2A-2501	25-pin, manufactured by OMRON
	XM2A-0901	9-pin (Plug), manufactured by OMRON
	XM2D-0901	9-pin (Socket), manufactured by OMRON
	DB-25P	25-pin, manufactured by JAE
Connector cover	XM2S-2511	25-pin, manufactured by OMRON
	XM2S-0901	9-pin, manufactured by OMRON
	DB-C2-J9	25-pin, manufactured by JAE

## APPENDIX K

### Option List

#### Replaceable Backlight ... NT600S-CFL01

This is a backlight for replacement purposes.



#### Reflection-Suppressing Protective Sheet ... NT600M-KBA04

Stuck to the display to prevent it from being soiled. The entire sheet is colorless and transparent.

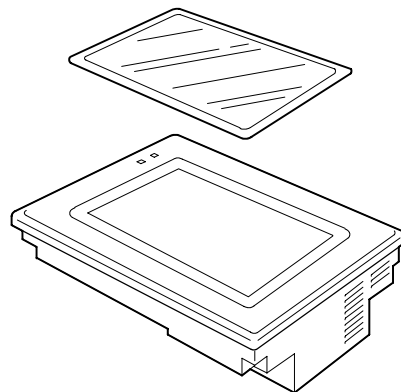



**Chemical-resistant Cover .. Type NT600S-KBA01**

Covers the front panel and protects it from chemical agents. The entire sheet is milky white and made of silicone rubber.

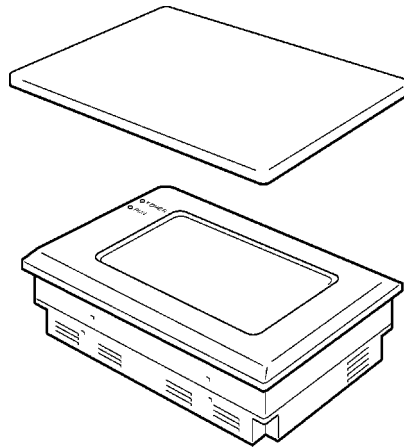

The protection the cover affords is summarized below.

Protects Against	Does Not Protect Against
Boric acid	Hexane
Sulfuric acid	Lubricating oils
Nitric acid	Benzene
Ammonia gas	Butane
Carbon dioxide	Carbonic acid
Phenol	Chlorinated solvents
Glycerin	Napthalene
Ammonia water	Soya oil
Calcium chloride	Toluene
Developing fluid ("hypo")	
Acetaldehyde	
Lard	

For information on protection against chemical agents not included in the table above, please ask OMRON. (If it is a chemical agent to which silicone rubber is recognized to be resistant, the cover can be used with confidence even if that chemical agent is not listed in the "Protects Against" column above.)

- Reference**
- This cover does not afford protection against all chemical agents.
  - Since the cover is milky white, it reduces the clarity of the display a little.
  - This cover is intended to be affixed to the display in order to provide protection against chemical agents. It will not provide protection against chemical agents that enter through the installation panel or through the gap between the cover and the display.

**C200H Interface Unit ... NT-LB122**

This is a host interface unit for executing direct communication.

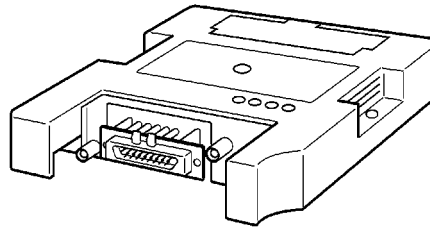
**Battery ... 3G2A9-BAT08**

This is a lithium battery used for memory backup.

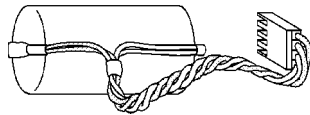
**Note**

---

The disposal of the batteries and backlight may be regulated by national or local authorities.

Dispose of them in accordance with the laws and regulations of the relevant country and local authority.

---

## APPENDIX L

### PC Memory Map

#### OMRON C-Series Memory Map

Area		IR Area	HR Area	AR Area	Link Relay Area	Timer/Counter Area	DM Area
Ladder type	C20H C28H C40H C60H	0000 to 0255	0000 to 0099	0000 to 0027	0000 to 0063	0000 to 0511	0000 to 1999
	C120	0000 to 0063	0000 to 0031			0000 to 0127	0000 to 0051
	C200H	0000 to 0255	0000 to 0099	0000 to 0027	0000 to 0063	0000 to 0511	0000 to 1999
	C200HS C200HE C200HG C200HX	0000 to 0511	0000 to 0099	0000 to 0027	0000 to 0063	0000 to 0511	0000 to 6655 7000 to 9999
	C500	0000 to 0063	0000 to 0031		0000 to 0031	0000 to 0127	0000 to 0511
	C1000H	0000 to 0255	0000 to 0099	0000 to 0027	0000 to 0063	0000 to 0051	0000 to 4095
	C2000(H) CQM1						0000 to 6655
	CPM1	0000 to 0019 0200 to 0255	0000 to 0019	0000 to 0015	0000 to 0015	0000 to 0127	0000 to 1023 6144 to 6655
Flow type	C500F	0000 to 0063	0000 to 0031		0000 to 0031	0000 to 0127	0000 to 0511
	C1000HF	0000 to 0255	0000 to 0099	0000 to 0027	0000 to 0063	0000 to 0511	0000 to 4095

#### OMRON CV-Series Memory Map

Area	IR Area	HR Area (*1)	AR Area	Link Relay Area	Timer/Counter Area	DM Area
CV500 CVM1-CPU01-V□	0000 to 2555		0000 to 0511		0000 to 0511	0000 to 8191
CV1000 CVM1-CPU11(-V□) CV2000 CVM1-CPU21(-V□)	0000 to 2555		0000 to 0511		0000 to 1023	0000 to 9999 (*2)

(\*1) Included in the IR area in the case of CVM1/CV-series PCs.

(\*2) This is the area that can be used with an NT600S. The DM area itself occupies the range 00000 to 24575.

## APPENDIX M

### Special Characters

#### English Character Codes

Pin 2 of SW2 must be ON to enable English language messages to use the following codes.

Example: Hex code is represented by 30, decimal code by 48, and character by 0.

30	0
48	

Code 20 and 32 in the table represents a space, as indicated by "SP".

Hex Digits 1st → 2nd ↓	2-		3-		4-		5-		6-		7-		8-		9-	
<b>-0</b>	20	SP	30	0	40	@	50	P	60	'	70	p	80	Ç	90	É
	32		48		64		80		96		112		128		144	
<b>-1</b>	21	!	31	1	41	A	51	Q	61	a	71	q	81	ü	91	æ
	33		49		65		81		97		113		129		145	
<b>-2</b>	22	"	32	2	42	B	52	R	62	b	72	r	82	é	92	Æ
	34		50		66		82		98		114		130		146	
<b>-3</b>	23	#	33	3	43	C	53	S	63	c	73	s	83	â	93	ô
	35		51		67		83		99		115		131		147	
<b>-4</b>	24	\$	34	4	44	D	54	T	64	d	74	t	84	ä	94	ö
	36		52		68		84		100		116		132		148	
<b>-5</b>	25	%	35	5	45	E	55	U	65	e	75	u	85	à	95	ò
	37		53		69		85		101		117		133		149	
<b>-6</b>	26	&	36	6	46	F	56	V	66	f	76	v	86	å	96	û
	38		54		70		86		102		118		134		150	
<b>-7</b>	27	'	37	7	47	G	57	W	67	g	77	w	87	ç	97	ù
	39		55		71		87		103		119		135		151	
<b>-8</b>	28	(	38	8	48	H	58	X	68	h	78	x	88	ê	98	ÿ
	40		56		72		88		104		120		136		152	
<b>-9</b>	29	)	39	9	49	I	59	Y	69	i	79	y	89	ë	99	Ö
	41		57		73		89		105		121		137		153	
<b>-A</b>	2A	*	3A	:	4A	J	5A	Z	6A	j	7A	z	8A	è	9A	Ü
	42		58		74		90		106		122		138		154	
<b>-B</b>	2B	+	3B	;	4B	K	5B	[	6B	k	7B	{	8B	ï	9B	ϕ
	43		59		75		91		107		123		139		155	
<b>-C</b>	2C	,	3C	<	4C	L	5C	\	6C	l	7C		8C	î	9C	£
	44		60		76		92		108		124		140		156	
<b>-D</b>	2D	-	3D	=	4D	M	5D	]	6D	m	7D	}	8D	ì	9D	¥
	45		61		77		93		109		125		141		157	
<b>-E</b>	2E	.	3E	>	4E	N	5E	^	6E	n	7E	~	8E	Ä	9E	Pt
	46		62		78		94		110		126		142		158	
<b>-F</b>	2F	/	3F	?	4F	O	5F	_	6F	o	7F	⏏	8F	Å	9F	f
	47		63		79		95		111		127		143		159	

Hex Digits 1st → 2nd ↓	A-		B-		C-		D-		E-		F-	
-0	A0	á	B0	⋮	C0	┘	D0	⌌	E0	α	F0	≡
	160		176	⋮	192	┘	208	⌌	224		240	
-1	A1	í	B1	■	C1	┘	D1	⌌	E1	β	F1	±
	161		177	■	193	┘	209	⌌	225		241	
-2	A2	ó	B2	⋮	C2	┘	D2	⌌	E2	Γ	F2	≥
	162		178	⋮	194	┘	210	⌌	226		242	
-3	A3	ú	B3		C3	┘	D3	⌌	E3	π	F3	≤
	163		179		195	┘	211	⌌	227		243	
-4	A4	ñ	B4	┘	C4	—	D4	⌌	E4	Σ	F4	∫
	164		180	┘	196	—	212	⌌	228		244	
-5	A5	Ñ	B5	≠	C5	+	D5	ƒ	E5	σ	F5	∫
	165		181	≠	197	+	213	ƒ	229		245	
-6	A6	á	B6	≠	C6	≠	D6	ƒ	E6	μ	F6	÷
	166		182	≠	198	≠	214	ƒ	230		246	
-7	A7	ó	B7	≠	C7	≠	D7	≠	E7	τ	F7	≈
	167		183	≠	199	≠	215	≠	231		247	
-8	A8	¿	B8	≠	C8	≠	D8	≠	E8	Φ	F8	°
	168		184	≠	200	≠	216	≠	232		248	
-9	A9	┘	B9	≠	C9	≠	D9	┘	E9	Θ	F9	·
	169		185	≠	201	≠	217	┘	233		249	
-A	AA	┘	BA		CA	⌌	DA	┘	EA	Ω	FA	•
	170		186		202	⌌	218	┘	234		250	
-B	AB	1/2	BB	┘	CB	≠	DB	■	EB	δ	FB	√
	171		187	┘	203	≠	219	■	235		251	
-C	AC	1/4	BC	≠	CC	≠	DC	■	EC	∞	FC	n
	172		188	≠	204	≠	220	■	236		252	
-D	AD	i	BD	⌌	CD	=	DD	■	ED	∅	FD	2
	173		189	⌌	205	=	221	■	237		253	
-E	AE	«	BE	≠	CE	≠	DE	■	EE	ε	FE	■
	174		190	≠	206	≠	222	■	238		254	
-F	AF	»	BF	┘	CF	⌌	DF	■	EF	∩	FF	* 1
	175		191	┘	207	⌌	223	■	239		255	

\* 1: Used as the prefix for mark data codes (2 bytes).

**Note**

In order to input these characters using the support tool, enter the relevant character code with the numeral keys while holding down the ALT key.



# INDEX

## A

Allocatable bits and words .....	154
Allocated bit .....	13
Allocated word .....	13
Alternate (touch switch) .....	185
Automatic reset function .....	89
Automatic reset .....	245

## B

Backlight OFF function .....	96
Backlight mode .....	194
Backlight .....	194, 247
Bar graphs .....	131
Batch lighting .....	180
Battery .....	292
Before operating .....	20
Buzzer attribute .....	194
Buzzer during operation .....	72
Buzzer .....	193

## C

C200H direct communication .....	56
CPU .....	40
Cannot communicate .....	242
Change the lamp display status .....	181
Changing displayed numerals or character-strings .....	170, 172, 175
Changing the contents of allocated bits .....	181
Changing the contents of allocated words .....	170, 172, 179
Changing the system settings etc. ....	67
Character specify size .....	222
Character string .....	17

Character-string memory table .....	128, 170
Characters .....	8, 120, 128
Checking the LCD display .....	104
Checking the LED .....	101
Checking the buzzer .....	102
Checking the communications .....	105
Checking the touch switches .....	102
Child screens .....	124, 125
Classification of screens .....	124
Clear screen .....	222
Communication I/F .....	106
Communication procedure .....	202
Comparison between NT600S and NT600M ....	7
Compatibility .....	4
Compatible PCs .....	31, 43
Computer is reset .....	82
Connecting the NT600S .....	32, 43
Connector specifications .....	267
Connector .....	32
Content upgrade memory table .....	190
Continuous buzzer .....	194
Continuous screens .....	125, 147, 161, 163
Contrast control .....	25
Control bits .....	183
Control timing .....	195
Controlling the NT600S status .....	156, 192
Controlling the display elements .....	155
Copy memory table setting .....	175
Copy memory table .....	211
Copy type .....	175, 177
Copying the memory table .....	175



Creating screen data ..... 115

## D

DIP switch settings ..... 107

DIP switch ..... 28, 40

Data memory (DM) ..... 183

Decimal fraction parts ..... 148

Description of parts ..... 26

Determine the upgraded numeral memory table  
number ..... 189

Determining touch switch status ..... 185

Direct connection data setting ..... 117

Direct connection ..... 13, 115

Direct information ..... 244

Display elements ..... 16

Display frame ..... 141

Display history ..... 110

Display mode control ..... 217

Display specified screen ..... 208

Draw circle ..... 227

Draw polyline ..... 226

## E

ERR ON ..... 96

Edit screen ..... 117

End flashing display ..... 225

End inverse display ..... 224

Enlarged display ..... 121

Equivalent to IP65 ..... 4

Error message during the start-up ..... 72

Error messages ..... 244

## F

Factory setting ..... 27

File units ..... 79

Flash memory ..... 83

Flash ..... 135, 140

Flashing display ..... 121, 129

Frame ..... 135

## G

Graph frame ..... 132

Grounding terminal ..... 25

Grounding ..... 29

Guide display ..... 140

## H

Host I/F tool connector ..... 25

Host link method ..... 31

Host link unit ..... 33, 34

Host link ..... 13, 85

## I

I/O check ..... 101

IP65 ..... 27

Image data memory ..... 72

Initialization by using the DIP switch  
(Forced initialization) ..... 74

Initialization by using the system menu ..... 73

Initialization error ..... 244

Initialization of the display history data  
memory ..... 76

Initialization setting ..... 162, 167

Initialize display history ..... 216

Initializing memory ..... 72

Initializing ..... 72

Integer parts ..... 148

Intermittent buzzer ..... 194

Intermittent sound ..... 95, 126

Internal processing ..... 282

## K

Key press sound ..... 93

## L

LCD ..... 264

LSS ..... 39, 40, 41, 44

Lamp and touch switch display status enquiry ..... 213

Lamp and touch switch display status response ..... 219

Lamp and touch switch display ..... 212, 213

Lamps ..... 8, 16, 135

Lid of CFL case ..... 25

Lit ..... 135, 140

## M

Maintenance mode ..... 70

Maintenance ..... 68

Making the cable for connection ..... 266

Mark data ..... 244

Marks ..... 9, 120, 128

Memory initialization by using the DIP switch ..... 82

Memory initialization ..... 74

Memory size ..... 115

Memory switches ..... 83

Menu tree ..... 69

Momentary (touch switch) ..... 186

Monitoring ..... 17

## N

9-pin ..... 32

NT link ..... 13, 14, 43, 85

NT600S cannot be normally started ..... 72

NT600S ..... 2

Normal display ..... 223

Normal screen ..... 124

Nothing is displayed ..... 242

Notification and control of touch switches ..... 205

Notification of numbers to the PC ..... 189

Notify bit ..... 183

Notifying the NT600S status ..... 157

Notifying the PC ..... 185

Notifying the display elements ..... 157

Notifying the display screen ..... 162

Number of registration words ..... 164, 166

Numeral memory table ..... 16, 129, 169

Numeral setting attributes ..... 126, 144

Numeral setting strobe flag ..... 190, 198

Numeral setting ..... 125, 143

Numeric keys ..... 144

Numeric values ..... 8

## O

100% value ..... 132

Operating panel ..... 2, 27

Operating status ..... 2, 198

Operation commands ..... 19, 207, 208, 218

Operation modes ..... 68

Operation will be automatically reset ..... 89

Operations with the system menu ..... 70

Overlapping screen ..... 124, 146, 161, 163

## P

PC memory map ..... 293

PC system setting ..... 39, 40, 41, 45

PC ..... 31

% display ..... 132

POWER LED ..... 242

POWER .....	102
PT battery status response .....	221
PT operating status .....	197
PT status control area .....	18, 156, 192
PT status enquiry .....	216
PT status notify area .....	18, 158
PT status .....	197
PT type .....	115
PT .....	2
Page number display .....	125
Parent screen .....	124, 125
Percentage .....	132
Peripheral tool .....	39, 40, 41, 45
Power input terminals .....	25, 28
Press .....	71
Production line status .....	2
Programmable terminal .....	2

## R

RS-232C cable .....	30
RUN .....	68, 102
Reflection-suppressing protective sheet .....	290
Replaceable backlight .....	290
Replacing the backlight .....	248
Request screen number .....	209
Reset switch .....	25
Reset .....	82
Reverse and flashing display .....	121, 129
Reverse display .....	121, 129, 135

## S

Screen attributes .....	126
Screen data displayed on the NT600S .....	9
Screen data memory is initialized .....	73, 74

Screen data .....	79, 244
Screen display control .....	208
Screen display .....	194
Screen list .....	116
Screen number 0 .....	119, 242
Screen number 1 .....	92
Screen number response .....	218
Screen number .....	119
Screen switch setting .....	160
Screen switch .....	142
Screen switching strobe .....	161, 162, 198
Screen switching timing .....	161
Screen .....	119
Selecting communication speed .....	86
Selecting the host communication method .....	85
Selecting the menu items .....	71
Set a screen number for a touch switch .....	142
Set a system key function for a touch switch .....	142
Set cursor position .....	225
Set flashing display .....	224
Set inverse display .....	224
Setting error .....	244
Setting status .....	108
Setting the buzzer .....	94
Setting the support tool mode .....	99
Setting the support tool .....	114
Setting the words for the character-string memory tables .....	166
Setting the words for the numeral memory tables number .....	167
Set (touch switch) .....	186
Sign display .....	132
Smoothing .....	121, 129

Solderless terminal .....	29
Specify character enlargement .....	223
Specify displayed characters .....	226
Standard .....	140
Start-up screen .....	119
Start-up .....	67
Statuses of touch switches are changed .....	185
Stop the buzzer sound .....	94, 102
Support tool .....	3, 30, 79, 115
Switch predetermined values or character-strings according to the situation .....	175
Switching the continuous screens .....	126
Switching the screen display .....	160
Switching to the RUN mode .....	92
System key functions .....	142
System menu display permission .....	216
System menu .....	68
System .....	127

## T

Table of commands .....	207
Terminal commands .....	19, 207, 222
3-D .....	140
Thumb-wheel numeral settings .....	148
Tool settings .....	114
Tool transmit .....	106
Touch switch bit output .....	220
Touch switch disable .....	214
Touch switch enable .....	214
Touch switch number output .....	221
Touch switches used to call the system menu .....	70
Touch switches .....	9, 17, 70, 139
Transmit mode .....	71, 80

Transmit .....	68, 79
Transmitting screen data .....	79, 118
Turn ON the power .....	67
25-pin .....	32

## U

Unlit .....	135
Upgrading bar graphs .....	179
Use touch switches for notification to the PC .....	183
User .....	144

## W

Warning lamp .....	195
Waterproofed .....	4
Wiring .....	267
Write character-string memory table .....	209
Write numeral memory table .....	210

## X

XON/XOFF control .....	63, 89
------------------------	--------

## Z

Zero suppress .....	130
---------------------	-----



## Revision History

# NT-series Programmable Terminal Operation Manual

A manual revision code appears as a suffix to the catalog number on the front cover of the manual.

Cat. No. V022-E3-1  
Revision code

The following table outlines the changes made to the manual during each revision. Page numbers refer to the previous version.

Revision code	Date	Revised content
E1-1	5-1995	Original production
E1-2	9-1995	<ul style="list-style-type: none"><li>• Additions relating to numeral input (numeral input using thumb wheel keys).</li><li>• Additions relating to operation for notification to the PC using touch switches (alternate set/reset).</li><li>• Additions relating to additional functions when performing numeral input (upper/lower limit check, hexadecimal input).</li><li>• Additions relating to additional communication method (C200H direct communication).</li></ul>
E1-3	5-1997	<ul style="list-style-type: none"><li>• Amendments relating to addition of the NT link (1:N) method communication function.</li><li>• Amendments relating to additions to safety notices and correction of errata.</li><li>• Amendments relating to addition of the Mitsubishi A computer link communication function, addition of an applicable PC (CPM1), additional explanations and correction of errata.</li></ul>
E3-1	7-97	Some reformat required for printing. Cable wiring drawings corrected in Sec 2-6, pages 51 and 52.

## Free Manuals Download Website

<http://myh66.com>

<http://usermanuals.us>

<http://www.somanuals.com>

<http://www.4manuals.cc>

<http://www.manual-lib.com>

<http://www.404manual.com>

<http://www.luxmanual.com>

<http://aubethermostatmanual.com>

Golf course search by state

<http://golfingnear.com>

Email search by domain

<http://emailbydomain.com>

Auto manuals search

<http://auto.somanuals.com>

TV manuals search

<http://tv.somanuals.com>