

# **SYSMAC CPM2B**

## **Programmable Controller**

# **OPERATION MANUAL**

**OMRON**

# **SYSMAC CPM2B**

## **Programmable Controller**

### **Operation Manual**

*Produced February 2000*

## Notice:

OMRON products are manufactured for use according to proper procedures by a qualified operator and only for the purposes described in this manual.

The following conventions are used to indicate and classify precautions in this manual. Always heed the information provided with them. Failure to heed precautions can result in injury to people or damage to property.

 **DANGER** Indicates an imminently hazardous situation which, if not avoided, will result in death or serious injury.

 **WARNING** Indicates a potentially hazardous situation which, if not avoided, could result in death or serious injury.

 **Caution** Indicates a potentially hazardous situation which, if not avoided, may result in minor or moderate injury, or property damage.

## OMRON Product References

All OMRON products are capitalized in this manual. The word “Unit” is also capitalized when it refers to an OMRON product, regardless of whether or not it appears in the proper name of the product.

The abbreviation “Ch,” which appears in some displays and on some OMRON products, often means “word” and is abbreviated “Wd” in documentation in this sense.

The abbreviation “PC” means Programmable Controller and is not used as an abbreviation for anything else.

## Visual Aids

The following headings appear in the left column of the manual to help you locate different types of information.

**Note** Indicates information of particular interest for efficient and convenient operation of the product.

**1, 2, 3...** 1. Indicates lists of one sort or another, such as procedures, checklists, etc.

## © OMRON, 2000

All rights reserved. No part of this publication may be reproduced, stored in a retrieval system, or transmitted, in any form, or by any means, mechanical, electronic, photocopying, recording, or otherwise, without the prior written permission of OMRON.

No patent liability is assumed with respect to the use of the information contained herein. Moreover, because OMRON is constantly striving to improve its high-quality products, the information contained in this manual is subject to change without notice. Every precaution has been taken in the preparation of this manual. Nevertheless, OMRON assumes no responsibility for errors or omissions. Neither is any liability assumed for damages resulting from the use of the information contained in this publication.

# TABLE OF CONTENTS

<b>PRECAUTIONS</b> .....	<b>xi</b>
1 Intended Audience .....	xii
2 General Precautions .....	xii
3 Safety Precautions .....	xii
4 Operating Environment Precautions .....	xiii
5 Application Precautions .....	xiii
6 EC Directives .....	xv
<b>SECTION 1</b>	
<b>Introduction</b> .....	<b>1</b>
1-1 CPM2B Features and Functions .....	2
1-2 System Configurations .....	6
1-3 Structure and Operation .....	13
<b>SECTION 2</b>	
<b>Board Specifications and Components</b> .....	<b>21</b>
2-1 Specifications .....	22
2-2 Board Components and their Functions .....	29
2-3 I/O Connector and Terminal Pin Allocation .....	33
<b>SECTION 3</b>	
<b>Installation and Wiring</b> .....	<b>35</b>
3-1 Design Precautions .....	36
3-2 Selecting an Installation Site .....	36
3-3 Assembling the CPM2B Boards .....	38
3-4 Installing the CPM2B .....	39
3-5 Wiring and Connections .....	40
<b>SECTION 4</b>	
<b>Memory Areas</b> .....	<b>53</b>
4-1 Introduction .....	54
4-2 I/O Allocation .....	55
4-3 SR Area .....	58
4-4 AR Area .....	60
4-5 PC Setup .....	64
4-6 Error Log .....	69
<b>SECTION 5</b>	
<b>Instruction Set</b> .....	<b>71</b>
5-1 CPM2B Function Codes .....	72
5-2 Alphabetic List by Mnemonic .....	73
5-3 Expansion Instructions .....	76
<b>SECTION 6</b>	
<b>Using Programming Devices</b> .....	<b>77</b>
6-1 Using a Programming Console .....	78
6-2 Programming Console Operations .....	84
6-3 Programming Example .....	106

# TABLE OF CONTENTS

## SECTION 7

### **Test Runs and Error Processing . . . . . 113**

7-1	Initial System Checks and Test Run Procedure . . . . .	114
7-2	CPM2B Test Run Procedure . . . . .	114
7-3	Self-diagnostic Functions . . . . .	115
7-4	Troubleshooting Flowcharts . . . . .	118
7-5	Maintenance Inspections . . . . .	125
7-6	Battery Replacement . . . . .	126

### **Appendices**

A	Standard Models . . . . .	129
B	Dimensions . . . . .	133

### **Index . . . . . 135**

### **Revision History . . . . . 139**

## About this Manual:

This manual describes the installation and operation of the CPM2B and includes the sections described below.

The CPM2B is a compact, high-speed board Programmable Controller (PC) designed for control operations. There are two manuals describing the setup and operation of the CPM2B: The *CPM2B Operation Manual* (this manual) and the *CPM1/CPM1A/CPM2A/CPM2C/SRM1(-V2) Programming Manual* (W353). (The *CPM1/CPM1A/CPM2A/CPM2C/SRM1(-V2) Programming Manual* is referred to as simply the *Programming Manual* in this manual.)

This manual describes the system configuration and installation of the CPM2B and provides a basic explanation of operating procedures for the Programming Consoles. Read this manual first to acquaint yourself with the CPM2B.

The *Programming Manual* (W353) provides detailed descriptions of the CPM2B's programming functions. The *SYSMAC Support Software Operation Manuals: Basics and C-series PCs* (W247 and W248) provide descriptions of SSS operations for the CPM2B and other SYSMAC C-series PCs. The *SYSMAC-CPT Support Software Quick Start Guide* (W332) and *User Manual* (W333) provide descriptions of ladder diagram operations in the Windows environment. The *WS02-CXPC1-E CX-Programmer User Manual* (W361) and the *CX-Server User Manual* (W362) provide details of operations for the WS02-CXPC1-E CX-Programmer.

Please read this manual carefully and be sure you understand the information provided before attempting to install and operate the CP2MB.

**Section 1** describes the CPM2B's special features and functions, shows the possible system configurations, and outlines the steps required before operation. Read this section first when using the CPM2B for the first time. Refer to the *CPM1/CPM1A/CPM2A/CPM2C/SRM1(-V2) Programming Manual* (W353) for details on programming.

**Section 2** provides the technical specifications of the CPM2B Boards and describes the main components of the Boards.

**Section 3** provides information on installing and wiring a CPM2B PC. Be sure to follow the directions and precautions in this section when installing the CPM2B in a panel or cabinet, wiring the power supply, or wiring I/O.

**Section 4** describes the structure of the PC memory areas and explains how to use them.

**Section 5** provides a brief summary of the instruction set. Refer to the *CPM1/CPM1A/CPM2A/CPM2C/SRM1(-V2) Programming Manual* (W353) for details on specific instructions.

**Section 6** provides information on Programming Console operations.

**Section 7** describes procedures for trial CPM2B operation, self-diagnosis functions, and error processing to identify and correct the hardware and software errors that can occur during PC operation.

**Appendices** provides lists of standard models and Board dimensions.



### **WARNING**

Failure to read and understand the information provided in this manual may result in personal injury or death, damage to the product, or product failure. Please read each section in its entirety and be sure you understand the information provided in the section and related sections before attempting any of the procedures or operations given.

# PRECAUTIONS

This section provides general precautions for using the Programmable Controller (PC) and related devices.

**The information contained in this section is important for the safe and reliable application of the Programmable Controller. You must read this section and understand the information contained before attempting to set up or operate a PC system.**

1 Intended Audience .....	xii
2 General Precautions .....	xii
3 Safety Precautions .....	xii
4 Operating Environment Precautions .....	xiii
5 Application Precautions .....	xiii
6 EC Directives .....	xv

## 1 Intended Audience

This manual is intended for the following personnel, who must also have knowledge of electrical systems (an electrical engineer or the equivalent).

- Personnel in charge of installing FA systems.
- Personnel in charge of designing FA systems.
- Personnel in charge of managing FA systems and facilities.

## 2 General Precautions

The user must operate the product according to the performance specifications described in the operation manuals.





Before using the product under conditions which are not described in the manual or applying the product to nuclear control systems, railroad systems, aviation systems, vehicles, combustion systems, medical equipment, amusement machines, safety equipment, and other systems, machines, and equipment that may have a serious influence on lives and property if used improperly, consult your OMRON representative.

Make sure that the ratings and performance characteristics of the product are sufficient for the systems, machines, and equipment, and be sure to provide the systems, machines, and equipment with double safety mechanisms.

This manual provides information for programming and operating the Unit. Be sure to read this manual before attempting to use the Unit and keep this manual close at hand for reference during operation.

-  **WARNING** It is extremely important that a PC and all PC Units be used for the specified purpose and under the specified conditions, especially in applications that can directly or indirectly affect human life. You must consult with your OMRON representative before applying a PC System to the above-mentioned applications.

## 3 Safety Precautions

-  **WARNING** Do not attempt to take any board apart while the power is being supplied. Doing so may result in electric shock.
-  **WARNING** Do not touch any of the terminals, terminal blocks or, for the CPM2B, the CPU board or expansion I/O board while the power is being supplied. Doing so may result in electric shock.
-  **WARNING** When handling the Memory Backup Battery, never drop, disassemble, distort, short-circuit, heat to a high temperature, or throw into fire. Otherwise the Battery may explode, catch fire, or leak fluid.
-  **WARNING** Do not attempt to disassemble, repair, or modify any Units. Any attempt to do so may result in malfunction, fire, or electric shock.
-  **WARNING** Provide safety measures in external circuits (i.e., not in the Programmable Controller), including the following items, in order to ensure safety in the system if an abnormality occurs due to malfunction of the PC or another external factor affecting the PC operation. Not doing so may result in serious accidents.



- Emergency stop circuits, interlock circuits, limit circuits, and similar safety measures must be provided in external control circuits.
- The PC will turn OFF all outputs when its self-diagnosis function detects any error or when a severe failure alarm (FALS) instruction is executed. As a countermeasure for such errors, external safety measures must be provided to ensure safety in the system.
- The PC outputs may remain ON or OFF due to deposition or burning of the output relays or destruction of the output transistors. As a countermeasure for such problems, external safety measures must be provided to ensure safety in the system.

 **WARNING** When transferring programs to other nodes, or when making changes to I/O memory, confirm the safety of the destination node before transfer. Not doing so may result in injury.

 **Caution** Execute online edit only after confirming that no adverse effects will be caused by extending the cycle time. Otherwise, the input signals may not be readable.

 **Caution** Tighten the screws on the terminal block to the torque specified in the operation manual. The loose screws may result in burning or malfunction.

## 4 Operating Environment Precautions

 **Caution** Do not operate the control system in the following places:

- Locations subject to direct sunlight.
- Locations subject to temperatures or humidity outside the range specified in the specifications.
- Locations subject to condensation as the result of severe changes in temperature.
- Locations subject to corrosive or flammable gases.
- Locations subject to dust (especially iron dust) or salts.
- Locations subject to exposure to water, oil, or chemicals.
- Locations subject to shock or vibration.

 **Caution** Take appropriate and sufficient countermeasures when installing systems in the following locations:

- Locations subject to static electricity or other forms of noise.
- Locations subject to strong electromagnetic fields.
- Locations subject to possible exposure to radioactivity.
- Locations close to power supplies.

 **Caution** The operating environment of the PC System can have a large effect on the longevity and reliability of the system. Improper operating environments can lead to malfunction, failure, and other unforeseeable problems with the PC System. Be sure that the operating environment is within the specified conditions at installation and remains within the specified conditions during the life of the system.

## 5 Application Precautions

Observe the following precautions when using the PC System.

 **WARNING** Always heed these precautions. Failure to abide by the following precautions could lead to serious or possibly fatal injury.

- Always turn OFF the power supply to the PC before attempting any of the following. Not turning OFF the power supply may result in malfunction or electric shock.

- Mounting or dismounting the CPU board or expansion I/O board.
- Setting switches or rotary switches.
- Connecting or wiring the cables.
- Connecting or disconnecting the connectors.

**Caution**

Failure to abide by the following precautions could lead to faulty operation of the PC or the system, or could damage the PC. Always heed these precautions.

- Fail-safe measures must be taken by the customer to ensure safety in the event of incorrect, missing, or abnormal signals caused by broken signal lines, momentary power interruptions, or other causes.
- Construct a control circuit so that power supply for the I/O circuits does not come ON before power supply for the PC. If power supply for the I/O circuits comes ON before power supply for the PC, normal operation may be temporarily interrupted.
- If the operating mode is changed from RUN or MONITOR mode to PROGRAM mode, with the IOM Hold Bit ON, the output will hold the most recent status. In such a case, ensure that the external load does not exceed specifications. (If operation is stopped because of an operation error (including FALS instructions), the values in the internal memory of the CPU board will be saved, but the outputs will all turn OFF.)
- Always use the power supply voltage specified in the operation manuals. An incorrect voltage may result in malfunction or burning.
- Take appropriate measures to ensure that the specified power with the rated voltage is supplied. Be particularly careful in places where the power supply is unstable. An incorrect power supply may result in malfunction.
- Install external breakers and take other safety measures against short-circuiting in external wiring. Insufficient safety measures against short-circuiting may result in burning.
- Do not apply voltages to the input terminals in excess of the rated input voltage. Excess voltages may result in burning.
- Do not apply voltages or connect loads to the output terminals in excess of the maximum switching capacity. Excess voltage or loads may result in burning.
- Be sure that all the mounting screws, terminal screws, and cable connector screws are tightened to the torque specified in the relevant manuals. Incorrect tightening torque may result in malfunction.
- When wiring the CPM2B, take countermeasures to prevent wiring cuttings from coming into contact with the product, such as covering the whole product with a dustproof cover. If wiring cuttings adhere to the PCB or circuit elements they may cause short-circuiting.
- Be sure to perform wiring in accordance with the relevant operation manual. Incorrect wiring may result in burning.
- Double-check all the wiring before turning ON the power supply. Incorrect wiring may result in burning.
- Be sure that the terminal blocks, expansion cables, and other items with locking devices are properly locked into place. Improper locking may result in malfunction.
- Be sure that terminal blocks and connectors are connected in the specified direction with the correct polarity. Not doing so may result in malfunction.
- Check the user program for proper execution before actually running it on the PC. Not checking the program may result in an unexpected operation.
- Confirm that no adverse effect will occur in the system before attempting any of the following. Not doing so may result in an unexpected operation.

- Changing the operating mode of the PC.
- Force-setting/force-resetting any bit in memory.
- Changing the present value of any word or any set value in memory.
- Resume operation only after transferring to the new CPU board the contents of the DM and HR Areas required for resuming operation. Not doing so may result in an unexpected operation.
- Do not pull on the cables or bend the cables beyond their natural limit. Doing either of these may break the cables.
- Do not place objects on top of the cables. Doing so may break the cables.
- Under no circumstances should batteries be short-circuited between positive (+) and negative (–) terminals, charged, disassembled, heated, or thrown into fire.
- When replacing parts, be sure to confirm that the rating of a new part is correct. Not doing so may result in malfunction or burning.
- When transporting or storing the CPM2B, cover the circuit boards in antistatic material to protect them from static electricity and maintain the proper storage temperature.
- Before touching the Unit, be sure to first touch a grounded metallic object in order to discharge any static build-up. Not doing so may result in malfunction or damage.
- Do not touch the expansion I/O connecting cable while the power is being supplied in order to prevent any malfunction due to static electricity.
- Do not touch CPM2B circuit boards or the components mounted to them with your bare hands. There are sharp leads and other parts on the boards that may cause injury if handled improperly.
- When disposing of the product, observe local ordinances and regulations.

## 6 EC Directives

### 6-1 Applicable Directives

- EMC Directives
- Low Voltage Directive

### 6-2 Concepts

#### **EMC Directives**

OMRON devices that comply with EC Directives also conform to the related EMC standards so that they can be more easily built into other devices or the overall machine. The actual products have been checked for conformity to EMC standards (see the following note). Whether the products conform to the standards in the system used by the customer, however, must be checked by the customer.

EMC-related performance of the OMRON devices that comply with EC Directives will vary depending on the configuration, wiring, and other conditions of the equipment or control panel on which the OMRON devices are installed. The customer must, therefore, perform the final check to confirm that devices and the overall machine conform to EMC standards.

**Note** Applicable EMC (Electromagnetic Compatibility) standards are as follows:

EMS (Electromagnetic Susceptibility): EN61131-2

EMI (Electromagnetic Interference): EN50081-2

(Radiated emission: 10-m regulations)

#### **Low Voltage Directive**

Always ensure that devices operating at voltages of 50 to 1,000 VAC and 75 to 1,500 VDC meet the required safety standards for the PC (EN61131-2).

### 6-3 Conformance to EC Directives

The CPM2B PCs comply with EC Directives. To ensure that the machine or device in which the CPM2B PC is used complies with EC directives, the PC must be installed as follows:

- 1, 2, 3... 1. The CPM2B PC must be installed within a control panel.
2. Reinforced insulation or double insulation must be used for the DC power supplies used for the communications and I/O power supplies.
3. CPM2B PCs complying with EC Directives also conform to the Common Emission Standard (EN50081-2). Radiated emission characteristics (10-m regulations) may vary depending on the configuration of the control panel used, other devices connected to the control panel, wiring, and other conditions. You must therefore confirm that the overall machine or equipment complies with EC Directives.

### 6-4 Relay Output Noise Reduction Methods

The CPM2B PCs conform to the Common Emission Standards (EN50081-2) of the EMC Directives. However, the noise generated when the PC is switched ON or OFF using the relay output may not satisfy these standards. In such a case, a noise filter must be connected to the load side or other appropriate countermeasures must be provided external to the PC.

Countermeasures taken to satisfy the standards vary depending on the devices on the load side, wiring, configuration of machines, etc. Following are examples of countermeasures for reducing the generated noise.

#### Countermeasures

(Refer to EN50081-2 for more details.)

Countermeasures are not required if the frequency of load switching for the whole system with the PC included is less than 5 times per minute.

Countermeasures are required if the frequency of load switching for the whole system with the PC included is 5 times or more per minute.

### Countermeasure Examples

When switching an inductive load, connect a surge protector, diodes, etc., in parallel with the load or contact as shown below.

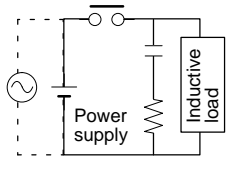
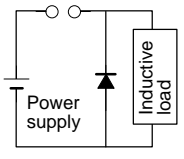
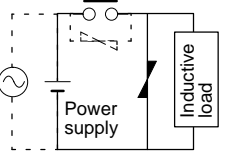
Circuit	Current		Characteristic	Required element
	AC	DC		
<p>CR method</p> 	Yes	Yes	<p>If the load is a relay or solenoid, there is a time lag between the moment the circuit is opened and the moment the load is reset.</p> <p>If the supply voltage is 24 to 48 V, insert the surge protector in parallel with the load. If the supply voltage is 100 to 200 V, insert the surge protector between the contacts.</p>	<p>The capacitance of the capacitor must be 1 to 0.5 <math>\mu\text{F}</math> per contact current of 1 A and resistance of the resistor must be 0.5 to 1 <math>\Omega</math> per contact voltage of 1 V. These values, however, vary with the load and the characteristics of the relay. Decide these values from experiments, and take into consideration that the capacitance suppresses spark discharge when the contacts are separated and the resistance limits the current that flows into the load when the circuit is closed again.</p> <p>The dielectric strength of the capacitor must be 200 to 300 V. If the circuit is an AC circuit, use a capacitor with no polarity.</p>
<p>Diode method</p> 	No	Yes	<p>The diode connected in parallel with the load changes energy accumulated by the coil into a current, which then flows into the coil so that the current will be converted into Joule heat by the resistance of the inductive load.</p> <p>This time lag, between the moment the circuit is opened and the moment the load is reset, caused by this method is longer than that caused by the CR method.</p>	<p>The reversed dielectric strength value of the diode must be at least 10 times as large as the circuit voltage value. The forward current of the diode must be the same as or larger than the load current.</p> <p>The reversed dielectric strength value of the diode may be two to three times larger than the supply voltage if the surge protector is applied to electronic circuits with low circuit voltages.</p>
<p>Varistor method</p> 	Yes	Yes	<p>The varistor method prevents the imposition of high voltage between the contacts by using the constant voltage characteristic of the varistor. There is time lag between the moment the circuit is opened and the moment the load is reset.</p> <p>If the supply voltage is 24 to 48 V, insert the varistor in parallel with the load. If the supply voltage is 100 to 200 V, insert the varistor between the contacts.</p>	---

# SECTION 1

## Introduction

This section describes the CPM2B's special features and functions, shows the possible system configurations, and outlines the steps required before operation. Read this section first when using the CPM2B for the first time.

Refer to the *CPM1/CPM1A/CPM2A/CPM2C/SRM1(-V2) Programming Manual (W353)* for details on programming.

1-1	CPM2B Features and Functions .....	2
1-1-1	CPM2B Features .....	2
1-1-2	Overview of CPM2B Functions .....	5
1-2	System Configurations .....	6
1-2-1	CPU Boards .....	6
1-2-2	Expansion I/O Boards .....	7
1-2-3	Connecting a Programming Console .....	8
1-2-4	Support Software .....	8
1-2-5	One-to-one Computer Connections .....	9
1-2-6	One-to-N Computer Connections .....	10
1-2-7	OMRON PT Connections .....	11
1-2-8	One-to-one PC Link Connections .....	12
1-3	Structure and Operation .....	13
1-3-1	CPU Board Structure .....	13
1-3-2	Operating Modes .....	14
1-3-3	Operating Mode at Startup .....	14
1-3-4	PC Operation at Startup .....	15
1-3-5	Cyclic Operation and Interrupts .....	16

## 1-1 CPM2B Features and Functions

### 1-1-1 CPM2B Features

The CPM2B PCs are compact Board PCs that can be incorporated easily into control equipment. The PCs are equipped with a variety of advanced features including synchronized pulse control, interrupt inputs, high-speed counters, pulse outputs, and a clock function.

- The compact Board design is ideal for incorporation into control equipment.
- The CPU Board itself can handle a wide range of machine control applications, so it is ideal for use as a built-in control unit in control equipment.
- The CPM2B is equipped with a full complement of communications functions to provide communications with personal computers, other OMRON PCs, and OMRON Programmable Terminals. These communications capabilities allow the user to design a low-cost distributed production system.

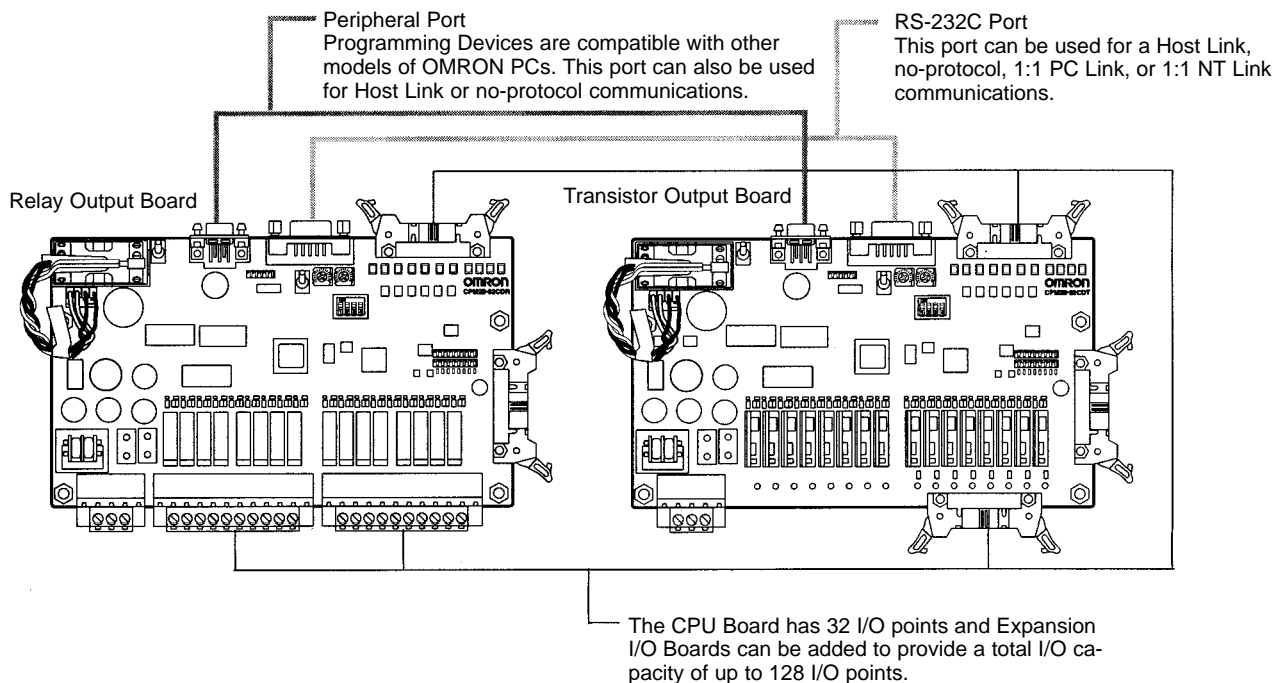

### Basic Functions

#### CPU Board I/O

The CPM2B CPU Board itself is equipped with 32 I/O points in I/O terminals or I/O connectors. There are 2 types of outputs available (relay outputs and sinking transistor outputs). The power supply is 24 V DC only.

#### Expansion I/O Boards

Up to 3 Expansion I/O Boards can be connected to the CPU Board to increase the PC's I/O capacity to a maximum of 128 I/O points. There are 2 types of 32-point Expansion I/O Boards available: one with relay outputs and the other with sinking transistor outputs.

#### Share Programming Devices

The same Programming Devices, such as Programming Consoles and Support Software, can be used for the C200H, C200HS, C200HX/HG/HE, CQM1, CPM1, CPM1A, CPM2A, CPM2C, and SRM1 (-V2) PCs, so existing ladder program resources can be used effectively.

### Built-in Motor Control Capability

#### Synchronized Pulse Control (Transistor Outputs Only)

Synchronized pulse control provides an easy way to synchronize the operation of a peripheral piece of equipment with the main equipment. The output pulse frequency can be controlled as some multiple of the input pulse frequency, al-

lowing the speed of a peripheral piece of equipment (such as a supply conveyor) to be synchronized with the speed of the main piece of equipment.

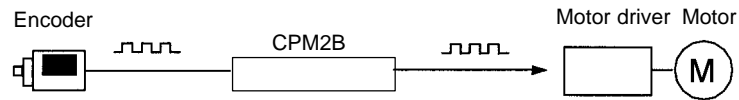

Pulses are output as a fixed multiple of the input frequency.

### High-speed Counters and Interrupts

The CPM2B has a total of five high-speed counter inputs. The one high-speed counter input has a response frequency of 20 kHz/5 kHz and the four interrupt inputs in counter mode have a response frequency of 2 kHz.

The high-speed counter can be used in any one of the four input modes: differential phase mode (5 kHz), pulse plus direction input mode (20 kHz), up/down pulse mode (20 kHz), or increment mode (20 kHz). Interrupts can be triggered when the count matches a set value or falls within a specified range.

The interrupt inputs in counter mode can be used for incrementing counters or decrementing counters (2 kHz) and trigger an interrupt (executing the interrupt program) when the count matches the target value.

### Easy Position Control with Pulse Outputs (Transistor Outputs Only)

CPM2B PCs with transistor outputs have two outputs that can produce 10 Hz to 10 kHz pulses (single-phase outputs).

When used as single-phase pulse outputs, there can be two outputs with a frequency range of 10 Hz to 10 kHz with a fixed duty ratio or 0.1 to 999.9 Hz with a variable duty ratio (0 to 100% duty ratio).

When used as pulse plus direction or up/down pulse outputs, there can be just one output with a frequency range of 10 Hz to 10 kHz.

## High-speed Input Capabilities for Machine Control

### High-speed Interrupt Input Function

There are four inputs used for interrupt inputs (shared with quick-response inputs and interrupt inputs in counter mode) with a minimum input signal width of 50  $\mu$ s and response time of 0.3 ms. When an interrupt input goes ON, the main program is stopped and the interrupt program is executed.

### Quick-response Input Function

There are four inputs used for quick-response inputs (shared with interrupt inputs and interrupt inputs in counter mode) that can reliably read input signals with a signal width as short as 50  $\mu$ s.

### Stabilizing Input Filter Function

The input time constant for all inputs can be set to 1 ms, 2 ms, 3 ms, 5 ms, 10 ms, 20 ms, 40 ms, or 80 ms. The effects of chattering and external noise can be reduced by increasing the input time constant.

## Other Functions

### Interval Timer Interrupts

The interval timer can be set between 0.5 and 319,968 ms and can be set to generate just one interrupt (one-shot mode) or periodic interrupts (scheduled interrupt mode).

### Analog Settings

There are two controls on the CPU Board that can be turned to change the analog settings (0 to 200 BCD) in IR 250 and IR 251. These controls can be used to easily change or fine-tune machine settings such as a conveyor belt's pause time or feed rate.

### DIP Switch Inputs

A DIP switch is provided that controls the status of four input bits.

### Calendar/Clock

The built-in clock (accuracy within 1 minute/month) can be read from the program to show the current year, month, day, day of the week, and time. The clock can be set from a Programming Device (such as a Programming Console) or the time can be adjusted by rounding up or down to the nearest minute.

### Long-term Timer

TIML(—) is a long-term timer that accommodates set values up to 99,990 seconds (27 hours, 46 minutes, 30 seconds). When combined with the SECONDS



TO HOURS conversion instruction (HMS(—)), the long-term timer provides an easy way to control equipment scheduling.

**Expansion Memory Unit**

The CPM1-EMU01-V1 Expansion Memory Unit is a program loader for small-size or micro PCs. Using the CPM1-EMU01-V1, simple on-site transfer of user programs and data memory is possible with PCs.

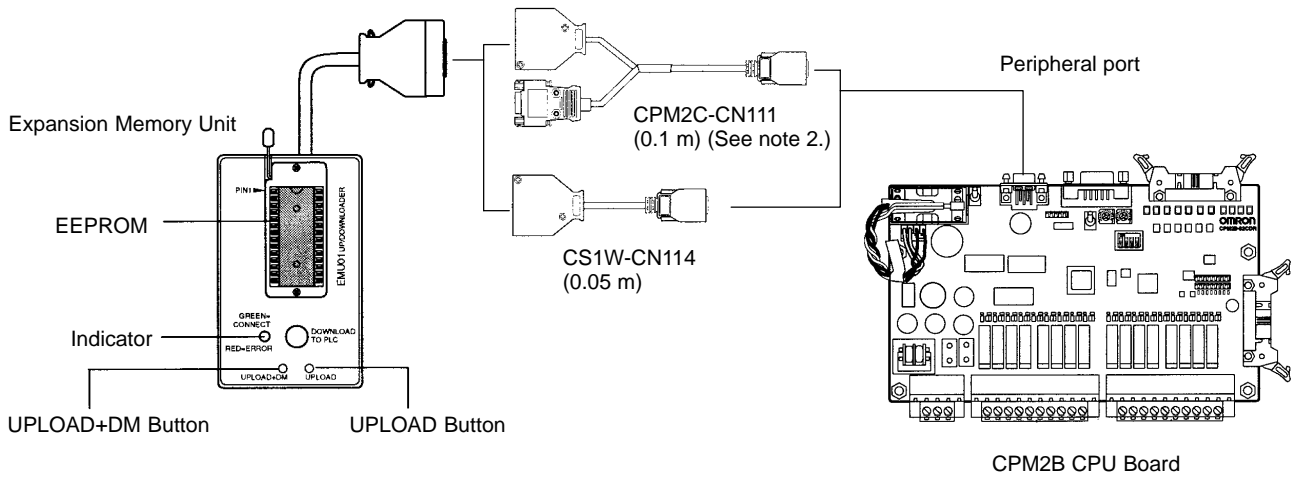

- Note**
1. Refer to the *CPM 2A Operation Manual (W352)* or *CPM2C Operation Manual* for details on the CPM1-EMV01-V1.
  2. The CPM2C-CN111 can be connected only to the peripheral port.

**Complete Communications Capabilities**

**Host Link**

A Host Link connection can be made through the PC's RS-232C port or Peripheral port. A personal computer or Programmable Terminal connected in Host Link mode can be used for operations such as reading/writing data in the PC's I/O memory or reading/changing the PC's operating mode.

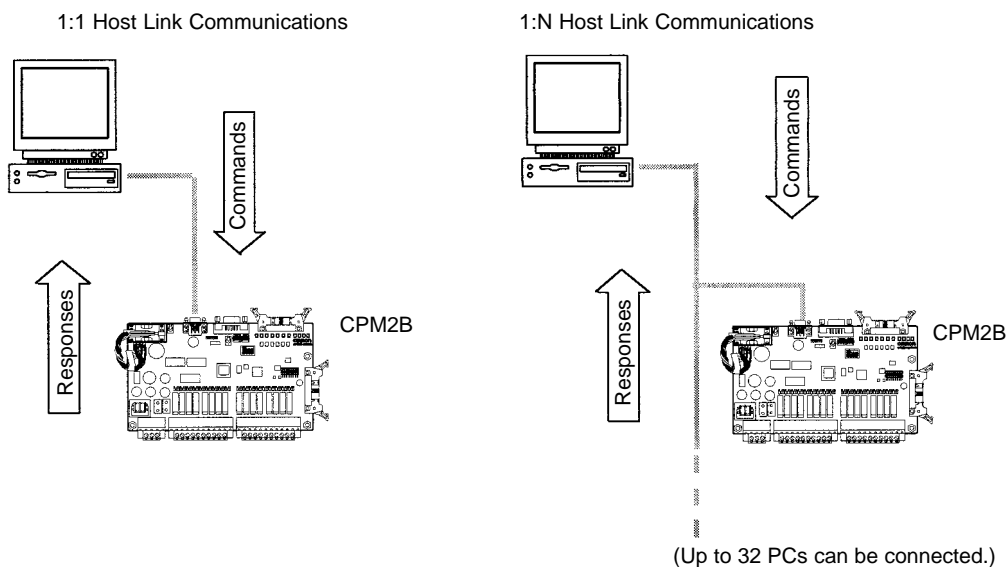

**No-protocol Communications**

The TXD(48) and RXD(47) instructions can be used in no-protocol mode to exchange data with standard serial devices. For example, data can be received

from a bar code reader or transmitted to a serial printer. The serial devices can be connected to the RS-232C port or Peripheral port.

Inputting data from a bar code reader

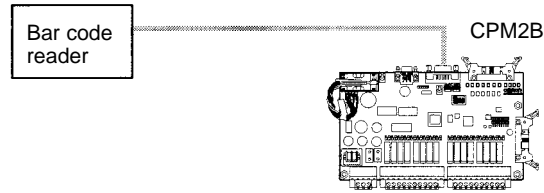

Outputting data to a serial printer

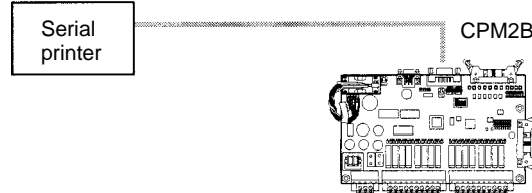

**High-speed 1:1 NT Link Communications**

In a 1:1 NT Link, an OMRON Programmable Terminal (PT) can be connected directly to the CPM2B. The PT must be connected to the RS-232C port; it cannot be connected to the Peripheral port.

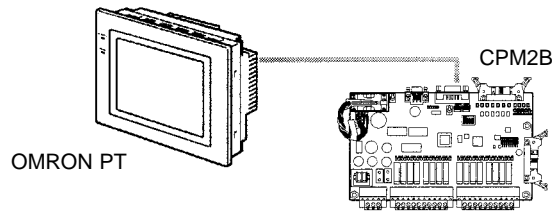

**One-to-one PC Link**

A CPM2B can be linked directly to another CPM2B, CQM1, CPM1, CPM1A, CPM2A, CPM2C, SRM1(-V2), C200HS or C200HX/HG/HE PC. The 1:1 PC Link allows automatic data link connections. The PCs must be connected through the RS-232C ports; they cannot be connected through the Peripheral ports.

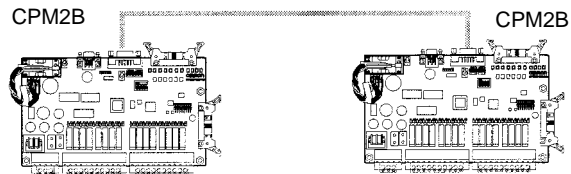

**1-1-2 Overview of CPM2B Functions**

Main function	Variations/Details	
Interrupts	Interrupt inputs 4 inputs, see note 1. Response time: 50 μs	
	Interval timer interrupts 1 input Set value: 0.5 to 319,968 ms Precision: 0.1 ms	Scheduled interrupts
		One-shot interrupt

Main function	Variations/Details	
High-speed counters	High-speed counter 1 input, see note 2.  Differential phase mode (5 kHz) Pulse plus direction input mode (20 kHz) Up/down input mode (20 kHz) Increment mode (20 kHz)	No interrupt  Count-check interrupt  (An interrupt can be generated when the count equals the set value or the count lies within a preset range.)
	Interrupt inputs in counter mode 4 inputs, see note 1.  Incrementing counter (2 kHz) Decrementing counter (2 kHz)	No interrupt  Count-up interrupt
Pulse outputs	2 outputs: Single-phase pulse output without acceleration/deceleration (See note 3.) 10 Hz to 10 kHz  2 outputs: Variable duty ratio pulse output (See note 3.) 0.1 to 999.9 Hz, duty ratio 0 to 100%  1 output: Pulse output with trapezoidal acceleration/deceleration (See note 3.) Pulse plus direction output, up/down pulse output, 10 Hz to 10 kHz	
Synchronized pulse control	1 point, see notes 2 and 3.  Input frequency range: 10 to 500 Hz, 20 Hz to 1 kHz, or 300 Hz to 20 kHz Output frequency range: 10 Hz to 10 kHz	
Quick-response input	4 inputs, see note 1.  Maximum input signal width: 50 μs	
Analog settings	2 controls (setting ranges: 0 to 200 BCD)	
Input time constant	Determines the input time constant for all inputs. (Settings: 1, 2, 3, 5, 10, 20, 40, or 80 ms)	
Calendar/Clock	Shows the current year, month, day of the week, day of the month, hour, minute, and second.	
Error log	Records the time of occurrence and error code.	

- Note**
1. These four inputs are shared by interrupt inputs, interrupt inputs in counter mode, and quick-response inputs, but each input can be used for only one purpose.
  2. This input is shared by the high-speed counter and synchronized pulse control functions.
  3. This output is shared by the pulse output and synchronized pulse control functions. These functions can be used with transistor outputs only.

## 1-2 System Configurations

### 1-2-1 CPU Boards

CPU Board with 32 I/O points  
(Relay outputs)

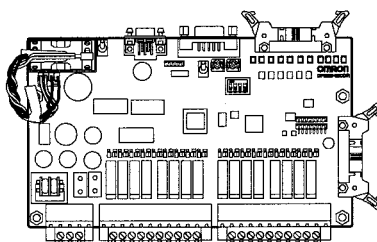

CPU Board with 32 I/O points  
(Transistor outputs)

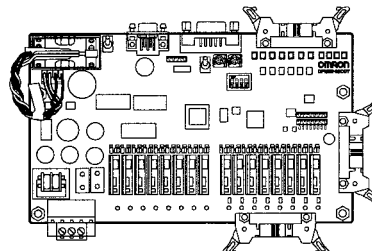

CPU Board	Inputs	Outputs	Battery	Clock	RS-232C port	Model
32 I/O points (16 inputs, 16 outputs)	16 inputs, 24 V DC	16 relay outputs (Terminal-block)	---	---	---	CPM2B-32C1DR-D
			Yes	Yes	Yes	CPM2B-32C2DR-D
	16 inputs, 24 V DC	16 sinking transistor outputs (Connector)	---	---	---	CPM2B-32C1DT-D
			Yes	Yes	Yes	CPM2B-32C2DT-D

### 1-2-2 Expansion I/O Boards

Up to 3 Expansion I/O Boards can be connected to the CPU Board.

Expansion I/O Board with 32 I/O points  
(Relay outputs)

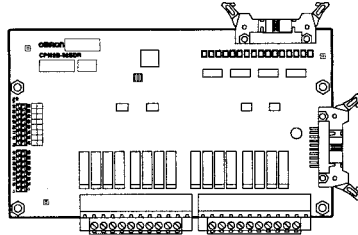

Expansion I/O Board with 32 I/O points  
(Transistor outputs)

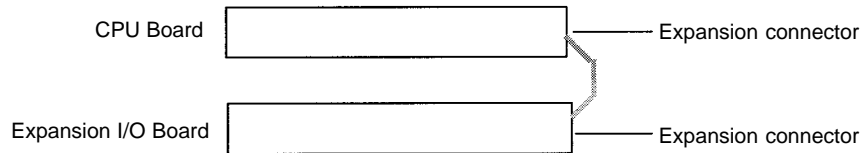
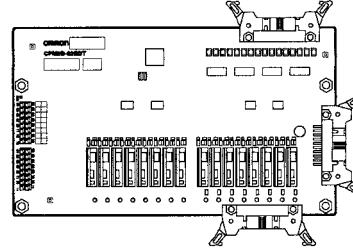

A PC with 128 I/O points (the maximum) can be assembled by connecting three Expansion I/O Boards. The following configuration provides 64 inputs and 64 sinking transistor outputs:

$$\text{CPM2B-32C1DT-D (16 inputs, 16 outputs)} \times 1 \text{ Board} + \text{CPM2B-32EDT (16 inputs, 16 outputs)} \times 3 \text{ Boards} = 64 \text{ inputs, 64 outputs}$$

#### Expansion I/O Boards

Expansion I/O Board	Inputs	Outputs	Model
32 I/O points (16 inputs, 16 outputs)	16 inputs, 24 V DC	16 relay outputs (Terminal-block)	CPM2B-32EDR
	16 inputs, 24 V DC	16 sinking transistor outputs (Connector)	CPM2B-32EDT

**Note** When an NT-AL001-E Adapter is connected to the RS-232C port, only one Expansion I/O Board can be connected because of power supply limitations.

### 1-2-3 Connecting a Programming Console

A Programming Console can be connected to the CPM2B CPU Board's peripheral port, as shown below.

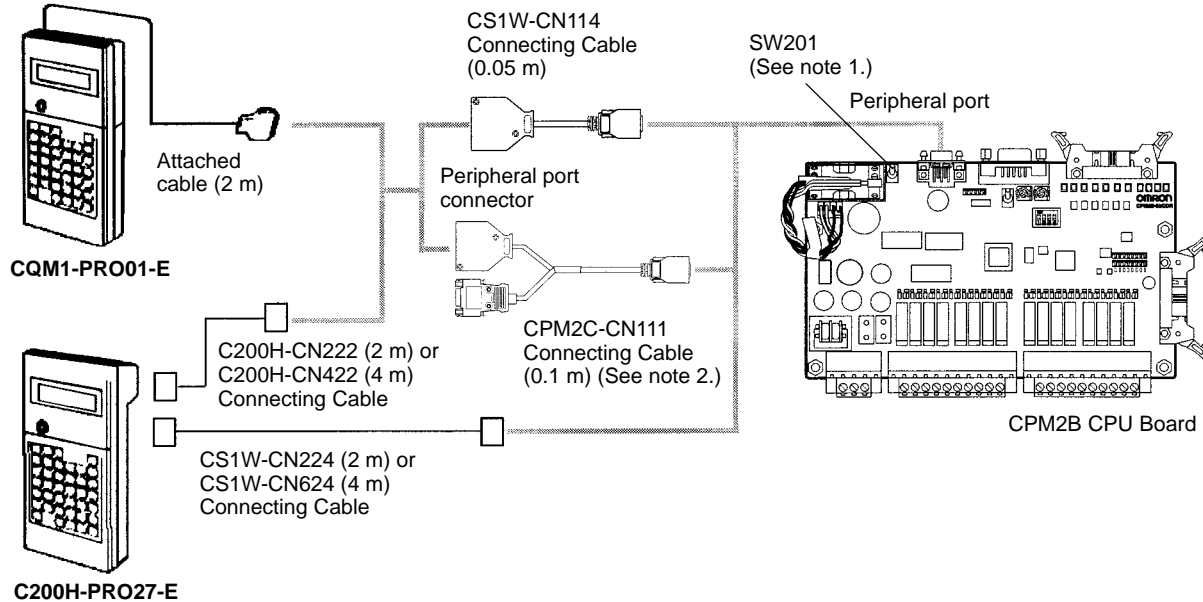

- Note**
1. Always turn OFF SW 201 before connecting the Programming Console.
  2. Only the peripheral port connector can be used when a CPM2C-CN111 Connecting Cable is connected.

### 1-2-4 Support Software

A personal computer running the CX-Programmer or SYSMAC-CPT Support Software (in MS Windows) or the SSS (in MS-DOS) can be connected to the CPU Board's Peripheral port or RS-232C port. Refer to 1-2-5 One-to-one Computer Connections for details on the computer connection.

Always turn ON Communications Switch SW201 when using Support Software instead of a Programming Console. The setting on Communications Switch SW202 determines whether the communications settings in the PC Setup or the standard settings will be used, as shown in the following table.

SW202 setting	Communications settings	
	Peripheral port	RS-232C port
ON	Standard settings (The standard settings and PC Setup default settings are Host Link communications at 9,600 bps with 1 start bit, 7-bit data, 2 stop bits, and even parity.)	
OFF	PC Setup settings in DM 6650 and DM 6651	PC Setup settings in DM 6645 and DM 6646

When using the SSS, set the PC Model to "CQM1." When using the SYSMAC-CPT, set the PC Model to "CQM1" with the "CPU43" CPU version.

## 1-2-5 One-to-one Computer Connections

Use one of the connecting cables shown in the following diagram to connect a personal computer with Support Software to the CPM2B for a 1:1 Host Link communications or no-protocol (serial) communications.

### RS-232C Port Connection

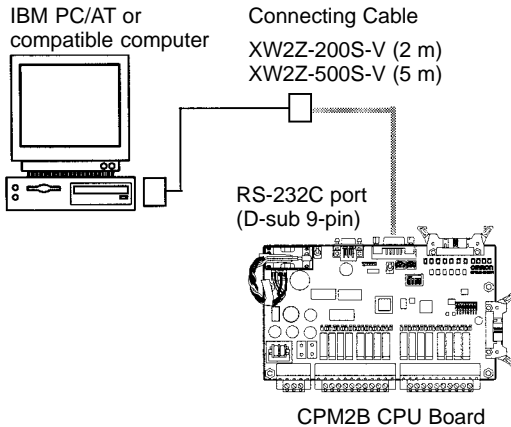

### Peripheral Port Connection

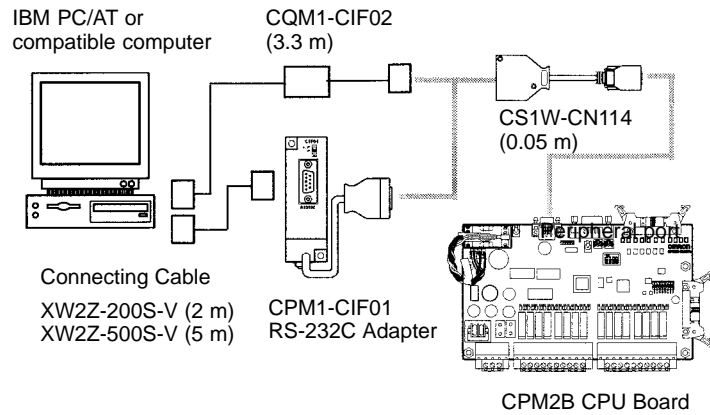

- Note**
1. The CQM1-CIF11 Connecting Cable cannot be used. (If one is connected, the CPM2C will not recognize it; the PC will enter RUN mode at startup if Communications Switch SW201 is ON and DM 6600 of the PC Setup is set to its default setting so that the Programming Console's mode switch controls the startup mode.)
  2. Refer to *Appendix A Standard Models* for details on the Support Software that can be used with the CPM2B.

## 1-2-6 One-to-N Computer Connections

Up to 32 OMRON PCs, including CPM2B PCs, can be connected to a host computer.

### Using the RS-232C Port

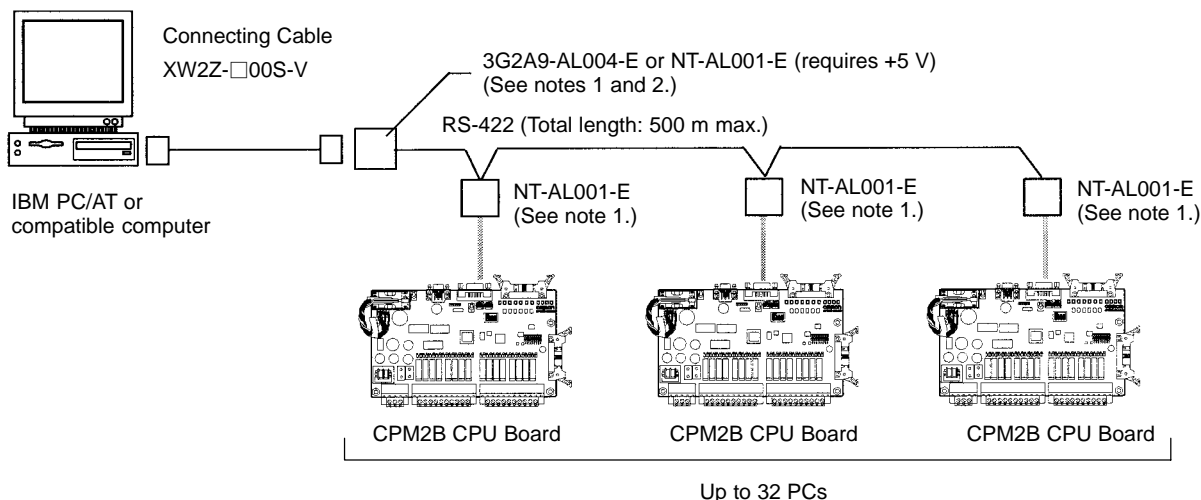

### Using the Peripheral Port

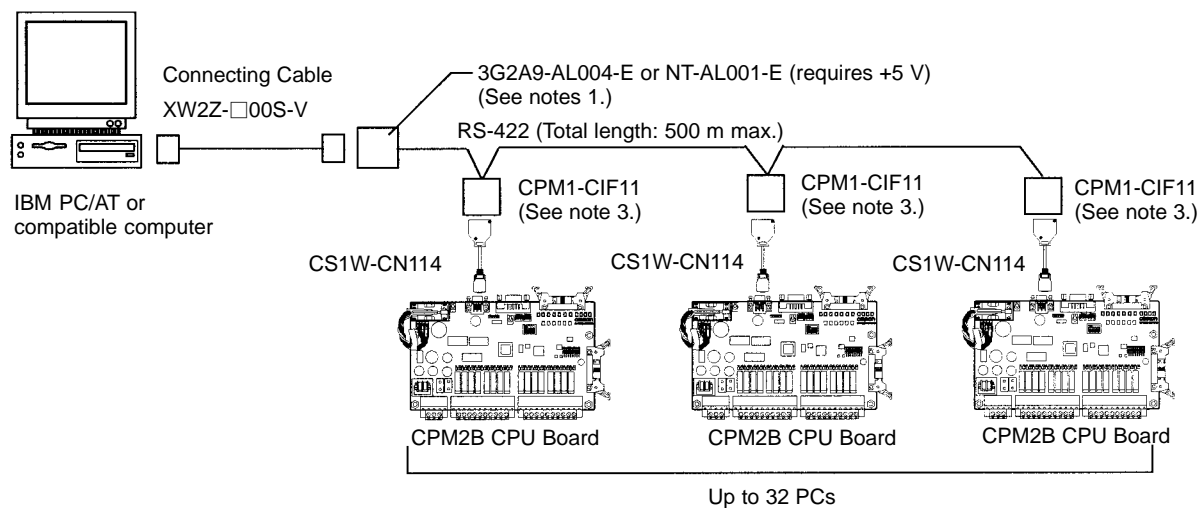

**Note** 1. The NT-AL001-E must be supplied externally with 5 V DC. When an NT-AL001-E is connected to a CPM2B PC, pin 6 of the CPM2B's RS-232C port supplies +5 V DC and an external power supply is not necessary. When the NT-AL001-E is connected to a host computer, it is necessary to supply 5 V DC from an external power supply.

If an NT-AL001-E is connected to the CPM2B's RS-232C port, only one Expansion I/O Board can be connected to the CPU Board because the NT-AL001-E draws its 5-V DC power from the CPU Board.

Use an XW2Z-070T-1 (0.7 m) or XW2Z-200T-1 (2 m) cable to connect the NT-AL001-E to the CPM2B's RS-232C port.

2. The 3G2A9-AL004-E requires an external AC power supply (110 V AC or 220 V AC).
3. The CPM1-CIF11 is supplied +5 V DC from the peripheral port so an external power supply is not necessary.

### 1-2-7 OMRON PT Connections

In a 1:1 NT Link, a CPM2B can be connected directly to a Programmable Terminal through the RS-232C port. (The Programmable Terminal cannot be connected directly to the peripheral port.)

An OMRON PT can also be connected to the CPM2B with a host link connection. Either the RS-232C port or peripheral port can be used for a host link connection.

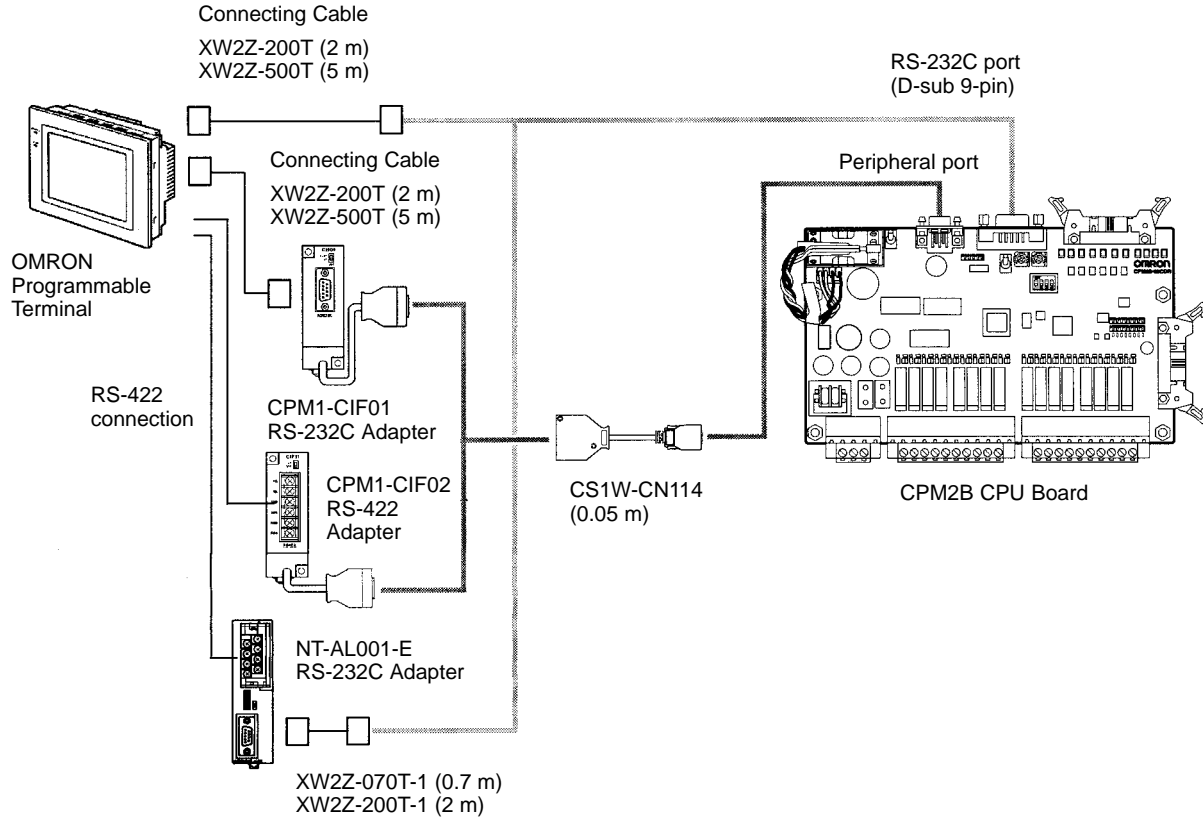

**Note** The Programmable Terminal cannot be connected through the peripheral port for direct access.



### 1-2-8 One-to-one PC Link Connections

A CPM2B can be linked to another CPM2B, a CQM1, CPM1, CPM1A, CPM2A, CPM2C, SRM1 (-V2) or a C200HS or C200HX/HG/HE PC. The PCs must be connected through the RS-232C ports; they cannot be connected through the Peripheral ports.

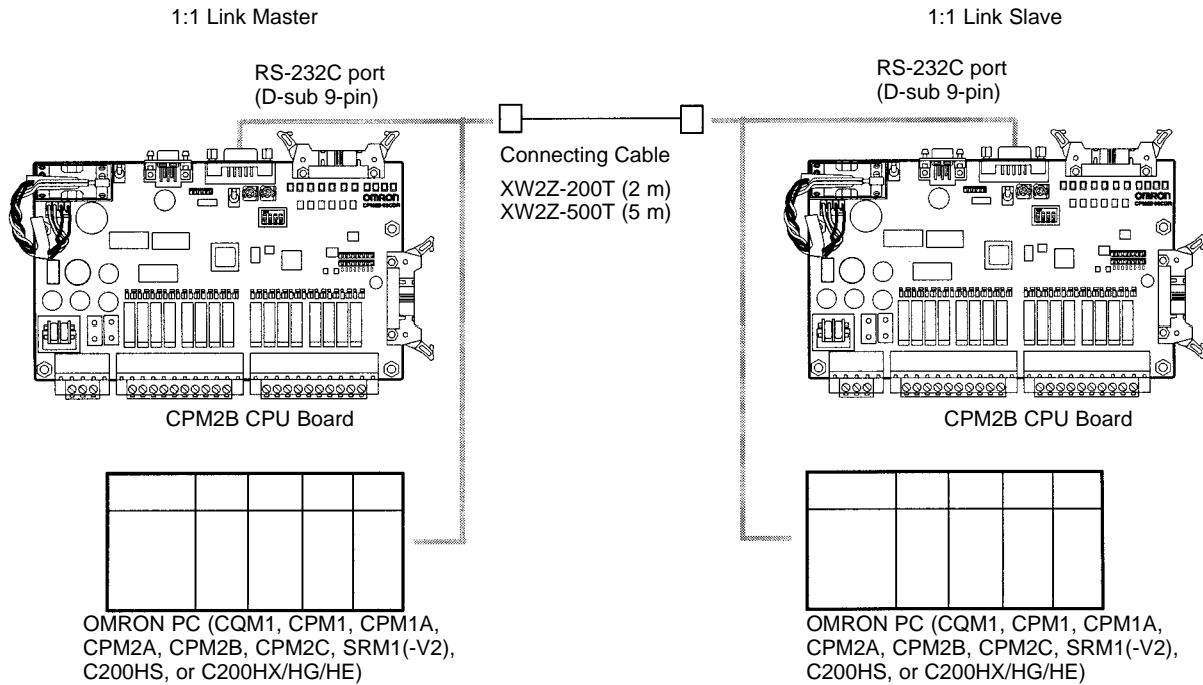

## 1-3 Structure and Operation

### 1-3-1 CPU Board Structure

The following diagram shows the internal structure of the CPU Board.

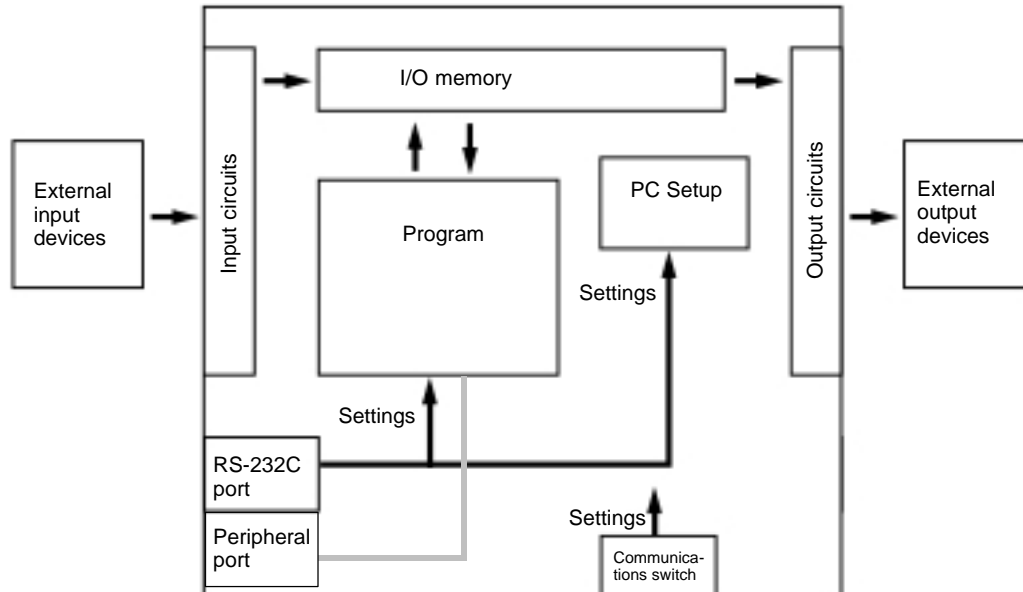

#### I/O Memory

The program reads and writes data in this memory area during execution. Part of the I/O memory contains the bits that reflect the status of the PC's inputs and outputs. Parts of the I/O memory are cleared when the power is turned ON and other parts are retained.

**Note** Refer to *Section 4 Memory Areas* for more details on I/O memory.

#### Program

This is the program written by the user. The CPM2B executes the program cyclically. (Refer to *1-3-5 Cyclic Operation* and *Interrupts* for details.)

The program can be divided broadly into two parts: the "main program" that is executed cyclically and the "interrupt programs" that are executed only when the corresponding interrupt is generated.

#### PC Setup

The PC Setup contains various startup and operating parameters. The PC Setup parameters can be changed from a Programming Device only; they cannot be changed from the program.

Some parameters are accessed only when PC's power supply is turned on and others are accessed regularly while the power is on. It will be necessary to turn the power off and then on again to enable a new setting if the parameter is accessed only when the power is turned on.

**Note** Refer to *4-5 PC Setup* for more details.

#### Communications Switches

The Communications Switches determine whether the peripheral port and RS-232C port operate with the standard communications settings or the communications settings in the PC Setup. Refer to *2-2 Board Components and their Functions* for more details.

### 1-3-2 Operating Modes

CPM2B CPU Boards have 3 operating modes: PROGRAM, MONITOR, and RUN.

#### PROGRAM Mode

The program cannot be executed in PROGRAM mode. This mode is used to perform the following operations in preparation for program execution

- Changing initial/operating parameters such as those in the PC Setup
- Writing, transferring, or checking the program
- Checking wiring by force-setting and force-resetting I/O bits



**Caution**

The PC continues to refresh I/O bits even if the PC is in PROGRAM mode, so devices connected to output points on the CPU Board or Expansion I/O Boards may operate unexpectedly if the corresponding output bit is turned ON by changing the contents of I/O memory from a Programming Device.

#### MONITOR Mode

The program is executed in MONITOR mode and the following operations can be performed from a Programming Device. In general, MONITOR mode is used to debug the program, test operation, and make adjustments.

- Online editing
- Monitoring I/O memory during operation
- Force-setting/force-resetting I/O bits, changing set values, and changing present values during operation

#### RUN Mode

The program is executed at normal speed in RUN mode. Operations such as online editing, force-setting/force-resetting I/O bits, and changing set values/present values cannot be performed in RUN mode, but the status of I/O bits can be monitored.

### 1-3-3 Operating Mode at Startup

The operating mode of the CPM2B when the power is turned ON depends upon the PC Setup settings and the Programming Console's mode switch setting if a Programming Console is connected.

PC Setup setting			Operating mode
Word	Bits	Setting	
DM 6600	08 to 15	00	See note.
		01	Startup mode is the same as the operating mode before power was interrupted.
		02	Startup mode is determined by bits 00 to 07.
	00 to 07	00	PROGRAM mode
		01	MONITOR mode
		02	RUN mode

**Note** The startup mode depends upon the setting of Communications Switch SW201 and the Programming Device connected to the peripheral port.

Programming Device	SW201 OFF	SW201 ON
None	PROGRAM mode	RUN mode (see note 2)
Programming Console	Operating mode set on the Programming Console's mode switch	PROGRAM mode (see note 1)
Other device	PROGRAM mode (see note 1)	PROGRAM mode

- Note**
1. The CPM2B will not be able to communicate with the Programming Device in these cases.
  2. The default setting of bits 08 to 15 of DM 6600 is 00. With this default setting, the PC will automatically enter RUN mode if a Programming Console is not connected and SW201 is ON. Be sure that it is safe for the PC to operate before turning it ON under these conditions.

## 1-3-4 PC Operation at Startup

### Time Required for Initialization

The time required for startup initialization depends on several factors, such as the operating conditions (including power supply voltage, system configuration, and ambient temperature) and the program contents.

### Power OFF Operation

#### **Minimum Power Supply Voltage**

The PC will stop and all outputs will be turned OFF if the power supply voltage falls below 85% of the rated value.

#### **Momentary Power Interruption**

A power interruption will not be detected and CPU Board operation will continue if the power interruption lasts less than 2 ms for a DC power supply.

A power interruption may or may not be detected for power interruptions somewhat longer than 2 ms for a DC power supply.

When a power interruption is detected, the CPU Board will stop operating and all outputs will be turned OFF.

#### **Automatic Reset**

Operation will restart automatically when the power supply voltage is restored to more than 85% of the rated voltage.

#### **Timing Chart of Power OFF Operation**

The power interruption detection time is the time required for a power interruption to be detected after the power supply voltage drops below 85% of the rated value.

- 1, 2, 3...
1. Minimum power interruption detection time  
Power interruptions that are shorter than 2 ms will not be detected.
  2. Undetermined additional time  
Power interruptions only slightly longer than the minimum power interruption time may not be detected.

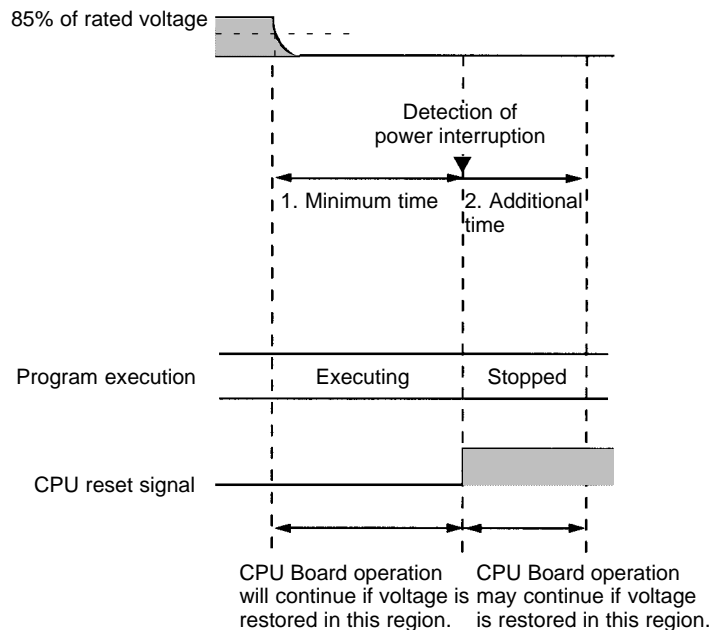

**Note** If the power supply voltage fluctuates around 85% of the PC's rated voltage, PC operation may stop and restart repeatedly. When repeated stopping and starting will cause problems with the controlled system, set up a protective circuit such as a circuit that shuts off the power supply to sensitive equipment until the power supply voltage returns to the rated value.

### 1-3-5 Cyclic Operation and Interrupts

#### Basic CPU Operation

Initialization processing is performed when the power is turned on. If there are no initialization errors, the overseeing processes, program execution, I/O refreshing, and communications port servicing are performed repeatedly (cyclically).

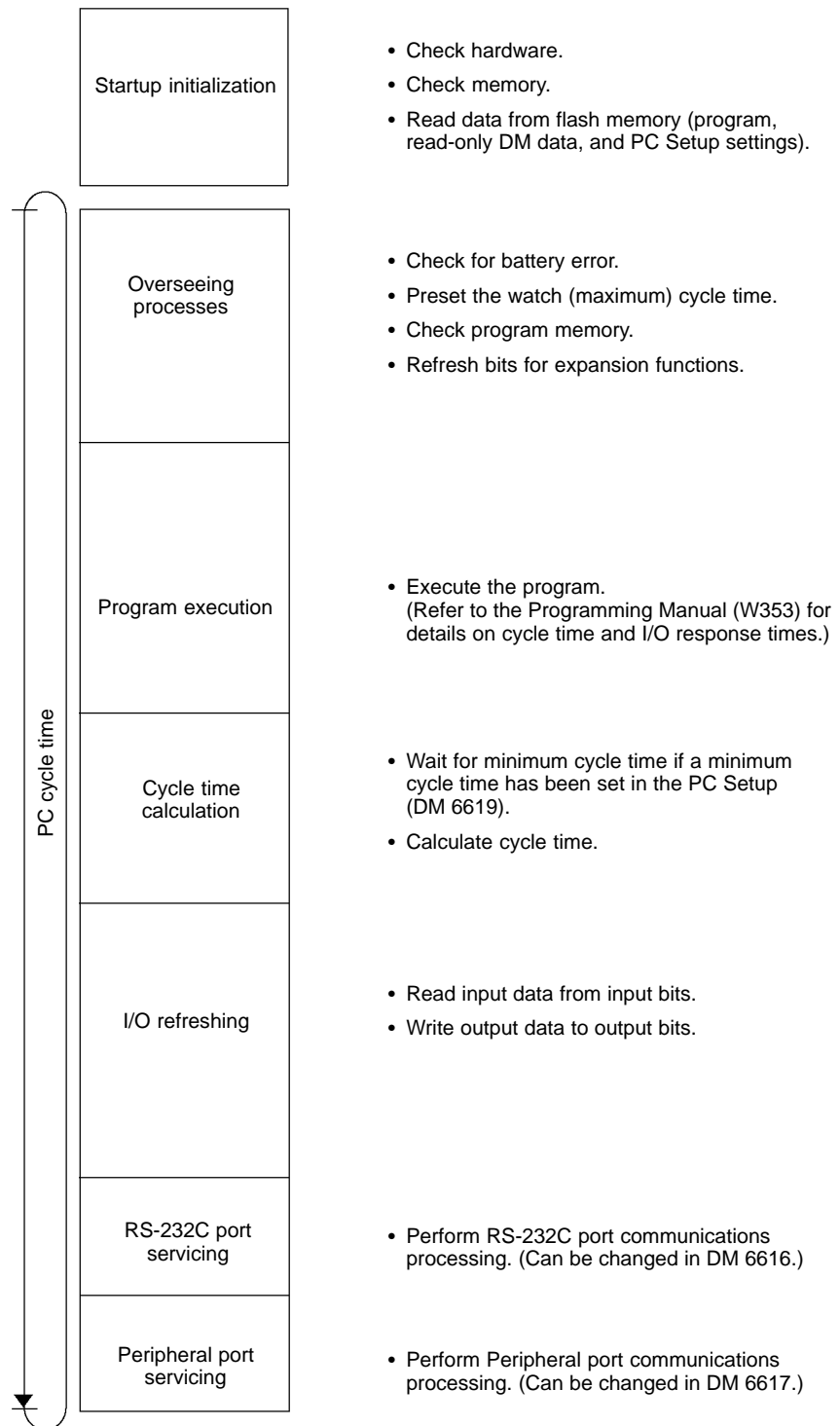

The cycle time can be read from a Programming Device.

AR 14 contains the maximum cycle time and AR 15 contains the present cycle time in 4-digit BCD.

**Program Execution in Cyclic Operation**

The cycle time will vary slightly depending on the processing being performed in each cycle, so the calculated cycle time will not always match the actual cycle time.

The following diagram shows the cyclic operation of the CPM2B when the program is being executed normally.

Normally, the results of program execution are transferred to I/O memory just after program execution (during I/O refreshing), but IORF(97) can be used to refresh a specified range of I/O words during program execution. The specified range of I/O words will be refreshed when IORF(97) is executed.

The cycle time is the sum of the time required for program execution, I/O refreshing, and communications port servicing.

A minimum cycle time (1 to 9,999 ms) can be set in the PC Setup (DM 6619). When a minimum cycle time has been set, CPU operation is paused after program execution until the minimum cycle time is reached. CPU operation will not be paused if the actual cycle time is longer than the minimum cycle time set in DM 6619.

**Note** A fatal error will occur and PC operation will stop if a maximum cycle time has been set in the PC Setup (DM 6618) and the actual cycle time exceeds that setting.

The default settings for RS-232C port servicing and Peripheral port servicing are 5% of the cycle time, but these settings can be changed (between 1% and 99%) in the PC Setup. The RS-232C port's setting is in DM 6616 and the Peripheral port's setting is in DM 6617.

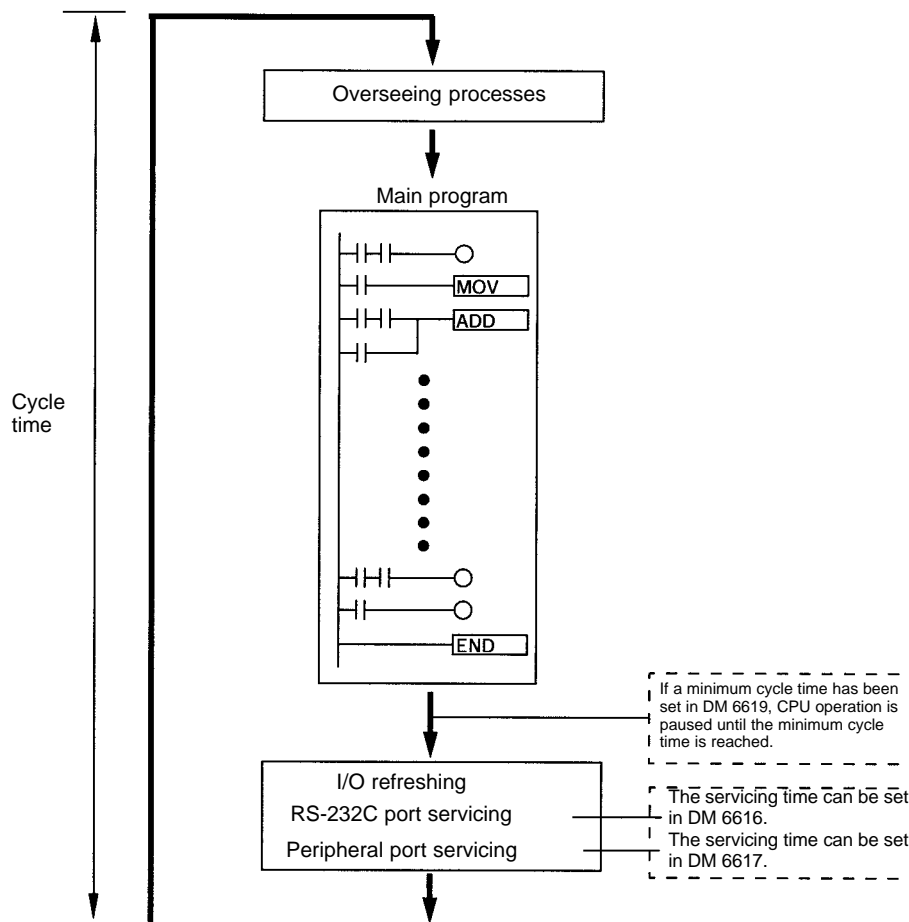

**Interrupt Program Execution**

When an interrupt is generated during execution of the main program, main program execution is interrupted immediately and the interrupt program is executed. The following diagram shows the cyclic operation of the CPM2B when an interrupt program is executed.

Normally, the results of interrupt program execution are transferred to I/O memory just after program execution (during I/O refreshing), but IORF(97) can be used to refresh a specified range of I/O words during execution of the interrupt program. The specified range of I/O words will be refreshed when IORF(97) is executed.

The normal cycle time is extended by the time required for execution of the interrupt program.

Refer to *Section 7 PC Operations and Processing Time in the CPM1/CPM1A/CPM2A/CPM2C/SRM1(-V2) Programmable Controllers Programming Manual (W353)* for more details and precautions on the cycle time.

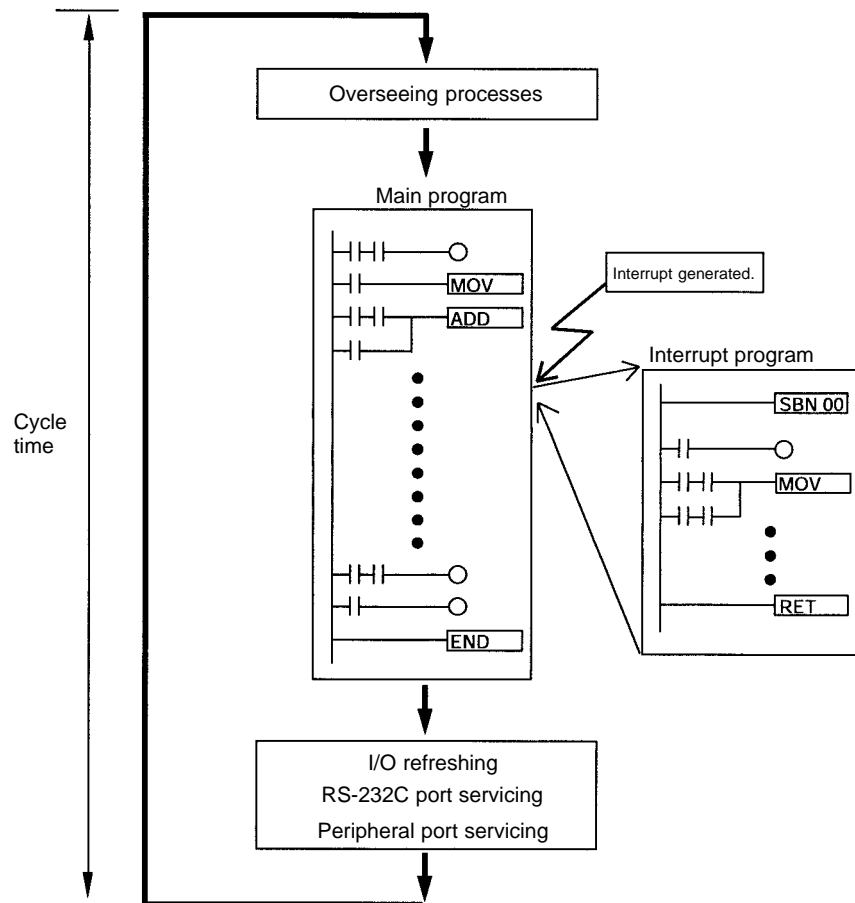

**Caution** Although IORF(97) can be used in interrupt subroutines, you must be careful of the interval between IORF(97) executions. If IORF(97) is executed too frequently, a fatal system error may occur (FALS 9F), stopping operation. The interval between executions of IORF(97) should be at least 1.3 ms + total execution time of the interrupt subroutine.

**Immediate Refreshing**

IORF(97) can be executed in the program to refresh a specified range of I/O words. The specified I/O words will be refreshed when IORF(97) is executed. IORF(97) can be used to refresh I/O from the main program or the interrupt program.

When IORF(97) is used, the cycle time is extended by the time required to refresh the specified I/O words.

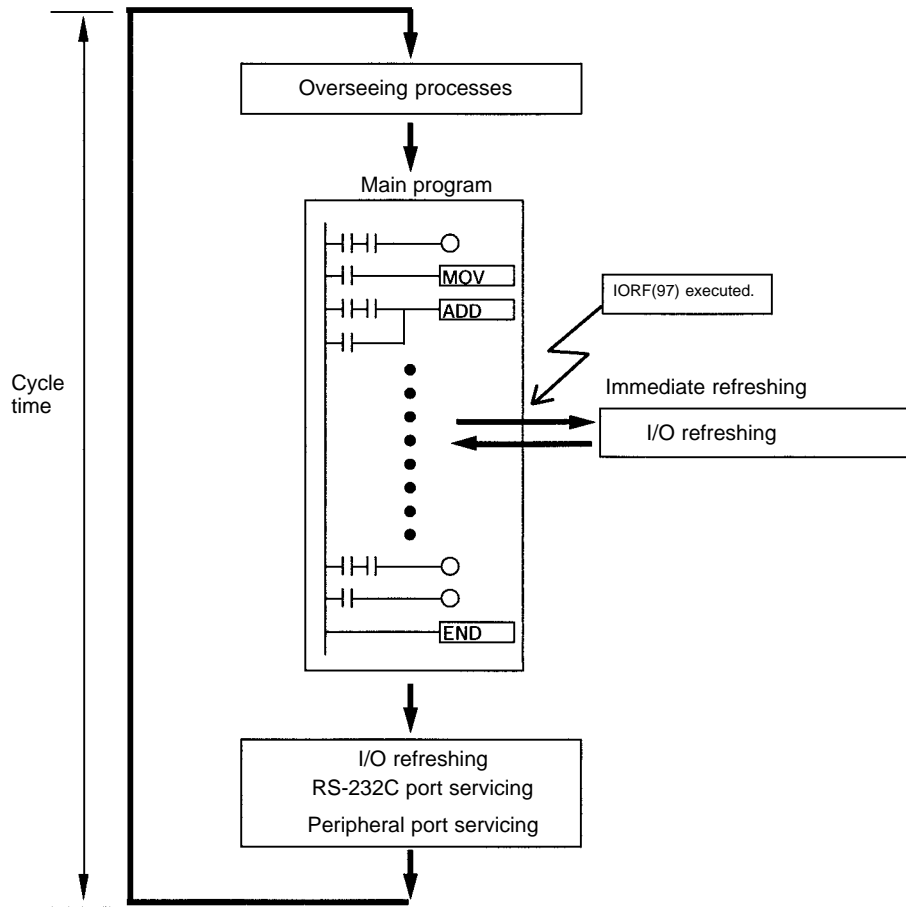



# SECTION 2

## Board Specifications and Components

This section provides the technical specifications of the CPM2B Boards and describes the main components of the Boards.

- 2-1 Specifications ..... 22
  - 2-1-1 General Specifications ..... 22
  - 2-1-2 Characteristics ..... 23
  - 2-1-3 I/O Specifications ..... 25
- 2-2 Board Components and their Functions ..... 29
  - 2-2-1 CPU Board Components ..... 29
  - 2-2-2 Expansion I/O Boards ..... 32
- 2-3 I/O Connector and Terminal Pin Allocation ..... 33

## 2-1 Specifications

### 2-1-1 General Specifications

Item	CPU Boards		Expansion I/O Boards	
	With relay outputs	With transistor outputs	With relay outputs	With transistor outputs
Supply voltage	24 V DC (Allowable range: 20.4 to 26.4 V DC)		Supplied from CPU Board.	
Power consumption	20 W max.		---	
Inrush current	20 A max.		---	
Insulation resistance	20 M $\Omega$ min. (at 500 V DC) between the external DC terminals and non-current carrying metal parts			
Dielectric strength	1,000 V AC 50/60 Hz for 1 min between the external DC terminals and non-current carrying metal parts			
Noise immunity	Conforms to IEC6100-4-4; 2 kV (power lines)			
Vibration resistance	10 to 57 Hz, 0.075-mm amplitude, 57 to 150 Hz, acceleration: 9.8 m/s <sup>2</sup> in X, Y, and Z directions for 80 minutes each (8 minutes of vibration $\times$ 10 repetitions= total time 80 minutes)			
Shock resistance	147 m/s <sup>2</sup> three times each in X, Y, and Z directions			
Ambient temperature	Operating: 0 to 55°C Storage: -25 to 70°C (excluding the battery)			
Ambient humidity	Operating: 10% to 90% (with no condensation)			
Ambient atmosphere	Operating: Must be free from corrosive gas			
I/O configuration	Inputs: Connector Outputs: Terminal block	Inputs: Connector Outputs: Connector	Inputs: Connector Outputs: Terminal block	Inputs: Connector Outputs: Connector
Power supply retention time	2 ms min.			
Weight	300 g max.		300 g max.	

## 2-1-2 Characteristics

Item		CPU Boards	
		With relay outputs	With transistor outputs
Control method		Stored program method	
I/O control method		Cyclic scan with direct output (Immediate refreshing can be performed with IORF(97).)	
Programming language		Ladder diagram	
Instruction length		1 step per instruction, 1 to 5 words per instruction	
Instructions	Basic instructions	14	
	Special instructions	105 instructions, 185 variations	
Execution time	Basic instructions	0.64 $\mu$ s (LD instruction)	
	Special instructions	7.8 $\mu$ s (MOV instruction)	
Program capacity		4,096 words	
Max. I/O capacity	CPU Board only	32 points	
	With Expansion I/O Boards	128 points max.	
Input bits		IR 00000 to IR 00915 (Words not used for input bits can be used for work bits.)	
Output bits		IR 01000 to IR 01915 (Words not used for output bits can be used for work bits.)	
Work bits		928 bits: IR 02000 to IR 04915 and IR 20000 to IR 22715	
Special bits (SR area)		448 bits: SR 22800 to SR 25515	
Temporary bits (TR area)		8 bits (TR0 to TR7)	
Holding bits (HR area)		320 bits: HR 0000 to HR 1915 (Words HR 00 to HR 19)	
Auxiliary bits (AR area)		384 bits: AR 0000 to AR 2315 (Words AR 00 to AR 23)	
Link bits (LR area)		256 bits: LR 0000 to LR 1515 (Words LR 00 to LR 15)	
Timers/Counters		256 timers/counters (TIM/CNT 000 to TIM/CNT 255)  1-ms timers: TMHH(—) 10-ms timers: TIMH(15) 100-ms timers: TIM 1-s/10-s timers: TIML(—) Decrementing counters: CNT Reversible counters: CNTR(12)	
Data memory	Read/Write	2,048 words (DM 0000 to DM 2047) The Error Log is contained in DM 2000 to DM 2021.	
	Read-only	456 words (DM 6144 to DM 6599)	
	PC Setup	56 words (DM 6600 to DM 6655)	
Interrupt processing	External interrupts	4 (Also used for external interrupt inputs in counter mode and quick-response inputs.)	
	Interval timer interrupts	1 (Scheduled Interrupt Mode or Single Interrupt Mode)	
High-speed counter	High-speed counter	1 (20 kHz single-phase or 5 kHz two-phase (linear count method))	
	Counter interrupt	1 (set value comparison or set-value range comparison)	
	Interrupt Inputs (Counter mode)	4 inputs (Also used for interrupt inputs and quick-response inputs.)	
	Counter interrupts	4 (Also used for the external interrupt inputs and quick-response inputs.)	
Pulse output		2 points with no acceleration/deceleration, 10 Hz to 10 kHz each, and no direction control. 1 point with trapezoidal acceleration/deceleration, 10 Hz to 10 kHz, and direction control. 2 points with variable duty-ratio outputs.  (Pulse outputs can be used with transistor outputs only, they cannot be used with relay outputs.)	

Item	CPU Boards	
	With relay outputs	With transistor outputs
Synchronized pulse control	1 point: A pulse output can be created by combining the high-speed counter with pulse outputs and multiplying the frequency of the input pulses from the high-speed counter by a fixed factor. (This output is possible with transistor outputs only, it cannot be used with relay outputs.)	
Quick-response inputs	4 points (Min. input pulse width: 50 μs max.) (Also used for interrupt inputs and for interrupt inputs in counter mode.)	
Input time constant (ON response time = OFF response time)	Can be set for all input points. (1 ms, 2 ms, 3 ms, 5 ms, 10 ms, 20 ms, 40 ms, or 80 ms)	
Clock function	Shows the year, month, day of the week, day, hour, minute, and second. (Backed up by the battery.) (The clock function is available only in CPU Boards equipped with a clock.)	
Communications functions	Built-in peripheral port: Supports Host Link, peripheral bus, no-protocol, or Programming Console connections. Built-in RS-232C port: Supports Host Link, no-protocol, 1:1 PC Link (Master/Slave), or 1:1 NT Link connections. (RS-232C communications are available only in CPU Boards equipped with an RS-232C port.)	
Memory protection (See notes 1 and 2.)	HR area, AR area, program contents, read/write DM area contents, and counter values maintained during power interruptions.	
Memory backup (See notes 1 and 2.)	Flash memory: Program, read-only DM area, and PC Setup Battery or capacitor backup: The read/write DM area, HR area, AR area, and counter values are backed up by a battery. CPU Boards with clock: Backup is approximately 5 years at 25°C. CPU Boards without clock: Backup is approximately 5 days at 25°C.	
Self-diagnostic functions	CPU error (watchdog timer), I/O bus error, battery error, and memory error	
Program checks	No END instruction, programming errors (checked when operation is started)	

- Note**
1. The DM area, HR area, AR area, and counter values are backed up by the CPU Board's built-in battery or capacitor. If the battery or capacitor is discharged, the contents of these areas will be lost and the data values will revert to the defaults.
  2. The contents of the program area, read-only DM area (DM 6144 to DM 6599), and PC Setup (DM 6600 to DM 6655) are stored in flash memory. The contents of these areas will be read from flash memory the next time the power is turned ON, even if the backup battery or capacitor is discharged.  
  
 When data has been changed in any of these areas, write the new values to flash memory by switching the CPM2B to MONITOR or RUN mode, or by turning the power OFF and then ON again.

### 2-1-3 I/O Specifications

#### CPU Board Input Specifications

Item	Inputs	Specification
Input voltage	All	24 V DC +10%/−15%
Input impedance	IN00000 to IN00001	2.7 kΩ
	IN00002 to IN00006	3.9 kΩ
	IN00007 and up	4.7 kΩ
Input current	IN00000 to IN00001	8 mA typical
	IN00002 to IN00006	6 mA typical
	IN00007 and up	5 mA typical
ON voltage/current	IN00000 to IN00001	17 V DC min., 5 mA
	IN00002 and up	14.4 V DC min., 3 mA
OFF voltage/current	All	5.0 V DC max., 1 mA
ON delay	All	1 to 80 ms max. Default: 10 ms (See note.)
OFF delay	All	1 to 80 ms max. Default: 10 ms (See note.)
Circuit configuration	IN00000 to IN00001	
	IN00002 to IN00006	
	IN00007 and up	

**Note** The input time constant can be set to 1, 2, 3, 5, 10, 20, 40, or 80 ms in the PC Setup. See page 66.

#### Max. Number of Inputs Simultaneously ON

The maximum number of inputs that can be ON simultaneously depends upon the ambient operating temperature and the installation orientation, as shown in the following diagrams.

- 1, 2, 3... 1. Installation orientation: Vertical with edge down  
All inputs can be ON simultaneously with this orientation.

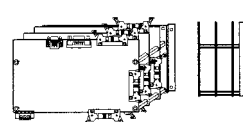

2. Installation orientation: Vertical with end down

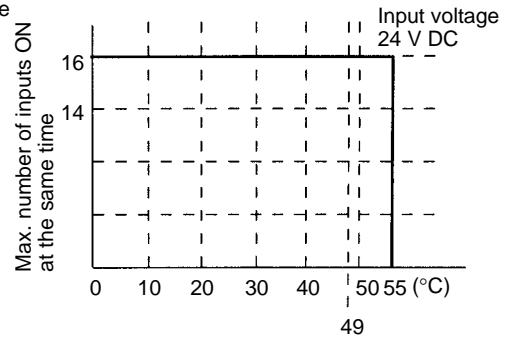
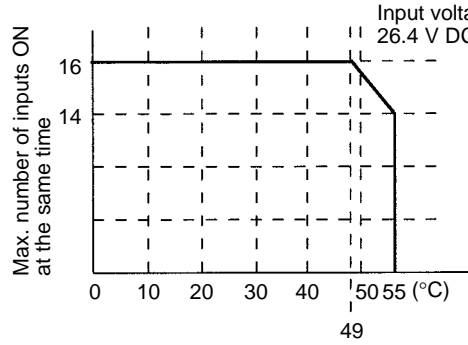
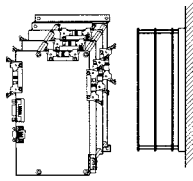

3. Installation orientation: Horizontal

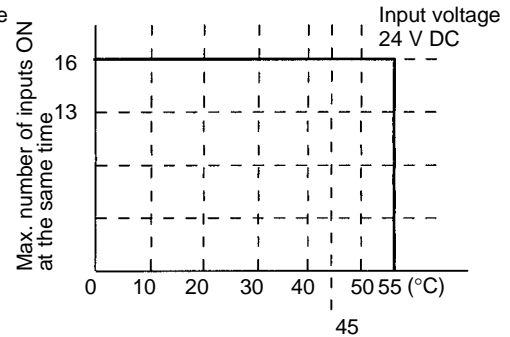
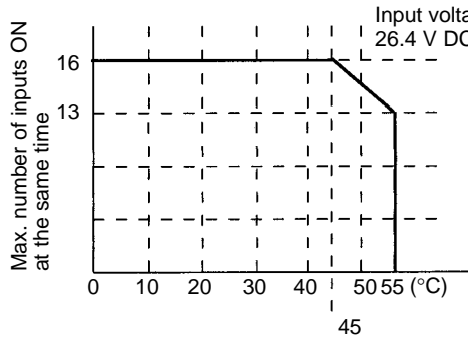
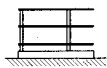

High-speed Counter Inputs

Inputs IN00000 through IN00002 can be used as high-speed counter inputs, as shown in the following table. The maximum count frequency is 5 kHz in differential phase mode and 20 kHz in the other modes.

Input	Function			
	Differential phase mode	Pulse plus direction input mode	Up/down input mode	Increment mode
IN00000	A-phase pulse input	Pulse input	Increment pulse input	Increment pulse input
IN00001	B-phase pulse input	Direction input	Decrement pulse input	Normal input
IN00002	Z-phase pulse input or hardware reset input (IN00002 can be used as a normal input when it is not used as a high-speed counter input.)			

The minimum pulse widths for inputs IN00000 (A-phase input) and IN00001 (B-phase input) are as follows:

Pulse plus direction input mode, Up/down input mode, Increment mode

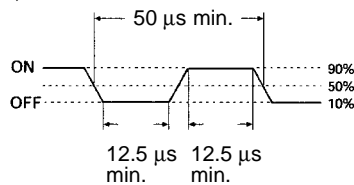

Differential phase mode

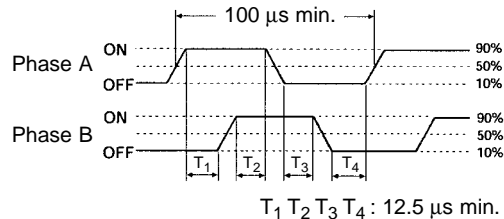

The minimum pulse width for input IN00002 (Z-phase input) is as follows:

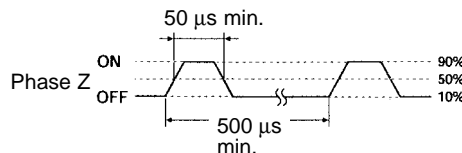

**Interrupt Inputs**

Inputs IN00003 through IN00006 can be used as interrupt inputs (interrupt input mode or counter mode) and quick-response inputs. The minimum pulse width for these inputs is 50  $\mu$ s.

**Expansion I/O Board Input Specifications**

Item	Specification
Input voltage	24 V DC $+10\%/ -15\%$
Input impedance	4.7 k $\Omega$
Input current	5 mA typical
ON voltage	14.4 V DC min.
OFF voltage	5.0 V DC max.
ON delay	1 to 80 ms max. Default: 10 ms (See note.)
OFF delay	1 to 80 ms max. Default: 10 ms (See note.)
Circuit configuration	

**Note** The input time constant can be set to 1, 2, 3, 5, 10, 20, 40, or 80 ms in the PC Setup. See page 66.

**CPU Board and Expansion I/O Board Output Specifications**

**Relay Outputs**

Item	Specification
Max. switching capacity	2 A, 250 V AC ( $\cos\phi = 1$ ) 2 A, 24 V DC (4 A/common)
Min. switching capacity	10 mA, 5 V DC
Service life of relay (See note.)	Electrical: 150,000 operations (24-V DC resistive load) 100,000 operations (240-V AC inductive load, $\cos\phi = 0.4$ ) Mechanical: 20,000,000 operations
ON delay	15 ms max.
OFF delay	15 ms max.
Circuit configuration	

**Note** The service life of the CPM2B's relay output contacts shown in the table assumes the worst conditions. The following graph shows the results of OMRON's service life tests at a switching rate of 1,800 times/hour.

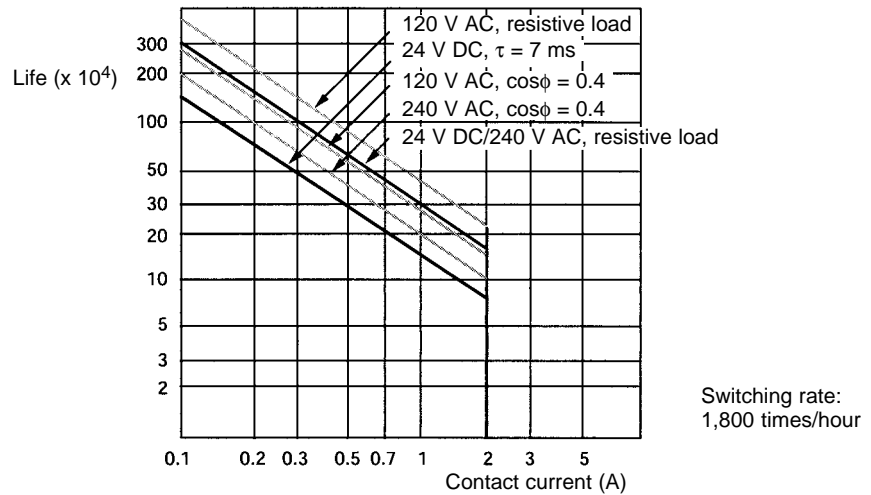

**Transistor Outputs (Sinking or Sourcing)**

Item	Specification
Max. switching capacity	OUT01000 and OUT01001: 4.5 to 30 V DC, 0.2 A/output (See note 1.) OUT01002 and up: 4.5 to 30 V DC, 0.3 A/output (See note 1.)
Leakage current	0.1 mA max.
Residual voltage	1.5 V max.
ON delay	OUT01000 and OUT01001: 20 $\mu$ s max. OUT01002 and up: 0.1 ms max.
OFF delay	OUT01000 and OUT01001: 40 $\mu$ s max. for 4.5 to 26.4 V, 10 to 100 mA 0.1 ms max. for 4.5 to 30 V, 10 to 200 mA OUT01002 and up: 1 ms max. for 4.5 to 30 V, 10 to 300 mA
Fuse	1 fuse/output (cannot be replaced by user)
Circuit configuration	<p><b>Sinking Outputs</b></p>

**Note** When using OUT01000 or OUT01001 for pulse outputs, connect a dummy resistor as required to bring the load current between 0.01 and 0.1 A. If the load current is below 0.01 A, the ON-to-OFF response time will be too long and high-speed pulses will not be output.

**Caution** Do not apply voltage in excess of the maximum switching capacity to an output terminal. It may result in damage to the product or fire.



## 2-2 Board Components and their Functions

### 2-2-1 CPU Board Components

#### CPU Boards with Relay Outputs

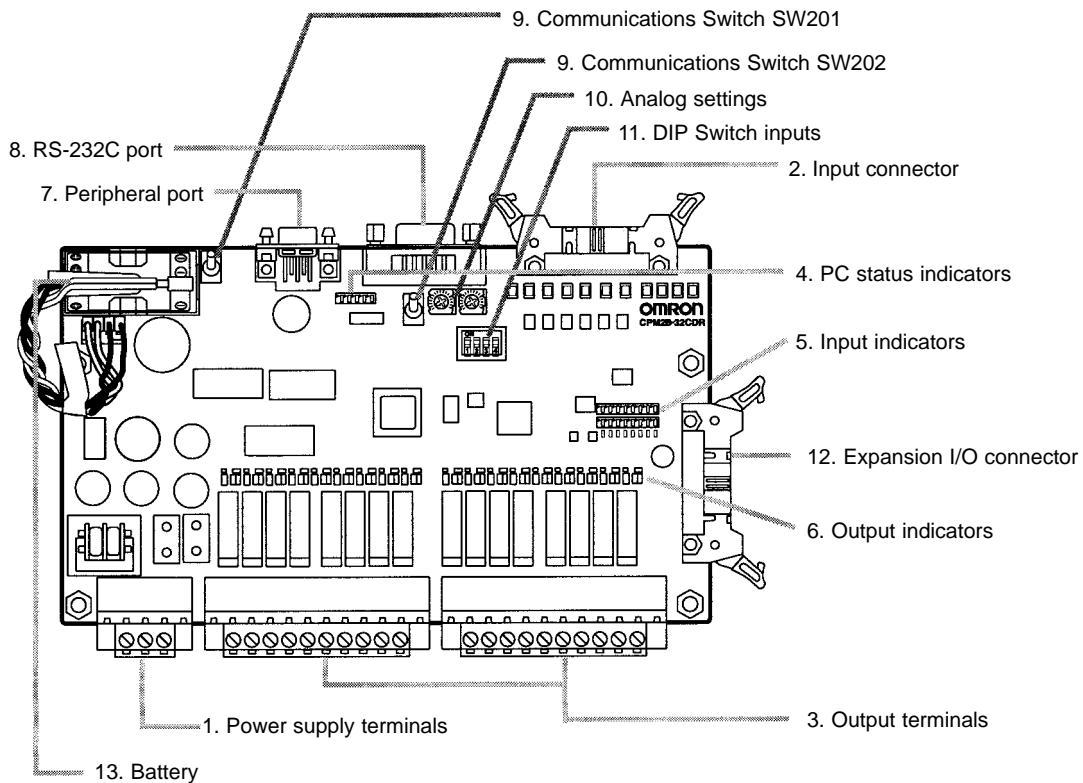

#### CPU Boards with Transistor Outputs

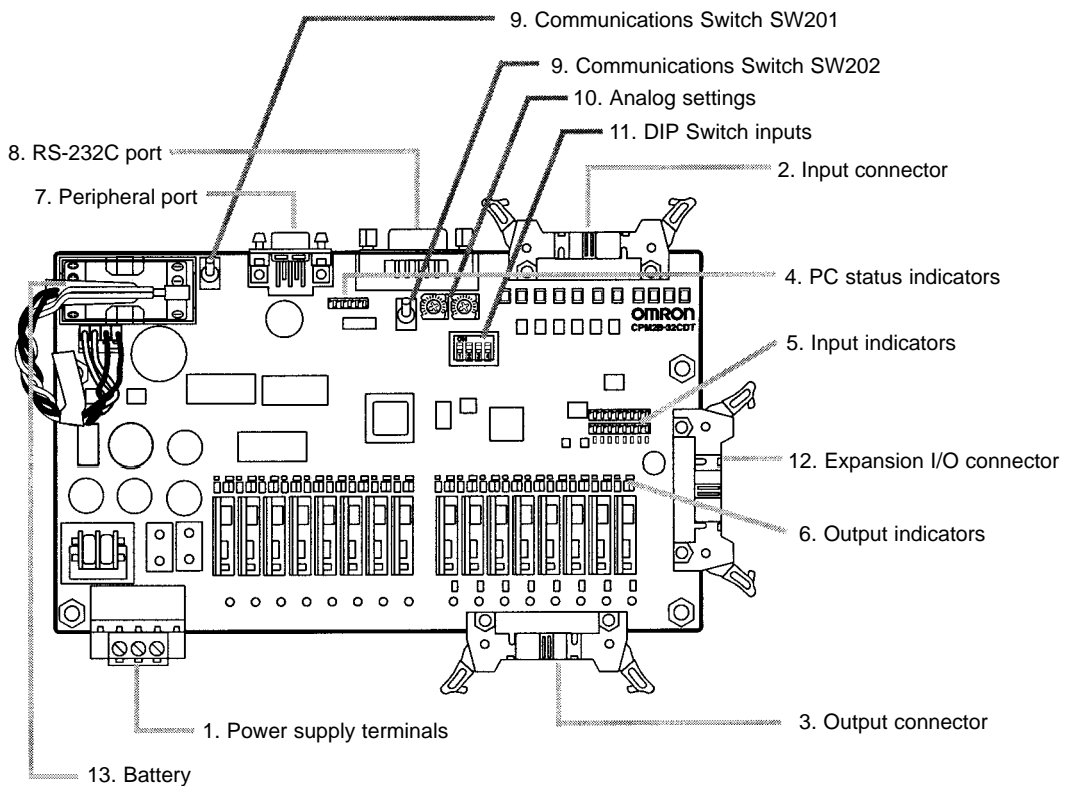

**CPU Board Component Descriptions**

1, 2, 3...

## 1. Power Supply Terminals

Connect the power supply (24 V DC) to these terminals.

## 2. Input Connector

Connects the CPU Board to external input devices.

## 3. Output Terminals/Connector

Connects the CPU Board to external output devices.

## 4. PC Status Indicators

These indicators show the operating status of the PC, as shown in the following table.

Indicator	Status	Meaning
PWR (green)	Lit	Power is being supplied to the PC.
	Not lit	Power isn't being supplied to the PC.
RUN (green)	Lit	The PC is operating in RUN or MONITOR mode.
	Not lit	The PC is in PROGRAM mode or a fatal error has occurred.
ERR (red)	Lit	A fatal error has occurred. (PC operation stops.)
	Flashing	A non-fatal error has occurred. (PC operation continues.)
	Not lit	Indicates normal operation.
PERI (orange)	Flashing	Data is being transferred through the peripheral port.
	Not lit	The peripheral port is not in use.
COMM (orange)	Flashing	Data is being transferred through the RS-232C port.
	Not lit	The RS-232C port is not in use.

## 5. Input Indicators

The input indicators are lit when the corresponding input terminal is ON. The status of an input indicator will reflect the status of the input even when that input is being used for a high-speed counter.

**Note** a) When interrupt inputs are used in interrupt input mode, the indicator may not light even when the interrupt condition is met if the input is not ON long enough. When a high-speed counter is being used, the indicator may not light depending on the speed of the pulses.

b) Input indicators will reflect the status of the corresponding inputs even when the PC is stopped, but the corresponding input bits will not be refreshed.

## 6. Output Indicators

The output indicators are lit when the corresponding output terminal is ON. The indicators are lit during I/O refreshing. When an output is being used as a pulse output, the corresponding will remain lit while pulses are being output.

## 7. Peripheral Port

Connects the PC to a Programming Device (including Programming Consoles), host computer, or standard external device.

## 8. RS-232C Port

Connects the PC to a Programming Device (excluding Programming Consoles), host computer, Programmable Terminal, or standard external device.

9. Communications Switches SW201 and SW202

The Communications Switches control the communications settings for the peripheral port and RS-232C port.

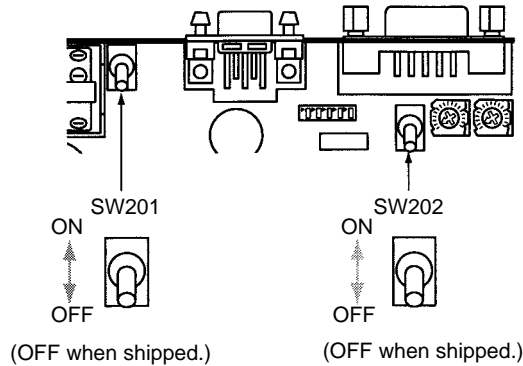

Switch settings		Peripheral port communications	RS-232C port communications
SW202	SW201		
OFF	OFF	Programming Console connection	The settings in the PC Setup (DM 6645 to DM 6649) are used.
OFF	ON	Other Programming Device: The settings in the PC Setup (DM 6650 to DM 6654) are used.	
ON	OFF	Programming Console connection	The standard settings are used.
ON	ON	Other Programming Device: The standard settings are used.	

- Note**
- a) The standard settings are 1 start bit, 7 data bits, 2 stop bits, even parity, and 9,600 bps baud rate.
  - b) Be sure that Communications Switch SW201 is OFF when connecting a Programming Console.

10. Analog Settings

Turning these controls changes the contents of IR 250 and IR 251. The contents of these words can be set independently between 0 and 200.

11. DIP Switch Inputs

The ON/OFF status of IR 00108 through IR 00111 reflects the ON/OFF status of these DIP switch pins.

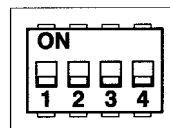

Pin	Corresponding input bit
1	IR 00108
2	IR 00109
3	IR 00110
4	IR 00111

12. Expansion I/O Connector

Connects the CPU Board to an Expansion I/O Board. Up to 3 Expansion I/O Boards can be connected to a CPU Board.

13. Battery

This battery backs up memory in CPU Boards equipped with an internal clock. The battery is connected when the Unit is shipped.

## 2-2-2 Expansion I/O Boards

### Expansion I/O Boards with Relay Outputs

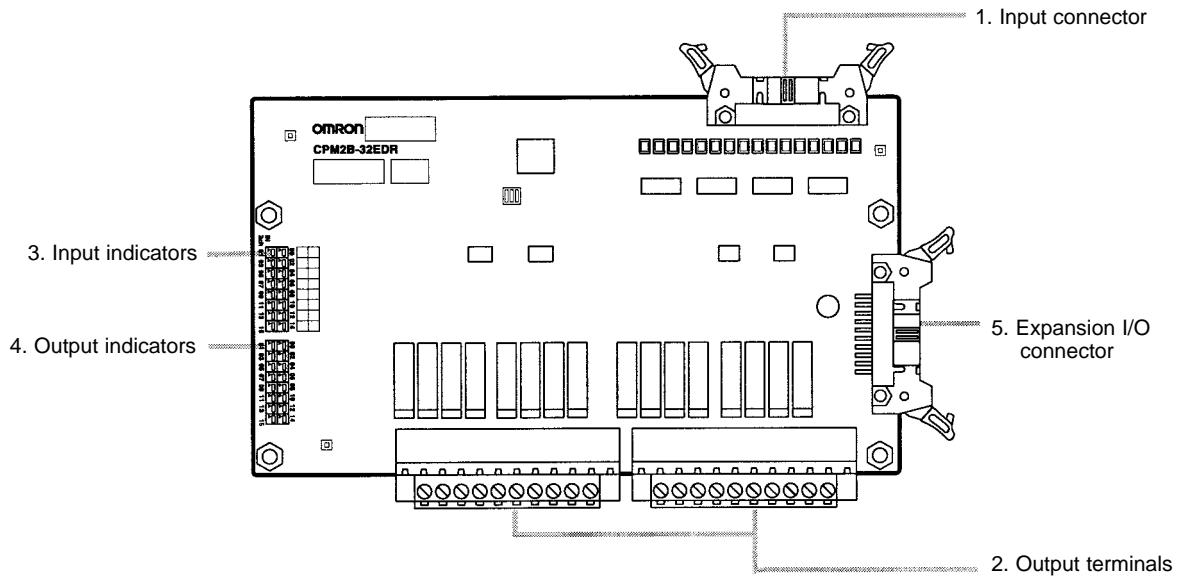

### Expansion I/O Boards with Transistor Outputs

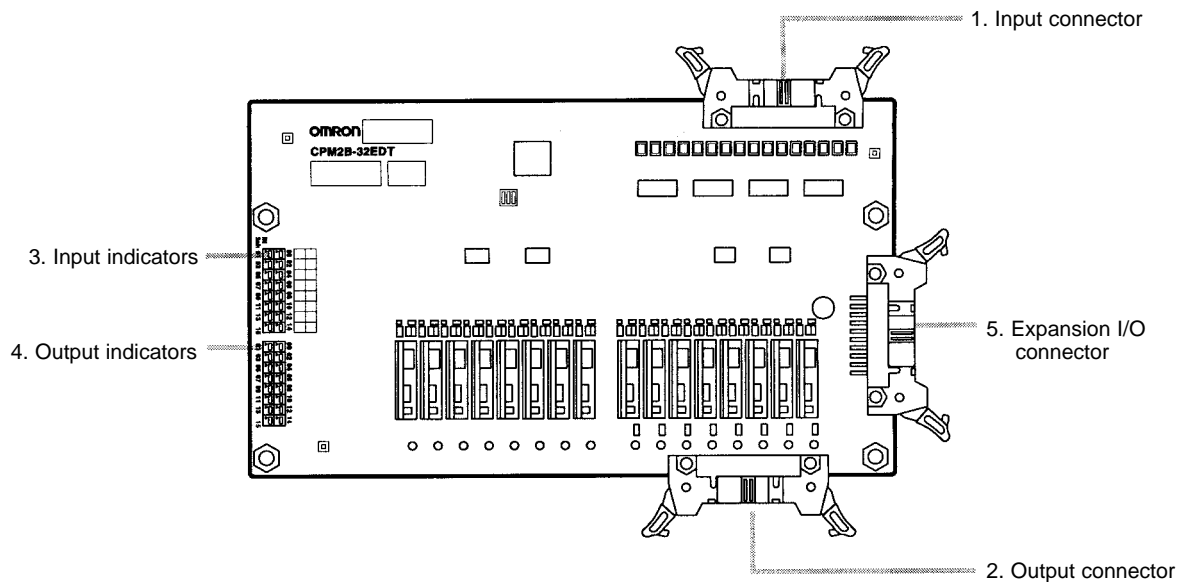

- 1, 2, 3...**
1. Input Connector  
Connects the Expansion I/O Board to external input devices.
  2. Output Terminals/Connector  
Connects the Expansion I/O Board to external output devices.
  3. Input Indicators  
The input indicators are lit when the corresponding input terminal is ON.
  4. Output Indicators  
The output indicators are lit when the corresponding output terminal is ON.
  5. Expansion I/O Connector  
Connects the Expansion I/O Board to the CPU Board or the previous Expansion Unit or Expansion I/O Unit. Up to 3 Expansion I/O Boards can be connected to a CPU Board. An Expansion I/O Cable is included with each Expansion I/O Board.

**Note** Do not touch the cables during operation to prevent unexpected operation due to static discharge.

## 2-3 I/O Connector and Terminal Pin Allocation

### CPU Boards

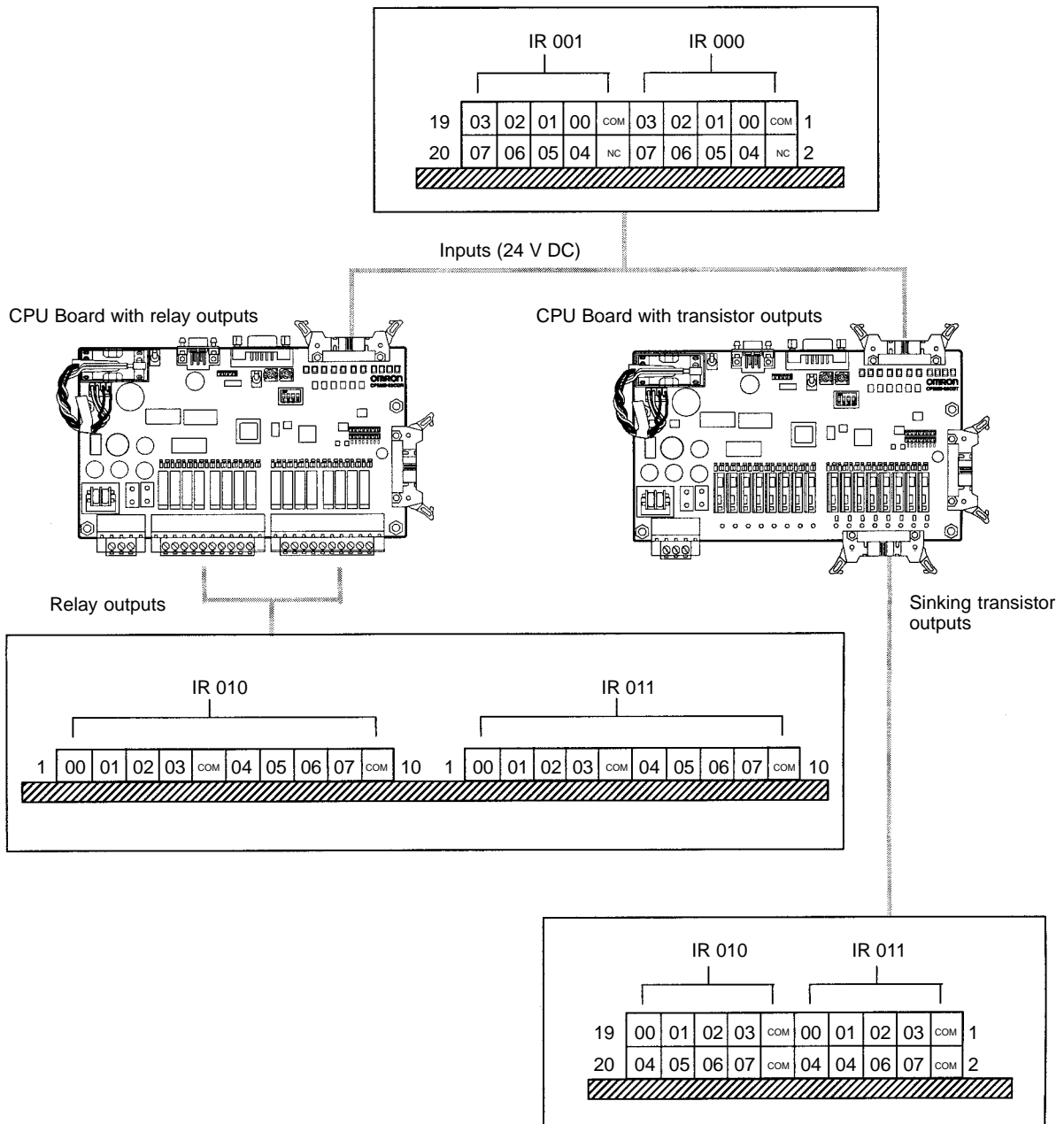

Expansion I/O Boards

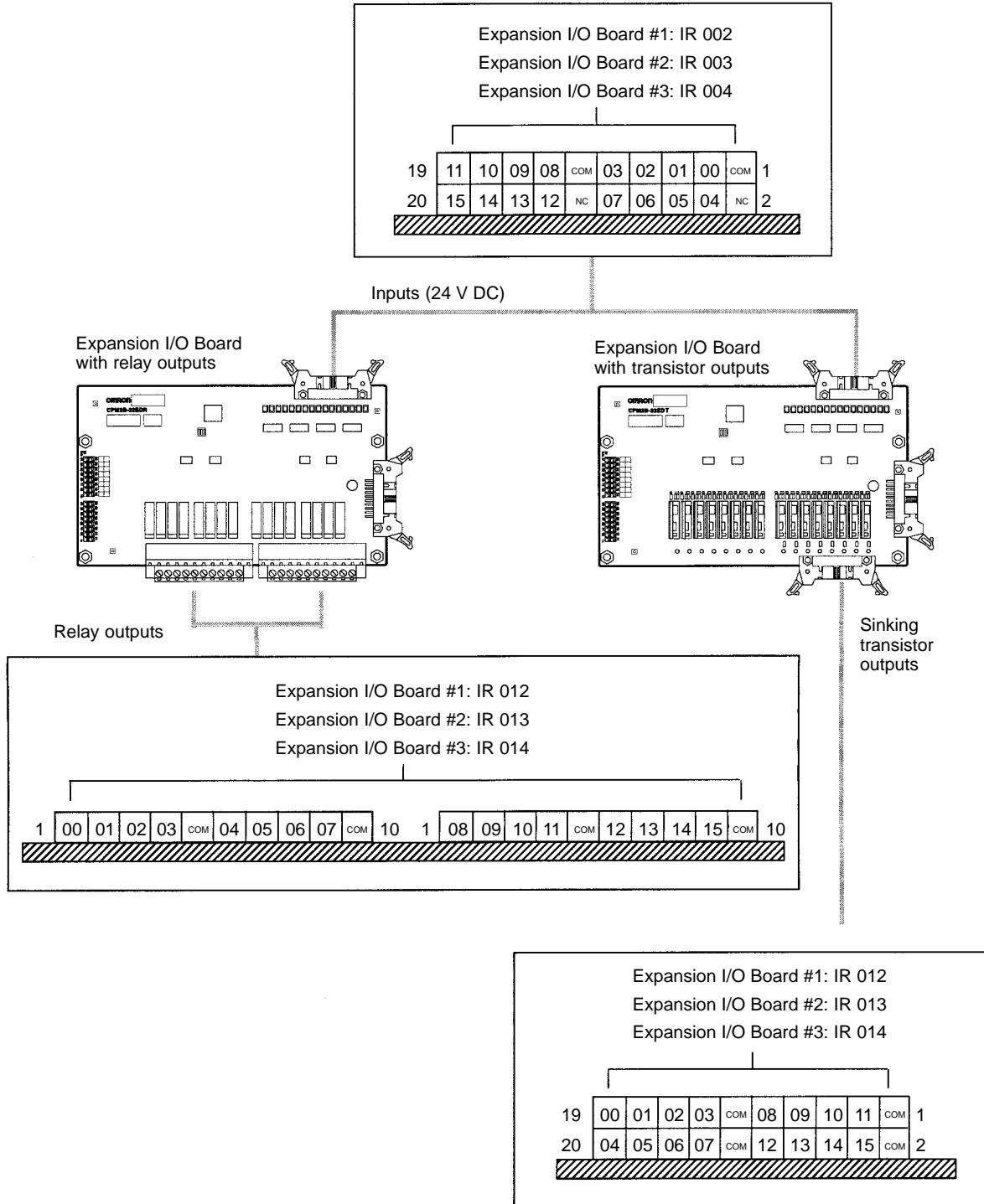

# SECTION 3

## Installation and Wiring

This section provides information on installing and wiring a CPM2B PC. Be sure to follow the directions and precautions in this section when installing the CPM2B in a panel or cabinet, wiring the power supply, or wiring I/O.

3-1	Design Precautions . . . . .	36
3-1-1	Power Supply Wiring . . . . .	36
3-1-2	Power Supply Voltage . . . . .	36
3-1-3	Interlock and Limit Circuits . . . . .	36
3-2	Selecting an Installation Site . . . . .	36
3-2-1	Installation Site Conditions . . . . .	37
3-2-2	Panel/Cabinet Installation . . . . .	37
3-3	Assembling the CPM2B Boards . . . . .	38
3-4	Installing the CPM2B . . . . .	39
3-5	Wiring and Connections . . . . .	40
3-5-1	Power Supply Wiring . . . . .	41
3-5-2	I/O Wiring Procedures . . . . .	42
3-5-3	Connecting Input Devices . . . . .	45
3-5-4	Output Wiring . . . . .	49

## 3-1 Design Precautions

Observe the following precautions when designing a system incorporating a CPM2B PC.

### 3-1-1 Power Supply Wiring

Separate the power supply wiring from the power system, control system, CPM2B system, and DC I/O system wiring. Separate the control circuits that supply power to the main Unit from the main circuits using dedicated circuit protectors and fuses.

### 3-1-2 Power Supply Voltage

**Caution** Use the power supply voltages indicated in *Section 2-1 Specification*. Failure to adhere to the specifications may result in fire.  
If the power supply voltage falls below 85% of the rated voltage, the CPM2B will stop and all outputs will be turned OFF. If low voltage affects the equipment, etc., provide a protection circuit which shuts off the output until the supply voltage returns to the rated value.  
In places where power supply conditions are poor, take steps to ensure that power is supplied at the rated voltage. Be sure to adhere to safety precautions, such as providing breakers to prevent short circuits in external wiring.  
When conducting any of the following operations, turn OFF the power to the PC. Electrocutation, product damage and malfunction may result.

- Connecting or disconnecting Expansion I/O Boards and CPU Boards.
- Assembling equipment.
- Connecting cables and wiring.

### 3-1-3 Interlock and Limit Circuits

**WARNING** Emergency stop circuits, interlock circuits, limit circuits, and similar safety measures must be provided in external control circuits (i.e., not in the Programmable Controller) to ensure safety in the system if an abnormality occurs due to malfunction of the PC or another external factor affecting the PC operation. Not providing proper safety measures may result in serious accidents.

The following diagram shows an example of an interlock circuit.

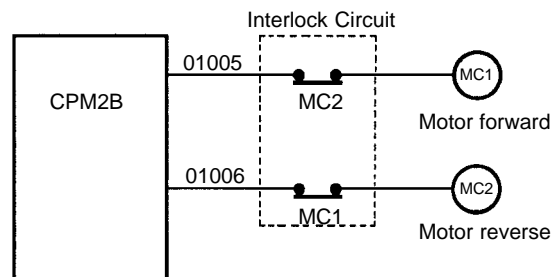

In the interlock circuit above, MC1 and MC2 can't be ON at the same time even if CPM2B outputs 01005 and 01006 are both ON (an incorrect PC operation).

## 3-2 Selecting an Installation Site

The CPM2B is resistant to harsh conditions and highly reliable, but installing the PC in a favorable site will maximize its reliability and operating lifetime.



**Caution** Be sure to install the CPM2B correctly, as outlined in this manual. Failure to do so may result in Board malfunction.

### 3-2-1 Installation Site Conditions

**Note** Do not install the CPM2B under any of the following conditions.

- Locations subject to direct sunlight.
- Locations subject to an ambient temperature below 0°C or over 55°C.
- Locations subject to an ambient humidity below 10% or over 90%.
- Locations subject to condensation as the result of severe changes in temperature.
- Locations subject to corrosive or flammable gases.
- Locations subject to dust (especially iron dust) or salts.
- Locations subject to shock or vibration.
- Locations subject to exposure to water, oil, or chemicals.

Be sure that the conditions at the installation site conform to the CPM2B's general specifications. Refer to 2-1-1 *General Specifications* for details.

**Note** Provide proper shielding when installing in the following locations:

- Locations subject to static electricity or other sources of noise.
- Locations subject to strong electromagnetic fields.
- Locations subject to possible exposure to radiation.
- Locations near to power supply lines.

### 3-2-2 Panel/Cabinet Installation

Consider PC operation, maintenance, and surrounding conditions when installing the CPM2B in a panel or cabinet.

#### Overheating

The ambient operating temperature range for the CPM2B is 0°C to 55°C. Be sure that there is adequate ventilation for cooling.

- Allow enough space for air circulation.
- Do not install the CPM2B above equipment that generates a large amount of heat, such as heaters, transformers, or large resistors.
- Install a cooling fan or system when the ambient temperature exceeds 55°C.

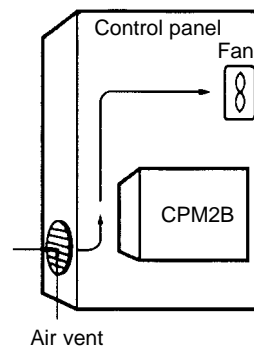

#### Electrical Noise

Power lines and high-voltage equipment can cause electrical noise in the PC.

- Do not install the CPM2B in a panel or cabinet with high-voltage equipment.
- Allow at least 200 mm between the CPM2B and nearby power lines.

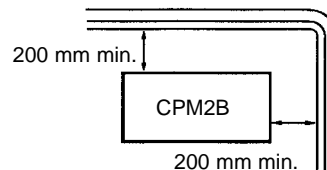

**Accessibility**

Ensure that the CPM2B can be accessed for normal operation and maintenance. High-voltage equipment, power lines, and moving machinery could be dangerous if they are in the way during routine operations.

### 3-3 Assembling the CPM2B Boards



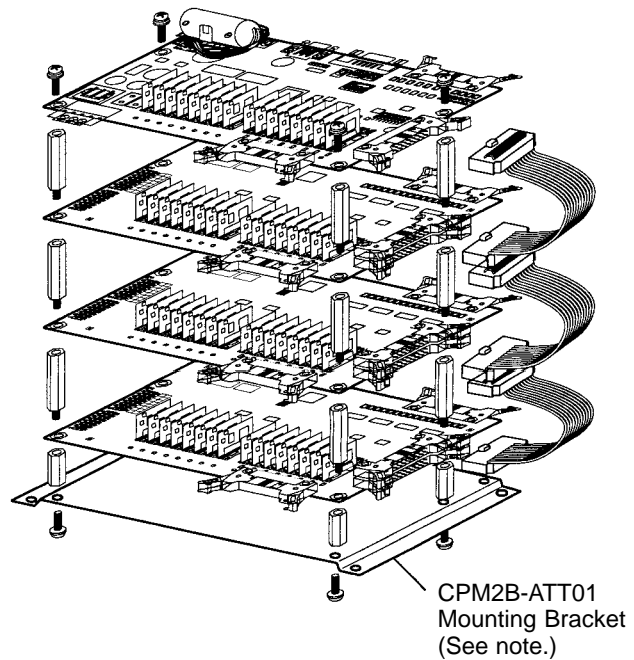

**Board Assembly**

Up to 3 Expansion I/O Boards can be connected to a CPM2B CPU Board. The following diagram shows how to assemble the Boards. The screws and standoffs are included with the CPU Board, Expansion I/O Board, and Mounting Bracket.

**Note** Use M3 screws for the standoffs and tighten to a torque of 0.5 N•m.

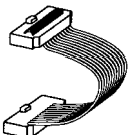

**Note** The CPM2B-ATT01 Mounting Bracket is required when the system must meet UL/CSA standards.

Board or Bracket	Hardware and cables included
CPU Board	Four M3 standoffs (short) 
	Four M3 screws 
Expansion I/O Board	Four M3 standoffs (long) 
	One CPM2B-CN601 Expansion I/O Cable 
Mounting Bracket	Four M3 screws 

**Note** Some of the CPM2B's electrical components such as leads are sharp, so do not touch the components or the surface of the circuit board.

**Installing the Expansion I/O Connecting Cables**

- 1, 2, 3... 1. Insert the Expansion I/O Cable into the connectors on the CPU Board and Expansion I/O Board.

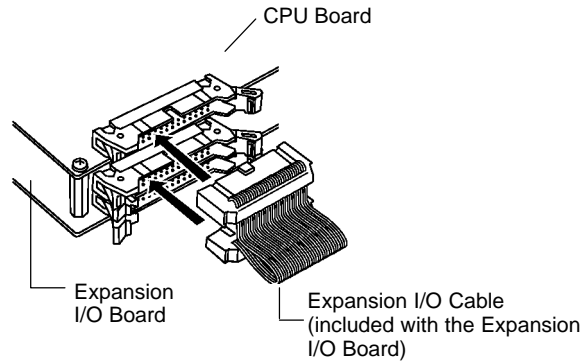

The cable from the CPU Board connects to the upper Expansion I/O Connector (the one with the short locks.)

Install the shorter connector of the cable in the lower Board and the longer connector in the upper Board.

2. Push the cable's connector into the Board's connector until both lock levers lock solidly.

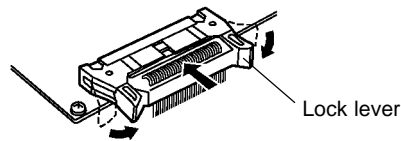

To remove the Expansion I/O Cable, open the connectors lock levers and pull out the cable's connector.

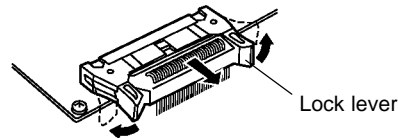

**3-4 Installing the CPM2B**

Install the CPM2B as shown in the following diagram. The CPM2B cannot be installed on DIN Track.

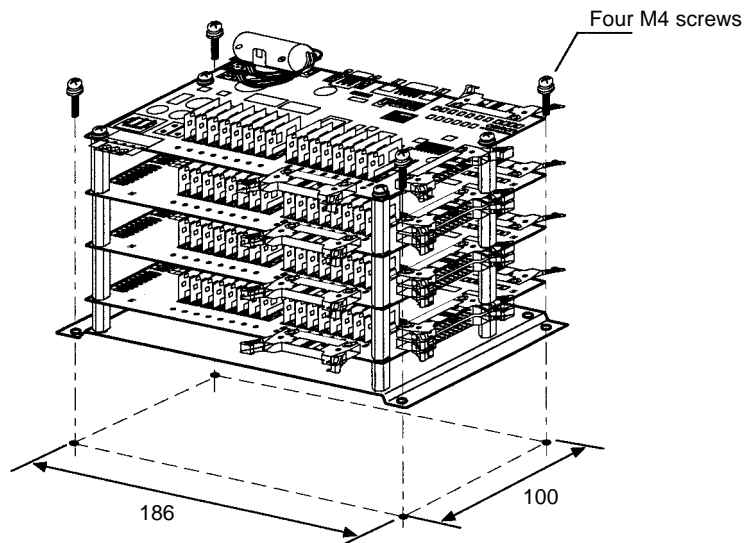

Example Installations

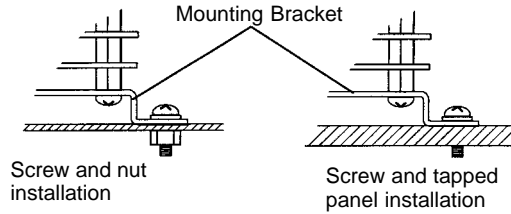

- Note**
1. Use M4 screws and tighten to a torque of 1.2 N•m.
  2. The CPM2B can be installed without a CPM2B-ATT01 Mounting Bracket, but the Mounting Bracket must be used to conform to UL/CSA standards. Refer to *Appendix B* for mounting dimensions.
  3. Installing the CPM2B horizontally or with its narrow edge down affects cooling and limits the number of inputs that can be ON simultaneously at high temperatures. Refer to page 26 for details.

### 3-5 Wiring and Connections

This section provides basic information on power supply wiring and I/O wiring.

#### General Precautions for Wiring

**Caution** Cover the CPM2B Boards with plastic or use some other method to prevent strands of wire from getting on the Board or inside the Board's components during wiring. Wire strands may short circuit the Board's components.

#### I/O Line Noise

Do not run CPM2B I/O lines in the same duct or conduit as power lines.

##### Hanging Ducts

Leave at least 300 mm between the power cables and the I/O or control wiring, as shown in the following diagram.

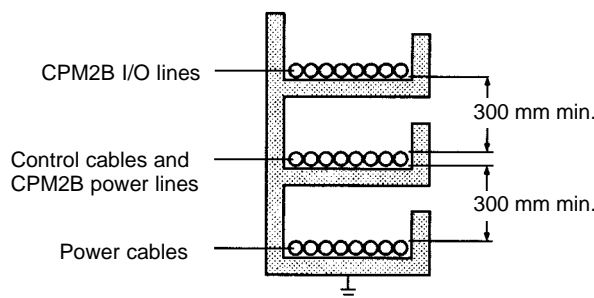

##### Floor Ducts

Leave at least 200 mm between the wiring and the top of the duct, as shown in the following diagram.

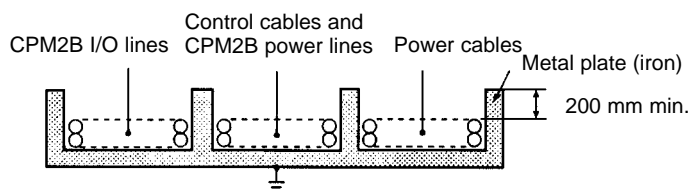

**Conduits**

Separate the CPM2B I/O lines, power and control lines, and power cables, as shown in the following diagram.

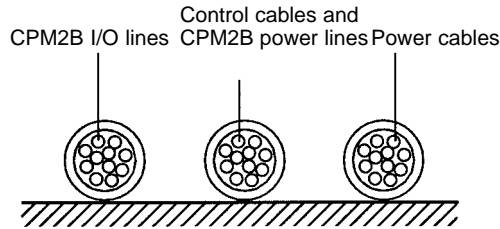

**3-5-1 Power Supply Wiring**

The power supply terminal specifications are shown below. Supply the power supply terminals with 24 V DC.

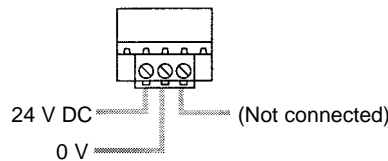

**Terminal Specifications**

Item	Specifications
Screw size	M3
Recommended torque	0.5 to 0.6 N•m Recommended screwdriver: OMRON XW4E-00C

**Compatible Wires and Terminals**

Wire/terminal		Specification
Solid wire		0.2 to 2.5 mm <sup>2</sup> (AWG 24 to AWG 12) Strip 7 mm (1/4 inch) of insulation.
Stranded wire		0.2 to 2.5 mm <sup>2</sup> (AWG 24 to AWG 12) Strip 7 mm (1/4 inch) of insulation.
Two-conductor wires	Solid	2 × (0.2 to 1.0 mm <sup>2</sup> ) (AWG 24 to AWG 20)
	Stranded	2 × (0.2 to 1.5 mm <sup>2</sup> ) (AWG 24 to AWG 16)
	Stranded with pin terminal	2 × (0.25 to 1.0 mm <sup>2</sup> ) (AWG 24 to AWG 20) without an insulating sleeve
Pin terminals		0.2 to 2.5 mm <sup>2</sup> diameter, 7-mm long pin terminal

The following diagram shows how to wire the power supply.

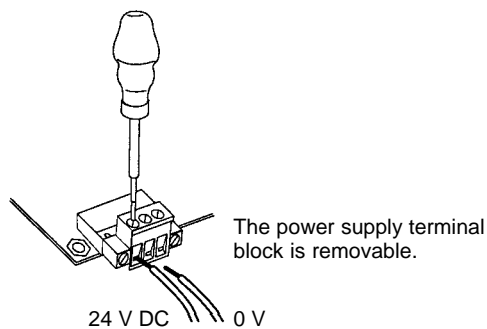

- Note**
1. Do not perform a voltage withstand test on the DC power supply terminals. The test might damage the PC's internal components.
  2. When equipment must conform to the EC Directives (Low-voltage Directives), use a power supply with double insulation or reinforced insulation.

### 3-5-2 I/O Wiring Procedures

#### Removing and Wiring I/O Terminal Blocks

The following tables provide output terminal block specifications.

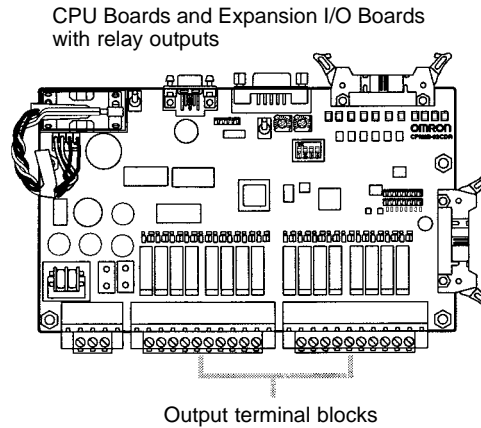

#### Terminal Block Specifications

Item	Specification
Screw size	M3
Recommended tightening torque	0.5 to 0.6 N•m Recommended screwdriver: OMRON XW4E-00C

#### Recommended Wire and Terminals

Item	Specification	
Solid wire	0.2 to 2.5 mm <sup>2</sup> (AWG 24 to AWG12) (Strip 7 mm.)	
Stranded wire (See notes.)	0.2 to 2.5 mm <sup>2</sup> (AWG 24 to AWG12) (Strip 7 mm.)	
Two-conductor wires	Solid	2 × (0.2 to 1.0 mm <sup>2</sup> ) (AWG 24 to AWG 20)
	Stranded	2 × (0.2 to 1.5 mm <sup>2</sup> ) (AWG 24 to AWG 16)
	Stranded with pin terminal	2 × (0.25 to 1.0 mm <sup>2</sup> ) (AWG 24 to AWG 20) without an insulating sleeve
Pin terminals	0.2 to 2.5 mm <sup>2</sup> diameter, 7-mm long pin terminal	
Bridge (shorts terminals)	Terminal pitch 5.08 mm Recommended Bridges: OMRON XW4Z-02C (2 pole) OMRON XW4Z-03C (3 pole)	

- Note**
1. When using stranded wire, be sure to avoid stray wire strands that might short-circuit an adjacent terminal.
  2. Do not solder the ends of stranded wires. Solder can break and cause wiring problems. Also, the solder can cause corrosion on the contact surface.
  3. Be sure to use the correct pin allocation when assembling and wiring connectors or terminal blocks.

#### Removing and Wiring a Terminal Block

Use the following procedure when wiring a terminal block.

- 1, 2, 3... 1. Use a flatblade screwdriver to loosen the screws at the left and right sides of the terminal block.

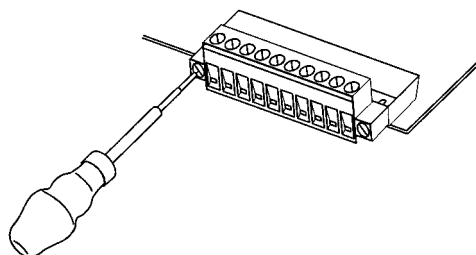

2. Pull the terminal block out of the Board.

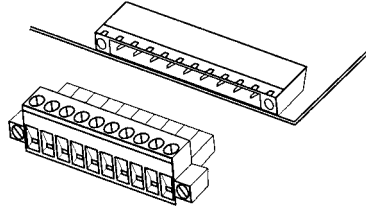

3. Insert each lead wire into the terminal block and tighten that terminal's screw.

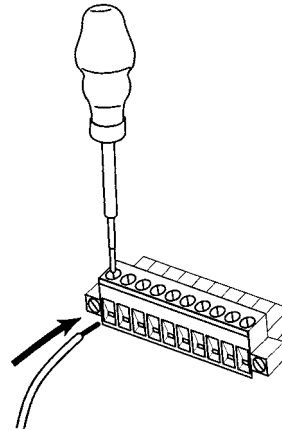

4. After wiring the terminal block, insert the block into the Unit and tighten the screws at the left and right sides of the terminal block.

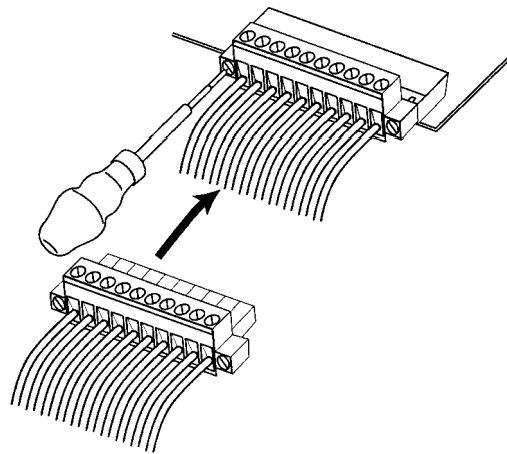

### Removing and Wiring I/O Connectors

The following tables provide specifications of compatible OMRON I/O connectors.

#### MIL 20P Flat Cable Connector

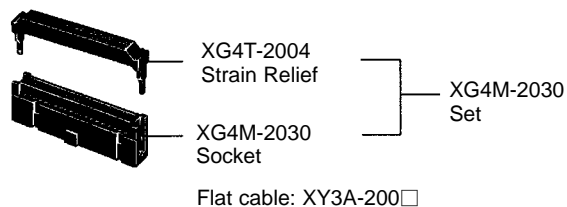

**Note** The max. rated current for flat cable is 1 A. Be sure that the current at the common terminal does not exceed 1A.

**OMRON Crimping Tools**

Crimping Tool	XY2B-0002
Attachment	XY2B-1007

**MIL 20P Loose-wire Pressure Connector**

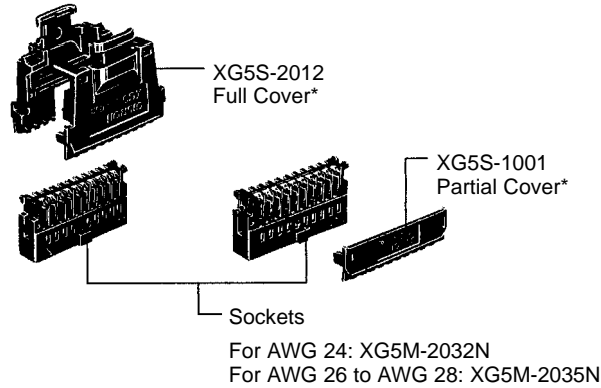

**Note** Two Full Covers or Partial Covers are required for each socket.

**OMRON Pressing Tools**

Pressing Tool Set (Handy Press)	XY2B-2104
Simple Pressing Tool	XY2B-7006

**Using Relay Terminal and Terminal Blocks**

A G79-A□C (Loose-wire Connecting Cable) can be used to connect to a Relay Terminal. (A pressure connector must be attached on the PC side of the cable.) A special cable is not provided for connection to the XW2B-20G4 or XW2B-20G5 Terminal Blocks, so one must be made. (The Terminal Block requires the kind of MIL 20P connector described above.)

**Inserting and Removing I/O Connectors**

When inserting a cable, first open the lock levers on each side of the connector and then insert the cable's connector. Press the cable's connector firmly until both lock levers lock onto the connector.

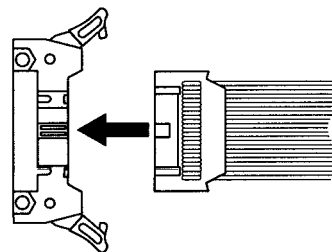

To remove the cable, open the lock levers to the left and right before removing the cable's connector.

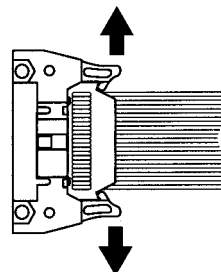



### 3-5-3 Connecting Input Devices

Wire inputs to the CPM2B CPU Board and Expansion I/O Boards as shown in the following diagrams.

**Note** When equipment must conform to the EC Directives (Low-voltage Directives), use a power supply with double insulation or reinforced insulation.

#### CPU Boards (All Models)

Input Connector

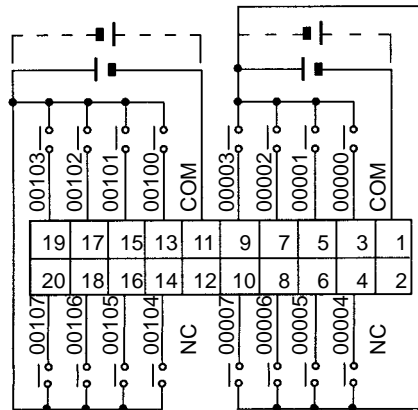

#### Expansion I/O Boards (All Models)

Input Connector

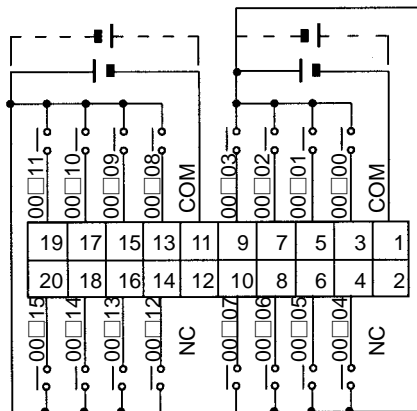

Input Devices

The following table shows how to connect various input devices.

Device	Circuit diagram
Relay output	
NPN open collector	
NPN current output	
PNP current output	
Voltage output	

**Note** Do not use the following wiring with voltage-output devices:

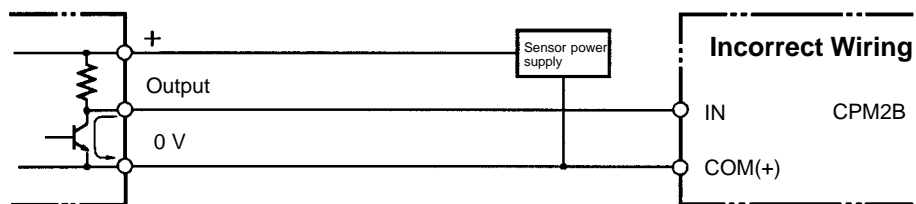

High-speed Counter Inputs

Using IR 00000 to IR 00002 as High-speed Counter Inputs

In these examples, Encoders with an external 24-V DC open-collector output are connected.

Differential Phase Mode  
(Count frequency: 5 kHz)

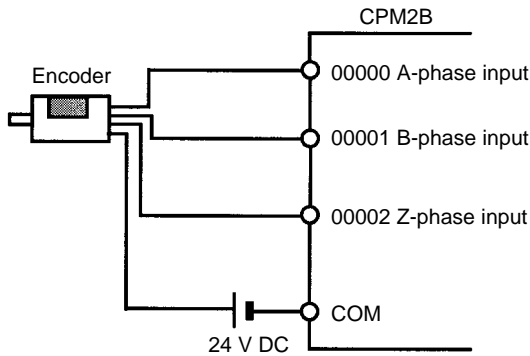

Pulse Plus Direction Input Mode  
(Count frequency: 20 kHz)

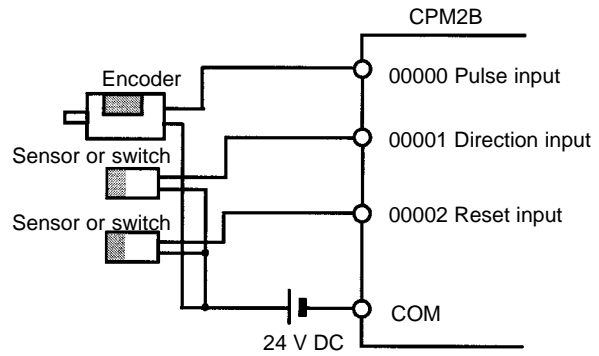

Up/Down Mode  
(Count frequency: 20 kHz)

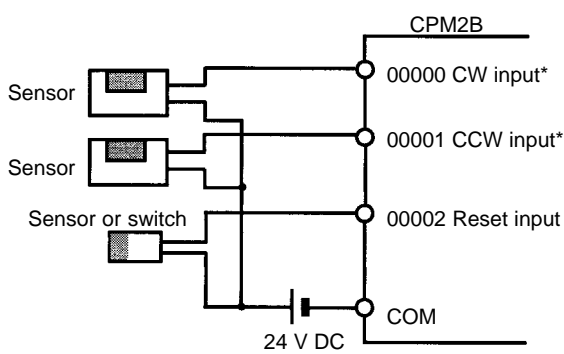

Increment Mode  
(Count frequency: 20 kHz)

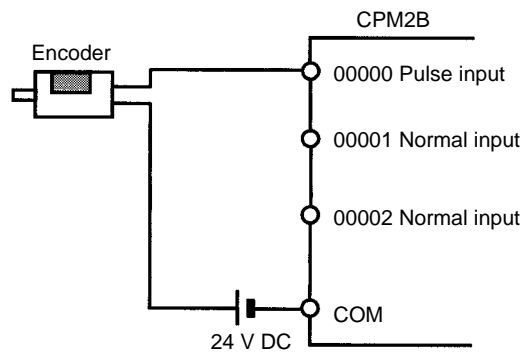

**Note** \*CW is clockwise and CCW is counter-clockwise.

Using IR 00003 to IR 00006 as Interrupt Inputs (Counter Mode)

In these examples, an Encoder with an external 24-V DC open-collector output is connected.

Increment or decrement  
(Count frequency: 2 kHz)

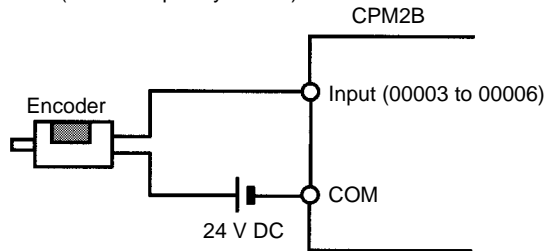

PC Setup Settings

The input bits shown in the following tables can operate as normal inputs or they can be assigned special functions in the PC Setup.

Special functions for input bits IR 00000 through IR 00002 are set in DM 6642:

Bit address	PC Setup setting (DM 6642 bits 08 to15)		
	00	01	02, 03, or 04
IR 00000	Used as normal inputs.	Used as high-speed counter inputs.	Used as inputs for synchronized pulse control.
IR 00001			Used as a normal input.
IR 00002			Used as a normal input.

Special functions for input bits IR 00003 through IR 00006 are set in DM 6628:

Bit address	Bits in DM 6628	PC Setup setting (in DM 6628)		
		0	1	2
IR 00003	00 to 03	Used as normal inputs.	Used as interrupt inputs (including counter mode).	Used as quick-response inputs.
IR 00004	04 to 07			
IR 00005	08 to 11			
IR 00006	12 to 15			

High-speed Counter Input Connection Examples

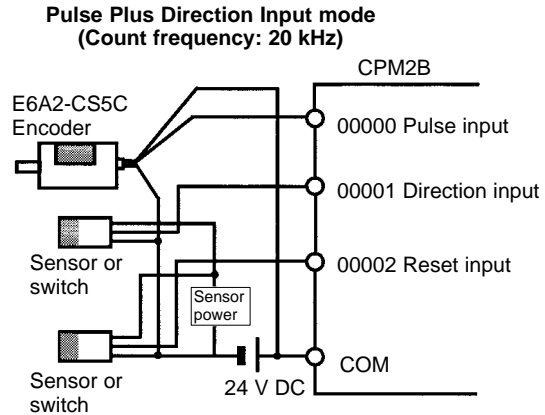
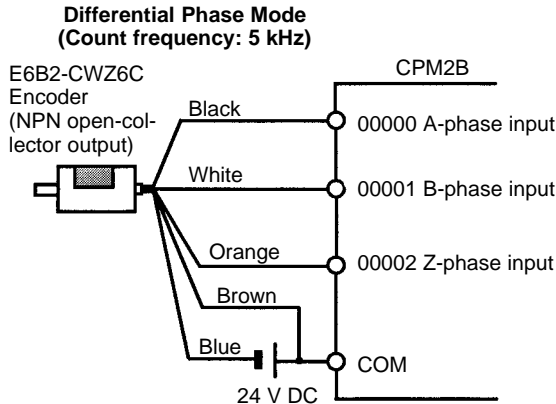

Leakage Current

A leakage current can cause false inputs when using 2-wire sensors (proximity switches or photoelectric switches) or limit switches with LEDs. False inputs won't occur if the leakage current is less than 1.0 mA (2.5 mA for IN00000 to IN00002). If the leakage current exceeds these values, insert a bleeder resistor in the circuit to reduce the input impedance, as shown in the following diagram.

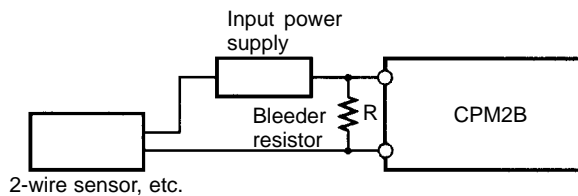

- I: Device's leakage current (mA)
- R: Bleeder resistance (kΩ)
- W: Bleeder resistor's power rating (W)
- L<sub>C</sub>: CPM2B's input impedance (kΩ)
- I<sub>C</sub>: CPM2B's input current (mA)
- E<sub>C</sub>: CPM2B's OFF voltage (V) = 5.0 V

$$R = \frac{L_C \times 5.0}{I \times L_C - 5.0} \text{ k}\Omega \text{ max.} \quad W = \frac{2.3}{R} \text{ W min.}$$

The equations above were derived from the following equations:

$$I \times \frac{R \times \frac{\text{Input voltage (24)}}{\text{Input Current (I}_C)}}{R + \frac{\text{Input voltage (24)}}{\text{Input Current (I}_C)}} \leq \text{OFF voltage (E}_C : 5.0)$$

$$W \leq \frac{\text{Input voltage (24)}}{R} \times \text{Input voltage (24)} \times \text{tolerance (4)}$$

Refer to 2-1-3 I/O Specifications for details on the values L<sub>C</sub>, I<sub>C</sub>, and E<sub>C</sub>. The input impedance, input current, and OFF voltage may vary depending on the input being used. (IN00000 through IN00002 have different values.)

Inductive Loads

When connecting an inductive load to an input, connect a diode in parallel with the load. The diode should satisfy the following requirements:

- 1, 2, 3... 1. Peak reverse-breakdown voltage must be at least 3 times the load voltage.

2. Average rectified current must be 1 A.

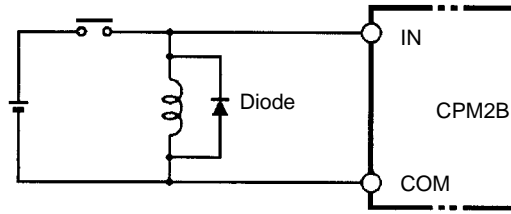

### 3-5-4 Output Wiring

#### Relay Output Wiring

Wire the outputs to the CPM2B's CPU Board and Expansion I/O Boards as shown in the following diagrams.

Don't exceed the output capacity or the maximum common current. Refer to 2-1-3 I/O Specifications for details.

**! WARNING** The PC outputs may remain ON or OFF due to fusing or burning of the output relays or destruction of the output transistors. External safety measures must be provided to ensure safety in the system. Not providing proper safety measures may result in serious accidents.

#### CPU Boards with Relay Outputs

Terminal Block #1 (Left side)

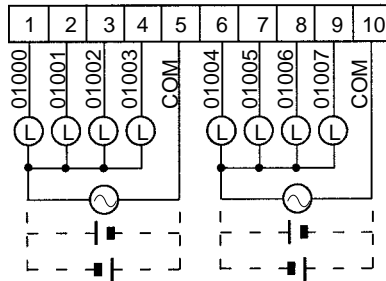

Terminal Block #2 (Right side)

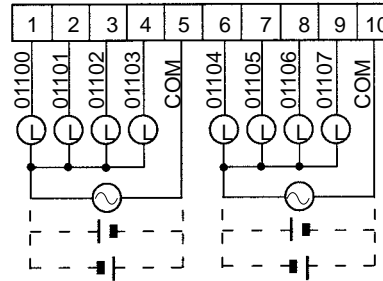

Output capacity	Max. common capacity
2 A (250 V AC or 24 V DC)	4 A/common

#### Expansion I/O Boards with Relay Outputs

Terminal Block #1 (Left side)

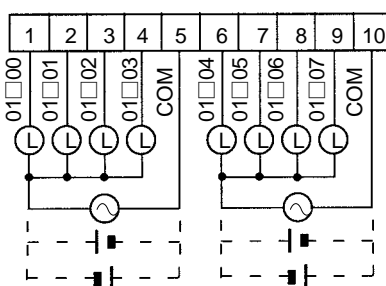

Terminal Block #2 (Right side)

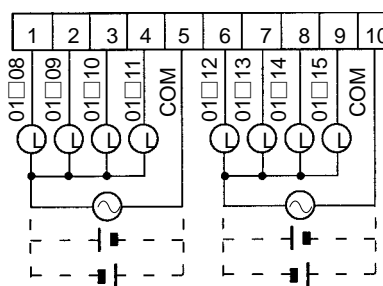

Output capacity	Max. common capacity
2 A (250 V AC or 24 V DC)	4 A/common

CPU Boards with Sinking Transistor Outputs

Output connector

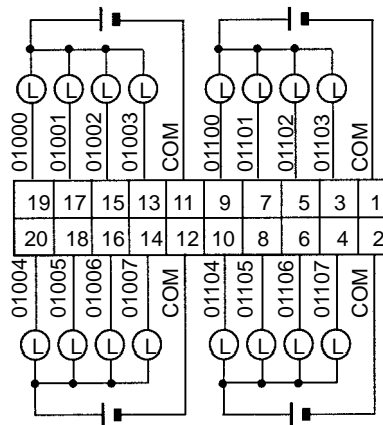

Output capacity	Max. common capacity
01000, 01001: 200 mA (30 V DC)	1.2 A/common
01002 and up: 300 mA (30 V DC)	

Expansion I/O Boards with Sinking Transistor Outputs

Output connector

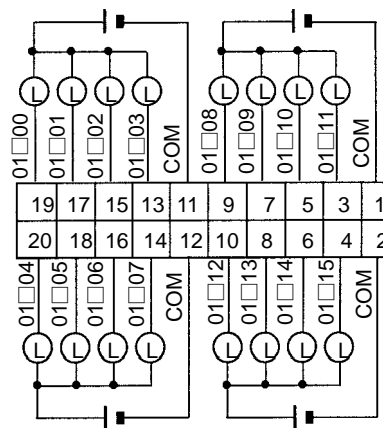

Output capacity	Max. common capacity
300 mA (30 V DC)	1.2 A/common

**Using Pulse Outputs**

Use the PULS(65), SPED(—), ACC(—), PWM(—), and SYNC(—) instructions to produce pulse outputs (rather than normal outputs) from output bits IR 01000 and IR 01001. Pulse outputs are possible from CPU Boards with transistor outputs only.

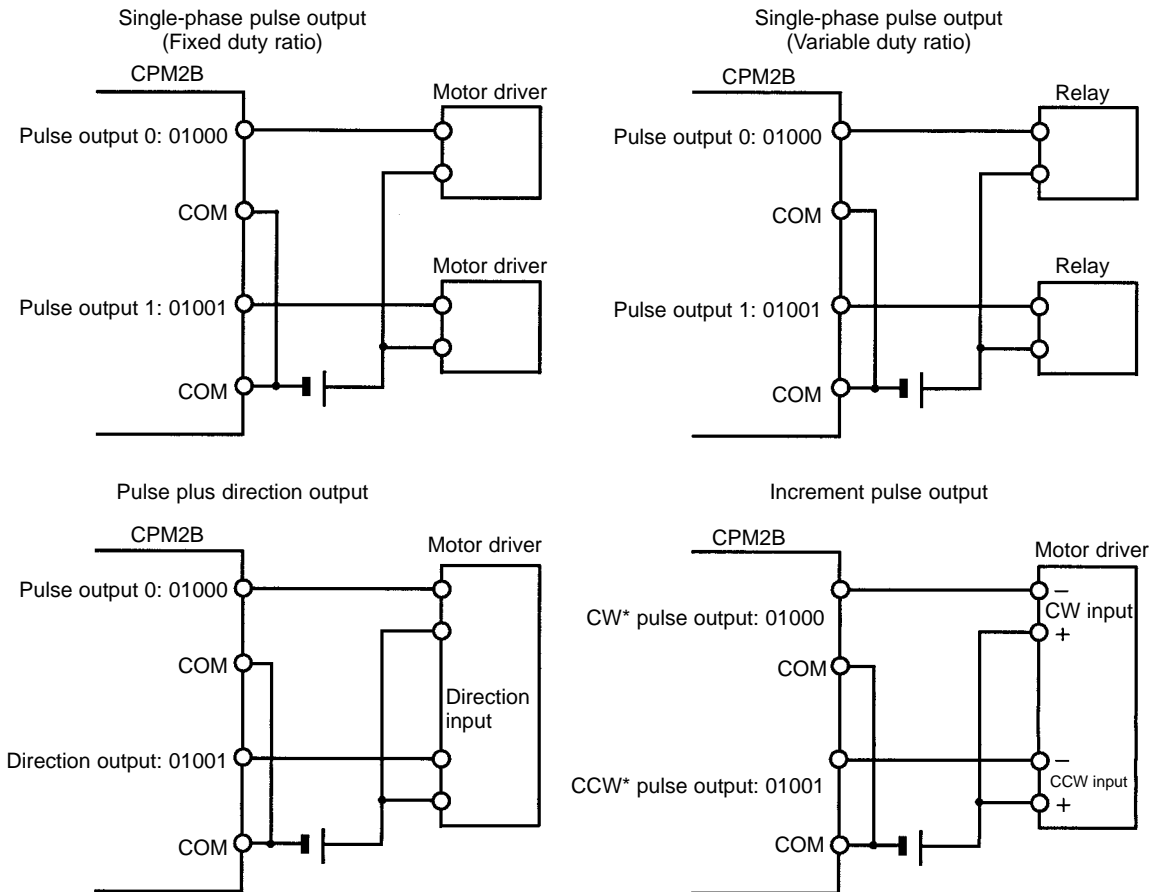

**Note** \*CW is clockwise and CCW is counter-clockwise.

**Output Wiring Precautions**

Observe the following precautions to protect the PC's internal components.

**Output Short Protection**

The output or internal circuitry might be damaged when the load connected to an output is short-circuited, so it is recommended to install a protective fuse in each output circuit.

**Inductive Loads**

When connecting an inductive load to an input, connect a surge protector or diode in parallel with the load.

The surge protector's components should have the following ratings:

**Relay Output**

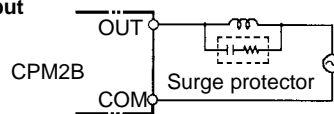

**Relay Output Transistor Output (Sinking)**

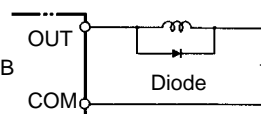

The diode should satisfy the following requirements:

Peak reverse-breakdown voltage must be at least 3 times the load voltage.

Average rectified current must be 1 A.

### Inrush Current Considerations

When a relay or transistor output is used to switch a load with a high inrush current such as an incandescent lamp, suppress the inrush current as shown below.

Countermeasure 1

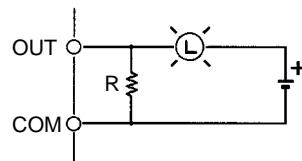

Providing a dark current of approx. one-third of the rated value through an incandescent lamp

Countermeasure 2

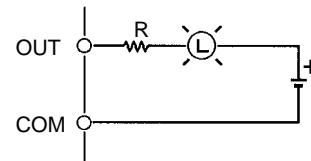

Providing a limiting resistor

### Fuse Insertion

The CPM2B with transistor output may burn if the load is short-circuited, therefore, insert a protective fuse in series with the load.



# SECTION 4

## Memory Areas

This section describes the structure of the PC memory areas and explains how to use them.

4-1	Introduction .....	54
	4-1-1 Functions .....	54
4-2	I/O Allocation .....	55
4-3	SR Area .....	58
4-4	AR Area .....	60
4-5	PC Setup .....	64
	4-5-1 Changing the PC Setup .....	64
	4-5-2 PC Setup Settings .....	65
4-6	Error Log .....	69

## 4-1 Introduction

Most data areas in the CPM2B can be accessed as bits or words. (The TR area can be accessed by bit address only and the DM area can be accessed by word address only.)

The following diagram shows the structure of the IR area and the relationship between bit and word addresses.

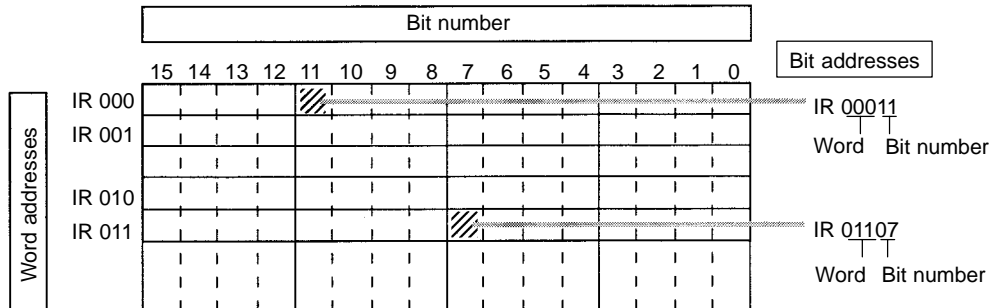

Data area	Size	Words	Bits	Function
Input area	160 bits (10 words)	IR 000 to IR 009	IR 00000 to IR 00915 (See note 1.)	These bits can be allocated to the external I/O terminals.
Output area	160 bits (10 words)	IR 010 to IR 019	IR 01000 to IR 01915	
Work area	928 bits (58 words)	IR 020 to IR 049 IR 200 to IR 227	IR 02000 to IR 04915 IR 20000 to IR 22715	Work bits can be freely used within the program.
SR area	448 bits (28 words)	SR 228 to SR 255	SR 22800 to SR 25515	These bits serve specific functions such as flags and control bits.
TR area	8 bits	TR 0 to TR 7		These bits are used to temporarily store ON/OFF status at program branches.
HR area	320 bits (20 words)	HR 00 to HR 19	HR 0000 to HR 1915	These bits store data and retain their ON/OFF status when power is turned off.
AR area	384 bits (24 words)	AR 00 to AR 23	AR 0000 to AR 2315	These bits serve specific functions such as flags and control bits.
LR area	256 bits (16 words)	LR 00 to LR 15	LR 0000 to LR 1515	Used for a 1:1 data link with another PC.
Timer/Counter area	256 bits	TIM/CNT 000 to TIM/CNT 255		The same numbers are used for both timers and counters.
DM area	Read/write	2,026 words	DM 0000 to DM 1999 DM 2022 to DM 2047	DM area data can be accessed in word units only. Word values are retained when the power is turned off.
	Error log	22 words	DM 2000 to DM 2021	
	Read-only	456 words	DM 6144 to DM 6599	The read-only area and PC Setup cannot be overwritten from program. Change these settings with a Programming Device.
	PC Setup	56 words	DM 6600 to DM 6655	

- Note**
1. Input bits IR 00108 to IR 00111 reflect the status of the DIP switch on the CPU Board.
  2. The contents of the HR area, AR area, Counter area, and read/write DM area are backed up by the CPU Board's backup battery or capacitor. If the battery or capacitor discharges completely, memory contents will be returned to their default settings.
  3. The program and data in DM 6144 to DM 6655 are stored in flash memory.

### 4-1-1 Functions

#### IR Area

The functions of the IR area are explained below.

IR area bits in the input and output areas are allocated to terminals on the CPU Board and Expansion I/O Boards. They reflect the ON/OFF status of input and output signals. Input bits begin at IR 00000, and output bits begin at IR 01000.

	IR words that are not allocated to inputs or outputs can be used as work words.
<b>Work Bits</b>	The work bits can be used freely within the program. They can only be used within the program, however, and not for direct external I/O.
<b>SR Area</b>	These bits mainly serve as flags for CPM2B operation or contain present and set values for various functions. SR 253 to SR 255 are read-only. Refer to 4-3 <i>SR Area</i> for details on the various bit functions.
<b>TR Area</b>	<p>When a complex ladder diagram cannot be programmed in mnemonic code just as it is, these bits are used to temporarily store ON/OFF execution conditions at program branches. They are used only for mnemonic code. When programming directly with ladder diagrams using the Support Software, TR bits are automatically processed for you.</p> <p>The same TR bits cannot be used more than once within the same instruction block, but can be used again in different instruction blocks. The ON/OFF status of TR bits cannot be monitored from a Programming Device.</p>
<b>HR Area</b>	These bits retain their ON/OFF status even after the PC power supply has been turned off or when operation begins or stops. They are used in the same way as work bits.
<b>AR Area</b>	These bits mainly serve as flags related to PC operation. These bits retain their status even after the PC power supply has been turned off or when operation begins or stops. Refer to 4-4 <i>AR Area</i> for details on the various bit functions.
<b>LR Area</b>	<p>When the CPM2B is linked 1:1 with another CPM2B or a CPM1/CPM1A/CPM2A/CPM2C/SRM1(-V2), a CQM1, a C200HS or a C200HX/HG/HE PC, these bits are used to share data.</p> <p>LR words can be used as work words when they are not used for a 1:1 PC Link.</p>
<b>Timer/Counter Area</b>	<p>This area is used to manage timers and counters created with TIM, TIMH(15), TMHH(—), TIML(—), CNT, and CNTR(12). The same numbers are used for both timers and counters and each number can be used only once in the user program. Do not use the same TC number twice even for different instructions.</p> <p>Use TC numbers 000 to 003 for TIMH(15) and TC numbers 004 to 007 for TMHH(—). When these timer numbers are used, timing is performed as an interrupt process and the cycle time is not affected.</p> <p>TC numbers are used to create timers and counters, as well as to access Completion Flags and present values (PVs). If a TC number is designated for word data, it will access the present value (PV); if it is used for bit data, it will access the Completion Flag for the timer/counter.</p>
<b>DM Area</b>	<p>DM area data is accessed in word units only. The contents of the DM area are retained even after the PC power supply has been turned off or when operation begins or stops.</p> <p>DM words DM 0000 to DM 1999 and DM 2022 to DM 2047 can be used freely in the program; other DM words are allocated specific functions.</p> <p>DM 2000 to DM 2021 contain the error log information. Refer to <i>Section 4-6 Error Log</i> for details on the error log.</p> <p>DM 6600 to DM 6655 contain the PC Setup. Refer to 4-5 <i>PC Setup</i> for details.</p>

## 4-2 I/O Allocation

IR bits are allocated to actual input terminals and output terminals on the CPU Board and Expansion I/O Boards. IR words that are not allocated to inputs or outputs can be used as work words.

**CPU Board I/O Allocation**

CPU Board inputs are allocated input bits starting from IR 00000 and CPU Board outputs are allocated output bits starting from IR 01000. Input bits IR 00108 to IR 00111 are allocated to the CPU Board's DIP switch inputs.

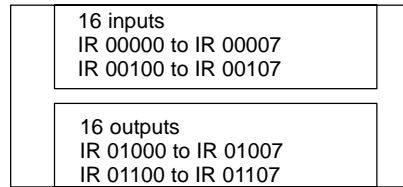

Bits		15	14	13	12	11	10	09	08	07	06	05	04	03	02	01	00
Inputs	IR 000	Do not use															
	IR 001																
Outputs	IR 010																
	IR 011																

- Note**
1. The unused bits in IR 000 and IR 001 cannot be used as work bits.
  2. IR 00108 to IR 00111 are used as an input DIP switch.

**Expansion I/O Board I/O Allocation**

Up to 3 Expansion I/O Boards can be connected.

Input bits are allocated to Expansion I/O Boards starting from word (m+1), where "m" is the last input word allocated to the CPU Board or to the previous Expansion I/O Board if one is already connected.

Output bits are allocated to Expansion I/O Boards starting from word (n+1), where "n" is the last output word allocated to the CPU Board or to the previous Expansion I/O Board if one is already connected.

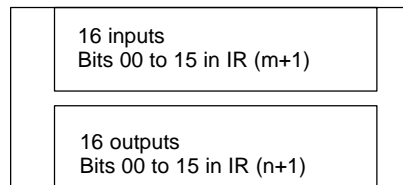

Bits		15	14	13	12	11	10	09	08	07	06	05	04	03	02	01	00
Inputs	m+1																
Outputs	n+1																

**CPU Board and One Expansion I/O Board**

The following example shows the I/O allocation when one Expansion I/O Board is connected to the CPU Board. Expansion I/O Board inputs are allocated IR 00200 through IR 00215 and the outputs are allocated IR 01200 through IR 01215.

Bits		15	14	13	12	11	10	09	08	07	06	05	04	03	02	01	00
Inputs	IR 000	Do not use as work bits.															
	IR 001																
	IR 002																
Outputs	IR 010																
	IR 011																
	IR 012																

**CPU Board and Three Expansion I/O Boards**

The following example shows the I/O allocation when three Expansion I/O Boards are connected to the CPU Board.

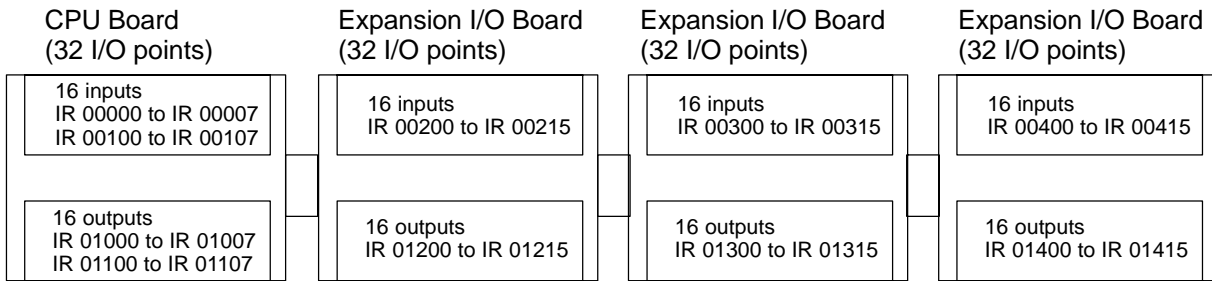

Bits		15	14	13	12	11	10	09	08	07	06	05	04	03	02	01	00	
Inputs	IR 000	Do not use as work bits.																
	IR 001																	
	IR 002																	
	IR 003																	
	IR 004																	
Outputs	IR 010																	
	IR 011																	
	IR 012																	
	IR 013																	
	IR 014																	

## 4-3 SR Area

These bits mainly serve as flags related to CPM2A/CPM2C operation or contain present and set values for various functions. The functions of the SR area are explained in the following table.

**Note** “Read-only” words and bits can be read as status in controller PC operation, but they cannot be written from the ladder program. Bits and words that are “Not used” are also read-only.

Word(s)	Bit(s)	Function	Read/write
SR 228, SR 229	00 to 15	<b>Pulse Output PV 0</b> Contains the pulse output PV (–16,777,215 to 16,777,215). SR 22915 acts as the sign bit; a negative number is indicated when SR 22915 is ON. (The same PV data can be read immediately with PRV(62).) Only Pulse Output PV 0 is used for ACC(—).	Read-only
SR 230, SR 231	00 to 15	<b>Pulse Output PV 1</b> Contains the pulse output PV (–16,777,215 to 16,777,215). SR 23115 acts as the sign bit; a negative number is indicated when SR 23115 is ON. (The same PV data can be read immediately with PRV(62).)	
SR 232 to SR 235	00 to 15	<b>Macro Function Input Area</b> Contains the input operands for MCRO(99). (Can be used as work bits when MCRO(99) is not used.)	Read/write
SR 236 to SR 239	00 to 15	<b>Macro Function Output Area</b> Contains the output operands for MCRO(99). (Can be used as work bits when MCRO(99) is not used.)	
SR 240	00 to 15	<b>Interrupt Input 00003 Counter Mode SV</b> SV when interrupt input 00003 is used in counter mode (4 digits hexadecimal). (Can be used as work bits when interrupt input 00003 is not used in counter mode.)	
SR 241	00 to 15	<b>Interrupt Input 00004 Counter Mode SV</b> SV when interrupt input 00004 is used in counter mode (4 digits hexadecimal). (Can be used as work bits when interrupt input 00004 is not used in counter mode.)	
SR 242	00 to 15	<b>Interrupt Input 00005 Counter Mode SV</b> SV when interrupt input 00005 is used in counter mode (4 digits hexadecimal). (Can be used as work bits when interrupt input 00005 is not used in counter mode.)	
SR 243	00 to 15	<b>Interrupt Input 00006 Counter Mode SV</b> SV when interrupt input 00006 is used in counter mode (4 digits hexadecimal). (Can be used as work bits when interrupt input 00006 is not used in counter mode.)	
SR 244	00 to 15	<b>Interrupt Input 00003 Counter Mode PV</b> Counter PV when interrupt input 00003 is used in counter mode (4 digits hexadecimal).	
SR 245	00 to 15	<b>Interrupt Input 00004 Counter Mode PV</b> Counter PV when interrupt input 00004 is used in counter mode (4 digits hexadecimal).	
SR 246	00 to 15	<b>Interrupt Input 00005 Counter Mode PV</b> Counter PV when interrupt input 00005 is used in counter mode (4 digits hexadecimal).	
SR 247	00 to 15	<b>Interrupt Input 00006 Counter Mode PV</b> Counter PV when interrupt input 00006 is used in counter mode (4 digits hexadecimal).	Read-only
SR 248, SR 249	00 to 15	<b>High-speed Counter PV Area</b> The PVs can have the following values. The leftmost digit of SR 249 acts as the sign indicator; a negative number is indicated when the leftmost digit of SR 249 is F. Differential phase input mode: –8,388,608 (F838 8608) to 8,388,607 Pulse +direction input mode: –8,388,608 (F838 8608) to 8,388,607 Up/down pulse input mode: –8,388,608 (F838 8608) to 8,388,607 Increment mode: 0 to 16,777,215 Synchronized pulse control: 0 to 20,000 Hz (Can be used as work bits when the high-speed counter is not used.)	
SR 250	00 to 15	<b>Analog Setting 0</b> Used to store the 4-digit BCD set value (0000 to 0200) from analog control 0.	
SR 251	00 to 15	<b>Analog Setting 1</b> Used to store the 4-digit BCD set value (0000 to 0200) from analog control 1.	

Word(s)	Bit(s)	Function	Read/write
SR 252	00	<b>High-speed Counter Reset Bit</b>	Read/write
	01 to 03	Not used.	
	04	<b>Pulse Output 0 PV Reset Bit</b> Turn ON to clear the PV of pulse output 0.	Read/write
	05	<b>Pulse Output 1 PV Reset Bit</b> Turn ON to clear the PV of pulse output 1.	
	06, 07	Not used.	Read/write
	08	<b>Peripheral Port Reset Bit</b> Turn ON to reset the peripheral port. Automatically turns OFF when reset is complete.	
	09	<b>RS-232C Port Reset Bit</b> Turn ON to reset the RS-232C port. Automatically turns OFF when reset is complete.	
	10	<b>PC Setup Reset Bit</b> Turn ON to initialize PC Setup (DM 6600 through DM 6655). Automatically turns OFF again when reset is complete. Only effective if the PC is in PROGRAM mode.	
	11	<b>Forced Status Hold Bit</b> (See note.) OFF: The forced status of bits that are forced set/reset is cleared when switching between PROGRAM mode and MONITOR mode. ON: The status of bits that are forced set/reset are maintained when switching between PROGRAM mode and MONITOR mode. The PC Setup can be set to maintain the status of this bit when the PC is turned off.	
	12	<b>I/O Hold Bit</b> (See note.) OFF: IR and LR bits are reset when starting or stopping operation. ON: IR and LR bit status is maintained when starting or stopping operation. The PC Setup can be set to maintain the status of this bit when the PC is turned off.	
	13	Not used.	Read/write
	14	<b>Error Log Reset Bit</b> Turn ON to clear error log. Automatically turns OFF again when operation is complete.	
15	Not used.		
SR 253	00 to 07	<b>FAL Error Code</b> The error code (a 2-digit number) is stored here when an error occurs. The FAL number is stored here when FAL(06) or FALS(07) is executed. This word is reset (to 00) by executing a FAL 00 instruction or by clearing the error from a Programming Device.	Read-only
	08	<b>Battery Error Flag</b> Turns ON when the CPU Board backup battery's voltage is too low.	
	09	<b>Cycle Time Overrun Flag</b> Turns ON when a cycle time overrun occurs (i.e., when the cycle time exceeds the maximum cycle time set in the PC Setup).	
	10,11	Not used.	Read/write
	12	<b>Changing RS-232C Setup Flag</b> Turns ON when the RS-232C port's settings are being changed.	
	13	<b>Always ON Flag</b>	
	14	<b>Always OFF Flag</b>	
15	<b>First Cycle Flag</b> Turns ON for 1 cycle at the start of operation.	Read-only	

Word(s)	Bit(s)	Function	Read/write
SR 254	00	1-minute clock pulse (30 seconds ON; 30 seconds OFF)	Read-only
	01	0.02-second clock pulse (0.01 second ON; 0.01 second OFF)	
	02	<b>Negative (N) Flag</b> Turns ON when the result of a calculation is negative (leftmost bit of binary result ON.)	
	03	Not used.	Read-only
	04	<b>Overflow (OF) Flag</b> Turns ON when an overflow occurs in a signed binary calculation.	
	05	<b>Underflow (UF) Flag</b> Turns ON when an underflow occurs in a signed binary calculation.	
	06	<b>Differential Monitor Complete Flag</b> Turns ON when differential monitoring is completed.	
	07	<b>STEP(08) Execution Flag</b> Turns ON for 1 cycle only at the start of process based on STEP(08).	
	08 to 15	Not used.	
SR 255	00	0.1-second clock pulse (0.05 second ON; 0.05 second OFF)	Read-only
	01	0.2-second clock pulse (0.1 second ON; 0.1 second OFF)	
	02	1.0-second clock pulse (0.5 second ON; 0.5 second OFF)	
	03	<b>Instruction Execution Error (ER) Flag</b> Turns ON when an error occurs during execution of an instruction.	
	04	<b>Carry (CY) Flag</b> Turns ON when there is a carry in the results of an instruction execution.	
	05	<b>Greater Than (GR) Flag</b> Turns ON when the result of a comparison operation is "greater."	
	06	<b>Equals (EQ) Flag</b> Turns ON when the result of a comparison operation is "equal," or when the result of an instruction execution is 0.	
	07	<b>Less Than (LE) Flag</b> Turns ON when the result of a comparison operation is "less."	
	08 to 15	Not used.	

**Note** DM 6601 in the PC Setup can be set to maintain the previous status of the Forced Status Hold Bit (SR 25211) and the I/O Hold Bit (SR 25212) when power is turned OFF. Refer to 4-5 PC Setup for details.

## 4-4 AR Area

These bits mainly serve as flags related to CPM2B operation. These bits retain their status even after the CPM2B power supply has been turned off or when operation begins or stops.

Word(s)	Bit(s)	Function
AR 00, AR 01	00 to 15	Not used.
AR 02	00 to 07	Not used.
	08 to 11	<b>Number of Expansion I/O Boards Connected</b>
	12 to 15	Not used.
AR 03 to AR 07	00 to 15	Not used.



Word(s)	Bit(s)	Function
AR 08	00 to 03	<b>RS-232C Port Error Code (1-digit BCD)</b> 0: Normal completion 1: Parity error 2: Frame error 3: Overrun error
	04	<b>RS-232C Communications Error Flag</b> Turns ON when an RS-232C port communications error occurs.
	05	<b>RS-232C Transmit Ready Flag</b> Turns ON when the PC is ready to transmit data. (No-protocol and Host Link only)
	06	<b>RS-232C Reception Completed Flag</b> Turns ON when the PC has completed reading data. (No-protocol only)
	07	<b>RS-232C Reception Overflow Flag</b> Turns ON when an overflow has occurred. (No-protocol only)
	08 to 11	<b>Peripheral Port Error Code (1-digit BCD)</b> 0: Normal completion 1: Parity error 2: Frame error 3: Overrun error
	12	<b>Peripheral Port Communications Error Flag</b> Turns ON when a peripheral port communications error occurs.
	13	<b>Peripheral Port Transmit Ready Flag</b> Turns ON when the PC is ready to transmit data. (No-protocol and Host Link only)
	14	<b>Peripheral Port Reception Completed Flag</b> Turns ON when the PC has completed reading data. (No-protocol only)
	15	<b>Peripheral Port Reception Overflow Flag</b> Turns ON when an overflow has occurred. (No-protocol only)
AR 09	00 to 15	<b>RS-232C Port Reception Counter (4-digit BCD)</b> Valid only when no-protocol communications are used.
AR 10	00 to 15	<b>Peripheral Port Reception Counter (4-digit BCD)</b> Valid only when no-protocol communications are used.

Word(s)	Bit(s)	Function
AR 11 (Note 1)	00 to 07	<b>High-speed Counter Range Comparison Flags</b> 00 ON: Counter PV is within comparison range 1 01 ON: Counter PV is within comparison range 2 02 ON: Counter PV is within comparison range 3 03 ON: Counter PV is within comparison range 4 04 ON: Counter PV is within comparison range 5 05 ON: Counter PV is within comparison range 6 06 ON: Counter PV is within comparison range 7 07 ON: Counter PV is within comparison range 8
	08	<b>High-speed Counter Comparison Operation</b> ON: Operating OFF: Stopped
	09	<b>High-speed Counter PV Overflow/Underflow Flag</b> ON: An overflow or underflow occurred. OFF: Normal operation
	10	Not used.
	11	<b>Pulse Output 0 Output Status</b> ON: Pulse output 0 is accelerating or decelerating. OFF: Pulse output 0 is operating at a constant rate.
	12	<b>Pulse Output 0 Overflow/Underflow Flag</b> ON: An overflow or underflow occurred. OFF: Normal operation
	13	<b>Pulse Output 0 Pulse Quantity Set Flag</b> ON: Pulse quantity has been set. OFF: Pulse quantity has not been set.
	14	<b>Pulse Output 0 Pulse Output Completed Flag</b> ON: Completed OFF: Not completed
15	<b>Pulse Output 0 Output Status</b> ON: Pulses being output. OFF: Stopped.	
AR 12 (Note 1)	00 to 10	Not used.
	11	<b>Pulse Output 1 Output Status</b> ON: Pulse output 1 is accelerating or decelerating. OFF: Pulse output 1 is operating at a constant rate.
	12	<b>Pulse Output 1 Overflow/Underflow Flag</b> ON: An overflow or underflow occurred. OFF: Normal operation
	13	<b>Pulse Output 1 Pulse Quantity Set Flag</b> ON: Pulse quantity has been set. OFF: Pulse quantity has not been set.
	14	<b>Pulse Output 1 Pulse Output Completed Flag</b> ON: Completed OFF: Not completed
15	<b>Pulse Output 1 Output Status</b> ON: Pulses being output. OFF: Stopped.	

Word(s)	Bit(s)	Function
AR 13	00	<b>Power-up PC Setup Error Flag</b> Turns ON when there is an error in DM 6600 to DM 6614 (the part of the PC Setup area that is read at power-up).
	01	<b>Start-up PC Setup Error Flag</b> Turns ON when there is an error in DM 6615 to DM 6644 (the part of the PC Setup area that is read at the beginning of operation).
	02	<b>RUN PC Setup Error Flag</b> Turns ON when there is an error in DM 6645 to DM 6655 (the part of the PC Setup area that is always read).
	03, 04	Not used.
	05	<b>Cycle Time Too Long Flag</b> Turns ON if the actual cycle time is longer than the cycle time set in DM 6619.
	06, 07	Not used.
	08	<b>Memory Area Specification Error Flag</b> Turns ON when a non-existent data area address is specified in the program.
	09	<b>Flash Memory Error Flag</b> Turns ON when there is an error in flash memory.
	10	<b>Read-only DM Error Flag</b> Turns ON when a checksum error occurs in the read-only DM (DM 6144 to DM 6599).
	11	<b>PC Setup Error Flag</b> Turns ON when a checksum error occurs in the PC Setup area.
	12	<b>Program Error Flag</b> Turns ON when a checksum error occurs in the program memory (UM) area, or when an improper instruction is executed.
	13	<b>Expansion Instruction Area Error Flag</b> Turns ON when a checksum error occurs in the expansion instruction assignments area. The expansion instruction assignments will be cleared to their default settings.
	14	<b>Data Save Error Flag</b> Turns ON if data could not be retained with the backup battery or capacitor.  The following words are normally backed up: DM read/write words (DM 0000 to DM 1999 and DM 2022 to DM 2047), Error Log (DM 2000 to DM 2021), HR area, counter area, SR 25511, SR 25512 (if DM 6601 is set to hold I/O memory at startup), AR 23, operating mode (if DM 6600 is set to use the previous operating mode).  If the above words cannot be retained, all data will be cleared except that AR 2114 will be turned ON in CPU Boards equipped with a clock. The CPU Board will start in PROGRAM mode if DM 6600 is set to use the previous operating mode. (If DM 6604 is set to generate an error, the PC will start in PROGRAM mode regardless.)
	15	Not used.
	AR 14	00 to 15
AR 15	00 to 15	<b>Current Cycle Time</b> (4-digit BCD, see note 3) The most recent cycle time during operation is stored. The Current Cycle Time is not cleared when operation stops.
AR 16	00 to 15	Not used.
AR 17 (Note 2)	00 to 07	<b>Minute</b> (00 to 59, BCD)
	08 to 15	<b>Hour</b> (00 to 59, BCD)
AR 18 (Note 2)	00 to 07	<b>Second</b> (00 to 59, BCD)
	08 to 15	<b>Minute</b> (00 to 59, BCD)
AR 19 (Note 2)	00 to 07	<b>Hour</b> (00 to 23, BCD)
	08 to 15	<b>Day of the Month</b> (01 to 31, BCD)
AR 20 (Note 2)	00 to 07	<b>Month</b> (01 to 12, BCD)
	08 to 15	<b>Year</b> (00 to 99, BCD)

Word(s)	Bit(s)	Function
AR 21 (Note 2)	00 to 07	<b>Day of the Week</b> (00 to 06, BCD) 00: Sunday    01: Monday    02: Tuesday    03: Wednesday 04: Thursday    05: Friday    06: Saturday
	08 to 12	Not used.
	13	<b>30-second Compensation Bit</b> Turn this bit ON to round off to the nearest minute. When the seconds are 00 to 29, the seconds are cleared to 00 and the rest of the time setting is left unchanged. When the seconds are 30 to 59, the seconds are cleared to 00 and the time is incremented by one minute.
	14	<b>Clock Stop Bit</b> Turn this bit ON to stop the clock. The time/date can be overwritten while this bit is ON.
	15	<b>Clock Set Bit</b> To change the time/date, turn ON AR 2114, write the new time/date (being sure to leave AR 2114 ON), and then turn this bit ON to enable a new time/date setting. The clock will restart and both AR 2114 and AR 2115 will be turned OFF automatically.
AR 22	00 to 15	Not used.
AR 23	00 to 15	<b>Power-off Counter</b> (4-digit BCD) This is the count of the number of times that the power has been turned off. To clear the count, write "0000" from a Programming Device.

- Note**
1. The same data can be read immediately with PRV(62).
  2. The time and date can be set while AR 2114 is ON. The new setting becomes effective when AR 2115 is turned ON. (AR 2114 and AR 2115 are turned OFF automatically when the new setting goes into effect.)
  3. The units for the maximum and current cycle times are determined by the setting in bits 08 to 15 of DM 6618. A setting of 00 specifies 0.1-ms units, 01 specifies 0.1-ms units, 02 specifies 1-ms units, and 03 specifies 10-ms units.

## 4-5 PC Setup

The PC Setup comprises various operating parameters that control PC operation. In order to make the maximum use of PC functionality when using interrupt processing and communications functions, the PC Setup may be customized according to operating conditions.

After the PC Setup has been changed, be sure to switch the CPM2B to MONITOR or RUN mode or turn the power OFF and then ON again.

### 4-5-1 Changing the PC Setup

The PC Setup settings in DM 6600 to DM 6655 can be changed from a Programming Device. The CPM2B must be in PROGRAM mode in order to change the settings in DM 6600 to DM 6644. The settings in DM 6645 to DM 6655 can be changed in MONITOR or PROGRAM mode, but CPM2B's cycle time will be long if the settings are changed in MONITOR mode.

All of the PC Setup settings are set to their defaults when the CPM2B is shipped. The default values for the PC Setup are 0000 for all words (except for the low battery error enable in DM 6655 bits 12 to 15).

#### Effectiveness of Changes

PC Setup settings are accessed at various times depending on the setting, as described below.

Words	Timing
DM 6600 to DM 6614	Accessed only when PC's power supply is turned ON.
DM 6615 to DM 6644	Accessed only when program execution begins.
DM 6645 to DM 6655	Accessed regularly when the power is ON.

Since changes in the PC Setup become effective only at the times given above, the PC will have to be restarted to make changes in DM 6600 to DM 6614 effective.

tive, and program execution will have to be restarted to make changes in DM 6615 to DM 6644 effective.

**Errors in the PC Setup**

If an incorrect PC Setup setting is accessed, a non-fatal error (error code 9B) will be generated, the corresponding error flag (AR 1300 to AR 1302) will be turned ON, and the default setting will be used instead of the incorrect setting.

**4-5-2 PC Setup Settings**

Word(s)	Bit(s)	Function
<b>Startup Processing (DM 6600 to DM 6614)</b>		
The following settings are effective after transfer to the PC only after the PC is restarted.		
DM 6600	00 to 07	Startup mode (effective when bits 08 to 15 are set to 02). 00: PROGRAM; 01: MONITOR; 02: RUN
	08 to 15	Startup mode designation 00: According to communications switch SW201 and peripheral port connection (See table at the bottom of this page.) 01: Continue operating mode last used before power was turned OFF. 02: Setting in 00 to 07
DM 6601	00 to 07	Not used.
	08 to 11	IOM Hold Bit (SR 25212) Status at Startup 0: Reset to 0; 1: Maintain previous status
	12 to 15	Forced Status Hold Bit (SR 25211) Status at Startup 0: Reset to 0; 1: Maintain previous status
DM 6602	00 to 03	Program memory write-protection 0: Program memory unprotected 1: Program memory write-protected (except DM 6602 itself)
	04 to 07	Programming Console display language 0: English; 1: Japanese
	08 to 11	Expansion instruction function code assignments 0: Default settings 1: User assignments
	12 to 15	Not used.
DM 6603	00 to 15	Not used.
DM 6604	00 to 07	00: A memory error will not be generated if data could not be retained by the battery. 01: A memory error will be generated if data could not be retained by the battery.
	08 to 15	Not used.
DM 6605 to DM 6614	00 to 15	Not used.

**Note** The startup operating mode will be as shown in the following table is bits 08 to 15 of DM 6600 are set to 00.

Peripheral port connected to	Communications switch SW201	
	OFF	ON
Nothing	PROGRAM	RUN
Programming Console	Mode set on Programming Console mode switch	PROGRAM (The CPM2B will not be able to communicate with Programming Console.)
Other Programming Device	PROGRAM (The CPM2B will not be able to communicate with Programming Device.)	PROGRAM

Word(s)	Bit(s)	Function
<b>Cycle Time Settings (DM 6615 to DM 6619)</b>		
The following settings are effective after transfer to the PC the next time operation is started.		
DM 6615	00 to 15	Not used.

Word(s)	Bit(s)	Function
DM 6616	00 to 07	Servicing time for RS-232C port (Effective when bits 08 to 15 are set to 01.) 00 to 99 (BCD): Percentage of cycle time used to service RS-232C port.
	08 to 15	RS-232C port servicing setting enable 00: 5% of the cycle time 01: Use time in bits 00 to 07.
DM 6617	00 to 07	Servicing time for peripheral port (Effective when bits 08 to 15 are set to 01.) 00 to 99 (BCD): Percentage of cycle time used to service peripheral.
	08 to 15	Peripheral port servicing setting enable 00: 5% of the cycle time 01: Use time in bits 00 to 07.
DM 6618	00 to 07	Cycle monitor time (Effective when bits 08 to 15 are set to 01, 02, or 03.) 00 to 99 (BCD): Setting (See bits 08 to 15, below.)  A fatal error will be generated and PC operation will stop if the cycle time exceeds the cycle monitor time set here.
	08 to 15	Cycle monitor enable (Setting in 00 to 07 × units; 99 s max.) 00: 120 ms (setting in bits 00 to 07 disabled) 01: Setting units: 10 ms 02: Setting units: 100 ms 03: Setting units: 1 s
DM 6619	00 to 15	Minimum cycle time 0000: Variable (no minimum) 0001 to 9999 (BCD): Minimum time in ms
<b>Interrupt Processing (DM 6620 to DM 6639)</b>		
The following settings are effective after transfer to the PC the next time operation is started.		
DM 6620	00 to 03	Input time constant for IR 00000 to IR 00002 0: 10 ms; 1: 1 ms; 2: 2 ms; 3: 3 ms; 4: 5 ms; 5: 10 ms; 6: 20 ms; 7: 40 ms; 8: 80 ms
	04 to 07	Input time constant for IR 00003 and IR 00004 (Setting same as bits 00 to 03)
	08 to 11	Input time constant for IR 00005 and IR 00006 (Setting same as bits 00 to 03)
	12 to 15	Input time constant for IR 00007 to IR 00011 (Setting same as bits 00 to 03)
DM 6621	00 to 07	Input time constant for IR 001 00: 10 ms      01: 1 ms      02: 2 ms      03: 3 ms      04: 5 ms 05: 10 ms      06: 20 ms      07: 40 ms      08: 80 ms
	08 to 15	Input constant for IR 002 (Setting same as for IR 001.)
DM 6622	00 to 07	Input constant for IR 003 (Setting same as for IR 001.)
	08 to 15	Input constant for IR 004 (Setting same as for IR 001.)
DM 6623	00 to 07	Input constant for IR 005 (Setting same as for IR 001.)
	08 to 15	Input constant for IR 006 (Setting same as for IR 001.)
DM 6624	00 to 07	Input constant for IR 007 (Setting same as for IR 001.)
	08 to 15	Input constant for IR 008 (Setting same as for IR 001.)
DM 6625	00 to 07	Input constant for IR 009 (Setting same as for IR 001.)
	08 to 15	Not used.
DM 6626 to DM 6627	00 to 15	Not used.
DM 6628	00 to 03	Interrupt enable for IR 00003 (0: Normal input; 1: Interrupt input; 2: Quick-response)
	04 to 07	Interrupt enable for IR 00004 (0: Normal input; 1: Interrupt input; 2: Quick-response)
	08 to 11	Interrupt enable for IR 00005 (0: Normal input; 1: Interrupt input; 2: Quick-response)
	12 to 15	Interrupt enable for IR 00006 (0: Normal input; 1: Interrupt input; 2: Quick-response)
DM 6629	00 to 03	PV coordinate system for pulse output 0 0: Relative coordinates; 1: Absolute coordinates
	04 to 07	PV coordinate system for pulse output 1 0: Relative coordinates; 1: Absolute coordinates
	08 to 15	Not used.
DM 6630 to DM 6641	00 to 15	Not used.

Word(s)	Bit(s)	Function																																																																
<b>High-speed Counter Settings (DM 6642 to DM 6644)</b>																																																																		
The following settings are effective after transfer to the PC the next time operation is started.																																																																		
DM 6642	00 to 03	High-speed counter mode (Effective only when bits 08 to 15 are <b>not</b> set to 00.) 0: Differential phase mode (5 kHz) 1: Pulse + direction input mode (20 kHz) 2: Up/down input mode (20 kHz) 4: Increment mode (20 kHz)																																																																
	04 to 07	High-speed counter reset mode (Effective only when bits 08 to 15 are set to 01.) 0: Z phase and software reset; 1: Software reset only																																																																
	08 to 15	High-speed counter/Synchronized pulse control for IR 00000 to IR 00002 00: Don't use either function. 01: Use as high-speed counters. 02: Use for synchronized pulse control (10 to 500 Hz). 03: Use for synchronized pulse control (20 Hz to 1 kHz). 04: Use for synchronized pulse control (300 Hz to 20 kHz).																																																																
DM 6643, DM 6644	00 to 15	Not used.																																																																
<b>RS-232C Port Communications Settings</b>																																																																		
The following settings are effective after transfer to the PC.																																																																		
If CPU Board communications switch SW202 is ON, communications through the RS-232C port are governed by the default settings (all 0) regardless of the settings in DM 6645 through DM 6649.																																																																		
DM 6645	00 to 03	Port settings 0: Standard (1 start bit, 7 data bits, even parity, 2 stop bits, 9,600 bps, Host Link unit number: 0) 1: Settings in DM 6646 (Any other setting will cause a non-fatal error and AR 1302 will turn ON.)																																																																
	04 to 07	CTS control setting 0: Disable CTS control; 1: Enable CTS control (Any other setting will cause a non-fatal error and AR 1302 will turn ON.)																																																																
	08 to 11	Link words for 1:1 PC Link 0: LR 00 to LR 15 (Any other settings are ineffective.)																																																																
	12 to 15	Communications mode 0: Host Link; 1: No-protocol; 2: 1:1 PC Link Slave; 3: 1:1 PC Link Master; 4: NT Link (Any other setting causes a non-fatal error and turns ON AR 1302.)																																																																
DM 6646	00 to 07	Baud rate 00: 1,200 bps; 01: 2,400 bps; 02: 4,800 bps; 03: 9,600 bps; 04: 19,200 bps																																																																
	08 to 15	Frame format <table border="1"> <thead> <tr> <th></th> <th>Start bits</th> <th>Data bits</th> <th>Stop bits</th> <th>Parity</th> </tr> </thead> <tbody> <tr><td>00:</td><td>1 bit</td><td>7 bits</td><td>1 bit</td><td>Even</td></tr> <tr><td>01:</td><td>1 bit</td><td>7 bits</td><td>1 bit</td><td>Odd</td></tr> <tr><td>02:</td><td>1 bit</td><td>7 bits</td><td>1 bit</td><td>None</td></tr> <tr><td>03:</td><td>1 bit</td><td>7 bits</td><td>2 bits</td><td>Even</td></tr> <tr><td>04:</td><td>1 bit</td><td>7 bits</td><td>2 bits</td><td>Odd</td></tr> <tr><td>05:</td><td>1 bit</td><td>7 bits</td><td>2 bits</td><td>None</td></tr> <tr><td>06:</td><td>1 bit</td><td>8 bits</td><td>1 bit</td><td>Even</td></tr> <tr><td>07:</td><td>1 bit</td><td>8 bits</td><td>1 bit</td><td>Odd</td></tr> <tr><td>08:</td><td>1 bit</td><td>8 bits</td><td>1 bit</td><td>None</td></tr> <tr><td>09:</td><td>1 bit</td><td>8 bits</td><td>2 bits</td><td>Even</td></tr> <tr><td>10:</td><td>1 bit</td><td>8 bits</td><td>2 bits</td><td>Odd</td></tr> <tr><td>11:</td><td>1 bit</td><td>8 bits</td><td>2 bits</td><td>None</td></tr> </tbody> </table> (Any other setting specifies standard settings (1 start bit, 7 data bits; even parity, 2 stop bits), causes a non-fatal error, and turns ON AR 1302.)		Start bits	Data bits	Stop bits	Parity	00:	1 bit	7 bits	1 bit	Even	01:	1 bit	7 bits	1 bit	Odd	02:	1 bit	7 bits	1 bit	None	03:	1 bit	7 bits	2 bits	Even	04:	1 bit	7 bits	2 bits	Odd	05:	1 bit	7 bits	2 bits	None	06:	1 bit	8 bits	1 bit	Even	07:	1 bit	8 bits	1 bit	Odd	08:	1 bit	8 bits	1 bit	None	09:	1 bit	8 bits	2 bits	Even	10:	1 bit	8 bits	2 bits	Odd	11:	1 bit	8 bits	2 bits
	Start bits	Data bits	Stop bits	Parity																																																														
00:	1 bit	7 bits	1 bit	Even																																																														
01:	1 bit	7 bits	1 bit	Odd																																																														
02:	1 bit	7 bits	1 bit	None																																																														
03:	1 bit	7 bits	2 bits	Even																																																														
04:	1 bit	7 bits	2 bits	Odd																																																														
05:	1 bit	7 bits	2 bits	None																																																														
06:	1 bit	8 bits	1 bit	Even																																																														
07:	1 bit	8 bits	1 bit	Odd																																																														
08:	1 bit	8 bits	1 bit	None																																																														
09:	1 bit	8 bits	2 bits	Even																																																														
10:	1 bit	8 bits	2 bits	Odd																																																														
11:	1 bit	8 bits	2 bits	None																																																														
DM 6647	00 to 15	Transmission delay (0000 to 9999 BCD sets a delay of 0 to 99,990 ms.) (Any other setting specifies a delay of 0 ms, causes a non-fatal error, and turns ON AR 1302.)																																																																

Word(s)	Bit(s)	Function																																																																
DM 6648	00 to 07	Node number (Host Link) 00 to 31 (BCD) (Any other setting specifies a node number of 00, causes a non-fatal error, and turns ON AR 1302.)																																																																
	08 to 11	Start code selection for no-protocol communications 0: Disables start code; 1: Enables start code in DM 6649 (Any other setting disables the start code, causes a non-fatal error, and turns ON AR 1302.)																																																																
	12 to 15	End code selection for no-protocol communications 0: Disables end code; 1: Enables end code in DM 6649; 2: Sets end code of CR, LF. (Any other setting disables the end code, causes a non-fatal error, and turns ON AR 1302.)																																																																
DM 6649	00 to 07	Start code (00 to FF) (This setting is valid only when bits 8 to 11 of DM 6648 are set to 1.)																																																																
	08 to 15	When bits 12 to 15 of DM 6648 set to 0: Sets the number of bytes to receive. (00: 256 bytes; 01 to FF: 1 to 255 bytes) When bits 12 to 15 of DM 6648 set to 1: Sets the end code. (00 to FF)																																																																
<p><b>Peripheral Port Communications Settings</b></p> <p>The following settings are effective after transfer to the PC.</p> <p>If CPU Board Communications Switch SW202 is ON, communications through the peripheral port are governed by the default settings (all 0) regardless of the settings in DM 6650 through DM 6654. Communications through the peripheral port are governed by the Programming Console protocol if Communications Switch SW201 is OFF.</p>																																																																		
DM 6650	00 to 03	Port settings 00: Standard (1 start bit, 7 data bits, even parity, 2 stop bits, 9,600 bps, Host Link unit number: 0) 01: Settings in DM 6651 (Any other setting specifies standard settings, causes a non-fatal error, and turns ON AR 1302.)																																																																
	04 to 11	Not used.																																																																
	12 to 15	Communications mode 0: Host Link or peripheral bus; 1: No-protocol (Any other setting specifies Host Link, causes a non-fatal error, and turns ON AR 1302.)																																																																
DM 6651	00 to 07	Baud rate 00: 1,200 bps; 01: 2,400 bps; 02: 4,800 bps; 03: 9,600 bps; 04: 19,200 bps																																																																
	08 to 15	<p>Frame format</p> <table border="1"> <thead> <tr> <th></th> <th>Start bits</th> <th>Data bits</th> <th>Stop bits</th> <th>Parity</th> </tr> </thead> <tbody> <tr><td>00:</td><td>1 bit</td><td>7 bits</td><td>1 bit</td><td>Even</td></tr> <tr><td>01:</td><td>1 bit</td><td>7 bits</td><td>1 bit</td><td>Odd</td></tr> <tr><td>02:</td><td>1 bit</td><td>7 bits</td><td>1 bit</td><td>None</td></tr> <tr><td>03:</td><td>1 bit</td><td>7 bits</td><td>2 bits</td><td>Even</td></tr> <tr><td>04:</td><td>1 bit</td><td>7 bits</td><td>2 bits</td><td>Odd</td></tr> <tr><td>05:</td><td>1 bit</td><td>7 bits</td><td>2 bits</td><td>None</td></tr> <tr><td>06:</td><td>1 bit</td><td>8 bits</td><td>1 bit</td><td>Even</td></tr> <tr><td>07:</td><td>1 bit</td><td>8 bits</td><td>1 bit</td><td>Odd</td></tr> <tr><td>08:</td><td>1 bit</td><td>8 bits</td><td>1 bit</td><td>None</td></tr> <tr><td>09:</td><td>1 bit</td><td>8 bits</td><td>2 bits</td><td>Even</td></tr> <tr><td>10:</td><td>1 bit</td><td>8 bits</td><td>2 bits</td><td>Odd</td></tr> <tr><td>11:</td><td>1 bit</td><td>8 bits</td><td>2 bits</td><td>None</td></tr> </tbody> </table> <p>(Any other setting specifies standard settings (1 start bit, 7 data bits; even parity, 2 stop bits), causes a non-fatal error, and turns ON AR 1302.)</p>		Start bits	Data bits	Stop bits	Parity	00:	1 bit	7 bits	1 bit	Even	01:	1 bit	7 bits	1 bit	Odd	02:	1 bit	7 bits	1 bit	None	03:	1 bit	7 bits	2 bits	Even	04:	1 bit	7 bits	2 bits	Odd	05:	1 bit	7 bits	2 bits	None	06:	1 bit	8 bits	1 bit	Even	07:	1 bit	8 bits	1 bit	Odd	08:	1 bit	8 bits	1 bit	None	09:	1 bit	8 bits	2 bits	Even	10:	1 bit	8 bits	2 bits	Odd	11:	1 bit	8 bits	2 bits
	Start bits	Data bits	Stop bits	Parity																																																														
00:	1 bit	7 bits	1 bit	Even																																																														
01:	1 bit	7 bits	1 bit	Odd																																																														
02:	1 bit	7 bits	1 bit	None																																																														
03:	1 bit	7 bits	2 bits	Even																																																														
04:	1 bit	7 bits	2 bits	Odd																																																														
05:	1 bit	7 bits	2 bits	None																																																														
06:	1 bit	8 bits	1 bit	Even																																																														
07:	1 bit	8 bits	1 bit	Odd																																																														
08:	1 bit	8 bits	1 bit	None																																																														
09:	1 bit	8 bits	2 bits	Even																																																														
10:	1 bit	8 bits	2 bits	Odd																																																														
11:	1 bit	8 bits	2 bits	None																																																														



Word(s)	Bit(s)	Function
DM 6652	00 to 15	Transmission delay (0000 to 9999 BCD sets a delay of 0 to 99,990 ms.) (Any other setting specifies a delay of 0 ms, causes a non-fatal error, and turns ON AR 1302.)
DM 6653	00 to 07	Node number (Host Link) 00 to 31 (BCD) (Any other setting specifies a node number of 00, causes a non-fatal error, and turns ON AR 1302.)
	08 to 11	Start code selection for no-protocol communications 0: Disables start code; 1: Enables start code in DM 6654 (Any other setting disables the start code, causes a non-fatal error, and turns ON AR 1302.)
	12 to 15	End code selection for no-protocol communications 0: Disables end code; 1: Enables end code in DM 6654; 2: Sets end code of CR, LF. (Any other setting disables the end code, causes a non-fatal error, and turns ON AR 1302.)
DM 6654	00 to 07	Start code (00 to FF) (This setting is valid only when bits 8 to 11 of DM 6653 are set to 1.)
	08 to 15	When bits 12 to 15 of DM 6653 set to 0: Sets the number of bytes to receive. (00: 256 bytes; 01 to FF: 1 to 255 bytes) When bits 12 to 15 of DM 6653 set to 1: Sets the end code. (00 to FF)
<b>Error Log Settings (DM 6655)</b>		
The following settings are effective after transfer to the PC.		
DM 6655	00 to 03	Style 0: Shift after 7 records have been stored 1: Store only first 7 records (no shifting) 2 to F: Do not store records
	04 to 07	Not used.
	08 to 11	Cycle time monitor enable 0: Generate a non-fatal error for a cycle time that is too long. 1: Do not generate a non-fatal error.
	12 to 15	Low battery error enable 0: Generate a non-fatal error for low battery voltage. 1: Do not generate a non-fatal error.  Low battery error detection is disabled (i.e., set to 1) by default in CPU Boards that do not have a clock. If the PC Setup is cleared, the setting will be changed to 0 and a low battery error will occur.

## 4-6 Error Log

The error log function registers the error code of any fatal or non-fatal error that occurs in the PC. The date and time at which the error occurred are registered along with the error code. The error code is also stored in AR 253.

The error log is stored in DM 2000 through DM 2021. Up to 7 error records can be stored.

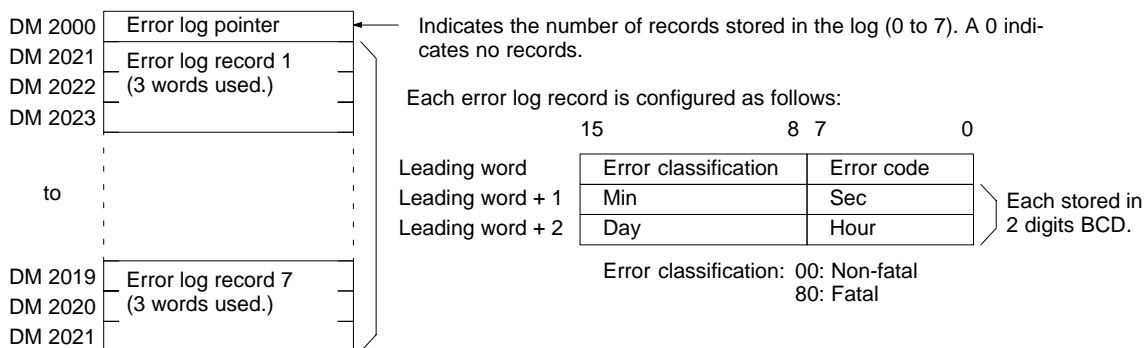

- Note** 1. An error record with an error code of 00 will be stored in the error log for power interruptions. Refer to 7-3 *Self-diagnostic Functions* for tables listing error codes.

2. In CPU Boards without a clock, the time that the error occurred will be set to all zeroes.

### Error Log Storage Methods

The error log storage method is set in the PC Setup (bits 00 to 03 of DM 6655). Set any of the following methods.

- 1, 2, 3... 1. DM 6655 bits 00 to 03 set to 0:  
Stores the most recent 7 error log records and discard older records. This is achieved by shifting the records as shown below so that the oldest record (record 0) is lost whenever a new record is generated.

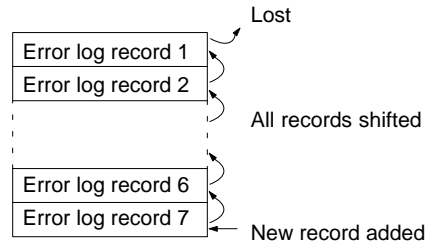

2. DM 6655 bits 00 to 03 set to 1:  
Stores only the first 7 error log records, and ignores any subsequent errors beyond those 7.
3. DM 6655 bits 00 to 03 set to any value other than 0 or 1:  
Disables the log so that no records are stored.

The default setting is the first method. Refer to the preceding page for details on the error log settings in DM 6655.

### Clearing the Error Log

To clear the entire error log, turn ON SR 25214 from a Programming Device. (After the error log has been cleared, SR 25214 will turn OFF again automatically.)

# SECTION 5

## Instruction Set

The CPM2B PCs have large a programming instruction set that allows for easy programming of complicated control processes. This section provides a brief summary of the instruction set.

5-1	CPM2B Function Codes .....	72
5-2	Alphabetic List by Mnemonic .....	73
5-3	Expansion Instructions .....	76

## 5-1 CPM2B Function Codes

The following table lists the CPM2B instructions that have fixed function codes. Each instruction is listed by mnemonic and by instruction name. Use the numbers in the leftmost column as the left digit and the number in the column heading as the right digit of the function code.

Left digit	Right digit									
	0	1	2	3	4	5	6	7	8	9
0	NOP NO OPERATION	END END	IL INTERLOCK	ILC INTERLOCK CLEAR	JMP JUMP	JME JUMP END	(@) FAL FAILURE ALARM AND RESET	FALS SEVERE FAILURE ALARM	STEP STEP DEFINE	SNXT STEP START
1	SFT SHIFT REGISTER	KEEP KEEP	CNTR REVERSIBLE COUNTER	DIFU DIFFERENTIATE UP	DIFD DIFFERENTIATE DOWN	TIMH HIGH-SPEED TIMER	(@) WSFT WORD SHIFT	(@) ASFT ASYNCHRONOUS SHIFT REGISTER	---	---
2	CMP COMPARE	(@) MOV MOVE	(@) MVN MOVE NOT	(@) BIN BCD TO BINARY	(@) BCD BINARY TO BCD	(@) ASL SHIFT LEFT	(@) ASR SHIFT RIGHT	(@) ROL ROTATE LEFT	(@) ROR ROTATE RIGHT	(@) COM COMPLEMENT
3	(@) ADD BCD ADD	(@) SUB BCD SUBTRACT	(@) MUL BCD MULTIPLY	(@) DIV BCD DIVIDE	(@) ANDW LOGICAL AND	(@) ORW LOGICAL OR	(@) XORW EXCLUSIVE OR	(@) XNRW EXCLUSIVE NOR	(@) INC INCREMENT	(@) DEC DECREMENT
4	(@) STC SET CARRY	(@) CLC CLEAR CARRY	---	---	---	---	(@) MSG MESSAGE DISPLAY	(@) RXD RECEIVE	(@) TXD TRANSMIT	---
5	(@) ADB BINARY ADD	(@) SBB BINARY SUBTRACT	(@) MLB BINARY MULTIPLY	(@) DVB BINARY DIVIDE	(@) ADDL DOUBLE BCD ADD	(@) SUBL DOUBLE BCD SUBTRACT	(@) MULL DOUBLE BCD MULTIPLY	(@) DIVL DOUBLE BCD DIVIDE	(@) BINL DOUBLE BCD-TO-DOUBLE BINARY	(@) BCDL DOUBLE BINARY-TO-DOUBLE BCD
6	CMPL DOUBLE COMPARE	(@) INI MODE CONTROL	(@) PRV HIGH-SPEED COUNTER PV READ	(@) CTBL COMPARISON TABLE LOAD	(@) SPED SPEED OUTPUT	(@) PULS SET PULSES	(@) SCL SCALING	(@) BCNT BIT COUNTER	(@) BCMP BLOCK COMPARE	(@) STIM INTERVAL TIMER
7	(@) XFER BLOCK TRANSFER	(@) BSET BLOCK SET	---	(@) XCHG DATA EXCHANGE	(@) SLD ONE DIGIT SHIFT LEFT	(@) SRD ONE DIGIT SHIFT RIGHT	(@) MLPX 4-TO-16 DECODER	(@) DMPX 16-TO-4 ENCODER	(@) SDEC 7-SEGMENT DECODER	---
8	(@) DIST SINGLE WORD DISTRIBUTE	(@) COLL DATA COLLECT	(@) MOVb MOVE BIT	(@) MOVD MOVE DIGIT	(@) SFTR REVERSIBLE SHIFT REGISTER	(@) TCMP TABLE COMPARE	(@) ASC ASCII CONVERT	---	---	(@) INT INTERRUPT CONTROL
9	---	(@) SBS SUBROUTINE ENTRY	SBN SUBROUTINE DEFINE	RET SUBROUTINE RETURN	---	---	---	(@) IORF I/O REFRESH	---	(@) MCRO MACRO

- Note**
1. The shaded areas are function codes to which expansion instructions are allocated by default or to which the user can allocate expansion instructions. Refer to *5-3 Expansion Instructions* for more details.
  2. Instruction execution times are the same as those for the CPM2A and CPM2C. Refer to the *Programming Manual (W353)* for details.

## 5-2 Alphabetic List by Mnemonic

Dashes (“—”) in the *Code* column indicate expansion instructions, which do not have fixed function codes. “None” indicates instructions for which function codes are not used.

Mnemonic	Code	Words	Name
ACC (@)	—	4	ACCELERATION CONTROL
ADB (@)	50	4	BINARY ADD
ADD (@)	30	4	BCD ADD
ADDL (@)	54	4	DOUBLE BCD ADD
AND	None	1	AND
AND LD	None	1	AND LOAD
AND NOT	None	1	AND NOT
ANDW (@)	34	4	LOGICAL AND
ASC (@)	86	4	ASCII CONVERT
ASFT(@)	17	4	ASYNCHRONOUS SHIFT REGISTER
ASL (@)	25	2	ARITHMETIC SHIFT LEFT
ASR (@)	26	2	ARITHMETIC SHIFT RIGHT
AVG	—	4	AVERAGE VALUE
BCD (@)	24	3	BINARY TO BCD
BCDL (@)	59	3	DOUBLE BINARY-TO-DOUBLE BCD
BCMP (@)	68	4	BLOCK COMPARE
BCNT (@)	67	4	BIT COUNTER
BIN (@)	23	3	BCD-TO-BINARY
BINL (@)	58	3	DOUBLE BCD-TO-DOUBLE BINARY
BSET (@)	71	4	BLOCK SET
CLC (@)	41	1	CLEAR CARRY
CMP	20	3	COMPARE
CMPL	60	4	DOUBLE COMPARE
CNT	None	2	COUNTER
CNTR	12	3	REVERSIBLE COUNTER
COLL (@)	81	4	DATA COLLECT
COM (@)	29	2	COMPLEMENT
CTBL(@)	63	4	COMPARISON TABLE LOAD
DEC (@)	39	2	BCD DECREMENT
DIFD	14	2	DIFFERENTIATE DOWN
DIFU	13	2	DIFFERENTIATE UP
DIST (@)	80	4	SINGLE WORD DISTRIBUTE
DIV (@)	33	4	BCD DIVIDE
DIVL (@)	57	4	DOUBLE BCD DIVIDE
DMPX (@)	77	4	16-TO-4 ENCODER
DVB (@)	53	4	BINARY DIVIDE
END	01	1	END
FAL (@)	06	2	FAILURE ALARM AND RESET
FALS	07	2	SEVERE FAILURE ALARM
FCS (@)	—	4	FCS CALCULATE
HEX (@)	—	4	ASCII-TO-HEXADECIMAL
HMS	—	4	SECONDS TO HOURS
IL	02	1	INTERLOCK
ILC	03	1	INTERLOCK CLEAR

Mnemonic	Code	Words	Name
INC (@)	38	2	INCREMENT
INI (@)	61	4	MODE CONTROL
INT (@)	89	4	INTERRUPT CONTROL
IORF (@)	97	3	I/O REFRESH
JME	05	2	JUMP END
JMP	04	2	JUMP
KEEP	11	2	KEEP
LD	None	1	LOAD
LD NOT	None	1	LOAD NOT
MAX (@)	—	4	FIND MAXIMUM
MCRO (@)	99	4	MACRO
MIN (@)	—	4	FIND MINIMUM
MLB (@)	52	4	BINARY MULTIPLY
MLPX (@)	76	4	4-TO-16 DECODER
MOV (@)	21	3	MOVE
MOVB (@)	82	4	MOVE BIT
MOVD (@)	83	4	MOVE DIGIT
MSG (@)	46	2	MESSAGE
MUL (@)	32	4	BCD MULTIPLY
MULL (@)	56	4	DOUBLE BCD MULTIPLY
MVN (@)	22	3	MOVE NOT
NEG (@)	—	4	2'S COMPLEMENT
NOP	00	1	NO OPERATION
OR	None	1	OR
OR LD	None	1	OR LOAD
OR NOT	None	1	OR NOT
ORW (@)	35	4	LOGICAL OR
OUT	None	2	OUTPUT
OUT NOT	None	2	OUTPUT NOT
PID	—	4	PID CONTROL
PRV (@)	62	4	HIGH-SPEED COUNTER PV READ
PULS (@)	65	4	SET PULSES
PWM (@)	—	4	PULSE WITH VARIABLE DUTY RATIO
RET	93	1	SUBROUTINE RETURN
ROL (@)	27	2	ROTATE LEFT
ROR (@)	28	2	ROTATE RIGHT
RSET	None	2	RESET
RXD (@)	47	4	RECEIVE
SBB (@)	51	4	BINARY SUBTRACT
SBN	92	2	SUBROUTINE DEFINE
SBS (@)	91	2	SUBROUTINE ENTRY
SCL (@)	66	4	SCALING
SCL2 (@)	—	4	SIGNED BINARY TO BCD SCALING
SCL3 (@)	—	4	BCD TO SIGNED BINARY SCALING
SDEC (@)	78	4	7-SEGMENT DECODER
SEC	—	4	HOURS TO SECONDS
SET	None	2	SET
SFT	10	3	SHIFT REGISTER
SFTR (@)	84	4	REVERSIBLE SHIFT REGISTER

Mnemonic	Code	Words	Name
SLD (@)	74	3	ONE DIGIT SHIFT LEFT
SNXT	09	2	STEP START
SPED (@)	64	4	SPEED OUTPUT
SRCH (@)	—	4	DATA SEARCH
SRD (@)	75	3	ONE DIGIT SHIFT RIGHT
STC (@)	40	1	SET CARRY
STEP	08	2	STEP DEFINE
STIM (@)	69	4	INTERVAL TIMER
STUP	—	3	CHANGE RS-232C SETUP
SUB (@)	31	4	BCD SUBTRACT
SUBL (@)	55	4	DOUBLE BCD SUBTRACT
SUM (@)	—	4	SUM
SYNC (@)	—	4	SYNCHRONIZED PULSE CONTROL
TCMP (@)	85	4	TABLE COMPARE
TIM	None	2	TIMER
TIMH	15	3	HIGH-SPEED TIMER
TIML	—	4	LONG TIMER
TMHH	—	4	VERY HIGH-SPEED TIMER
TXD (@)	48	4	TRANSMIT
WSFT (@)	16	3	WORD SHIFT
XCHG (@)	73	3	DATA EXCHANGE
XFER (@)	70	4	BLOCK TRANSFER
XNRW (@)	37	4	EXCLUSIVE NOR
XORW (@)	36	4	EXCLUSIVE OR
ZCP	—	4	AREA RANGE COMPARE
ZCPL	—	4	DOUBLE AREA RANGE COMPARE

## 5-3 Expansion Instructions

A set of expansion instructions is provided to aid in special programming needs. Function codes can be assigned to up to 18 of the expansion instructions to enable using them in programs. This allows the user to pick the instructions needed by each program to more effectively use the function codes required to input instructions.

The mnemonics of expansion instructions are followed by “(—)” as the function code to indicate that they must be assigned function codes by the user in the instructions table before they can be used in programming (unless they are used under their default settings).

Refer to the *6-2-5 Assigning Expansion Instruction Function Codes* for a description of the Programming Console operations used to change expansion instruction allocations.

Refer to the *SYSMAC Support Software Operation Manuals: C-series PCs (W248)*, the *SYSMAC-CPT Support Software User Manual (W333)*, or the *WS02-CXPC1-E CX-Programmer User Manual (W361)* for a description of the corresponding Support Software operations.

### Function Codes for Expansion Instructions

The following 18 function codes can be used for expansion instructions: 17, 18, 19, 47, 48, 60, 61, 62, 63, 64, 65, 66, 67, 68, 69, 87, 88, and 89

The 35 expansion instructions that can be used are listed below, along with the default function codes that are assigned when the CPM2B is shipped.

Mnemonic	Code
ASFT (@)	17
(open)	18
(open)	19
RXD (@)	47
TXD (@)	48
CMPL	60
INI (@)	61
PRV (@)	62
CTBL (@)	63
SPED (@)	64
PULS (@)	65
SCL (@)	66
BCNT (@)	67

Mnemonic	Code
BCMP (@)	68
STIM (@)	69
(open)	87
(open)	88
INT (@)	89
ACC (@)	---
AVG	---
FCS (@)	---
HEX (@)	---
HMS (@)	---
MAX (@)	---
MIN (@)	---
NEG (@)	---

Mnemonic	Code
PID	---
PWM (@)	---
SCL2 (@)	---
SCL3 (@)	---
SEC (@)	---
SRCH (@)	---
STUP (@)	---
SUM (@)	---
SYNC (@)	---
TIML	---
TMHH	---
ZCP	---
ZCPL	---



# SECTION 6

## Using Programming Devices

This section outlines the operations possible with the Programming Consoles.

6-1	Using a Programming Console . . . . .	78
6-1-1	Compatible Programming Consoles . . . . .	78
6-1-2	Changing the CPM2B's Mode with the Mode Switch . . . . .	80
6-1-3	Connecting the Programming Console . . . . .	81
6-1-4	Preparation for Operation . . . . .	82
6-1-5	Entering the Password . . . . .	83
6-2	Programming Console Operations . . . . .	84
6-2-1	Overview . . . . .	84
6-2-2	Clearing Memory . . . . .	85
6-2-3	Reading/Clearing Error Messages . . . . .	86
6-2-4	Buzzer Operation . . . . .	86
6-2-5	Assigning Expansion Instruction Function Codes . . . . .	87
6-2-6	Setting and Reading a Program Memory Address and Monitoring I/O Bit Status . . . . .	88
6-2-7	Entering or Editing Programs . . . . .	88
6-2-8	Instruction Search . . . . .	91
6-2-9	Bit Operand Search . . . . .	92
6-2-10	Inserting and Deleting Instructions . . . . .	93
6-2-11	Checking the Program . . . . .	94
6-2-12	Bit, Digit, Word Monitor . . . . .	94
6-2-13	Differentiation Monitor . . . . .	96
6-2-14	Binary Monitor . . . . .	97
6-2-15	Three-Word Monitor . . . . .	98
6-2-16	Signed Decimal Monitor . . . . .	98
6-2-17	Unsigned Decimal Monitor . . . . .	99
6-2-18	Three-Word Data Modification . . . . .	99
6-2-19	Changing Timer, Counter SV . . . . .	100
6-2-20	Hexadecimal, BCD Data Modification . . . . .	101
6-2-21	Binary Data Modification . . . . .	101
6-2-22	Signed Decimal Data Modification . . . . .	102
6-2-23	Unsigned Decimal Data Modification . . . . .	103
6-2-24	Force Set, Reset . . . . .	104
6-2-25	Clear Force Set/Reset . . . . .	104
6-2-26	Hex-ASCII Display Change . . . . .	105
6-2-27	Displaying the Cycle Time . . . . .	105
6-2-28	Reading and Setting the Clock . . . . .	106
6-3	Programming Example . . . . .	106
6-3-1	Preparatory Operations . . . . .	106
6-3-2	Example Program . . . . .	108
6-3-3	Programming Procedures . . . . .	109
6-3-4	Checking the Program . . . . .	111
6-3-5	Test Run in MONITOR Mode . . . . .	112

## 6-1 Using a Programming Console

This section provides information on connecting and using a Programming Console.

### 6-1-1 Compatible Programming Consoles

There are two Programming Consoles that can be used with the CPM2B: The CQM1-PRO01-E and the C200H-PRO27-E. The key functions for these Programming Consoles are identical.

Press and hold the Shift Key to input a letter shown in the upper-left corner of the key or the upper function of a key that has two functions. For example, the CQM1-PRO01-E's AR/HR Key can specify either the AR or HR Area; press and release the Shift Key and then press the AR/HR Key to specify the AR Area.

#### CQM1-PRO01-E

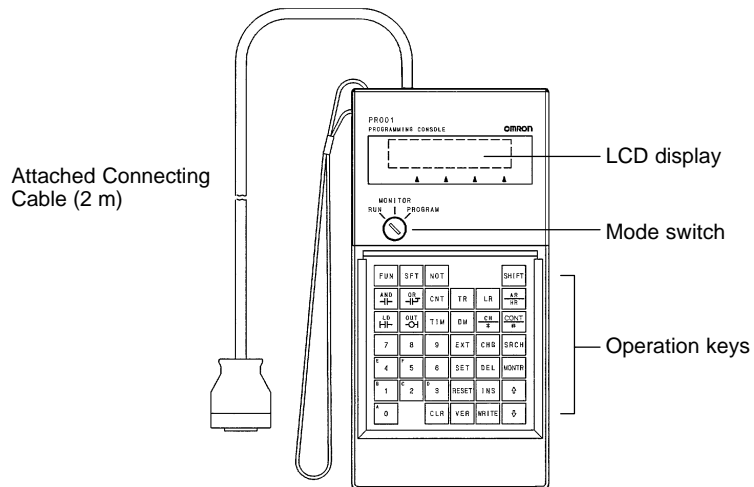



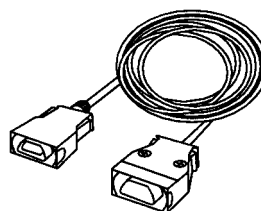
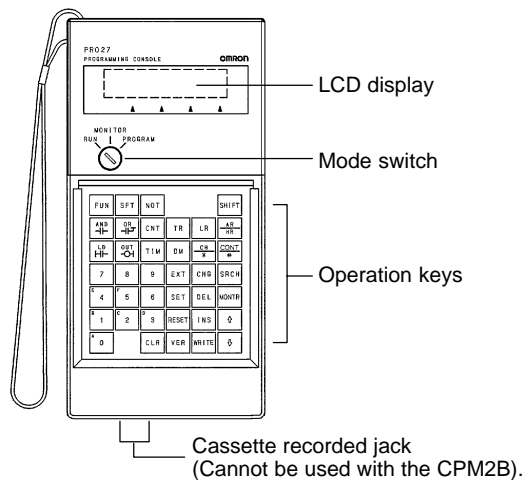



#### C200H-PRO27-E



Connecting Cables  
 C200H-CN222 (2 m)  
 C200H-CN422 (4 m)

**Different Keys**

The following keys are labeled differently on the CQM1-PRO01-E and the C200H-PRO27-E, but the operation of the keys in each pair is identical.

CQM1-PRO01-E Keys	C200H-PRO27-E Keys
	
	
	

**Note** To specify the AR area, use SHIFT and HR Keys for the C200H-PRO27-E and use SHIFT and AR/HR Keys for the CQM1-PRO01-E.

A shift symbol will be displayed in the upper-right corner of the screen when the Shift Key is pressed. The shift input can be cleared by pressing the Shift Key again.



**Mode Switch**

The mode switch controls the CPM2B's operating mode. The key can be removed when the switch is set to RUN or MONITOR but it cannot be removed when the switch is set to PROGRAM.

**Contrast Control**

The display contrast can be adjusted with the control on the right side of the Programming Console.

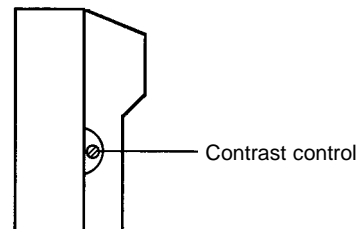

**Buzzer Volume**

The C200H-PRO27-E's buzzer volume can be adjusted with the lever on the right side of the Programming Console. The CQM1-PRO01-E's buzzer volume cannot be adjusted.

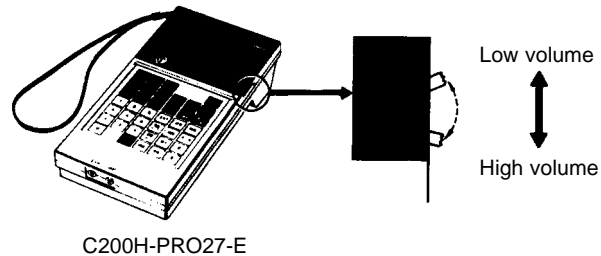

**Note** The buzzer volume can be turned on and off with a key operation. See 6-2-4 *Buzzer Operation* for details.

## 6-1-2 Changing the CPM2B's Mode with the Mode Switch

Once the Programming Console has been connected, its mode switch can be used to change the CPM2B's operating mode. The mode display (<PROGRAM>, <MONITOR>, or <RUN>) will appear on the Programming Console screen.

- No key operations can be performed while the mode display is displayed on the Programming Console screen. Press CLR to clear the display so that key operations can be performed.
- If the SHIFT Key is pressed while the mode switch is turned, the original display will remain on the Programming Console's screen and the mode display won't appear.
- The CPM2B will enter RUN mode automatically if a Programming Console isn't connected when the CPM2B is turned on.

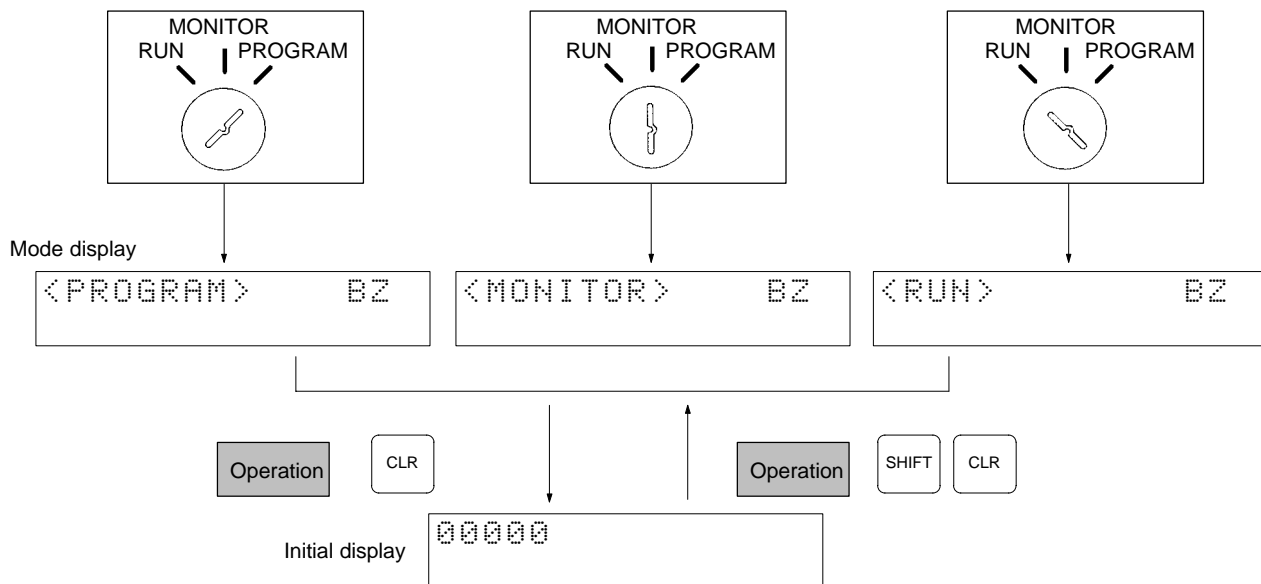

### Operating Modes

#### PROGRAM Mode

The CPM2B program isn't executed in PROGRAM mode. Use PROGRAM mode to create and edit the program, clear memory, or check the program for errors, or check output wiring.

#### MONITOR Mode

The CPM2B program is executed in MONITOR mode and I/O is processed just as it is in RUN mode. Use MONITOR mode to test system operations, such as monitoring CPM2B operating status, force-setting and resetting I/O bits, changing the SV/PV of timers and counters, changing word data, and online editing.

#### RUN Mode

This is the CPM2B's normal operating mode. The CPM2B's operating status can be monitored from a Programming Device, but bits can't be force-set/force-reset and the SV/PV of timers and counters can't be changed.

**Caution** Check the system thoroughly before changing the operating mode of the PC to prevent any accidents that might occur when the program is first started.

**Caution** Never change the mode while pressing any of the keys.

**Startup Operating Mode**

The operating mode of the CPM2B when the power is turned ON depends upon the PC Setup setting in DM 6600 and the Programming Console's mode switch setting if the Programming Console is connected.

PC Setup setting (DM 6600)	Programming Console connected	Programming Console not connected
00xx	The startup mode determined by the mode switch setting.	RUN mode if no Programming Device is connected. PROGRAM mode if another Programming Device is connected.
01xx	The startup mode is the same as the operating mode before power was interrupted.	
0200	PROGRAM mode	
0201	MONITOR mode	
0202	RUN mode	

**Note** The default setting is 00xx. With this default setting, the PC will automatically enter RUN mode if a Programming Console is not connected and SW201 is ON. Be sure that it is safe for the PC to operate before turning it ON under these conditions.

**6-1-3 Connecting the Programming Console**

Connect the Programming Console's connecting cable to the CPM2B's peripheral port, as shown below.

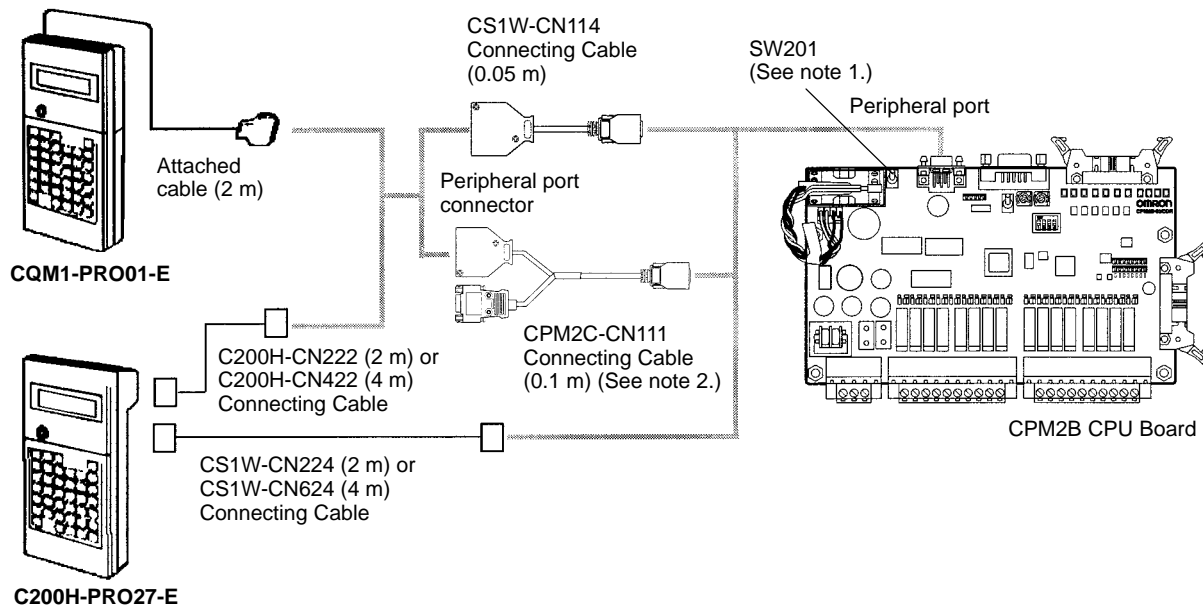

- Note**
1. Always turn OFF SW 201 before connecting the Programming Console.
  2. Only the peripheral port connector can be used when a CPM2C-CN111 Connecting Cable is connected.

**Panel Installation**

The C200H-PRO27-E Programming Console can be installed in a control panel as shown in the following diagram. (The C200H-ATT01 Mounting Bracket is sold separately.)

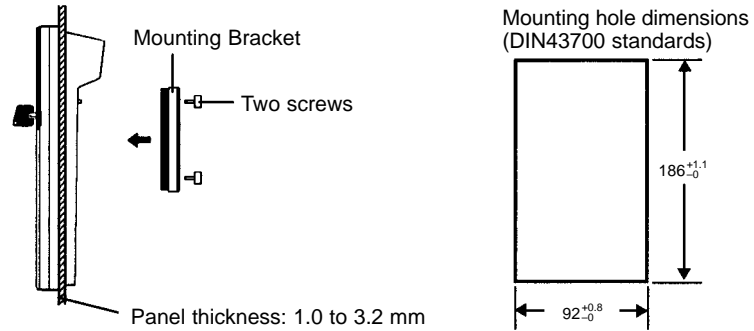

Allow at least 80 mm for the cable connector above the Programming Console.

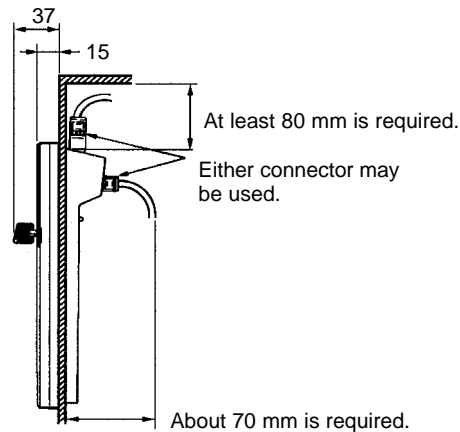
**6-1-4 Preparation for Operation**

This section describes the procedures required to begin Programming Console operation when using the Programming Console for the first time.

**Caution**

Always confirm that the Programming Console is in PROGRAM mode when turning ON the PC with a Programming Console connected unless another mode is desired for a specific purpose. If the Programming Console is in RUN mode when PC power is turned ON, any program in Program Memory will be executed, possibly causing a PC-controlled system to begin operation.

The following sequence of operations must be performed before beginning initial program input.

- 1, 2, 3...**
1. Be sure that the PC is OFF.
  2. Connect the Programming Console to the CPU Board's peripheral port. See *6-1-3 Connecting the Programming Console* for details. (The CPU Board's Communications Switch setting has no effect on communications with the Programming Console.)
  3. Set the mode switch to PROGRAM mode.
  4. Turn ON the PC.
  5. Enter the password. See *6-1-5 Entering the Password* for details.
  6. Clear (All Clear) the PC's memory. See *6-2-2 Clearing Memory* for details.
  7. Read and clear all errors and messages. See *6-2-3 Reading/Clearing Error Messages* for details.

8. Start programming.

### 6-1-5 Entering the Password

To gain access to the PC's programming functions, you must first enter the password. The password prevents unauthorized access to the program.

The PC prompts you for a password when PC power is turned on or, if PC power is already on, after the Programming Console has been connected to the PC. To gain access to the system when the "Password!" message appears, press CLR and then MONTR. Then press CLR to clear the display.

If the Programming Console is connected to the PC when PC power is already on, the first display below will indicate the mode the PC was in before the Programming Console was connected. **Ensure that the PC is in PROGRAM mode before you enter the password.** When the password is entered, the PC will shift to the mode set on the mode switch, causing PC operation to begin if the mode is set to RUN or MONITOR. The mode can be changed to RUN or MONITOR with the mode switch after entering the password.

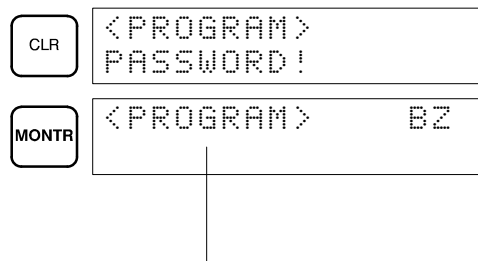

Indicates the mode set by the mode selector switch.

## 6-2 Programming Console Operations

### 6-2-1 Overview

The following table lists the programming and monitoring operations that can be performed from a Programming Console. Refer to the rest of this section for details on operational procedures.

Name	Function	Page
<b>Clearing memory</b>	Clears all or part of the Program Memory and any data areas that are not read-only, as well as the contents of the Programming Console's memory.	85
<b>Reading/clearing error messages</b>	Displays and clears error messages and displays MESSAGE instruction messages.	86
<b>Buzzer operation</b>	Turns on and off the buzzer that sounds when Programming Console keys are pressed.	86
<b>Assigning expansion instruction function codes</b>	Reads or changes the function codes assigned to expansion instructions	87
<b>Setting a program memory address</b>	Sets the specified program memory address when reading, writing, inserting and deleting programs.	88
<b>Reading a program memory address</b>	Reads the contents of the Program Memory. Displays the status of the currently displayed bit in PROGRAM and MONITOR modes.	88
<b>Instruction search</b>	Finds occurrences of the specified instruction in the program.	91
<b>Bit operand search</b>	Finds occurrences of the specified operand bit in the program.	92
<b>Inserting and deleting instructions</b>	Inserts or deletes instructions from the program.	93
<b>Entering or editing programs</b>	Overwrites the contents of the current Program Memory to either input a program for the first time or to change a program that already exists.	88
<b>Checking the program</b>	Checks for programming errors and displays the program address and error when errors are found.	94
<b>Bit, digit, word monitor</b>	Monitors the status of up to 16 bits and words, although only 3 can be shown on the display at one time.	94
<b>Multiple address monitor</b>	Monitors the status of up to 6 bits and words simultaneously.	96
<b>Differentiation monitor</b>	Monitors the up or down differentiation status of a particular bit.	96
<b>Binary monitor</b>	Monitors the ON/OFF status of any word's 16 bits.	97
<b>Three-word monitor</b>	Monitors the status of three consecutive words.	98
<b>Signed decimal monitor</b>	Converts the contents of the specified word from signed hexadecimal (two's complement format) to signed decimal for display.	98
<b>Unsigned decimal monitor</b>	Converts hexadecimal data in a word to unsigned decimal for display.	99
<b>3-word data modification</b>	Changes the contents of one or more of the 3 consecutive words displayed in the 3-Word Monitor operation.	99
<b>Changing timer, counter SV 1</b>	Changes the SV of a timer or counter.	100
<b>Changing timer, counter SV 2</b>	Makes fine adjustment changes to the SV of the timer or counter.	100
<b>Hexadecimal, BCD data modification</b>	Changes the BCD or hexadecimal value of a word being monitored.	101
<b>Binary data modification</b>	Changes the status of a word's bits when the word is being monitored.	101
<b>Signed decimal data modification</b>	Changes the decimal value of a word being monitored as signed decimal data, within a range of -32,768 to 32,767. The contents of the specified word are converted automatically to signed hexadecimal (two's complement format.)	102
<b>Unsigned decimal data modification</b>	Changes the decimal value of a word being monitored as unsigned decimal data, within a range of 0 to 65,535. A change into hexadecimal data is made automatically.	103
<b>Force set/reset</b>	Forces bits ON (force set) or OFF (force reset.)	104
<b>Clear force set/reset</b>	Restores the status of all bits which have been force set of reset.	104
<b>Hex-ASCII display change</b>	Converts word data displays back and forth between 4-digit hexadecimal data and ASCII.	105



Name	Function	Page
Displaying the cycle time	Displays the current average cycle time (scan time.)	105
Reading and setting the clock	Reads or sets the internal clock.	106

### 6-2-2 Clearing Memory

This operation is used to clear all or part of the Program Memory and data areas, as well as the contents of the Programming Console's memory. This operation is possible in PROGRAM mode only.

RUN	MONITOR	PROGRAM
No	No	OK

Before beginning to program for the first time or when installing a new program, clear all areas.

#### All Clear

The following procedure is used to clear memory completely, including the program, all data areas, counter PVs, Data Memory, and the PC Setup (DM 6600 to DM 6655).

- 1, 2, 3... 1. Bring up the initial display by pressing the CLR Key repeatedly.
2. Press the SET, NOT, and then the RESET Key to begin the operation.

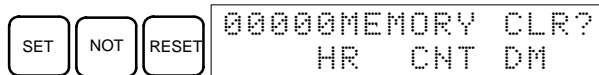

3. Press the MONTR Key to clear memory completely.

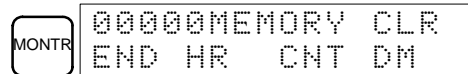

**Caution** The PC Setup (DM 6600 through DM 6655) will be cleared when this operation is performed.

#### Partial Clear

It is possible to retain the data in specified areas or part of the Program Memory. To retain the data in the HR, TC, or DM Areas, press the appropriate key after pressing SET, NOT, and RESET. Any data area that still appears on the display will be cleared when the MONTR Key is pressed.

The HR Key is used to specify both the AR and HR Areas, the CNT Key is used to specify the entire timer/counter area, and the DM Key is used to specify the DM Area.

It is also possible to retain a portion of the Program Memory from the first memory address to a specified address. After designating the data areas to be retained, specify the first Program Memory address to be cleared. For example, input 030 to leave addresses 000 to 029 untouched, but to clear addresses from 030 to the end of Program Memory.

As an example, follow the procedure below to retain the timer/counter area and Program Memory addresses 000 through 122:

- 1, 2, 3... 1. Press the CLR Key to bring up the initial display.
2. Press the SET, NOT, and then the RESET Key to begin the operation.
3. Press the CNT Key to remove the timer/counter area from the data areas shown on the display. (Counter PVs will not be cleared.)

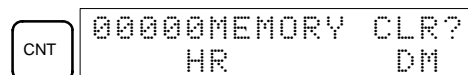

4. Press 123 to specify 123 as the starting program address.

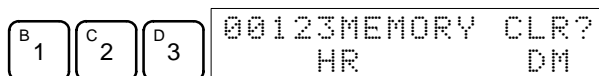

5. Press the MONTR Key to clear the specified regions of memory.



### 6-2-3 Reading/Clearing Error Messages

This operation is used to display and clear error messages. It is possible to display and clear non-fatal errors and MESSAGE instruction messages in any mode, but fatal errors can be cleared in PROGRAM mode only.

RUN	MONITOR	PROGRAM
OK	OK	OK

Before inputting a new program, any error messages recorded in memory should be cleared. It is assumed here that the causes of any of the errors for which error messages appear have already been taken care of. If the buzzer sounds when an attempt is made to clear an error message, eliminate the cause of the error, and then clear the error message. (Refer to *Section 7 Test Runs and Error Processing* for troubleshooting information.)

#### Key Sequence

Follow the procedure below to display and clear messages.

- 1, 2, 3...
1. Press the CLR Key to bring up the initial display.
  2. Press the FUN and then the MONTR Key to begin the operation. If there are no messages, the following display will appear:

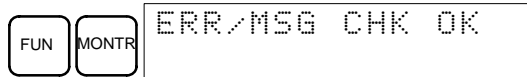

If there are messages, the most serious message will be displayed when the MONTR Key is pressed. Pressing MONTR again will clear the present message and display the next most serious error message. Continue pressing MONTR until all messages have been cleared. These are some examples of error messages:

A memory error:

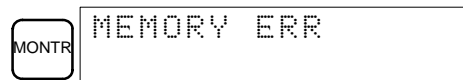

A system error:

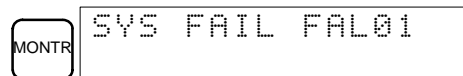

A message (displayed with MSG(46)):

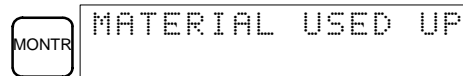

All messages cleared:

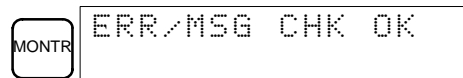

### 6-2-4 Buzzer Operation

This operation is used to turn on and off the buzzer that sounds when Programming Console keys are pressed. This buzzer will also sound whenever an error occurs during PC operation. Buzzer operation for errors is not affected by this setting.

This operation is possible in any mode.

RUN	MONITOR	PROGRAM
OK	OK	OK

**Key Sequence**

Follow the procedure below to turn the key-input buzzer on and off.

- 1, 2, 3...** 1. Press the CLR, SHIFT, and then the CLR Key to bring up the mode display. In this case the PC is in PROGRAM mode and the buzzer is ON.

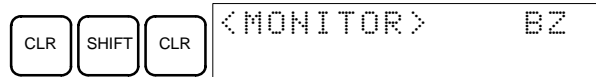

2. Press the SHIFT and then the 1 Key to turn off the buzzer.



The buzzer will not sound when "BZ" is not displayed.

3. Press the SHIFT and then the 1 Key again to turn the buzzer back ON.

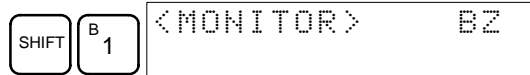

### 6-2-5 Assigning Expansion Instruction Function Codes

This operation is used to display or change the expansion instructions assigned to expansion instruction function codes. The assignments can be displayed in any mode, but can be changed in PROGRAM mode only.

Operation	RUN	MONITOR	PROGRAM
Read assignment	OK	OK	OK
Change assignment	No	No	OK

Assign expansion instruction function codes before inputting the program. The CPM2B will not operate properly if expansion instructions aren't assigned correctly. An expansion instruction can be assigned to one function code only.

The PC Setup must be set for user-defined expansion instruction assignments. Set bits 8 to 11 of DM 6602 to 1 and turn the PC's power off and then on again to enable the new setting.

There are tables in *Section 5 Instruction Set* showing the default function code assignments in the CPM2B.

- 1, 2, 3...** 1. Press the CLR Key to bring up the initial display.  
2. Press the EXT Key to display the assignment for the first function code (17).

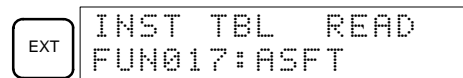

3. Press the Up and Down Arrow Keys to scroll through the expansion instruction function codes.

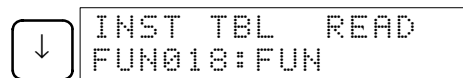

4. Press the CHG Key to assign a different expansion instruction to the selected function code.

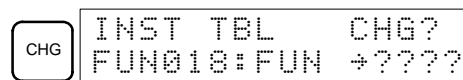

5. Press the Up and Down Arrow Keys to scroll through the expansion instructions that can be assigned to the selected function code.

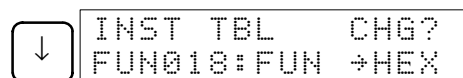

- Press the WRITE Key to assign the displayed instruction to the function code.

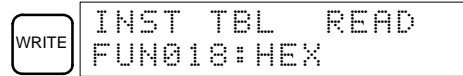

### 6-2-6 Setting and Reading a Program Memory Address and Monitoring I/O Bit Status

This operation is used to display the specified program memory address and is possible in any mode. In the RUN or MONITOR mode, the I/O bit status of bits in the program will be displayed.

RUN	MONITOR	PROGRAM
OK	OK	OK

When inputting a program for the first time, it is generally written to Program Memory starting from address 000. Because this address appears when the display is cleared, it is not necessary to specify it.

When inputting a program starting from other than 000 or to read or modify a program that already exists in memory, the desired address must be designated.

- 1, 2, 3... 1. Press the CLR Key to bring up the initial display.
2. Input the desired address. It is not necessary to input leading zeroes.

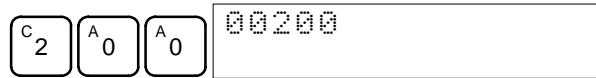

3. Press the Down Arrow Key.

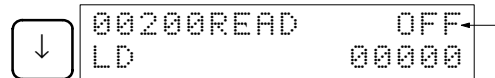

In the RUN or MONITOR mode, ON/OFF status of the bit will be displayed.

Pressing the MONTR Key will change to the I/O monitor display. Bits can be force-set or force-reset from the I/O monitor display. Press the CLR Key to return to I/O bit status monitoring of the initial address.

**Note** The ON/OFF status of any displayed bit will be shown if the PC is in RUN or MONITOR mode.

4. Press the Up and Down Arrow Keys to scroll through the program.

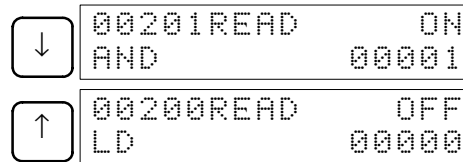

### 6-2-7 Entering or Editing Programs

This operation is used enter or edit programs. It is possible in PROGRAM mode only.

RUN	MONITOR	PROGRAM
No	No	OK

The same procedure is used to either input a program for the first time or to change a program that already exists. In either case, the current contents of Program Memory is overwritten.

The program shown in the following diagram will be entered to demonstrate this operation.

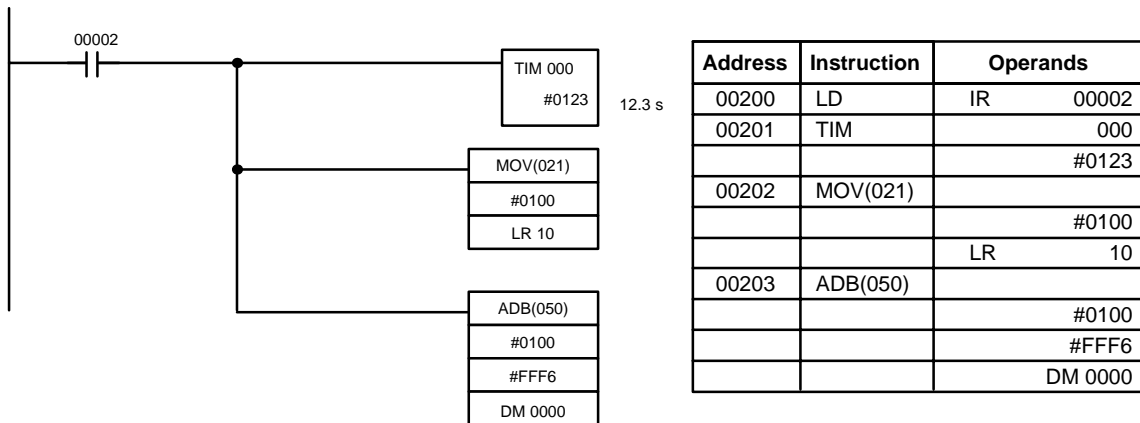

- 1, 2, 3... 1. Press the CLR Key to bring up the initial display.  
 2. Specify the address where the program will begin.  
 3. Input the address where the program will begin and press the Down Arrow Key. It is not necessary to input leading zeroes.

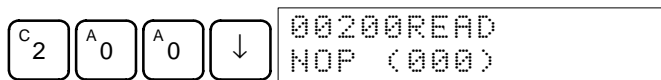

4. Input the first instruction and operand.

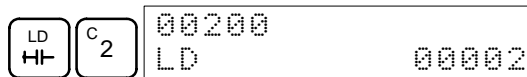

5. Press the WRITE Key to write the instruction to Program Memory. The next program address will be displayed.

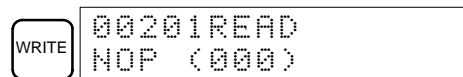

If a mistake was made inputting the instruction, press the Up Arrow Key to return to the previous program address and input the instruction again. The mistaken instruction will be overwritten

To specify the Completion Flag for a timer or counter, press the LD, AND, OR, or NOT Key followed by the TIM or CNT Key, and then input the timer/counter number last.

6. Input the second instruction and operand. (In this case it isn't necessary to enter the timer number, because it's 000.) Press the WRITE Key to write the instruction to Program Memory.

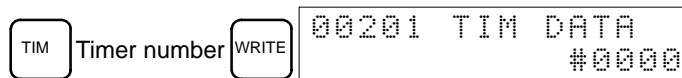

7. Input the second operand (123 to specify 12.3 seconds) and press the WRITE Key. The next program address will be displayed.

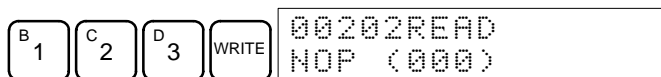

If a mistake was made inputting the operand, press the Up Arrow Key to return to display the mistaken operand and input the operand again.

- Note** a) Counters are input in the same basic way as timers except the CNT Key is pressed instead of the TIM Key.  
 b) Timer and counter SVs are input in BCD, so it isn't necessary to press the CONT/# Key.

- Input the third instruction and its operands. First input the instruction by pressing the FUN Key and then the function code (21 in this case).

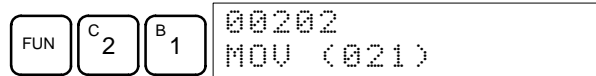

To input the differentiated version of an instruction, press the NOT Key after the function code (FUN 2 1 NOT). The “@” symbol will be displayed next to differentiated instructions. Press the NOT Key again to change back the instruction back to a non-differentiated instruction. The “@” symbol will disappear.

To change an instruction after it has been entered, simply scroll through the program until the desired instruction is displayed and press the NOT Key. The “@” symbol should be displayed next to the instruction.

- Press the WRITE Key to write the instruction to Program Memory. The input display for the first operand will be displayed.

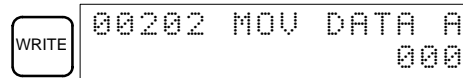

**• Writing Hexadecimal, BCD Constant**

- Input the first operand.

The operands of MOV (21) are normally word addresses, but a constant can be input by pressing the CONT/# Key first. When the CONT/# Key is pressed, the display will change to “#0000,” indicating that a constant can be entered.

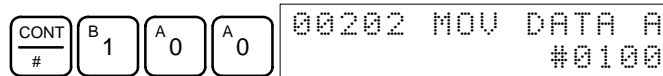

Press the WRITE Key to write the instruction to Program Memory. The input display for the second operand will appear.

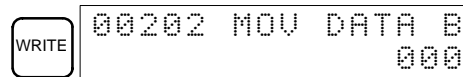

**Note** The operands of MOV(21) can be word addresses, so the CONT/# Key must be pressed to input a constant.

**• Writing a Word Address**

- Input the second operand.

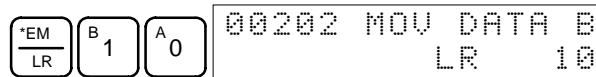

Press the WRITE Key to write the instruction to Program Memory. The next program address will be displayed.

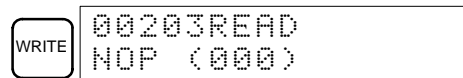

**Note** When the default display value is “000”, a word address can be input immediately without pressing the Shift and CH/# Keys.

- Input the next instruction.

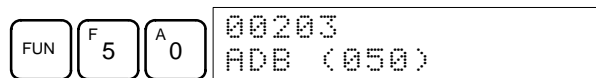

Press the WRITE Key to write the instruction to Program Memory.

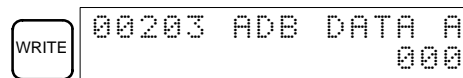

• Writing an Unsigned Decimal Number

13. The first operand is input as an unsigned integer.

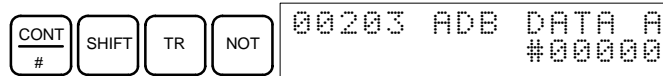

Input the value of the operand from 0 to 65535.

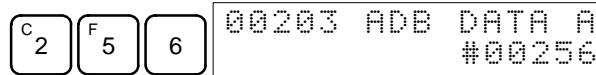

**Note** If an erroneous input is made, press the CLR Key to restore the status prior to the input. Then enter the correct input.

14. Restore the hexadecimal display.

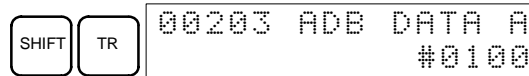

**Note** If an input is made outside of the permissible range, a buzzer will sound and the hexadecimal display will not be displayed.

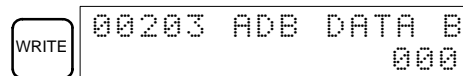

15. The second operand is input as a signed integer.

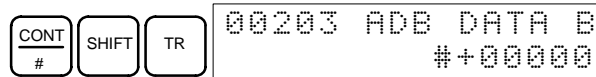

Input the value of the operand from -32,768 to 32,767. Use the SET Key to input a positive number, and use the RESET Key to input a negative number.

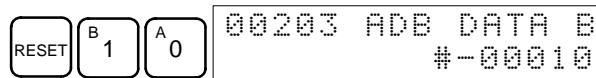

**Note** If an erroneous input is made, press the CLR Key to restore the status prior to the input. Then enter the correct input.

16. Restore the hexadecimal display.

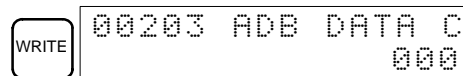
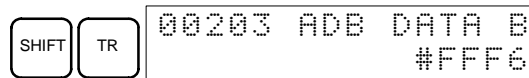

• Writing a Word Address (DM 0000)

17. Input the final operand and then press the WRITE Key. (It isn't necessary to input leading zeroes.)

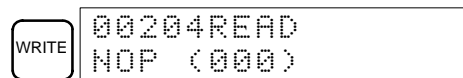
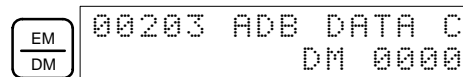

6-2-8 Instruction Search

This operation is used to find occurrences of the specified instruction in the program and is possible in any mode.

RUN	MONITOR	PROGRAM
OK	OK	OK

The ON/OFF status of any displayed bit will be shown if the PC is in RUN or MONITOR mode.

- 1, 2, 3... 1. Press the CLR Key to bring up the initial display.
2. Input the address from which the search will begin and press the Down Arrow Key. It is not necessary to input leading zeroes.

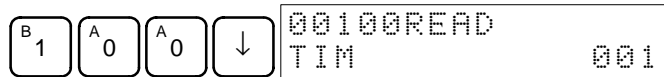

3. Input the instruction to be found and press the SRCH Key. In this case, the search is for OUT 01000.

In this case, the next OUT 01000 instruction is at address 200, as shown below.



4. Press the Down Arrow Key to display the instruction's operands or press the SRCH Key to search for the next occurrence of the instruction.
5. The search will continue until an END instruction or the end of Program Memory is reached. In this case, an END instruction was reached at address 397.

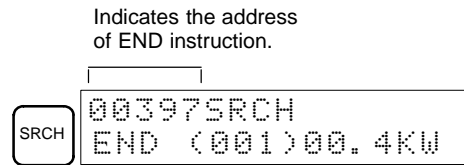

Indicates the amount used by the user program in units of 0.1 Kwords.

### 6-2-9 Bit Operand Search

This operation is used to find occurrences of the specified operand bit in the program and is possible in any mode.

RUN	MONITOR	PROGRAM
OK	OK	OK

The ON/OFF status of any displayed bit will be shown if the PC is in RUN or MONITOR mode.

- 1, 2, 3... 1. Press the CLR Key to bring up the initial display.
2. Input the operand address. It is not necessary to input leading zeroes.

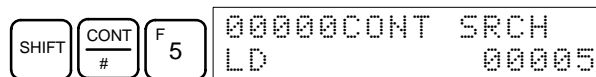

3. Press the SRCH Key to begin the search.

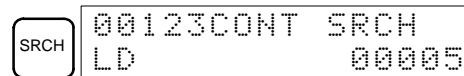

4. Press the SRCH Key to search for the next occurrence of the operand bit.

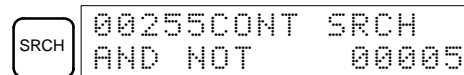

5. The search will continue until an END instruction or the end of Program Memory is reached. In this case, an END instruction was reached.

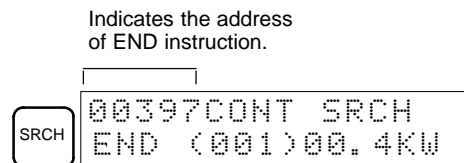

Indicates the amount used by the user program in units of 0.1 Kwords.



### 6-2-10 Inserting and Deleting Instructions

This operation is used to insert or delete instructions from the program. It is possible in PROGRAM mode only.

RUN	MONITOR	PROGRAM
No	No	OK

To demonstrate this operation, an IR 00105 NO condition will be inserted at program address 00206 and an IR 00103 NO condition deleted from address 00205, as shown in the following diagram.

Original Program

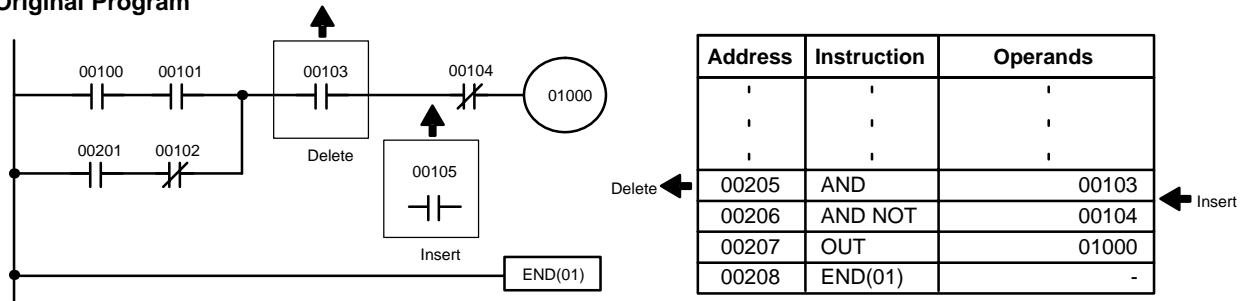

#### Insertion

Follow the procedure below to insert the IR 00105 NO condition at address 00206.

1, 2, 3...

1. Press the CLR Key to bring up the initial display.
2. Input the address where the NO condition will be inserted and press the Down Arrow Key. It is not necessary to input leading zeroes.

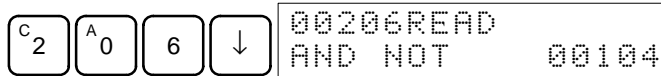

3. Input the new instruction and press the INS Key.



4. Press the Down Arrow Key to insert the new instruction.

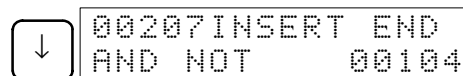

**Note** For instructions that require more operands (such as set values), input the operands and then press the WRITE Key.

#### Deletion

Follow the procedure below to delete the IR 00103 NO condition at address 00205.

1, 2, 3...

1. Press the CLR Key to bring up the initial display.
2. Input the address where the NO condition will be deleted and press the Down Arrow Key. It is not necessary to input leading zeroes.

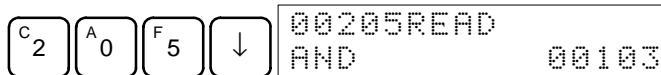

3. Press the DEL Key.

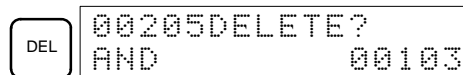

4. Press the Up Arrow Key to delete the specified instruction.

If the instruction has more operands, the operands will be deleted automatically with the instruction.

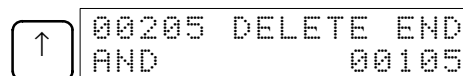

After completing the insertion and deletion procedures, use the Up and Down Arrow Keys to scroll through the program and verify that it has been changed correctly, as shown in the following diagram.

**Corrected Program**

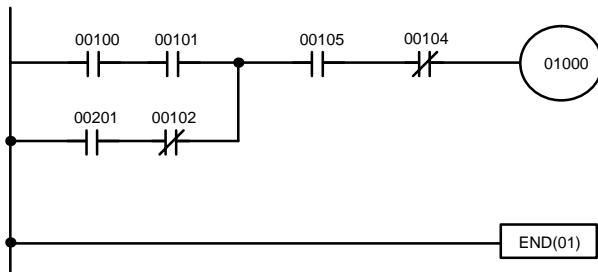

Address	Instruction	Operands
00205	AND	00105
00206	AND NOT	00104
00207	OUT	01000
00208	END(01)	-

**6-2-11 Checking the Program**

This operation checks for programming errors and displays the program address and error when errors are found. It is possible in PROGRAM mode only.

RUN	MONITOR	PROGRAM
No	No	OK

- 1, 2, 3...
1. Press the CLR Key to bring up the initial display.
  2. Press the SRCH Key. An input prompt will appear requesting the desired check level.

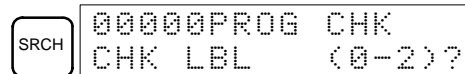

3. Input the desired check level (0, 1, or 2). The program check will begin when the check level is input, and the first error found will be displayed.

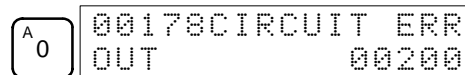

4. Press the SRCH Key to continue the search. The next error will be displayed. Continue pressing the SRCH Key to continue the search. The search will continue until an END instruction or the end of Program Memory is reached. A display like this will appear if the end of Program Memory is reached:

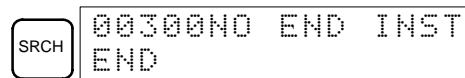

A display like this will appear if an END instruction is reached:

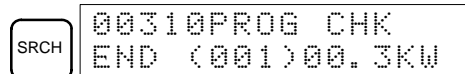

No more errors exist if the END instruction is displayed.

If errors are displayed, edit the program to correct the errors and check the program again. Continue checking the program by pressing the SRCH Key again until all errors have been corrected.

**6-2-12 Bit, Digit, Word Monitor**

This operation is used to monitor the status of up to 16 bits and words, although only 3 can be shown on the display at any one time. Operation is possible in any mode.

RUN	MONITOR	PROGRAM
OK	OK	OK

**Program Read then Monitor** When a program address is being displayed, the status of the bit or word in that address can be monitored by pressing the MONTR Key.

- 1, 2, 3...**
1. Press the CLR Key to bring up the initial display.
  2. Input the desired program address and press the Down Arrow Key.

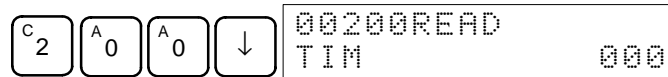

3. Press the MONTR Key to begin monitoring.

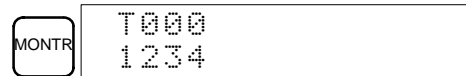

If the status of a bit is being monitored, that bit's status can be changed using the Force Set/Reset operation. Refer to 6-2-24 *Force Set, Reset* for details.

If the status of a word is being monitored, that word's value can be changed using the Hexadecimal/BCD Data Modification operation. Refer to 4-3-19 *Hexadecimal, BCD Data Modification*, 4-3-20 *Binary Data Modification*, 4-3-21 *Signed Decimal Data Modification*, and 4-3-22 *Unsigned Decimal Data Modification* for details.

4. Press the CLR Key to end monitoring.

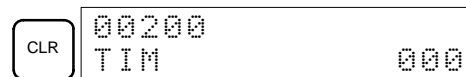

**Bit Monitor**

Follow the procedure below to monitor the status of a particular bit.

- 1, 2, 3...**
1. Press the CLR Key to bring up the initial display.
  2. Input the bit address of the desired bit and press the MONTR Key.

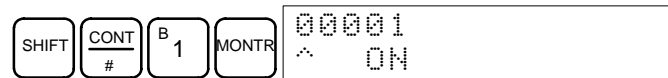

The Up or Down Arrow Key can be pressed to display the status of the previous or next bit.

The displayed bit's status can be changed using the Force Set/Reset operation. Refer to 6-2-24 *Force Set, Reset* for details.

3. Press the CLR Key to end monitoring.

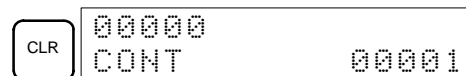

**Word Monitor**

Follow the procedure below to monitor the status of a particular word.

- 1, 2, 3...**
1. Press the CLR Key to bring up the initial display.
  2. Input the word address of the desired word.

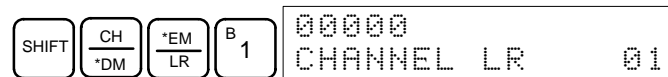

3. Press the MONTR Key to begin monitoring.

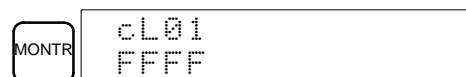

The Up or Down Arrow Key can be pressed to display the status of the previous or next word.

The displayed word's status can be changed using the Hexadecimal/BCD Data Modification operation. Refer to 4-3-19 *Hexadecimal, BCD Data Modification*, 4-3-20 *Binary Data Modification*, 4-3-21 *Singed Decimal Data Modification*, and 4-3-22 *Unsigned Decimal Data Modification* for details.

4. Press the CLR Key to end monitoring.

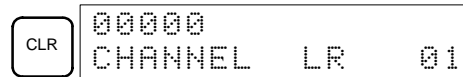

**Note** The operating mode can be changed without altering the current monitor display by holding down the SHIFT Key and then changing the operating mode.

**Multiple Address Monitoring**

The status of up to six bits and words can be monitored simultaneously, although only three can be shown on the display at any one time.

1, 2, 3...

1. Press the CLR Key to bring up the initial display.
2. Input the address of the first bit or word and press the MONTR Key.

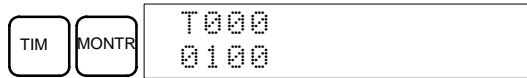

3. Repeat step 2 up to 6 times to display the next addresses to be monitored.

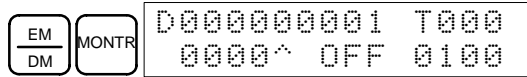

If 4 or more bits and words are being monitored, the bits and words that do not appear on the display can be displayed by pressing the MONTR Key. If the MONTR Key is pressed alone, the display will shift to the right.

If more than six bits and words are input, monitoring of the bit or word input first will be canceled.

4. Press the CLR Key to stop monitoring the leftmost bit or word and clear it from the display.

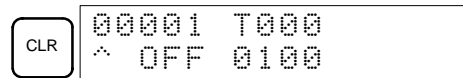

5. Press the SHIFT and CLR Keys to end monitoring altogether.

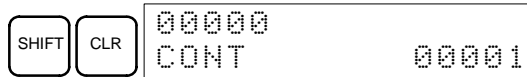

**Note** Press the SHIFT Key, CLR Key, and then CLR Key again to return to the initial Programming Console display with the multiple address monitoring state unchanged. Press the SHIFT Key and then the MONTR Key from the initial display to return to the multiple address monitoring state. The monitoring states can be retained for 6 bits and words.

The operating mode can be changed without altering the current monitor display by holding down the SHIFT Key and then changing the operating mode.

**6-2-13 Differentiation Monitor**

This operation is used to monitor the up or down differentiation status of a particular bit. When detected, the up or down differentiation will be displayed and the buzzer will sound. It is possible in any mode.

RUN	MONITOR	PROGRAM
OK	OK	OK

1, 2, 3...

1. Monitor the status of the desired bit according to the procedure described in 6-2-12 Bit, Digit, Word Monitor. If 2 or more bits are being monitored, the desired bit should be leftmost on the display.

In this case the differentiation status of LR 00 will be monitored.

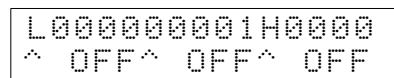

- To specify up-differentiation monitoring, press the SHIFT and then the Up Arrow Key. The symbols "U@" will appear.



To specify down-differentiation monitoring, press the SHIFT and then the Down Arrow Key. The symbols "D@" will appear.



- The buzzer will sound when the specified bit goes from off to on (for up-differentiation) or from on to off (for down-differentiation).



**Note** The buzzer will not sound if it has been turned off.

- Press the CLR Key to end differentiation monitoring and return to the normal monitoring display.



### 6-2-14 Binary Monitor

This operation is used to monitor the ON/OFF status of any word's 16 bits. It is possible in any mode.

RUN	MONITOR	PROGRAM
OK	OK	OK

- 1, 2, 3... Monitor the status of the desired word according to the procedure described in 6-2-12 *Bit, Digit, Word Monitor*. The desired word should be leftmost on the display if 2 or more words are being monitored.



(Word monitor)

- Press the SHIFT and then the MONTR Key to begin binary monitoring. The ON/OFF status of the selected word's 16 bits will be shown along the bottom of the display. A 1 indicates a bit is on, and a 0 indicates it is off.

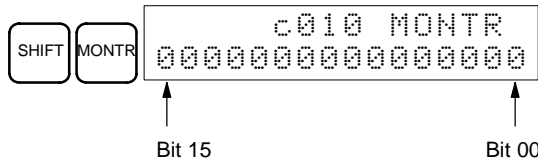

The status of force-set bits is indicated by "S," and the status of a force-reset bits is indicated by "R," as shown below.

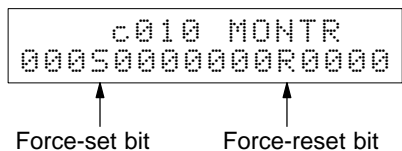

- Note**
- The status of displayed bits can be changed at this point. Refer to 6-2-21 *Binary Data Modification* for details.
  - The Up or Down Arrow Key can be pressed to display the status of the previous or next word's bits.

- Press the CLR Key to end binary monitoring and return to the normal monitoring display.

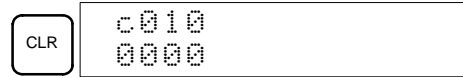

### 6-2-15 Three-Word Monitor

This operation is used to monitor the status of three consecutive words. It is possible in any mode.

RUN	MONITOR	PROGRAM
OK	OK	OK

- 1, 2, 3... 1. Monitor the status of the first of the three words according to the procedure described in 6-2-12 *Bit, Digit, Word Monitor*. If 2 or more words are being monitored, the desired first word should be leftmost on the display.



(Word monitor)

2. Press the EXT Key to begin 3-word monitoring. The status of the selected word and the next two words will be displayed, as shown below. In this case, DM 0000 was selected.

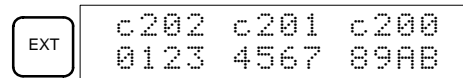

The Up and Down Arrow Keys can be used to shift one address up or down. The status of the displayed words can be changed at this point. Refer to 6-2-18 *Three-word Data Modification*.

The display can be changed to display ASCII text, which is useful when three consecutive words containing an ASCII message are displayed. Refer to 6-2-26 *Hex-ASCII Display Change*.

3. Press the CLR Key to end 3-word monitoring and return to the normal monitoring display. The rightmost word on the 3-word monitor display will be monitored.

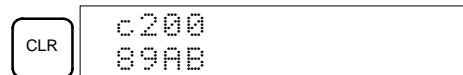

**Note** The operating mode can be changed without altering the current monitor display by holding down the SHIFT Key and then changing the operating mode.

### 6-2-16 Signed Decimal Monitor

This operation converts the contents of the specified word from signed hexadecimal (two's complement format) to signed decimal for display. The operation can be executed while using I/O monitoring, multiple address monitoring or 3-word monitoring.

RUN	MONITOR	PROGRAM
OK	OK	OK

- 1, 2, 3... 1. Monitor the word that is to be used for decimal monitor with sign. During multiple address monitoring, the leftmost word will be converted.

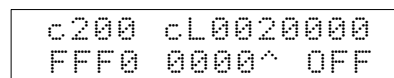

(Multiple address monitor)

2. Press the SHIFT+TR Keys to display the leftmost word as signed decimal.

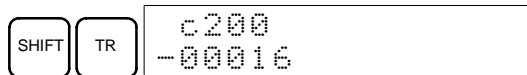

At this point, the contents of the displayed word can be changed with a signed-decimal input. Refer to 6-2-22 Signed Decimal Data Modification.

3. Press the CLR Key or the SHIFT+TR Keys to end the unsigned decimal display and return to normal monitoring.

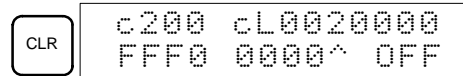

### 6-2-17 Unsigned Decimal Monitor

This operation is used to convert hexadecimal data in a word to unsigned decimal for display. The operation can be executed while using I/O monitoring, multiple address monitoring or 3-word monitoring.

RUN	MONITOR	PROGRAM
OK	OK	OK

- 1, 2, 3... 1. Monitor the word that is to be used for decimal monitor without sign. During multiple address monitoring, the leftmost word will be converted.

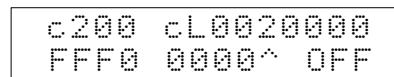

Multiple address monitoring

2. Press the SHIFT+TR+NOT Keys to display the leftmost word as unsigned decimal.

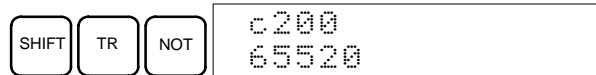

At this point, the contents of the displayed word can be changed with an unsigned-decimal input. Refer to 6-2-23 Unsigned Decimal Data Modification.

3. Press the CLR Key or the SHIFT+TR Keys to end the unsigned decimal display and return to normal monitoring.

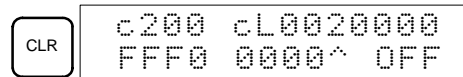

### 6-2-18 Three-Word Data Modification

This operation is used to change the contents of one or more of the 3 consecutive words displayed in the Three-Word Monitor operation. It is possible in MONITOR or PROGRAM mode only.

RUN	MONITOR	PROGRAM
No	OK	OK

**Caution** Before changing the contents of I/O memory, be sure that the changes will not cause equipment to operate unexpectedly or dangerously. In particular, take care when changing the status of output bits. The PC continues to refresh I/O bits even if the PC is in PROGRAM mode, so devices connected to output points on the CPU Board or Expansion I/O Boards may operate unexpectedly.

- 1, 2, 3... 1. Monitor the status of the desired words according to the procedure described 6-2-15 Three-Word Monitor.

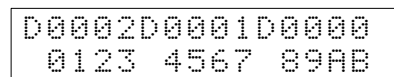

(Three-word monitor)

2. Press the CHG Key to begin 3-word data modification. The cursor will appear next to the contents of the leftmost word.

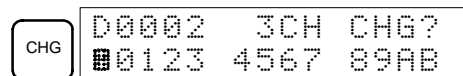

3. Input the new value for the leftmost word on the display and press the CHG Key if more changes will be made.

(Input the new value and press the WRITE Key to write the changes in memory if no more changes will be made.)



- Input the new value for the middle word on the display and press the CHG Key if the rightmost word will be changed. Input the new value and press the WRITE Key to write the changes in memory if the rightmost word will not be changed. (In this case, it will not.)

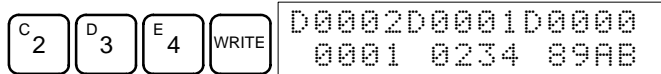

**Note** If the CLR Key is pressed before the WRITE Key, the operation will be cancelled and the 3-word monitor display will return without any changes in data memory.

### 6-2-19 Changing Timer, Counter SV

There are two operations that can be used to change the SV of a timer or counter. They are possible in MONITOR or PROGRAM mode only. In MONITOR mode, the SV can be changed while the program is being executed.

RUN	MONITOR	PROGRAM
No	OK	OK

The timer or counter SV can be changed either by inputting a new value or by incrementing or decrementing the current SV.

#### Inputting a New SV Constant

This operation can be used to input a new SV constant, as well as to change an SV from a constant to a word address designation and vice versa. The following examples show how to input a new SV constant and how to change the SV from a constant to an address.

- 1, 2, 3... 1. Press the CLR Key to bring up the initial display.
2. Display the desired timer or counter.

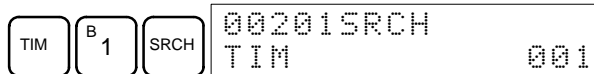

3. Press the Down Arrow Key and then the CHG Key.

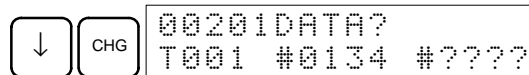

4. At this point a new SV constant can be input or the SV constant can be changed to a word address designation

- a) To input a new SV constant, input the constant and press the WRITE Key.

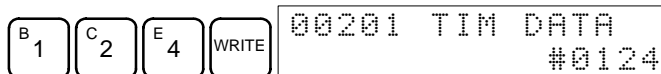

- b) To change to a word address designation, input the word address and press the WRITE Key.



#### Incrementing and Decrementing a Constant

This operation can be used to increment and decrement an SV constant. It is possible only when the SV has been entered as a constant.

- 1, 2, 3... 1. Press the CLR Key to bring up the initial display.
2. Display the desired timer or counter.

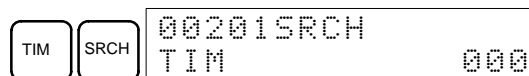



- Press the Down Arrow, CHG, and then the EXT Key.

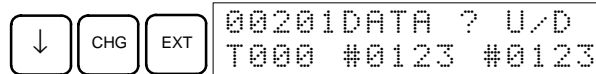

The constant on the left is the old SV and the constant on the right will become the new SV constant in step 5.

- Press the Up and Down Arrow Keys to increment and decrement the constant on the right. (In this case the SV is incremented once.)



- Press the CLR Key twice to change the timer's SV to the new value.

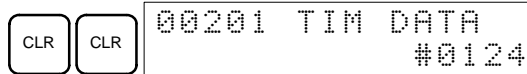

### 6-2-20 Hexadecimal, BCD Data Modification

This operation is used to change the BCD or hexadecimal value of a word being monitored using the procedure described in 6-2-12 *Bit, Digit, Word Monitor*. It is possible in MONITOR or PROGRAM mode only.

RUN	MONITOR	PROGRAM
No	OK	OK

Words SR 253 to SR 255 cannot be changed.

**Caution** Before changing the contents of I/O memory, be sure that the changes will not cause equipment to operate unexpectedly or dangerously. In particular, take care when changing the status of output bits. The PC continues to refresh I/O bits even if the PC is in PROGRAM mode, so devices connected to output points on the CPU Board or Expansion I/O Boards may operate unexpectedly.

- 1, 2, 3... 1. Monitor the status of the desired word according to the procedure described in 6-2-12 *Bit, Digit, Word Monitor*. If two or more words are being monitored, the desired word should be leftmost on the display.



(Word monitor)

2. Press the CHG Key to begin hexadecimal, BCD data modification.

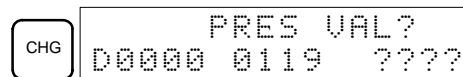

3. Input the new PV and press the WRITE Key to change the PV.

The operation will end and the normal monitoring display will return when the WRITE Key is pressed.

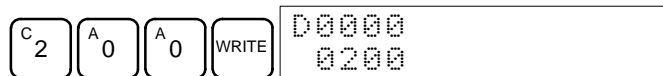

### 6-2-21 Binary Data Modification

This operation is used to change the status of a word's bits when the word is monitored using the procedure described in 6-2-14 *Binary Monitor*. It is possible in MONITOR or PROGRAM mode only.

RUN	MONITOR	PROGRAM
No	OK	OK

Bits SR 25300 to SR 25507 and timer/counter flags cannot be changed.

**! Caution** Before changing the contents of I/O memory, be sure that the changes will not cause equipment to operate unexpectedly or dangerously. In particular, take care when changing the status of output bits. The PC continues to refresh I/O bits even if the PC is in PROGRAM mode, so devices connected to output points on the CPU Board or Expansion I/O Boards may operate unexpectedly.

- 1, 2, 3... 1. Monitor the status of the desired word according to the procedure described 6-2-14 Binary Monitor.

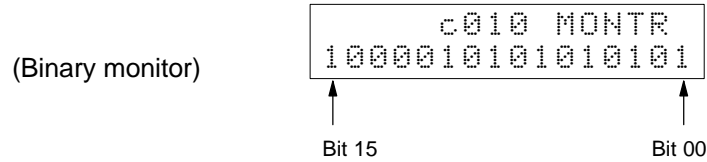

2. Press the CHG Key to begin binary data modification.

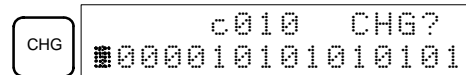

A flashing cursor will appear over bit 15. The cursor indicates which bit can be changed.

3. Three sets of keys are used to move the cursor and change bit status:  
 a) Use the Up and Down Arrow Keys to move the cursor to the left and right.

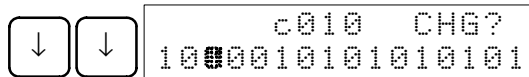

- b) Use the 1 and 0 Keys to change a bit's status to on or off. The cursor will move one bit to the right after one of these keys is pressed.

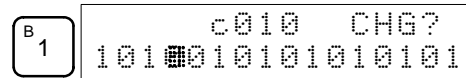

- c) Use the SHIFT+SET and SHIFT+RESET Keys to force-set or force-reset a bit's status. The cursor will move one bit to the right after one of these keys is pressed. The NOT Key will clear force-set or force-reset status.

**Note** Bits in the DM Area cannot be force-set or force-reset.

4. Press the WRITE Key to write the changes in memory and return to the binary monitor.

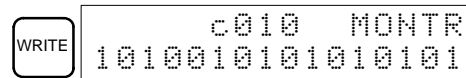

### 6-2-22 Signed Decimal Data Modification

This operation is used to change the decimal value of a word being monitored as signed decimal data, within a range of -32,768 to 32,767. The contents of the specified word are converted automatically to signed hexadecimal (two's complement format).

Words SR 253 to SR 255 cannot be changed.

RUN	MONITOR	PROGRAM
No	OK	OK

**! Caution** Before changing the contents of I/O memory, be sure that the changes will not cause equipment to operate unexpectedly or dangerously. In particular, take care when changing the status of output bits. The PC continues to refresh I/O bits even if the PC is in PROGRAM mode, so devices connected to output points on the CPU Board or Expansion I/O Boards may operate unexpectedly.

- 1, 2, 3... 1. Monitor (signed decimal) the status of the word for which the present value is to be changed.

```
D0200
-00016
```

(Signed decimal monitor)

2. Press the CHG Key to begin decimal data modification.

```
CHG      PRES VAL?
D0200-00016
```

3. Input the new PV and press the WRITE Key to change the PV. The operation will end and the signed-decimal monitoring display will return when the WRITE Key is pressed.

The PV can be set within a range of -32,768 and 32,767. Use the SET Key to input a positive number, and use the RESET Key to input a negative number.

```
RESET  D 3  C 2  7  6  8  WRITE  D0200
                                           -32768
```

If an erroneous input has been made, press the CLR Key to restore the status prior to the input. Then enter the correct input.

The buzzer will sound if a value outside the specified range is input, allowing no writing.

### 6-2-23 Unsigned Decimal Data Modification

This operation is used to change the decimal value of a word being monitored as unsigned decimal data, within a range of 0 to 65,535. A change into hexadecimal data is made automatically.

Words SR 253 to SR 255 cannot be changed.

RUN	MONITOR	PROGRAM
No	OK	OK

**Caution** Before changing the contents of I/O memory, be sure that the changes will not cause equipment to operate unexpectedly or dangerously. In particular, take care when changing the status of output bits. The PC continues to refresh I/O bits even if the PC is in PROGRAM mode, so devices connected to output points on the CPU Board or Expansion I/O Boards may operate unexpectedly.

- 1, 2, 3... 1. Monitor (unsigned decimal) the status of the word for which the present value is to be changed.

```
c200
65520
```

(Unsigned decimal monitor)

2. Press the CHG Key to begin decimal data modification.

```
CHG      PRES VAL?
c200 65520
```

3. Input the new PV and press the WRITE Key to change the PV. The operation will end and the decimal-without-sign monitoring display will return when the WRITE Key is pressed.

The PV can be set within a range of 0 to 65,535.

```
D 3  C 2  7  6  8  WRITE  c200
                                           32768
```

If an erroneous input has been made, press the CLR Key to restore the status prior to the input. Then enter the correct input.

The buzzer will sound if a value outside the specified range is input, allowing no writing.

### 6-2-24 Force Set, Reset

This operation is used to force bits ON (force set) or OFF (force reset) and is useful when debugging the program or checking output wiring. It is possible in MONITOR or PROGRAM mode only.

RUN	MONITOR	PROGRAM
No	OK	OK

**Caution** Before changing the contents of I/O memory, be sure that the changes will not cause equipment to operate unexpectedly or dangerously. In particular, take care when changing the status of output bits. The PC continues to refresh I/O bits even if the PC is in PROGRAM mode, so devices connected to output points on the CPU Board or Expansion I/O Boards may operate unexpectedly.

- 1, 2, 3...
1. Monitor the status of the desired bit according to the procedure described in 6-2-12 Bit, Digit, Word Monitor. If two or more words are being monitored, the desired bit should be leftmost on the display.

(Multiple address monitor)

```

00000020000
^ OFF^ ON
    
```

2. Press the SET Key to force the bit ON or press the RESET Key to force the bit OFF.

```

[SET] 00000020000
      █ ON^ ON
    
```

The cursor in the lower left corner of the display indicates that the force set/reset is in progress. Bit status will remain ON or OFF only as long as the key is held down; the original status will return one cycle after the key is released.

3. Press the SHIFT and SET Keys or SHIFT and RESET Keys to maintain the status of the bit after the key is released. In this case, the force-set status is indicated by an "S" and the force-reset status is indicated by an "R."

To return the bit to its original status, press the NOT Key or perform the Clear Force Set/Reset operation. Refer to 6-2-25 Clear Force Set/Reset for details.

Forced status will also be cleared in the following cases:

- a) When the PC's operating mode is changed (although the forced status will not be cleared when the mode is changed from PROGRAM to MONITOR if SR 25211 is ON)
- b) When the PC stops because a fatal error occurred
- c) When the PC stops because of a power interruption
- d) When the Clear Force Set/Reset Operation is performed

### 6-2-25 Clear Force Set/Reset

This operation is used to restore the status of all bits which have been force set or reset. It is possible in MONITOR or PROGRAM mode only.

RUN	MONITOR	PROGRAM
No	OK	OK

**Caution** Before changing the contents of I/O memory, be sure that the changes will not cause equipment to operate unexpectedly or dangerously. In particular, take care when changing the status of output bits. The PC continues to refresh I/O bits even if the PC is in PROGRAM mode, so devices connected to output points on the CPU Board or Expansion I/O Boards may operate unexpectedly.

- 1, 2, 3... 1. Press the CLR Key to bring up the initial display.
2. Press the SET and then the RESET Key. A confirmation message will appear.

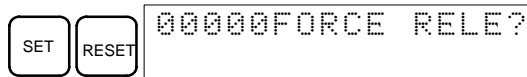

**Note** If you mistakenly press the wrong key, press CLR and start again from the beginning.

3. Press the NOT Key to clear the force-set/reset status of bits in all data areas.

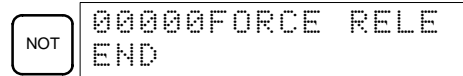

### 6-2-26 Hex-ASCII Display Change

This operation is used to convert word data displays back and forth between 4-digit hexadecimal data and ASCII. It is possible in any mode.

The displayed PV of the timer or counter cannot be changed.

RUN	MONITOR	PROGRAM
OK	OK	OK

- 1, 2, 3... 1. Monitor the status of the desired word(s) according to the procedure described in 6-2-12 *Bit, Digit, Word Monitor*. While the multiple addresses are being monitored, the leftmost word is subject to change.

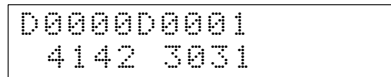

(Multiple address monitor)

2. Press the TR Key to switch to ASCII display. The display will toggle between hexadecimal and ASCII displays each time the TR Key is pressed.

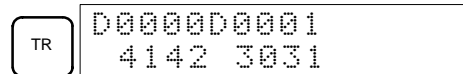
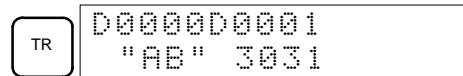

- Note**
1. A message contained in three words can be displayed by using ASCII display in combination with the Three-word monitor operation.
  2. The Hexadecimal, BCD Data Modification Operation can be used while displaying ASCII data. Input values in 4-digit hexadecimal.

### 6-2-27 Displaying the Cycle Time

This operation is used to display the current average cycle time (scan time). It is possible only in RUN or MONITOR mode while the program is being executed.

RUN	MONITOR	PROGRAM
OK	OK	No

- 1, 2, 3... 1. Press the CLR Key to bring up the initial display.
2. Press the MONTR Key to display the cycle time.

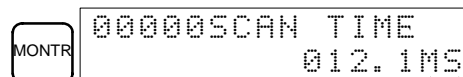

"MS" in the display indicates the unit "ms" for the cycle time.

There might be differences in displayed values when the MONTR Key is pressed repeatedly. These differences are caused by changing execution conditions.

### 6-2-28 Reading and Setting the Clock

This operation is used to read or set the CPU's clock. The clock can be read in any mode, but can be set in MONITOR or PROGRAM mode only.

Operation	RUN	MONITOR	PROGRAM
Read clock	OK	OK	OK
Set clock	No	OK	OK

- 1, 2, 3...
1. Press the CLR Key to bring up the initial display.
  2. Press the FUN Key, SHIFT Key, and then the MONTR Key to display the date and time.

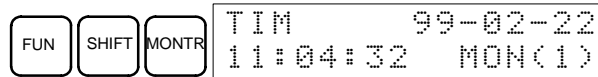

3. Press the CHG Key to change the date and/or time.

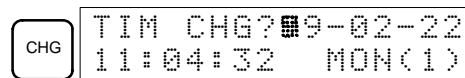

The digit that can be changed will flash. If necessary, input a new value with the Up and Down Arrow Keys or Numeric Keys. Press the CHG Key to move the cursor to the next digit. The following table shows the setting ranges for each value.

Year	Month	Day	Hour	Minute	Second	Day-of-week
00 to 99	01 to 12	01 to 31	00 to 23	00 to 59	00 to 59	0 to 6 (SUN to SAT)

4. Press the WRITE Key to write the new value.

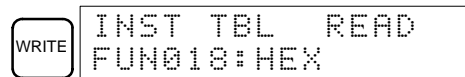

Press the CLR Key to return to the initial display.

## 6-3 Programming Example

This section demonstrates all of the steps needed to write a program with the Programming Console.

### 6-3-1 Preparatory Operations

Use the following procedure when writing a program to the CPM2B for the first time.

- 1, 2, 3...
1. Set the Programming Console's mode switch to PROGRAM mode and turn on the CPM2B's power supply. The password input display will appear on the Programming Console.

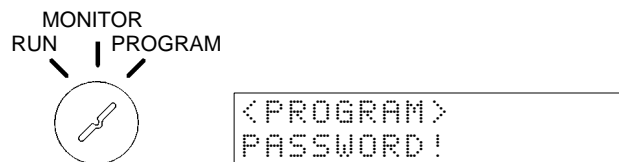

2. Enter the password by pressing the CLR and then the MONTR Key.

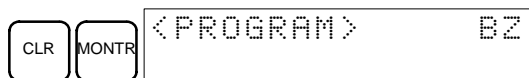

3. Clear the CPM2B's memory by pressing the CLR, SET, NOT, RESET, and then the MONTR Key. Press the CLR Key several times if memory errors are displayed.

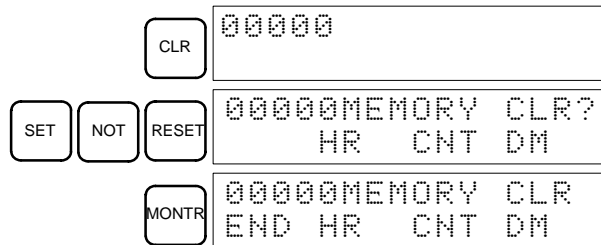

4. Display and clear error messages by pressing the CLR, FUN, and then the MONTR Key. Continue pressing the MONTR Key until all error messages have been cleared.

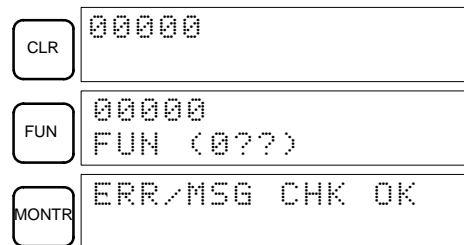

5. Press the CLR Key to bring up the initial programming display (program address 00000). The new program can be written at this point.

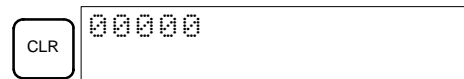

**Caution** Check the system thoroughly before starting or stopping the CPM2B to prevent any accidents that might occur when the program is first started.

### 6-3-2 Example Program

The following ladder program will be used to demonstrate how to write a program with the Programming Console. This program makes output IR 01000 flicker ON/OFF (one second ON, one second OFF) ten times after input IR 00000 is turned ON.

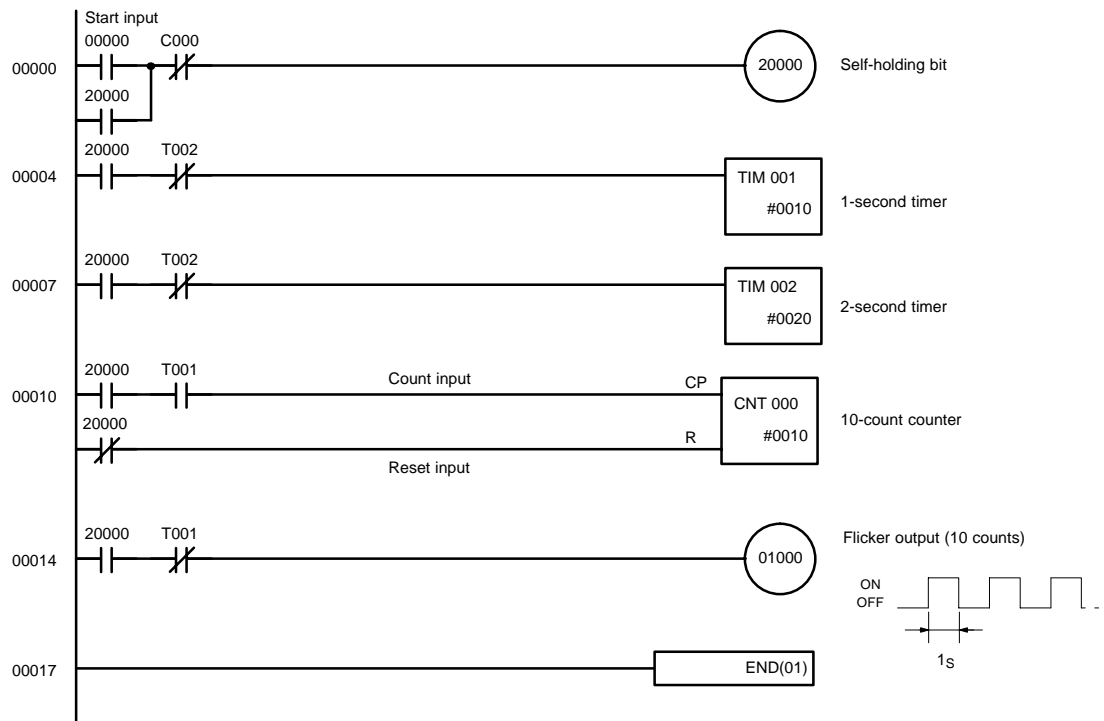

The mnemonic list for the example program is shown in the following table. The steps required to enter this program from a Programming Console are described in 6-3-3 Programming Procedures.

Address	Instruction	Data	Programming example procedures in 6-3-3 Programming Procedures
00000	LD	00000	(1) Self-holding bit
00001	OR	20000	
00002	AND NOT	C 000	
00003	OUT	20000	
00004	LD	20000	(2) 1-second timer
00005	AND NOT	T 002	
00006	TIM	001	
		# 0010	
00007	LD	20000	(3) 2-second timer
00008	AND NOT	T 002	
00009	TIM	002	
		# 0020	
00010	LD	20000	(4) 10-count counter
00011	AND	T 001	
00012	LD NOT	20000	
00013	CNT	000	
		# 0010	
00014	LD	20000	(5) Flicker output (10 counts)
00015	AND NOT	T 001	
00016	OUT	01000	
00017	END (01)	---	(6) END(01) instruction



### 6-3-3 Programming Procedures

The example program will be written to the CPM2B according to the mnemonic list in 6-3-2 Example Program. The procedure is performed beginning with the initial display. (Clear the memory before entering a new program.)

**Note** If an error occurs while inputting the program, refer to the *Programming Manual* for details on correcting the error.

#### (1) Inputting the Self-holding Bit

- 1, 2, 3... 1. Input the normally open condition IR 00000.  
(It isn't necessary to input leading zeroes.)

LD HI	00000 LD	00000
----------	-------------	-------

WRITE	00001READ NOP (000)
-------	------------------------

2. Input the OR condition IR 20000.

OR HI	C 2	A 0	A 0	A 0	A 0	00001 OR	20000
----------	-----	-----	-----	-----	-----	-------------	-------

WRITE	00002READ NOP (000)
-------	------------------------

3. Input the normally closed AND condition C000.  
(It isn't necessary to input leading zeroes.)

AND HI	NOT	CNT	00002 AND NOT CNT 000
-----------	-----	-----	--------------------------

WRITE	00003READ NOP (000)
-------	------------------------

4. Input the OUT instruction IR 20000.

OUT	C 2	A 0	A 0	A 0	A 0	00003 OUT	20000
-----	-----	-----	-----	-----	-----	--------------	-------

WRITE	00004READ NOP (000)
-------	------------------------

#### (2) Inputting the One-second Timer

- 1, 2, 3... 1. Input the normally open condition IR 20000.

LD HI	C 2	A 0	A 0	A 0	A 0	00004 LD	20000
----------	-----	-----	-----	-----	-----	-------------	-------

WRITE	00005READ NOP (000)
-------	------------------------

2. Input the normally closed AND condition T002.  
(It isn't necessary to input leading zeroes.)

AND HI	NOT	TIM	C 2	00005 AND NOT TIM 002
-----------	-----	-----	-----	--------------------------

WRITE	00006READ NOP (000)
-------	------------------------

3. Input the 1-second timer T001.

TIM	B 1	00006 TIM	001
-----	-----	--------------	-----

WRITE	00006 TIM DATA #0000
-------	-------------------------

4. Input the SV for T001 (#0010 = 1.0 s).

B 1	A 0	00006 TIM DATA #0010
WRITE	00007READ NOP (000)	

**(3) Inputting the Two-second Timer**

The following key operations are used to input the 2-second timer.

1, 2, 3...

1. Input the normally open condition IR 20000.

LD	C 2	A 0	A 0	A 0	A 0	00007 LD 20000
WRITE	00008READ NOP (000)					

2. Input the normally closed AND condition T002.  
(It isn't necessary to input leading zeroes.)

AND	NOT	TIM	C 2	00008 AND NOT TIM 002
WRITE	00009READ NOP (000)			

3. Input the 2-second timer T002.

TIM	C 2	00009 TIM 002
WRITE	00009 TIM DATA #0000	

4. Input the SV for T002 (#0020 = 2.0 s).

C 2	A 0	00009 TIM DATA #0020
WRITE	00010READ NOP (000)	

**(4) Inputting the 10-count Counter**

The following key operations are used to input the 10-count counter.

1, 2, 3...

1. Input the normally open condition IR 20000.

LD	C 2	A 0	A 0	A 0	A 0	00010 LD 20000
WRITE	00011READ NOP (000)					

2. Input the normally open AND condition T001.  
(It isn't necessary to input leading zeroes.)

AND	TIM	B 1	00011 AND TIM 001
WRITE	00012READ NOP (000)		

3. Input the normally closed condition IR 20000.

LD	NOT	C 2	A 0	A 0	A 0	A 0	00012 LD NOT 20000
WRITE	00013READ NOP (000)						

4. Input the counter 000.

CNT	A 0	00013 CNT 000
WRITE		00013 CNT DATA #0000

5. Input the SV for counter 000 (#0010 = 10 counts).

B 1	A 0	00013 CNT DATA #0010
WRITE		00014READ NOP (000)

**(5) Inputting the Flicker Output**

1, 2, 3... 1. Input the normally open condition IR 20000.

LD	C 2	A 0	A 0	A 0	A 0	000014 LD 20000
WRITE						00015READ NOP (000)

2. Input the normally closed AND condition T001.  
(It isn't necessary to input leading zeroes.)

AND	NOT	TIM	B 1	00015 AND NOT TIM 001
WRITE				00016READ NOP (000)

3. Input the OUT instruction IR 01000.  
(It isn't necessary to input leading zeroes.)

OUT	B 1	A 0	A 0	A 0	00016 OUT 01000
WRITE					00017READ NOP (000)

**(6) Inputting the END(001) Instruction**

Input END(01). (The display shows three digits in the function code, but only the last two digits are input for CPM2B PCs.)

FUN	00017 FUN (0??)	
A 0	B 1	00017 END (001)
WRITE		00018READ NOP (000)

**6-3-4 Checking the Program**

Check the program syntax in PROGRAM mode to make sure that the program has been input correctly.

1, 2, 3... 1. Press the CLR Key to bring up the initial display.

CLR	00000
-----	-------

2. Press the SRCH Key. An input prompt will appear requesting the desired check level.



3. Input the desired check level (0, 1, or 2). The program check will begin when the check level is input, and the first error found will be displayed. If no errors are found, the following display will appear.

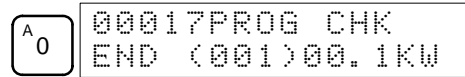

**Note** Refer to the *Programming Manual* for details on check levels and the programming errors that may be displayed during a program check.

4. Press the SRCH Key to continue the search. The next error will be displayed. Continue pressing the SRCH Key to continue the search.

The search will continue until an END(01) instruction or the end of Program Memory is reached.

If errors are displayed, edit the program to correct the errors and check the program again. Continue checking the program until all errors have been corrected.

### 6-3-5 Test Run in MONITOR Mode

Switch the CPM2B in MONITOR mode and check the operation of the program.

- 1, 2, 3... 1. Set the Programming Console's mode switch to MONITOR mode.

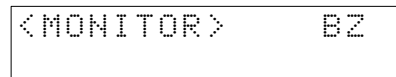
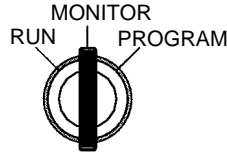

2. Press the CLR Key to bring up the initial display.

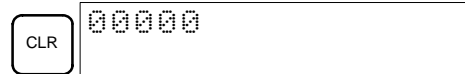

3. Force-set the start input bit (IR 00000) from the Programming Console to start the program.

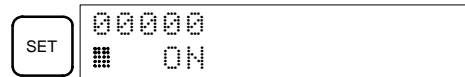
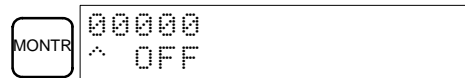
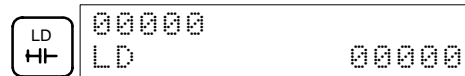

The cursor in the lower left corner of the display indicates that the force set is in progress. The bit will remain ON as long as the Set Key is held down.

4. The output indicator for output IR 01000 will flash ten times if the program is operating correctly. The indicator should go OFF after ten one-second flashes.

There is a mistake in the program if the output indicator doesn't flash. In this case, check the program and force set/reset bits to check operation.

# SECTION 7

## Test Runs and Error Processing

This section describes procedures for test runs of CPM2B operation, self-diagnosis functions, and error processing to identify and correct the hardware and software errors that can occur during PC operation.

7-1	Initial System Checks and Test Run Procedure .....	114
7-1-1	Initial System Checks .....	114
7-1-2	Flash Memory Precautions .....	114
7-2	CPM2B Test Run Procedure .....	114
7-3	Self-diagnostic Functions .....	115
7-3-1	Identifying Errors .....	115
7-3-2	User-defined Errors .....	116
7-3-3	Non-fatal Errors .....	116
7-3-4	Fatal Errors .....	117
7-4	Troubleshooting Flowcharts .....	118
7-5	Maintenance Inspections .....	125
7-6	Battery Replacement .....	126

## 7-1 Initial System Checks and Test Run Procedure

### 7-1-1 Initial System Checks

Check the following items after setting up and wiring the CPM2B, but before performing a test run.

Item	Points to check
Power supply and I/O connections	Is the wiring correct? Are the terminals securely tightened? Are there any shorts between crimp terminals or wires? Refer to 3-5 <i>Wiring and Connections</i> for details.
Connecting cables	Are the cables all connected correctly and locked? Refer to 3-5 <i>Wiring and Connections</i> for details.

#### Clearing Memory

Always clear memory before beginning to program the CPM2B. Although memory is cleared before the CPU Board is shipped, the contents of the DM, HR, AR, and counter areas may change in transit.

When a CPU Board without a clock is being used and the contents of DM have been cleared, battery error detection must be disabled in the PC Setup by setting the leftmost digit of DM 6655 to 1.

#### Operating Mode at Startup

See 1-3-3 *Operating Mode at Startup* to determine what mode the CPM2B will enter when the power is turned on.

### 7-1-2 Flash Memory Precautions

Observe the following precautions to protect the flash memory and ensure proper operation.

- 1, 2, 3...**
1. If changes are made in the read-only DM area (DM 6144 through DM 6599) or PC Setup (DM 6600 through DM 6655), the PC's operating mode must be changed to write the new contents to flash memory. If backup battery is replaced before the changes are written to flash memory, the changes will be lost.  
The changes can be saved by switching the CPM2B to RUN or MONITOR mode or turning the CPM2B OFF and then ON again.
  2. When contents of the program, read-only DM (DM 6144 through DM 6599), or PC Setup (DM 6600 through DM 6655) have been changed, startup processing will take up to 1,200 ms longer than usual. Be sure to take this one-time startup delay into account if it may affect operations.
  3. If one of the following three operations is performed in MONITOR or RUN mode, the CPM2B's cycle time will be extended by up to 1,200 ms and interrupts will be disabled while the program or PC Setup is being overwritten.
    - Program changes with the online edit operation
    - Changes to the read-only DM area (DM 6144 through DM 6599)
    - Changes to the PC Setup (DM 6600 through DM 6655)
 A "SCAN TIME OVER" error won't occur during these operations. Be sure to take this delay in the CPM2B's I/O response times into account when performing online editing.

## 7-2 CPM2B Test Run Procedure

- 1, 2, 3...**
1. Power Supply Application
    - a) Check the CPM2B's power supply voltage and terminal connections.
    - b) Check the I/O devices' power supply voltage and terminal connections.
    - c) Turn on the power supply and check that the "PWR" indicator lights.

- d) Use a Programming Device to set the CPM2B to PROGRAM mode.
2. I/O Wiring Checks
  - a) With the CPM2B in PROGRAM mode, check the output wiring by turning on the output bits with the force set and force reset operations.
  - b) Check the input wiring with the CPM2B's input indicators or a Programming Device's monitor operations.
3. Test Run
  - a) Use a Programming Device to set the CPM2B to RUN or MONITOR mode and check that the "RUN" indicator lights.
  - b) Check the sequence of operation with the force set/reset operations, etc.
4. Debugging
 

Correct any programming errors that are detected.
5. Saving the Program
  - a) Use a Programming Device to write the program to a backup floppy disk.
  - b) Print out a hard copy of the program with a printer.

**Note** Refer to *Section 4 Using Programming Devices* for details on the Support Software and Programming Console operations.

## 7-3 Self-diagnostic Functions

The CPM2B is equipped with a variety of self-diagnostic functions to help identify and correct errors and reduce down time.

### 7-3-1 Identifying Errors

An error can be identified by the error message displayed on a Programming Device, error flags in the AR and SR areas, and the error code output to SR 253.

#### Fatal and Non-fatal Errors

PC errors are divided into 2 categories based on the severity of the errors. The status of the ERR indicator (lit or flashing) shows which type of error has occurred.

#### **ERR Lit (Fatal Error)**

Fatal errors are serious errors which stop CPM2B operation. There are two ways to restart operation:

- Turn the PC off and then on again.
- Use a Programming Device to switch the PC to PROGRAM mode, and read/clear the error.

#### **ERR Flashing (Non-fatal Error)**

Non-fatal errors are less serious errors which don't stop CPM2B operation.

#### Error Messages

When an error is detected, a corresponding error message will be displayed on the Programming Console or other Programming Device connected to the PC.

#### Error Flags

When a hardware error is detected, the corresponding error flag in the AR or SR area will be turned ON.

#### Error Code

When an error is detected, a specific 2-digit hexadecimal error code is output to SR 25300 to SR 25307. The error code and time of occurrence are also output to the Error Log Area (DM 2000 to DM 2021).

 **WARNING** When the CPM2B's self-diagnosis function detects a fatal error or when a severe failure alarm (FALS) instruction is executed, PC operation will stop and all outputs will be turned OFF. External safety measures must be provided to ensure safety in the system. Not providing proper safety measures may result in serious accidents.

## 7-3-2 User-defined Errors

There are three instructions that can be used to define errors or messages. FAL(06) causes a non-fatal error, FALS(07) causes a fatal error, and MSG(46) sends a message to the Programming Console or host computer connected to the PC.

### FAILURE ALARM – FAL(06)

FAL(06) is an instruction that causes a non-fatal error. The following will occur when an FAL(06) instruction is executed:

- 1, 2, 3... 1. The ERR indicator on the CPU Board will flash. PC operation will continue.
2. The instruction's 2-digit BCD FAL number (01 to 99) will be written to SR 25300 to SR 25307.

The FAL numbers can be set arbitrarily to indicate particular conditions, but the same number should not be used as both an FAL number and an FALS number. To clear an FAL error, correct the cause of the error and then execute FAL 00 or use a Programming Device to clear the error.

### SEVERE FAILURE ALARM – FALS(07)

FALS(07) is an instruction that causes a fatal error. The following will occur when an FALS(07) instruction is executed:

- 1, 2, 3... 1. Program execution will be stopped and all outputs will be turned OFF.
2. The ERR indicator on the CPU Board will be lit.
3. The instruction's 2-digit BCD FALS number (01 to 99) will be written to SR 25300 to SR 25307.

The FALS numbers can be set arbitrarily to indicate particular conditions, but the same number should not be used as both an FAL number and an FALS number. To clear an FALS error, use a Programming Device to switch the PC to PROGRAM Mode, correct the cause of the error, and then clear the error.

### MESSAGE – MSG(46)

MSG(46) is used to display a message on a Programming Device connected to the CPM2B. The message, which can be up to 16 characters long, is displayed when the instruction's execution condition is ON.

## 7-3-3 Non-fatal Errors

PC operation and program execution will continue after one or more of these errors have occurred. Although PC operation will continue, the cause of the error should be corrected and the error cleared as soon as possible.

When one of these errors occurs, the POWER and RUN indicators will remain lit and the ERR indicator will flash.

Message	FAL No.	Meaning and appropriate response
SYS FAIL FAL** (** is 01 to 99 or 9B.)	01 to 99	An FAL(06) instruction has been executed in the program. Check the FAL number to determine conditions that would cause execution, correct the cause, and clear the error.
	9B	An error has been detected in the PC Setup. Check flags AR 1300 to AR 1302, and correct as directed.  AR 1300 ON: An incorrect setting was detected in the PC Setup (DM 6600 to DM 6614) when power was turned on. Correct the settings in PROGRAM Mode and turn on the power again.  AR 1301 ON: An incorrect setting was detected in the PC Setup (DM 6615 to DM 6644) when switching to RUN or MONITOR mode. Correct the settings in PROGRAM Mode and switch to RUN or MONITOR mode again.  AR 1302 ON: An incorrect setting was detected in the PC Setup (DM 6645 to DM 6655) during operation. Correct the settings and clear the error.
SCAN TIME OVER	F8	The cycle time has exceeded 100 ms. (SR 25309 will be ON.)  This indicates that the program cycle time is longer than recommended. Reduce cycle time if possible. (The CPM2B can be set so that this error won't be detected.)
Battery error (no message)	F7	If the voltage of the C500-BAT08 backup battery is below the minimum level, the ERR indicator will flash and SR 25308 will be turned ON. Replace the battery. (See 7-6 <i>Battery Replacement</i> for details.)



### 7-3-4 Fatal Errors

PC operation and program execution will stop and all outputs from the PC will be turned OFF when any of these errors have occurred. CPM2B operation can't be restarted until the PC is turned off and then on again or a Programming Device is used to switch the PC to PROGRAM mode and clear the fatal error.

All CPU Board indicators will be OFF for the power interruption error. For all other fatal operating errors, the POWER and ERR indicators will be lit. The RUN indicator will be OFF.

Message	FALS No.	Meaning and appropriate response
Power interruption (no message)	00	Power has been interrupted for more than 2 ms. Check power supply voltage and power lines. Try to power-up again.
MEMORY ERR	F1	AR 1308 ON: There is a non-existent bit or word address in the user program. Check the program and correct errors.
		AR 1309 ON: An error has occurred in flash memory. Replace the CPU Board.
		AR 1310 ON: A checksum error has occurred in read-only DM (DM 6144 to DM 6599). Check and correct the settings in the read-only DM area.
		AR 1311 ON: A checksum error has occurred in the PC Setup. Initialize the PC Setup and input the settings again.
		AR 1312 ON: A checksum error has occurred in the program. Check the program and correct any errors detected.
		AR 1313 ON: A checksum error has occurred in the expansion instructions data and all function codes have been set the their default values. Reset the expansion instructions.
		AR 1314 ON: Data was not maintained in an area specified for holding. Clear the error, check the data in the areas specified for holding, and try again.
NO END INST	F0	END(01) is not written in the program. Write END(01) at the end of the program.
I/O BUS ERR	C0	An error has occurred during data transfer between the CPU Board and an Expansion I/O Board. Check the Board's connecting cable.
I/O UNIT OVER	E1	Too many Expansion I/O Boards have been connected. Check the Board configuration.
SYS FAIL FALS** (** is 01 to 99 or 9F.)	01 to 99	A FALS(07) instruction has been executed in the program. Check the FALS number to determine the conditions that caused execution, correct the cause, and clear the error.
	9F	The cycle time has exceeded the Maximum (Watch) Cycle Time setting (DM 6618). Check the cycle time and adjust the Maximum Cycle Time setting if necessary.

# 7-4 Troubleshooting Flowcharts

Use the following flowcharts to troubleshoot errors that occur during operation.

## Main Check

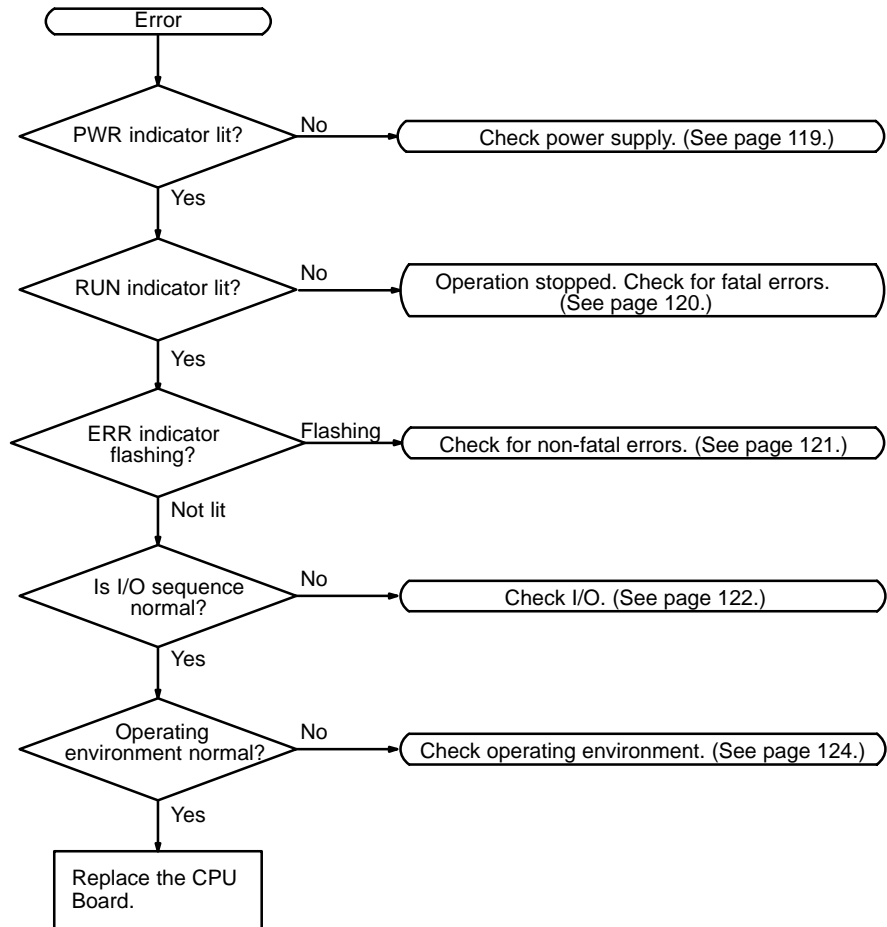

Power Supply Check

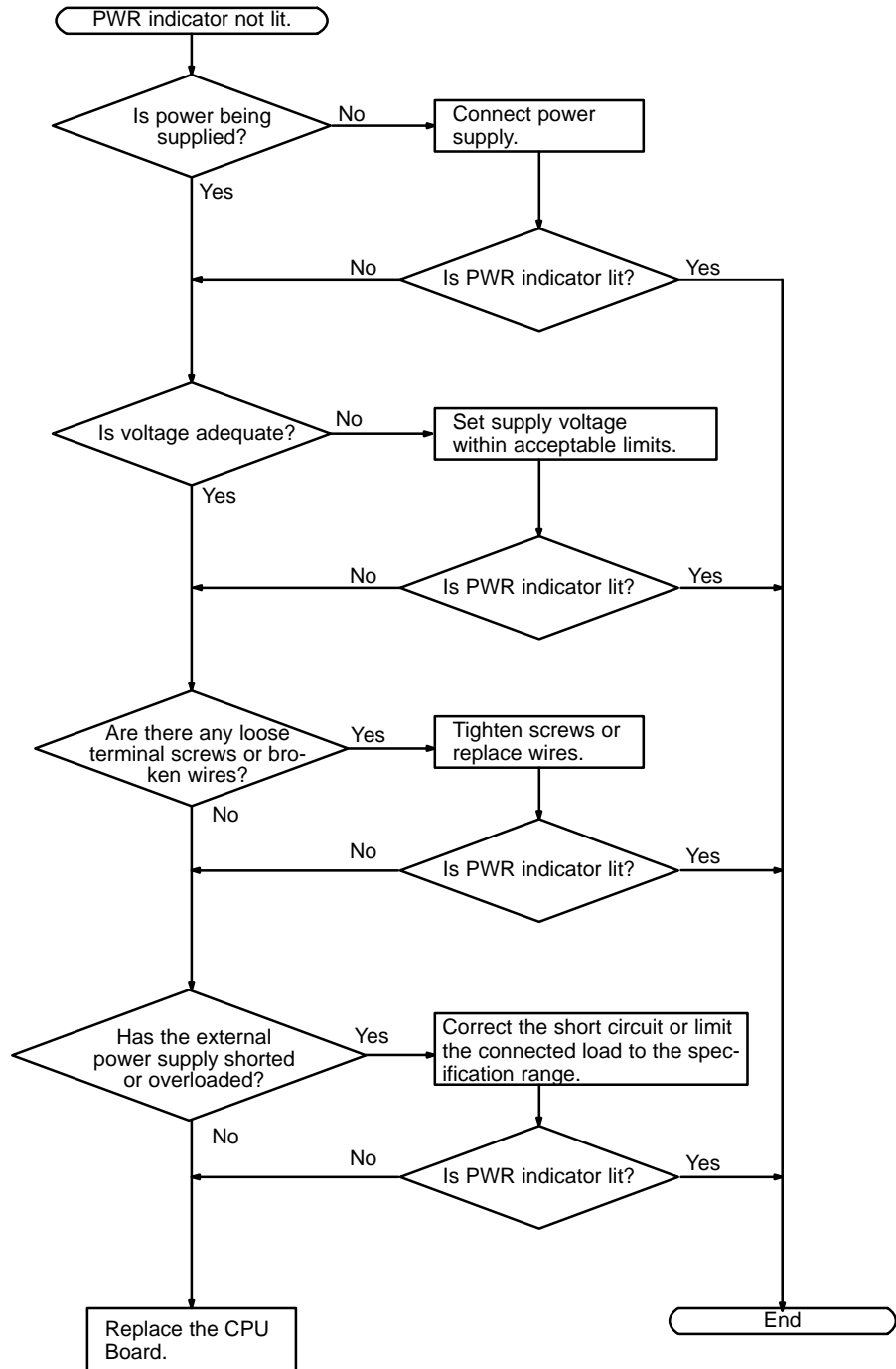

Fatal Error Check

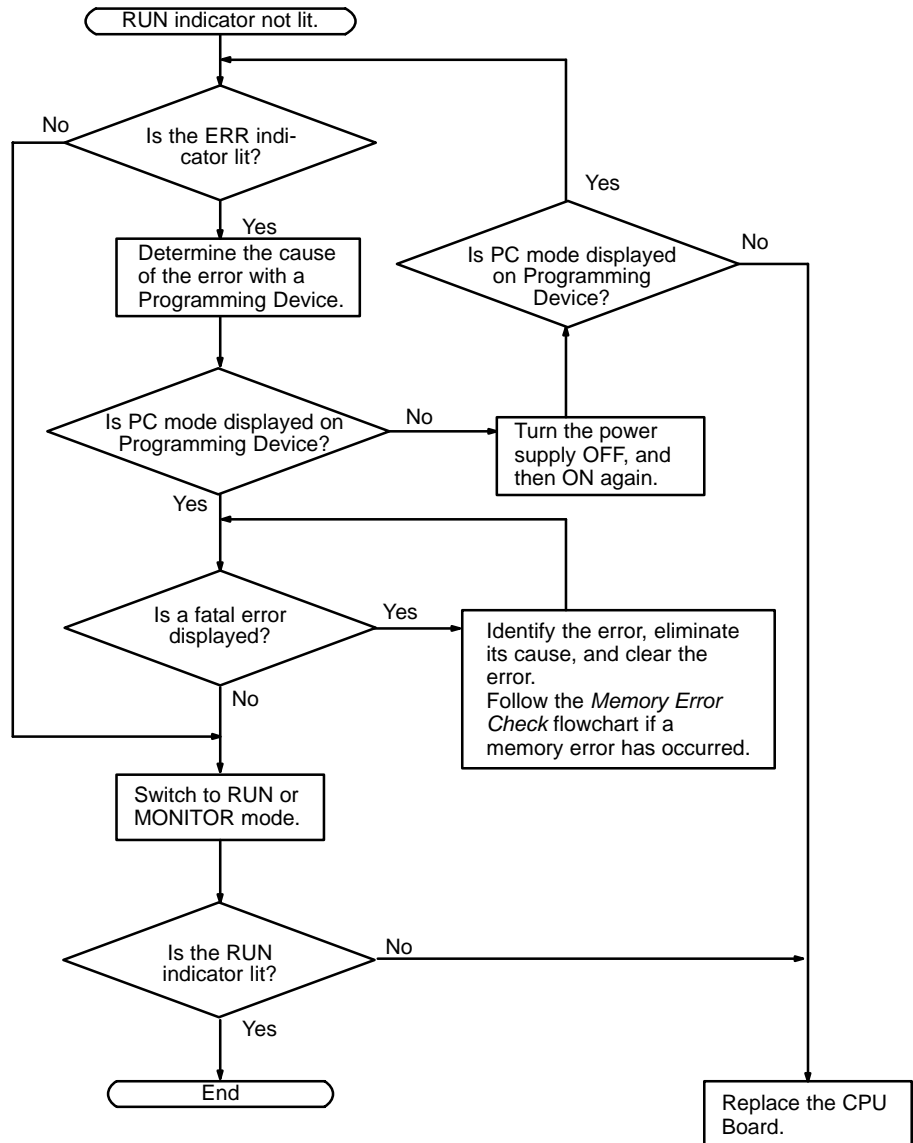

Non-fatal Error Check

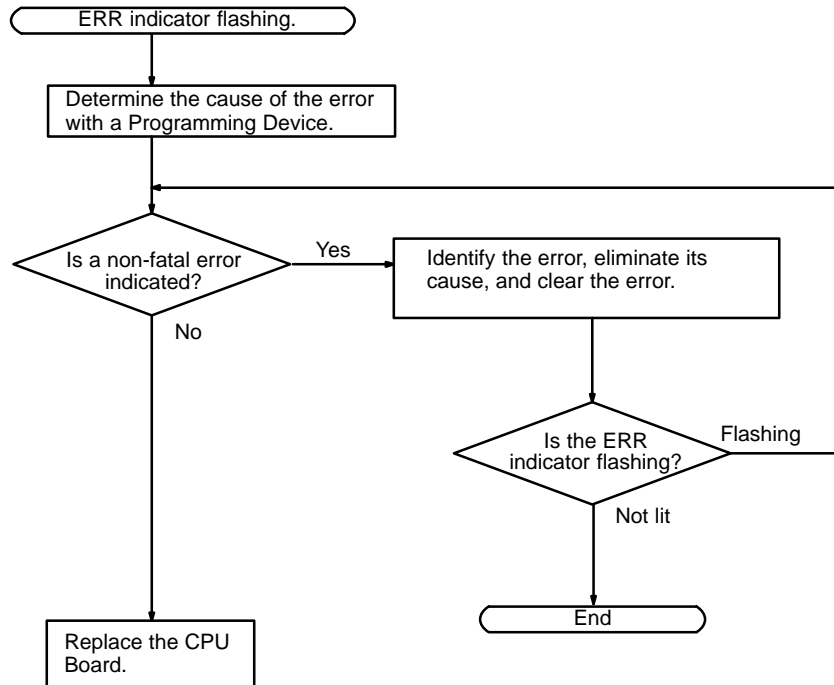

I/O Check

The I/O check flowchart is based on the following ladder diagram section.

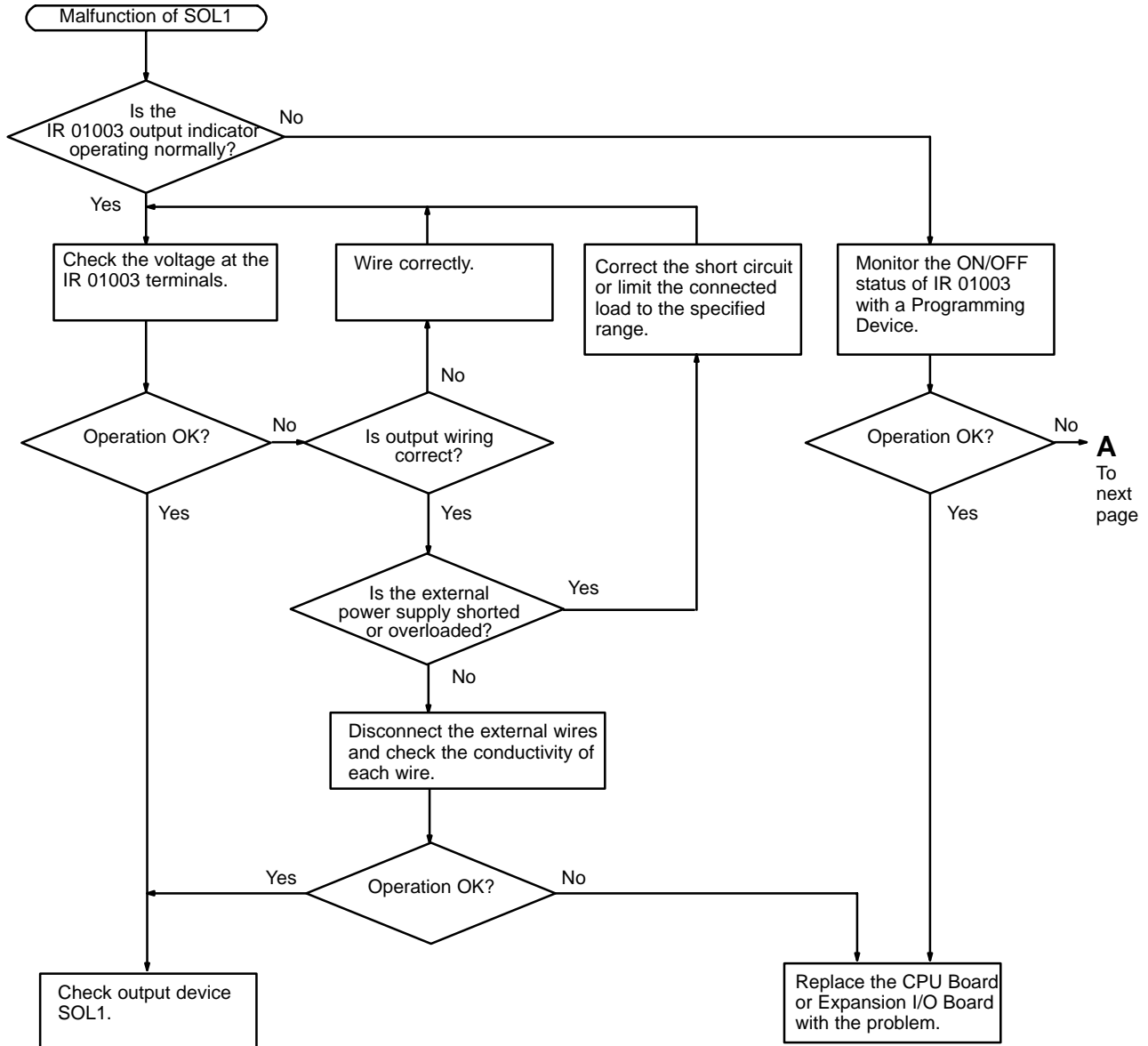
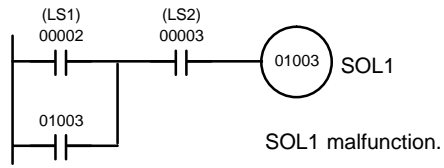

**A**  
To next page

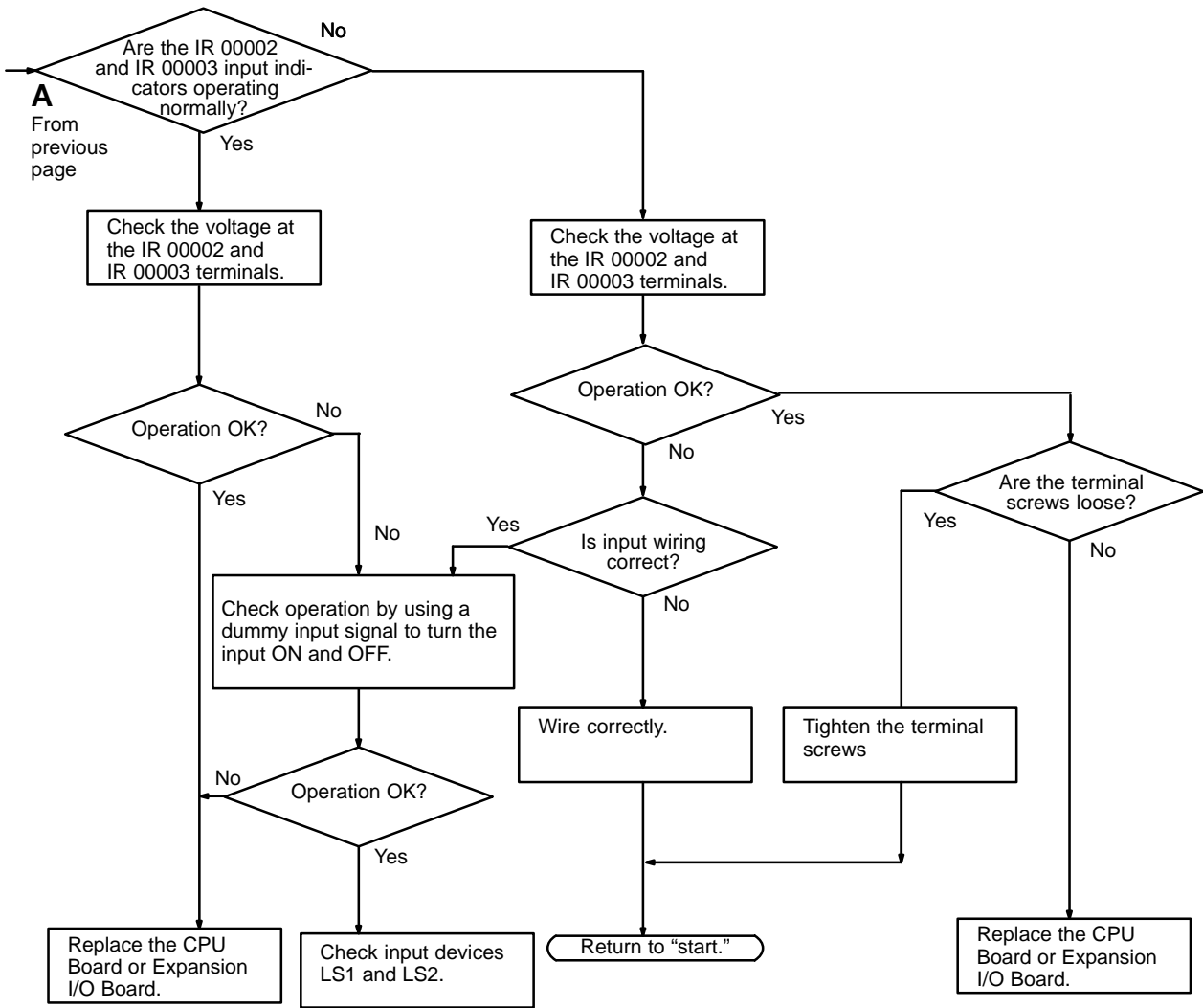

Environmental Conditions Check

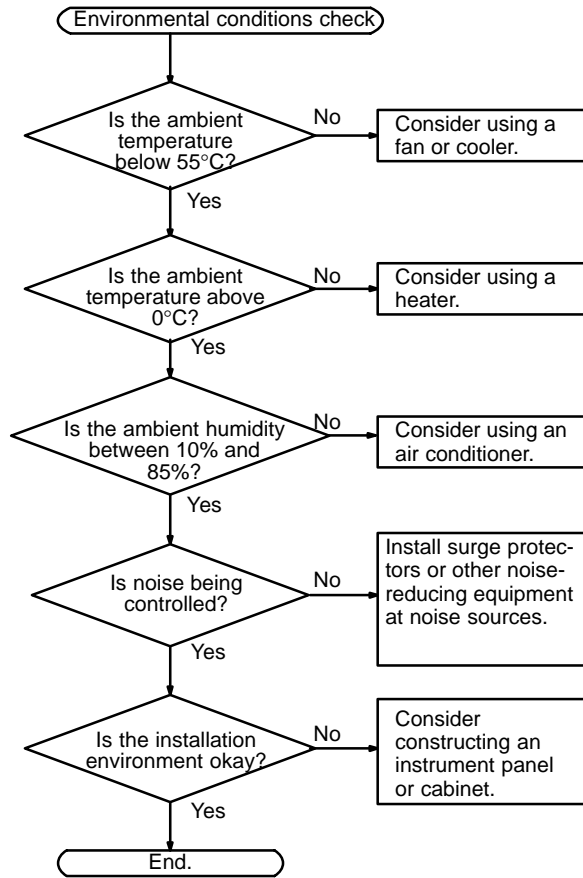



Memory Error Check

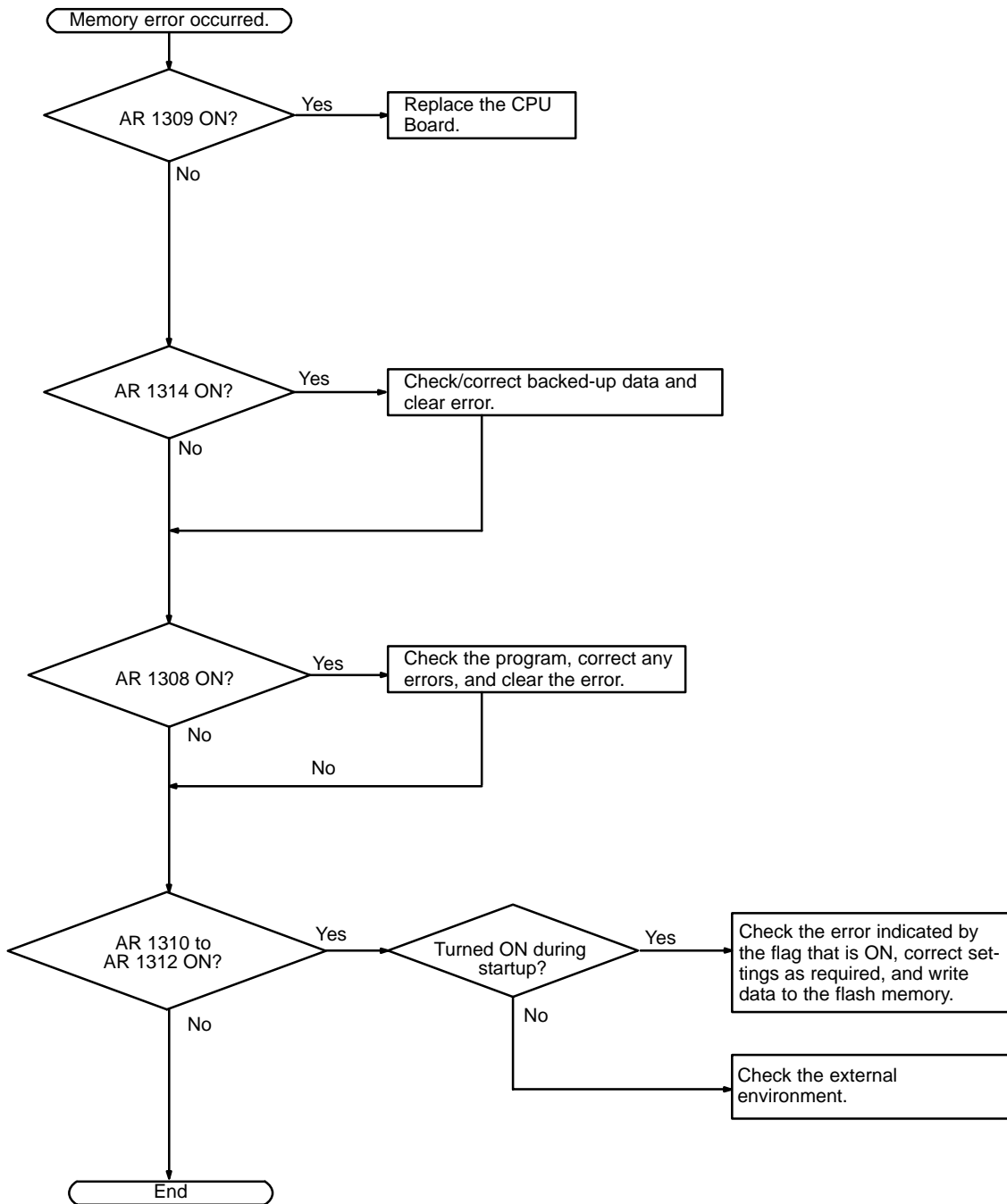

## 7-5 Maintenance Inspections

In order for your SYSMAC system to operate in optimum condition, be sure to carry out daily or periodical inspections.

### Inspection Items

The main system components of a SYSMAC system are semiconductors, and it contains few components with limited lifetimes. Poor environmental conditions, however, can lead to deterioration of the electrical components, making regular maintenance necessary.

The standard period for maintenance checks is 6 months to 1 year, but more frequent checks are required if the PC is operated in more demanding conditions. If the criteria are not met, adjust to within the specified ranges.

Inspection items	Details	Criteria	Remarks
Power supply	Determine whether the voltage fluctuation at the power supply terminals is within specifications.	Within the voltage variation range (20.4 to 26.4 VDC)	Tester
Environmental conditions	Is the ambient temperature inside the panel appropriate?	0 to 55°C	Thermometer
	Is the ambient humidity inside the panel appropriate?	35% to 85% RH with no condensation	Hygrometer
	Has dirt or dust collected?	None	Visual inspection
I/O power supply	Is the voltage fluctuation measured at the I/O terminals within the standard range?	Each I/O terminal must conform to the specifications	Tester
Installation status	Are all Boards securely installed?	Nothing is loose	Phillips screwdriver
	Are all connection cables and connectors inserted completely and locked?	Nothing is loose	Visual inspection
	Are any of the external wiring screws loose?	Nothing is loose	Phillips screwdriver
	Are any of the external wiring cables frayed?	No external abnormalities	Visual inspection
Product service life	Contact output relay	Electrical: Resistance load: 300,000 operations Inductive load: 100,000 operations  Mechanical: 10,000,000 operations	---
	Battery (C500-BAT08)	5 years	---

**Required Tools**

**Standard Tools (Required)**

- Screwdrivers (Phillips and flat-blade)
- Voltage tester or digital voltage meter
- Industrial alcohol and a cotton cloth

**Measurement Devices (May be Needed)**

- Synchroscope
- Cathode-ray oscilloscope
- Thermometer, hygrometer

**Note** Do not attempt to disassemble, repair, or modify the PC in any way.

## 7-6 Battery Replacement

 **WARNING** Do not drop, disassemble, crush, short-circuit, recharge, or dispose of the battery in fire. The battery may explode, burn, or leak and cause personal injury.

**Precautions**

Turn ON the power supply for at least 5 minutes before replacing the battery in order to recharge the backup capacitor.

Turn OFF the power supply to the CPU Board before replacing the battery.

Use the procedure below when replacing the battery. This procedure must be completed within 5 minutes to prevent loss of memory contents.

Dispose of the old battery properly.

**Replacement Procedure**

CPU Boards that are equipped with a clock are also equipped with a backup battery that has a 5-year lifetime at 25°C. Use the following procedure when replacing the backup battery.

- 1, 2, 3...** 1. Stop CPM2B operation and turn OFF the CPM2B's power supply.

2. Disconnect the battery connector and remove the battery.

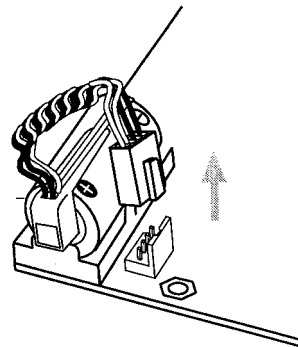

3. Install the new battery. Check the alignment of the connector and fully insert the connector. Make sure that the power wires are not pinched.

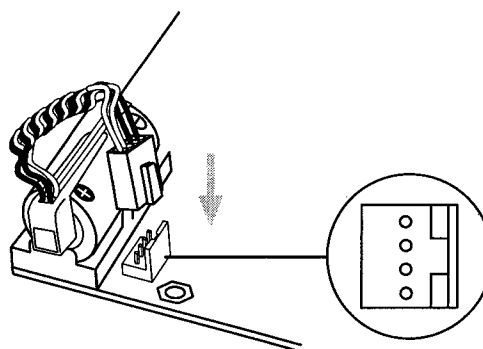

4. Enable the detection of battery errors in the PC Setup by setting the leftmost digit of DM 6655 to 0.

# Appendix A

## Standard Models

### CPU Boards

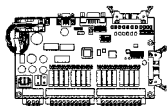
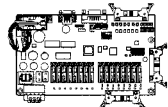
Appearance	Relay outputs	Transistor outputs (sinking)	Internal clock, RS-232C port, and battery	Number of inputs	Number of outputs
	CPM2B-32C1DR-D	---	No	16 points	16 points
	CPM2B-32C2DR-D	---	Yes		
	---	CPM2B-32C1DT-D	No		
	---	CPM2B-32C2DT-D	Yes		

Accessories: Four studs, four M3 screws

### Expansion I/O Boards

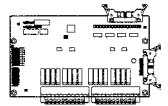
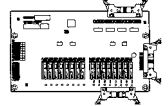
Appearance	Relay outputs	Transistor outputs (sinking)	Power supply	Number of inputs	Number of outputs
	CPM2B-32EDR	---	---	16 points	16 points
	---	CPM2B-32EDT	---	16 points	16 points

Accessories: Four long studs, four M3 screws



### Expansion I/O Cable

Appearance	Model	Specifications
	CPM2B-CN601	Connects an Expansion I/O Board to the CPU Board or another Expansion I/O Board. (This cable is identical to the cable supplied with an Expansion I/O Board.)

### Mounting Bracket

Appearance	Model	Specifications
	CPM2B-ATT01	Includes four M3 × 4 mounting screws. <b>Note</b> The CPM2B-ATT01 Mounting Bracket is required when the system must meet UL/CSA standards.

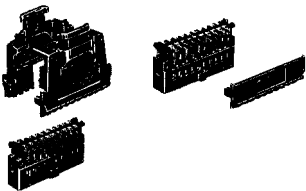

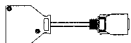
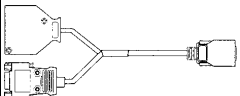

## I/O Connectors

Appearance	Model	Name
	XG5M-2032-N	Socket (for AWG 24 wire)
	XG5M-2035-N	Socket (for AWG 26 to AWG 28 wire)
	XG5S-2012	Full Cover (two are required for each socket)
	XG5S-1001	Partial Cover (two are required for each socket)
	XG4M-2030	Socket
	XG4T-2004	Strain Relief

## Communications Port Connecting Cables

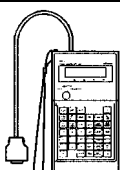
Appearance	Name	Specifications	Length
	CS1W-CN114 Connecting Cable	Peripheral port to Programming Console cable.	0.05 m
	CPM2C-CN111 Connecting Cable	Peripheral port to Programming Console cable.	0.1 m



## Peripheral Devices

Appearance	Model Number	Name	Specifications
	CQM1-PRO01-E	Programming Console	2-m Connecting Cable attached
		C200H-PRO27-E	
C200H-CN222			Connects the C200H-PRO27-E. 2-m cable
C200H-CN422			4-m cable
CS1W-CN224			Connects the C200H-PRO27-E directly to a CPM2B CPU Board. 2-m cable
	CS1W-CN624		6-m cable
	WS02-CXPC1-E	CX-Programmer	For MS-Windows 95/98/NT (CD-ROM)
	C500-ZL3AT1-E	SYSMAC Support Software	3.5", 2HD for IBM PC/AT compatible
	WS01-CPTB1-E	SYSMAC-CPT	For IBM PC/AT or compatible computers (3.5" disks (2HD) and CDROM)

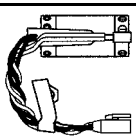
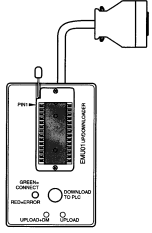
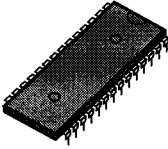

## Maintenance Accessories

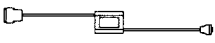
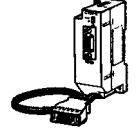
Appearance	Model Number	Name	Specifications
	C500-BAT08	Backup Battery	---
	CPM1-EMU01-V1	Expansion Memory Unit	Uploads the ladder program and DM 6144 to DM 6655 from the PC to the EEPROM and downloads the ladder program and DM 6144 to DM 6655 from the EEPROM to the PC.
	EEROM-JD	EEPROM	256 K bit

## Adapters and Connecting Cables (1:1 Connection)

CPM2B port	Appearance	Model number	Name	Comments	Cable length
Peripheral		CQM1-CIF02	RS-232C Adapter	For a 9-pin computer serial port	3.3 m
		CPM1-CIF01		Use for peripheral port to RS-232C level conversion	
RS-232C		XW2Z-200S-V	RS-232C Cable	For a 9-pin computer serial port	2 m
		XW2Z-500S-V			5 m

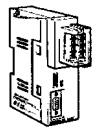
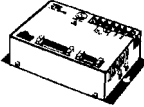
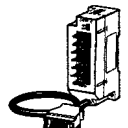
## Adapters and Connecting Cables (1:N Connections)

Appearance	Model number	Name	Specifications
	NT-AL001-E	RS-422 Adapter	Use for CPM2B RS-232C port to RS-422A conversion. Requires a 5-VDC, 150 mA power supply which is supplied through the CPM2B connection. (Can also be connected to a personal computer, but this connection requires an external 5-VDC power supply.)
	3G2A9-AL004-E	Link Adapter	Use for personal computer RS-232C port to RS-422A. (Can also be connected to a CPM2B.)
	CPM1-CIF11	RS-422 Adapter	Use for CPM2B peripheral port to RS-422A conversion.
	XW2Z-070T-1	RS-232C Cables (For use with the NT-AL001-E.)	Use for CPM2B RS-232C port to NT-AL001-E connection. (0.7-m cable)
	XW2Z-200T-1		Use for CPM2B RS-232C port to NT-AL001-E connection. (2-m cable)

# Appendix B

## Dimensions

All dimensions are in millimeters.

### CPU Boards and Expansion I/O Boards

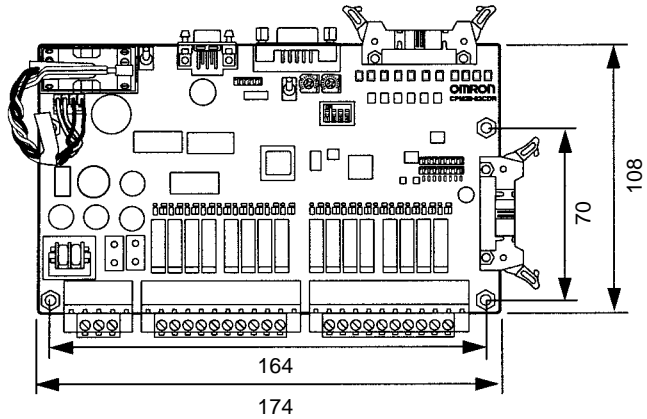

### Mounting Bracket (CPM2B-ATT01)

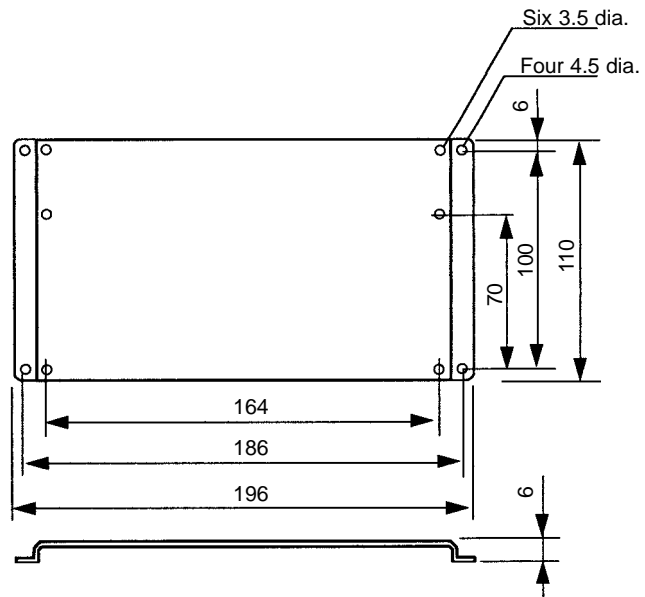

# Assembly Dimensions

Front view

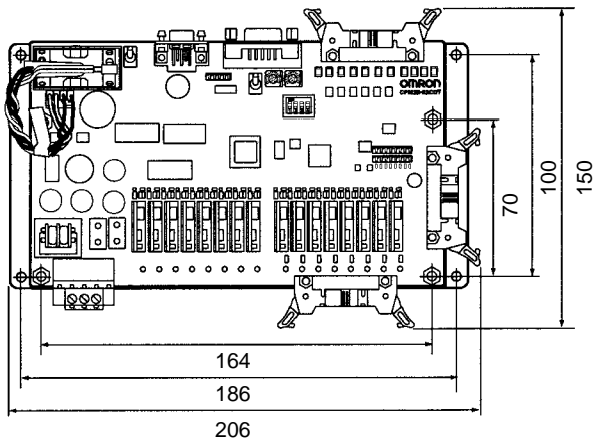

Side view

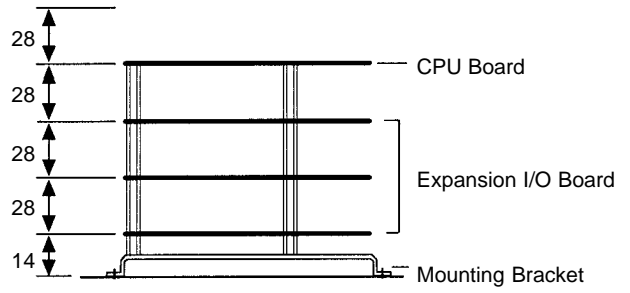



# Index

## Numbers

1:N connections, 10

## A

arc killer, examples, xvii

ASCII, converting displays, Programming Console, 105

atmosphere, 22

## B

battery, replacing, 126

binary data, modifying, Programming Console, 101

bit status, force-set/reset, Programming Console, 104

bits, searching, Programming Console, 92

buzzer operation, Programming Console, 86

## C

cabinet

installation, precautions, 37

Programming Console installation, 82

cables, available models, 130, 131

characteristics, 23

checking, program syntax, Programming Console, 94

circuit configuration

inputs, 25

outputs, relay, 27

clearing, memory areas, Programming Console, 85

clock, reading and setting the clock, 106

communications capabilities, overview, 4

components, Expansion I/O Boards, 32

conduit installation, 41

counters

changing SV, Programming Console, 100

example of inputting, 110

CPU Boards

available models, 129

dimensions, 133

CPU Units

cyclic operation, 16

internal structure, 13

CX-Programmer, 8

cycle time, displaying, Programming Console, 105

cyclic operation, 16

## D

data, modifying, Programming Console, 99–100, 101, 102, 103

data link, 5, 12

date. *See* clock

decimal data with sign. *See* signed decimal data

decimal data without sign. *See* unsigned decimal data

dielectric strength, 22

differentiated instructions, entering, 90

dimensions, 133

displays

converting between hex and ASCII, Programming Console, 105

cycle time, Programming Console, 105

duct installation, 40

## E

EC Directives, precautions, xv

electrical noise, preventing, 37, 40

ERR indicator

flashing, 116

lit, 117

error log, 69

errors

error processing, 113

fatal, 117

identifying, 115

non-fatal, 116

PC Setup, 65

reading/clearing messages, Programming Console, 86

user-defined errors, 116

Expansion I/O Boards

available models, 129

components, 32

dimensions, 133

Expansion I/O Cable, available models, 129

expansion instructions

function codes, 76

reading and changing function code assignments, 87

## F–H

FAL numbers, 116

FAL(06), 116

FALS numbers, 117

FALS(07), 116

false inputs, 48

fatal errors, troubleshooting, 120

features, 2  
flash memory, precautions, 114  
flicker output, example, 111  
force-set/reset  
  clearing, Programming Console, 104  
  Programming Console, 104  
function codes  
  expansion instructions, 76  
  reading and changing expansion instruction assignments, 87  
functions, 5  
hexadecimal data, converting displays, Programming Console, 105

## I-L

I/O capacity, 23  
I/O connectors  
  available models, 130  
  pin allocation, Expansion I/O Units, 33  
  wiring, 43  
I/O errors, troubleshooting, 122  
I/O line noise, preventing, 40  
I/O terminals, allocation, Expansion I/O Units, 33  
indicators  
  flashing ERR indicator, 116  
  lit ERR indicator, 117  
  PC status indicators, 30  
inductive loads, 48, 51  
initialization, time required, 15  
input devices, connecting, 46  
input specifications, 25, 27  
inputs, wiring, 45  
inrush current, suppressing, 52  
inspections, 125  
installation, site, selecting, 36  
instructions  
  expansion, 76  
  inserting and deleting, Programming Console, 93  
  mnemonics list, ladder, 73  
  searching, Programming Console, 91  
insulation resistance, 22  
interlocks, 36  
interrupt program execution, in cyclic operation, 18  
leakage current, 48  
LED indicators, 30  
limit switches, preventing false inputs, 48

## M

maintenance, 125  
memory  
  backup, 24  
  protection, 24  
memory areas  
  AR area bits, CPM2A/CPM2C, 60  
  clearing, Programming Console, 85  
  flags and control bits, CPM2A/CPM2C, 58  
  partial clear, 85  
messages, reading/clearing, 86  
mode, changing the PC mode, 80  
modes, operating modes, 14  
modifying  
  binary data, Programming Console, 101  
  data, Programming Console, 99  
  hexadecimal/BCD data, Programming Console, 101  
  signed decimal data, Programming Console, 102  
  SV, Programming Console, 100  
  unsigned decimal data, Programming Console, 103  
MONITOR mode  
  description, 80  
  example test run, 112  
monitoring  
  3-word monitor, Programming Console, 98  
  binary monitor, Programming Console, 97–98  
  differentiation monitor, Programming Console, 96–97  
  signed decimal monitor, Programming Console, 98–99  
  status, Programming Console, 94  
  unsigned decimal monitor, Programming Console, 99  
motor control, capabilities, 2  
MSG(46), 116

## N

noise, preventing electrical noise, 37, 40  
noise immunity, 22  
non-fatal errors, troubleshooting, 121  
NPN current output, connecting, 46  
NPN open collector, connecting, 46  
NT Link, connections, 11

## O

operating conditions, troubleshooting, 124  
operating modes, 14  
  operating mode at startup, 14  
operation, preparations, 82  
output short protection, 51  
output specifications  
  relay output, 27  
  transistor output, sink type, 28

output wiring, relay output, 49

## **P–R**

panel, Programming Console installation, 82

panel installation, precautions, 37

password, entering on Programming Console, 83

PC mode, changing, 80

PC Setup. *See* settings

PC status, indicators, 30

Peripheral Devices, 130

available models, 130

photoelectric switches, preventing false inputs, 48

PNP current output, connecting, 46

position control, 3

power, consumption, 22

power cables, 40

power interruption, detection, 15

power supply

precautions, 36

troubleshooting, 119, 125

wiring, 41

precautions

design precautions, 36

general, xi

program, programming example, 106

program capacity, 23

program execution, in cyclic operation, 17

program memory, setting address and reading content, Programming Console, 88

PROGRAM mode, description, 80

programming

checking the program, 111–112

checks for syntax, Programming Console, 94

inserting and deleting instructions, Programming Console, 93–94

preparation for, 106

searching, Programming Console, 91–92

setting and reading a memory address, Programming Console, 88

special features, 76

Programming Console

connecting, 81

connections, 8

keys, 78

models, 78

operations, 84

Programming Devices, using, 77

programming example, 106

programs, entering and editing, Programming Console, 88

proximity switches, preventing false inputs, 48

pulse control, 2

pulse outputs, 3

wiring, 51

quick-response inputs, 3

relay outputs, connecting, 46

Relay Terminals, connections, 44

RUN mode, description, 80

## **S**

search

instruction, Programming Console, 91–92

operands, Programming Console, 92

self-diagnosis functions, 24

self-holding bit, example, 109

self-diagnostic functions, 115

settings, changing, 64

shock resistance, 22

signed decimal data

modifying, Programming Console, 102

monitoring, 98–99

specifications

characteristics, 23

general specifications, 22

input specifications, 25, 27

output specifications

relay output, 27

transistor output, sink type, 28

terminal blocks, 42

status, monitoring, Programming Console, 94

Support Software, 8

SV, modifying, Programming Console, 100

syntax, checking the program, Programming Console, 94

SYSMAC Support Software, 8

SYSMAC-CPT Support Software, 8

system, checks, 114

system configuration, 6

## **T**

temperature, operating, storage, 22

temperature, ambient, 22

terminal blocks

connections, 44

specifications, 42

wiring, 42

test run

example, 112

procedure, 114

time. *See* clock

timers

changing SV, Programming Console, 100  
example of inputting, 110

troubleshooting, 118  
fatal errors, 120  
I/O errors, 122  
non-fatal errors, 121  
operating conditions, 124  
power supply, 119, 125

## **U**

unsigned decimal data

modifying, Programming Console, 103  
monitoring, 99

## **V-W**

vibration resistance, 22  
voltage, supply voltage, 22  
voltage output, connecting, 46  
wiring, 40  
I/O connectors, 43  
power supply, 41  
terminal blocks, 42

## Revision History

A manual revision code appears as a suffix to the catalog number on the front cover of the manual.

Cat. No. W371-E1-1

↑  
Revision code

The following table outlines the changes made to the manual during each revision. Page numbers refer to the previous version.

Revision code	Date	Revised content
1	February 2000	Original production

## Free Manuals Download Website

<http://myh66.com>

<http://usermanuals.us>

<http://www.somanuals.com>

<http://www.4manuals.cc>

<http://www.manual-lib.com>

<http://www.404manual.com>

<http://www.luxmanual.com>

<http://aubethermostatmanual.com>

Golf course search by state

<http://golfingnear.com>

Email search by domain

<http://emailbydomain.com>

Auto manuals search

<http://auto.somanuals.com>

TV manuals search

<http://tv.somanuals.com>