

ONKYO®

English

Audio CD Recorder **CDR-201A**

Before using

Connections

Operations

Other Information

Operating Instructions

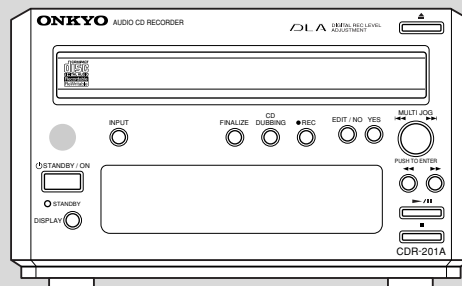

COMPACT
disc
DIGITAL AUDIO

COMPACT
disc
DIGITAL AUDIO
Recordable

COMPACT
disc
DIGITAL AUDIO
ReWritable

Before using Thank you for purchasing ...

Thank you for purchasing the ONKYO CDR-201A CD Recorder.
Please read this manual thoroughly before making connections and plugging in the unit.
Following the instructions in this manual will enable you to obtain the optimum performance and listening enjoyment from your new CDR-201A.
Please retain this manual for future reference.

Main Features

- CD/CD-R/CD-RW Disc Compatibility
- 32kHz/44.1kHz/48kHz Sampling-Rate Converter
- 2 Optical Digital Inputs
- 2-Mode (Album/Fade) One-Touch CD Recording
- Name input function allowing you to specify a disc name and track titles.
- Adjustable Recording Volume (Digital/Analog)
- Auto Finalizing Function
- High-Resolution D/A & A/D Converter
- 1 Optical Digital Output
- Signal Synchro Recording
- RI Compatible Remote Control Included

WARNING:

TO REDUCE THE RISK OF FIRE OR ELECTRIC SHOCK, DO NOT EXPOSE THIS APPLIANCE TO RAIN OR MOISTURE.



CAUTION:

TO REDUCE THE RISK OF ELECTRIC SHOCK, DO NOT REMOVE COVER (OR BACK). NO USER-SERVICEABLE PARTS INSIDE. REFER SERVICING TO QUALIFIED SERVICE PERSONNEL.



The lightning flash with arrowhead symbol, within an equilateral triangle, is intended to alert the user to the presence of uninsulated "dangerous voltage" within the product's enclosure that may be of sufficient magnitude to constitute a risk of electric shock to persons.

The exclamation point within an equilateral triangle is intended to alert the user to the presence of important operating and maintenance (servicing) instructions in the literature accompanying the appliance.

Important Safeguards

1. **Read Instructions** – All the safety and operating instructions should be read before the appliance is operated.
2. **Retain Instructions** – The safety and operating instructions should be retained for future reference.
3. **Heed Warnings** – All warnings on the appliance and in the operating instructions should be adhered to.
4. **Follow Instructions** – All operating and use instructions should be followed.
5. **Cleaning** – Unplug the appliance from the wall outlet before cleaning. The appliance should be cleaned only as recommended by the manufacturer.
6. **Attachments** – Do not use attachments not recommended by the appliance manufacturer as they may cause hazards.
7. **Water and Moisture**– Do not use the appliance near water –for example, near a bath tub, wash bowl, kitchen sink, or laundry tub; in a wet basement; or near a swimming pool; and the like.
8. **Accessories** – Do not place the appliance on an unstable cart, stand, tripod, bracket, or table. The appliance may fall, causing serious injury to a child or adult, and serious damage to the appliance. Use only with a cart, stand, tripod, bracket, or table recommended by the manufacturer, or sold with the appliance. Any mounting of the appliance should follow the manufacturer's instructions, and should use a mounting accessory recommended by the manufacturer.
9. An appliance and cart combination should be moved with care. Quick stops, excessive force, and

PORTABLE CART WARNING



53125A

Important Safeguards

uneven surfaces may cause the appliance and cart combination to overturn.

10. **Ventilation** – Slots and openings in the cabinet are provided for ventilation and to ensure reliable operation of the appliance and to protect it from overheating, and these openings must not be blocked or covered. The openings should never be blocked by placing the appliance on a bed, sofa, rug, or other similar surface. The appliance should not be placed in a builtin installation such as a bookcase or rack unless proper ventilation is provided. There should be free space of at least 5 cm (2 in.) and an opening behind the appliance.
11. **Power Sources** – The appliance should be operated only from the type of power source indicated on the marking label. If you are not sure of the type of power supply to your home, consult your appliance dealer or local power company.
12. **Grounding or Polarization** – The appliance may be equipped with a polarized alternating current line plug (a plug having one blade wider than the other). This plug will fit into the power outlet only one way. This is a safety feature. If you are unable to insert the plug fully into the outlet, try reversing the plug. If the plug should still fail to fit, contact your electrician to replace your obsolete outlet. Do not defeat the safety purpose of the polarized plug.
13. **Power-Cord Protection** – Powersupply cords should be routed so that they are not likely to be walked on or pinched by items placed upon or against them, paying particular attention to cords at plugs, convenience receptacles, and the point where they exit from the appliance.
14. **Lightning** – For added protection for the appliance during a lightning storm, or when it is left unattended and unused for long periods of time, unplug it from the wall outlet and disconnect the antenna or cable system. This will prevent damage to the appliance due to lightning and power-line surges.
15. **Overloading** – Do not overload wall outlets, extension cords, or integral convenience receptacles as this can result in a risk of fire or electric shock.
16. **Object and Liquid Entry** – Never push objects of any kind into the appliance through openings as they may touch dangerous voltage points or short-out parts that could result in a fire or electric shock. Never spill liquid of any kind on the appliance.
17. **Servicing** – Do not attempt to service the appliance yourself as opening or removing covers may expose you to dangerous voltage or other hazards. Refer all servicing to qualified service personnel.
18. **Damage Requiring Service** – Unplug the appliance from the wall outlet and refer servicing to qualified service personnel under the following conditions:
 - A. When the power-supply cord or plug is damaged,
 - B. If liquid has been spilled, or objects have fallen into the appliance,
 - C. If the appliance has been exposed to rain or water,
 - D. If the appliance does not operate normally by following the operating instructions. Adjust only those controls that are covered by the operating instructions as an improper adjustment of other controls may result in damage and will often require extensive work by a qualified technician to restore the appliance to its normal operation,
 - E. If the appliance has been dropped or damaged in any way, and
 - F. When the appliance exhibits a distinct change in performance – this indicates a need for service.
19. **Replacement Parts** – When replacement parts are required, be sure the service technician has used replacement parts specified by the manufacturer or have the same characteristics as the original part. Unauthorized substitutions may result in fire, electric shock, or other hazards.
20. **Safety Check** – Upon completion of any service or repairs to the appliance, ask the service technician to perform safety checks to determine that the appliance is in proper operation condition.
21. **Wall or Ceiling Mounting** – The appliance should be mounted to a wall or ceiling only as recommended by the manufacturer.
22. **Heat** – The appliance should be situated away from heat sources such as radiators, heat registers, stoves, or other appliances (including amplifiers) that produce heat.

Precautions

1. Recording Copyright

Recording of copyrighted material for other than personal use is illegal without permission of the copyright holder.

2. Power

WARNING

BEFORE PLUGGING IN THE UNIT FOR THE FIRST TIME, READ THE FOLLOWING SECTION CAREFULLY.

The voltage of the available power supply differs according to country or region. Be sure that the power supply voltage of the area where this unit will be used meets the required voltage (e.g., AC 230 V, 50 Hz or AC 120 V, 60 Hz) written on the rear panel.

Turning off the standby button does not shut off the power completely. So the power cord should be removed from the AC outlet when the unit is not used for a prolonged time.

3. Do not touch this unit with wet hands

Do not handle this unit or power cord when your hands are wet or damp. If water or any other liquid enters the case, take this unit to an authorized service center for inspection.

4. Location of this unit

Place this unit in a well-ventilated location.

Take special care to provide plenty of ventilation on all sides of this unit especially when it is placed in an audio rack. If ventilation is blocked, this unit may overheat and malfunction.

Do not expose this unit to direct sunlight or heating units as this unit's internal temperature may rise and shorten the life of the pickup.

Avoid damp and dusty places and places directly affected by vibrations from the speakers. In particular, avoid placing the unit on or above one of the speakers.

Be sure this unit is placed in a horizontal position. Never place it on its side or on a slanted surface as it may malfunction.

Do not place near tuners or TV sets.

If placed next to a TV or tuner, it may cause reception interference resulting in some noise in the TV or tuner output.

5. Care

From time to time you should wipe the front and rear panels and the cabinet with a soft cloth. For heavier dirt, dampen a soft cloth in a weak solution of mild detergent and water, wring it out dry, and wipe off the dirt. Following this, dry immediately with a clean cloth.

Do not use rough material, thinners, alcohol or other chemical solvents or cloths since these could damage the finish or remove the panel lettering.

6. Points to remember

If this unit is brought from a cold environment to a warm one or is in a cold room that is quickly heated, condensation may form on the pickup, preventing proper operation. In this case, remove the disc and leave the power ON for about one hour to remove the condensation.

When transporting this unit, be careful not to bump it.

DANGER:

INVISIBLE LASER RADIATION WHEN OPEN AND INTERLOCK FAILED OR DEFEATED. AVOID DIRECT EXPOSURE TO BEAM.

CAUTION:

THIS PRODUCT UTILIZES A LASER. USE OF CONTROLS OR ADJUSTMENTS OR PERFORMANCE OF PROCEDURES OTHER THAN THOSE SPECIFIED HEREIN MAY RESULT IN HAZARDOUS RADIATION EXPOSURE.

Precautions

For U.S. model

The laser is covered by a housing which prevents exposure during operation or maintenance. However, this product is classified as a Laser Product by CDRH (Center for Devices and Radiological Health) which is a department of the Food and Drug Administration. According to their regulations 21 CFR section 1002.30, all manufacturers who sell Laser Products must maintain records of written communications between the manufacturer, dealers and customers concerning radiation safety. If you have any complaints about instructions or explanations affecting the use of this product, please feel free to write to the address on the back page of this manual. When you write us, please include the model number and serial number of your unit.

In compliance with Federal Regulations, the certification, identification and the period of manufacture are indicated on the rear panel.

FCC INFORMATION FOR USER

CAUTION:

The user changes or modifications not expressly approved by the party responsible for compliance could void the user's authority to operate the equipment.

NOTE:

This equipment has been tested and found to comply with the limits for a Class B digital device, pursuant to Part 15 of the FCC Rules. These limits are designed to provide reasonable protection against harmful interference in a residential installation. This equipment generates, uses and can radiate radio frequency energy and, if not installed and used in accordance with the instructions, may cause harmful interference to radio communications. However, there is no guarantee that interference will not occur in a particular installation. If this equipment does cause harmful interference to radio or television reception, which can be determined by turning the equipment off and on, the user is encouraged to try to correct the interference by one or more of the following measures:

- Reorient or relocate the receiving antenna.
- Increase the separation between the equipment and receiver.
- Connect the equipment into an outlet on a circuit different from that to which the receiver is connected.
- Consult the dealer or an experienced radio/TV technician for help.



Memory Preservation

This unit does not require memory preservation batteries. A built-in memory power back-up system preserves the contents of the memory during power failures and even when the unit is unplugged. The unit must be plugged-in in order to charge the back-up system.

The memory preservation period after the unit has been unplugged varies depending on climate and placement of the unit. On the average, memory contents are protected over a period of a few weeks after the last time the unit was unplugged. This period is shorter when the unit is exposed to a highly humid climate.

Before Using

Precautions

For Canadian model

NOTE: THIS CLASS B DIGITAL APPARATUS COMPLIES WITH CANADIAN ICES-003.

For models having a power cord with a polarized plug:

CAUTION: TO PREVENT ELECTRIC SHOCK, MATCH WIDE BLADE OF PLUG TO WIDE SLOT, FULLY INSERT.

Modele pour les Canadien

REMARQUE: CET APPAREIL NUMÉRIQUE DE LA CLASSE B EST CONFORME À LA NORME NMB-003 DU CANADA.

Sur les modèles dont la fiche est polarisée:

ATTENTION: POUR ÉVITER LES CHOCS ÉLECTRIQUES, INTRODUIRE LA LAME LA PLUS LARGE DE LA FICHE DANS LA BORNE CORRESPONDANTE DE LA PRISE ET POUSSER JUSQU'AU FOND.

For European model

This unit contains a semiconductor laser system and is classified as a "CLASS 1 LASER PRODUCT". So, to use this model properly, read this Instruction Manual carefully. In case of any trouble, please contact the store where you purchased the unit. To prevent being exposed to the laser beam, do not try to open the enclosure.



This label on the right hand panel states that:

1. This unit is a CLASS 1 LASER PRODUCT and employs a laser inside the cabinet.
2. To prevent the laser from being exposed, do not remove the cover. Refer servicing to qualified personnel.

For British model

Replacement and mounting of an AC plug on the power supply cord of this unit should be performed only by qualified service personnel.

IMPORTANT

The wires in the mains lead are coloured in accordance with the following code:

Blue : Neutral

Brown : Live

As the colours of the wires in the mains lead of this apparatus may not correspond with the coloured markings identifying the terminals in your plug, proceed as follows:

The wire which is coloured blue must be connected to the terminal which is marked with the letter N or coloured black.

The wire which is coloured brown must be connected to the terminal which is marked with the letter L or coloured red.

IMPORTANT

A 5 ampere fuse is fitted in this plug. Should the fuse need to be replaced, please ensure that the replacement fuse has a rating of 5 amperes and that it is approved by ASTA or BSI to BS1362. Check for the ASTA mark or the BSI mark on the body of the fuse.

IF THE FITTED MOULDED PLUG IS UNSUITABLE FOR THE SOCKET OUTLET IN YOUR HOME, THEN THE FUSE SHOULD BE REMOVED AND THE PLUG CUT OFF AND DISPOSED OF SAFELY. THERE IS A DANGER OF SEVERE ELECTRICAL SHOCK IF THE CUT OFF PLUG IS INSERTED INTO ANY 13 AMPERE SOCKET.

If in any doubt, please consult a qualified electrician.

Table of contents

Before Using

Thank you for purchasing	2
Important Safeguards	2
Precautions	4
Table of contents	7
Supplied accessories	7
Using the remote controller	8
Part names and functions	10
Notes on usable CDs	13

Connections

Connecting to the Onkyo Separate Collection	15
Connecting the CDR-201A	16

Operations

Recording modes	18
Inserting a disc	20
CD dubbing (component system operation)	21
Synchronous recording (component system operation)	23
Analog recording	26
Digital recording	27
Synchronous recording by input digital signal detection	29
Using the level sync function	31
Changing the display	33
Entering names	34
Finalization	39
Erasing recordings (CD-RW discs only)	40
Playing CDs	44
Timer playback (component system operation)	47

Other Information

Display messages	47
Troubleshooting guide	48
Rules concerning digital recording	51
Specifications	Back cover

Supplied accessories

Check that the following accessories are supplied with the CDR-201A.

- Audio connection cables × 2

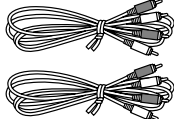

- Optical digital cable × 1



- RI cable × 1



- Remote controller × 1



- Dry-cell batteries (size AA, R06, or UM-3) × 2



Using the remote controller

■ Using the RC-466S remote controller that is supplied with the Onkyo Separate Collection R-801A components to operate the CDR-201A.

- For more details, refer to the R-801A operation manual.

Using the remote controller

When operating the remote controller, point it toward the remote control sensor of the tuner amplifier.

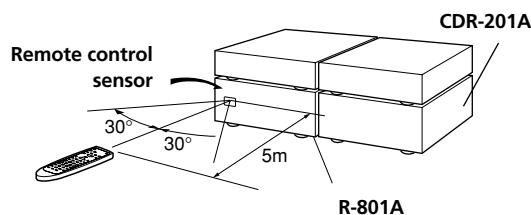

Notes:

- If the remote control sensor is subjected to direct sunlight or inverted fluorescent light, operation of the remote controller may be adversely affected.
- Use of another remote controller nearby or using the remote controller near equipment that uses infrared light may cause operational interference.
- Do not put objects on the remote controller. A button on the remote controller may remain pressed and drain the batteries.
- Make sure the CDR-201A is not placed behind colored glass doors. Placing the CDR-201A behind such doors may prevent proper operation of the remote controller.
- If there is an obstacle between the remote controller and the remote control sensor, the remote controller will not operate.

Using the remote controller

■ Using the RC-448C remote controller that is supplied with the CDR-201A to operate the CDR-201A

Installing the remote controller batteries

- ① Push the battery cover in the direction of the arrows shown and remove it.

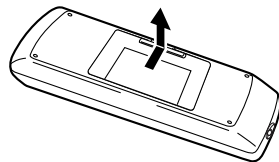

- ② Install the supplied (or AA, R06, or UM-3-sized) batteries into the battery compartment being careful not to mistake the polarity (follow the polarity diagram inside).

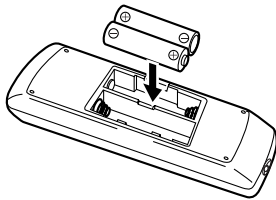

- ③ Replace the battery cover.

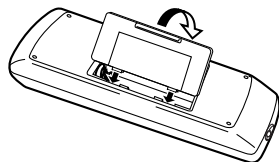

Notes:

- Do not mix new batteries with old batteries or different kinds of batteries.
- To avoid corrosion, remove the batteries if the remote controller will not be used for a long time.
- Immediately remove dead batteries to avoid damage to the remote controller from corrosion. If the remote controller begins to operate improperly, remove the old batteries and replace them with two new batteries.
- The life of the supplied batteries is approx. 1 year, though this value may vary depending on usage.

Using the remote controller

When operating the remote controller, point it toward the remote control sensor of the CDR-201A.

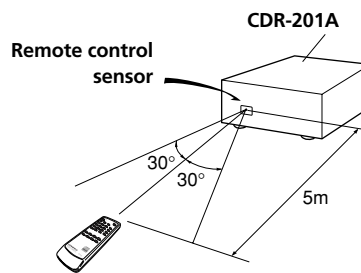

Notes:

- If the remote control sensor is subjected to direct sunlight or inverted fluorescent light, operation of the remote controller may be adversely affected.
- Use of another remote controller nearby or using the remote controller near equipment that uses infrared light may cause operational interference.
- Do not put objects on the remote controller. A button on the remote controller may remain pressed and drain the batteries.
- Make sure the CDR-201A is not placed behind colored glass doors. Placing the CDR-201A behind such doors may prevent proper operation of the remote controller.
- If there is an obstacle between the remote controller and the remote control sensor, the remote controller will not operate.

Before using

Part names and functions

Front Panel

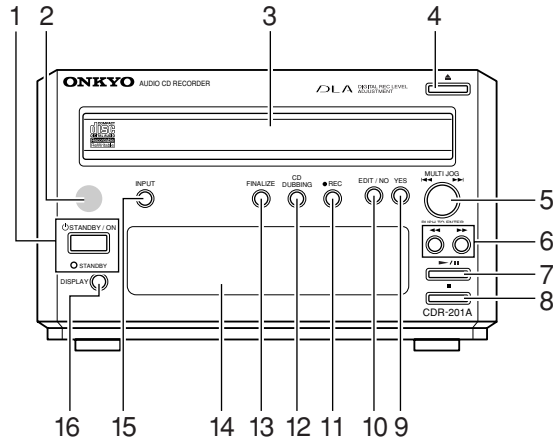

Display

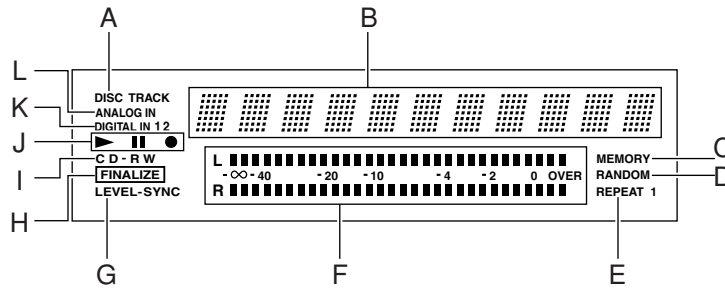

Rear Panel

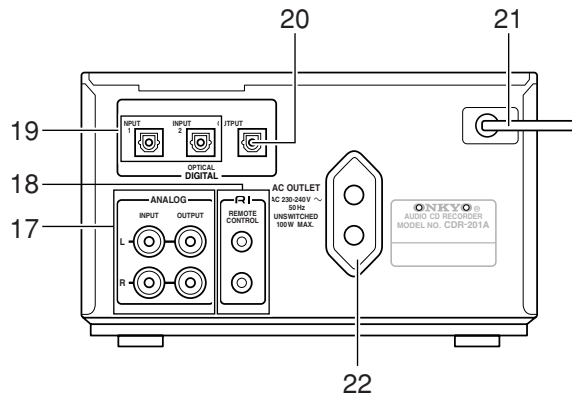

Part names and functions

The numbers within the brackets are the pages where the part is introduced.

Front panel

- 1 **STANDBY/ON button and STANDBY indicator [20]**
- 2 **Remote control sensor [9]**
- 3 **Disc tray [20]**
- 4 **▲ (tray open/close) button [20]**
Press to open and close the disc tray.
- 5 **◀◀ MULTI JOG ▶▶ dial [21]**
Use to jump to tracks prior to or later than the one currently playing. Use while playback is stopped to select the track to play.
- 6 **◀◀/▶▶ (rewind/fast forward) buttons [44]**
Press to rewind or fast forward through the track currently playing.
- 7 **▶/|| (play/pause) button [26, 27, 44]**
Press to start analog recording, digital recording, and playback. Press during playback to pause the playback. Press again to resume playback.
- 8 **■ (stop) button [26, 28, 44]**
Press to stop recording or playback.
- 9 **YES button [21]**
Press to confirm displayed settings during CD dubbing and other operations.
- 10 **EDIT/NO button [21]**
Press to display the operations for CD dubbing, erasing, name input, and other operations. To select a displayed operation, turn the MULTI JOG dial.
- 11 **● REC (recording) button [23]**
For analog and digital recording, press to place the CDR-201A in the recording standby state.

12 CD DUBBING button [21, 22]

Press to start CD dubbing.

13 FINALIZE button [22, 39]

Press to finalize discs onto which you have finished recording. Also, press to unfinalize discs that have already been finalized.

14 Front display

- A DISC/TRACK indicator
- B Display
- C MEMORY (programmed playback) indicator
- D RANDOM (random playback) indicator
- E REPEAT (repeat playback) indicator
- F Recording level display
- G LEVEL-SYNC indicator
- H FINALIZE indicator
- I CD/CD-R/CD-RW indicator
- J ▶ (play) / || (pause) / ● (recording) indicator
- K DIGITAL IN 1/2 indicator
- L ANALOG IN indicator

15 INPUT button [21]

Press to select the input source.

16 DISPLAY button [33, 35]

Press to change the contents of the display.

Rear panel

17 ANALOG INPUT (REC)/OUTPUT (PLAY) terminals [17]

18 R I REMOTE CONTROL terminals [17]

19 DIGITAL OPTICAL INPUT 1/2 terminals [17]

20 DIGITAL OPTICAL OUTPUT terminal [17]

21 Power cord [17]

22 AC outlet [17]

Before using

Part names and functions

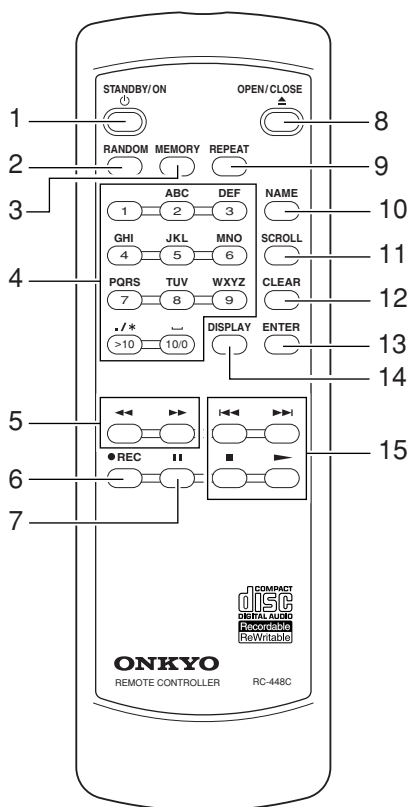

The numbers within the brackets are the pages where the part is introduced.

RC-448C remote controller

- 1 STANDBY/ON button [20]**
Press to switch the CDR-201A between the on state and the standby state.
- 2 RANDOM (random playback) button [45]**
Press to playback the tracks on the disc in random order.
- 3 MEMORY (programmed playback) button [46]**
Press to program the tracks to play in memory.
- 4 Numeric buttons [36, 46]**
Press the number for a track to start playback at that track. Also, press to program tracks for programmed playback.

Alphabetic letters/Symbols/Numeric/(1 to 10) buttons [36]

Press to enter a disc name and track titles.

- 5 ◀◀/▶▶ (rewind/fast forward) buttons [36, 44]**
Press to rewind or fast forward through the track currently playing. Press to move the cursor forward or backward when changing the name of a disc.
- 6 ● REC (recording) button [23]**
For analog and digital recording, press to place the CDR-201A in the recording standby state.
- 7 || (pause) button [44]**
Press during playback to pause the playback. Press the ▶ button to resume playback.
- 8 ▲ (tray open/close) button [20]**
Press to open and close the disc tray.
- 9 REPEAT (repeat playback) button [45]**
Press to repeat the playback of a disc or a track.
- 10 NAME button [34]**
Press to begin entering a disc name or track titles. Also press this button to confirm the name you input.

- 11 SCROLL button**
Press to scroll a displayed disc name or track titles.
- 12 CLEAR button [36, 46]**
Press to erase the programmed tracks one at a time from the end. This button is also used to erase the character entered.
- 13 ENTER button [36]**
Press to enter and confirm a disc name, artist name, or track titles.
- 14 DISPLAY button [33, 35]**
Press to change the contents of the display.
- 15 OPERATION button**
 - (stop) button [28, 44]
Press to stop recording or playback.
 - ▶ (play) button [26, 44]
Press to start analog recording, digital recording, and playback.
 - ◀◀/▶▶ (skip) buttons [36, 44]
Use to jump to tracks prior to or later than the one currently playing. Use while playback is stopped to select the track to play.

For the part names and functions of the RC-4665 remote controller, refer to the instruction manual with the R-801A.

Notes on usable CDs

Notes on usable discs

- **CD-Recordable (CD-R) and CD-ReWritable (CD-RW) discs**

When recording with the CDR-201A, you must use compact discs with the following marks printing on them:



FOR CONSUMER

FOR CONSUMER USE

FOR MUSIC USE ONLY

(A disc with any of the above markings.)

Recording cannot be performed on discs that do not have one of the above markings.

Copyright fees have been enacted by copyright laws, and these fees are included in the price of CD-R*¹ and CD-RW*² discs, as well as discs labeled with "FOR CONSUMER," "FOR CONSUMER USE," and "FOR MUSIC USE ONLY." Therefore, the recording of music protected by copyright laws with these discs is permitted for personal use. However, copying for purposes other than personal use requires the permission of the copyright holder.

- **Compact discs**

Always use compact discs with the following mark (optical digital audio discs):



CD TEXT

CD TEXT is a feature added to audio CDs that provides the ability to deliver text information (alphabetic letters, symbols, and numbers) such as disc titles, artist names, track titles, etc. Commercial audio CDs that contain this text information bear the following mark.



Cautions regarding copyrights

The lyrics and melodies composing the musical elements of media and musical performances from radio broadcasts, compact discs, records, music tapes, original cassettes, and other media are protected equally by copyright law. Therefore, the sale, transition, distribution, and re-release in media-form, or use as background music in stores and the like, is strictly forbidden without the previous express consent from the copyright holder.

CD-R finalization process

After recording onto a CD-R disc, it is necessary to perform the finalization process before the CD-R can be played in CD players. After the finalization process is completed, you cannot perform additional recordings.

CD-ReWritable (CD-RW) discs

CD-RW discs cannot be played in normal CD players even after finalization. CD-RW discs can only be played on players compatible with CD-RW discs. Also, with CD-RW discs, recording can be erased even after finalization.

Before using

Notes on usable CDs

Notes on discs

Never use heart-shaped, octagonal, or other special shaped discs as they may damage the internal mechanisms of the CDR-201A.



Do not play CD-ROMs intended for computer use or non-audio compact discs. Doing so may cause high-pitched noises or other unpredictable results that may damage speakers, amplifiers, and other connected components.

■ Handling discs

Be careful not to touch the data side of the disc (the side that does not have printing on it). Always hold discs by the edges or by using the hole in the middle.

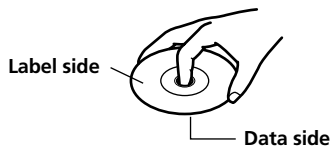

Never place labels or stickers on the data side or label side of the discs. Also, do not write on the discs or allow them to become scratched.



■ Cautions when using rented compact discs

Do not use discs that have cellophane tape attached to them or rental compact discs that have rental labels attached. If the tape is sticking out or peeling off, the disc may not be able to be ejected and the CDR-201A may become damaged.

■ Do not use 8-cm CD adapters.

■ Cleaning

Dirt and contaminants on discs can obstruct the pickup of the signals and lead to deterioration the sound. When dirty, clean the data side with a soft dry cloth, wiping from the inside of the disc toward the outside.



If the dirt is excessive, soak the cloth in water, wring it out, and then wipe the disc surface clean. Next, using a soft dry cloth, wipe the moisture from the disc surface.

Do not use conventional record cleaners or antistatic agents. Also, never use benzene, thinners, or other volatile agents as they may damage the disc surface.

■ Cautions for disc storage

Do not store discs in locations exposed to direct sunlight, near heat emitting devices, and other locations of excessive heat, or locations of extremely low temperatures. Also, always store discs properly in their protective cases.

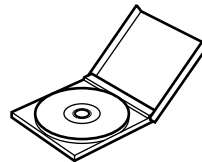

Condensation

When moving the CDR-201A from a cold location to a hot location, when quickly heating a cold location with a furnace, or other similar situation, condensation may occur. This may not only cause improper operation of the device, but may also damage the discs and components. If condensation has occurred, turn on the CDR-201A and leave it running for 1 to 2 hours. If you will not use the CDR-201A, then eject any disc inside.

Connections

Connecting to the Onkyo Separate Collection

This section introduces you to the other Separate Collection Series system components and their convenient system functions, followed by connecting instructions.

The following Separate Collection series components are commercially available:

- R-801A FM Stereo/AM Tuner Amplifier (Not available in U.S.A. and Canada)
- MD-101A ... MD Recorder (Not available in U.S.A. and Canada)
- K-501A Stereo Cassette Tape Deck (Not available in U.S.A. and Canada)
- C-701A Compact Disc(CD) Player (Not available in U.S.A. and Canada)

Note that the available components may vary according to the area.

Combination use of the unit with the above system components enables you to operate the following convenient functions.

- **Auto power on**
By turning on the CDR-201A or starting a playback with it, the power to the amplifier is automatically turned on as well. Also, when not using the CDR-201A, you can turn it off independently.
- **Direct change**
By pressing the play/pause button (▶/II) on the CDR-201A, the input source at the tuner amplifier automatically switches to CDR.
- **Remote controller operation**
The remote controller supplied with the R-801A can be used to operate the CDR-201A. (For more details, refer to the R-801A instruction manual.)
- **Timer**
Timed playback is possible. (For more details, refer to page 47 of this instruction manual or to the R-801A instruction manual.)
- **CD dubbing**
This function allows one-touch recording from the CD player to the CDR-201A. (For more details, refer to the pages 21 and 22 of this instruction manual.)
- **CD - synchro recording**
By first setting the CDR-201A so that it is ready for recording, you can start the recording by just pressing play at the CD player. (For more details, refer to the pages 23 and 24 of this instruction manual.)
- **Synchronous recording from the MD or tape deck**
By first setting the CDR-201A so that it is ready for recording, you can start the recording by just pressing play at the MD or tape deck. (For more details, refer to the page 25 of this instruction manual.)

Connecting the CDR-201A

■ Connecting to other components

The CDR-201A contains components that are extremely heat sensitive, so do not place the CDR-201A on the amplifier.

Always complete all connections before inserting the power cord into the wall outlet.

To L channel of the CDR-201A (White) To R channel of the CDR-201A (Red)

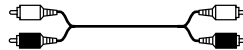

(White) To L channel of other component
(Red) To R channel of other component

Protection cap for the optical digital input terminal

When necessary, remove this protection cap and store it safely. When not using the optical digital input terminal, be sure to put the cap back on the terminal.

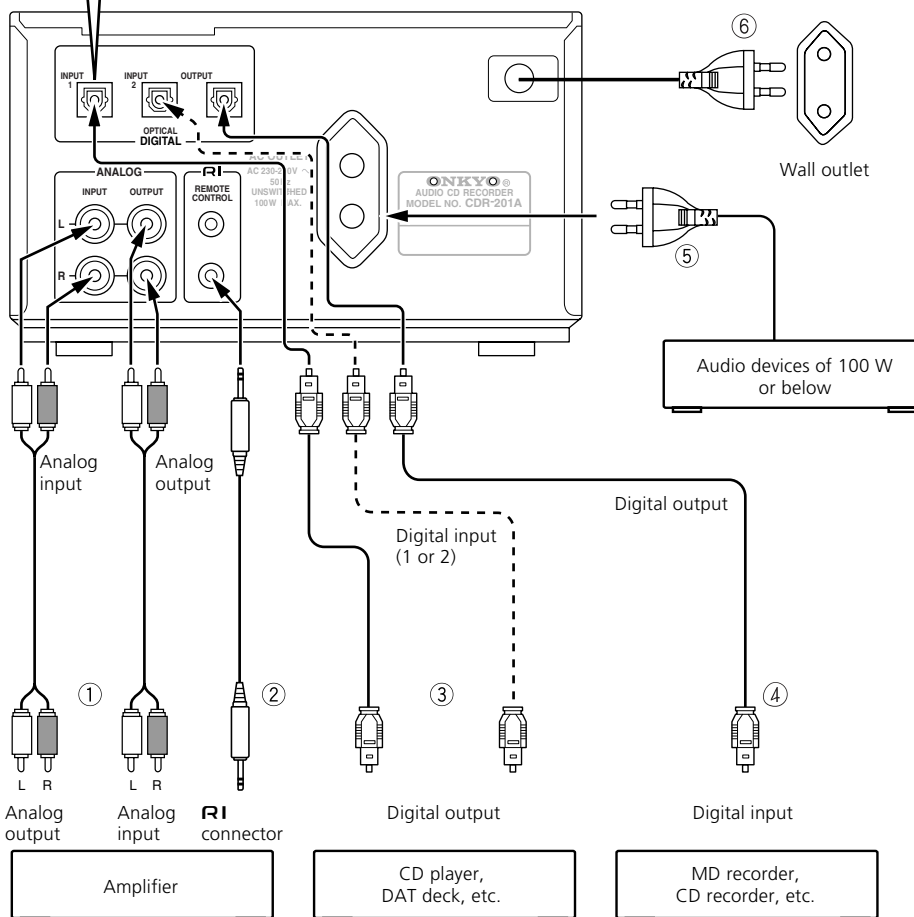
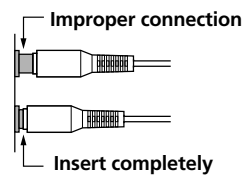
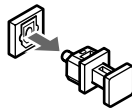

Connecting the CDR-201A

① Connecting to an amplifier/Tuner amplifier

Connect the CDR-201A to the CDR, TAPE or MD terminal on the amplifier/Tuner amplifier.

- Connect the red connectors of the supplied audio connection cables to the R-channel terminals and the white connectors to the L-channel terminals.
- Make sure the connectors are properly inserted all the way. If the connectors are not properly connected, noise or improper operation may result.
- Do not bundle the audio cables together with power cords or speaker cables. Doing so may cause deterioration of the audio signal.

② Connecting the RI cable

- With Onkyo components that are equipped with an **RI** connector, use the supplied **RI** cable to connect the **RI** connector to the **RI** connector of the CDR-201A.
- The **RI** connectors are only effective if they are used in conjunction with an Onkyo amplifier with an **RI** connector. Do not connect to a component other than an Onkyo component with an **RI** connector. Doing so may damage the CDR-201A.
- The function of the upper and lower **RI** connectors are the same. Connect to either one.
- Connecting the **RI** cable only does not make the system operational. You must also connect the audio cables as well.

③ Connecting to the digital input

Using the digital input, you can record digital audio from compact disc players, DAT decks, and other digital audio components that have a digital output. Connect using the supplied optical digital cable and either the DIGITAL INPUT 1 and 2 input on the CDR-201A. You can also connect to amplifiers that are equipped with digital output terminals.

Notes:

- The optical digital terminal is provided with a protection cap installed. When necessary, remove this protection cap and store it safely. When not using the optical digital input terminal, be sure to put the cap back on the terminal.
- To perform digital input recording, you must connect to the optical digital input terminal. If the digital connection is not made, "D.In Unlock" will appear in the display.

④ Connecting to the digital output

Using the digital output, you can connect to MD recorders, CD recorders, DAT deck recorders, and other digital audio recorders that have optical digital input connectors for making digital recordings. You can also connect to amplifiers that are equipped with digital input terminals.

⑤ Using the AC outlet on the CDR-201A

An AC outlet is available on the CDR-201A for you to connect your own audio devices.

Note:

The shape, number, and total capacity of the AC outlets may differ depending on the area where the unit is purchased.

230 - 240 V, 50 Hz model: Capacity is 100 W in total.

⑥ Connecting the power cord

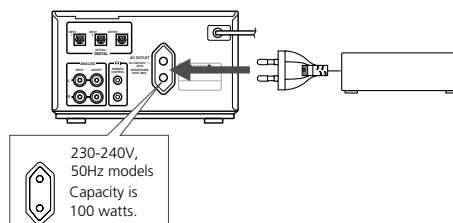

Operations

Recording modes

Cautions during recording

In the following situations, recording is not possible even if the ● REC or CD DUBBING button is pressed.

- The CD indicator is lit (a CD or finalized CD-R has been inserted).
- The CD-RW and FINALIZE indicators are lit (a finalized CD-RW has been inserted).
- The inserted disc is full and "Disc Full" is displayed.
- The 99th track has been recorded and "Disc Full" is displayed.
- The disc is not for audio use or when "Pro Disc" is displayed.

Only the audio signals can be recorded

The CDR-201A is designed for recording audio signals only and therefore only digital signals that are audio signals are recorded. Other CD-ROM and Dolby Digital data, and the like, will not be recorded. Also, when recording from discs that have graphics or text data, only the audio signals will be recorded.

The minimum track length is 4 seconds

For compact discs, the minimum track length is 4 seconds. Even if the ■ (stop) or || (pause) button is pressed immediately after starting recording, a silent 4-second track will be recorded. Also, during that 4 seconds, you cannot resume recording or perform another operation.

When an unrecordable signal is present during the digital recording

"D.In Unlock" or "Cannot Copy" appears in the display and the recording operation is suspended. The operation will be resumed in response to any recordable signals that may follow.

Recording mode for system setups

Below is an introduction to the type of recordings possible when the CDR-201A is connected to the R-801A, C-701A, MD-101A, and K-501A components.

■ CD dubbing (digital) (see page 21)

Digitally record all tracks from a music CD to a CD-R or CD-RW. When dubbing is completed, you can automatically select the finalization mode. The dubbing mode is selected at the EDIT menu.

Album mode: Only record the tracks that can be completely recorded.

Fade-out mode: A fade-out is recorded at the end of the final track that could not be completely recorded.

■ Single-track CD dubbing (digital) (see page 22)

Record the track currently being played (or paused) with the CD player with one touch. The dubbing mode is the mode that is currently set; however, if the album mode is set, tracks that cannot be fully recorded will not be erased, but will be recorded until the disc becomes full.

■ Synchronous recording (see page 23)

When connected to a component system, the operations given below are possible.

- Synchronous recording from the CD player to the CDR-201A. (Analog recording only)
- Synchronous recording from the MD recorder or tape deck to the CDR-201A. (Analog recording only)
- Synchronous recording from the CDR-201A to an MD recorder or tape deck. (Analog recording only)

Note:

For CD dubbing, single-track CD dubbing, and synchronous recording, you must have the optical digital cable from the C-701A connected to the digital input 1 terminal of the CDR-201A. For more details regarding system setup, refer to the instruction manual for the R-801A.

Do not turn off the CDR-201A during recording, finalizing, erasing, or while "PMA Writing" is displayed.

If you accidentally do turn the power off, or if a power outage occurs, the data on the disc may be rendered unreadable.

Do not shake or subject the CDR-201A to vibrations during recording, finalizing, erasing, or while "PMA Writing" is displayed.

Doing so may cause the sound on the disc to skip or the data on the disc to become unreadable.

Recording modes

Normal recording mode

When not connected to a component system, there are a few methods that you can perform to record the signal in from the analog input or digital input of the CDR-201A.

■ Analog recording (see page 26)

This method records the signal at the analog inputs. The recording level can be adjusted manually.

■ Digital recording (see page 27)

This method records the signal at the optical digital inputs. The recording level can be adjusted manually. You may need to adjust the recording level when recording low digital signal sources such as satellite broadcasts and the like.

■ Signal synchronous recording (see page 29)

When recording together with a portable MD player or Onkyo component that does not have an **RI** connector, you can synchronize the recording with the input signal.

About the level sync function

The level sync function detects the space between tracks (songs, etc.) in the recording source and automatically assigns track numbers to them during recording.

■ When the level synch function is turned on

The track numbers are updated automatically. Press the ● REC button to set track numbers manually .

■ When the level synch function is turned off

The track numbers are not updated automatically. Press the ● REC button to set track numbers manually .

■ For analog recording

If you put the CDR-201A into the recording standby state, the level sync function turns on automatically. If there are gaps of no sound 2 seconds or longer between tracks in the recording source, the track numbers will be automatically updated.

■ For digital recording

If you put the CDR-201A into the recording standby state, the level sync function turns on automatically.

If the digital signal includes the track number information, the track numbers will be automatically assigned.

For satellite broadcasts and other digital signals that do not include track number information, the track numbers will be automatically updated when 2 seconds or more of silence is detected.

Name function

■ Entering a disc name (see page 34)

You can enter one disc name per disc.

■ Entering track names (see page 37)

You can enter up to 99 track names per disc.

■ Erasing the disc name and track names (see page 38)

You can erase all the name information retained in the CDR-201A.

Finalization

The finalization process writes the TOC data (tracks, etc.) for the disc in a special area on the disc called the PMA. After finalization, CD-Rs can be played in CD players. Even after finalization, CD-RWs can only be played on CD players that are compatible with CD-RWs.

For CD-Rs that have been finalized, you cannot add more recordings.

Erasing recording (CD-RW discs only)

The data recorded on CD-RW discs can be erased and the disc can be used again as many times as desired (see page 40).

The erasing methods are given below.

- **Erasing data on unfinalized CD-RWs**
 - Last track erase:** Erases only the last track.
 - All track erase:** Erases all tracks.
- **Erasing data on finalized CD-RWs**
 - All track erase:** Erases all tracks.
 - TOC erase:** Returns a finalized disc to the unfinalized conditions.
- **Erasing discs**
 - Erases all data recorded on the CD-RW.

Inserting a disc

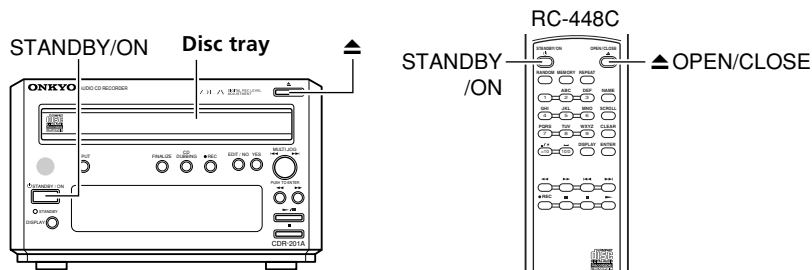

1 Turn on the CDR-201A.

Press the STANDBY/ON button.
The STANDBY indicator turns off.



2 Press the ▲ button.

The disc tray opens. Place the disc with the label-side up in the center of the tray.

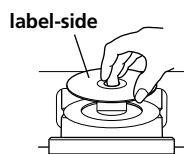

3 Press the ▲ button.

The disc tray closes.

Memo:

- You can also press the ►/|| button (or the remote controller ► button) to close it.
- By pressing the ▲ button (or the remote controller ▲ OPEN/CLOSE button) in the standby state, the power is automatically turned on. If used in a component system with the R-801A, their power automatically turns on as well.
- When the disc is inserted, the CDR-201A automatically scans the disc and displays the type in the front display.

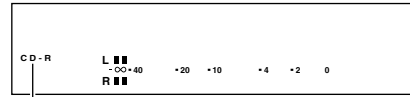

Disc indicator

CD	Commercially sold CD Finalized CD-R
CD-R	Unrecorded CD-R Partly recorded (not finalized) CD-R
CD-RW	Unrecorded CD-RW Partly recorded (not finalized) CD-RW
CD-RW	Finalized CD-RW
FINALIZE	

- The CDR-201A displays information of the disc, including total recording number of tracks and time, and remaining available recording time. Displayed contents may vary depending on the type of disc. When unrecorded compact discs are inserted, "Blank Disc" appears in the display.

CD dubbing (component system operation)

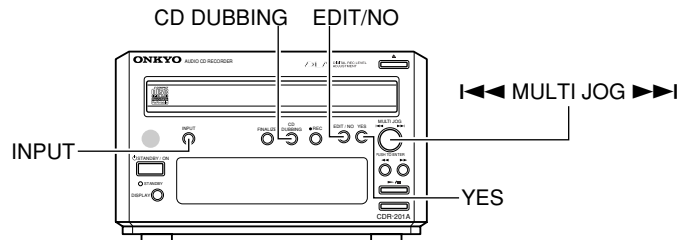

Perform CD dubbing to digitally record all the tracks from a music CD to a CD-R or CD-RW. The dubbing mode is selected at the EDIT menu.

Preparation

- Turn on the CDR-201A (see page 20).
- Place the music CD in the CD player. (Refer to the instruction manual for the C-701A.)
- Place a recordable CD-R or CD-RW in the CDR-201A (see page 20).

1 Repeatedly press the INPUT button until "Digital In1" appears.

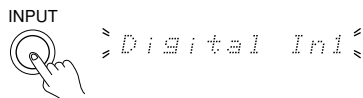

Note:

CD dubbing cannot be performed when "Digital In 2" or "Analog In" is selected.

2 Press the EDIT/NO button and turn the MULTI JOG dial until "CD DubMode?" appears.

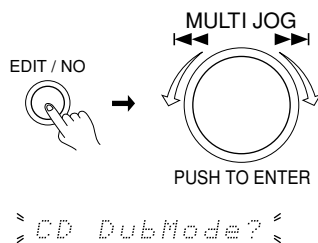

3 Press the MULTI JOG dial.

Pressing the YES button provides the same operation. The current dubbing mode appears.

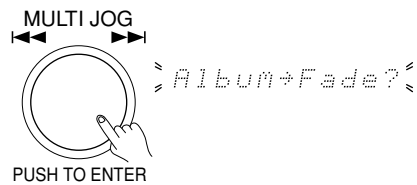

The current dubbing mode is given on the left side (for the display given above, the current dubbing mode is the album mode).

Album: Only record the tracks that can be completely recorded. (Album mode) With CD-RW discs, erase a track if it cannot be completely recorded.

Fade: A fade-out is recorded at the end of the final track that could not be completely recorded. (Fade-out mode)

4 To change the dubbing mode, press the MULTI JOG dial.

Pressing the YES button provides the same operation. The new dubbing mode is set. To not change the dubbing mode, press the EDIT/NO button.

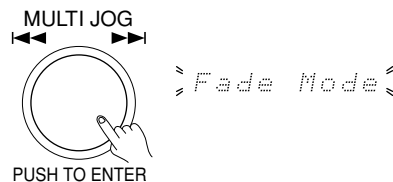

CD dubbing (component system operation)

5 Press the CD DUBBING button.

CD dubbing begins.



During CD dubbing, the level sync function turns on. The CD player begins a search for the peak level and the CDR-201A set the optimum recording level to match that peak level (DLA* Link 2 function).

Then the music CD is digitally recorded from the first track to the last track.

Auto finalization

To use auto finalization, press the FINALIZE button repeatedly during recording until "Auto On" appears. (The FINALIZE indicator appears flashing.) Finalization starts automatically as soon as the CD dubbing finishes.

Note:

The auto finalization automatically starts after CD dubbing completes unless the recording is interrupted as follows:

- If you press the ■ button to stop the CDR-201A.
- If you power off the system tuner amplifier (R-801A) which the CDR-201A is connected to, or the sleep time shuts down the whole system.

To cancel auto finalization during recording

Press the FINALIZE button repeatedly until "Auto Off" appears. (The FINALIZE indicator disappears.)

When the CD finishes

The CDR-201A automatically stops. (To perform finalization after completion, press the FINALIZE button.) If you turn on auto finalization, then the CDR-201A will stop after auto finalization.

To confirm settings during recording

Press the CD DUBBING button.

To stop the recording

Press the ■ button.

* DLA

Digital Rec Level Adjustment

Single-track CD dubbing

Perform single-track CD dubbing when connected to component system to record the track currently being played (or paused) with the CD player with one touch.

1 Play the CD with the CD player.

2 Press the CD DUBBING button while the track you want to record is playing.



CD dubbing begins.

The CD player returns to the beginning of the song and searches for the peak level. The CDR-201A set the optimum recording level to match that peak level. Then recording begins. When the track is completed, the CDR-201A stops and the CD player continues on to the next track.

Note:

The dubbing mode is the mode that is currently set. However, when performing single-track CD dubbing with CD-RW, even if the album mode is set, tracks that cannot be fully recorded will not be erased, but will be recorded until the disc becomes full.

Synchronous recording (component system operation)

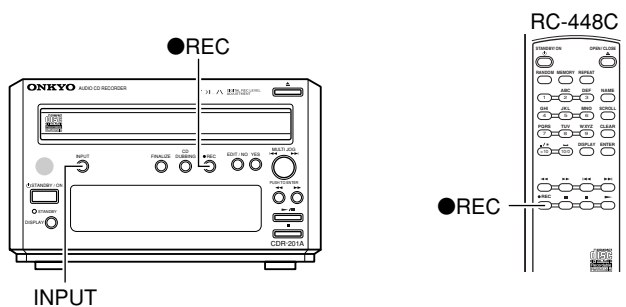

When connected to a component system, the synchronous recording operations given below are possible.

- Synchronous recording from the CD player to the CDR-201A.
- Synchronous recording from the MD recorder or tape deck to the CDR-201A.
- Synchronous recording from the CDR-201A to a MD recorder or tape deck.

Synchronous recording from a CD player to the CDR-201A

Preparation

- Turn on the CDR-201A (see page 20).
- Place the music CD in the CD player. (Refer to the instruction manual for the C-701A.)
- Place a recordable CD-R or CD-RW in the CDR-201A (see page 20).

1 Repeatedly press the INPUT button until "Digital In1" appears.

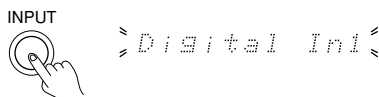

For analog recording, select "Analog In." Proceed to step 3 if you do not wish to adjust the recording level.

Note:

Synchronous recording cannot be performed when "Digital In 2" is selected.

2 Press the ► button on the CD player to start playback.

3 Press the ● REC button (or the remote controller REC ● button).

"Rec Setup" appears in the display followed by the time display (the recording standby state).

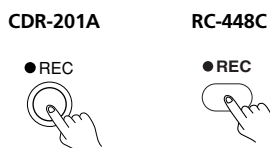

Proceed to step 6 if you do not wish to adjust the recording level.

Synchronous recording (component system operation)

Synchronous recording from an MD recorder or tape deck to the CDR-201A.

Preparation

- Turn on the CDR-201A (see page 20).
- Place the MD or cassette in the MD deck or tape deck. (Refer to the instruction manual for the MD-101A or K-501A.)
- Place a recordable CD-R or CD-RW in the CDR-201A (see page 20).

1 Repeatedly press the INPUT button until "Analog In" appears.

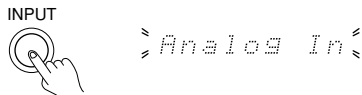

Proceed to step 3 if you do not wish to adjust the recording level.

Notes:

- When recording from an MD recorder or a tape deck, select "Analog In."
- Synchronous recording cannot be performed when "Digital In 2" or "Digital In 1" is selected.

2 Start playback of an MD or tape.

3 Press the ● REC button (or the remote controller REC ● button).

"Rec Setup" appears in the display followed by the time display (the recording standby state).

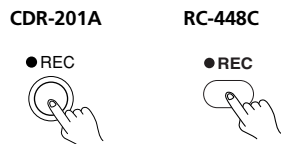

Proceed to step 6 if you do not wish to adjust the recording level

4 Adjust the recording level.

Refer to page 24, step 4 "Adjust the recording level."

5 Stop the playback of the MD or tape.

6 Press the ► button at the MD recorder or tape deck.

The MD recorder or tape deck starts playing and recording starts at the CDR-201A.

When the MD or tape finishes

The CDR-201A automatically returns to the recording standby state.

To stop the synchronous recording

Stop play at the MD or tape deck.

Synchronous recording from the CDR-201A to an MD recorder or tape deck

Preparation

- Turn on the CDR-201A (see page 20).
- Place the MD or cassette for recording in the MD deck or tape deck. (Refer to the instruction manual for the MD-101A or K-501A.)
- Place the CD, CD-R or CD-RW to be recorded in the CDR-201A (see page 20).

1 Put the MD recorder or tape deck in its recording standby state.

2 Press the ►/II button (or the remote controller ► button).

The CDR-201A begins playback and the MD or tape deck begins recording.

When the CDR-201A finishes

The MD or tape deck automatically returns to the recording standby state.

To stop the synchronous recording

Stop play at the CDR-201A.

Analog recording

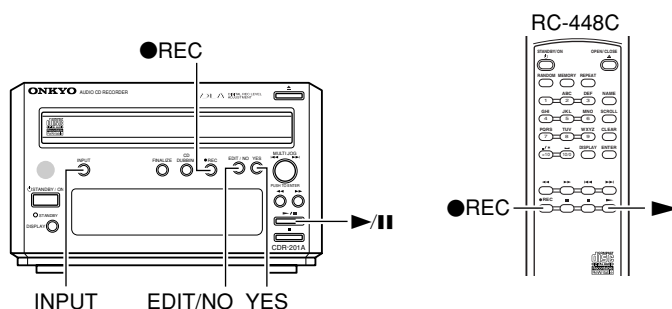

Perform analog recording to record the signal input to the analog input terminal of the CDR-201A. The recording level can be adjusted manually.

Preparation

- Turn on the CDR-201A (see page 20).
- Place a recordable CD-R or CD-RW in the CDR-201A (see page 20).
- Verify that the input dial and recording selection button of the amplifier are set to the position of the recording source.

1 Repeatedly press the INPUT button until "Analog In" appears.



Proceed to step 3 if you do not wish to adjust the recording level.

2 Start playback of the recording source.

3 Press the ● REC button (or the remote controller REC ● button).

The level sync function turns on. "Rec Setup" appears in the display followed by the time display (the recording standby state).

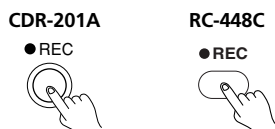

Proceed to step 6 if you do not wish to adjust the recording level.

4 Adjust the recording level

Refer to page 24, step 4 "Adjust the recording level."

5 Stop playback of the recording source.

6 Press the ►/|| button (or the remote controller ► button) and start the recording source.

Recording starts. If the entire disc becomes filled with recordings, the CDR-201A automatically stops.

To set the track numbers manually

Press the ● REC button.

To pause the recording

Press the ►/|| button (or the remote controller || button). To resume recording, press the ►/|| button (or the remote controller ► button) when the time display appears.

The CD recorder will stop, if the recording standby state persists for 10 minutes or more.

To stop the recording

Press the ■ button.

Digital recording

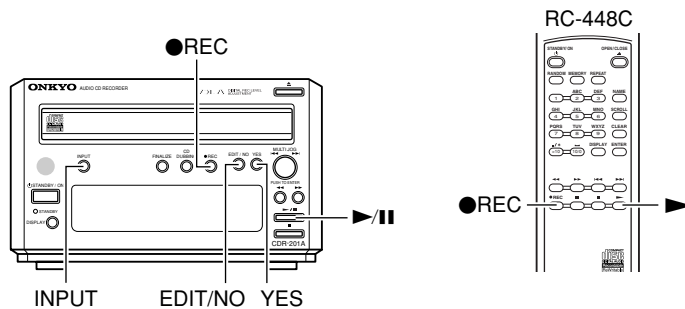

Perform digital recording to record the signal input to the optical digital input terminal of the CDR-201A. The track numbers are recorded as is from the input source. The recording level can be adjusted manually.

Types of digital source that can be recorded

The CDR-201A contains an internal sampling rate converter, and therefore can record digital signals of the sampling rates given below.

- 44.1 kHz (CDs, etc.)
- 32 kHz (DAT, satellite broadcasts, etc.)
- 48 kHz (DAT, satellite broadcasts, etc.)

Notes:

- When performing digital recording with an HDCD, use the procedure given on this page or that given for signal synchronous recording or synchronous recording. Also, make sure the recording level is set to 0 decibels (see page 24). Since the recording level is set automatically (DLA) during CD dubbing with the CD dubbing button, the recording will not be performed properly.
- You cannot perform digital recording from a DTS CD.

Preparation

- Turn on the CDR-201A (see page 20).
- Place a recordable CD-R or CD-RW in the CDR-201A (see page 20).
- Verify that the input dial and recording selection button of the amplifier are set to the position of the recording source.

1 Repeatedly press the INPUT button until "Digital In1" or "Digital In2" appears.

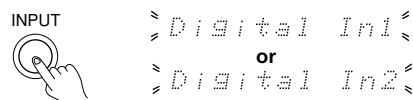

Proceed to step 3 if you do not wish to adjust the recording level

Note:

Verify to which digital input the optical digital cable is connected.

2 Start playback of the recording source.

3 Press the ● REC button (or the remote controller REC ● button).

The level sync function is set to ON.

"Rec setup" appears in the display followed by the time display (the recording standby state).

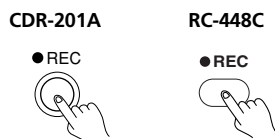

Proceed to step 6 if you do not wish to adjust the recording level.

Note:

If you select the digital input to which the optical digital cable is not connected, "D.In Unlock" will appear.

Digital recording

4 Adjust the recording level.

Refer to page 24, step 4 "Adjust the recording level."

5 Stop the playback of the recording source.

6 Press the ►/|| button (or the remote controller ► button) and start the recording source.

Recording starts. The track numbers are automatically recorded as well.

To pause the recording

Press the ►/|| button (or the remote controller || button). To resume recording, press the ►/|| button (or the remote controller ► button) when the time display appears.

To stop the recording

Press the ■ button.

Notes:

- When digitally recording satellite broadcasts, the track numbers may not be assigned properly. If this occurs, turn off the level sync function and set the track numbers manually (see page 31).
- If the time between tracks is extremely short, the track numbers may not be assigned properly.

Synchronous recording by input signal detection (Signal synchronous recording)

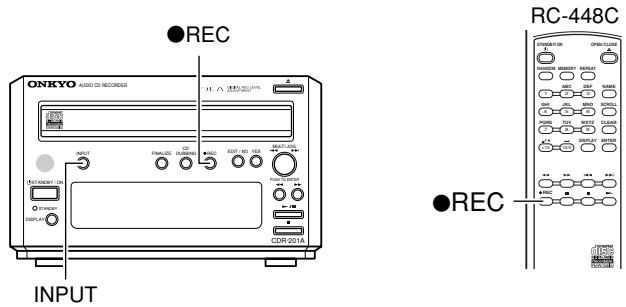

When recording with portable MD players, or other components that are not equipped with an **RI** connector, recording is started synchronous with the input signal. (This is called signal synchronous recording.)

Notes:

Note the following when using synchronous recording for digital input sources.

- DATs cannot be recorded if no start ID is present before audio contents.
- CD DUBBING uses a sub-code signal that is contained in the digital output from most player components, and therefore there may be some CD players, MD recorders, or the like where digital synchronous recording is impossible.
- If you are performing signal synchronous recording of classical or other soft music using the analog input, the recording may not start at the proper time. If this is the case, start the recording manually (see "Analog recording" on page 26).

Preparation

- Turn on the CDR-201A (see page 20).
- Place a recordable CD-R or CD-RW in the CDR-201A (see page 20).
- Verify that the input dial and recording selection button of the amplifier are set to the position of the recording source.

1 Repeatedly press the INPUT button and select the desired input signal.

Select "Digital In 1," "Digital In 2," or "Analog In" for the input source.

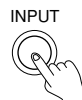

Proceed to step 3 if you do not wish to adjust the recording level.

2 Start playback of the recording source.

3 Press the ● REC button (or the remote controller REC ● button).

"Rec Setup" appears in the display followed by the time display.

CDR-201A



RC-448C



Proceed to step 6 if you do not wish to adjust the recording level.

Synchronous recording by input signal detection (Signal synchronous recording)

4 Adjust the recording level.

Refer to page 24, step 4 "Adjust the recording level."

5 Stop the playback of the recording source.

6 Press the ● REC button (or the remote controller REC ● button)

The CDR-201A enters the input standby state, "Signal Rec" appears in the display, and then "Signal Wait" appears flashing alternately with the time display.

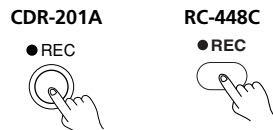

7 Verify that "Signal Wait" is flashing together with the time display and then start the playback of the recording source.

Recording starts as soon as the CDR-201A receives signals from the recording source.

Notes on the signal synchronous recording

- When the level synch function is turned on during analog recording, the track numbers are updated automatically as soon as audible sound is detected after 2 seconds or more of silence.
- If "Signal Wait" continues for 1 minute, signal synchronous recording is cancelled and playback is stopped.
- When "D.In Unlock" appears in the front display during the signal synchronous recording (digital input), the CDR-201A cancels the recording mode and enter to the recording standby state.

Using the level sync function

Using the level sync function

During analog recording, the track numbers are assigned automatically since the level sync function is turned on. Even so, you can press the ● REC (or the remote controller ● REC button) to assign the track numbers manually. To disable the automatic assignment of track numbers during recording, turn off the level sync function.

Turn off the level sync function and assign the track numbers manually, if the numbers are not automatically updated due to the situations as follows:

For analog recording

The level sync function uses the recording source level to detect the end and beginning of tracks. Therefore, in the cases given below, the track numbers may not be properly assigned.

- The recording on the cassette tape is poor (e.g., the space between songs contains much noise).
- With music such as classical music where there may be very low volumes.
- Where the space between songs is extremely short.
- If the signal at the tuner is weak (excessive noise).
- When recording from turntables.
- When the level sync function is turned on, if no signal continues for approximately one minute, recording will stop.

For digital recording

- When digitally recording satellite broadcasts, the track numbers may not be assigned properly. If this occurs, turn off the level sync function and set the track numbers manually.
- If the time between tracks is extremely short, the track numbers may not be assigned properly.
- When the level sync function is turned on, if no signal continues for approximately one minute, recording will stop. However, you can continue recording to CDs.

- 1 While in the recording standby state, press the EDIT/NO button and turn the MULTI JOG dial until "Level Sync?" appears.**

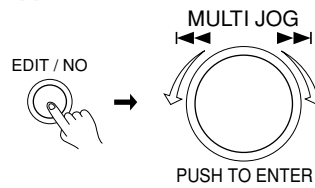

Level Sync?

Note:

This setting cannot be made during recording.

- 2 Press the MULTI JOG dial.**

Pressing the YES button provides the same operation. The current setting appears. The current setting is given on the left side (for the display given below, the current setting is "On").

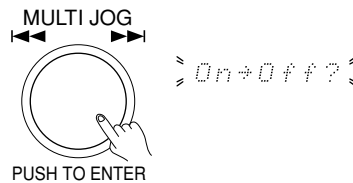

- 3 Press the MULTI JOG dial.**

Pressing the YES button provides the same operation. The level sync function turns off. Press the EDIT/NO button to return to the previous setting.

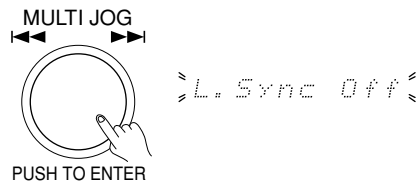

To return to automatic assignment of track numbers

Switch the setting to ON.

Follow the steps 1 through 3. "Off → On" should appear in step 2, "L.Sync On" in step 3.

Using the level sync function

Setting the level sync level

When the level sync function is turned on, the track numbers are automatically adjusted through the detection of music and digital signals during recording. The CDR-201A enables you to set the detection level of the sound used to signal the changes between tracks.

- 1 Press the **EDIT/NO** button and turn the **MULTI JOG** dial until "L. Sync. Lvl?" appears.

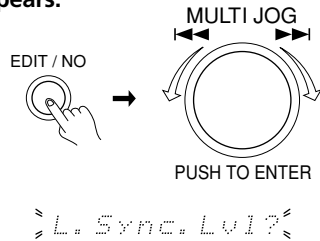

- 2 Press the **MULTI JOG** dial.

Pressing the YES button provides the same operation.

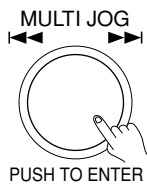

The current setting appears.

- 3 Turn the **MULTI JOG** dial to select the desired level.

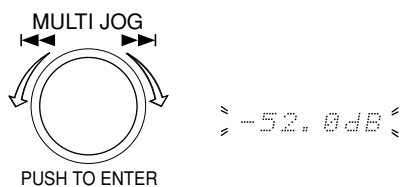

You can select a setting between -30 and -60 decibels in 2-decibel increments.

- 4 Press the **MULTI JOG** dial.

Pressing the YES button provides the same operation.

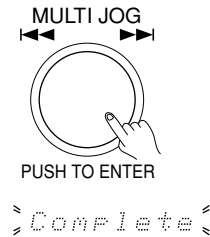

Memo:

- The initial settings are -46 decibels for analog recording and -52 decibels for digital recording.
- The level settings can be made separately for each input source.
- If a new track is not numbered when the silent gap between tracks in the recording source is reached, increase the level setting. Similarly, if tracks are numbered at locations where there is no silent gap between tracks, decrease the level setting.

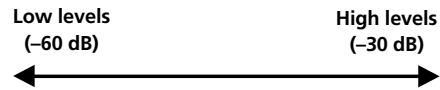

If there is noise in the silent gaps, the gaps will be difficult to detect.

Even if there is noise in the silent gaps, the gaps will be easy to detect.

Notes:

- This setting is enabled for digital recordings and analog recordings other than CDs, MDs, and DATs.
- This setting cannot be made during recording.
- Even if adjusted, the tracks may not be numbered properly.

Changing the display

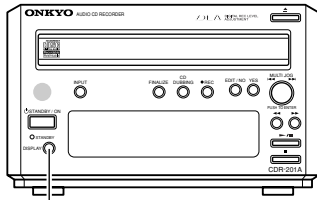

DISPLAY

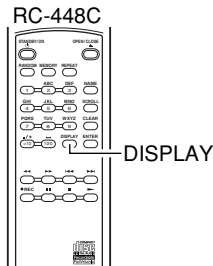

DISPLAY

Display during recording

Repeatedly pressing the DISPLAY button during recording changes the display as shown below.

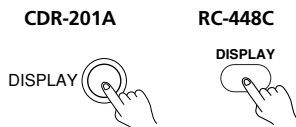

■ Display during recording

Track number and elapsed time of track being recorded

TRACK 4 0m42s



Remaining available recording time

DISC -2m24s



Track name (Track number and "No Name" if unavailable)

TRACK ONKYO



(Return to first display)

■ Display while stopped

Total number of tracks and time of the disc

24T 36m24s



Remaining available recording time (Not displayed for audio CDs and finalized discs)

DISC -34m18s



Disc name ("No Name" if unavailable)

DISC SONGS



(Return to first display)

■ Display during playback

Track number and elapsed time of track being played

TRACK 1 0m42s



Track number and remaining time of track being played

TRACK 1 -2m24s



Remaining time of total time of the disc (Not displayed during random playback)

DISC -26m30s



Track name (Track number and "No Name" if unavailable)

TRACK ONKYO



(Return to first display)

Entering names

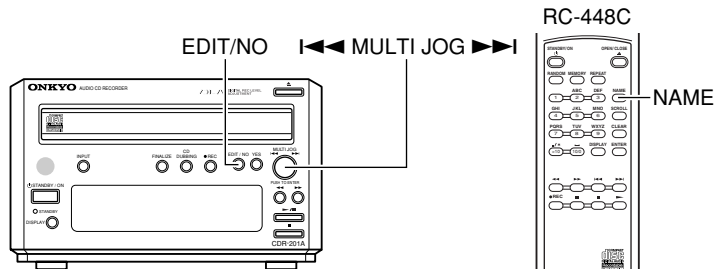

Name function

- The name function can be used for non-finalized CD-Rs or CD-RWs. You cannot enter names on finalized discs.
- The names you can enter include the disc name and track names.
- You can enter one disc name and up to 99 track names per disc. A disc or track name can consist of up to 24 characters. You can enter up to 1000 characters per disc.
- Finalization is required to write entered names to the disc. (The names you enter are temporarily retained in the CDR-201A and then written to the disc during finalization.)

Entering a disc name

When entering a disc name, set the CDR-201A to the stop state in advance.

- 1 Press the EDIT/NO button and turn the MULTI JOG dial until "Name In?" appears.**

To cancel name input, press the EDIT/NO button again or the STOP ■ button.

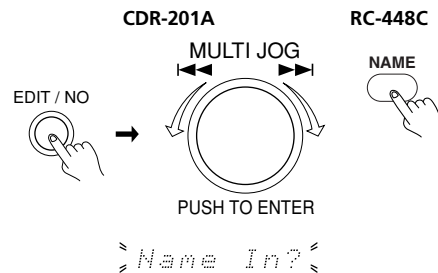

Or, press the remote controller NAME button. Pressing the NAME button proceeds to the state after step 2 is complete (go to step 3).

Entering names

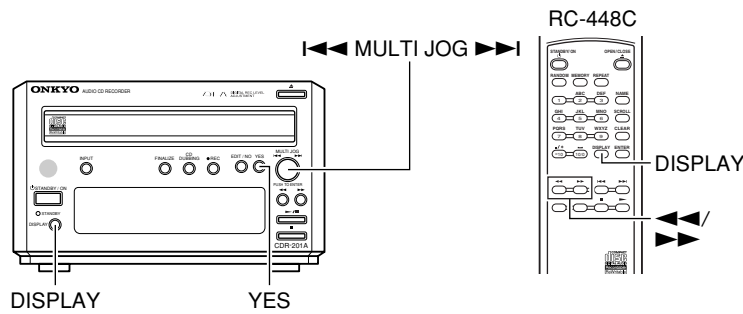

2 Press the MULTI JOG dial.

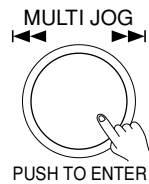

Pressing the YES button provides the same operation. The cursor appears flashing. To stop entering names while the cursor is flashing, press the YES button with holding the EDIT/NO button pressed, or press the STOP ■ button.



3 Enter a name.

(1) Press the DISPLAY button to select the type of characters you wish to enter.

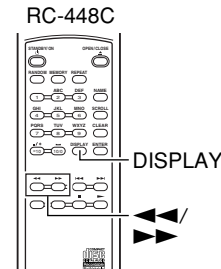
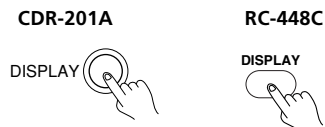

Repeatedly pressing the DISPLAY button changes the type of input characters as shown below.

Upper-case letter of alphabet (Indication: A)

↓

Lower-case letter of alphabet (Indication: a)

↓

Numbers and symbols (Indication: 1)

↓

Easy name (Indication: ♪)

You can also press the SCROLL button on the remote controller to change the character type. (Easy name→Numbers and symbols→Lower-case letter of alphabet→Upper-case letter of alphabet)

Types of available characters and symbols

A B C D E F G H I J K L M N O P Q R S T U V W X Y Z

a b c d e f g h i j k l m n o p q r s t u v w x y z

0 1 2 3 4 5 6 7 8 9 _ @ ' < > # \$ % & * = ; : +

- / () ? ! " , . (Space) ◀ (Insertion)

Types of available easy names

BALLAD, BLUES, CLASSIC, DANCE, FUSION, JAZZ, LIVE, POPS, REGGAE, ROCK, SOUL, TECHNO, VOCAL, African, American, Asian, British, Euro, German, Japanese, Anthology, Best of*, Collection, Favorite, Happy, Heavy, Hit Songs, Omnibus, Selection, Special, Super, (Space)

* One space will be added automatically as you enter "of."

Entering names

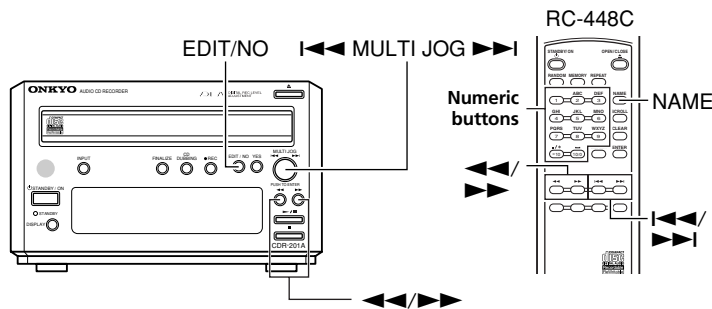

- (2) Turn the MULTI JOG dial to select the desired character and press the MULTI JOG dial to enter it.

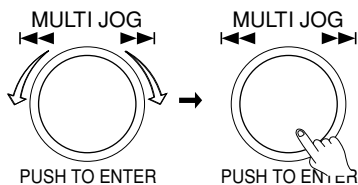

To change the type of input characters

Press the DISPLAY button and select the type of input characters in the above step 3-(1) before turning and pressing the MULTI JOG dial to enter characters.

Using the remote controller (RC-448C) for entering names

- Entering an alphabetic character**
 Press the desired numeric button to sequentially display the characters indicated on it. For example, pressing the 2/ABC button each time changes the displayed character in the sequence of A→B→C→A. When the character you want appears, press the ENTER button.
- Entering an easy name**
 Press the desired numeric button to sequentially display the easy names by the initial letters indicated on it. For example, pressing the 2/ABC button each time changes the displayed easy name to BALLAD, BLUES, CLASSIC, and so on. When the easy name you want appears, press the ENTER button.

Entering a number or symbol

Press the desired numeric button to display the number indicated on it. Or, repeatedly press the >10.//* button to change displaying the desired symbol, /*-,!?(), in that order, and press the 10/0/- button to display a space. When the number or symbol you want appears, press the ENTER button.

You may select the desired character using the ◀◀ or ▶▶ button and press the ENTER button to enter it.

Note:

Using the remote controller to enter symbols
 You may not be able to enter some symbols using the remote controller numeric buttons. To enter a symbol, select it using the remote controller ◀◀ or ▶▶ button.

To correct an input character

Press the ◀◀ or ▶▶ button on the CDR-201A or the remote controller. While the character you wish to correct appears flashing, enter a correct character.

To insert a character

Press the ◀◀ or ▶▶ button on the CDR-201A or the remote controller. When the position where you wish to insert a character appears flashing, turn the MULTI JOG dial counterclockwise (▶ appears flashing) and press the MULTI JOG dial. Enter a correct character at the position where the cursor is flashing.

To erase a character

Press the ◀◀ or ▶▶ button on the CDR-201A or the remote controller. When the character you wish to erase appears flashing, press the EDIT/NO button or the remote controller CLEAR button.

Entering names

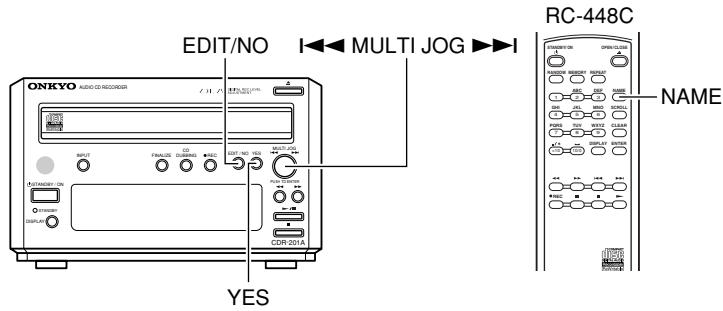

4 Press the YES button to end name input.

Or, press the NAME button on the remote controller (RC-448C).

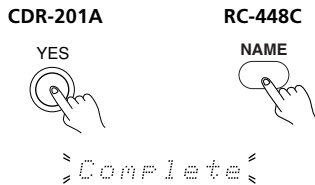

To write the entered names to the disc

Finalize the disc.

The names you enter are temporarily stored in the CDR-201A and then written to the disc during finalization. Be aware of the following notes when finalizing a disc.

Note:

If you enter a disc name and remove the disc without finalizing it, the name will not be stored. You will need to enter the name again.

Entering track names

1 Turn the MULTI JOG dial to select the desired track.

During playback, pause, or recording, the track selected currently will be named.

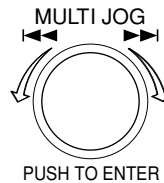

2 Press the EDIT/NO button and turn the MULTI JOG dial until "Name In?" appears.

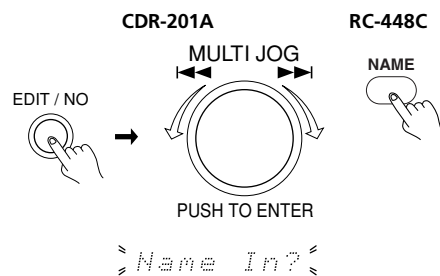

Or, press the remote controller NAME button. Pressing the NAME button proceeds to the state after step 2 is complete (go to step 3).

Entering names

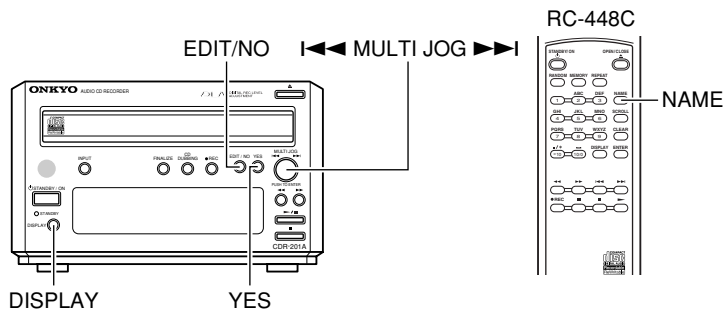

3 Press the MULTI JOG dial.

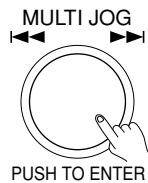

Pressing the YES button provides the same operation. The cursor appears flashing. To stop entering names while the cursor is flashing, press the YES button with holding the EDIT/NO button pressed, or press the STOP ■ button. Enter a track name in the same method as that described in step 3 of "Entering a disc name" (see page 35).

4 Press the YES button to end name input.

With the RC-448C remote controller, press the NAME button.

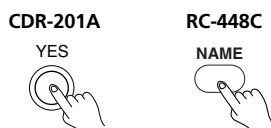

To write the entered names to the disc

Finalize the disc. The names you enter are temporarily stored in the CDR-201A and then written to the disc during finalization. Be aware of the following notes when finalizing a disc.

Note:

If you enter a disc name and remove the disc without finalizing it, the name will not be stored. You will need to enter the name again.

Erasing the disc name and track names

Follow the steps below to erase all the name information retained in the CDR-201A. Set the CDR-201A to the stop state in advance.

1 Press the EDIT/NO button and turn the MULTI JOG dial until "Name Erase?" appears.

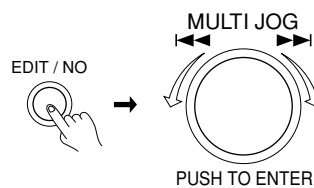

"Name Erase?"

2 Press the MULTI JOG dial.

Pressing the YES button provides the same operation. When completed, "Complete" appears in the display and the CDR-201A will stop. See page 42 to erase the names written to a (finalized) CD-RW.

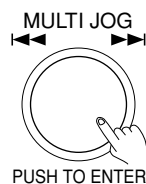

Finalization

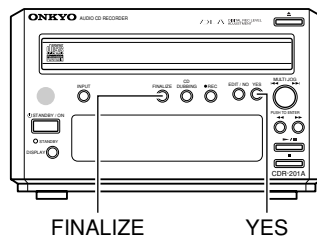

Finalization is a process of writing the TOC data (track numbers etc.) and the name information retained in the CDR-201A to the special area (PMA) of the disc.

After finalization

CD-Rs can be played in CD players. Even after finalization, CD-RWs can only be played on CD players that are compatible with CD-RWs. For finalized CD-Rs, you cannot add more recordings and name information.

When finalization finishes

"Complete" appears in the display and finalization automatically stops.

To stop the finalization process

Press the  button or the EDIT/NO button (before pressing the YES button in step 3).

Display after finalization

For CD-Rs, the display becomes that for CDs. For CD-RWs, the display does not change, except that FINALIZE is added.

1 Insert the CD-R or CD-RW to be finalized into the CDR-201A.

2 Press the FINALIZE button.

"Finalize?" appears.

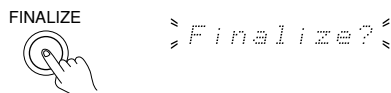

3 Press the YES button.

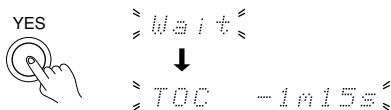

Finalization begins. During finalization, the remaining time is displayed. (Finalization takes approx. 80 seconds.)

The display of the remaining time is only a guide and the actual time until the process is completed may be a little before or after.

Notes:

- Never turn off the power or remove the power cord during finalization. Doing so may damage all the data on the disc. An inserted disc can be corrupt and no longer usable if the power is accidentally turned off or in case of power failure.
- Do not shake or subject the CDR-201A to vibrations during recording, finalizing, erasing, or while "PMA Writing" is displayed. Doing so may cause the sound on the disc to skip or the data on the disc to become unreadable.
- Never finalize discs that are scratched, dirty, or dusty. The process may not be carried out properly.
- During finalization, the operation button on the CDR-201A will be disabled.

Auto finalization

For CD dubbing, you can turn on the auto finalization function. When auto finalization is turned on, finalization occurs automatically at the end of recording. For details, refer to the applicable pages.

Erasing recordings (CD-RW discs only)

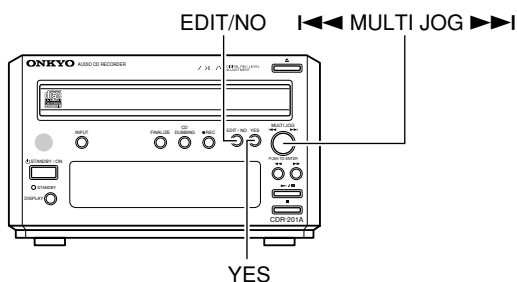

The data recorded on CD-RW discs can be erased and the disc can be used again as many times as desired. The erasing methods are given below.

■ Erasing data on unfinalized CD-RWs

All track erase: Erases all tracks.

Last track erase: Erases only the last track.

■ Erasing data on finalized CD-RWs

All track erase: Erases all tracks.

TOC erase: Returns a finalized disc to the unfinalized condition.

■ Erasing discs

Erases all data recorded on the CD-RW.

Note:

If "Disc Error" appears during an erase, abort the erase and check the disc for scratches, dirt, or dust. After removing any dirt or dust that may exist, resume the erase.

Erasing data on non-finalized CD-RWs

Insert the CD-RW you wish to erase and place the CDR-201A in the stop state.

■ Erasing all tracks

This operation will erase all recorded tracks and entered names (the disc name and/or track titles) in the CD-RW disc.

- 1 Press the **EDIT/NO** button and turn the **MULTI JOG** dial until "All Erase?" appears.

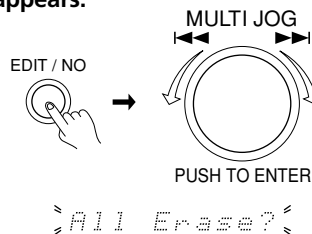

- 2 Press the **MULTI JOG** dial.

Pressing the YES button provides the same operation.

"All Ers ??" appears.

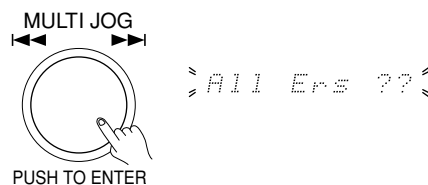

- 3 Press the **MULTI JOG** dial.

Pressing the YES button provides the same operation.

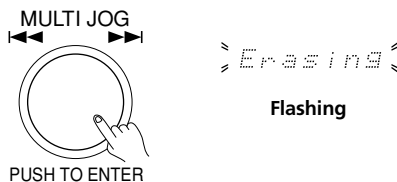

Erasing begins. When completed, "Complete" appears in the display and the CDR-201A will stop.

Erasing recordings (CD-RW discs only)

■ Erasing the last track

- 1** Press the EDIT/NO button and turn the MULTI JOG dial until "Last Erase?" appears.

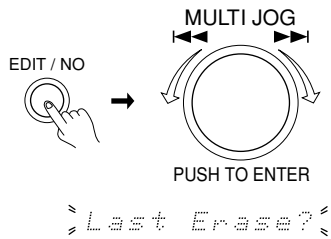

- 2** Press the MULTI JOG dial.

Pressing the YES button provides the same operation.

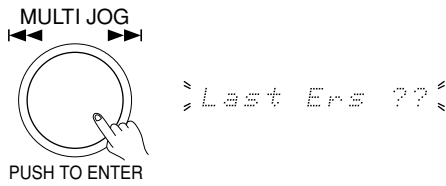

"Last Ers ??" appears.

- 3** Press the MULTI JOG dial.

Pressing the YES button provides the same operation.

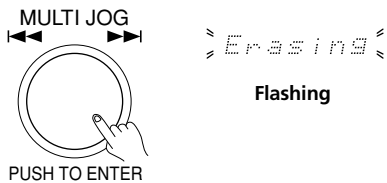

Erasing begins. When completed, "Complete" appears in the display and the CDR-201A will stop.

Erasing recordings (CD-RW discs only)

Erasing data on finalized CD-RWs

■ Erasing all tracks

- 1 Press the EDIT/NO button and turn the MULTI JOG dial until "All Erase?" appears.

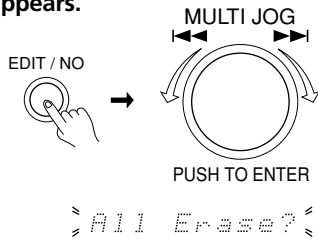

- 2 Press the MULTI JOG dial.

Pressing the YES button provides the same operation.

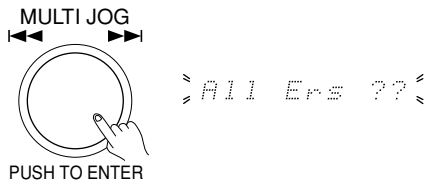

"All Ers ??" appears.

- 3 Press the MULTI JOG dial.

Pressing the YES button provides the same operation.

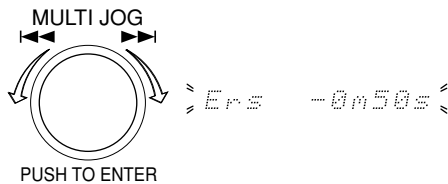

Erasing begins. When completed, "Complete" appears in the display followed by "Blank Disc." The time remaining until the deletion is completed appears (approx. 1 minute). The display of the remaining time is only a guide and the actual time until the process is completed may be a little before or after.

■ Unfinalizing the disc (TOC erase)

- 1 Press the FINALIZE button.

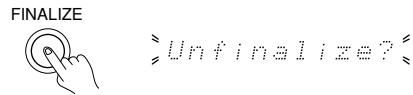

"Unfinalize?" appears.

- 2 Press the YES button.

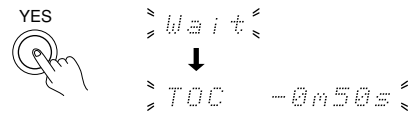

The unfinalization process starts. The time remaining until the unfinalization is completed appears (approx. 1 minute). The display of the remaining time is only a guide and the actual time until the process is completed may be a little before or after.

After TOC is erased

"Complete" appears in the display and the CDR-201A will stop.

Note:

If you unfinalize a disc that contains data for track names, be sure to remove the disc only after finalizing it again. Otherwise, the name data will not be saved.

Erasing recordings (CD-RW discs only)

Erasing entire disc

1 Insert the CD-RW to be erased.

2 Press the **EDIT/NO** button and turn the **MULTI JOG** dial until "Disc Erase?" appears.

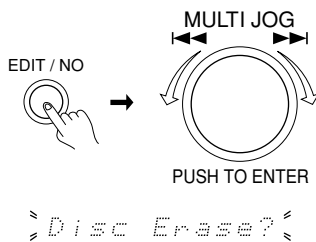

3 Press the **MULTI JOG** dial.

Pressing the YES button provides the same operation.
"Disc Ers ??" appears.

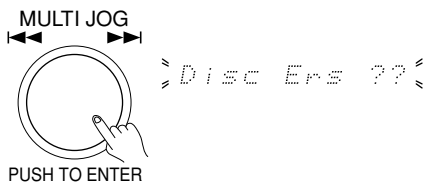

4 Press the **MULTI JOG** dial.

Pressing the YES button provides the same operation.
A display conforming the erase appears and erasing begins.
The time remaining for the erase appears.

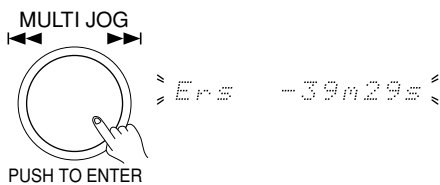

This process requires an amount of time equal to about one half of the total recording time of the disc.

The display of the remaining time is only a guide and the actual time until the process is completed may be a little before or after.
When the deletion is completed, the tray opens automatically.

Stopping an erase

Press the **■** button for approx. 5 seconds.
However, within 2 minutes from the start of the erase, the erase cannot be stopped. Once the DISC indicator begins flashing, the erase can be stopped.
The recording will not properly be erased, so be sure to perform the erase again.

Playing CDs

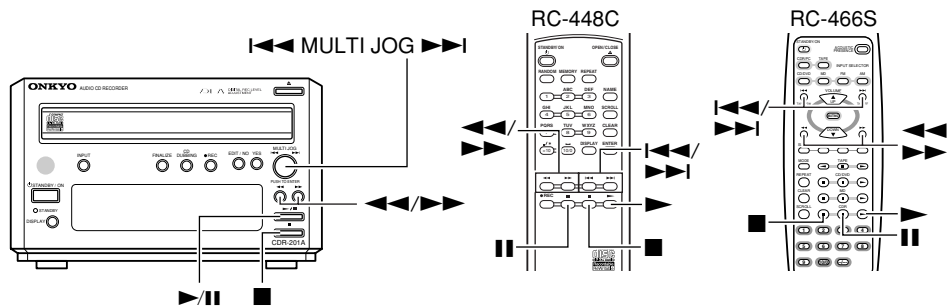

The CDR-201A is capable of four different styles of playback.

- Normal playback
- Random playback
- Repeat playback
- Programmed playback

Preparation

- Turn on the CDR-201A (see page 20).
- Place the CD or recorded CD-R or CD-RW in the CDR-201A (see page 20).

Normal playback

Press the ►/|| button.

Playback starts at track 1.

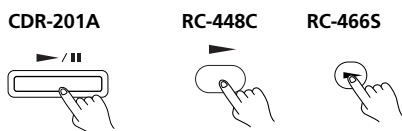

To pause playback

Press the ►/|| button (or the remote controller || button). To resume playback, press the ►/|| button (or the remote controller ► button).



To stop playback

Press the ■ button.

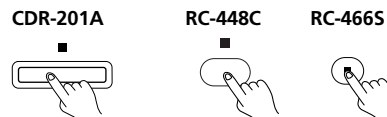

To skip to specific track

Turn the MULTI JOG dial to the left or right and select the desired track. With the remote controller, press the I◀◀ or ▶▶I button.

I◀◀: Press once to skip to the beginning of the track currently being played. Press twice in succession to skip to the beginning of the previous track.

▶▶I: Press once to skip to the beginning of the next track.

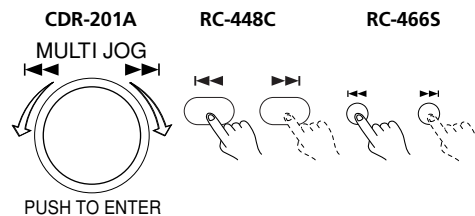

To fast forward or rewind (search)

Press the ◀◀ or ▶▶ button.

◀◀: Press for rewind.

▶▶: Press for fast forward.

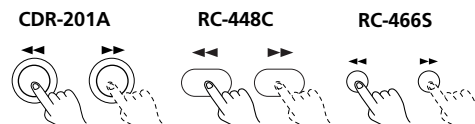

To play a specific track

Press the number of the desired track with the numerical buttons on the remote controller to start playback from that specific track (see page 46).

Playing CDs

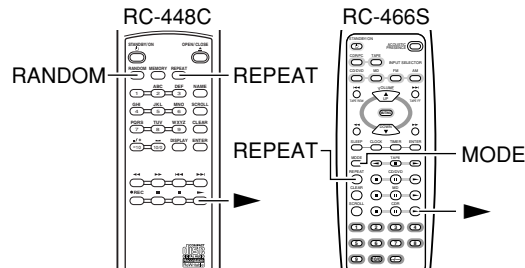

Random playback

Note:

This function is only for CDs and for CD-Rs and CD-RWs that have been finalized.

With playback stopped, press the **RANDOM** button

With the RC-466S remote controller, repeatedly press the MODE button to select the random mode. When you press the ► button, the random playback mode plays all the tracks on the disc in random order. The RANDOM indicator lights.

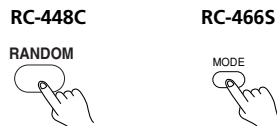

To stop the random playback mode

With playback stopped, press the RANDOM button.

Notes:

- While in the random playback mode, the numerical buttons do not operate.
- The EDIT/NO button will not work when the RANDOM indicator lights.
- During random playback, the remaining time of total time of the disc is not displayed.

Repeat playback

Press the **REPEAT** button as many times as desired

Selecting "REPEAT" repeats all tracks.
Selecting "REPEAT 1" only repeats only the track currently being played.

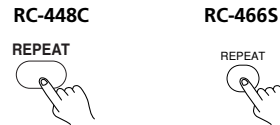

To stop repeat playback

Repeatedly press the REPEAT button until "REPEAT" is no longer displayed.

Memo:

- You can press the REPEAT button during random playback to repeatedly playback all tracks in random order.
- You can press the REPEAT button during programmed playback to repeatedly playback the track currently being played or the track programmed.

Playing CDs

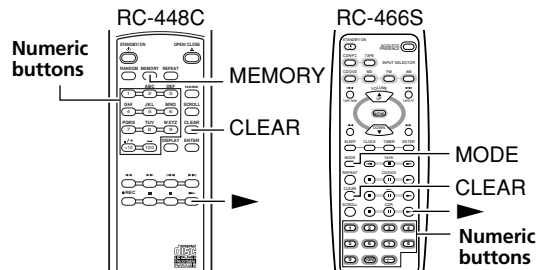

Programmed playback

Programmed playback allows you to select only the tracks that you want to play and in which order that you them to be played. Up to 32 tracks can be programmed at one time. This function is only for CDs and for CD-Rs and CD-RWs that have been finalized.

To verify the programmed track numbers

Press the ◀◀/▶▶ button.

Memo:

You can also turn the MULTI JOG dial to select tracks and press the dial to enter them.

1 With playback stopped, press the MEMORY button.

With the RC-466S remote controller, repeatedly press the MODE button to select the programmed mode. The MEMORY indicator lights.



3 Press the ▶ button.

Playback starts to the order programmed.

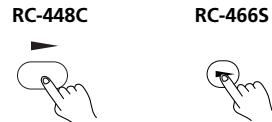

2 Press the numeric buttons for the tracks that you want to hear in the order that you want to hear them.

To select track numbers of 11 or greater (up to 99)

RC-448C: Press the [>10] button, then the numeric button corresponding to the 10's digit for the track number, and then the numeric button corresponding to the 1's digit.
Example: Track number 35: [>10] + [3] + [5]

RC-466S: Press the [--/--] button and then press the numeric button corresponding to the 10's digit for the track number, and then the numeric button corresponding to the 1's digit.
Example: Track number 35: [--/--] + [3] + [5]

To stop programmed playback

Press the ■ button.

To stop the programmed playback mode

With playback stopped, press the MEMORY button.

To clear the programmed tracks

With playback stopped, press the CLEAR button. Each time a button is pressed, the last track is cleared.

Note:

The numeric buttons are disabled during programmed playback.

Further, the EDIT/NO button will not work when the MEMORY indicator lights.

Total time of the programmed tracks

Total time of the programmed tracks is displayed as "m--s" when it exceeds 100 minutes.

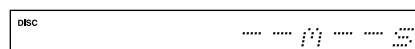

Timer playback (component system operation)

When connected to the R-801A component, playback using the timer is possible. For more information on how to set the timer, refer to the instruction manual with the R-801A.

1 Insert a disc for playback.

2 Set the timer for the R-801A.

Other Information Display messages

Message	Explanation	Pages
Open	Disc tray is opening.	—
Welcome	Disc tray is closing.	—
Rec Setup	Setting initial settings for recording. Please wait.	23
TOC Reading	Reading the table of contents recorded on the disc. Please wait.	—
PMA Writing	Recording TOC data to the disc PMA (Program Memory Area). Never turn off the power while this message is displayed.	18
Wait	Writing or reading of data for track names is taking place during the finalization of a disc or during the restoring of a disc to its pre-finalization state.	39, 42
Erasing	Erasing all tracks or the last track. Wait until the process is completed.	40, 41
No Track	The tracks are not entered, but the disc name is.	—

If during operation a malfunction occurs or an improper operation is performed, the corresponding message will appear. For a description of these messages, refer to the explanations on the following pages.

Troubleshooting guide

If the CDR-201A begins to operate improperly, use the troubleshooting guide below to help you ascertain the problem. Because the unit contains a microcomputer to provide advanced functions, it may malfunction due to external noise or static electricity. If this happens, disconnect the power cord and then plug it in again after about 5 seconds. If it still does not operate properly, press and hold the STANDBY/ON button until the standby indicator and display turn off (approx. 5 seconds).

About the self-diagnosis function

The CDR-201A is equipped with a self-diagnosis function. If a malfunction is detected during operation, one of the messages given below will appear in the front display.

Display	Cause	Remedy
Disc Error	<ul style="list-style-type: none"> • Playback was likely stopped due to dirt, dust, scratches, or vibrations. • The disc has been placed in upside down. 	<ul style="list-style-type: none"> • Eject the disc and check for dirt, dust, and scratches. • Eject the disc and check that it is placed in correctly. <p>If you place the disc correctly and the same message appears, unplug the power cord and plug it back in again. If the same message appears again, contact an Onkyo service representative.</p>
System Err. (flashing)	A malfunction has occurred in the system due to excessive noise or static electricity.	Unplug the power cord and plug it back in again. If the same message appears again, contact an Onkyo service representative.
Mecha Error	Mechanical malfunction has occurred.	Remove the disc and check it for damage. If the disc cannot be removed, disconnect the power cord and then reconnect it. If the same message appears, contact an Onkyo Service Station.
Rec Error	Malfunction occurred during recording.	Eject the disc and check for dirt, dust, and scratches.
OPC Error	Malfunction occurred during the OPC (*1) process.	Eject the disc and check for dirt, dust, and scratches. If there is a problem with the disc, replace it with one suitable for recording.

Messages during recording

Display	Cause	Remedy
Cannot Copy	The input digital signal contains a copy guard signal (SCMS).	Record an analog signal or recordable music signal (see page 26).
D. In Unlock	<ul style="list-style-type: none"> • The digital input is blocked. • Data has been input in the CD-ROM, etc. 	<ul style="list-style-type: none"> • Verify that the player component is properly playing and the digital cable is properly connected (see page 17). • Verify that source signal is a normal music signal (see page 18).
Rec Setup	The CDR-201A is entering the recording standby state.	Wait until the message disappears.
Disc Full	Either the disc is full of recordings or 99 tracks have been recorded and no more recordings can be made on the disc.	Use a new disc.
Pro Disc	A CD-R or a CD-RW not for music recording use (without the "FOR CONSUMER" marking) or a CD-RW has been inserted.	Eject the disc and check whether it meets the specifications for use with the CDR-201A. Always insert a disc that has the markings "FOR CONSUMER" or "FOR MUSIC USE ONLY" on its surface (see page 13).

Troubleshooting guide

Messages during recording (continued)

Display	Cause	Remedy
CD Dub Fail	CD dubbing cannot be performed because "Digital In 1" is not selected for the input source.	Select "Digital In 1" for the input source.
	CD dubbing cannot be performed because the connected component (Onkyo separate collection's cassette deck or MD recorder) is in the recording or recording standby state.	Cancel the recording or recording standby state on the connected component.
	CD dubbing cannot be performed because the components are not properly connected.	Make sure that proper connections is made for the RI cable, audio connection cables, and optical digital cable.
Cannot Rec	Recording cannot be performed because a finalized CD-R is used.	Replace it with a non-finalized CD-R.
	Recording cannot be performed because a finalized CD-RW is used.	Replace it with a non-finalized CD-RW. Or, retry recording after unfinalizing it.

Messages during playback, name input, and other situations

Display	Cause	Remedy
Blank Disc	You have tried to play a disc that has no recordings on it.	If the inserted disc is a CD-R or CD-RW with no recordings, you may record onto it, but it cannot be played.
No Disc	No disc has been inserted.	Open the disc tray and make sure that a disc is inserted.
Name Full	Entering name information exceeding the limitation of 1000 characters per disc was attempted.	You can enter up to 1000 characters per disc (see page 34).
Full	Entering a name exceeding the limitation of 24 characters per name was attempted.	You can enter up to 24 characters per name (see page 34).
Memory Full	Programming more than 32 tracks was attempted.	You can program up to 32 tracks.
Cannot Edit	<ul style="list-style-type: none"> Editing of a CD or finalized CD-R was attempted. Editing of a finalized CD-RW was attempted while in the memory or random playback mode. Editing of the name of a finalized CD-RW was attempted using the remote controller. 	<ul style="list-style-type: none"> Exit the memory or random playback mode. To edit the disc name, first unfinalize the disc.
DAO Disc	Unfinalizing a disc recorded with the DAO method (*2) using a computer was attempted.	Unfinalization cannot be performed using the CDR-201A.
Not Audio	A signal that cannot be recorded is being input.	Input only recordable audio signals (see page 18).
Data Disc	One or more data tracks exist on the disc.	Insert a disc that is suitable for recording.
PCA Full	Since no PCA (*3) remains, no more tracks can be added.	Insert a disc that is suitable for recording.
PMA Full	Since no PMA remains, no more tracks can be added.	Insert a disc that is suitable for recording.

*1 OPC (Optimum Power Control)/*3 PCA (Power Calibration Area)

If an unfinalized disc is inserted into the CDR-201A, experimental recording is performed in a specified area on the disc to calculate the optimum laser power. This process is called OPC and the area for the experimental recording is called the PCA.

*2 DAO (Disc At Once)

One type of recording method. Additional tracks cannot be added when this method is used.

Troubleshooting guide

Trouble	Cause	Remedy
The power does not turn on	The power cord is not properly plugged in.	Plug the power cord properly into a mains power supply.
	The component where the power cord is plugged into is not turned on.	Turn on the component into which the power cord is plugged.
No sound is output from the speakers	The speakers are not properly connected.	Connect the speakers following the procedure given in "Connecting the CDR-201A" on page 16.
Cannot record	The components are not properly connected.	Connect the components following the procedure given in "Connecting the CDR-201A" on page 16.
	A finalized CD-R or CD-RW is being used.	Use an unfinalized disc.
	The input switch is not properly set.	Switch to a properly connected input source (see pages 23, 25, 26, 27, 29).
	The recording level adjustment is set too low.	Adjust the recording level to a proper level (see page 24).
Recorded sound is distorted	The components are not properly connected.	Connect the components following the procedure given in "Connecting the CDR-201A" on page 16.
	Recording is being affected by the television.	Either turn off the television or move the CDR-201A away from the television.
	The disc is damaged or cracked.	Use another disc.
	The recording level adjustment is set too high.	Adjust the recording level to a proper level (see page 24).
	The disc is too dirty.	Clean the disc.
Remote controller does not work	The remote controller batteries are dead.	Replace all the remote controller batteries with new batteries (see page 9).
	There is an object between the CDR-201A and the remote controller obstructing the signals.	Remove the obstructing object (see pages 8, 9).
	The remote controller is being used outside of its operational range.	Use the remote controller within its operational range (see pages 8, 9).
A recorded CD-R cannot be played in normal CD players	The disc was not finalized after recording. (The CD-R indicator lights when the disc is played with the CDR-201A)	Perform the finalization process (see page 39).

Rules concerning digital recording

Guide to the serial copy management system

You cannot use digital recording to create a second-generation copy, a copy of a copy created through digital recording, with a CD-R or CD-RW. This is because the unit conforms to the Serial Copy Management System and permits only one generation of digital-to-digital copying (the recording of the original digital signals as they are). The Serial Copy Management System is based on the following three rules.

Principle 1

Digital-to-digital copying can be used to create a copy of a CompactDisc (CD), Digital Audio Tape (DAT), MiniDisk (MD), etc. with a CD-R or CD-RW. However, digital-to-digital copying is not allowed to create a copy of a CD-R or CD-RW that has been created through digital-to-digital copying.

Principle 2

Digital-to-digital copying can be used to create a copy of a CD-R or CD-RW that contains the songs from analog records, FM radio programs, etc. you recorded using the unit. However, digital-to-digital copying is not allowed to create a copy of a CD-R or CD-RW that has been created through digital-to-digital copying. When two CD recorders are connected via the analog input and output terminals, however, recording can be performed beyond this restriction.

Principle 3

With a DAT deck or a CD recorder that supports the sampling frequencies of 32 kHz and 48 kHz, digital-to-digital copying can be used to record the digital sound from satellite broadcast. (This CD recorder supports these sampling frequencies.) In this case, digital-to-digital copying is allowed to create a second-generation copy. However, with some BS tuners, second-generation copy may not be produced.

- * When CD recorders are connected using analog terminals, the number of dubbings is not limited.

Specifications

System	Compact disc recorder
Recording/playing time	Max. 80 min (Approx., when using an 80-min disc)
D/A converter	Advanced Multi bit
Digital filter	8 times oversampling
Connections	1 analog output, 1 analog input 2 digital input (optical), 1 digital output (optical)
Frequency response	10 Hz to 20 kHz
Playback total harmonic distortion	0.012 % (1 kHz)
Playback dynamic range	85 dB
Playback signal-to-noise ratio	98 dB
Recording total harmonic distortion	0.015 % (1 kHz)
Recording dynamic range	85 dB
Recording signal-to-noise ratio	82 dB
Channel separation	75 dB (during playback)
Wow and flutter	Below threshold of measurability
Output level	2.0 V r.m.s. (analog)
Power supply	AC230-240 V, 50 Hz
External dimensions	155 (W) x 94 (H) x 307 (D) mm
Weight	2.8 kg

Specifications and features are subject to change without notice.

ONKYO CORPORATION

Sales & Product Planning Div. : 2-1, Nisshin-cho, Neyagawa-shi, OSAKA 572-8540, JAPAN
Tel: 072-831-8111 Fax: 072-833-5222 <http://www.onkyo-intl.com>

ONKYO U.S.A. CORPORATION

18 Park Way, Upper Saddle River, N.J. 07458, U.S.A.
Tel: 201-785-2600 Fax: 201-785-2650 <http://www.onkyousa.com>

ONKYO EUROPE ELECTRONICS GmbH

Lignitzerstrasse 6, 82194 Groebenzell, GERMANY
Tel: +49-8142-4401-0 Fax: +49-8142-4401-555 <http://www.onkyo.net>

ONKYO CHINA LIMITED

Units 2102-2107, Metroplaza Tower I, 223 Hing Fong Road, Kwai Chung,
N.T., HONG KONG Tel: 852-2429-3118 Fax: 852-2428-9039



SN 29343240

Printed in Japan
D0109-1



Free Manuals Download Website

<http://myh66.com>

<http://usermanuals.us>

<http://www.somanuals.com>

<http://www.4manuals.cc>

<http://www.manual-lib.com>

<http://www.404manual.com>

<http://www.luxmanual.com>

<http://aubethermostatmanual.com>

Golf course search by state

<http://golfingnear.com>

Email search by domain

<http://emailbydomain.com>

Auto manuals search

<http://auto.somanuals.com>

TV manuals search

<http://tv.somanuals.com>