

# CD Recorder CDR-205X

Before using

Connections

Operations

Other Information

## Operating Instructions

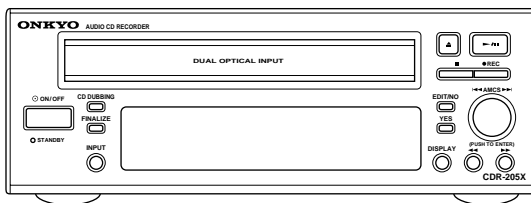

# Before using Thank you for purchasing ...

Thank you for purchasing the ONKYO CDR-205X CD Recorder.

Please read this manual thoroughly before making connections and plugging in the unit.

Following the instructions in this manual will enable you to obtain the optimum performance and listening enjoyment from your new CDR-205X.

Please retain this manual for future reference.

## Main Features

- **CD/CD-R/CD-RW Disc Compatibility**
- **Auto Finalizing Function**
- **32kHz/44.1kHz/48kHz Sampling-Rate Converter**
- **High-Resolution D/A & A/D Converter**
- **2 Optical Digital Inputs**
- **1 Optical Digital Output**
- **2-Mode (Album/Fade) One-Touch CD Recording**
- **Digital Signal Synchro Recording**
- **Adjustable Recording Volume (Digital/Analog)**
- **RI Compatible Remote Control Included**

### WARNING:

TO REDUCE THE RISK OF FIRE OR ELECTRIC SHOCK, DO NOT EXPOSE THIS APPLIANCE TO RAIN OR MOISTURE.



**WARNING**  
RISK OF ELECTRIC SHOCK  
DO NOT OPEN

**AVIS**  
RISQUE DE CHOC ELECTRIQUE  
NE PAS OUVRIR



### CAUTION:

TO REDUCE THE RISK OF ELECTRIC SHOCK, DO NOT REMOVE COVER (OR BACK). NO USER-SERVICEABLE PARTS INSIDE. REFER SERVICING TO QUALIFIED SERVICE PERSONNEL.



The lightning flash with arrowhead symbol, within an equilateral triangle, is intended to alert the user to the presence of uninsulated "dangerous voltage" within the product's enclosure that may be of sufficient magnitude to constitute a risk of electric shock to persons.

The exclamation point within an equilateral triangle is intended to alert the user to the presence of important operating and maintenance (servicing) instructions in the literature accompanying the appliance.

## Important Safeguards

1. **Read Instructions** – All the safety and operating instructions should be read before the appliance is operated.
2. **Retain Instructions** – The safety and operating instructions should be retained for future reference.
3. **Heed Warnings** – All warnings on the appliance and in the operating instructions should be adhered to.
4. **Follow Instructions** – All operating and use instructions should be followed.
5. **Cleaning** – Unplug the appliance from the wall outlet before cleaning. The appliance should be cleaned only as recommended by the manufacturer.
6. **Attachments** – Do not use attachments not recommended by the appliance manufacturer as they may cause hazards.
7. **Water and Moisture** – Do not use the appliance near water –for example, near a bath tub, wash bowl, kitchen sink, or laundry tub; in a wet basement; or near a swimming pool; and the like.
8. **Accessories** – Do not place the appliance on an unstable cart, stand, tripod, bracket, or table. The appliance may fall, causing serious injury to a child or adult, and serious damage to the appliance. Use only with a cart, stand, tripod, bracket, or table recommended by the manufacturer, or sold with the appliance. Any mounting of the appliance should follow the manufacturer's instructions, and should use a mounting accessory recommended by the manufacturer.
9. An appliance and cart combination should be moved with care. Quick stops, excessive force, and uneven surfaces may cause the appliance and cart combination to tip over.  
PORTABLE CART WARNING



S3125A

## Important Safeguards

10. **Ventilation** – Slots and openings in the cabinet are provided for ventilation and to ensure reliable operation of the appliance and to protect it from overheating, and these openings must not be blocked or covered. The openings should never be blocked by placing the appliance on a bed, sofa, rug, or other similar surface. The appliance should not be placed in a built-in installation such as a bookcase or rack unless proper ventilation is provided. There should be free space of at least 5 cm (2 in.) and an opening behind the appliance.
11. **Power Sources** – The appliance should be operated only from the type of power source indicated on the marking label. If you are not sure of the type of power supply to your home, consult your appliance dealer or local power company.
12. **Grounding or Polarization** – The appliance may be equipped with a polarized alternating current line plug (a plug having one blade wider than the other). This plug will fit into the power outlet only one way. This is a safety feature. If you are unable to insert the plug fully into the outlet, try reversing the plug. If the plug should still fail to fit, contact your electrician to replace your obsolete outlet. Do not defeat the safety purpose of the polarized plug.
13. **Power-Cord Protection** – Powersupply cords should be routed so that they are not likely to be walked on or pinched by items placed upon or against them, paying particular attention to cords at plugs, convenience receptacles, and the point where they exit from the appliance.
14. **Lightning** – For added protection for the appliance during a lightning storm, or when it is left unattended and unused for long periods of time, unplug it from the wall outlet and disconnect the antenna or cable system. This will prevent damage to the appliance due to lightning and power-line surges.
15. **Overloading** – Do not overload wall outlets, extension cords, or integral convenience receptacles as this can result in a risk of fire or electric shock.
16. **Object and Liquid Entry** – Never push objects of any kind into the appliance through openings as they may touch dangerous voltage points or short-out parts that could result in a fire or electric shock. Never spill liquid of any kind on the appliance.
17. **Servicing** – Do not attempt to service the appliance yourself as opening or removing covers may expose you to dangerous voltage or other hazards. Refer all servicing to qualified service personnel.
18. **Damage Requiring Service** – Unplug the appliance from the wall outlet and refer servicing to qualified service personnel under the following conditions:
  - A. When the power-supply cord or plug is damaged,
  - B. If liquid has been spilled, or objects have fallen into the appliance,
  - C. If the appliance has been exposed to rain or water,
  - D. If the appliance does not operate normally by following the operating instructions. Adjust only those controls that are covered by the operating instructions as an improper adjustment of other controls may result in damage and will often require extensive work by a qualified technician to restore the appliance to its normal operation,
  - E. If the appliance has been dropped or damaged in any way, and
  - F. When the appliance exhibits a distinct change in performance – this indicates a need for service.
19. **Replacement Parts** – When replacement parts are required, be sure the service technician has used replacement parts specified by the manufacturer or have the same characteristics as the original part. Unauthorized substitutions may result in fire, electric shock, or other hazards.
20. **Safety Check** – Upon completion of any service or repairs to the appliance, ask the service technician to perform safety checks to determine that the appliance is in proper operation condition.
21. **Wall or Ceiling Mounting** – The appliance should be mounted to a wall or ceiling only as recommended by the manufacturer.
22. **Heat** – The appliance should be situated away from heat sources such as radiators, heat registers, stoves, or other appliances (including amplifiers) that produce heat.

# Precautions

---

## 1. Warranty Claim

You can find the serial number on the rear panel of this unit. In case of warranty claim, please report this number.

## 2. Recording Copyright

Recording of copyrighted material for other than personal use is illegal without permission of the copyright holder.

## 3. Power

### WARNING

BEFORE PLUGGING IN THE UNIT FOR THE FIRST TIME, READ THE FOLLOWING SECTION CAREFULLY.

The voltage of the available power supply differs according to country or region. Be sure that the power supply voltage of the area where this unit will be used meets the required voltage (e.g., AC 230 V, 50 Hz or AC 120 V, 60 Hz) written on the rear panel.

Turning off the standby button does not shut off the power completely. So the power cord should be removed from the AC outlet when the unit is not used for a prolonged time.

## 4. Do not touch this unit with wet hands

Do not handle this unit or power cord when your hands are wet or damp. If water or any other liquid enters the case, take this unit to an authorized service center for inspection.

## 5. Location of this unit

Place this unit in a well-ventilated location.

Take special care to provide plenty of ventilation on all sides of this unit especially when it is placed in an audio rack. If ventilation is blocked, this unit may overheat and malfunction.

Do not expose this unit to direct sunlight or heating units as this unit's internal temperature may rise and shorten the life of the pickup.

Avoid damp and dusty places and places directly affected by vibrations from the speakers. In particular, avoid placing the unit on or above one of the speakers.

Be sure this unit is placed in a horizontal position. Never place it on its side or on a slanted surface as it may malfunction.

Do not place near tuners or TV sets.

If placed next to a TV or tuner, it may cause reception interference resulting in some noise in the TV or tuner output.

## 6. Care

From time to time you should wipe the front and rear panels and the cabinet with a soft cloth. For heavier dirt, dampen a soft cloth in a weak solution of mild detergent and water, wring it out dry, and wipe off the dirt. Following this, dry immediately with a clean cloth.

Do not use rough material, thinners, alcohol or other chemical solvents or cloths since these could damage the finish or remove the panel lettering.

## 7. Points to remember

If this unit is brought from a cold environment to a warm one or is in a cold room that is quickly heated, condensation may form on the pickup, preventing proper operation. In this case, remove the disc and leave the power ON for about one hour to remove the condensation.

When transporting this unit, be careful not to bump it.

### DANGER:

INVISIBLE LASER RADIATION WHEN OPEN AND INTERLOCK FAILED OR DEFEATED. AVOID DIRECT EXPOSURE TO BEAM.

### CAUTION:

THIS PRODUCT UTILIZES A LASER. USE OF CONTROLS OR ADJUSTMENTS OR PERFORMANCE OF PROCEDURES OTHER THAN THOSE SPECIFIED HEREIN MAY RESULT IN HAZARDOUS RADIATION EXPOSURE.

# Precautions

## For U.S. model

The laser is covered by a housing which prevents exposure during operation or maintenance. However, this product is classified as a Laser Product by CDRH (Center for Devices and Radiological Health) which is a department of the Food and Drug Administration. According to their regulations 21 CFR section 1002.30, all manufacturers who sell Laser Products must maintain records of written communications between the manufacturer, dealers and customers concerning radiation safety. If you have any complaints about instructions or explanations affecting the use of this product, please feel free to write to the address on the back page of this manual. When you write us, please include the model number and serial number of your unit.

In compliance with Federal Regulations, the certification, identification and the period of manufacture are indicated on the rear panel.

## FCC INFORMATION FOR USER

### CAUTION:



The user changes or modifications not expressly approved by the party responsible for compliance could void the user's authority to operate the equipment.

### NOTE:

This equipment has been tested and found to comply with the limits for a Class B digital device, pursuant to Part 15 of the FCC Rules. These limits are designed to provide reasonable protection against harmful interference in a residential installation. This equipment generates, uses and can radiate radio frequency energy and, if not installed and used in accordance with the instructions, may cause harmful interference to radio communications. However, there is no guarantee that interference will not occur in a particular installation. If this equipment does cause harmful interference to radio or television reception, which can be determined by turning the equipment off and on, the user is encouraged to try to correct the interference by one or more of the following measures:

- Reorient or relocate the receiving antenna.
- Increase the separation between the equipment and receiver.
- Connect the equipment into an outlet on a circuit different from that to which the receiver is connected.
- Consult the dealer or an experienced radio/TV technician for help.

**Declaration of Conformity**

<p>We, ONKYO EUROPE ELECTRONICS GmbH INDUSTRIESTRASSE 20 82110 GERMERING, GERMANY</p>	
<p>declare in own responsibility, that the ONKYO product described in this instruction manual is in compliance with the corresponding technical standards such as EN60065, EN55013, EN55020 and EN61000-3-2, -3-3 (or EN60555-2, -3)</p>	
<p>GERMERING, GERMANY</p>	 A.HORIUCHI
<p>ONKYO EUROPE ELECTRONICS GmbH</p>	

## Memory Preservation

This unit does not require memory preservation batteries. A built-in memory power back-up system preserves the contents of the memory during power failures and even when the unit is unplugged. The unit must be plugged-in in order to charge the back-up system.

The memory preservation period after the unit has been unplugged varies depending on climate and placement of the unit. On the average, memory contents are protected over a period of a few weeks after the last time the unit was unplugged. This period is shorter when the unit is exposed to a highly humid climate.

# Precautions

---

## For Canadian model

**NOTE:** THIS CLASS B DIGITAL APPARATUS COMPLIES WITH CANADIAN ICES-003.

For models having a power cord with a polarized plug:

**CAUTION:** TO PREVENT ELECTRIC SHOCK, MATCH WIDE BLADE OF PLUG TO WIDE SLOT, FULLY INSERT.

## Modele pour les Canadien

**REMARQUE:** CET APPAREIL NUMÉRIQUE DE LA CLASSE B EST CONFORME À LA NORME NMB-003 DU CANADA.

Sur les modèles dont la fiche est polarisée:

**ATTENTION:** POUR ÉVITER LES CHOCS ÉLECTRIQUES, INTRODUIRE LA LAME LA PLUS LARGE DE LA FICHE DANS LA BORNE CORRESPONDANTE DE LA PRISE ET POUSSER JUSQU'AU FOND.

## For European model

This unit contains a semiconductor laser system and is classified as a "CLASS 1 LASER PRODUCT". So, to use this model properly, read this Instruction Manual carefully. In case of any trouble, please contact the store where you purchased the unit. To prevent being exposed to the laser beam, do not try to open the enclosure.



This label on the left hand panel states that:

1. This unit is a CLASS 1 LASER PRODUCT and employs a laser inside the cabinet.
2. To prevent the laser from being exposed, do not remove the cover. Refer servicing to qualified personnel.

## For British model

Replacement and mounting of an AC plug on the power supply cord of this unit should be performed only by qualified service personnel.

### IMPORTANT

The wires in the mains lead are coloured in accordance with the following code:

Blue : Neutral  
Brown : Live

As the colours of the wires in the mains lead of this apparatus may not correspond with the coloured markings identifying the terminals in your plug, proceed as follows:

The wire which is coloured blue must be connected to the terminal which is marked with the letter N or coloured black.

The wire which is coloured brown must be connected to the terminal which is marked with the letter L or coloured red.

### IMPORTANT

A 5 amp fuse is fitted in this plug. Should the fuse need to be replaced, please ensure that the replacement fuse has a rating of 5 amps and that it is approved by ASTA or BSI to BS1362. Check for the ASTA mark or the BSI mark on the body of the fuse.

IF THE FITTED MOULDED PLUG IS UNSUITABLE FOR THE SOCKET OUTLET IN YOUR HOME, THEN THE FUSE SHOULD BE REMOVED AND THE PLUG CUT OFF AND DISPOSED OF SAFELY. THERE IS A DANGER OF SEVERE ELECTRICAL SHOCK IF THE CUT OFF PLUG IS INSERTED INTO ANY 13 AMP SOCKET.

If in any doubt, please consult a qualified electrician.

# Table of contents

## Before Using

Supplied accessories .....	7
Using the remote controller .....	8
Notes on usable CDs .....	10

## Connections

Connecting the CDR-205X .....	12
Connecting to the Onkyo Separate Collection .....	14
Turning on the power .....	15

## Operations

Inserting a disc .....	16
Changing the display .....	17
Recording modes .....	18
CD dubbing (component system operation) .....	20
Synchronous recording (component system operation) .....	22
Analog recording .....	24
Digital recording .....	26
Synchronous recording by input digital signal detection .....	28
Adjusting the recording level .....	29
Placing and removing SKIP commands .....	30
Finalization .....	32
Erasing recordings (CD-RW discs only) .....	33
Playing CDs .....	36
Skipping a track (using the SKIP command) .....	39
Timer playback (component system operation) .....	40

## Other Information

Display messages .....	41
Troubleshooting guide .....	42
Part names and functions .....	45
Rules concerning digital recording .....	48
Specifications .....	49

# Supplied accessories

Check that the following accessories are supplied with the CDR-205X.

- Audio connection cables × 2



- Optical digital cable × 1



- RI cable × 1



- Remote controller × 1



- Dry-cell batteries (size AA, R06, or UM-3) × 2



The CDR-205X uses an internal microcomputer that performs many complicated operations; however, on rare occasions, external noise or interference or static electricity may cause the microcomputer to malfunction. If this occurs, unplug the CDR-205X, wait approx. 5 seconds, and then plug it back in.

# Using the remote controller

- Using the RC-414C remote controller that is supplied with the Onkyo Separate Collection R-805X components to operate the CDR-205X.

## Installing the remote controller batteries

- ① Push the battery cover in the direction of the arrows shown and remove it.

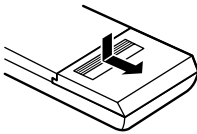

- ② Install the supplied (or AA, R06, or UM-3-sized) batteries into the battery compartment being careful not to mistake the polarity (follow the polarity diagram inside).

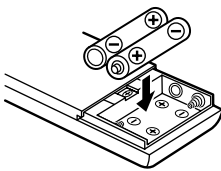

- ③ Replace the battery cover.

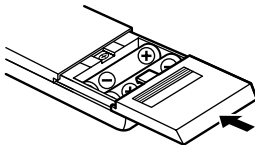

### Note:

- Do not mix new batteries with old batteries or different kinds of batteries.
- To avoid corrosion, remove the batteries if the remote controller will not be used for a long time.
- Immediately remove dead batteries to avoid damage to the remote controller from corrosion. If the remote controller begins to operate improperly, remove the old batteries and replace them with two new batteries.
- The life of the supplied batteries is approx. 1 year, though this value may vary depending on usage.

## Using the remote controller

When operating the remote controller, point it toward the remote control sensor of the Tuner amplifier.

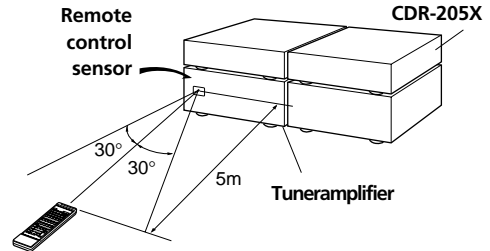

### Note:

- If the remote control sensor is subjected to direct sunlight or inverted fluorescent light, operation of the remote controller may be adversely affected.
- Use of another remote controller nearby or using the remote controller near equipment that uses infrared light may cause operational interference.
- Do not put objects on the remote controller. A button on the remote controller may remain pressed and drain the batteries.
- Make sure the CDR-205X is not placed behind colored glass doors. Placing the CDR-205X behind such doors may prevent proper operation of the remote controller.
- If there is an obstacle between the remote controller and the remote control sensor, the remote controller will not operate.



# Using the remote controller

## ■ Using the RC-413C remote controller that is supplied with the CDR-205X to operate the CDR-205X

### Installing the remote controller batteries

- ① Push the battery cover in the direction of the arrows shown and remove it.

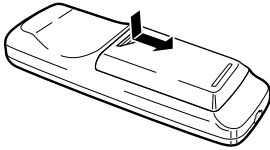

- ② Install the supplied (or AA, R06, or UM-3-sized) batteries into the battery compartment being careful not to mistake the polarity (follow the polarity diagram inside).

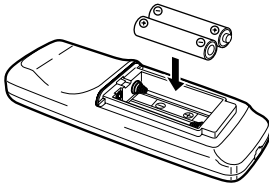

- ③ Replace the battery cover.

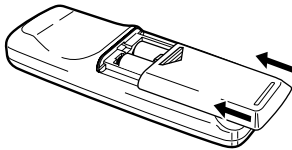

#### Note:

- Do not mix new batteries with old batteries or different kinds of batteries.
- To avoid corrosion, remove the batteries if the remote controller will not be used for a long time.
- Immediately remove dead batteries to avoid damage to the remote controller from corrosion. If the remote controller begins to operate improperly, remove the old batteries and replace them with two new batteries.
- The life of the supplied batteries is approx. 1 year, though this value may vary depending on usage.

### Using the remote controller

When operating the remote controller, point it toward the remote control sensor of the CDR-205X.

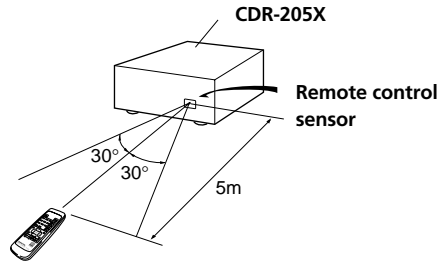

#### Note:

- If the remote control sensor is subjected to direct sunlight or inverted fluorescent light, operation of the remote controller may be adversely affected.
- Use of another remote controller nearby or using the remote controller near equipment that uses infrared light may cause operational interference.
- Do not put objects on the remote controller. A button on the remote controller may remain pressed and drain the batteries.
- Make sure the CDR-205X is not placed behind colored glass doors. Placing the CDR-205X behind such doors may prevent proper operation of the remote controller.
- If there is an obstacle between the remote controller and the remote control sensor, the remote controller will not operate.

# Notes on usable CDs

## CD-Recordable (CD-R) and CD-ReWritable (CD-RW) discs

When recording with the CDR-205X, you must use compact discs with the following marks printing on them:



### FOR CONSUMER FOR CONSUMER USE FOR MUSIC USE ONLY

(A disc with any of the above markings.)

Recording cannot be performed on discs that do not have one of the above markings.

Copyright fees have been enacted by copyright laws, and these fees are included in the price of CD-R\*<sup>1</sup> and CD-RW\*<sup>2</sup> discs, as well as discs labeled with "FOR CONSUMER," "FOR CONSUMER USE," and "FOR MUSIC USE ONLY." Therefore, the recording of music protected by copyright laws with these discs is permitted for personal use. However, copying for purposes other than personal use require the permission of the copyright holder.

## Compact discs

Always use compact discs with the following mark (optical digital audio discs):



## Cautions regarding copyrights

The lyrics and melodies composing the musical elements of media and musical performances from radio broadcasts, compact discs, records, music tapes, original cassettes, and other media are protected equally by copyright law. Therefore, the sale, transition, distribution, and re-release in media-form, or use as background music in stores and the like, is strictly forbidden without the previous express consent from the copyright holder.

## CD-R finalization process

After recording onto a CD-R disc, it is necessary to perform the finalization process before the CD-R can be played in CD players. After the finalization process is completed, you cannot perform additional recordings or place and remove SKIP commands.

## Unrecorded compact discs (recording is possible)

When unrecorded compact discs are inserted, "Blank Disc" appears flashing in the display.

» Blank Disc «

## Partly recorded compact discs (recording is possible)

### • Before finalization (recording is possible)

Compact discs that have not been finalized cannot be played in normal CD players; they can only be played in CD recorders.

» C D - R «

### • After finalization (recording is not possible)

Compact discs that have been finalized can be played in normal CD players.

» C D «

## CD-ReWritable (CD-RW) discs

CD-RW discs cannot be played in normal CD players even after finalization. CD-RW discs can only be played on players compatible with CD-RW discs. Also, with CD-RW discs, recording can be erased even after finalization.

When a finalized CD-RW disc is inserted, the CD-RW and FINALIZE indicator light.

# Notes on usable CDs

## Notes on discs

Never use heart-shaped, octagonal, or other special shaped discs as they may damage the internal mechanisms of the CDR-205X. Do not play CD-ROMs intended for computer use or



non-audio compact discs. Doing so may cause high-pitched noises or other unpredictable results that may damage speakers, amplifiers, and other connected components.

## Handling discs

Be careful not to touch the data side of the disc (the side that does not have printing on it). Always hold discs by the edges or by using the hole in the middle.

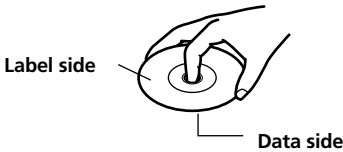

Never place labels or stickers on the data side or label side of the discs. Also, do not write on the discs or allow them to become scratched.



## Cautions when using rented compact discs

Do not use discs that have cellophane tape attached to them or rental compact discs that have rental labels attached. If the tape is sticking out or peeling off, the disc may not be able to be ejected and the CDR-205X may become damaged.

## Cleaning

Dirt and contaminants on discs can obstruct the pickup of the signals and lead to deterioration the sound. When dirty, clean the data side with a soft dry cloth, wiping from the inside of the disc toward the outside.



If the dirt is excessive, soak the cloth in water, wring it out, and then wipe the disc surface clean. Next, using a soft dry cloth, wipe the moisture from the disc surface.

Do not use conventional record cleaners or antistatic agents. Also, never use benzene, thinners, or other volatile agents as they may damage the disc surface.

## Cautions for disc storage

Do not store discs in locations exposed to direct sunlight, near heat emitting devices, and other locations of excessive heat, or locations of extremely low temperatures. Also, always store discs properly in their protective cases.

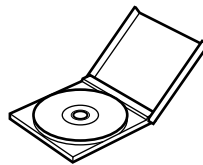

## Condensation

When moving the CDR-205X from a cold location to a hot location, when quickly heating a cold location with a furnace, or other similar situation, condensation may occur. This may not only cause improper operation of the device, but may also damage the discs and components.

If condensation has occurred, turn on the CDR-205X and leave it running for 1 to 2 hours. If you will not use the CDR-205X, then eject any disc inside.

# Connections

## Connecting the CDR-205X

### ■ Connecting to other components

The CDR-205X contains components that are extremely heat sensitive, so do not place the CDR-205X on the amplifier.

Always complete all connections before inserting the power cord into the wall outlet.

To L channel of the CDR-205X White  
To R channel of the CDR-205X Red

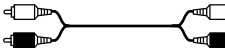

To L channel of other component White  
To R channel of other component Red

#### Protection cap for the optical digital input terminal

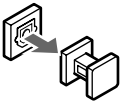

When necessary, remove this protection cap and store it safely. When not using the optical digital input terminal, be sure to put the cap back on the terminal.

Improper connection

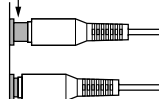

Insert completely

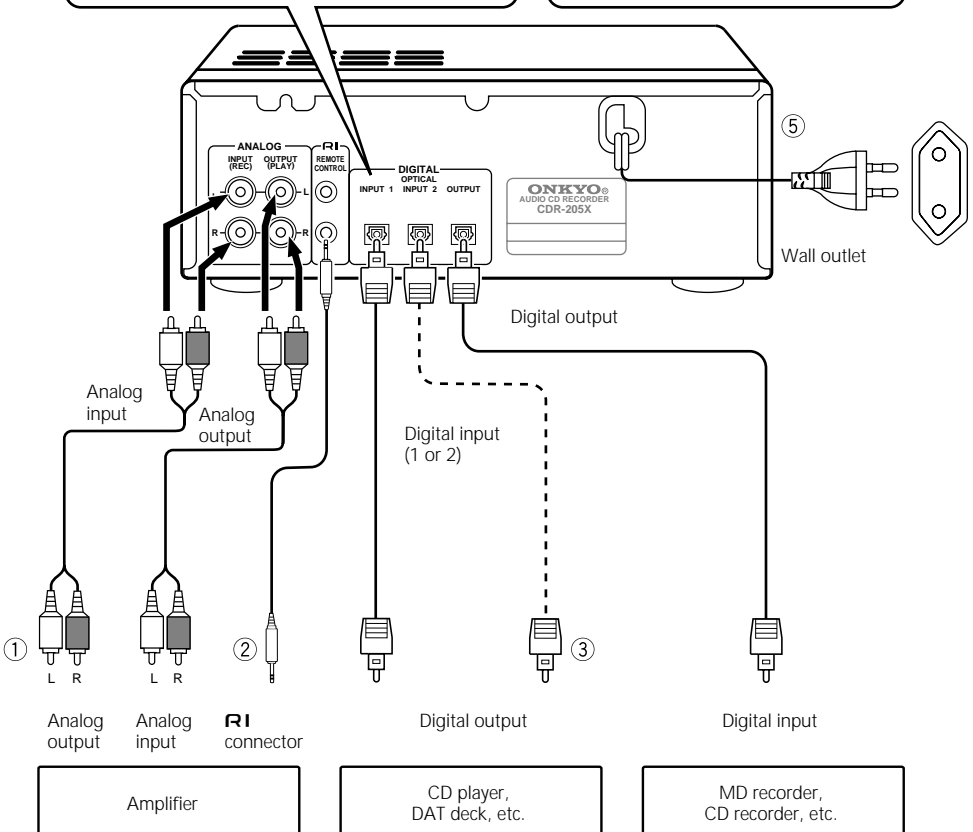

# Connecting the CDR-205X

---

## ① Connecting to an amplifier

Connect the CDR-205X to the CDR, TAPE or MD terminal on the amplifier.

- Connect the red connectors of the supplied audio connection cables to the R-channel terminals and the white connectors to the L-channel terminals.
- Make sure the connectors are properly inserted all the way. If the connectors are not properly connected, noise or improper operation may result.
- Do not bundle the audio cables together with power cords or speaker cables. Doing so cause deterioration of the audio signal.

## ② Connecting the **RI** cable

- With Onkyo components that are equipped with an **RI** connector, use the supplied **RI** cable to connect the **RI** connector to the **RI** connector of the CDR-205X.
- The **RI** connectors are only effective if they are used in conjunction with an Onkyo amplifier with an **RI** connector. Do not connect to a component other than an Onkyo component with an **RI** connector. Doing so may damage the CDR-205X.
- The function of the upper and lower **RI** connectors are the same. Connect to either one.
- Connecting the **RI** cable only does not make the system operational. You must also connect the audio cables as well.

## ③ Connecting to the digital input

Using the digital input, you can record digital audio from compact disc players, DAT decks, and other digital audio components that have a digital output. Connect using the supplied optical digital cable and either the DIGITAL INPUT 1 and 2 input on the CDR-205X. You can also connect to amplifiers that are equipped with digital output terminals.

### Notes:

- The optical digital terminal is provided with a protection cap installed. When necessary, remove this protection cap and store it safely. When not using the optical digital input terminal, be sure to put the cap back on the terminal.
- To perform digital input recording, you must connect to the optical digital input terminal. If the digital connection is not made, "D.In Unlock" will appear in the display.

## ④ Connecting to the digital output

Using the digital output, you can connect to MD recorders, CD recorders, DAT deck recorders, and other digital audio recorders that have optical digital input connectors for making digital recordings. You can also connect to amplifiers that are equipped with digital input terminals.

## ⑤ Connecting the power cord

# Connecting to the Onkyo Separate Collection

---

This section introduces you to the other Separate Collection Series system components and their convenient system functions, followed by connecting instructions.

The following Separate Collection series components are commercially available:

- R-805X ..... FM Stereo/AM Tuner Amplifier
- MD-105X ... MD Recorder (Not available in U.S.A. and Canada)
- K-505X ..... Stereo Cassette Tape Deck
- C-707CHX .. Compact Disc (CD) Changer (Only available in U.S.A. and Canada)

Note that the available components may vary according to the area.

Combination use of the unit with the above system components enables you to operate the following convenient functions.

- **Auto power on**

By turning on the CDR-205X or starting a playback with it, the power to the amplifier is automatically turned on as well. Also, when not using the CDR-205X, you can turn it off independently.

**Note:**

When the R-805X is in its energy save mode, the auto power on function will not work.

- **Direct change**

By pressing the play/pause button(▶/||) on the CDR-205X, the input source at the tuner amplifier automatically switches to CDR.

- **Remote controller operation**

The remote controller supplied with the R-805X can be used to operate the CDR-205X. (For more details, refer to the R-805X instruction manuals.)

- **Timer**

Timed playback is possible. (For more details, refer to page 40 of this instruction manual or to the R-805X instruction manuals.)

- **CD dubbing**

This function allows one-touch recording from the CD player to the CDR-205X. (For more details, refer to the page 20 of this instruction manual.)

- **CD - synchro recording**

By first setting the CDR-205X so that it is ready for recording, you can start the recording by just pressing play at the CD player. (For more details, refer to the page 22 of this instruction manual.)

- **Synchronous recording from the MD or tape deck**

By first setting the CDR-205X so that it is ready for recording, you can start the recording by just pressing play at the MD or tape deck. (For more details, refer to the page 23 of this instruction manual.)

# Turning on the power

When the CDR-205X is connected to a component system, it has three different states of on or off.

**Power on:** The ON/OFF switch is depressed (ON) and the remote controller or other system components are not turned off. The STANDBY indicator is turned off. This is the condition for normal operation.

**Standby:** The ON/OFF switch is depressed (ON) and the remote controller or other system components are turned off. The STANDBY indicator is turned on. When in the standby state, if the remote controller or other system components are turned on, the CDR-205X automatically turns on and system operation begins.

**Power off:** The ON/OFF switch is released (OFF). In this condition, the CDR-205X will not operate even if the remote controller or other system components are turned on.

## Operating the power supply

### 1 Press in the ON/OFF switch.

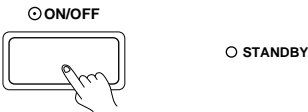

The CDR-205X turns on and the display illuminates.

### 2 Press the POWER button on the remote controller (press the STANDBY/ON button of the R-805X to put the R-805X in standby).

The standby indicator lights and the CDR-205X enters the standby state.

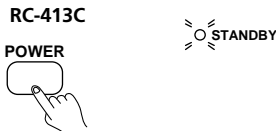

### 3 Press the POWER button on the remote controller (press the STANDBY/ON button of the R-805X to turn on the R-805X).

The STANDBY indicator turns off and the CDR-205X turns on again.

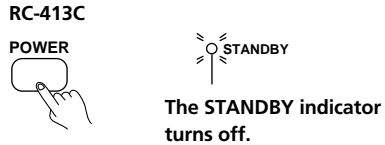

### 4 Press ON/OFF switch to release it.

The CDR-205X turns off.

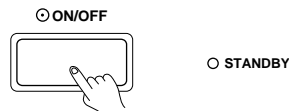

#### Note:

When the ON/OFF switch is in the OFF position, the CD recorder is still consuming some power. If you wish to disconnect your player completely from the mains, withdraw the plug from the AC outlet.

# Operations

## Inserting a disc

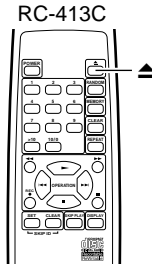
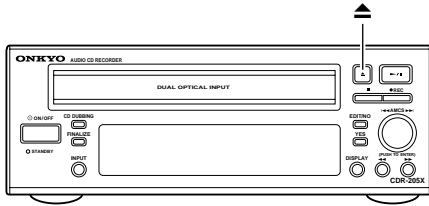

**1** Turn on the CDR-205X. (See page 15.)

**2** Press the  button.

The disc tray opens. Place the disc with the label-side up in the center of the tray.

CDR-205X



RC-413C



When the disc is inserted, the CDR-205X automatically scans the disc and displays the type in the front display.

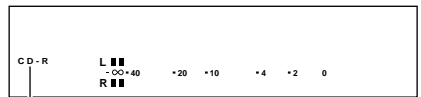

Disc indicator

**3** Press the  button.

The disc tray closes.

### Memo:

- ▶/|| You can also press the ▶/|| button (or the remote controller ▶ button) to close it.
- By pressing the ▶/|| button (or the remote controller ▶ button) in the standby state, the power is automatically turned on. If used in a component system with the R-805X, their power automatically turns on as well.

**CD** Commercially sold CD  
Finalized CD-R

**CD-R** Unrecorded CD-R  
Partly recorded  
(not finalized) CD-R

**CD-RW** Unrecorded CD-RW  
Partly recorded  
(not finalized) CD-RW

**CD-RW** Finalized CD-RW

**FINALIZE**



# Changing the display

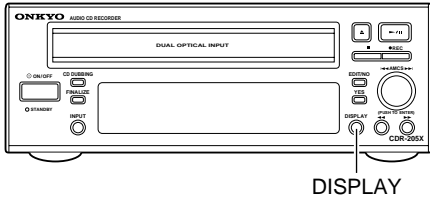

DISPLAY

RC-413C

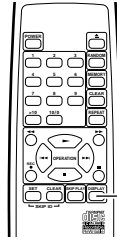

DISPLAY

## Display during recording

Repeatedly pressing the DISPLAY button during recording changes the display as shown below.

CDR-205X  
DISPLAY



RC-413C  
DISPLAY



Track number and elapsed time of track being recorded



Remaining available recording time

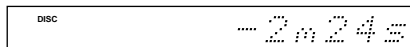

Total recording number of tracks and time

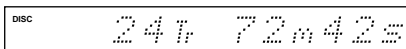

**(Return to first display)**

## Display during playback and while stopped

Repeatedly pressing the DISPLAY button during playback or while the CDR-205X is stopped changes the display as shown below.

CDR-205X  
DISPLAY



RC-413C  
DISPLAY



Track number and elapsed time of track being played (while stopped: 0m00s)



Track number remaining time of track being played (while stopped: 0m00s)



Total remaining playback time on disc (while stopped, the total recordable time)

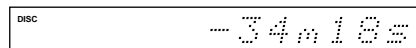

Total number of tracks and time of the disc

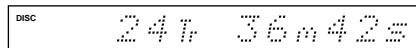

Number of programmed tracks and the total programmed playback time (for programmed playback only)

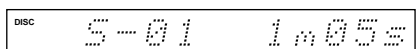

**(Return to first display)**

# Recording modes

## Cautions during recording

**In the following situations, recording is not possible even if the ● REC or CD DUBBING buttons are pressed.**

- The CD indicator is lit (a CD or finalized CD-R has been inserted).
- The CD-RW and FINALIZE indicators are lit (a finalized CD-RW has been inserted).
- The inserted disc is full and "Disc Full" is displayed.
- The 99th track has been recorded and "Disc Full" is displayed. Full" is displayed.

## Only the audio signals can be recorded

The CDR-205X is designed for recording audio signals only and therefore only digital signals that are audio signals are recorded. Other CD-ROM and Dolby Digital data, and the like, will not be recorded. Also, when recording from discs that have graphics or text data, only the audio signals will be recorded.

## The minimum track length is 4 seconds

For compact discs, the minimum track length is 4 seconds. Even if the ■ (stop) or || (pause) button is pressed immediately after starting recording, a silent 4-second track will be recorded. Also, during that 4 seconds, you cannot resume recording or perform another operation.

**Do not turn off the CDR-205X while making recordings, finalizing discs, or erasing recordings, or while "PMA Writing" is displayed**

If the power is turned off by mistake or a power outage occurs, when the power is turned back on and the recording will resume. However, there are times when the recording is not properly resumed and the disc is rendered irreparable.

## Recording mode for system setups

Below is an introduction to the type of recordings possible when the CDR-205X is connected to the R-805X, C-707CHX, K-505X, and MD-105X components.

### ■ CD dubbing (digital) (see page 20)

Digitally record all tracks from a music CD to a CD-R or CD-RW. When dubbing is completed, you can automatically select the finalization mode. The dubbing mode is selected at the EDIT menu.

**Album mode:** Only record the tracks that can be completely recorded.

**Fade-out mode:** Fade-out a track if it cannot be completely recorded.

### ■ Single-track CD dubbing (digital) (see page 21)

Record the track currently being played (or paused) with the CD player with one touch. The dubbing mode is the mode that is currently set; however, if the album mode is set, tracks that cannot be fully recorded will not be erased, but recorded until the disc becomes full.

### ■ Synchronous recording (see page 22)

When connected to a component system, the operations given below are possible.

- Synchronous recording from the CD player to the CDR-205X.
- Synchronous recording from the MD recorder or tape deck to the CDR-205X.
- Synchronous recording from the CDR-205X to a MD recorder or tape deck.

### Note:

For CD dubbing, single-track CD dubbing, and synchronous recording, you must have the optical digital cable from the C-707CHX connected to the digital input 1 terminal of the CDR-205X. For more details regarding system setup, refer to the instruction manual for the R-805X.

# Recording modes

## Normal recording mode

When not connected to a component system, there are a few methods that you can perform to record the signal in from the analog input or digital input of the CDR-205X.

### ■ Analog recording (see page 24)

This method records the signal at the analog inputs. The recording level can be adjusted manually.

### ■ Digital recording (see page 26)

This method records the signal at the optical digital inputs. The recording level can be adjusted manually.

### ■ Digital Signal synchronous recording (see page 28)

When recording together with a portable MD player or component that does not have an **RI** connector, you can synchronize the recording with the digital input signal.

## About the level sync function

The level sync function detects the space between tracks (songs, etc.) in the recording source and automatically assigns track numbers to them during recording.

### ■ For analog recording

The level sync function automatically turns off. To assign the track numbers, during recording press the ● REC at the locations where you want to add them. If there are gaps of no sound 2 seconds or longer between tracks in the recording source, you can turn on the level sync function and have the track numbers assigned automatically (see page 25).

### ■ For digital recording

The level sync recording automatically turns on. If the digital signal includes the track number information, the track numbers will be automatically assigned. For satellite broadcasts and other digital signals that do not include track number information, turn off the level sync function and assign the track numbers manually (see page 27).

## Finalization

The finalization process writes the TOC data (tracks, etc.) for the disc in a special area on the disc called the PMA. After finalization, CD-Rs can be played in CD players. Even after finalization, CD-RWs can only be played on CD players that are compatible with CD-RWs.

For CD-Rs that have been finalized, you cannot add more recordings, place SKIP commands,

## Erasing recording (CD-RW discs only)

The data recorded on CD-RW discs can be erased and the disc can be used again as many times as desired. (see page 33)

The erasing methods are given below.

- **Erasing data on unfinalized CD-RWs**

- **Last track erase:** Erases only the last track.

- **Multi-track erase:** Erases all tracks from the selected track to the final track.

- **All track erase:** Erases all tracks.

- **Erasing data on finalized CD-RWs**

- **All track erase:** Erases all tracks.

- **TOC erase:** Returns a finalized disc to the unfinalized conditions.

- **Erasing discs**

- Erases all data recorded on the CD-RW.

# CD dubbing (component system operation)

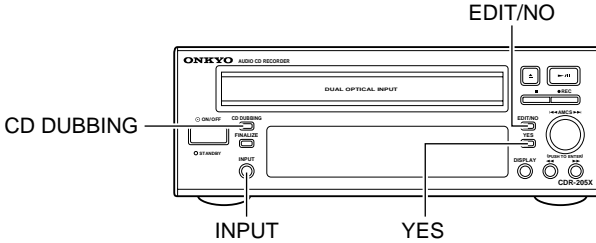

Perform CD dubbing to digitally record all the tracks from a music CD to a CD-R or CD-RW. The dubbing mode is selected at the EDIT menu.

## Preparation

- Turn on the CDR-205X (see page 15).
- Place the music CD in the CD player. (Refer to the instruction manual for the C-707CHX).
- Place a recordable CD-R or CD-RW in the CDR-205X (see page 16).

## 1 Repeatedly press the INPUT button until "Digital In1" appears.

INPUT



"Digital In1"

### Note:

CD dubbing cannot be performed when "Digital In2" or "Analog In" is selected.

## 2 Repeatedly press the EDIT/NO button until "CD DubMode" appears.

EDIT/NO



"CD DubMode"

## 3 Press the YES button.

The current dubbing mode appears.

YES



"Album+Fade?"

The current dubbing mode is given on the left side (for the display given above, the current dubbing mode is the album mode).

**Album:** Only record the tracks that can be completely recorded. (Album mode)

**Fade:** Fade-out a track if it cannot be completely recorded. (Fade-out mode)

## 4 To change the dubbing mode, press the YES button.

The new dubbing mode is set. To not change the dubbing mode, press the EDIT/NO button.

YES



"FadeMode"

### Notes:

- In the fade mode, only the remaining recording time is displayed.
- When recording to a CD-RW in the album mode, the remaining possible recording time is not displayed.

## CD dubbing (component system operation)

### 5 Press the CD DUBBING button.

A finalization confirmation will automatically appear for 5 seconds.

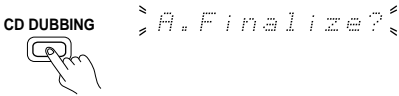

### 6 To automatically finalize the disc after recording, press the YES button within 5 seconds.

CD dubbing begins.



During CD dubbing, the level sync function turns on.

The CD player begins a search for the peak level (may take up to 20 seconds) and the CDR-205X set the optimum recording level to match that peak level (DLA\* Link 2 function).

Then the music CD is digitally recorded from the first track to the last track.

#### When the CD finishes

The CDR-205X automatically stops. (To perform finalization after completion, press the FINALIZE button.) If you pressed the YES button for automatic finalization, then the CDR-205X will stop after finalization.

#### To confirm settings during recording

Press the CD DUBBING button.

#### To stop the recording

Press the ■ button.

#### To cancel auto finalization ("A. FINALIZE") during CD dubbing

Press the FINALIZE button.

#### \* DLA

Digital Rec Level Adjustment

### Single-track CD dubbing

Perform single-track CD dubbing when connected to component system to record the track currently being played (or paused) with the CD player with one touch.

### 1 Play the CD with the CD player.

### 2 Press the CD DUBBING button while the track you want to record is playing.

A finalization confirmation will automatically appear for 5 seconds.

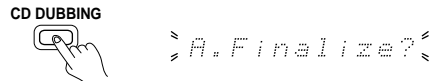

### 3 To automatically finalize the disc after recording, press the YES button within 5 seconds.

CD dubbing begins.



The CD player returns to the beginning of the song and searches for the peak level. The CDR-205X set the optimum recording level to match that peak level. Then recording begins. When the track is completed, the CDR-205X stops and the CD player continues on to the next track.

#### Note:

The dubbing mode is the mode that is currently set; however, if the album mode is set, tracks that cannot be fully recorded will not be erased, but recorded until the disc becomes full.

# Synchronous recording (component system operation)

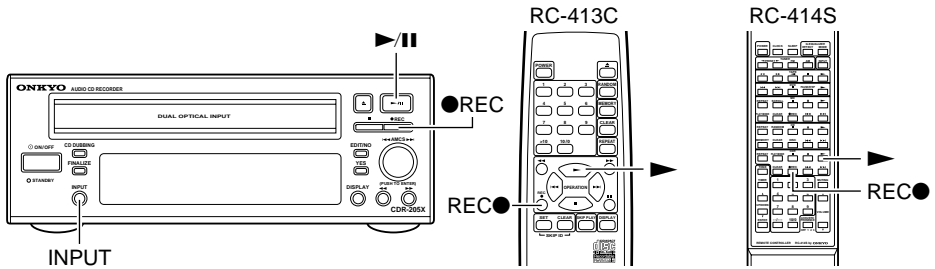

When connected to a component system, the synchronous recording operations given below are possible.

- Synchronous recording from the CD player to the CDR-205X.
- Synchronous recording from the MD recorder or tape deck to the CDR-205X.
- Synchronous recording from the CDR-205X to a MD recorder or tape deck.

## Synchronous recording from a CD player to the CDR-205X

### Preparation

- Turn on the CDR-205X (see page 15).
- Place the music CD in the CD player. (Refer to the instruction manual for the C-707CHX.)
- Place a recordable CD-R or CD-RW in the CDR-205X (see page 16).

### 1 Repeatedly press the INPUT button until "Digital In1" appears.

INPUT



≡ Digital In1 ≡

For analog recording, select "Analog In."

#### Note:

Synchronous recording cannot be performed when "Digital In2" is selected.

### 2 Adjust the recording level (see page 29)

### 3 Press the ● REC button (or the remote controller REC ● button).

"Rec Setup" appears in the display followed by the time display (the recording standby state).

CDR-205X

RC-413C

RC-414S

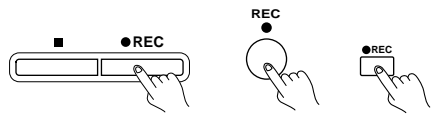

### 4 After the CDR-205X enters the recording standby state, press the ► button at the CD player.

The CD player starts playing and recording starts at the CDR-205X.

≡ Synchrono Rec ≡

### When the CD finishes

The CDR-205X automatically returns to the recording standby state.

### To stop the CD synchronous recording

Stop play at the CD player. The CDR-205X enters the recording standby state.

#### Note:

During analog recording, set the input dial on the amplifier to the CD position and be sure not to change this setting during recording. If this setting is changed, the CDR-205X will automatically enter the recording standby state.

# Synchronous recording (component system operation)

## Synchronous recording from an MD recorder or tape deck to the CDR-205X.

### Preparation

- Turn on the CDR-205X (see page 15).
- Place the MD or cassette in the MD deck or tape deck. (Refer to the instruction manual for the MD-105X or K-505X.)
- Place a recordable CD-R or CD-RW in the CDR-205X (see page 16).

### 1 Repeatedly press the INPUT button until "Analog In" appears.

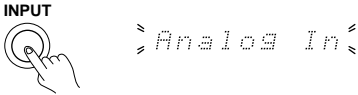

#### Note:

- When recording from an MD recorder or a tape deck, select "Analog In."
- Synchronous recording cannot be performed when "Digital In2" or "Digital In1" is selected.

### 2 Adjust the recording level (see page 29)

### 3 Press the ● REC button (or the remote controller REC ● button).

"Rec Setup" appears in the display followed by the time display (the recording standby state).

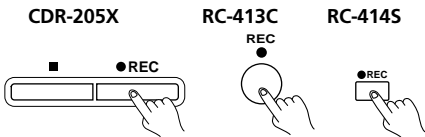

### 4 Press ► button at the MD recorder or tape deck.

The MD recorder or tape deck starts playing and recording starts at the CDR-205X.  
The level sync function turns off.

#### When the MD or tape finishes

The CDR-205X automatically returns to the recording standby state.

#### To stop the synchronous recording

Stop play at the MD or tape deck.

## Synchronous recording from the CDR-205X to an MD recorder or tape deck

### Preparation

- Turn on the CDR-205X (see page 15).
- Place the MD or cassette for recording in the MD deck or tape deck. (Refer to the instruction manual for the MD-105X or K-505X.)
- Place the CD, CD-R or CD-RW to be recorded in the CDR-205X (see page 16).

### 1 Put the MD recorder or tape deck in its recording standby state.

For information on how to operate the MD recorder or tape deck, refer to the instruction manual for the MD-105X or K-505X.

#### K-505X



### 2 Press the ►/|| button (or the remote controller ► button).

The CDR-205X begins playback and the MD or tape deck begins recording.

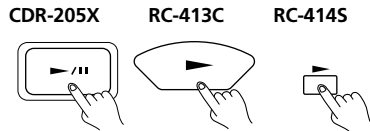

#### When the CDR-205X finishes

The MD or tape deck automatically returns to the recording standby state.

#### To stop the synchronous recording

Stop play at the CDR-205X.

# Analog recording

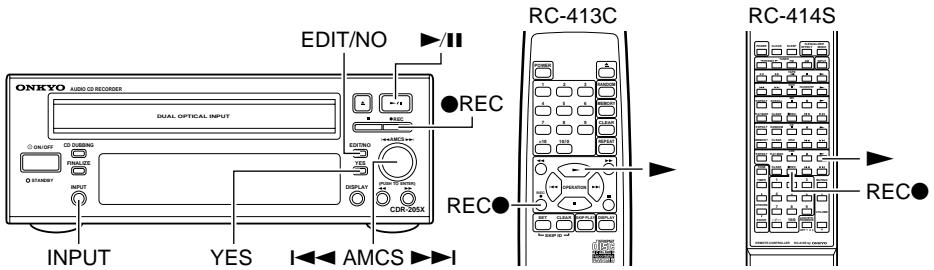

Perform analog recording to record the signal input to the analog input terminal of the CDR-205X. The recording level can be adjusted manually.

## Preparation

- Turn on the CDR-205X (see page 15).
- Place a recordable CD-R or CD-RW in the CDR-205X (see page 16).
- Verify that the input dial and recording selection button of the amplifier are set to the position of the recording source.

### 1 Repeatedly press the INPUT button until "Analog In" appears.



### 2 Adjust the recording level (see page 29)

### 3 Press the ● REC button (or the remote controller REC ● button).

"Rec Setup" appears in the display followed by the time display (the recording standby state).

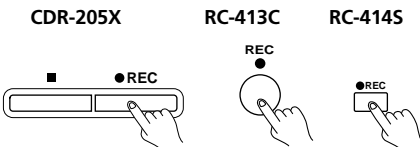

### 4 Press the ►/|| button (or the remote controller ► button) and start the recording source.

Recording starts.  
The level sync function turns off.

If the entire disc becomes filled with recordings, the CDR-205X automatically stops.

### To set the track numbers manually when the level sync function is turned off

Press the ●REC button.

### To pause the recording

Press the ►/|| button (or the remote controller || button). To resume recording, press the ►/|| button (or the remote controller ► button).

### To stop the recording

Press the ■ button.



# Analog recording

## Setting the track numbers automatically

The level sync function is turned off during analog recording. Press the ● REC button (or the remote controller REC ● button) and assign the track numbers automatically.

To have the track numbers assigned automatically by the CDR-205X, turn on the level sync function.

### Note:

The level sync function uses the recording source level to detect the end and beginning of tracks. Therefore, in the cases given below, the track numbers may not be properly assigned.

- The recording on the cassette tape is poor (e.g., the space between songs contains much noise).
- With music such as classical music where there may be very low volumes.
- Where the space between songs is extremely short.
- If the signal at the tuner is weak (excessive noise).
- When recording from turntables.

### To return to manual assignment of the track numbers

Set "Off" at step 2 (see page 27).

## 1 During recording or while in the recording standby state, press the EDIT/NO button repeatedly until "Level Sync?" appears.

(23.m-11)

EDIT/NO



Level Sync?

## 2 Press the YES button.

The current setting appears. The current setting is given on the left side (for the display given below, the current setting is "Off").

YES



Off → On

## 3 Press the YES button.

The level sync function turns on. Press the EDIT/NO button to return to the previous setting.

YES



Lvl Sync On

# Digital recording

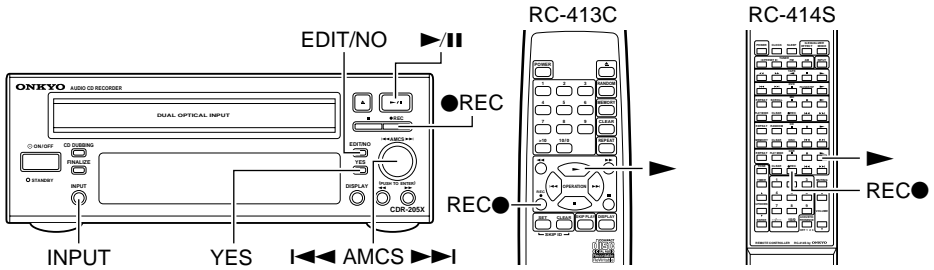

Perform digital recording to record the signal input to the optical digital input terminal of the CDR-205X. The track numbers are recorded as is from the input source. The recording level can be adjusted manually.

## Types of digital source that can be recorded

The CDR-205X contains an internal sampling rate converter, and therefore can record digital signals of the sampling rates given below.

- 44.1 kHz (CDs, etc.)
- 32 kHz (DAT, satellite broadcasts, etc.)
- 48 kHz (DAT, satellite broadcasts, etc.)

### Note:

When performing a digital recording from HDCDs, DTS CDs, and the like, be sure to set the recording level to 0 dB (see page 29). Since the recording level is set automatically (DLA) when dubbing a disc using the CD DUBBING button, recording cannot be performed.

## Preparation

- Turn on the CDR-205X (see page 15).
- Place a recordable CD-R or CD-RW in the CDR-205X (see page 16).
- Verify that the input dial and recording selection button of the amplifier are set to the position of the recording source.

## 1 Repeatedly press the INPUT button until "Digital In1" or "Digital In2" appears.

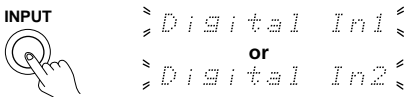

### Note:

Verify to which digital input the optical digital cable is connected. If you select the digital input to which the cable is not connected, "D.In Unlock" will appear.

## 2 Adjust the recording level (see page 29)

## 3 Press the ● REC button (or the remote controller REC ● button).

"Rec setup" appears in the display followed by the time display (the recording standby state).

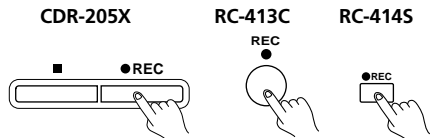

## 4 Press the ►/|| button (or the remote controller ► button) and start the recording source.

Recording starts. The track numbers are automatically recorded as well. If the entire disc becomes filled with recordings, the CDR-205X automatically stops.

## To pause the recording

Press the ►/|| button (or the remote controller || button). To resume recording, press the ►/|| button (or the remote controller ► button).

## To stop the recording

Press the ■ button.

## Notes:

- When digitally recording satellite broadcasts, the track numbers may not be assigned properly. If this occurs, turn off the level sync function and set the track numbers manually.
- If the time between tracks is extremely short, the track numbers may not be assigned properly.

# Digital recording

## Setting the track numbers manually (For more information regarding the level sync function, refer to page 19.)

During digital recording, the level sync function is turned on so the track numbers are assigned automatically.

To assign the track numbers manually, turn off the level sync function.

- 1 During recording or while in the recording standby state, press the EDIT/NO button repeatedly until "Level Sync?" appears.**

EDIT/NO



Level Sync?

- 2 Press the YES button.**

The current setting appears.

The current setting is given on the left side (for the display given below, the current setting is "On").

YES



On+Off

- 3 Press the YES button.**

The level sync function is turned off. Press the EDIT/NO button to return to the previous setting.

YES



LvlSyncOff

Press the ● REC button (or the remote controller REC ● button) to assign the track numbers manually.

### To return to automatic assignment of the track numbers

Set "On" (see page 25).

# Synchronous recording by input digital signal detection

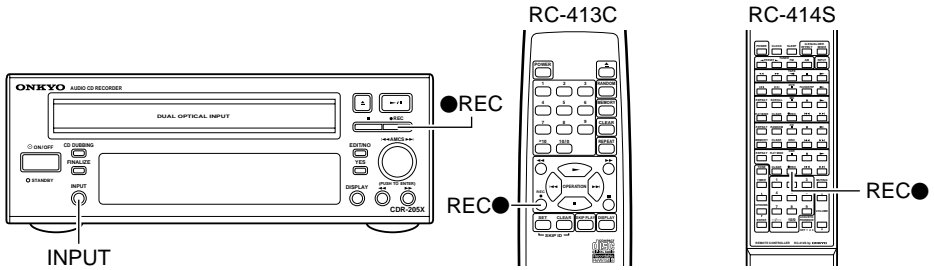

When recording with portable MD players, or other components that are not equipped with an **RI** connector, recording is started synchronous with the input signal. (This is called digital signal synchronous recording.)

## Preparation

- Turn on the CDR-205X (see page 15).
- Place a recordable CD-R or CD-RW in the CDR-205X (see page 16).
- Verify that the input dial and recording selection button of the amplifier are set to the position of the recording source.

## 1 Repeatedly press the INPUT button and select the desired input signal.

Select "Digital In1" either "Digital In2" for the input source.



## 2 Adjust the recording level (see page 29)

## 3 Press the ● REC button (or the remote controller REC ● button)

"Rec Setup" appears in the display followed by the time display.

## 4 Press the ● REC button (or the remote controller REC ● button)

The CDR-205X enters the input standby state, "Signal Rec" appears in the display, and then "Signal Wait" appears flashing.

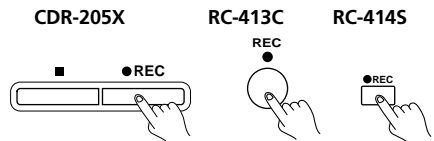

≡ Signal Rec ≡  
↓  
≡ Signal Wait ≡

## Notes:

- If "Check Input" and "Rec Setup" flash alternately and recording does not start, then the recording source was likely already playing and not allowing recording to start. First stop the recording source and then resume operations.
- CD DUBBING uses a sub-code signal that is contained in the digital output from most player components, and therefore there may be some CD players, MD recorders, or the like where digital synchronous recording is impossible.

## 5 Verify that "Signal Wait" is flashing in the display and then start the playback of the recording source.

Recording starts as soon as the unit receives signals from the recording source.  
Level Sync automatically set to On.

# Adjusting the recording level

## Adjusting the recording level for digital recording

You may need to adjust the recording level when recording low digital signal sources such as satellite broadcasts and the like.

### 1 Verify that "Monitor" is displayed in the front display.

If "Monitor" is not displayed, press the INPUT button to display it.

### 2 Press the EDIT/NO button.



### 3 Press the YES button.

If you will not adjust the recording level, press the EDIT/NO button again.

### 4 Using the AMCS dial, adjust the recording level as desired.

The recording level can be adjusted between  $-\infty$  and +12 decibels.

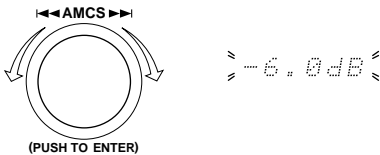

Adjust so that when the recording level is at its highest, it reaches to a level between -6 to -2 decibels in the front display.

Adjust to between this level.



Even if you change the recording level, the monitor sound level from the DIGITAL OUT terminal will not change.

### 5 After adjusting the recording level, press the YES button.

The new recording level is set.

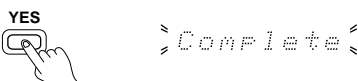

## Adjusting the recording level for analog recording

### 1 Verify that "Monitor" is displayed in the front display.

If "Monitor" is not displayed, press the INPUT button to display it.

### 2 Press the EDIT/NO button.



### 3 Press the YES button.

If you will not adjust the recording level, press the EDIT/NO button again.

### 4 Using the AMCS dial, adjust the recording level as desired.

The recording level can be adjusted between  $-\infty$  and +18 decibels.

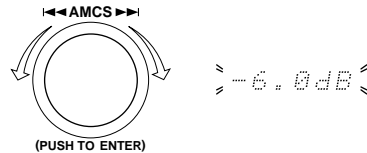

Adjust so that when the recording level is at its highest, it does not reach "OVER" in the front display. If OVER is reached, the sound becomes distorted.

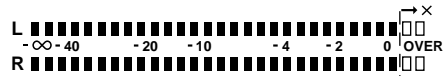

### 5 After adjusting the recording level, press the YES button.

The new recording level is set.

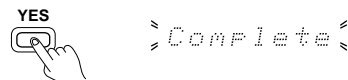

# Placing and removing SKIP commands

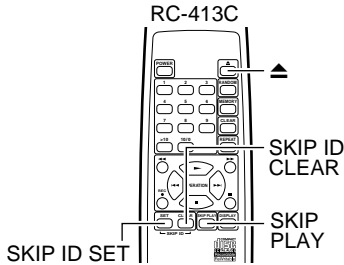

## Placing and removing SKIP commands

If you make a mistake during recording, recording only silence, or have recorded some other track which you do not want to have played when the disc is played back, you can place a SKIP command at the place of that track. Then, when that disc is played, that track will be automatically skipped. (This procedure can only be performed with the remote controller.) Up to 21 SKIP commands can be placed on one disc.

### Notes:

- If you repeatedly place and remove SKIP commands, you may reduce the actual number of SKIP commands that can be placed.
- You cannot place SKIP commands on purchased music CDs or finalized CD-Rs or CD-RWs.
- SKIP commands only operate with CD players equipped with SKIP function operability.

## Placing a SKIP command

### 1 Play the track that where you want to place the SKIP command.

#### Memo:

When a track is played that already has a SKIP command, the SKIP indicator will light.



### 2 Press the SKIP ID SET button.

The track is played again. The track number and the message "Skip Set?" flash alternately in the display.

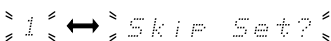
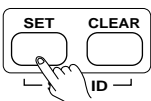

#### Memo:

By pressing **I◀◀** or **▶▶I** (or turning the AMCS dial), you can jump to tracks before or after that do not have a SKIP command.

### 3 Press the SKIP ID SET button again.

The SKIP command is placed.

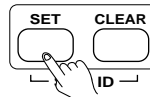

### 4 To place a SKIP command on another track, repeat steps 1 to 3.

When no more SKIP commands can be placed, "Skip Full" will appear in the display.

### 5 Press the **▲** button.

After the SKIP command is recorded on the disc (a few seconds), the disc tray opens.



#### To stop the placement of a SKIP command

Press the **■** or SKIP ID CLEAR button.

# Placing and removing SKIP commands

## Removing a SKIP command

**1** Insert the CD-R or CD-RW with the SKIP command into the CDR-205X.

**2** Press the SKIP PLAY button.

The SKIP ON indicator turns off.



**3** Play the track where you want to remove the SKIP command.

### Memo:

When a track is played that already has a SKIP command, the SKIP indicator will light.

≡ SKIP ≡

**4** Press the SKIP ID CLEAR button.

The track is played again. The track number and the message "Skip Clear?" flash alternately in the display.

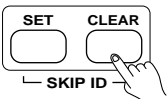

≡ 1 ≡ ↔ ≡ Skip Clear? ≡

### Memo:

By pressing ◀◀◀ or ▶▶▶ (or turning the AMCS dial), you can jump to tracks before or after that have a SKIP command.

### Note:

If the SKIP ID CLEAR button is pressed while a track without a SKIP command is being played, then the CDR-205X will search for the next track with a SKIP command.

**5** Press the SKIP ID CLEAR button again.

The SKIP command is removed.

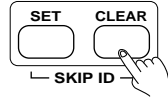

**6** To remove a SKIP command from another track, repeat steps 3 to 5.

**7** Press the ▲ button.

After the SKIP command is removed from the disc (a few seconds), the disc tray opens.



### To stop the removal of a SKIP command

Press the ■ or SKIP ID SET button.

# Finalization

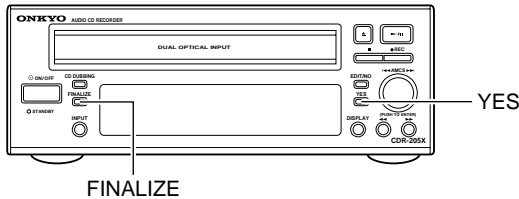

The finalization process writes the TOC data (tracks, etc.) for the disc in a special area on the disc called the PMA.

## After finalization

CD-Rs can be played in CD players. Even after finalization, CD-RWs can only be played on CD players that are compatible with CD-RWs. For finalized CD-Rs, you cannot add more recordings, place SKIP commands, or remove SKIP commands.

## When finalization finishes

The CDR-205X automatically stops.

## To stop the finalization process

Press the  button (before pressing the YES button in step 3).

## Display after finalization

For CD-Rs, the display becomes that for CDs. For CD-RWs, the display does not change, except that FINALIZE is added.

## 1 Insert the CD-R or CD-RW to be finalized into the CDR-205X.

## 2 Press the FINALIZE button.

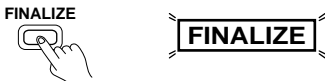

### Memo:

If the CDR-205X is left in the finalize standby state for more than 10 minutes, then it will automatically exit the state and return to normal operation.

## 3 After the time information appears, press the YES button.



Finalization begins. During finalization, the remaining time is displayed. (Finalization takes approx. 4 minutes.)

### Notes:

- **Never turn off the power or remove the power cord during finalization. Doing so may damage all the data on the disc.** If the power is turned off by mistake or if a power outage occurs, the remaining operations will resume when power is turned back on. However, there are times when the operations are not properly resumed and the disc is not restored.
- Never finalize discs that are scratched, dirty, or dusty. Doing so may prevent the process from being properly completed. If the process does not finish in 10 minutes, press the  button and abort the process. This disc will not be able to be played with normal CD players.
- During finalization, the operation button on the CDR-205X will be disabled.



# Erasing recordings (CD-RW discs only)

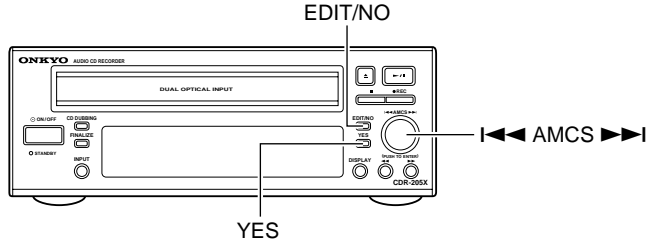

The data recorded on CD-RW discs can be erased and the disc can be used again as many times as desired. The erasing methods are given below.

## ■ Erasing data on unfinalized CD-RWs

**Last track erase:** Erases only the last track.

**Multi-track erase:** Erases all tracks from the selected track to the final track.

**All track erase:** Erases all tracks.

## ■ Erasing data on finalized CD-RWs

**All track erase:** Erases all tracks.

**TOC erase:** Returns a finalized disc to the unfinalized condition.

## ■ Erasing discs

Erases all data recorded on the CD-RW.

### Notes:

- If the power is turned off by mistake during an erase, then immediately turn the power back on. The process will be automatically resume.
- If "Disc Error" appears during an erase, the abort the erase and check the disc for scratches, dirt, or dust. After removing any dirt or dust that may exist, resume the erase.
- After performing an erase, always remove the disc before turning off the power. If the disc is left inside when the power is turned off, there is a chance the erase may be left uncompleted.

## Erasing from a non-finalized CD-RW

### 1 Insert the CD-RW to be erased.



### 2 Repeatedly press the EDIT/NO button until "Erase?" appears.



"Erase?"

### 3 Press the YES button.

The erasing method appears.



"Last Track?"

## Erasing recordings (CD-RW discs only)

- Turn the AMCS dial and select the erasing method.

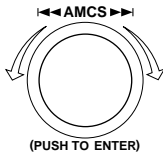

**Last Track?:** Erases only the last track.

**All Track?:** Erases all tracks.

**xx-yy?:** Erases all tracks from "xx" to "yy," where "xx" is the track you select with the AMCS dial and "yy" is the final track on the disc.

- Press the YES button (or AMCS dial).

Erasing begins.



### Erasing from a finalized CD-RW

- Insert the CD-RW to be erased.
- Repeatedly press the EDIT/NO button until "Erase?" appears.

EDIT/NO



"Erase?"

- Press the YES button.

The erasing method appears.

YES



"Toc Erase?"

- Turn the AMCS dial and select the erasing method.

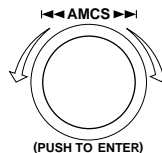

**Toc Erase ?:** Returns a finalized disc to the unfinalized condition.

**All Track ?:** Erases all tracks.

- Press the YES button.

Erasing begins. The time remaining for the erase appears.

YES



### Stopping an erase

Press the ■ button for approx. 10 seconds.

The recording will not properly be erased, so be sure to perform an erase of the entire disc (see page 35).

# Erasing recordings (CD-RW discs only)

## Erasing entire disc

**1** Insert the CD-RW to be erased.

**2** Repeatedly press the EDIT/NO button until "Erase?" appears.

EDIT/NO



» Erase? «

**3** Press the YES button for more than 4 seconds.

A display confirming the erase appears.

YES



» All « → » Disc « → » Erase? «  
» Erase? 79m30s «

If this display continues for more than four minutes, it is automatically exited.

**4** Press the YES button.

Erasing begins. The time remaining for the erase appears.

This process requires an amount of time equal to the total recording time of the disc plus an additional 5 minutes.

YES



### Stopping an erase

Press the ■ button for approx. 10 seconds. The recording will not properly be erased, so be sure to perform the erase again.

# Playing CDs

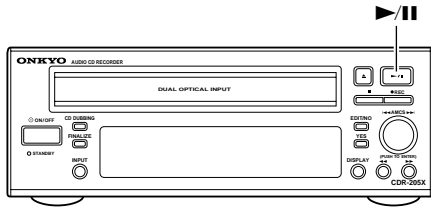

The CDR-205X is capable of four different styles of playback.

- Normal playback
- Random playback
- Repeat playback
- Programmed playback

## Preparation

- Turn on the CDR-205X (see page 15).
- Place the CD or recorded CD-R or CD-RW in the CDR-205X (see page 16).

## Normal playback

### Press the ►/|| button.

Playback starts at track 1.

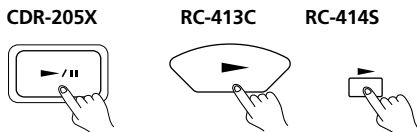

### To pause playback

Press the ►/|| button (or the remote controller || button). To resume playback, press the ►/|| button (or the remote controller ► button).

If a disc is left in pause for more than 10 minutes, it is automatically stopped and returned to the beginning.

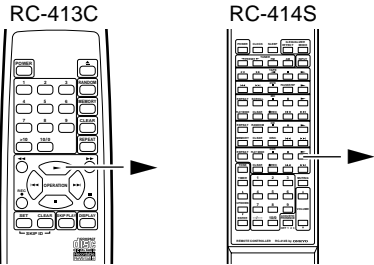

### To stop playback

Press the ■ button.

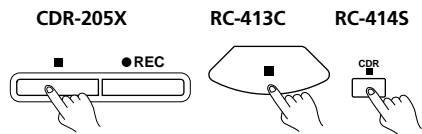

### To skip to specific track

Turn the AMCS dial to the left or right and select the desired track. With the remote controller, press the ◀◀ or ▶▶ buttons.

◀◀: Press once to skip to the beginning of the track currently being played. Press twice in succession to skip to the beginning of the previous track.

▶▶: Press once to skip to the beginning of the next track.

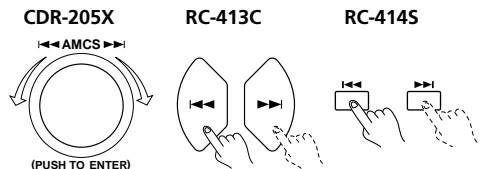

### To fast forward or rewind (search)

Press the ◀◀ or ▶▶ buttons.

◀◀: Press for rewind.

▶▶: Press for fast forward.

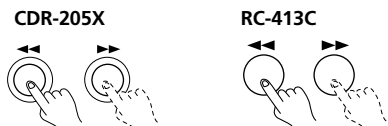

### To play a specific track

Press the number of the desired track with the numerical buttons on the remote controller to start playback from that specific track (see page 38).

# Playing CDs

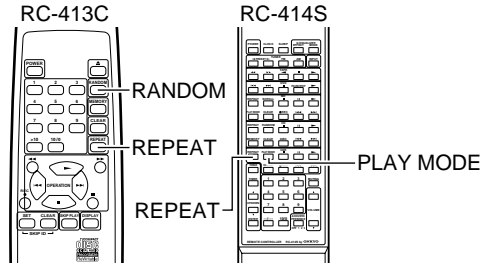

## Random playback

### With playback stopped, press the **RANDOM** button

With the RC-414S remote controller, repeatedly press the PLAY MODE button to select the random mode. The random playback mode plays all the tracks on the disc in random order. The RANDOM indicator lights.

RC-413C



RC-414S

PLAY MODE



## Repeat playback

### Press the **REPEAT** button as many times as desired

Each time the REPEAT button is pressed, the display changes between "REPEAT 1" and "REPEAT." Selecting "REPEAT 1" only repeats only the track currently being played. Selecting "REPEAT" repeats all tracks.

RC-413C

REPEAT



RC-414S

REPEAT



### To stop the random playback mode

With playback stopped, press the RANDOM button.

#### Note:

While in the random playback mode, the numerical buttons, AMCS dial, I◀◀ button, and ▶▶I button do not operate.

### To stop repeat playback

Repeatedly press the REPEAT button until "REPEAT" is no longer displayed, or press the ■ button.

#### Memo:

- You can press the REPEAT button during random playback to repeatedly playback all tracks in random order.
- You can press the REPEAT button during programmed playback to repeatedly playback the track currently being played or the track programmed.

# Playing CDs

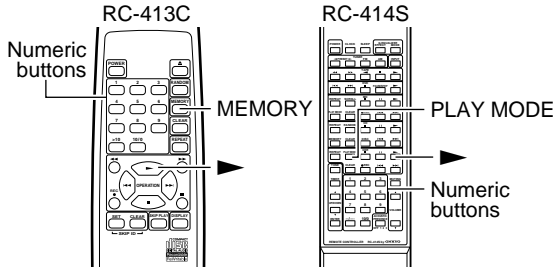

## Programmed playback

Programmed playback allows you to select only the tracks that you want to play and in which order that you them to be played. Up to 30 tracks can be programmed at one time.

### 1 With playback stopped, pressed the MEMORY button.

With the RC-414S remote controller, repeatedly press the PLAY MODE button to select the programmed mode. The MEMORY indicator lights. "Track=?" appears.

RC-413C



RC-414S



### 2 Press the numeric buttons for the tracks that you want to hear in the order that you want to hear them.

**To select track numbers of 11 or greater (up to 99)**

**RC-413C:** Press the [ $>10$ ] button, then the numeric button corresponding to the 10's digit for the track number, and then the numeric button corresponding to the 1's digit.

Example: Track number 35: [ $>10$ ] + [3] + [5]

**RC-414S:** Press the [ $--/--$ ] button and then press the numeric button corresponding to the 10's digit for the track number, and then the numeric button corresponding to the 1's digit.

Example: Track number 35: [ $--/--$ ] + [3] + [5]

**To verify the programmed track numbers.**

Press the  $\blacktriangleright\blacktriangleright$  button.

### Memo:

You can also turn the AMCS dial to select tracks and press the dial to enter them.

### 3 Press the $\blacktriangleright$ button.

Playback starts to the order programmed.

RC-413C

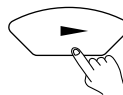

RC-414S



### To stop programmed playback

Press the  $\blacksquare$  button.

### To stop the programmed playback mode

With playback stopped, press the MEMORY button.

### To clear the programmed tracks

With playback stopped, press the CLEAR or  $\blacksquare$  button. Each time a button is pressed, the last track is cleared.

### To change the programmed tracks

Press the  $\blacktriangleright\blacktriangleright$  button and display the track to be changed. Turn the AMCS dial to the track that you want to program. Then, press the DISPLAY to return to the original display.

### Searching during programmed playback

You can search during playback through only the tracks that you have programmed. When you reach the end of the track that is currently playing, playback is paused before you go on to the next track. To stop the pause, press the  $\blacktriangleright$  button,  $\blacksquare\blacksquare$  button, or  $\blacktriangleleft\blacktriangleleft$  button.

# Skipping a track (using the SKIP command)

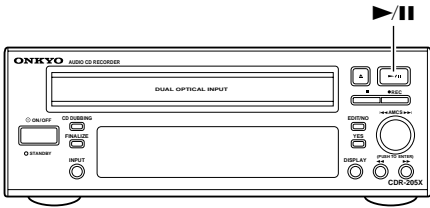

RC-413C

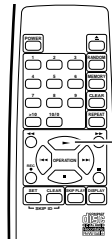

RC-414S

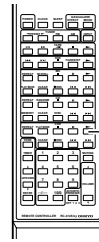

You can set the CDR-205X to skip tracks that have a SKIP command (see page 30).

## To play tracks where SKIP commands are placed

With playback stopped, press the SKIP PLAY button. The SKIP ON indicator turns off. Then start playback.

### 1 Insert a disc with SKIP commands recorded into the CDR-205X.

If a disc with SKIP commands is inserted into the CDR-205X, the SKIP ON indicator will light.



#### Note:

SKIP commands only work with CD players that support the SKIP function.

### 2 Press the ►/|| button (or the remote controller ► button).

The disc is played skipping the tracks where SKIP commands have been placed.

CDR-205X

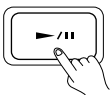

RC-413C

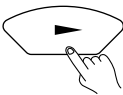

RC-414S



# Timer playback (component system operation)

---

When connected to the R-805X component, playback using the timer is possible. For more information on how to set the timer, refer to the instruction manuals with the R-805X.

---

**1** Insert a disc for playback.

---

**2** Set the timer for the R-805X.

**Note:**

For timer playback, the CDR-205X must have its power constantly turned on.



# Other Information

## Display messages

Message	Explanation	Pages
Open	Disc tray is opening.	16
Welcome	Disc tray is closing.	16
Rec Setup	Setting initial settings for recording. Please wait.	22
Disc Reading	Recognizing disc. Please wait.	16
TOC Reading	Reading the table of contents recorded on the disc. Please wait.	16
Monitor	Monitoring the input source selected by the INPUT button.	29
PMA Writing	Recording TOC data to the disc PMA (Program Memory Area). Never turn off the power while this message is displayed.	18
Track= ?	Select the track to program with the numeric buttons, AMCS dial, or ◀◀ and ▶▶ buttons.	38
Skip Set?	Select the track where the SKIP command is to be placed. To place the SKIP command, press the SKIP ID SET button.	30
Skip Clear?	Select the track where the SKIP command is to be removed. To remove the SKIP command, press the SKIP ID CLEAR button.	31
Last Track?	Erasing the last track. To erase the last track, press the YES button or the AMCS dial.	34
All Track?	Erasing all tracks. To erase all track, press the YES button or the AMCS dial.	34
TOC Erase?	Erasing the TOC from a finalized disc to return it to the unfinalized condition. To erase the TOC, press the YES button or the AMCS dial.	34
* - *?	Erasing from track selected to last track. To erase, press the YES button or the AMCS dial.	34
All → Disc → Erase ? → Ers ? **:**	Erase all data from disc. To erase all data, press the YES button or the AMCS dial.	35

If during operation a malfunction occurs or an improper operation is performed, the corresponding message will appear. For a description of these messages, refer to the explanations on the following pages.

# Troubleshooting guide

---

If the CDR-205X begins to operate improperly, use the troubleshooting guide below to help you ascertain the problem.

Because the unit contains a microcomputer to provide advanced functions, it may malfunction due to external noise or static electricity. If this happens, disconnect the power cord and then plug it in again after about 5 seconds.

## About the self-diagnosis function

The CDR-205X is equipped with a self-diagnosis function. If a malfunction is detected during operation, one of the messages given below will appear in the front display.

Display	Cause	Remedy
Disc Error	<ul style="list-style-type: none"><li>• Playback was likely stopped due to dirt, dust, scratches, or vibrations.</li><li>• The disc has been placed in upside down.</li></ul>	<ul style="list-style-type: none"><li>• Eject the disc and check for dirt, dust, and scratches (see page 16).</li><li>• Eject the disc and check that it is placed in correctly (see page 16).</li></ul> <p>If you place the disc correctly and the same message appears, unplug the power cord and plug it back in again. If the same message appears again, contact an Onkyo service representative.</p>
Sys. Error (flashing)	A malfunction has occurred in the system due to excessive noise or static electricity.	Unplug the power cord and plug it back in again. If the same message appears again, contact an Onkyo service representative.

## Messages during recording

Display	Cause	Remedy
Cannot Copy	The input digital signal contains a copy guard signal (SCMS).	Record an analog signal or recordable music signal (see page 48).
Cannot Rec	<ul style="list-style-type: none"><li>• The digital input is blocked.</li><li>• Data has been input in the CD-ROM, etc.</li></ul>	<ul style="list-style-type: none"><li>• Verify that the player component is properly playing and the digital cable is properly connected. (see page 12).</li><li>• Verify that source signal is a normal music signal (see page 18).</li></ul>
Check Input ↓ ↑ Rec Setup	The player component was already playing.	Stop the player component. Shortly thereafter, "Signal Wait" will appear (see page 28).
Rec Setup	The CDR-205X is entering the recording standby state.	Wait until the message disappears.

# Troubleshooting guide

## Messages during recording (continued)

Display	Cause	Remedy
Repair	After recording, the disc was left in the CDR-205X when the power was turned off and the track numbers and recording time data was lost.	While "Repair" is displayed, the CDR-205X is tracing back through the recorded area and repairing the track numbers and recording time data. When the message disappears, finalization of the disc is possible. Depending on the recording amount, this process may take up to 40 minutes.recording time data was lost.
Disc Full	Either the disc is full of recordings or 99 tracks have been recorded and no more recordings can be made on the disc.	Use a new disc.
Pro Disc	A CD-R not for music recording use (without the "FOR CONSUMER" marking) or a CD-RW has been inserted.	Eject the disc and check whether it meets the specifications for use with the CDR-205X. Always insert a disc that has the markings "FOR CONSUMER" or "FOR MUSIC USE ONLY" on its surface (see page 10).

## Messages during playback

Display	Cause	Remedy
Blank Disc	You have tried to play a disc that has no recordings on it.	If the inserted disc is a CD-R or CD-RW with no recordings, you may record onto it, but it cannot be played.
No Disc	No disc has been inserted.	Open the disc tray and make sure that a disc is inserted (see page 16).
Now Setting	The CDR-205X is warming up.	Please wait.
Recovering	This is displayed after the power has been or if the power is accidentally turned off during a recording, the CDR-205X will enter this mode to repair the disc for additional recordings.	Wait until the message disappears (see page 18).
Over	You reached the end of the disc by pressing the search button during playback or while the CDR-205X was paused.	

# Troubleshooting guide

<b>Trouble</b>	<b>Cause</b>	<b>Remedy</b>
The power does not turn on	The power cord is not properly plugged in.	Plug the power cord properly into a mains power supply.
	The component where the power cord is plugged into is not turned on.	Turn on the component into which the power cord is plugged.
No sound is output from the speakers	The speakers are not properly connected.	Connect the speakers following the procedure given in "Connecting the CDR-205X" on page 12.
Cannot record	The components are not properly connected.	Connect the components following the procedure given in "Connecting the CDR-205X" on page 12.
	A finalized CD-R or CD-RW is being used.	Use an unfinalized disc (see page 32).
	The input switch is not properly set.	Switch to a properly connected input source (see page 20, 22, 24, 26, 28).
	The recording level adjustment is set too low.	Adjust the recording level to a proper level (see page 29).
Recorded sound is distorted	The components are not properly connected.	Connect the components following the procedure given in "Connecting the CDR-205X" on page 12.
	Recording is being affected by the television.	Either turn off the television or move the CDR-205X away from the television.
	The disc is damaged or cracked.	Use another disc.
	The recording level adjustment is set too high.	Adjust the recording level to a proper level (see page 29).
	The disc is too dirty.	Clean the disc.
Remote controller does not work	The remote controller batteries are dead.	Replace all the remote controller batteries with new batteries (see page 8-9).
	There is an object between the CDR-205X and the remote controller obstructing the signals.	Remove the obstructing object (see page 8-9).
	The remote controller is being used outside of its operational range.	Use the remote controller within its operational range (see page 8-9).
A track is skipped during playback	The skip play mode is turned on.	Using the SKIP PLAY button, turn off the skip play mode (see page 39).
A track is not properly skipped.	The skip play mode is turned off.	Using the SKIP PLAY button, turn on the skip play mode (see page 39).
A recorded CD-R cannot be played in normal CD players	<ul style="list-style-type: none"> <li>The disc was not finalized after recording.</li> <li>The CD-R indicator lights when the disc is played with the CDR-205X</li> </ul>	<ul style="list-style-type: none"> <li>Perform the finalization process (see page 32).</li> </ul>

# Part names and functions

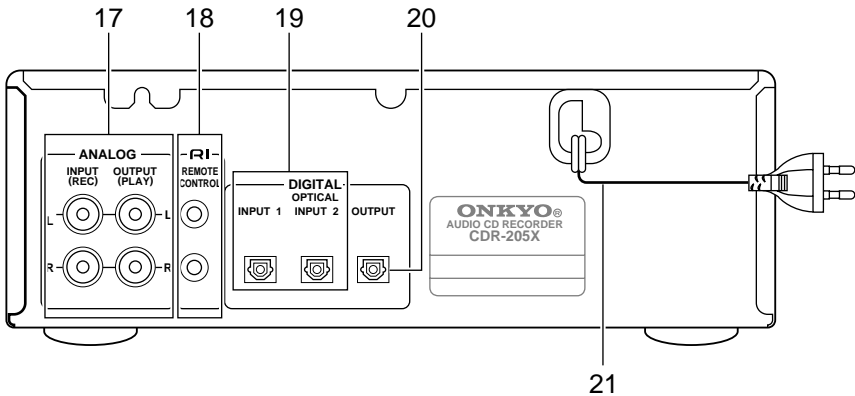
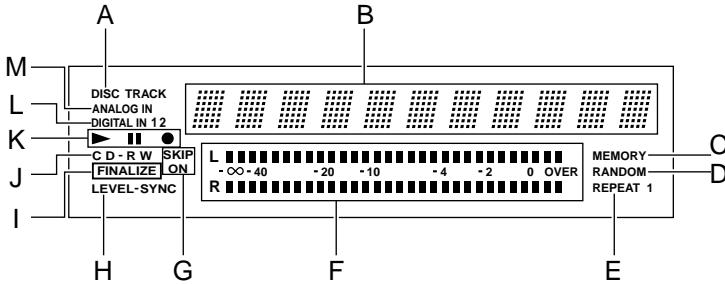
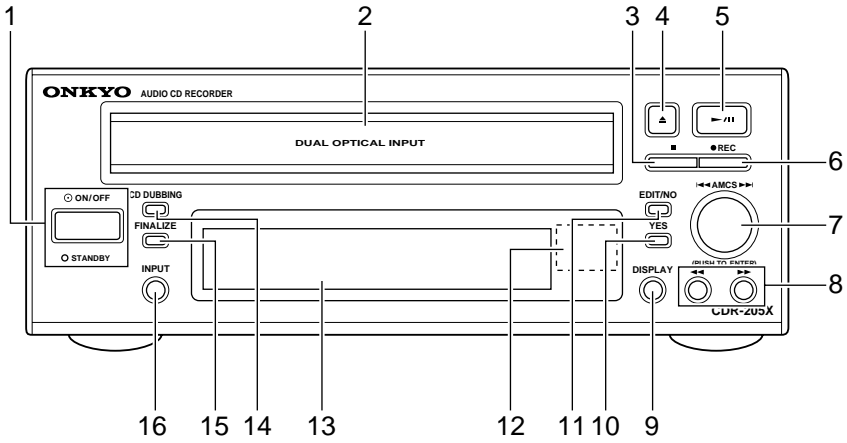

## Part names and functions

The numbers within the brackets is the page number where the part is introduced.

### Front panel

- 1 ON/OFF switch and STANDBY indicator [15]**  
Press in to turn the power on, and release out to turn the power off. If the power is turned off by the remote control or by another system component, the CDR-205X enters the standby state and the STANDBY indicator lights.
- 2 Disc tray [16]**
- 3 ■ (stop) button [36]**  
Press to stop recording or playback. Press while playback or recording is stopped to erase the programmed playback memory.
- 4 ▲ (tray open/close) button [16]**  
Press to open and close the disc tray.
- 5 ►/|| (play/pause) button [36]**  
Press to start analog recording, digital recording, and playback. Press during playback to pause the playback. Press again to resume playback.
- 6 ● REC (recording) button [22]**  
For analog and digital recording, press to place the CDR-205X in the recording standby state.
- 7 I◀◀ AMCS ▶▶I dial [36]**  
Use to jump to tracks prior to or later than the one currently playing. Use while playback is stopped to select the track to play.
- 8 ◀◀/▶▶ (rewind/fast forward) buttons [36]**  
Press to rewind or fast forward through the track currently playing.
- 9 DISPLAY button [17]**  
Press to change the contents of the display.
- 10 YES button [20]**  
Press to finalize settings and confirm display messages during CD dubbing and other operations.

**11 EDIT/NO button [20]**

Press repeatedly to select the operations for CD dubbing, erasing, and other operations. Press while making settings to cancel displayed messages.

**12 Remote control sensor [9]****13 Front display**

- A DISC/TRACK indicator
- B Display
- C MEMORY (programmed playback) indicator
- D RANDOM (random playback) indicator
- E REPEAT (repeat playback) indicator
- F Recording level display
- G SKIP ON (skip play mode) indicator
- H LEVEL-SYNC indicator
- I FINALIZE indicator
- J CD/CD-R/CD-RW indicator
- K ► (play) / || (pause) / ● (recording) indicator
- L DIGITAL IN 1/2 indicator
- M ANALOG IN indicator

**14 CD DUBBING button [20]**

Press to start CD dubbing.

**15 FINALIZE button [32]**

Press to finalize discs onto which you have finished recording.

**16 INPUT button [20]**

Press to select the input source.

### Rear panel

**17 ANALOG INPUT (REC)/OUTPUT (PLAY) terminals [12]****18 RI REMOTE CONTROL terminals [12]****19 DIGITAL OPTICAL INPUT 1/2 terminals [12]****20 DIGITAL OPTICAL OUTPUT terminal [12]****21 Power cord [12]**

## Part names and functions

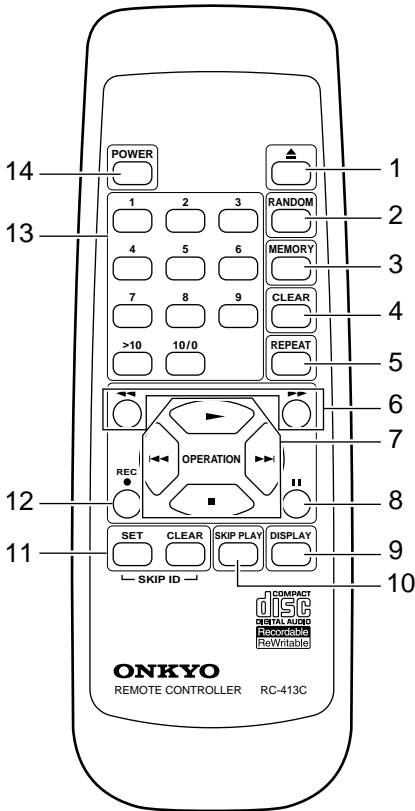

The numbers within the brackets is the page number where the part is introduced.

### RC-413C remote controller

- 1** **▲ (tray open/close) button [16]**  
Press to open and close the disc tray.
- 2** **RANDOM (random playback) button [37]**  
Press to playback the tracks on the disc in random order.
- 3** **MEMORY (programmed playback) button [38]**  
Press to program the tracks to play in memory.
- 4** **CLEAR (clear program memory) button [38]**  
Press to erase the programmed tracks one at a time from the end.
- 5** **REPEAT (repeat playback) button [37]**  
Press to repeat the playback of a disc or a track.
- 6** **◀◀/▶▶ (rewind/fast forward) buttons [36]**  
Press to rewind or fast forward through the track currently playing. Press to move the cursor forward or backward when changing the name of a disc.
- 7** **OPERATION button**  
**■ (stop) button [36]**  
Press to stop recording or playback. Press while playback or recording is stopped to erase the programmed playback memory.  
**▶ (play) button [36]**  
Press to start analog recording, digital recording, and playback.
- 8** **◀◀/▶▶ (skip) buttons [36]**  
Use to jump to tracks prior to or later than the one currently playing. Use while playback is stopped to select the track to play.
- 9** **■ (pause) button [36]**  
Press during playback to pause the playback. Press ▶ button to resume playback.
- 9** **DISPLAY button [17]**  
Press to change the contents of the display.
- 10** **SKIP PLAY (skip play mode) button [31, 39]**  
Press to turn the skip play mode on or off for discs that contain SKIP commands.
- 11** **SKIP ID SET/CLEAR button [30, 31]**  
Press to place and remove SKIP commands.
- 12** **● REC (recording) button [22]**  
For analog and digital recording, press to place the CDR-205X in the recording standby state.
- 13** **Numeric buttons [38]**  
Press the number for a track to start playback at that track. Also, press to program tracks for programmed playback.
- 14** **POWER button [15]**  
While the ON/OFF switch at the CDR-205X is pressed in, press to switch the CDR-205X between the on state and the standby state.

For the part names and functions of the RC-414S remote controller, refer to the instruction manual with the R-805X.

# Rules concerning digital recording

---

## Guide to the serial copy management system

You cannot use digital recording to create a second-generation copy, a copy of a copy created through digital recording, with a CD-R or CD-RW. This is because the unit conforms to the Serial Copy Management System and permits only one generation of digital-to-digital copying (the recording of the original digital signals as they are). The Serial Copy Management System is based on the following three rules.

### Principle 1

Digital-to-digital copying can be used to create a copy of a CompactDisc (CD), Digital Audio Tape (DAT), MiniDisk (MD), etc. with a CD-R or CD-RW. However, digital-to-digital copying is not allowed to create a copy of a CD-R or CD-RW that has been created through digital-to-digital copying.

### Principle 2

Digital-to-digital copying can be used to create a copy of a CD-R or CD-RW that contains the songs from analog records, FM radio programs, etc. you recorded using the unit. However, digital-to-digital copying is not allowed to create a copy of a CD-R or CD-RW that has been created through digital-to-digital copying. When two CD recorders are connected via the analog input and output terminals, however, recording can be performed beyond this restriction.

### Principle 3

With a DAT deck or a CD recorder that supports the sampling frequencies of 32 kHz and 48 kHz, digital-to-digital copying can be used to record the digital sound from satellite broadcast. (This CD recorder supports these sampling frequencies.) In this case, digital-to-digital copying is allowed to create a second-generation copy. However, with some BS tuners, second-generation copy may not be produced.

- \* When CD recorders are connected using analog terminals, the number of dubbings is not limited.



# Specifications

---

<b>System</b>	Compact disc recorder
<b>Recording/playing time</b>	Max. 80 min (Approx., when using an 80-min disc)
<b>D/A converter</b>	Single-bit
<b>Digital filter</b>	8 times oversampling
<b>Connections</b>	1 analog output, 1 analog input 2 digital input (optical), 1 digital output (optical)
<b>Frequency response</b>	5 Hz to 20 kHz
<b>Playback total harmonic distortion</b>	0.004% (1kHz)
<b>Playback dynamic range</b>	98 dB
<b>Playback signal-to-noise ratio</b>	98 dB
<b>Recording total harmonic distortion</b>	0.006% (1kHz)
<b>Recording dynamic range</b>	92 dB
<b>Recording signal-to-noise ratio</b>	94 dB
<b>Channel separation</b>	90 dB (during playback)
<b>Wow and flutter</b>	Below threshold of measurability
<b>Output level</b>	2.0 V r.m.s. (analog)
<b>Power supply</b>	AC 230 V, 50 Hz, AC 120 V, 60 Hz
<b>External dimensions</b>	205 (W) x 76 (H) x 303 (D) mm
<b>Weight</b>	2.9 kg

Specifications and features are subject to change without notice.

# Memo

---



# **ONKYO CORPORATION**

Sales & Product Planning Div.:2-1, Nisshin-cho, Neyagawa-shi, OSAKA 572-8540, JAPAN  
Tel: 072-831-8111 Fax: 072-833-5222 <http://www.onkyo-intl.com>

## **ONKYO U.S.A. CORPORATION**

18 Park Way, Upper Saddle River, N.J. 07458, U.S.A.  
Tel: 201-785-2600 Fax: 201-785-2650 <http://www.onkyousa.com>

## **ONKYO EUROPE ELECTRONICS GmbH**

Liegnitzerstrasse 6, 82194 Groebenzell, GERMANY  
Tel: +49-8142-4401-0 Fax: +49-8142-4401-555 <http://www.onkyo.net>

## **ONKYO CHINA LIMITED**

Units 2102-2107, Metroplaza Tower I, 223 Hing Fong Road, Kwai Chung,  
N.T., HONG KONG Tel: 852-2429-3118 Fax: 852-2428-9039



SN29342869

Printed in Japan  
D0003-1



## Free Manuals Download Website

<http://myh66.com>

<http://usermanuals.us>

<http://www.somanuals.com>

<http://www.4manuals.cc>

<http://www.manual-lib.com>

<http://www.404manual.com>

<http://www.luxmanual.com>

<http://aubethermostatmanual.com>

Golf course search by state

<http://golfingnear.com>

Email search by domain

<http://emailbydomain.com>

Auto manuals search

<http://auto.somanuals.com>

TV manuals search

<http://tv.somanuals.com>