

# ONKYO®

## CD Receiver

# *CR-515DAB*

# *CR-315DAB*

## Instruction Manual

Thank you for purchasing an Onkyo CD Receiver. Please read this manual thoroughly before making any connections and plugging it in. Following the instructions in this manual will enable you to obtain optimum performance and listening enjoyment from your new CD Receiver. Please retain this manual for future reference.

## Contents

Getting Started ..... 2

Connections ..... 16

Basic Operation ..... 27

Playing a Disc..... 30

Listening to the Radio ..... 38

Clock and Timer ..... 49

Miscellaneous ..... 56

**Troubleshooting..... 56**

If you can't resolve an issue, try resetting the CD receiver by holding down the [■] button and pressing the [STANDBY/ON] button.



## WARNING:

TO REDUCE THE RISK OF FIRE OR ELECTRIC SHOCK, DO NOT EXPOSE THIS APPARATUS TO RAIN OR MOISTURE.

## CAUTION:

TO REDUCE THE RISK OF ELECTRIC SHOCK, DO NOT REMOVE COVER (OR BACK). NO USER-SERVICEABLE PARTS INSIDE. REFER SERVICING TO QUALIFIED SERVICE PERSONNEL.



**WARNING**  
RISK OF ELECTRIC SHOCK  
DO NOT OPEN

**AVIS**  
RISQUE DE CHOC ELECTRIQUE  
NE PAS OUVRIR



The lightning flash with arrowhead symbol, within an equilateral triangle, is intended to alert the user to the presence of uninsulated “dangerous voltage” within the product’s enclosure that may be of sufficient magnitude to constitute a risk of electric shock to persons.



The exclamation point within an equilateral triangle is intended to alert the user to the presence of important operating and maintenance (servicing) instructions in the literature accompanying the appliance.

## Important Safety Instructions

1. Read these instructions.
2. Keep these instructions.
3. Heed all warnings.
4. Follow all instructions.
5. Do not use this apparatus near water.
6. Clean only with dry cloth.
7. Do not block any ventilation openings. Install in accordance with the manufacturer’s instructions.
8. Do not install near any heat sources such as radiators, heat registers, stoves, or other apparatus (including amplifiers) that produce heat.
9. Do not defeat the safety purpose of the polarized or grounding-type plug. A polarized plug has two blades with one wider than the other. A grounding type plug has two blades and a third grounding prong. The wide blade or the third prong are provided for your safety. If the provided plug does not fit into your outlet, consult an electrician for replacement of the obsolete outlet.
10. Protect the power cord from being walked on or pinched particularly at plugs, convenience receptacles, and the point where they exit from the apparatus.
11. Only use attachments/accessories specified by the manufacturer.
12. Use only with the cart, stand, tripod, bracket, or table specified by the manufacturer, or sold with the apparatus. When a cart is used, use caution when moving the cart/apparatus combination to avoid injury from tip-over.  

PORTABLE CART WARNING  
S3125A
13. Unplug this apparatus during lightning storms or when unused for long periods of time.
14. Refer all servicing to qualified service personnel. Servicing is required when the apparatus has been damaged in any way, such as power-supply cord or plug is damaged, liquid has been spilled or objects have fallen into the apparatus, the apparatus has been exposed to rain or moisture, does not operate normally, or has been dropped.
15. Damage Requiring Service  
Unplug the apparatus from the wall outlet and refer servicing to qualified service personnel under the following conditions:
  - A. When the power-supply cord or plug is damaged,
  - B. If liquid has been spilled, or objects have fallen into the apparatus,
  - C. If the apparatus has been exposed to rain or water,
  - D. If the apparatus does not operate normally by following the operating instructions. Adjust only those controls that are covered by the operating instructions as an improper adjustment of other controls may result in damage and will often require extensive work by a qualified technician to restore the apparatus to its normal operation,
  - E. If the apparatus has been dropped or damaged in any way, and
  - F. When the apparatus exhibits a distinct change in performance this indicates a need for service.
16. Object and Liquid Entry  
Never push objects of any kind into the apparatus through openings as they may touch dangerous voltage points or short-out parts that could result in a fire or electric shock.  
The apparatus shall not be exposed to dripping or splashing and no objects filled with liquids, such as vases shall be placed on the apparatus.  
Don’t put candles or other burning objects on top of this unit.
17. Batteries  
Always consider the environmental issues and follow local regulations when disposing of batteries.
18. If you install the apparatus in a built-in installation, such as a bookcase or rack, ensure that there is adequate ventilation.  
Leave 20 cm (8”) of free space at the top and sides and 10 cm (4”) at the rear. The rear edge of the shelf or board above the apparatus shall be set 10 cm (4”) away from the rear panel or wall, creating a flue-like gap for warm air to escape.

# Precautions

- 1. Recording Copyright**—Unless it's for personal use only, recording copyrighted material is illegal without the permission of the copyright holder.
- 2. AC Fuse**—The AC fuse inside the unit is not user-serviceable. If you cannot turn on the unit, contact your Onkyo dealer.
- 3. Care**—Occasionally you should dust the unit all over with a soft cloth. For stubborn stains, use a soft cloth dampened with a weak solution of mild detergent and water. Dry the unit immediately afterwards with a clean cloth. Don't use abrasive cloths, thinners, alcohol, or other chemical solvents, because they may damage the finish or remove the panel lettering.
- 4. Power**

**WARNING**  
BEFORE PLUGGING IN THE UNIT FOR THE FIRST TIME, READ THE FOLLOWING SECTION CAREFULLY.

AC outlet voltages vary from country to country. Make sure that the voltage in your area meets the voltage requirements printed on the unit's rear panel (e.g., AC 230 V, 50 Hz or AC 120 V, 60 Hz).

The power cord plug is used to disconnect this unit from the AC power source. Make sure that the plug is readily operable (easily accessible) at all times.



Pressing the [STANDBY/ON] button to select Standby mode does not fully shutdown the unit. If you do not intend to use the unit for an extended period, remove the power cord from the AC outlet.
- 5. Never Touch this Unit with Wet Hands**—Never handle this unit or its power cord while your hands are wet or damp. If water or any other liquid gets inside this unit, have it checked by your Onkyo dealer.
- 6. Handling Notes**
  - If you need to transport this unit, use the original packaging to pack it how it was when you originally bought it.
  - Do not leave rubber or plastic items on this unit for a long time, because they may leave marks on the case.
  - This unit's top and rear panels may get warm after prolonged use. This is normal.
  - If you do not use this unit for a long time, it may not work properly the next time you turn it on, so be sure to use it occasionally.
  - When you've finished using this unit, remove all discs and turn off the power.
- 7. Installing this Unit**
  - Install this unit in a well-ventilated location.
  - Ensure that there's adequate ventilation all around this unit, especially if it's installed in an audio rack. If the ventilation is inadequate, the unit may overheat, leading to malfunction.
  - Do not expose this unit to direct sunlight or heat sources, because its internal temperature may rise, shortening the life of the optical pickup.
  - Avoid damp and dusty places, and places subject to vibrations from loudspeakers. Never put the unit on top of, or directly above a loudspeaker.
  - Install this unit horizontally. Never use it on its side or on a sloping surface, because it may cause a malfunction.
  - If you install this unit near a TV, radio, or VCR, the picture and sound quality may be affected. If this occurs, move this unit away from the TV, radio, or VCR.
- 8. To Obtain a Clear Picture**—This unit is a high-tech, precision device. If the lens on the optical pickup, or the disc drive mechanism becomes dirty or worn, the picture quality may be affected. To maintain the best picture quality, we recommend regular inspection and maintenance (cleaning or worn part replacement) every 1,000 hours of use depending on the operating environment. Contact your Onkyo dealer for details.
- 9. Moisture Condensation**

**Moisture condensation may damage this unit.**  
Read the following carefully:  
Moisture may condense on the lens of the optical pickup, one of the most important parts inside this unit.

  - Moisture condensation can occur in the following situations:
    - The unit is moved from a cold place to a warm place.
    - A heater is turned on, or cold air from an air conditioner is hitting the unit.
    - In the summer, when this unit is moved from an air conditioned room to a hot and humid place.
    - The unit is used in a humid place.
  - Do not use this unit when there's the possibility of moisture condensation occurring. Doing so may damage your discs and certain parts inside this unit.

If condensation does occur, remove all discs and leave this unit turned on for two to three hours. By this time, the unit will have warmed up and any condensation will have evaporated.

## For European Models

<b>Declaration of Conformity</b>	
We, ONKYO EUROPE ELECTRONICS GmbH LIEGNITZERSTRASSE 6, 82194 GROEBENZELL, GERMANY	
declare in own responsibility, that the ONKYO product described in this instruction manual is in compliance with the corresponding technical standards such as EN60065, EN55013, EN55020 and EN61000-3-2, -3-3.	
GROEBENZELL, GERMANY	 K. MIYAGI
ONKYO EUROPE ELECTRONICS GmbH	

## Precautions—Continued

This unit contains a semiconductor laser system and is classified as a “CLASS 1 LASER PRODUCT”. So, to use this model properly, read this Instruction Manual carefully. In case of any trouble, please contact the store where you purchased the unit.

To prevent being exposed to the laser beam, do not try to open the enclosure.

### **DANGER:**

VISIBLE AND/OR INVISIBLE LASER RADIATION WHEN OPEN AND INTERLOCK FAILED OR DEFEATED. DO NOT STARE INTO BEAM.

### **CAUTION:**

THIS PRODUCT UTILIZES A LASER. USE OF CONTROLS OR ADJUSTMENTS OR PERFORMANCE OF PROCEDURES OTHER THAN THOSE SPECIFIED HEREIN MAY RESULT IN HAZARDOUS RADIATION EXPOSURE.

The label on the right is applied on the rear panel.



1. This unit is a CLASS 1 LASER PRODUCT and employs a laser inside the cabinet.
2. To prevent the laser from being exposed, do not remove the cover. Refer servicing to qualified personnel.

## For British models

Replacement and mounting of an AC plug on the power supply cord of this unit should be performed only by qualified service personnel.

### **IMPORTANT**

The wires in the mains lead are coloured in accordance with the following code:

Blue: Neutral  
Brown: Live

As the colours of the wires in the mains lead of this apparatus may not correspond with the coloured markings identifying the terminals in your plug, proceed as follows:

The wire which is coloured blue must be connected to the terminal which is marked with the letter N or coloured black.

The wire which is coloured brown must be connected to the terminal which is marked with the letter L or coloured red.

### **IMPORTANT**

The plug is fitted with an appropriate fuse. If the fuse needs to be replaced, the replacement fuse must be approved by ASTA or BSI to BS1362 and have the same ampere rating as that indicated on the plug. Check for the ASTA mark or the BSI mark on the body of the fuse.

If the power cord's plug is not suitable for your socket outlets, cut it off and fit a suitable plug. Fit a suitable fuse in the plug.

## Supplied Accessories

Make sure you have the following accessories:

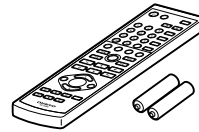

**Remote controller and two batteries (AA/R6)**



**Indoor FM antenna**  
(Connector type varies from country to country.)

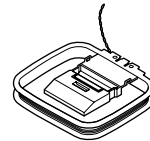

**AM loop antenna**



**DAB antenna**

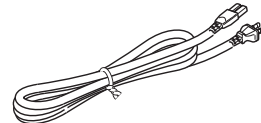

**Power cord**  
(Plug type varies from country to country.)

\* In catalogs and on packaging, the letter at the end of the product name indicates the color. Specifications and operations are the same regardless of color.

# Before Using the CD Receiver

## Installing the Batteries

- 1 Detach the battery cover by pressing the tab and pulling up the cover.**

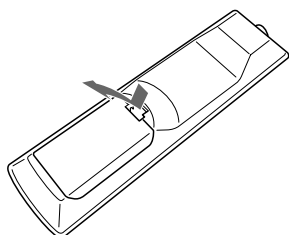

- 2 Insert two AA-size batteries into the battery compartment.**

Carefully follow the polarity diagram (positive (+) and negative (-) symbols) inside the battery compartment.

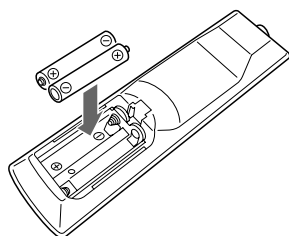

- 3 After the batteries are installed and seated correctly, attach the compartment cover.**

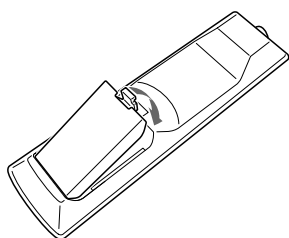

### Notes:

- If the remote controller doesn't work reliably, try replacing the batteries.
- Don't mix new and old batteries or different types of batteries.
- If you intend not to use the remote controller for a long time, remove the batteries to prevent damage from leakage or corrosion.
- Expired batteries should be removed as soon as possible to prevent damage from leakage or corrosion.

## Using the Remote Controller

When you operate the remote controller, point it at the CD receiver's remote control sensor, as shown below.

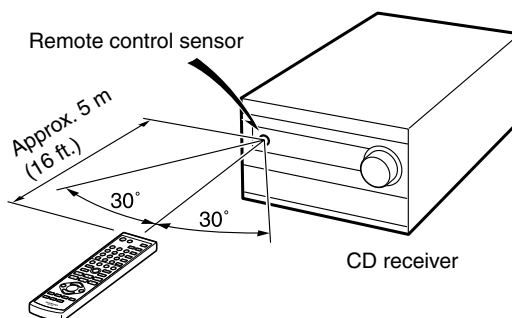

### Notes:

- The remote controller may not work reliably if the CD receiver is subjected to bright light, such as direct sunlight or inverter-type fluorescent lights. Keep this in mind when installing.
- If another remote controller of the same type is used in the same room, or the CD receiver is installed close to equipment that uses infrared rays, the remote controller may not work reliably.
- Don't put anything, such as a book, on the remote controller because the buttons may be pressed inadvertently, thereby draining the batteries.
- The remote controller may not work reliably if the CD receiver is installed in a rack behind colored glass doors. Keep this in mind when installing.
- The remote controller will not work if there's an obstacle between it and the CD receiver's remote control sensor.

# Features

---

## ***Amplifier***

---

- WRAT (Wide Range Amplifier Technology)
  - High Current, Low Impedance Drive
  - Discrete Output Stage Circuitry
  - Optimum Gain Volume Circuitry
  - Subwoofer Pre Out
- **CR-515DAB** —
- VLSC (Vector Linear Shaping Circuitry)\*
  - 4 Audio Inputs and 2 Outputs (1 on front panel)
- **CR-315DAB** —
- 3 Audio Inputs (1 on front panel) and 1 Output

## ***CD Player***

---

- Plays CDs, MP3 CDs, CD-Rs and CD-RWs
  - 25 Track Programming
  - 2 Repeat Mode (Track/Full)
  - 4 Play Modes (Normal/Random/Memory/1 Folder)
- **CR-515DAB** —
- Wolfson Single-Bit D/A Converter
- **CR-315DAB** —
- Single-Bit D/A Converter

## ***Tuner & Other***

---

- DAB Digital Radio
- 4-Program Timer (Play or Rec / Once or Every)
- Sleep Timer
- Battery-Free Memory Backup
- Headphone Jack
- Aluminium Front Panel
- RI-Dock Compatible Remote Control (iPod Control Capable)

\* VLSC and the VLSC logo are registered trademarks of Onkyo Corporation.

# Contents

## Basic Operations

### Getting Started

Important Safety Instructions .....	2
Precautions .....	3
Supplied Accessories .....	4
Before Using the CD Receiver .....	5
Installing the Batteries .....	5
Using the Remote Controller .....	5
Features .....	6
Contents .....	7
Getting to Know the CD Receiver .....	8
Front Panel .....	8
Display .....	10
Rear Panel .....	11
Remote Controller .....	12
Disc Notes .....	14

### Connections

Connecting Antennas .....	16
Connecting Speakers .....	18
Connecting the Power Cord .....	25
First Time Setup (European Model Only) .....	26
Setting the Clock with the AccuClock Function (European Model Only) .....	26

### Basic Operation

Basic Operation .....	27
Turning On the CD Receiver .....	27
Adjusting the Volume .....	27
Selecting the Input Source .....	27
Using Headphones .....	27
Adjusting the Bass and Treble .....	28
Using the Super Bass Function .....	28
Using the Direct Function .....	28
Muting the Sound .....	28
Changing the Input Display .....	29

### Playing a Disc

Playing CDs .....	30
Using the Remote Controller .....	31
Displaying CD Information .....	31
Selecting/Playing MP3 Files .....	32
Displaying MP3 Information .....	34

### Listening to the Radio

Listening to the Radio .....	38
Tuning into FM/AM Radio Stations .....	38
Displaying Radio Information .....	39
Receiving RDS .....	39
Listening to DAB Digital Radio .....	40
Presetting FM Stations Automatically (Auto Preset) .....	43
Presetting AM/FM/DAB Stations Manually .....	44
Selecting Preset Stations .....	45

### Clock and Timer

Setting the Clock .....	49
Setting AccuClock to Use a Specific Station .....	49
Setting the Clock Manually .....	50
Using the Timers .....	51
About the Timers .....	51
Programming the Timers .....	52
Turning Timers On and Off .....	54
Checking Timer Settings .....	54
Using the Sleep Timer .....	55

### Miscellaneous

Troubleshooting .....	56
Specifications .....	59

## Advanced Operations

Connecting Other Components .....	19
About Connections .....	19
Cables and Jacks .....	19
Connecting a Subwoofer .....	19
Connecting an Onkyo Cassette Deck .....	20
Connecting an Onkyo MD recorder .....	21
Connecting an Onkyo RI Dock (Remote Interactive Dock) .....	22
Connecting an Onkyo CD Recorder (CR-515DAB) .....	23
Connecting a Portable Audio Device .....	23
Connecting a Component with a Digital Audio Output (CR-515DAB only) .....	24
Connecting a TV .....	25

Memory Playback .....	35
Random Playback .....	36
Repeat Playback .....	36
Setting MP3 Preferences .....	37

Selecting DAB Stations .....	41
Displaying DAB Radio Information .....	41
DAB Setup .....	42
Naming Presets .....	46
Copying Presets .....	47
Erasing a Preset's Name .....	48
Erasing Presets .....	48

# Getting to Know the CD Receiver

## Front Panel

### CR-515DAB

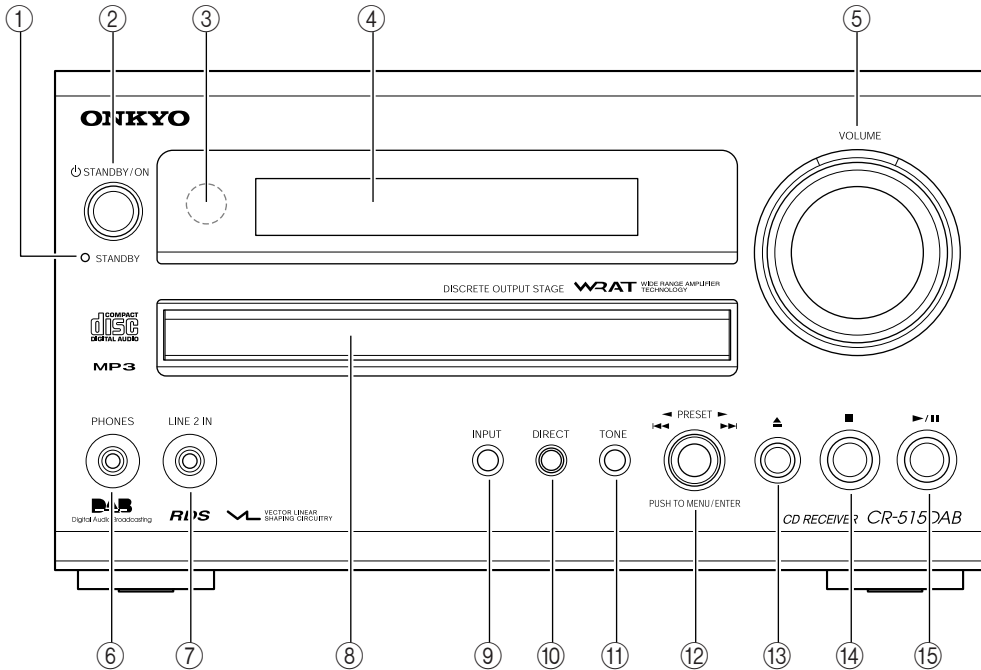

### CR-315DAB

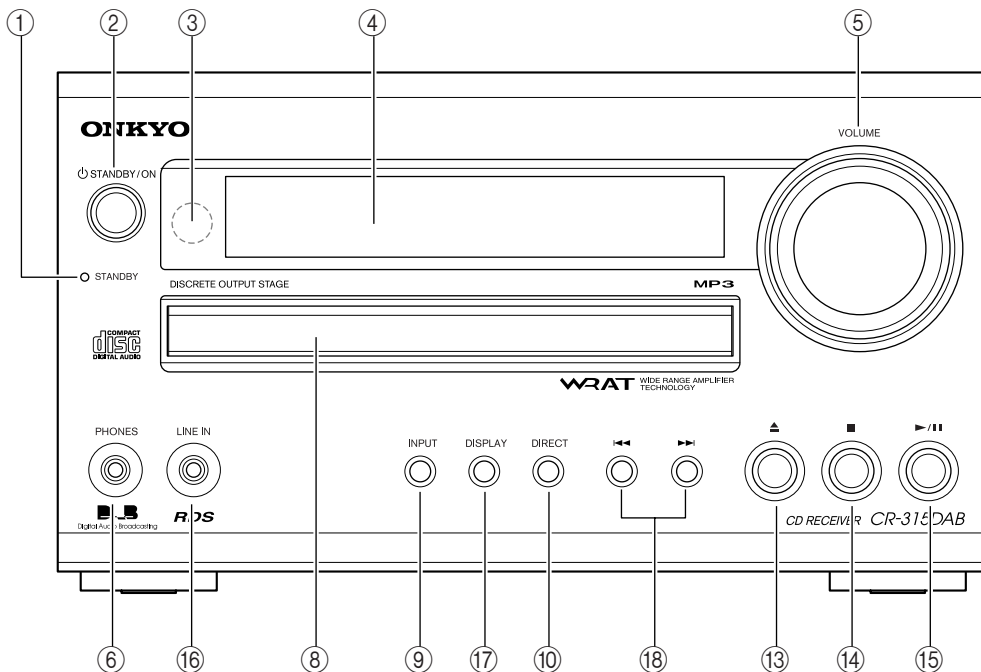



The page numbers in parentheses show where you can find the main explanation for each item.

- ① **STANDBY indicator (25, 27)**  
Lights up in Standby mode.
- ② **STANDBY/ON button (27, 50, 53, 56)**  
Sets the CD receiver to On or Standby.
- ③ **Remote control sensor (5)**  
Receives control signals from the remote controller.
- ④ **Display**  
See “Display” on page 10.
- ⑤ **VOLUME control (27)**  
Adjusts the volume level.  
On the CR-515DAB, the volume control indicator lights up when the CD receiver is on.
- ⑥ **PHONES jack (27)**  
This stereo minijack is for connecting a pair of stereo headphones for private listening.
- ⑦ **LINE 2 IN jack (CR-515DAB)**  
This stereo minijack is for connecting an audio source, such as an MP3 music player or personal computer.
- ⑧ **Disc tray (30)**  
The CD is loaded here.
- ⑨ **INPUT button (27, 29, 43, 45)**  
Used to select the input source.
- ⑩ **DIRECT button (28)**  
Used with the Direct function.  
On the CR-515DAB, the DIRECT button’s indicator lights up when the Direct function is on.
- ⑪ **TONE button (CR-515DAB) (28)**  
Used to adjust the bass and treble.
- ⑫ **Multi control (CR-515DAB) (30, 45)**  
Used to select radio presets, tracks, and MP3 folders. Also used to select and set various functions and settings.
- ⑬ **Eject [▲] button (30)**  
Ejects the loaded CD.
- ⑭ **Stop [■] button (30, 56)**  
Stops CD playback.
- ⑮ **Play/Pause [▶/⏸] button (30)**  
Starts CD playback. Pressing it during playback pauses playback.
- ⑯ **LINE IN jack (CR-315DAB) (23)**  
This stereo minijack is for connecting an audio source, such as an MP3 music player or personal computer.
- ⑰ **DISPLAY button (CR-315DAB) (31, 34, 39)**  
Used to change the information shown on the display. Also used to select characters when naming radio presets.
- ⑱ **Previous and Next [◀◀]/[▶▶] buttons (CR-315DAB) (30)**  
The Previous [◀◀] button selects the previous track. During playback it selects the beginning of the current track. The Next [▶▶] button selects the next track.

## Display

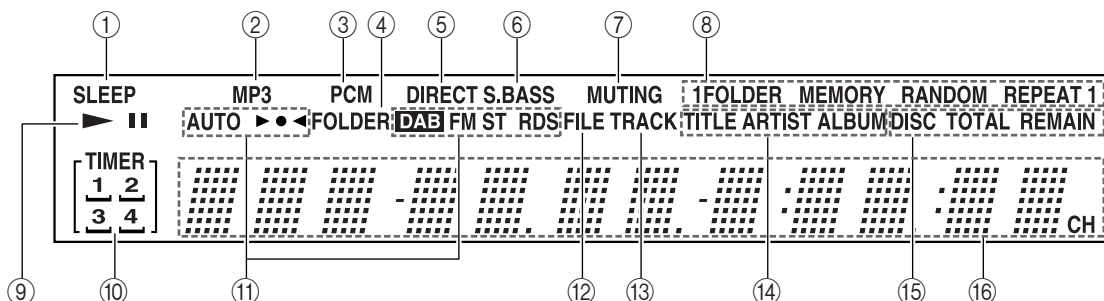

### ① SLEEP indicator

Lights up when the Sleep function has been set.

### ② MP3 indicator

Lights up when an MP3 CD is loaded.

### ③ PCM indicator

Lights up when the digital input signal received by the DIGITAL IN jack is PCM. It flashes if the signal is not PCM or the CD receiver is not locked to the incoming digital signal.

### ④ FOLDER indicator

Lights up while the number of an MP3 folder is being displayed.

### ⑤ DIRECT indicator

Lights up when the Direct function is on.

### ⑥ S.BASS indicator

Lights up when the Super Bass function is on.

### ⑦ MUTING indicator

Flashes while the CD receiver is muted.

### ⑧ Playback mode indicators

**1FOLDER:** Lights up when 1-folder playback is selected.

**MEMORY:** Lights up when memory playback is selected.

**RANDOM:** Lights up when random playback is selected.

**REPEAT:** Lights up when repeat playback is selected for all tracks.

**REPEAT 1:** Lights up when repeat playback is selected for one track.

### ⑨ Play and pause ▶/|| indicators

The Play indicator lights up for playback. The Pause indicator lights up while playback is paused.

### ⑩ TIMER indicators

Show the status of the timers.

**TIMER:** Lights up when a timer has been programmed.

**1, 2, 3, 4:** Light up when a timer has been programmed.

◡: Lights up when a timer has been programmed for recording.

### ⑪ Tuning indicators

**AUTO:** Lights up when Auto Tuning is selected, and disappears when Manual Tuning is selected.

►●◄: Lights up when the CD receiver is tuned to a radio station.

**DAB:** Lights up when the CD receiver is tuned to a DAB digital radio station.

**FM ST:** Lights up when the CD receiver is tuned to a stereo FM station.

**RDS (European model only):** Lights up when the CD receiver is tuned to a radio station that supports RDS (Radio Data System).

### ⑫ FILE indicator

Lights up when an MP3 file number is being displayed.

### ⑬ TRACK indicator

Lights up when a CD track number is being displayed.

### ⑭ TITLE, ARTIST and ALBUM indicators

**TITLE** lights up when the title (ID3 tag) of an MP3 track is being displayed.

**ARTIST** lights up when the artist name from an MP3 track (ID3 tag) is being displayed.

**ALBUM** lights up when the album name from an MP3 track (ID3 tag) is being displayed.

### ⑮ DISC, TOTAL, and REMAIN indicators

These indicators light up when the total time or the remaining disc or track time is being displayed.

### ⑯ Message area

Various information is displayed here, including radio preset numbers, tuning frequency, current time, volume level, sleep time, mode settings, and so on.

Rear Panel

CR-515DAB

CR-315DAB

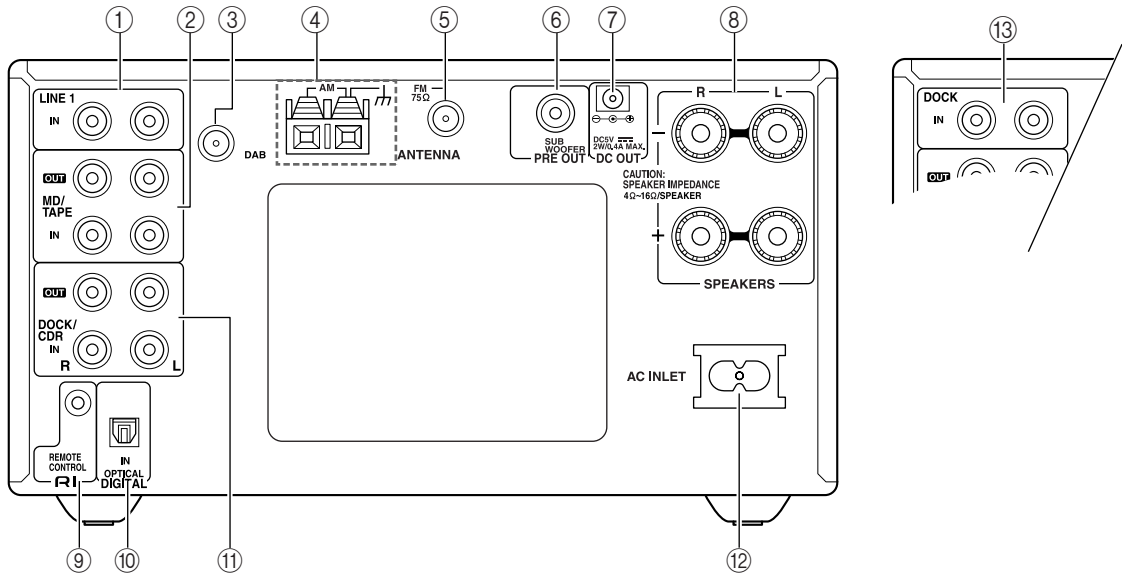

The page numbers in parentheses show where you can find the main explanation for each item.

- ① **LINE 1 IN (CR-515DAB) (25)**  
This analog audio input is for connecting a component with an analog output, such as a TV, or a turntable with a built-in phono equalizer.
- ② **MD/TAPE IN/OUT (20, 21)**  
These analog audio inputs and outputs are for connecting a recorder with an analog input and output, such as a MiniDisc recorder or cassette deck.
- ③ **DAB ANTENNA (17)**  
This jack is for connecting a DAB antenna.
- ④ **AM ANTENNA (16, 17)**  
These push terminals are for connecting an AM antenna.
- ⑤ **FM ANTENNA (16, 17)**  
This jack is for connecting an FM antenna.
- ⑥ **SUBWOOFER PRE OUT (19)**  
This jack is for connecting a powered subwoofer.
- ⑦ **DC OUT (CR-515DAB only)**  
This jack is for powering the Onkyo UWL-1 Wireless USB Audio Transport. Only connect the special cable included with the UWL-1. Do not connect any other cable, as it will cause a malfunction. See the UWL-1's instruction manual for more information.
- ⑧ **SPEAKERS (18)**  
These terminal posts are for connecting speakers.
- ⑨ **RI REMOTE CONTROL (20–24)**  
This RI (Remote Interactive) jack can be connected to an RI jack on another Onkyo component. The CD receiver's remote controller can then be used to control that component. To use RI, you must make an analog audio connection (RCA) between the CD receiver and the other component, even if they are connected digitally.
- ⑩ **OPTICAL DIGITAL IN (CR-515DAB only) (24)**  
This optical digital audio input can be used to connect a component with an optical digital output, such as a CD recorder, MD recorder, games console, satellite tuner, or personal computer. Use a commercially available optical digital audio cable to make the connection.
- ⑪ **DOCK/CDR IN/OUT (CR-515DAB) (22, 23)**  
These analog audio inputs and outputs are for connecting a recorder with an analog input and output such as a CD recorder, or an Onkyo RI Dock.
- ⑫ **AC INLET (25)**  
The supplied power cord is connected here.
- ⑬ **DOCK IN (CR-315DAB) (22)**  
This analog audio input is for connecting an Onkyo RI Dock.

See pages 16–25 for connection information.

Remote Controller

RC-662S  
(CR-515DAB)

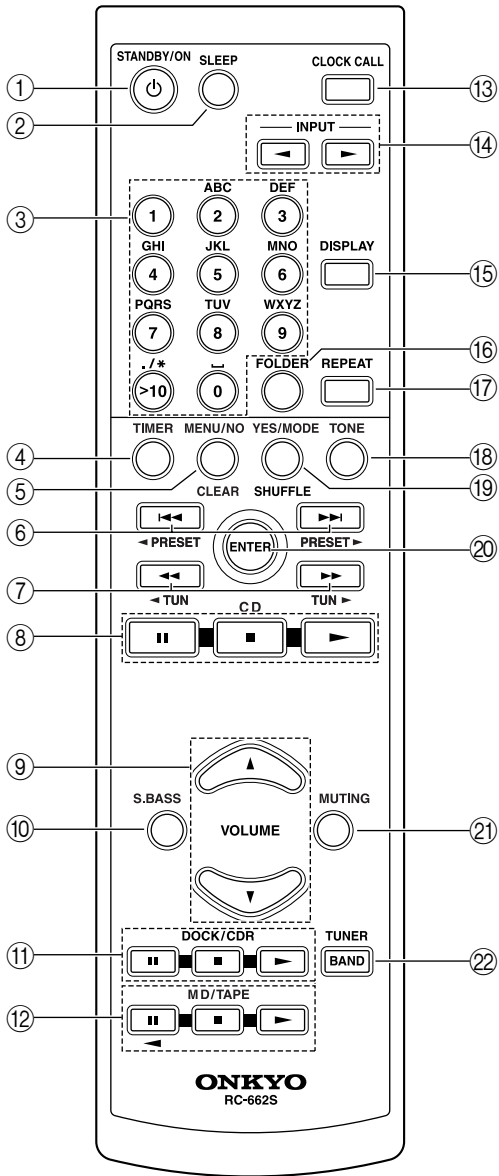

RC-660S  
(CR-315DAB)

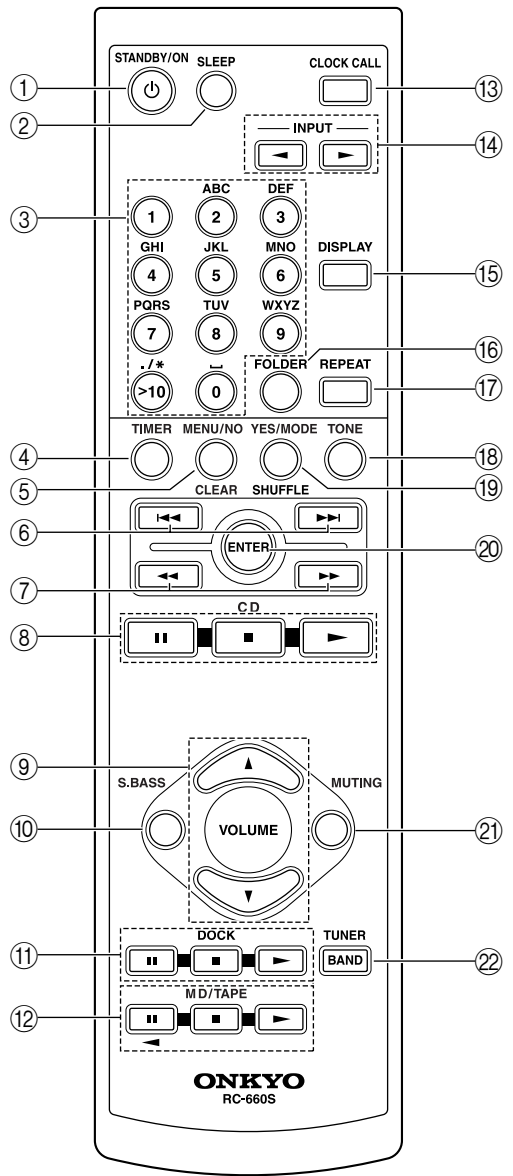





The page numbers in parentheses show where you can find the main explanation for each item.

- ① **STANDBY/ON button (27, 53)**  
This button is used to set the CD receiver to On or Standby.
- ② **SLEEP button (55)**  
Used to set the Sleep timer, which turns off the CD receiver after a specified time.
- ③ **Number buttons (31, 33, 35, 45, 46, 52)**  
Used to select tracks and radio presets. Also used to set the clock manually, set the timers, and enter names for radio presets. Can also be used with an Onkyo RI Dock or CD recorder.
- ④ **TIMER button (26, 49, 50, 52, 54)**  
Used to set the timers and clock.
- ⑤ **MENU/NO/CLEAR button (29, 36, 42–44, 46–48)**  
Used with various functions and settings for selecting, cancelling, and deleting. With an Onkyo CD recorder, it works as a clear button. With an Onkyo RI Dock, it works as a mode button.
- ⑥ **Previous/Next [◀◀]/[▶▶] and [◀ PRESET]/[PRESET ▶] buttons (31, 40, 42, 45)**  
Used to select the previous or next track or radio preset. Can also be used with an Onkyo RI Dock or CD recorder. With an Onkyo cassette deck, they work as rewind and fast forward buttons.
- ⑦ **Rewind/Fast Forward [◀◀]/[▶▶] and [◀ TUN]/[TUN ▶] buttons (31, 38, 41, 49)**  
Used to rewind or fast forward CD playback. Can also be used with an Onkyo RI Dock or CD recorder. Also used to tune the radio and edit preset names.
- ⑧ **CD control buttons (31)**  
  - : Pauses playback.
  - : Stops playback.
  - ▶ : Starts playback.
- ⑨ **VOLUME [▲/▼] buttons (27, 31)**  
Adjust the volume level.
- ⑩ **S.BASS button (28)**  
Sets the Super Bass function.
- ⑪ **Onkyo RI Dock and CD recorder control buttons**  
  - : Pauses playback or recording.
  - : Stops playback or recording.
  - ▶ : Starts playback or resumes recording.
- ⑫ **Onkyo MD recorder and cassette deck control buttons**  
For twin cassette decks, only Deck B can be controlled.
  - ◀ : Plays side B (cassette deck).
  - : Pauses playback or recording (MD).
  - : Stops playback, recording, fast-forward, or rewind.
  - ▶ : Plays side A.
- ⑬ **CLOCK CALL button (50)**  
Calls up the clock to display the day and time.
- ⑭ **INPUT [◀]/[▶] buttons (27, 29, 43, 45)**  
Used to select the input source.
- ⑮ **DISPLAY button (31, 34, 39, 41, 46, 50)**  
Used to change the information shown on the display. Also used to select characters when naming radio presets. Can also be used with an Onkyo CD recorder. With an Onkyo RI Dock, it works as a backlight button.
- ⑯ **FOLDER button (32, 33, 34, 37)**  
Used to select MP3 folders.
- ⑰ **REPEAT button (36)**  
Sets repeat playback. Can also be used with an Onkyo CD recorder. With an Onkyo cassette deck, it works as a reverse mode button.
- ⑱ **TONE button (28)**  
Used to adjust the bass and treble.
- ⑲ **YES/MODE/SHUFFLE button (34–36, 38)**  
Used with various functions and settings for confirming, selecting modes, and selecting shuffle playback.
- ⑳ **ENTER button**  
Used to confirm various functions and settings. Can also be used with an Onkyo RI Dock or CD recorder.
- ㉑ **MUTING button (28)**  
Mutes the output of the CD receiver.
- ㉒ **TUNER/BAND button (38, 40, 43, 44, 45)**  
Selects AM, FM, or DAB radio as the input source.

# Disc Notes

## Supported Discs

The CD receiver supports the following discs.

Disc	Logo	Format or file type
Audio CD		PCM
CD-R		Audio CD, MP3
		MP3
CD-RW		Audio CD, MP3
		MP3
CD Extra		Audio CD (Session 1), MP3 (Session 2)

- Some audio CDs use copy protection that doesn't conform to the official CD standard. Since these are non-standard discs, they may not play properly in the CD receiver.
- The CD receiver supports CD-R and CD-RW discs. However, some CD-R and CD-RW discs may not work properly for any of the following reasons: disc burner characteristics, disc characteristics, the disc is damaged or dirty. See the manual supplied with your disc burner for more information. Condensation or dirt on the optical pickup lens can also affect playback.
- The CD receiver supports 8 cm and 12 cm discs.
- The CD receiver does not support disc types not listed.
- Don't use discs with an unusual shape, such as those shown below, as you may damage the CD receiver.



- Don't use discs that have residue from adhesive tape, rental discs with peeling labels, or discs with custom-made labels or stickers. Doing so may damage the CD receiver and you may not be able to remove the disc properly.

## Discs Made on Personal Computers

Discs made on personal computers, including those of a compatible format, may not work properly in the CD receiver because of incorrect settings in the disc burning software. Check the manuals supplied with your disc burning software for additional compatibility information.

## MP3 Compatibility

- MP3 discs must be ISO 9660 Level 1 or Level 2, Romeo or Joliet compliant. Supported formats: Mode 1, Mode 2 XA Form 1.
- Folders can be up to eight levels deep.
- MP3 files must be MPEG-1/MPEG-2 Audio Layer 3 format with a sampling rate of between 8 kHz and 48 kHz and a bit-rate of between 8 kbps and 320 kbps (128 kbps recommended). Incompatible files cannot be played.
- Constant bit rate MP3 files are recommended, however, variable bit-rate (VBR) MP3 files between 8 kbps and 320 kbps are supported. (Playing times may not display correctly.)
- MP3 files must have a ".mp3" or ".MP3" file name extension. MP3 files without the proper extension will not be recognized. To prevent noise and malfunction, do not use these extensions for other types of files.
- The CD receiver supports up to 499 MP3 files and folders. Files and folders in excess of this cannot be played. Note that if the file and folder structure is very complicated, the CD receiver may not be able to read or play all of the MP3 files on the disc.
- Disc, file, and folder names may contain up to 32 characters.
- The maximum time that can be displayed for a single file is 99 minutes and 59 seconds.
- The remaining time cannot be displayed when playing MP3 files.
- MP3 file and folder names (excluding the extension) are shown on the display.
- Multisession discs are supported, however, some multisession discs may take a long time to load and some may not load at all. When burning CDs, we recommend that you use a single-session (disc-at-once), and select "Disc Close."
- Normally, the music in the audio session of a CD Extra disc is played. However, you can set the CD receiver so that it plays any MP3 files in the data session of a CD-R/RW disc instead. If the data session contains no MP3 files, the audio session will be played regardless. See "Setting MP3 Preferences" on page 36 for more information.
- The Emphasis is not supported.

- The following ID3 tags are supported: versions 1.0/1.1 and 2.2/2.3/2.4. Versions 2.5 and later are not supported. Normally, version 2.2/2.3/2.4 tags have priority and will be displayed regardless of the ID3 VER 1 preference on page 37.
- For ID3 version 2 tags, the tag information recognized will be those embedded in the beginning of the file. We recommend that you include only title, artist name, and album name information in ID3 tags. Compressed, encrypted, and unsynchronized ID3 tags cannot be displayed.

**Note:**

With CD-ROM, CD-R, and CD-RW discs that contain many files and folders and files other than MP3s, it may take a long time to read the disc. We recommend that you include only MP3 files on your discs, use about 20 folders, and limit folder nesting to three levels deep.

**Disc Content Organization**

■ **CD**

CDs contain tracks.

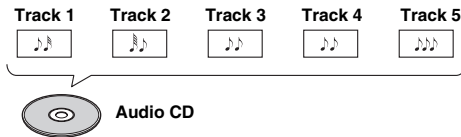

■ **MP3**

MP3 discs contain MP3 files organized into folders.

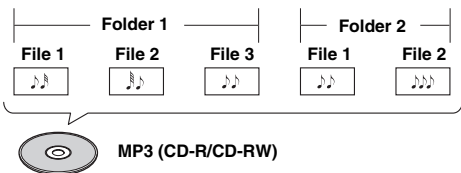

**Handling Discs**

- Never touch the underside of a disc. Always hold discs by the edge, as shown.

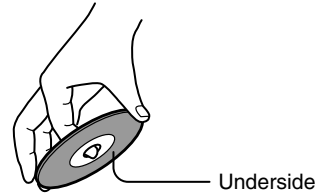

- Never attach adhesive tape or sticky labels to discs.



**Cleaning Discs**

- For best results, keep your discs clean. Fingerprints and dust can affect the sound quality and should be removed as follows. Using a clean soft cloth, wipe from the center outwards, as shown. Never wipe in a circular direction.



- To remove stubborn dust or dirt, wipe the disc with a damp soft cloth, and then dry it with a dry cloth.
- Never use solvent-based cleaning fluids, such as thinner or benzine, commercially available cleaners, or antistatic sprays intended for vinyl records, as they may damage the disc.

**Storing Discs**

- Don't store discs in places subject to direct sunlight or near heat sources.
- Don't store discs in places subject to moisture or dust, such as in a bathroom or near a humidifier.
- Always store discs in their cases and vertically. Stacking, or putting objects on unprotected discs may cause warping, scratches, or other damage.

# Connecting Antennas

This section explains how to connect the supplied indoor FM antenna, AM loop antenna, and DAB antenna, and how to connect commercially available outdoor FM and AM antennas.

The CD receiver won't pick up any radio signals without an antenna connected, so you must connect the antenna to use the tuner.

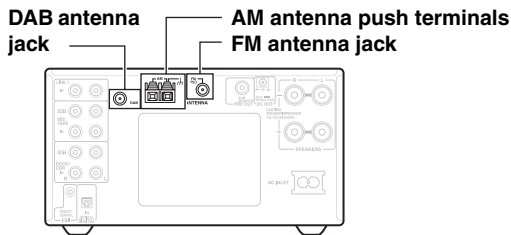

## Connecting the Indoor FM Antenna

The supplied indoor FM antenna is for indoor use only.

### 1 Attach the FM antenna, as shown.

#### ■ North American Model

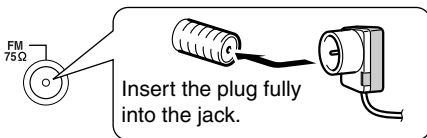

#### ■ Other Models

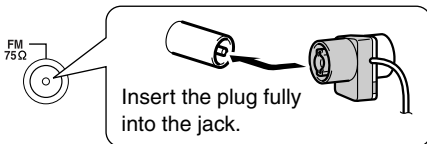

Once the CD receiver is ready for use, you'll need to tune into an FM radio station and adjust the position of the FM antenna to achieve the best possible reception.

### 2 Use thumbtacks or something similar to fix the FM antenna into position.

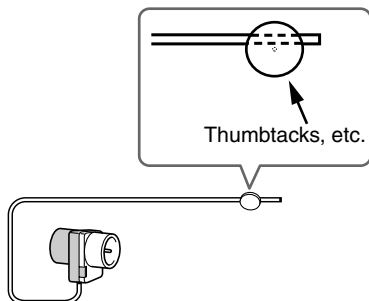

**Caution:** Be careful that you don't injure yourself when using thumbtacks.

If you cannot achieve good reception with the supplied indoor FM antenna, try a commercially available outdoor FM antenna instead (see page 17).

## Connecting the AM Loop Antenna

The supplied indoor AM loop antenna is for indoor use only.

### 1 Assemble the AM loop antenna, inserting the tabs into the base, as shown.

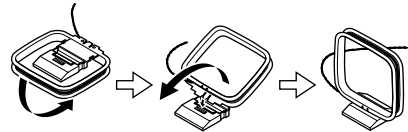

### 2 Connect both wires of the AM loop antenna to the AM push terminals, as shown.

(The antenna's wires are not polarity sensitive, so they can be connected either way around).

Make sure that the wires are attached securely and that the push terminals are gripping the bare wires, not the insulation.

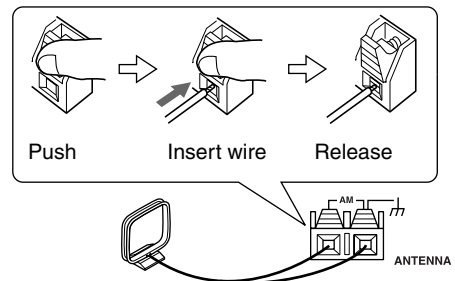

Once the CD receiver is ready for use, you'll need to tune into an AM radio station and adjust the position of the AM antenna to achieve the best possible reception.

Keep the antenna as far away as possible from the CD receiver, TV, speaker cables, and power cords.

If you cannot achieve good reception with the supplied indoor AM loop antenna, try using it with a commercially available outdoor AM antenna (see page 17).



### Connecting the DAB Antenna

#### 1 Screw the supplied DAB antenna's plug onto the DAB ANTENNA jack.

Once the CD Receiver is ready for use, you'll need to tune into a DAB station and adjust the position of the DAB antenna to achieve the best possible reception.

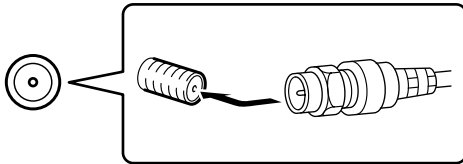

#### 2 Use thumbtacks or something similar to fix the DAB antenna into position.

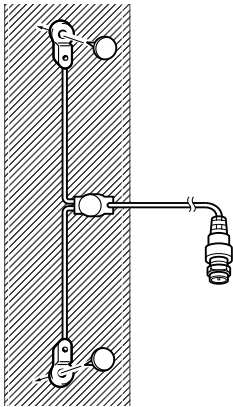

### Connecting an Outdoor FM Antenna

If you cannot achieve good reception with the supplied indoor FM antenna, try a commercially available outdoor FM antenna instead.

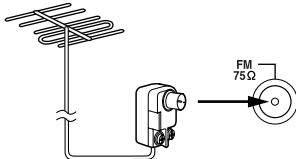

#### Notes:

- Outdoor FM antennas work best outside, but usable results can sometimes be obtained when installed in an attic or loft.
- For best results, install the outdoor FM antenna well away from tall buildings, preferably with a clear line of sight to your local FM transmitter.
- Outdoor antenna should be located away from possible noise sources, such as neon signs, busy roads, etc.

- For safety reasons, outdoor antenna should be situated well away from power lines and other high-voltage equipment.
- Outdoor antenna must be grounded in accordance with local regulations to prevent electrical shock hazards.

#### ■ Using a TV/FM Antenna Splitter

It's best not to use the same antenna for both FM and TV reception, as this can cause interference problems. If circumstances demand it, use a TV/FM antenna splitter, as shown.

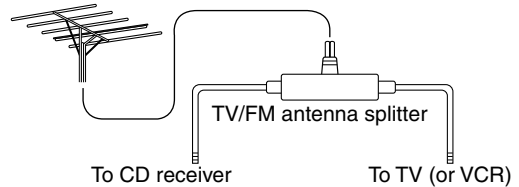

### Connecting an Outdoor AM Antenna

If good reception cannot be achieved using the supplied AM loop antenna, an outdoor AM antenna can be used in addition to the loop antenna, as shown.

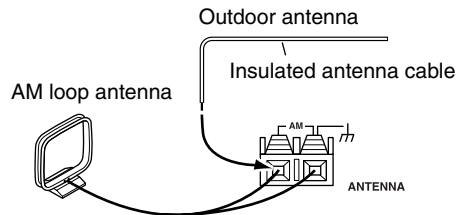

Outdoor AM antennas work best when installed horizontally outside, but good results can sometimes be obtained indoors by mounting horizontally above a window. Note that the AM loop antenna should be left connected.

Outdoor antenna must be grounded in accordance with local regulations to prevent electrical shock hazards.

# Connecting Speakers

## Connecting Your Speakers

- Connect the right speaker to the CD receiver's right (R) SPEAKERS terminals. Connect the left speaker to the left (L) SPEAKERS terminals.
- Connect the positive (+) terminal on each speaker to the corresponding positive (+) terminal on the CD receiver. Connect the negative (-) terminal on each speaker to the corresponding negative (-) terminal on the CD receiver. Use the red wires to connect the positive (+) terminals.

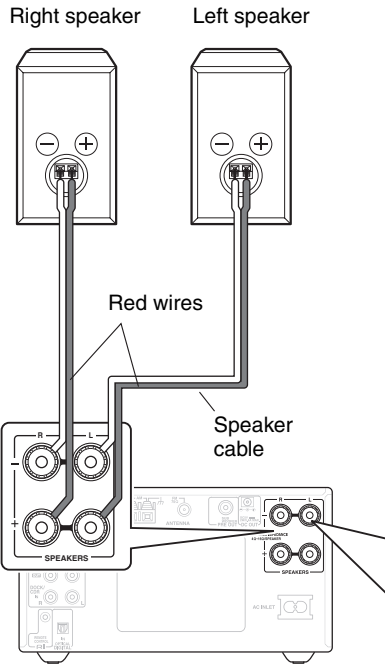

### —Terminal posts—

Strip about 15 mm (5/8") of insulation from the ends of the speaker cables, and twist the bare wires tightly. Unscrew the terminal. Fully insert the bare wire, making sure that it's touching the threaded shaft in the center. Screw the terminal tight.

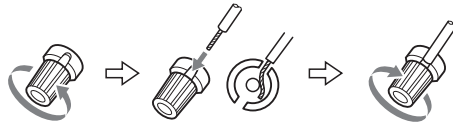

### —Push-type terminals—

Strip about 10 mm (3/8") of insulation from the ends of the speaker cables, and twist the bare wires tightly. Push the lever and insert the bare wires. Release the lever. Make sure the terminal is gripping the bare wires and not the insulation.



- Connect only speakers with an impedance of between 4 and 16 ohms. Connecting a speaker with a lower impedance may damage the speaker.
- Be careful not to short the positive and negative wires. Doing so may damage the CD receiver.
- Do not connect both speaker cables to the same L or R terminals (Fig. 1). Do not connect more than two speaker terminals to each speaker (Fig. 2).

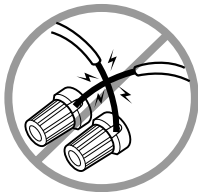

Fig. 1

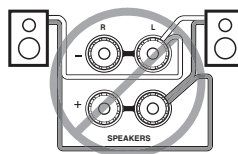
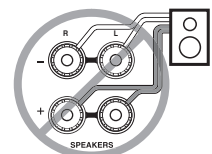

Fig. 2



# Connecting Other Components

## About Connections

- Before making any connections, read the manuals supplied with your other components.
- Don't connect the power cord until you've completed and double-checked all connections.

### Connection Color Coding

RCA-type audio connections are usually color-coded: red and white. Use red plugs to connect right-channel audio inputs and outputs (typically labeled "R"). Use white plugs to connect left-channel audio inputs and outputs (typically labeled "L").

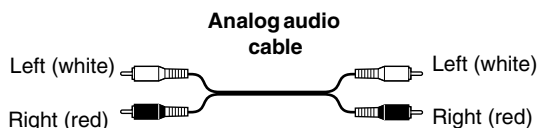

- Push plugs in all the way to make good connections (loose connections can cause noise or malfunctions).
- To prevent interference, keep audio cables away from power cords and speaker cables.

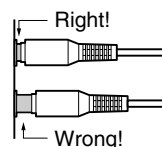

### Optical Digital Jack (CR-515DAB)

The CD receiver's optical digital jack has a shutter-type cover that opens when an optical plug is inserted and closes when it's removed. Push the plug in all the way.

**Caution:** To prevent shutter damage, hold the optical plug straight when inserting and removing.

**Note:**

Do not put anything on top of the CD receiver, as it may interfere with proper ventilation.

## Cables and Jacks

No connecting cables are included with the CD receiver.

Cable	Jack	Description
	R L	This cable carries analog audio.
	OPTICAL	This cable carries digital audio.
	LINE 2 IN	This cable carries analog audio.

## Connecting a Subwoofer

The CD receiver has a SUBWOOFER PRE OUT jack for connecting a powered subwoofer (i.e., a subwoofer with a built-in amplifier).

**Powered subwoofer**

**CD receiver**

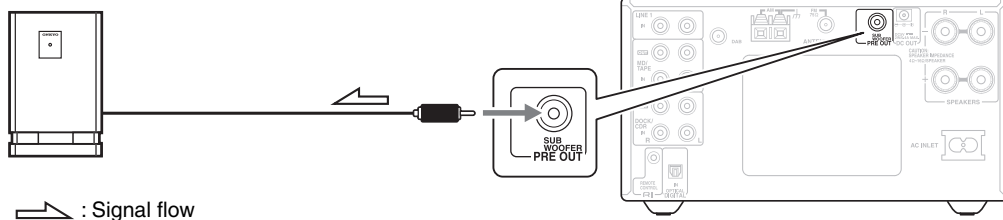

### Connecting an Onkyo Cassette Deck

The following diagram shows how to connect an optional Onkyo cassette deck.

Connect the CD receiver's MD/TAPE OUT jacks to the cassette deck's INPUT (REC) jacks, and connect the CD receiver's MD/TAPE IN jacks to the cassette deck's OUTPUT (PLAY) jacks.

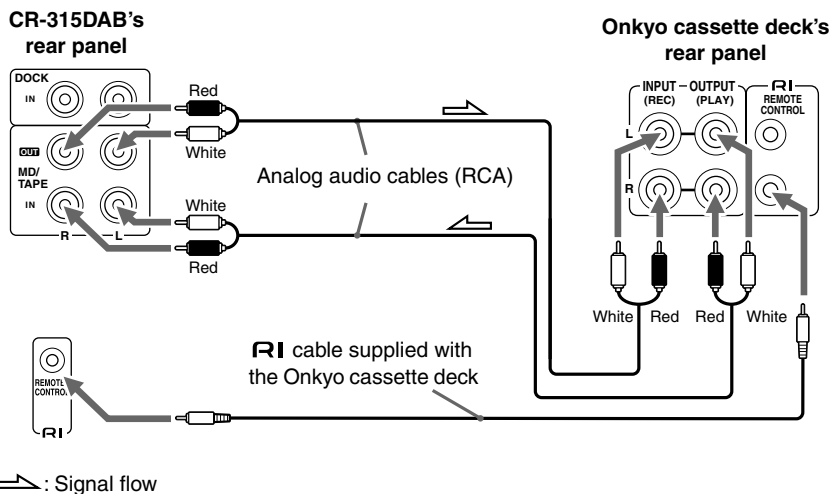
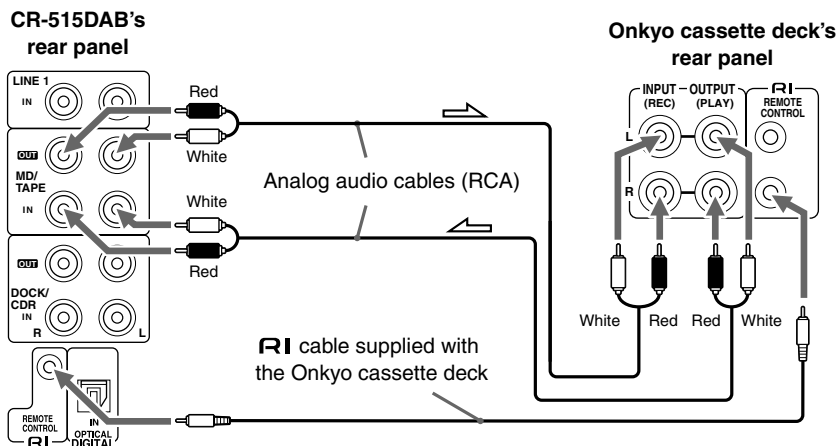

#### What can you do with RI?

- Connecting an Onkyo cassette deck to the CD receiver with an **RI** cable allows you to control the cassette deck with the CD receiver's remote controller. In addition, when playback is started on the cassette deck, the CD receiver will automatically select it as the input source.
- To use **RI**, you must connect the Onkyo cassette deck to the CD receiver with an **RI** cable and an analog audio cable (RCA). In addition, the Input Display for the MD/TAPE jacks must be set to "TAPE." Since this is the default setting, unless you've changed it, it can be left as it is (see page 29).
- Some **RI**-capable components have two **RI** jacks. They're both the same, so you can use either one. The extra jack is for connecting additional **RI**-capable components.

### Connecting an Onkyo MD recorder

The following diagram shows how to connect an optional Onkyo MD recorder.

Connect the CD receiver's MD/TAPE OUT jacks to the MD recorder's INPUT (REC) jacks, and connect the CD receiver's MD/TAPE IN jacks to the MD recorder's OUTPUT (PLAY) jacks.

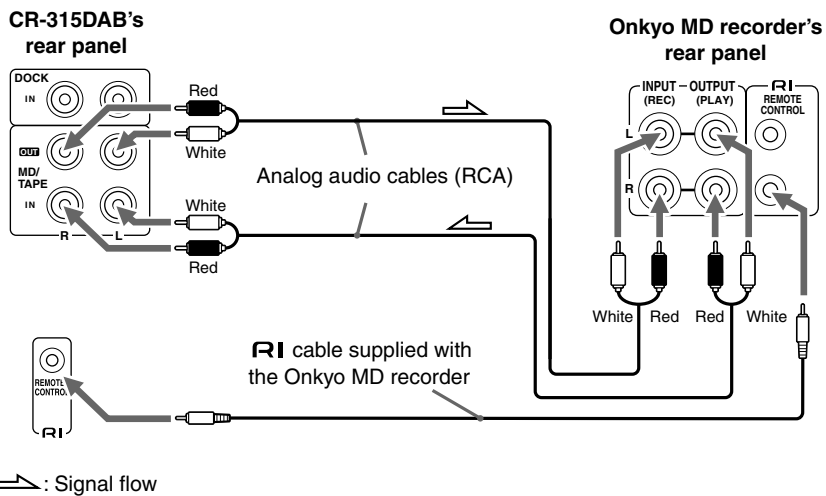
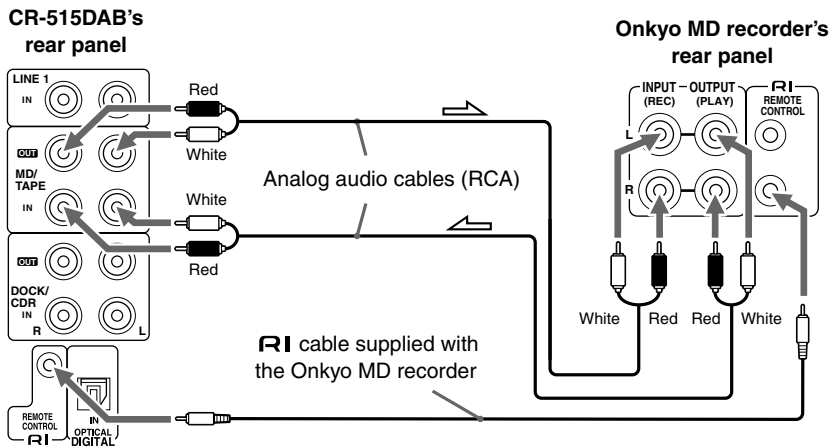

#### What can you do with RI?

- Connecting an Onkyo MD recorder to the CD receiver with an **RI** cable allows you to control the MD recorder with the CD receiver's remote controller. In addition, when playback is started on the MD recorder, the CD receiver will automatically select it as the input source.
- To use **RI**, you must connect the Onkyo MD recorder to the CD receiver with an **RI** cable and an analog audio cable (RCA). In addition, the Input Display for the MD/TAPE jacks must be set to "MD" (see page 29).
- Some **RI**-capable components have two **RI** jacks. They're both the same, so you can use either one. The extra jack is for connecting additional **RI**-capable components.

#### Note:

- The MD/TAPE jacks can alternatively be used to connect a VCR or DAT recorder, in which case the Input Display on the CD receiver would need to be set to "VCR" or "DAT" respectively (see page 29).

### Connecting an Onkyo RI Dock (Remote Interactive Dock)

The following diagram shows how to connect an optional Onkyo RI Dock (Remote Interactive Dock). Connect the CD receiver's DOCK/CDR IN jacks (DOCK IN jacks on the CR-315DAB) to the RI Dock's AUDIO OUT jacks.

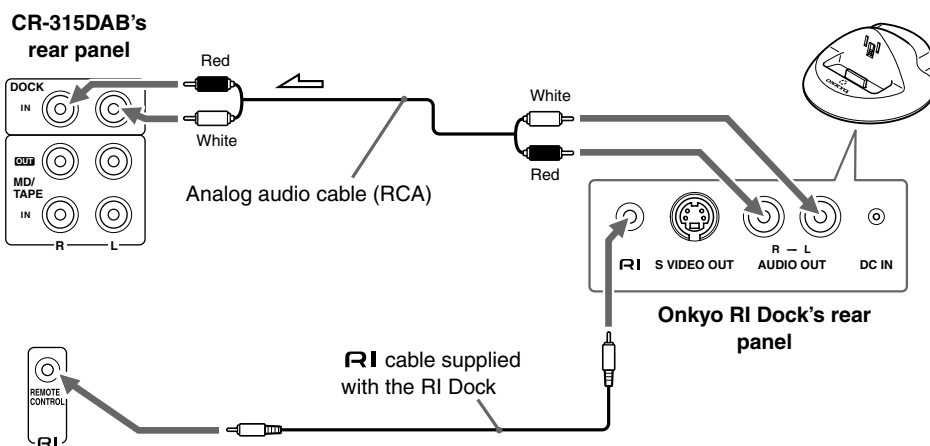
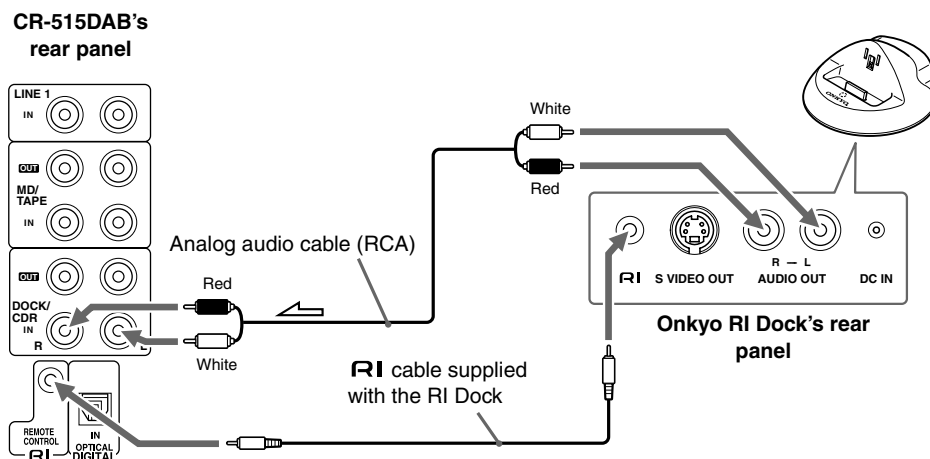

➤ : Signal flow

#### What can you do with RI?

- Connecting an Onkyo RI Dock to the CD receiver with an **RI** cable allows you to control the RI Dock with the CD receiver's remote controller. In addition, when playback is started on the RI Dock, the CD receiver will automatically select it as the input source.
- To use **RI**, you must connect the RI Dock to the CD receiver with an **RI** cable and an analog audio cable (RCA). On the RI Dock, set the MODE switch to "HDD." See the RI Dock's instruction manual for details.

#### CR-515DAB

- To use **RI**, the Input Display for the DOCK/CDR jacks must be set to "DOCK." Since this is the default setting, unless you've changed it, it can be left as it is (see page 29).

## Connecting an Onkyo CD Recorder (CR-515DAB)

The following diagram shows how to connect an optional Onkyo CD recorder.

Connect the CD receiver's DOCK/CDR OUT jacks to the CD recorder's INPUT (REC) jacks, and connect the CD receiver's DOCK/CDR IN jacks to the CD recorder's OUTPUT (PLAY) jacks.

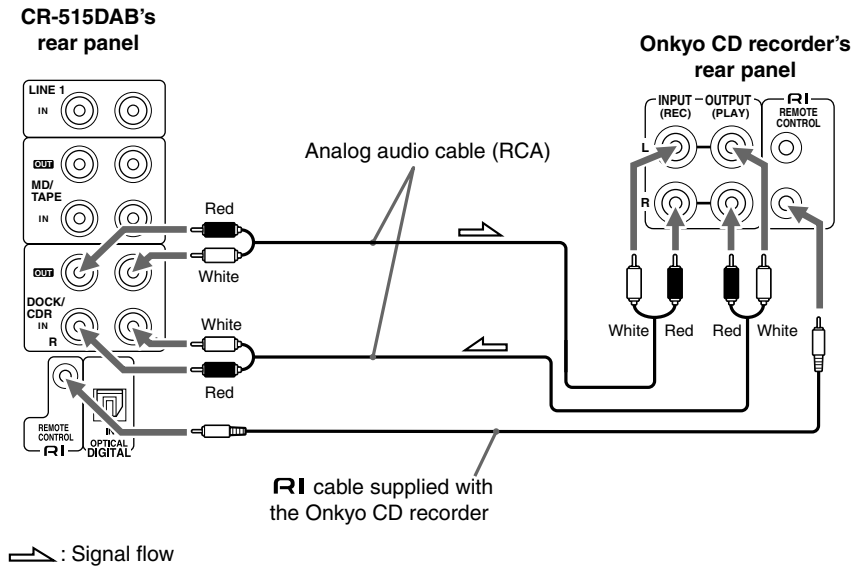

### What can you do with RI?

- Connecting an Onkyo CD recorder to the CD receiver with an **RI** cable allows you to control the CD recorder with the CD receiver's remote controller. In addition, when playback is started on the CD recorder, the CD receiver will automatically select it as the input source.
- To use **RI**, you must connect the Onkyo CD recorder to the CD receiver with an **RI** cable and an analog audio cable (RCA). In addition, the Input Display for the DOCK/CDR jacks must be set to "CDR" (see page 29).
- Some **RI**-capable components have two **RI** jacks. They're both the same, so you can use either one. The extra jack is for connecting additional **RI**-capable components.

## Connecting a Portable Audio Device

The following diagram shows how to connect a portable audio device (e.g., MP3 player, MD player, CD player).

Connect the CD receiver's LINE 2 IN jack (LINE IN jack on the CR-315DAB) on the front panel to the portable audio device's output jack.

Depending on the type of output jack on the portable audio device, you may need to buy a suitable cable. The CD receiver's LINE 2 IN jack (LINE IN jack on the CR-315DAB) accepts a stereo miniplug.

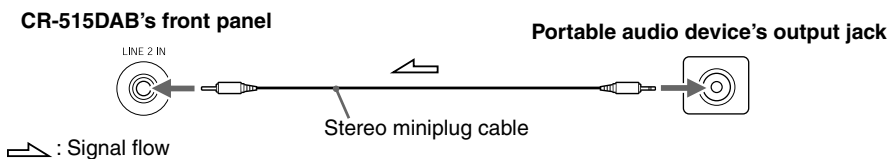

### Notes:

- Use a connecting cable that doesn't have any attenuation resistors in it.
- If you connect a portable audio device's headphone output to the CD receiver's LINE2 IN jack (LINE IN jack on the CR-315DAB), turn down the volume on the portable audio device before you connect it.
- When you connect a portable audio device to the CD receiver, make sure you connect it to the LINE 2 IN jack (LINE IN jack on the CR-315DAB) and not the adjacent PHONES jack. If you connect to the PHONES jack by mistake, it may cause the PHONES output to malfunction.

### Connecting a Component with a Digital Audio Output (CR-515DAB only)

The following diagram shows how to connect a component with an optical digital audio output, such as a CD recorder, MD recorder, games console, satellite tuner, or personal computer.

Connect the CD receiver's OPTICAL DIGITAL IN jack to an optical digital audio output on the other component.

You can change the Input Display for the OPTICAL DIGITAL IN to DIGITAL, CDR, PC, or GAME so that it matches the type of component that you connect (see page 29).

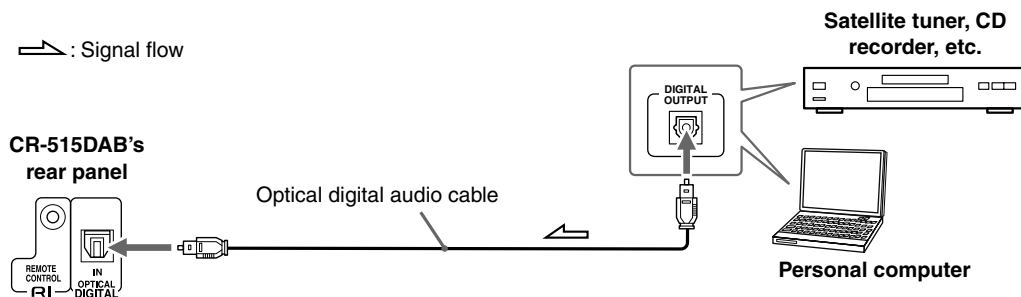

### Connecting an Onkyo Component with a Digital Audio Output

The following diagram shows how to connect an Onkyo component with an optical digital audio output.

Connect the CD receiver's OPTICAL DIGITAL IN jack to an optical digital audio output on the Onkyo component.

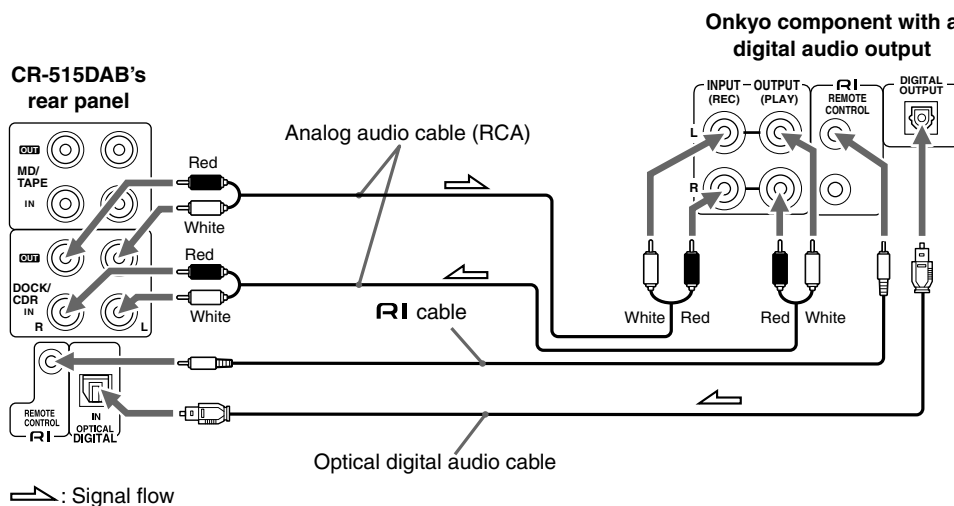

#### What can you do with RI?

- Connecting an Onkyo component to the CD receiver with an **RI** cable allows you to control the component with the CD receiver's remote controller. In addition, when playback is started on the component, the CD receiver will automatically select it as the input source.
- To use **RI**, you must connect the Onkyo component to the CD receiver with an **RI** cable and an analog audio cable (RCA). In addition, you must change the Input Display for the DIGITAL IN so that it matches the type of component that you connect. When you connect a CD recorder to the DOCK/CDR jacks and OPTICAL DIGITAL IN jack, you must set the Input Display for DOCK/CDR to "CD-R," and set the Input Display for OPTICAL DIGITAL IN to "CD-R/dig" (see page 29).
- If you connect an audio processor such as the Onkyo UE-205, you must set the Input Display for DOCK/CDR to "PC," and set the Input Display for OPTICAL DIGITAL IN to "PC/dig," otherwise the wrong input source may be selected when playback starts (see page 29).
- Some **RI**-capable components have two **RI** jacks. They're both the same, so you can use either one. The extra jack is for connecting additional **RI**-capable components.



## Connecting a TV

Connect the CD receiver's LINE 1 IN jacks (use the DOCK IN jacks on the CR-315DAB) to the TV's audio output jacks.

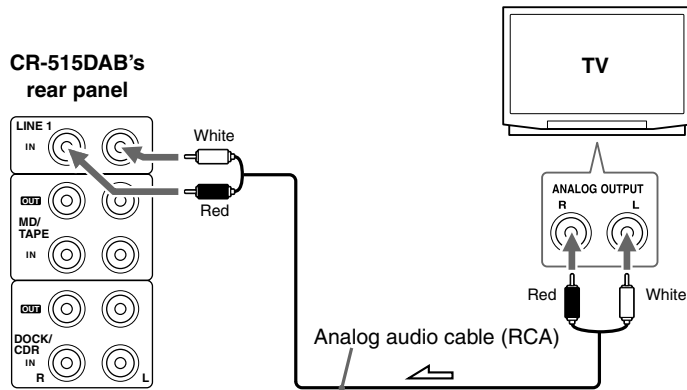

➔ : Signal flow

### Hint:

To listen to the TV, select the LINE 1 input source (select DOCK on the CR-315DAB).

## Connecting the Power Cord

### Notes:

- Before connecting the power cord, connect all of your speakers and AV components.
- Turning on the CD receiver may cause a momentary power surge that might interfere with other electrical equipment on the same circuit. If this is a problem, plug the CD receiver into a different branch circuit.
- Do not use a power cord other than the one supplied with the CD receiver. The supplied power cord is designed exclusively for use with the CD receiver and should not be used with any other equipment.
- Never disconnect the power cord from the CD receiver while the other end is still plugged into a wall outlet. Doing so may cause an electric shock. Always disconnect the power cord from the wall outlet first, and then the CD receiver.

### CR-515DAB

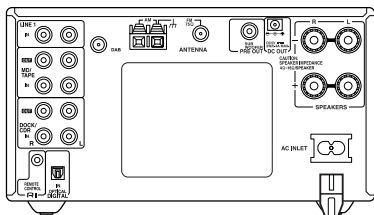

1  
2  
Supplied power cord To wall outlet

### CR-315DAB

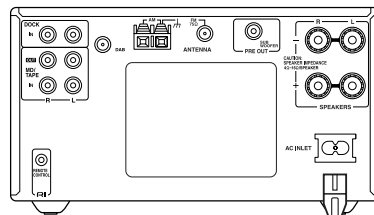

1  
2  
Supplied power cord To wall outlet

**1** Connect the supplied power cord to the CD receiver's AC INLET.

**2** Plug the power cord into a suitable wall outlet.  
The STANDBY indicator lights up.

To set the clock with the AccuClock function, the CD receiver must be able to receive RDS radio stations, which means an FM antenna must be connected (see page 16).

# First Time Setup (European Model Only)

## Setting the Clock with the AccuClock Function (European Model Only)

To use the AccuClock function, the CD receiver must be able to receive RDS radio stations, which means an FM antenna must be connected. Be sure to connect an FM antenna before attempting to use this function (see page 16).

The very first time you turn on the CD receiver, the AccuClock function automatically sets the CD receiver's clock based on the CT (Clock Time) information present in an RDS radio broadcast. While the clock is being set, "Wait..." flashes on the display, as shown. Note that it may take up to 5 minutes to set the clock.

When the clock has been set, the message "Clock Adjusted" scrolls across the display, then the day and time are displayed for a while, as shown.







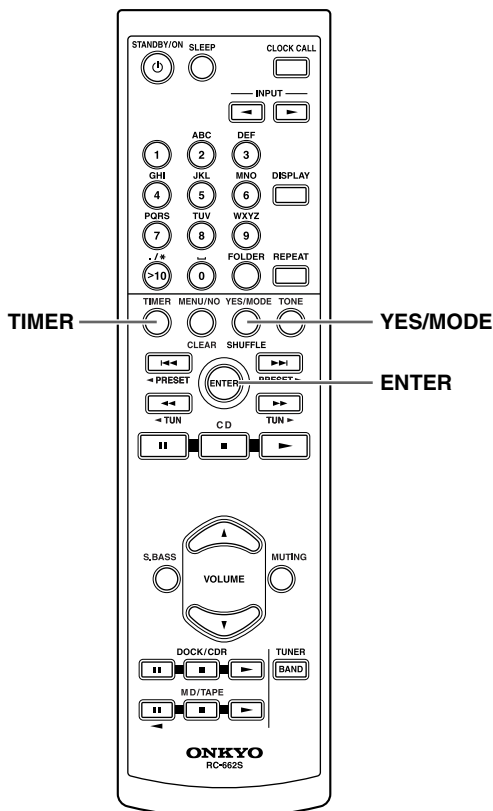

The AccuClock function automatically updates the clock daily at 2 A.M., 3 A.M., and 2 P.M.

If for some reason the clock cannot be set automatically, see "Setting AccuClock to Use a Specific Station" on page 49 and "Setting the Clock Manually" on page 50.

## Turning Off the AccuClock Function

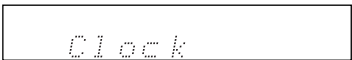
If you don't want AccuClock to automatically update the clock each day, you can turn it off as follows.

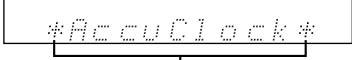

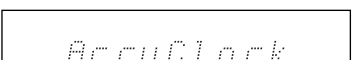
- 1**  
  
Press the [TIMER] button repeatedly until "Clock" appears on the display.  

- 2**  
  
Press [ENTER].  
\*\*AccuClock\*\* appears on the display.  
  
The asterisks indicate that the AccuClock function is on.
- 3**  
  
To turn off AccuClock, press the [YES/MODE] button.  
  
The asterisks disappear, indicating that the AccuClock function is off. To turn AccuClock back on again, press the [YES/MODE] button so that the asterisks are displayed.

### Note:

The AccuClock function cannot be turned off until the clock has been set.

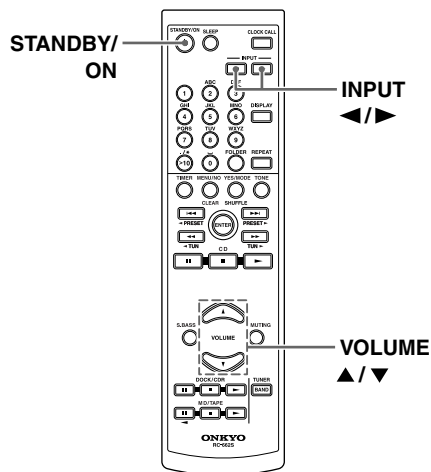
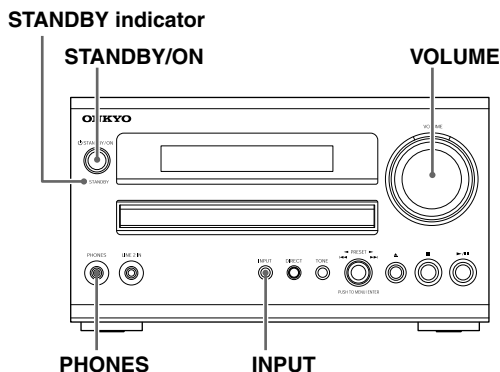
# Basic Operation



## Turning On the CD Receiver

CD receiver



Remote controller



To turn on the CD receiver, press the [STANDBY/ON] button on the CD receiver or remote controller. The STANDBY indicator goes off. Press the [STANDBY/ON] button again to set the CD receiver to Standby. The STANDBY indicator lights up.

### Tip:

When you start playback on (or turn on) an Onkyo RI Dock, CD recorder, MD recorder, or cassette deck that's connected to the CD receiver with an **RI** cable and analog audio cable, the CD receiver turns on automatically. Similarly, when you set the CD receiver to On or Standby, the other component will also be set to On or Standby.

## Adjusting the Volume

CD receiver

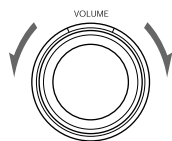

Remote controller

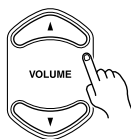

Turn the [VOLUME] control clockwise to increase the volume or counterclockwise to decrease it.

You can also use remote controller's VOLUME [▲]/[▼] buttons.

## Selecting the Input Source

You can select CD, DAB, AM, FM, or a connected component (TAPE, DOCK, LINE, DIGITAL) as the input source.

To select the input source, press the remote controller's INPUT [◀]/[▶] buttons repeatedly. On the CD receiver, press the [INPUT] button repeatedly. The input sources are selected in the following order.

### • CR-515DAB

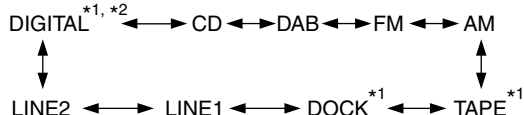

### • CR-315DAB

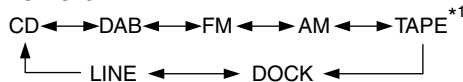

\*1 Input Display can be changed (see page 29).

\*2 CR-515DAB only.

## Using Headphones

Turn down the volume, then connect your stereo headphones to the PHONES minijack.

You can adjust the volume and mute the sound, as explained earlier.

The speakers output no sound while the headphones are connected.

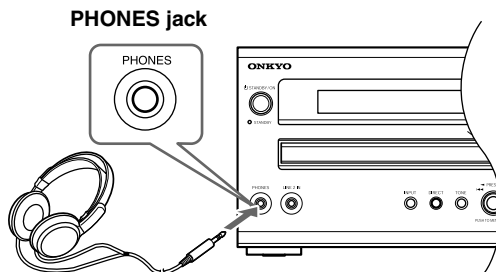

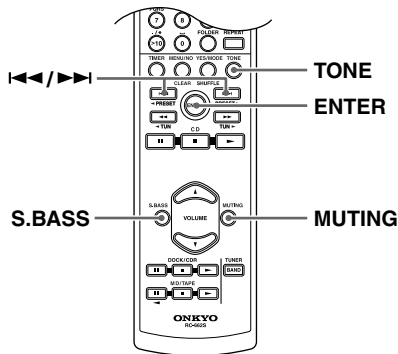

**CR-515DAB**

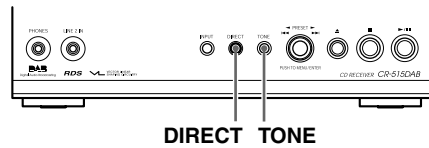

**CR-315DAB**

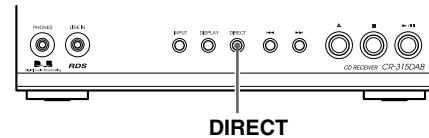

**Adjusting the Bass and Treble**

<p><b>1</b></p> <p>TONE</p>	<p>Press the [TONE] button to select Bass.</p>
<p><b>2</b></p> <p>↓</p>	<p>Use the Previous and Next [◀] [▶] buttons to adjust the bass.</p> <p>The default setting is “±0.” You can adjust the bass and treble from -3 to +3.</p> <p>Press [ENTER], and then use the Previous and Next [◀] [▶] buttons to adjust the treble.</p> <p><b>Notes:</b></p> <ul style="list-style-type: none"> <li>• If you press no buttons for 8 seconds, the previous display will appear automatically.</li> <li>• If you press the [TONE] button while the Direct function is on, the Direct function will be turned off.</li> </ul>

On the CR-515DAB, you can also use the [TONE] button and multi control on the front panel to adjust the bass and treble.

**Using the Super Bass Function**

**To turn on the Super Bass function, press the [S.BASS] button.**

The S.BASS indicator lights up.

**To turn off the Super Bass function, press the [S.BASS] button again.**

On the CR-515DAB, you can also use the [TONE] button on the front panel. Press the [TONE] button for 3 seconds to turn on the Super Bass function.

**Note:**

If you press the [S.BASS] button while the Direct function is on, the Direct function will be turned off.

**Using the Direct Function**

To turn the Direct function on or off, press the [DIRECT] button on the CD receiver.

When the Direct function is off, the tone controls can be used to adjust the sound. When the Direct function is on, the tone controls are bypassed, so you can enjoy a pure sound, and the DIRECT indicator lights up.

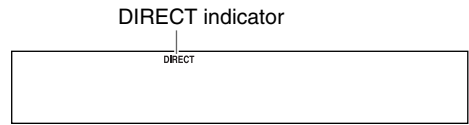

On the remote controller, press the [TONE] button for 3 seconds to turn on the Direct function.

On the CR-515DAB, the [DIRECT] button's indicator lights up when the Direct function is on.

**Muting the Sound**

To mute the output of the CD receiver, press the remote controller's [MUTING] button.

The MUTING indicator flashes on the display.

On the CR-515DAB, the volume control indicator flashes, too.

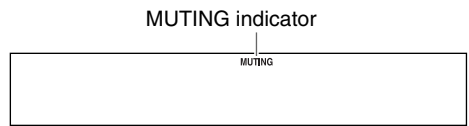

To unmute the CD receiver, press the [MUTING] button again.

- Tips:**
- While the CD receiver is muted:
- Turning the [VOLUME] control on the CD receiver or pressing the VOLUME [▲]/[▼] buttons on the remote controller will unmute the CD receiver.
  - If you turn the CD receiver off, the next time you turn it on, the CD receiver will be unmuted.

## Changing the Input Display

You can choose what name is displayed when an input source is selected so that it matches the type of component that you've connected to the MD/TAPE IN, DOCK/CDR IN, or DIGITAL IN. When you connect an Onkyo **RI**-capable component, it's important that you select the input source name that matches the type of component for **RI** to work properly.

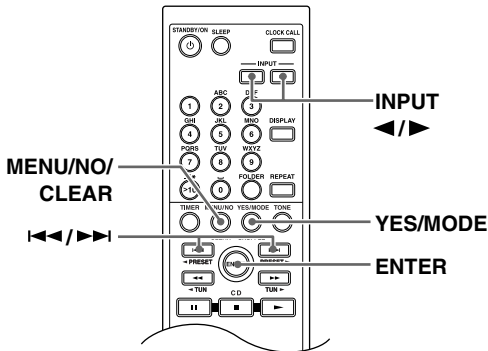

Depending on the input source selected in step 1, the input source names are selected in the following orders:

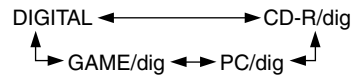

**1**

Use the **INPUT** [**◀**]/[**▶**] buttons to select the input source whose name you want to change.  
**CR-515DAB:** TAPE, DOCK, DIGITAL  
**CR-315DAB:** TAPE

**2**

Press and hold the [**MENU/NO/CLEAR**] button until “Name Select?” flashes on the display, and then press [**ENTER**].

Name Select?

**3**

Use the Previous or Next [**◀◀**]/[**▶▶**] button to select the new input source name.

M D

**4**

Complete

“Complete” appears on the display.

On the CR-515DAB, you can also use the front panel controls.

- 1 Use the [INPUT] button to select the input source whose name you want to change.
- 2 Push the multi control to select “Name Select?,” and then push it again.
- 3 Turn the multi control to select the new input source name.
- 4 Push the multi control to confirm your selection.

### Input Source Name Abbreviations

Sometimes the input source name may be displayed as a 2-letter abbreviation, as per the following table.

Full name	Abbreviation
CDR	CR
DAT	DT
DIGITAL	DG
GAME	GM
DOCK	DC
LINE	LI
LINE1	L1
LINE2	L2
MD	MD
PC	PC
TAPE	TP
VIDEO	VD

# Playing CDs

CR-515DAB

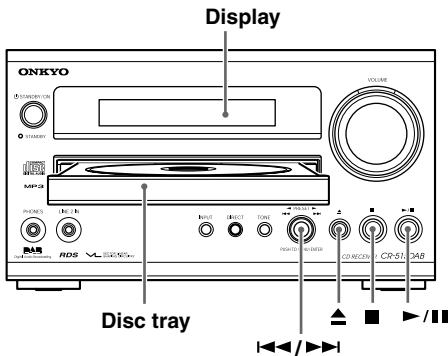

CR-315DAB

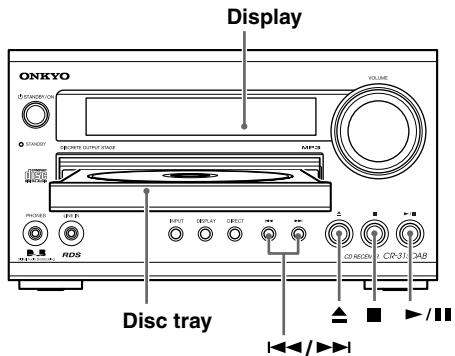

- 1**



**Press the Eject [▲] button to open the disc tray.**  
**Tip:**  
 Pressing the Eject [▲] button while the CD receiver is on Standby will turn on the CD receiver and open the disc tray.
- 2**

**Place the CD on the tray with the label-side facing up.**  
 Place 8 cm CDs in the center of the tray.
- 3**



**To start playback, press the Play/Pause [▶/||] button.**  
 The disc tray closes and playback starts.  
**To stop playback:**  
 Press the Stop [■] button. Playback stops automatically when the last track has been played.  
**To pause playback:**  
 Press the Play/Pause [▶/||] button. The Pause [||] indicator appears. To resume playback, press the Play/Pause [▶/||] button again.  
**To remove the CD:**  
 Press the Eject [▲] button to open the disc tray.

## Selecting Tracks (CR-515DAB)

To return to the beginning of the track currently playing, turn the multi control a little to the left.

Turn the multi control further to select earlier tracks.

- While playback is stopped, turn the multi control to the left to select the previous track.

Turn the multi control to the right to select subsequent tracks.

- On MP3 CDs, you can select MP3 files in other folders (see page 32).

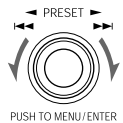

## Selecting Tracks (CR-315DAB)

To return to the beginning of the track currently playing, press the Previous [◀◀] button.

Press the Previous [◀◀] button repeatedly to select earlier tracks.

- While playback is stopped, pressing the Previous [◀◀] button will select the previous track.

Press the Next [▶▶] button repeatedly to select subsequent tracks.

- On MP3 CDs, you can select MP3 files in other folders (see page 32).

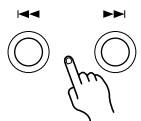

### • Audio CD Display

“DISC TOTAL” lights up while the disc information is being displayed.

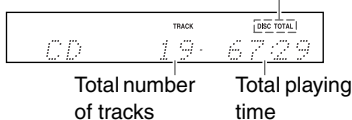

### • MP3 CD Display

Disc name

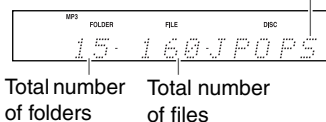

## Using the Remote Controller

Use the number buttons as shown in the examples below to select tracks.

To select: Press:

Track #8 8  
 Track #10 0  
 Track #34 <10> 3 4

<10> Used to enter numbers over 10.

With MP3 CDs, you can select files in the current folder with these buttons.

### Press to select tracks

- Press the Previous [◀◀] button to locate the beginning of the currently playing or paused track. Press it repeatedly to select earlier tracks.
- Press the Next [▶▶] button repeatedly to select subsequent tracks.

On MP3 CDs, you can select files in other folders (see page 32).

### Press to pause playback

To resume playback, press the Pause [⏸] or Play [▶] button.

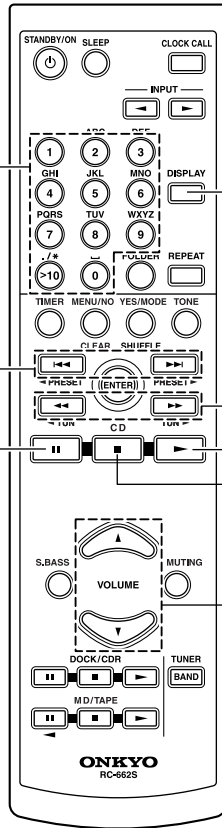

Press to display more CD information

### Press to fast forward or fast reverse

During playback or while playback is paused, press and hold the Fast Forward [▶▶] button to fast forward, or the Reverse [◀◀] button to fast reverse.

### Press to start playback

Pressing this button while the CD receiver is on Standby will turn on the CD receiver and start playback.

### Press to stop playback

### Press to adjust the volume

Press the VOLUME Up [▲] button to turn up the volume. Press the VOLUME Down [▼] button to turn it down.

## Displaying CD Information

During playback or while playback is paused, press the remote controller's [DISPLAY] button repeatedly to display the following CD information.

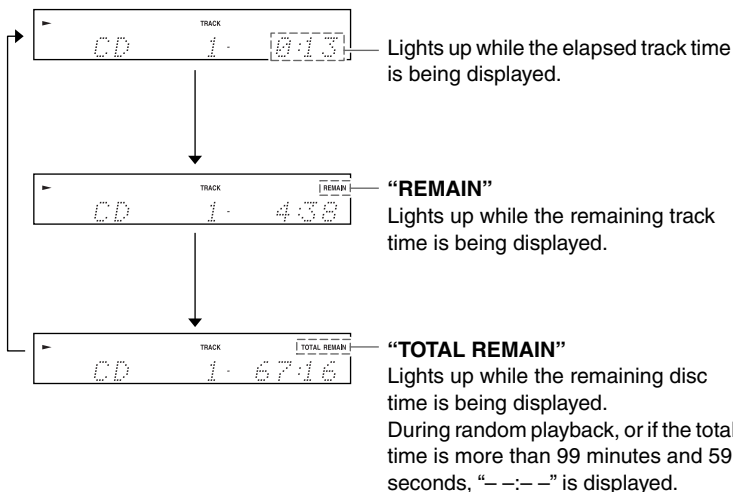

### Note:

See page 34 for details on displaying MP3 information.

On the CR-315DAB, you can also use the CD receiver's [DISPLAY] button to display this information.

## Selecting MP3 Files

On an MP3 CD, MP3 files may be organized in a hierarchically, with folders containing files and subfolders, as shown below. On the CD receiver, there are two modes for selecting MP3 files: *Navigation mode* and *All Folder mode*. In Navigation mode, you can select MP3 files by navigating through the folder hierarchy, moving in and out of folders and subfolders. In All Folder mode, all folders appear at the same level, making it easy to select folders regardless of the hierarchy.

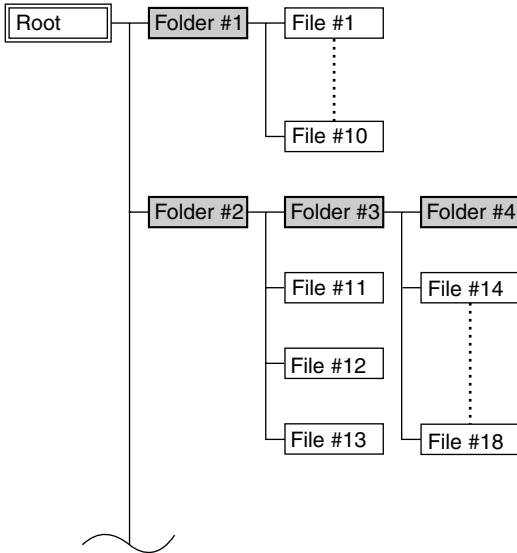

If you don't select a specific MP3 file or folder for playback, all of the MP3 files on the CD will be played in numerical order starting with file #1.

## Selecting MP3 Files in Navigation Mode

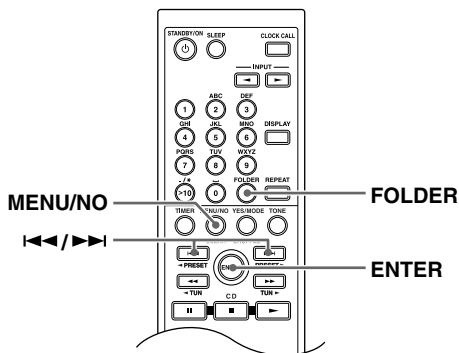

With Navigation mode, you can select MP3 files by navigating through the folder hierarchy. This mode can only be used while playback is stopped.

If random mode or 1-folder mode is currently selected, press the [YES/MODE] button to cancel it before proceeding.

- 1**

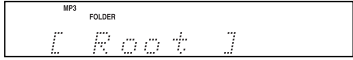

**While playback is stopped, press the [FOLDER] button.**

The CD receiver enters Navigation mode and "Root" appears on the display.



- 2**

**Press [ENTER].**

The name of the first folder one level down from root appears on the display.

If the disc contains no folders, the name of the first MP3 file is displayed.
- 3**

**Use the Previous and Next [◀◀]/[▶▶] buttons to select other folders and files at the same level.**

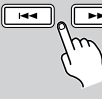

Folders that don't contain MP3 files or subfolders can't be selected.
- 4**

**To access files or subfolders inside another folder, select the folder, and then press [ENTER].**

Use the Previous and Next [◀◀]/[▶▶] buttons to select the files and subfolders within that folder.

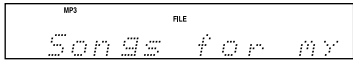
To move up a level, press the [MENU/NO] button.
- 5**

**To start playback, press the [ENTER] or Play/Pause [▶/||] button.**



Playback will start with the specified file or folder and continue until all of the MP3 files on the disc have been played.

On the CR-515DAB, you can also use the multi control for steps 2, 3, and 4. Turn the multi control to select files and folders, and push it for ENTER.



Selecting MP3 Files in All Folder Mode

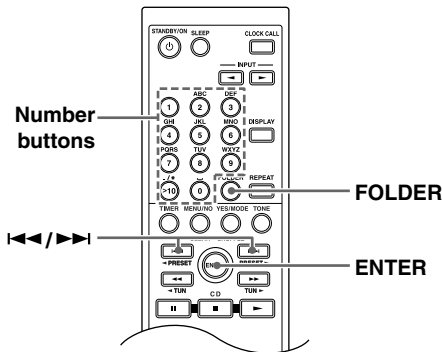

With All Folder mode, you don't have to navigate the folder hierarchy because all folders that contain MP3 files appear at the same level.

If random playback is currently selected, press the [YES/MODE] button to cancel it before proceeding.

**1**



**FOLDER**

**While playback is stopped, press the [FOLDER] button for 2 seconds.**

The CD receiver enters All Folder mode and the name of the first folder appears on the display.

MP3 FOLDER  
*My Favori*

**2**

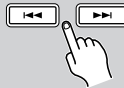

**Use the Previous and Next [◀◀]/[▶▶] buttons to select the other folders.**

You can select any folder that contains MP3 files.

To play the first file in the selected folder, go to Step 4.

**3**

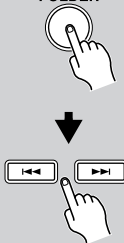

**FOLDER**

**To access the files inside the folder, press the [FOLDER] button.**

The name of the first MP3 file inside the folder is displayed.

Use the Previous and Next [◀◀]/[▶▶] buttons to select the MP3 files within the folder.

MP3 FOLDER FILE  
 5 3 Song

To select another folder, press the [FOLDER] button again, and then use the Previous and Next [◀◀]/[▶▶] buttons to select it.

**4**



**To start playback, press the [ENTER] or Play/Pause [▶/||] button.**

Playback will start with the specified file or folder and continue until all of the MP3 files on the disc have been played.

On the CR-515DAB, you can also use the multi control for steps 2, 3, and 4. Turn the multi control to select files and folders, and push it for ENTER.

To select an MP3 file in another folder during playback, press the [FOLDER] button, select the folder by using the Previous and Next [◀◀]/[▶▶] buttons (or multi control), and then press [ENTER] (or push the multi control). Now use the Previous and Next [◀◀]/[▶▶] buttons (or multi control) to select the MP3 files within that folder.

**■ Pausing Playback**  
 To pause playback, press the Play/Pause [▶/||] button. To resume playback, press it again.

**■ Cancelling Navigation or All Folder Mode**  
 To cancel Navigation mode or All Folder mode while selecting MP3 files, press the Stop [■] button.

**■ Selecting MP3 Folders and Files by Number**

- 1 Press the [FOLDER] button for 2 seconds to enter All Folder mode.
- 2 Use the number buttons as shown in the examples below to enter folder numbers.

To select:	Press:
Folder #8	[8]
Folder #10	[0]
Folder #34	[>10] [3] [4]

[>10] Used to enter numbers over 10.

If playback is stopped, playback starts with the first MP3 file in the specified folder. If playback is already in progress, press [ENTER] to play the first MP3 file in the specified folder.

- 3 Use the number buttons to enter the file number. Playback starts. If a folder contains more than 99 MP3 files, single- and double-digit file numbers must be preceded by zeros. For example, to specify file #5, press [5]. To specify file #32, press [>10], [3], and [2].

Playing the MP3 Files in Only One Folder

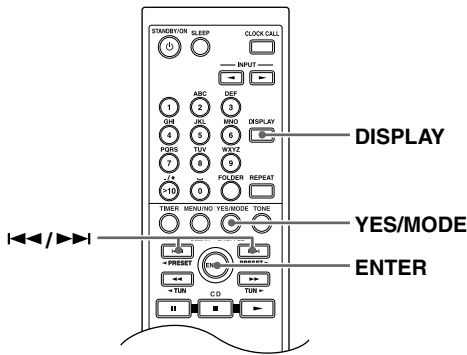

Normally, all of the MP3 files in all of the folders on the disc are played. With 1-folder playback, only the MP3 files in the specified folder are played.

- 1** **YES/MODE**



**Press the [YES/MODE] button repeatedly until the 1FOLDER indicator appears.**

1FOLDER indicator

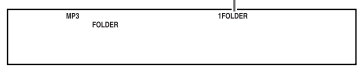
- 2**

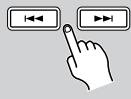

**Use the Previous and Next [◀] / [▶] buttons to select the folder.**

You can select any folder that contains MP3 files.
- 3**



**To start playback, press the [ENTER] or Play/Pause [▶/||] button.**

Playback will start with the first MP3 file in the specified folder and continue until all of the MP3 files in that folder have been played.

Displaying MP3 Information

You can display various information about the MP3 file currently playing, including ID3 tags such as title, artist name, and album name.

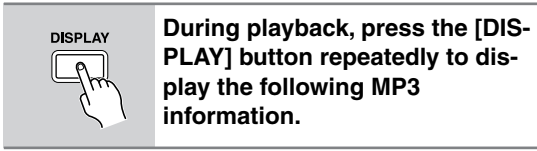

**During playback, press the [DISPLAY] button repeatedly to display the following MP3 information.**

**Elapsed time:** The length of time that the current MP3 file has been playing (default display). If the elapsed time is more than 99 minutes and 59 seconds, “--:--” is displayed.

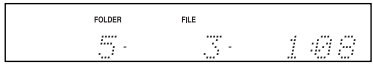

**File name:** Name of the current MP3 file.

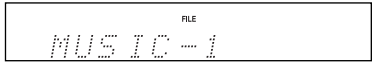

**Folder name:** Name of the current folder.

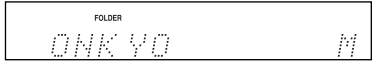

**Title name:** Title of the current file (if ID3 tag present).

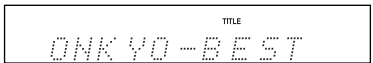

**Artist name:** Name of the artist (if ID3 tag present).

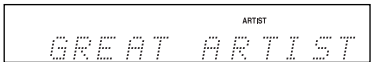

**Album name:** Name of the album (if ID3 tag present).

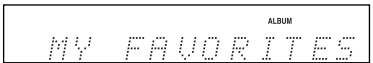

**Sampling rate and bit rate:** Sampling rate and bit rate of the current MP3 file.

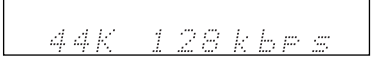

- Notes:**
- On the CR-315DAB, you can also use the CD receiver’s [DISPLAY] button to display this information.
  - To display the disc name, press the [DISPLAY] button while playback is stopped.
  - If a file or folder name contains a character that cannot be displayed, it will be displayed as “FILE n” or “FOLDER n,” “n” being the file or folder number. You can set the CD receiver so that it displays underscore characters in place of any undisplayable characters (see page 37).

## Memory Playback

With memory playback, you can create a playlist of up to 25 tracks.

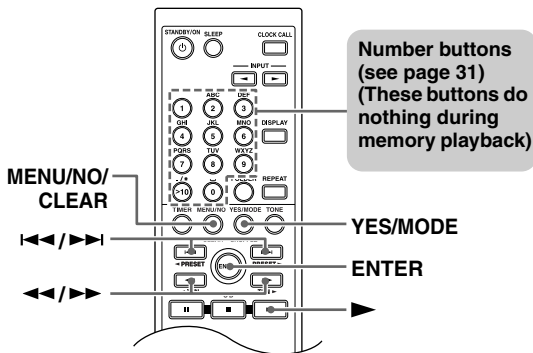

Memory playback can be set only when the input source is set to CD and playback is stopped.

**1**

YES/MODE



Press the [YES/MODE] button repeatedly until the MEMORY indicator appears.

MEMORY indicator

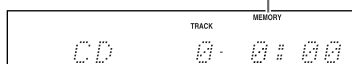

**2**



Use the Previous and Next [◀]/[▶] buttons to select the first track you want to add to the playlist, and then press [ENTER].

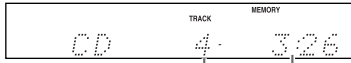
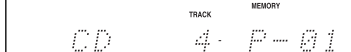

Track to be added to the playlist      Total time of playlist

Repeat this step to add additional tracks to the playlist.

You can also use the number buttons on the remote controller to select tracks.

On the CR-515DAB, you can also use the multi control to add tracks to the playlist. Turn the multi control to select a track, and then push it for ENTER.

**To select MP3 files for memory playback:**

In Navigation mode, use steps 1–4 on page 32. In All Folder mode, use steps 1–4 on page 33.

**To remove tracks from the playlist:**

Press the [CLEAR] button. Each press removes the last track from the playlist.

**Notes:**

- If the total playing time is more than 99 minutes and 59 seconds, “--:--” is displayed.
- You can add up to 25 tracks to the playlist. If you try to add more, the message “Memory Full” appears.

**3**

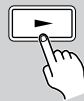

To start memory playback, press the Play [▶] button.



Track currently playing

On the CD receiver, press the Play/Pause [▶/||] button to start memory playback.

**Selecting Other Tracks During Memory Playback**

To select other playlist tracks during memory playback, use the remote controller’s Previous and Next [◀]/[▶] buttons.

**Checking What’s on the Playlist**

To check what tracks are on the playlist, with playback stopped, use the Fast Reverse and Fast Forward [◀◀]/[▶▶] buttons to scroll through the playlist.

**Removing Tracks from the Playlist**

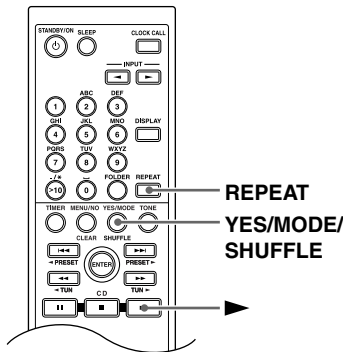

- While memory playback is stopped, press the [CLEAR] button. Each press removes the last track from the playlist.
- The playlist will be deleted when you cancel memory playback, select random playback, turn off the CD receiver, or remove the CD.



### Random Playback

With random playback, all of the tracks on the disc are played in random order.

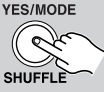
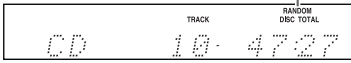
Random playback can be set only when the input source is set to CD and playback is stopped.

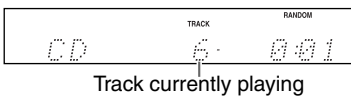

<b>1</b>	<p>Press the [YES/MODE/SHUFFLE] button repeatedly until the <b>RANDOM</b> indicator appears.</p>  <p style="text-align: center;">RANDOM indicator</p> 
<b>2</b>	<p>To start random playback, press the Play [▶] button.</p>   <p style="text-align: center;">Track currently playing</p>

#### Canceling Random Playback

- To cancel random playback, press the [SHUFFLE] button repeatedly until the RANDOM indicator disappears.
- Random playback is cancelled when the CD is removed or the CD receiver is set to Standby.

### Repeat Playback

With repeat playback, you can play an entire CD repeatedly, play one track repeatedly, or combine it with memory playback to play the playlist repeatedly, or random playback to play all of the tracks on the disc in random order repeatedly. With an MP3 CD, you can combine repeat playback with 1-folder playback to play all of the tracks in a specified folder repeatedly.

<b>1</b>	<p>Press the [REPEAT] button repeatedly until the REPEAT or REPEAT 1 indicator appears.</p>  <p style="text-align: center;">REPEAT or REPEAT 1 indicator</p> 
----------	--

Repeat-1 playback can't be combined with memory playback, random playback, or 1-Folder playback.

#### Canceling Repeat Playback

- To cancel repeat playback, press the [REPEAT] button repeatedly until both the REPEAT and REPEAT 1 indicators disappear.
- Repeat playback is cancelled when the CD is removed or the CD receiver is set to Standby.

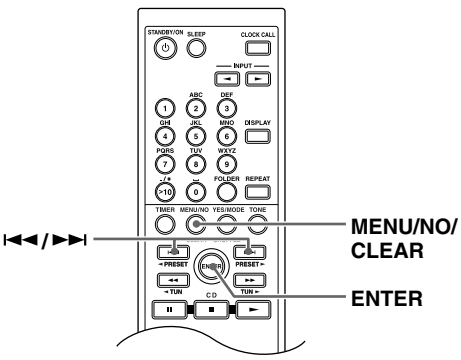

### Setting MP3 Preferences

With the MP3 preferences, you can change the way MP3 file information is displayed and the way MP3 CDs are played.

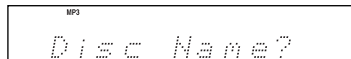
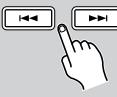

The MP3 preferences can be set only when playback is stopped.

<b>1</b>	<p>Press the [MENU/NO] button repeatedly until "Disc Name?" appears.</p>  
<b>2</b>	<p>Use the Previous and Next [◀] [▶] buttons to select the preference you want to change.</p>  <p>The preferences are explained in the next column.</p>

<b>3</b> 	<b>Press [ENTER].</b>
<b>4</b> 	<b>Use the Previous and Next [◀] [▶] buttons to select the preference's options.</b>
<b>5</b> 	<b>Press [ENTER].</b> When the preference has been set, "Complete" appears on the display.

To cancel the procedure at any point, press the [MENU/NO] button.

### Preferences

Below, the name of each preference is followed by its options in parentheses, with the default option in bold.

#### Disc Name? (Display/Not Display)

This preference determines whether or not the disc name is displayed when an MP3 disc is loaded.

#### File Name? (Scroll/Not Scroll)

This preference determines whether or not the file name scrolls across the display when an MP3 file is selected. In Navigation mode (see page 32), the file name scrolls across the display regardless of this setting.

#### Folder Name? (Scroll/Not Scroll)

This preference determines whether or not the folder name scrolls across the display when an MP3 folder is selected (in All Folder mode).

In Navigation mode (see page 32), the folder name scrolls across the display regardless of this setting.

#### Bad Name? (Replace/Not Replace)

This preference determines whether or not file and folder names that contain undisplayable characters are replaced with "FILE n" or "FOLDER n," "n" being the file or folder number. When set to Not Replace, displayable characters are displayed and underscore characters are used in place of any undisplayable characters.

For ID3 tags, underscore characters are used in place of undisplayable characters regardless of this preference.

#### ID3 Ver. 1? (Read/Not Read)

This preference determines whether or not version 1.0/1.1 tags are read and displayed. When set to Not Read, version 1.0/1.1 tags are not displayed.

#### ID3 Ver. 2? (Read/Not Read)

This preference determines whether or not version 2.2/2.3/2.4 tags are read and displayed. When set to Not Read, version 2.2/2.3/2.4 ID3 tags are not displayed.

#### CD Extra? (Audio/MP3)

This preference applies to CD Extra discs and determines whether music in the audio session or MP3 files in the data session are played.

#### Joliet? (Use SVD/ISO9660)

This preference applies to MP3 discs in Joliet format and determines whether the CD receiver reads the SVD data or treats the disc as an ISO 9660 disc. Normally, this preference doesn't need to be changed.

SVD (Supplementary Volume Descriptor) supports long file and folder names and characters other than letters and numbers. Some CD burning software refers to the Joliet format as "Windows format."

#### Hide Number? (Disable/Enable)

This preference determines whether or not the numbers at the beginning of file and folder names are displayed.

When you create an MP3 CD on a personal computer, you cannot normally determine the playback order of the files. However, if you number the MP3 files in order, starting with 01, 02, 03, and so on, they will play in that order. If you don't want these numbers to appear on the display, choose Not Display.

The following table shows a few examples of numbered file and folder names and how they will appear with the Display and Not Display options.

File/folder name	Trk/Fld Num Option	
	Display	Not Display
01 Pops	01 Pops	Pops
10-Rock	10-Rock	Rock
16_Jazz	16_Jazz	Jazz
21th Century	21th Century	21th Century
05-07-20 Album	05-07-20 Album	Album

#### Folder Key? (All Folder/Navigation)

This preference determines how the [FOLDER] button works. When the All Folder option is selected, pressing the [FOLDER] button once selects All Folder mode and pressing and holding it for 2 seconds selects Navigation mode. When the Navigation option is selected, pressing the [FOLDER] button once selects Navigation mode and pressing and holding it for 2 seconds selects All Folder mode.

# Listening to the Radio

## Tuning into FM/AM Radio Stations

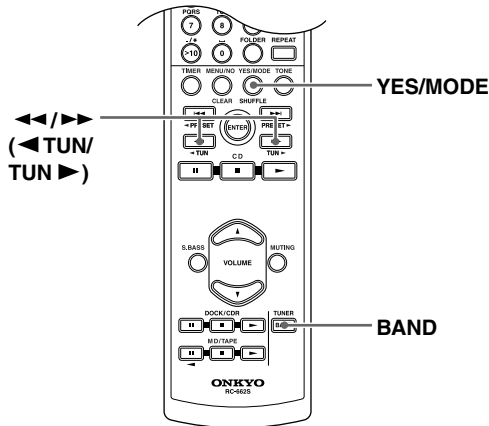

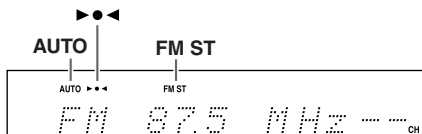

When tuned into a station, the Tuned ►●◄ indicator appears. When tuned into a stereo FM station, the FM ST indicator appears as well.



### Tuning into weak stereo FM stations

If the signal from a stereo FM station is weak, it may be impossible to get good reception. In this case, switch to Manual Tuning mode and listen to the station in mono.

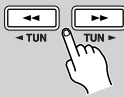
<b>1</b>	 <p>Press the [BAND] button repeatedly to select AM or FM.</p>
<b>2</b>	 <p>Press the [YES/MODE] button repeatedly to select Auto or Manual.</p> <ul style="list-style-type: none"> <li>• <b>Auto Tuning Mode</b> The AUTO indicator appears and stereo radio reception is possible.</li> <li>• <b>Manual Tuning Mode</b> The AUTO indicator is not displayed and radio reception will be in mono.</li> </ul> <p style="text-align: center;">AUTO indicator</p> 
<b>3</b>	 <p>Use the Fast Reverse and Fast Forward [◀◀]/[▶▶] buttons to tune into a station.</p> <p>In Auto tuning mode, once a station is found, tuning stops automatically. The American model changes FM frequency in 0.2 MHz steps, 10 kHz steps for AM. For other models it's 0.05 MHz steps for FM and 9 kHz or 10 kHz steps for AM.</p> <p>In Manual Tuning mode, the frequency stops changing when you release the button. Press the button repeatedly to change the frequency one step at a time.</p>

## Adjusting the Antennas

### Adjusting and installing the FM antenna

Choose a location for the FM antenna while listening to an FM station.

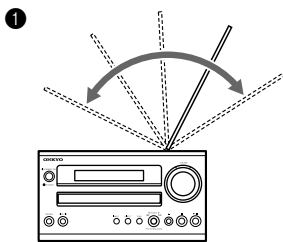

Change the direction of the antenna to achieve the best reception.

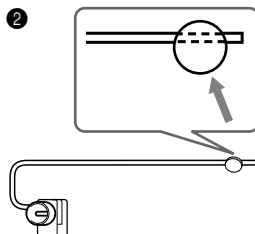

Affix the antenna with a thumbtack. (Do not push the thumbtack through the antenna.)

**Caution:** Be careful not to prick your finger!

### Adjusting the AM antenna

Adjust the location and position of the AM antenna while listening to an AM station to achieve the best reception.

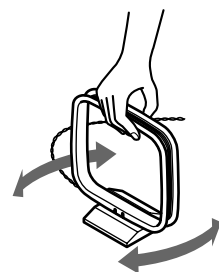

Displaying Radio Information

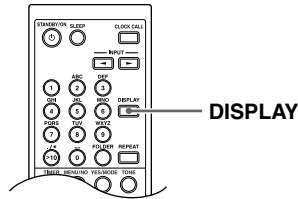

Press the remote controller's [DISPLAY] button repeatedly to display more radio information. On the CR-315DAB, you can also use the CD receiver's [DISPLAY] button to display this information.

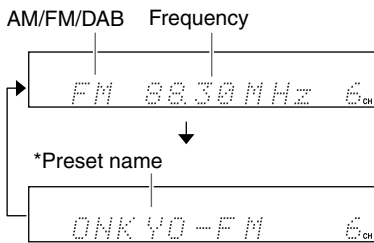

\* If the selected preset has no name, "No Name" appears briefly and then the frequency is displayed. See "Naming Presets" on page 46.

Receiving RDS



Press the [DISPLAY] button repeatedly to display the following RDS information.

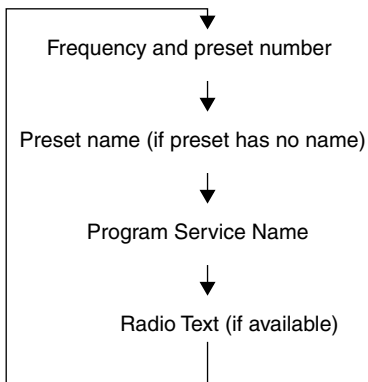

RDS is only available on European models and only in areas where RDS broadcasts are available.

What is RDS?

RDS stands for *Radio Data System* and is a method of transmitting data in FM radio signals. It was developed within the European Broadcasting Union (EBU) and many European FM radio stations use it these days. The CD receiver supports and displays the Program Service Name (PS) and Radio Text (RT) types of RDS data. The RDS indicator appears on the display when the CD receiver is tuned to an FM station that supports RDS.

Notes:

- If the signal from an RDS station is weak, RDS data may be displayed intermittently or not at all.
- The message "Waiting..." may appear while the RT data is being received.

## Listening to DAB Digital Radio

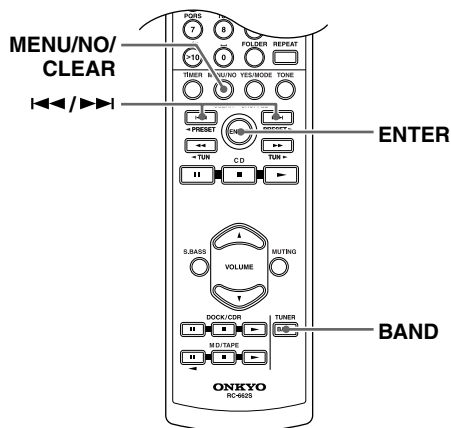

**Press the [BAND] button repeatedly to select DAB.**

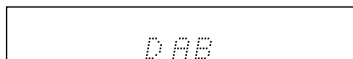

When tuned into a DAB station, the Tuned ►◀ indicator appears and the DAB indicator as well.

Tuned indicator  
DAB indicator

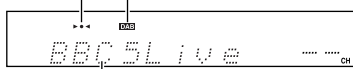

Station name

On the front panel, press the [INPUT] repeatedly to select DAB.

### Selecting DAB for the Very First Time

The very first time you select DAB, the Auto Tuning function automatically scans the DAB Band III and L-Band for the multiplexes (i.e., stations) available in your area.

Once the scanning process is complete, the first station that was detected is selected.

### Using the Auto Tuning Function Manually

If a new DAB station is introduced, or you move to a new area, you can run the Auto Tuning function again.

- 1 Press the [MENU/NO] button.
- 2 Use the Previous and Next [◀] / [▶] buttons to select “Auto Tuning?” and then press [ENTER].
- 3 Use the Previous and Next [◀] / [▶] buttons to select Worldwide or U.K., (see “Auto Tuning?” on page 42), and then press [ENTER] to start the Auto Tuning function.

The number of stations found and the scanning progress are shown on the display.

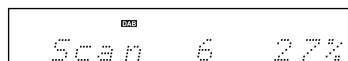

To cancel Auto Tuning, press the [ENTER], [MENU/NO/CLEAR] or [YES/MODE] button.

**On the CR-515DAB, you can also use the front panel controls.**

- 1 Push the multi control.
- 2 Turn the multi control to select “Auto Tuning?” and then push it.
- 3 Turn the multi control to select Worldwide or U.K., and then push it to start the Auto Tuning function.

To cancel Auto Tuning, push the multi control.



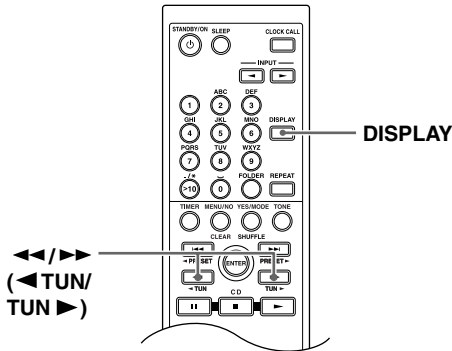

## Selecting DAB Stations

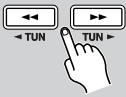

Use the Fast Reverse and Fast Forward [◀◀]/[▶▶] buttons to select the DAB stations.

If a secondary service is available, a right angle bracket (>) is displayed. Press [▶▶] to listen to the secondary service.

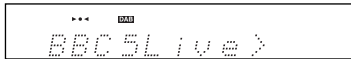

While the secondary service is selected, a left angle bracket (<) is displayed. Press [◀◀] to return to the primary service.

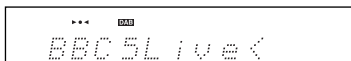

When you select a station that you've selected a lot in the past, the letter *F* (short for *Favorite*) is displayed.

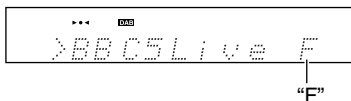

If you select a station that cannot be received properly, a question mark (?) is displayed.

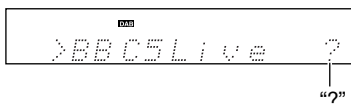

- On the CR-515DAB, you can also use the multi control to select DAB stations.
- On the CR-315DAB, you can also use the Previous and Next [◀◀] or [▶▶] buttons to select DAB stations.

- Once a DAB station has been preset, these front panel controls will select presets, in Preset mode. To use them to select DAB stations, select DAB as the input source, and then press the Stop [■] button for 3 seconds until “Station Mode” appears on the display.

## Displaying DAB Radio Information

Press the remote controller's [DISPLAY] button repeatedly to display more information about the selected DAB station.

On the CR-515DAB, you can also use the CD receiver's [DISPLAY] button to display this information.

### 1. DLS (Dynamic Label Segment)

When tuned to a station that's broadcasting DLS text data, the text will scroll across the display.



### 2. Program Type

Displays the type of program.

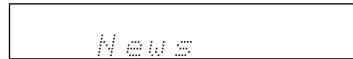

### 3. Bit Rate and Audio Mode

Displays the station's bit rate and audio mode (stereo, mono, or joint stereo).

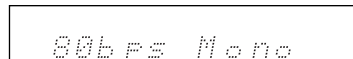

### 4. Signal Quality

Displays the signal quality.

0–59: Poor reception

60–79: Good reception

80–100: Excellent reception

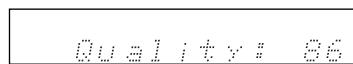

### 5. Multiplex Name

Displays the name of the current multiplex.

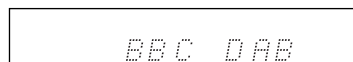

### 6. Multiplex Number and Frequency

Displays the number and frequency of the current multiplex.

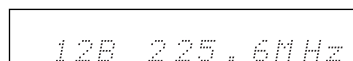

## DAB Setup

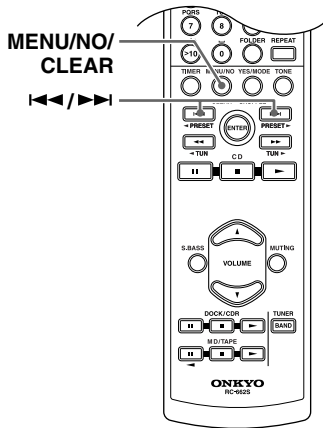

Use the following functions and settings to set up DAB digital radio.

<b>1</b>	<b>Press the [MENU/NO] button.</b>
<b>2</b>	<b>Use the Previous and Next [◀◀]/[▶▶] buttons to select the item you want to set, and then press [ENTER].</b>
	The items are explained below.

### ■ Preset Write?

Select this to preset the current DAB station. See “Presetting AM/FM/DAB Stations Manually” on page 44 for more information.

### ■ Tuning Mode?

With this setting, you can sort the available stations alphabetically, by multiplex, favorites, or active stations. Use the Previous and Next [◀◀]/[▶▶] buttons to select the following options, and then press [ENTER].

**Alphabet** (default): Sort stations alphabetically.

**Multiplex**: Sort stations by multiplex.

**Favorite**: Sort stations by favorites. The stations you select the most will appear at the top of the list.

**Active St**: Sort by active stations. Receivable stations appear at the top of the list. stations that cannot be received properly appear at the bottom of the list.

### ■ Trim Station?

With this function, you can delete all of the stations that cannot be received properly.

### ■ Auto Tuning?

This setting determines which DAB bands are scanned by the Auto Tuning function (see page 40).

**UK**: Band III (11B–12D).

**Worldwide** (default): Band III (5A–13F) and L-Band (LA–LW).

### ■ DRC Setting?

With the DRC (Dynamic Range Control) setting, you can reduce the dynamic range of DAB digital radio so that you can still hear quiet parts even when listening at low volume levels—ideal for listening to the radio late at night when you don’t want to disturb anyone.

Use the Previous and Next [◀◀]/[▶▶] buttons to select the following options, and then press [ENTER].

**0** (default): DRC off.

**1/2**: Small reduction in dynamic range.

**1**: Large reduction in dynamic range.

### ■ Tuning Aid?

With the Tuning Aid, you can adjust the position and direction of the DAB antenna while monitoring the signal strength on the display. If the letter “B” appears on the display, it means the signal strength is Bad. If the letter “G” appears, it means the signal strength is Good. To make the letter “G” appear, adjust the antenna to get the best signal strength.

Use the Previous and Next [◀◀]/[▶▶] buttons to select other multiplexes (Band III: 5A–13F or L-Band: LA–LW).

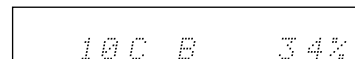

## Presetting FM Stations Automatically (Auto Preset)

With the Auto Preset function, you can automatically preset all of the FM radio stations available in your area in one go. Presets make it easy to select your favorite stations and eliminate the need to tune the radio manually each time you want to change stations. The Auto Preset function does not preset AM radio stations (see page 44).

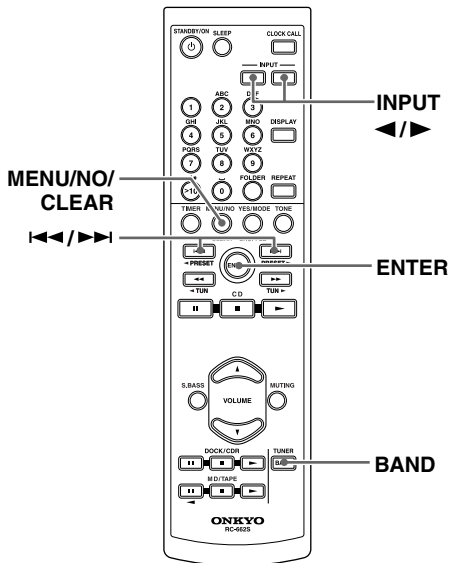

**Auto Preset Caution!**  
Any existing presets will be deleted when the Auto Preset function is run.

<b>1</b>	<p>Press the [BAND] or INPUT [◀/▶] buttons repeatedly until "FM" appears.</p> <p>or</p> <p>Make sure the FM antenna is positioned to achieve the best possible reception.</p>
<b>2</b>	<p>Press the [MENU/NO] button, and then use the Previous and Next [◀◀]/[▶▶] buttons to select "AutoPreset?"</p>
<b>3</b>	<p>Press [ENTER]. The confirmation message "AutoPreset??" appears.</p> <p>To cancel the Auto Preset function at this point, press the [MENU/NO] button.</p>

<b>4</b>	<p>To start the Auto Preset function, press [ENTER].</p> <p>Up to 20 stations can be preset and presets are stored in frequency order.</p>
----------	--

**Note:**  
Depending on your location, a preset may be stored with no station and you will hear only noise when you select it. In this case, delete the preset (see page 48).

**On the CR-515DAB, you can also use the front panel controls.**

- 1 Press the [INPUT] button repeatedly until "FM" appears.
- 2 Push the multi control, and then turn it to select "AutoPreset?"
- 3 Push the multi control. The confirmation message "AutoPreset??" appears.
- 4 To start the Auto Preset function, push the multi control.

**After Storing Presets You Can:**

- Select them (see page 45)
- Name them for easy identification (see page 46)
- Copy them (see page 47)
- Erase them (see page 48)

## Presetting AM/FM/DAB Stations Manually

With the Preset Write function, you can manually preset individual AM, FM, and DAB radio stations. Presets make it easy to select your favorite stations and eliminate the need to tune the radio manually each time you want to change stations. FM stations can also be preset automatically (see page 43).

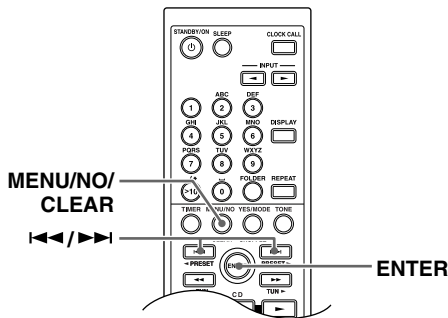

### About Presets

- You can store up to 40 FM, AM and DAB stations as presets and this can be any combination. For example, 27 FM and 13 AM or 20 FM, 12 AM and 8 DAB.
- Although AM, FM, and DAB presets share the same numbers, they're selected independently. For example, preset #1 will store an AM station when the AM band is selected, and an FM station when the FM band is selected.
- Stations can be stored to presets in any order. For example, you could store preset #5 first, #1 second, and so on.

<b>1</b>	<p><b>Tune into the station that you want to store as a preset.</b></p>
<b>2</b>	<p>Press the [MENU/NO] button, and then use the Previous and Next [◀] / [▶] buttons to select "Preset Write?"</p>
<b>3</b>	<p>Press [ENTER].</p> <p>The preset number flashes. To cancel the Preset Write function at this point, press the [MENU/NO] button.</p>
<b>4</b>	<p>Use the Previous and Next [◀] / [▶] buttons to select a preset.</p>
<b>5</b>	<p>To store the station, press [ENTER].</p> <p>If no station has yet been stored to the selected preset, "Complete" appears and the station is stored.</p> <p>If a station has already been stored in the selected preset, the message "Overwrite?" appears.</p>

<b>6</b>	<p>To overwrite the previously stored station, press the [YES/MODE] button.</p> <p>To not overwrite the previously stored station, press the [MENU/NO] button.</p> <p>If the message "Memory Full" appears, all 40 presets have been stored and you'll need to erase some presets before you can store any more stations (see page 48).</p>
<p>Repeat steps 1 to 5 to preset more radio stations.</p>	

**On the CR-515DAB, you can also use the front panel controls.**

- 1 Tune into the station you want to store as a preset (see page 38).
- 2 Push the multi control, and then turn it to select "PresetWrite?"
- 3 Push the multi control.
- 4 Turn the multi control to select a preset.
- 5 To store the station, push the multi control.

### Note:

If the current FM station supports RDS and PS (Program Service Name), the station's name will be displayed instead of the frequency. (See page 39 for more on RDS.)

### After Storing Presets You Can:

- Select them (see page 45)
- Name them for easy identification (see page 46)
- Copy them (see page 47)
- Erase them (see page 48)

## Selecting Preset Stations

You must store some presets before you can select them (see pages 43 and 44).

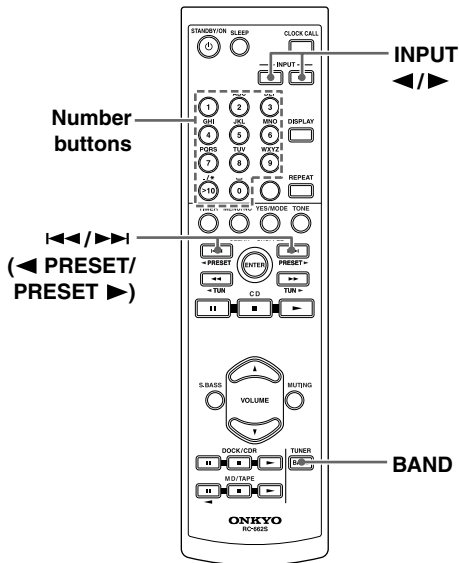

You can also use the number buttons as shown in the examples below to select presets.

To select:      Press:

Preset #8      [8]

Preset #10     [0]

Preset #22     [>10] [2] [2]

[>10] Used to enter numbers over 10.

On the CR-515DAB, you can also use the front panel controls.

- 1 Use the [INPUT] button to select AM, FM, or DAB.
- 2 To select DAB stations, press the Stop [■] button for 3 seconds until “Preset Mode” appears on the display.
- 3 Turn the multi control to select a preset.

On the CR-315DAB, you can also use the front panel controls.

- 1 Use the [INPUT] button to select AM, FM, or DAB.
- 2 To select DAB stations, press the Stop [■] button for 3 seconds until “Preset Mode” appears on the display.
- 3 Use the Previous and Next [◀] / [▶] buttons to select a preset.

1



or

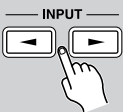

Use the [BAND] or INPUT [◀]/[▶] buttons to select AM, FM, or DAB.

The preset you selected the last time you listened to the radio will still be selected.



2

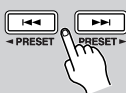

or



Use the Previous and Next [◀] / [▶] buttons to select a preset.

Press the Previous [◀] button to select the previous preset. Press the Next [▶] button to select the next preset.

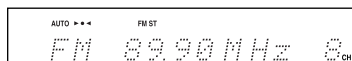

## Naming Presets

You can name presets for easy identification. The preset name may contain up to eight characters.

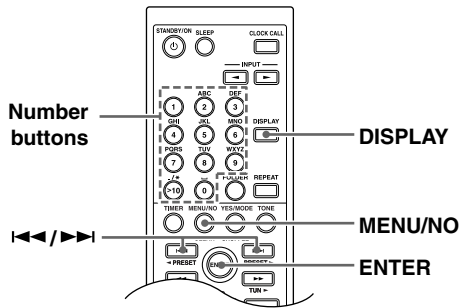

<b>1</b>	<b>Select the preset you want to name (see page 45).</b>
<b>2</b> <small>MENU/NO</small>	<p>Press the [MENU/NO] button, and then use the Previous and Next [◀]/[▶] buttons to select “Name In?”</p>
<b>3</b>	<p>Press [ENTER].</p>
<b>4</b> <small>DISPLAY</small>	<p>Press the [DISPLAY] button repeatedly to select one of the following character groups:</p> <ul style="list-style-type: none"> <li>• “A” for uppercase letters.</li> <li>• “a” for lowercase letters.</li> <li>• “1” for numbers and symbols.</li> </ul> <p style="text-align: center;">Character group</p>
<b>5</b>	<ul style="list-style-type: none"> <li>• <b>Selecting letters:</b> Press the number buttons repeatedly to select the available letters. For example, press the [2] button repeatedly to select: A, B, or C.</li> <li>• <b>Selecting numbers and symbols:</b> Use the number buttons to select numbers. Press the [&gt;10] button repeatedly to select: ␣ (space) . / * - , ! ? &amp; ' ( ) Press the [0] button repeatedly to select: 0 or ␣ (space)</li> </ul>

### Note:

Not all of the symbols can be entered by using the number buttons. Use the Previous and Next [◀] or [▶] buttons to select from the full range of symbols.

**When you’ve selected the character you want, press [ENTER], and then choose the next character.**

- **Editing characters:**  
To change or delete a character you’ve already entered, use the Rewind and Fast Forward [◀◀]/[▶▶] buttons to select it, and then select another character, or press the [CLEAR] button to delete it.
- **Inserting a new character:**  
To insert a new character, use the Rewind and Fast Forward [◀◀]/[▶▶] buttons to select the character immediately after the insertion point. That character flashes. Use the Previous and Next [◀] or [▶] buttons to select “#,” press [ENTER], and then select the new character.

To cancel the Name In function, press the [MENU/NO] button for 2 seconds.

<b>6</b> <small>YES/MODE</small>	<p>When you’ve finished entering the name, press the [YES/MODE] button.</p> <p>The preset is named and “Complete” appears on the display.</p>
-------------------------------------	---

**On the CR-515DAB, you can also use the front panel controls.**

- 1 Select the preset you want to name (see page 45).
- 2 Push the multi control, and then turn it to select “Name In?”
- 3 Push the multi control.
- 4 Turn the multi control to select a character, and then push it.
- 5 Repeat step 4 to enter up to 8 characters.

Use the remote controller’s [DISPLAY] button to select the character groups.

### Available Characters

A B C D E F G H I J K L M N O P Q R S T U V W X Y Z  
 a b c d e f g h i j k l m n o p q r s t u v w x y z  
 0 1 2 3 4 5 6 7 8 9  
 \_ @ ' < > # \$ % & \* = ; : + - / ( ) ?  
 ! ' " , . ␣(space) # (insert)

## Copying Presets

With the Preset Copy function, you can organize your presets in the order you want. When you copy a preset, its name is also copied.

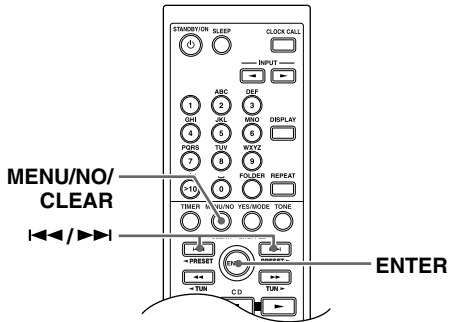

**1** Select the preset you want to copy (see page 45).



**2** Press the [MENU/NO] button, and then use the Previous and Next [◀]/[▶] buttons to select “PresetCopy?”

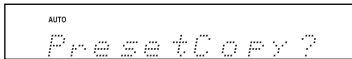
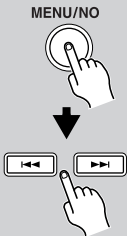

**3** Press [ENTER].

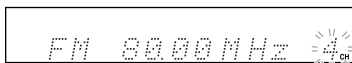

The number of the preset to be copied flashes.

**4** Use the Previous and Next [◀]/[▶] buttons to select the destination preset.

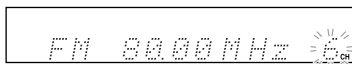
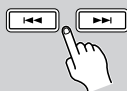

The number of the destination preset flashes.

**5**

To copy the preset, press [ENTER].

If no station has yet been stored in the destination preset, the station is copied and “Complete” appears.

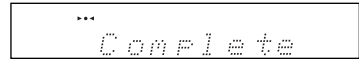

MENU/NO



If a station has already been stored in the destination preset, the message “Overwrite?” appears.

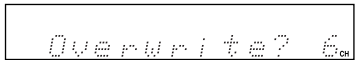

To overwrite the previously stored station, press [ENTER].

To not overwrite the previously stored station, press the [MENU/NO] button.





On the CR-515DAB, you can also use the front panel controls.

- 1 Select the preset you want to copy (see page 45).
- 2 Push the multi control, and then turn it to select “PresetCopy?”
- 3 Push the multi control.
- 4 Turn the multi control to select the destination preset.
- 5 To copy the preset, push the multi control.

**Tip:**

If your favorite station is stored in preset #5 and you want to make it preset #1, copy preset #5 to preset #1. To keep the station that’s already stored in preset #1, you may want to copy it to an unused preset first.

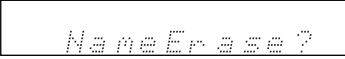
## Erasing a Preset's Name





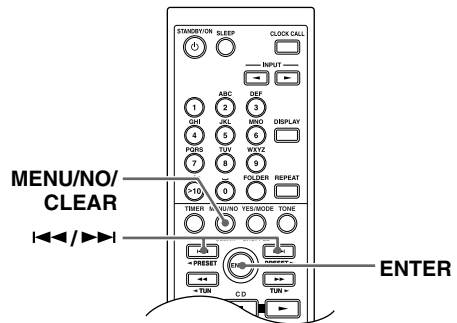

<b>1</b>	Select the preset whose name you want to erase (see page 45).
<b>2</b>  ↓ 	Press the [MENU/NO] button, and then use the Previous and Next [◀]/[▶] buttons to select "NameErase?"  
<b>3</b> 	To erase the preset's name, press the [YES/MODE] button. The preset's name is erased and "Complete" appears on the display.

On the CR-515DAB, you can also use the front panel controls.

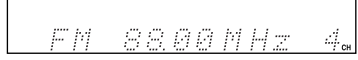
- 1 Select the preset whose name you want to erase (see page 45).
- 2 Push the multi control, and then turn it to select "NameErase?"
- 3 To erase the preset's name, push the multi control.

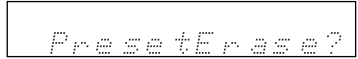
## Erasing Presets

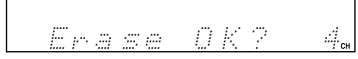

<b>1</b>	Select the preset you want to erase (see page 45).  
<b>2</b>  ↓ 	Press the [MENU/NO] button, and then use the Previous and Next [◀]/[▶] buttons to select "PresetErase?"  
<b>3</b> 	Press [ENTER]. A message requesting confirmation appears.    To cancel the Preset Erase function at this point, press the [MENU/NO] button.
<b>4</b> 	To erase the preset, press [ENTER]. The preset is erased and "Complete" appears on the display.

On the CR-515DAB, you can also use the front panel controls.

- 1 Select the preset you want to erase (see page 45).
- 2 Push the multi control, and then turn the multi control to select "PresetErase?"
- 3 Push the multi control. The confirmation message "Erase OK?" appears.
- 4 To erase the preset, push the multi control.



# Setting the Clock

## Setting AccuClock to Use a Specific Station

The AccuClock function normally uses the FM station with the strongest signal to set the clock. However, if the clock cannot be set properly using that station, you can specify which FM station the AccuClock function should use. This must be an FM station that supports RDS CT (Clock Time) information.

**1**

**Press the [TIMER] button.**

“Clock” appears on the display.

If the clock has already been set, a timer option appears instead, in which case you’ll need to press the [TIMER] button repeatedly until “Clock” appears.



**2**

**Press [ENTER].**

“AccuClock” or “\*AccuClock\*” appears on the display.



If “Manual Adjust” appears, use the Previous and Next [◀◀]/[▶▶] buttons to select “AccuClock” or “\*AccuClock\*”.



**3**

**Press [ENTER].**

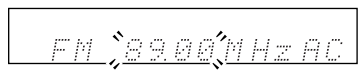
The frequency flashes on the display.



**4**

**Use the Rewind and Fast Forward [◀◀]/[▶▶] buttons to tune into the FM station.**

**Tip:**

If you press the [YES/MODE] button instead of using the Rewind and Fast Forward [◀◀]/[▶▶] buttons, the CD receiver will automatically search for a suitable station.

The RDS indicator appears when tuned into a station that supports RDS.

The RDS indicator will flash while the CD receiver searches for a station and light up continuously when a station is found.

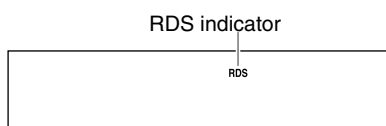
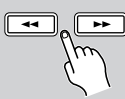

**5**

**When you’ve selected the station, press [ENTER].**

While the clock is being set, “Wait” flashes on the display. It may take a few minutes to set the clock. When the clock has been set, the message “Clock Adjusted” scrolls across the display, then the day and time are displayed for a while.

**Notes:**

- If the clock is not set correctly, specify another FM station and try again or set the clock manually (see page 50).
- The AccuClock function automatically updates the clock every day. If you don’t want it to, you can turn off the AccuClock function (see page 26).



## Setting the Clock Manually

The time can be displayed in either 12- or 24-hour format.

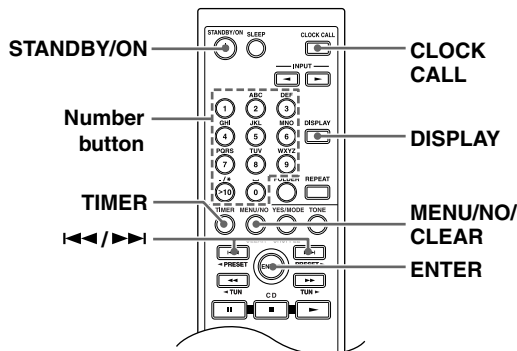

- 1** Press the [TIMER] button repeatedly until “Clock” appears.



Clock
- 2** Press [ENTER].



AccuClock
- 3** Use the Previous and Next [◀▶] / [▶▶] buttons to select “Manual Adjust.”.

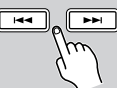

Manual Adjust
- 4** Press [ENTER].



SUN 000
- 5** Use the Previous and Next [◀▶] / [▶▶] buttons to select the day of the week.  
You can select: SUN, MON, TUE, WED, THU, FRI, or SAT.

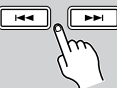

- 6** Press [ENTER].



THU 000

To cancel the Manual Adjust function at this point, press the [MENU/NO] button.

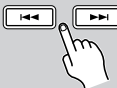
- 7** Use the Previous and Next [◀▶] / [▶▶] buttons to set the time.



You can also use the remote controller’s number buttons to enter the time.

THU 1:03

For the 12-hour format, use the remote controller’s [>10] button to select AM or PM.
- 8** Press [ENTER].



THU 1:03\*

The clock is set and the second dot starts flashing.

### Displaying the Day and Time

To display the day and time, press the remote controller’s [CLOCK CALL] button.  
If the CD receiver is on Standby, the time is displayed for 8 seconds.

### Using the 12- or 24-hour Format

To change the time format between 12-hour and 24-hour, while the time is shown on the display, press the [DISPLAY] button.

### Displaying the Time in Standby Mode

To set the CD receiver so that the time is displayed while its on Standby, turn on the CD receiver, and then press and hold its [STANDBY/ON] button for 2 seconds.  
Note that having the time displayed in Standby mode will consume a little more power.

# Using the Timers

The CD receiver has five timers: four programmable timers for automated playback or recording, and a sleep timer for turning the CD receiver off after a specified period.

The timers can be used with other Onkyo components that are connected to the CD receiver via **RI** (see pages 20 to 24 for hookup details).

## About the Timers

The various settings for the four programmable timers are explained here. For details on the sleep timer, see page 55.

### Timer Types

Each timer can be programmed for playback (Play) or recording (Rec).

#### ■ Play

Play mode can be used to start playback at a specified time on the CD receiver or another Onkyo component that's connected to the CD receiver with an **RI** cable. You could use a Play timer to turn on the CD receiver every morning, just like a radio alarm.

#### ■ Rec

Rec mode can be used to start playback on one component and start recording on another component at a specified time. The recording component (e.g., Onkyo cassette deck or MD recorder) must be connected to the CD receiver with an **RI** cable. You could use a Rec timer to record your favorite radio show every day.

### Playback and Recording Components

The playback component can be the CD receiver (AM, FM, DAB or CD), an Onkyo component (MD recorder, cassette deck, etc) that's connected to the CD receiver with an **RI** cable, or a component that's connected to one of the CD receiver's inputs, perhaps one with its own built-in timer.

The recording component can be an Onkyo MD recorder or cassette deck that's connected to the CD receiver with an **RI** cable.

### Repeat Timers

Each timer can be programmed to work just once (Once), every week (Every), every day (Every Day), or on a range of days (Days Set).

#### ■ Once

The timer will work just once.

#### ■ Every

The timer will work every week on the specified day and time.

##### • Everyday

The timer will work every day.

##### • Days Set

The timer will work on the specified range of days. With this setting, you could set up a morning alarm for Monday to Friday.

### Timer Examples

The following examples highlight some of the ways in which you can use the timers.

**Timer 1:** To wake up to your favorite radio station (preset #1) every morning, set as follows:

Play→FM 1→Every→Every Day→On 7:00→Off 7:30

If you want a radio alarm only on weekdays, select "Days Set" instead of "Every Day" and specify "MON-FRI."

**Timer 2:** To record a one-off radio show (preset #2) to a cassette deck this Sunday, set as follows:

Rec→FM 2→TAPE→Once→SUN→On 21:00→Off 22:00  
(You need an **RI**-capable Onkyo cassette recorder or MD recorder to do the recording.)

**Timer 3:** To record an FM radio show to a MiniDisc recorder every day from Monday to Friday, set as follows:

Rec→FM 1→MD→Every→Days Set→MON→FRI→On 15:00→Off 15:30

### Timer Priority

If two or more timers are set to the same On time, the lowest numbered timer has priority. For example:

**Timer 1:** 07:00 – 13:00 (This timer has priority.)

**Timer 2:** 07:00 – 12:30

If two or more timers overlap, the timer with the earliest start time has priority. For example:

**Timer 1:** 9:00 – 10:00

**Timer 2:** 8:00 – 10:00 (This timer has priority.)

If the On and Off times of two timers are the same, the timer with the earliest start time has priority and the other timer will fail. For example:

**Timer 1:** 0:00 – 1:00 (This timer has priority.)

**Timer 2:** 1:00 – 2:00

### Timer Indicators

When a timer has been set, the **TIMER** indicator and the number of the timer appear on the display. If the timer has been set to perform recording, an underscore character appears underneath the timer's number.



#### Notes:





- The timers work only if the CD receiver is on Standby. If it's on when a timer is supposed to start playback or recording, nothing will happen.
- While timed playback or recording is in progress, the timer's Off time cannot be changed.
- To use timed playback or recording with an external component, make sure it's properly connected to the CD receiver. Also, for **RI** to work properly, make sure that the Input Display on the CD receiver is set to match the type of component you've connected to the MD/TAPE IN, DOCK/CDR IN, or DIGITAL IN (see page 29).



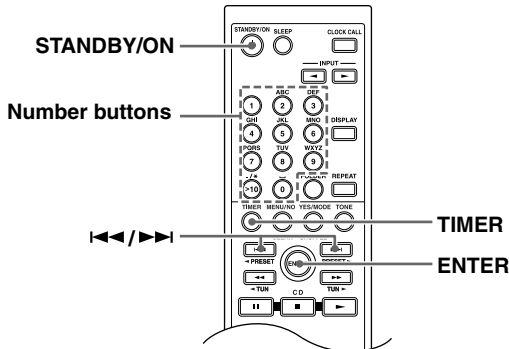



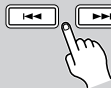

**Programming the Timers**

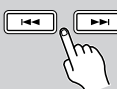
**Notes:**

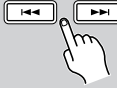
- You must set the clock before you can program the timers.
- Before programming a timer to turn on the radio, you must preset the station you want to use. (See pages 43 and 44.)
- If you don't operate any buttons for 60 seconds while programming a timer, the procedure will be cancelled and the previous display will reappear.

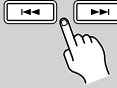

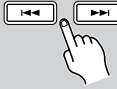
<p><b>1</b></p>  <p>TIMER</p> 	<p><b>Press the [TIMER] button repeatedly to select timer 1, 2, 3, or 4, and then press [ENTER].</b></p> <div style="border: 1px solid black; padding: 5px; text-align: center; width: fit-content; margin: 10px auto;">Timer 1</div> <p>If “Clock” appears, you need to set the clock (see page 26).</p>
<p><b>2</b></p>  	<p><b>Use the Previous and Next [◀▶] / [▶▶] buttons to select Play or Rec, and then press [ENTER].</b></p> <div style="border: 1px solid black; padding: 5px; text-align: center; width: fit-content; margin: 10px auto;">Play</div> <p style="text-align: center;">or</p> <div style="border: 1px solid black; padding: 5px; text-align: center; width: fit-content; margin: 10px auto;">Rec</div> <p>If you can't select Rec, make sure that your Onkyo cassette deck or MD recorder is properly connected to the MD/TAPE jacks (pages 20 and 21) and the Input Display is set accordingly (page 29).</p>

<p><b>3</b></p>  	<p><b>Use the Previous and Next [◀▶] / [▶▶] buttons to select the source, and then press [ENTER].</b></p> <div style="border: 1px solid black; padding: 5px; text-align: center; width: fit-content; margin: 10px auto;">FM</div> <p>You can select the following sources:  <b>CR-515DAB</b>          FM, AM, TAPE, DOCK, LINE1, LINE2, DIGITAL, CD, or DAB.  <b>CR-315DAB</b>          FM, AM, TAPE, DOCK, LINE, CD, or DAB.          If you selected Rec, CD cannot be selected as the source.</p>
<p><b>4</b></p>  	<p><b>If you selected AM, FM, or DAB, use the Previous and Next [◀▶] / [▶▶] buttons to select the radio preset, and then press [ENTER].</b></p> <div style="border: 1px solid black; padding: 5px; text-align: center; width: fit-content; margin: 10px auto;">FM 87.50 MHz</div>
<p><b>5</b></p>  	<p><b>If you selected Rec, make sure the name of the connected recorder is flashing on the display, and then press [ENTER].</b></p> <div style="border: 1px solid black; padding: 5px; text-align: center; width: fit-content; margin: 10px auto;">FM → TAPE</div> <p>You can select TAPE or MD.</p>
<p><b>6</b></p>  	<p><b>Use the Previous and Next [◀▶] / [▶▶] buttons to select Once or Every, and then press [ENTER].</b></p> <p>Select Once for on-off operation. Select Every to perform the same operation every week.</p> <div style="border: 1px solid black; padding: 5px; text-align: center; width: fit-content; margin: 10px auto;">Every</div>

**7**



If you selected **Once**, use the Previous and Next [◀] / [▶] buttons to select the day, and then press [ENTER].

You can select: SUN, MON, TUE, WED, THU, FRI, or SAT.

**8**

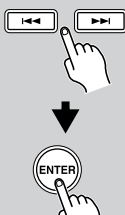

If you selected **Every**, use the Previous and Next [◀] / [▶] buttons to select the day, **Everyday**, or **Days Set**, and then press [ENTER].

You can select the following:

MON ⇄ TUE ⇄ WED ⇄ THU ⇄ FRI  
 ↓ ↑  
 SUN ⇄ Days Set ⇄ Everyday ⇄ SAT

**9**

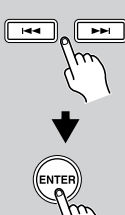

If you selected **Days Set**, use the Previous and Next [◀] / [▶] buttons to select the first day, and then press [ENTER].

TUE

Use the Previous and Next [◀] / [▶] buttons again to select the last day, and then press [ENTER].

TUE - SUN

You can select only consecutive days.

**10**

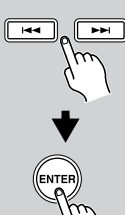

Use the Previous and Next [◀] / [▶] buttons to specify the On time, and then press [ENTER].

On 7:29

You can also use the remote controller's number buttons to enter the time. For example, to enter 7:29, press [>10], [0], [7], [2], and [9].

**Notes:**

- Once the On time is set, the Off time is automatically set to one hour later.
- To ensure that the first few seconds of a program are recorded when using timer recording, set the On time slightly ahead of the program's start time (about 1 minute).

**11**



Use the Previous and Next [◀] / [▶] buttons to specify the Off time, and then press [ENTER].

Off 8:29

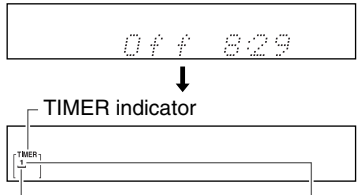

TIMER indicator

Underscore indicates timer programmed for recording

Number of programmed timer

**12**



Use the Previous and Next [◀] / [▶] buttons to specify the CD receiver's volume level, and then press [ENTER].

TimerVol. 10

The default setting is 10.

If you want to use your normal volume level setting for the timer, press the Previous [◀] button repeatedly until "TimerVol.Off" appears on the display. In this case, the timer will use the volume level that was set before the CD receiver was set to Standby.

**13**



STANDBY/ON

STANDBY/ON

Press the [STANDBY/ON] button to set the CD receiver to Standby.

**Notes:**

- Be sure to set the CD receiver to Standby, otherwise the timed operation will not work.
- While a timed operation is in progress, you can cancel it by pressing the [TIMER] or [SLEEP] button.
- While timed recording is in progress, the output of the CD receiver is muted. To hear what's being recorded, press the [MUTING] button. Press it again to mute the CD receiver.
- Memory, random, and 1-Folder playback cannot be used with the timers.

To return to step 1 and start timer programming all over again, press the [MENU/NO] button at any point in this procedure.

## Turning Timers On and Off

Once a timer has been programmed, you can turn it on or off as necessary. For example, while you're on holiday, you may want to turn off the timer you use as an early-morning alarm.

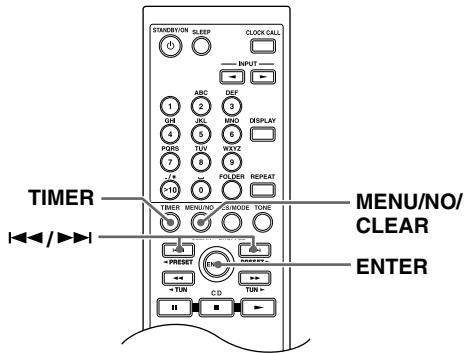

### 1 Press the [TIMER] button repeatedly to select timer 1, 2, 3, or 4.

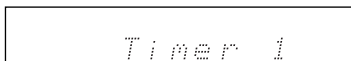

When a timer has been programmed, its number appears on the display.

### 2 Use the Previous and Next [◀▶] / [▶▶] buttons to select Timer On or Timer Off.

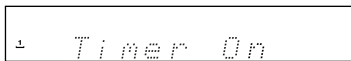
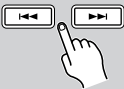

or

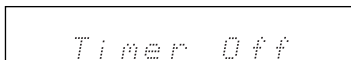

After a few moments, the previous display reappears.

## Checking Timer Settings

1



Press the [TIMER] button repeatedly to select timer 1, 2, 3, or 4, and then press [ENTER].

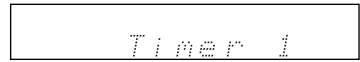

2



Press [ENTER] repeatedly to see all of the timer's settings.



#### Notes:

- You can change the settings by using the Previous and Next [◀▶]/[▶▶] buttons.
  - If you change the settings of a timer that is off, that timer will be turned on. If you don't change any settings, the previous display reappears.
- To return to the previous display at any point in this procedure, press the [MENU/NO] button.

## Using the Sleep Timer

With the sleep timer, you can set the CD receiver so that it automatically turns off after a specified period.

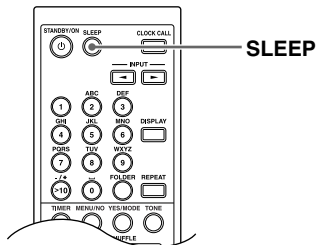

SLEEP



**Press the [SLEEP] button repeatedly to select the required sleep time.**

With the [SLEEP] button, you can set the sleep time from 90 to 10 minutes in 10 minute increments.

Use the Previous and Next [**◀◀**]/[**▶▶**] buttons to set the sleep time in 1 minute increments from 99 to 1.

SLEEP indicator

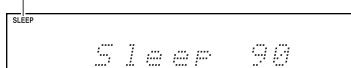

When the sleep timer has been set, the SLEEP indicator appears on the display, as shown. The sleep time appears on the display for about 8 seconds, then the previous display reappears.

### Note:

The sleep timer will be ignored while dubbing a CD to an Onkyo cassette deck or MD recorder is in progress. The CD receiver will automatically switch to Standby when the dubbing is complete.

## Checking the Remaining Sleep Time

To check the remaining sleep time, press the [SLEEP] button.

Note that if you press the [SLEEP] button while the sleep time is being displayed, you'll shorten the sleep time by 10 minutes.

## Canceling the Sleep Timer

To cancel the sleep timer, press the [SLEEP] button repeatedly until the SLEEP indicator disappears.

# Troubleshooting

If you have any trouble using the CD receiver, look for a solution in this section.

If you can't resolve the issue yourself, try resetting the CD receiver before contacting your Onkyo dealer.

**To reset the CD receiver to its factory defaults, turn it on and, while holding down the  button, press the [STANDBY/ON] button. "Clear" will appear on the display and the CD receiver will enter Standby mode.**

Note that resetting the CD receiver will delete your radio presets and custom settings.

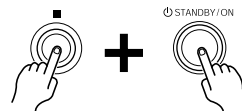

## Power

### Can't turn on the CD receiver.

- Make sure that the power cord is properly plugged into the wall outlet (see page 25).
- Unplug the power cord from the wall outlet, wait 5 seconds or more, then plug it in again.

### The CD receiver turns off unexpectedly.

- If the sleep timer has been set and the TIMER indicator is shown on the display, the CD receiver will turn off automatically after a specified period.
- When timed playback or recording finishes, the CD receiver automatically switches to Standby mode.
- If the STANDBY indicator is flashing, the built-in amplifier protection circuit has been activated. This can happen if there's a short between the positive and negative wires of a speaker cable.

## Audio

### There's no sound.

- Make sure the CD receiver's volume control is not set to minimum (see page 27).
- Make sure the correct input source is selected (see page 27).
- Make sure the CD receiver is not muted (see page 28).
- Make sure the speakers are connected correctly (see page 18).
- Check all connections and correct as necessary (see pages 16 to 25).
- While headphones are connected, the speakers output no sound (see page 27).

### The sound quality is not good.

- Make sure the speaker cables are connected with the correct polarity (see page 18).
- Make sure all audio connecting plugs are pushed in all the way (see page 19).
- The sound quality can be affected by strong magnetic fields, such as that from a TV. Try moving any such devices away from the CD receiver.
- If you have any devices that emit high-intensity radio waves near the CD receiver, such as a cellular phone that's being used to make a call, the CD receiver may output noise.
- The CD receiver's precision drive mechanism may emit a faint hissing sound while reading discs during playback or when searching for tracks. You may be able to hear this noise in extremely quiet environments.

### Audio output is intermittent when the CD receiver is subjected to vibration.

- The CD receiver is not a portable device. Use it in a location that's not subject to shock or vibration.

### Headphone output is intermittent or there's no sound.

- This may be due to dirty contacts. Clean the headphones plug. See your headphones' instruction manual for cleaning information. Also, make sure that the headphones cable is not broken or damaged.

## Audio performance

- Audio performance will be at its best about 10 to 30 minutes after the CD receiver has been turned on and had time to warm up.
- Using cable ties to bundle audio cables with speaker or power cables may degrade the sound quality, so don't do it.

## CD Playback

### Playback jumps.

- The CD receiver is being subjected to vibration or the disc is scratched or dirty (see page 15).



---

### Can't add tracks to the playlist for memory playback.

- Make sure there's a disc in the CD receiver. Also, you can only add valid track numbers. For example, if the CD contains 11 tracks, you cannot add track #12.

---

### The disc will not play.

- Make sure the disc has been loaded correctly, with the label-side facing up.
- Check to see if the surface of the disc is dirty (see page 15).
- If condensation is suspected, turn on the CD receiver and leave it for 1 hour before playing any discs.
- Some CD-R/RW discs may not be playable (see page 14).

---

### It takes a long time for playback to start.

- It may take the CD receiver a while to read CDs that contain many tracks or files.

## Tuner

---

### Reception is noisy, stereo FM reception suffers from hiss, the Auto Preset function doesn't preset all stations, or the ST indicator doesn't light up when tuned to a stereo FM station.

- Check the antenna connections (see page 16).
- Change the position of the antenna (see page 38).
- Move the CD receiver away from a nearby TV or computer.
- Cars or airplanes can cause noisy interference.
- The radio signal will be weakened if it has to pass through a concrete wall before reaching the antenna.
- Try setting FM mode to mono (see page 38).
- Move power cords and speaker cables as far away as possible from the tuner's antenna.
- When listening to an AM station, noise may be heard when you operate the remote controller.
- If none of the above improves the reception, install an outdoor antenna (see page 17).

---

### If a power outage occurs or the power cable is disconnected:

- If the preset stations are lost, preset them again (see pages 43, 44).
- The clock and timer settings will be lost. Set the clock and timers again (see pages 49, 50).

---

### Can't adjust the frequency of the radio.

- Use the Fast Reverse and Fast Forward [ $\blacktriangleleft$ ]/[ $\blacktriangleright$ ] buttons to change the frequency of the radio (see page 38).

---

### RDS doesn't work.

- The FM station you are tuned to doesn't support RDS.
- Install an outdoor FM antenna (see page 17).
- Change the position or direction of your outdoor FM antenna (see pages 17, 38).
- Move the FM antenna as far away as possible from fluorescent lights (see page 38).

## Remote Controller

---

### The remote controller doesn't work properly.

- Make sure the batteries have been installed with the correct polarity (+/-) (see page 5).
- Replace both batteries with new ones. (Do not mix different types of batteries or new and old batteries.)
- The remote controller is too far away from the CD receiver, or there's an obstacle between them (see page 5).
- The CD receiver's remote control sensor is being subjected to bright light (inverter-type fluorescent light or sunlight).
- The CD receiver is located behind the glass doors of a audio rack or cabinet.

## External Components

---

### Interactive control with other Onkyo RI-capable components is not working.

- Make sure the **RI** cables and analog audio cables are connected correctly (see pages 19 to 25). Connecting only an **RI** cable won't work.
- Make sure the Input Display matches the type of device that you've connected to the CD receiver (see page 29).
- When recording an MP3 CD to an Onkyo recording component, recording will start without performing a peak search when the [CD DUBBING] button is pressed on the recording component. This is not a malfunction.

### No sound is heard from a connected component.

---

- Make sure the optical digital audio cable is not bent or damaged.
- On the external component, set the digital output format to PCM, as the CD receiver supports only PCM signals.

### No sound is heard from your turntable.

---

- Make sure the turntable has a built-in phono equalizer.
- If the turntable doesn't have a phono equalizer built-in, you must provide one.

## Timers

### Timer playback or recording doesn't work.

---

- Make sure the clock has been set correctly (see page 49).
- Timed operation will fail if the CD receiver is on at the specified On time, so make sure it's set to Standby (see page 53).
- The timer may overlap with another timer. If you program several timers, make sure they don't overlap (see page 51).
- If you press the [SLEEP] or [TIMER] button while a timed operation is in progress, the timer will be cancelled.
- Make sure the **RI** cables and analog audio cables are connected correctly (see pages 19 to 25).
- If you're using an Onkyo component for timed playback or recording, you must set the Input Display to match that component (see page 29).

### The time is not displayed in Standby mode.

---

- Set the CD receiver so that the time is displayed in Standby mode (see page 50).

Onkyo is not responsible for damages (such as CD rental fees) due to unsuccessful recordings caused by the unit's malfunction. Before you record important data, make sure that the material will be recorded correctly.

The CD receiver contains a microcomputer for signal processing and control functions. In very rare situations, severe interference, noise from an external source, or static electricity may cause it to lockup. In the unlikely event that this should happen, unplug the power cord, wait at least 5 seconds, and then plug it again.

# Specifications

General	CR-515DAB	CR-315DAB
Power Supply:	AC 230 V, 50 Hz	AC 230 V, 50 Hz
Power Consumption:	56 W	56 W
Stand-by Power Consumption:	0.25 W	0.25 W
Dimensions (W × H × D):	205 × 116 × 353 mm (8-1/16" × 4-9/16" × 13-7/8")	205 × 116 × 352.5 mm (8-1/16" × 4-9/16" × 13-7/8")
Weight:	4.3 kg (9.5 lbs.)	4.2 kg (9.3 lbs.)

## Audio Inputs

Digital Inputs:	1 (optical)	0
Analog Inputs:	4 (LINE1, LINE2, DOCK, TAPE)	3 (LINE, DOCK, TAPE)

## Audio Outputs

Analog Outputs:	2 (DOCK, TAPE)	1 (TAPE)
Subwoofer Pre Outputs:	1	1
Speaker Outputs:	2	2
Phones:	1	1

Amplifier Section	CR-515DAB	CR-315DAB
Power Output:	26 W + 26 W (4Ω, 1 kHz, 10% THD) 2ch × 20 W (4Ω, 1 kHz, 2ch driven, IEC)	25 W + 25 W (4Ω, 1 kHz, 10% THD) 2ch × 19 W (4Ω, 1 kHz, 2ch driven, IEC)
THD (Total Harmonic Distortion):	0.4% (1 kHz, 1 W)	0.9% (Power Rated) 0.4% (1 kHz, 1 W)
Damping Factor:	25 (Front, 1 kHz, 8 Ω)	25 (Front, 1 kHz, 8 Ω)
Input Sensitivity and Impedance:	150 mV/50 kΩ (TAPE)	150 mV/50 kΩ (TAPE)
Output Level and Impedance:	150 mV/2.2Ω (REC OUT)	150 mV/2.2Ω (REC OUT)
Frequency Response:	10 Hz–100 kHz±3 dB (TAPE)	10 Hz–100 kHz±3 dB (TAPE)
Tone Control:	±6 dB, 80 Hz (BASS) ±8 dB, 10 kHz (TREBLE) +7 dB, 80 Hz (S.BASS)	±6 dB, 80 Hz (BASS) ±8 dB, 10 kHz (TREBLE) +7 dB, 80 Hz (S.BASS)
Signal to Noise Ratio:	100 dB (LINE, IHF-A)	100 dB (LINE, IHF-A)
Speaker Impedance:	4 Ω–16 Ω	4 Ω–16 Ω

Tuner Section	CR-515DAB	CR-315DAB
<b>FM</b>		
Tuning Frequency Range:	87.5 MHz–108.0 MHz	87.5 MHz–108.0 MHz
Usable Sensitivity:	Stereo: 22.2 dBf (IHF) Mono: 15.2 dBf (IHF)	Stereo: 22.2 dBf (IHF) Mono: 15.2 dBf (IHF)
Signal to Noise Ratio:	Stereo: 67 dB (IHF-A) Mono: 73 dB (IHF-A)	Stereo: 67 dB (IHF-A) Mono: 73 dB (IHF-A)
THD (Total Harmonic Distortion):	Stereo: 0.5% (1 kHz) Mono: 0.3% (1 kHz)	Stereo: 0.5% (1 kHz) Mono: 0.3% (1 kHz)
Stereo Separation:	40 dB (1 kHz)	40 dB (1 kHz)

## AM

Tuning Frequency Range:	522 kHz–1611 kHz	522 kHz–1611 kHz
Usable Sensitivity:	300 dBf (30 μV)	300 dBf (30 μV)
Signal to Noise Ratio:	40 dB	40 dB
THD (Total Harmonic Distortion):	0.7%	0.7%

## DAB

Tuning Frequency Range:	174.928–239.200 MHz	174.928–239.200 MHz
Frequency Response:	20 Hz–20 kHz	20 Hz–20 kHz
Signal to Noise Ratio:	94 dB	94 dB
THD (Total Harmonic Distortion):	0.09%	0.09%

CD	CR-515DAB	CR-315DAB
Frequency Response:	4 Hz–20 kHz	10 Hz–20 kHz
Audio Dynamic Range:	96 dB	95 dB
THD (Total Harmonic Distortion):	0.005%	0.007%
Wow and Flutter:	Below threshold of measurability	Below threshold of measurability
Audio Output/Impedance (Analog):	1.3 V/1.0 kΩ	1.3 V/1.0 kΩ

Specifications and features are subject to change without notice.

## **ONKYO CORPORATION**

Sales & Product Planning Div. : 2-1, Nisshin-cho, Neyagawa-shi, OSAKA 572-8540, JAPAN  
Tel: 072-831-8023 Fax: 072-831-8124

### **ONKYO U.S.A. CORPORATION**

18 Park Way, Upper Saddle River, N.J. 07458, U.S.A.  
Tel: 201-785-2600 Fax: 201-785-2650 <http://www.us.onkyo.com/>

### **ONKYO EUROPE ELECTRONICS GmbH**

Liegnitzerstrasse 6, 82194 Groebenzell, GERMANY  
Tel: +49-8142-4401-0 Fax: +49-8142-4401-555 <http://www.eu.onkyo.com/>

### **ONKYO EUROPE UK Office**

Suite 1, Gregories Court, Gregories Road, Beaconsfield, Buckinghamshire, HP9 1HQ  
UNITED KINGDOM Tel: +44-(0)1494-681515 Fax: +44(0)-1494-680452

### **ONKYO CHINA LIMITED**

Unit 1&12, 9/F, Ever Gain Plaza Tower 1, 88, Container Port Road, Kwai Chung,  
N.T., HONG KONG Tel: 852-2429-3118 Fax: 852-2428-9039  
<http://www.ch.onkyo.com/>



I0606-1

SN 29344262

(C) Copyright 2006 ONKYO CORPORATION Japan. All rights reserved.

Download from [www.Somanuals.com](http://www.Somanuals.com). All Manuals Search And Download.



\* 2 9 3 4 4 2 6 2 \*

## Free Manuals Download Website

<http://myh66.com>

<http://usermanuals.us>

<http://www.somanuals.com>

<http://www.4manuals.cc>

<http://www.manual-lib.com>

<http://www.404manual.com>

<http://www.luxmanual.com>

<http://aubethermostatmanual.com>

Golf course search by state

<http://golfingnear.com>

Email search by domain

<http://emailbydomain.com>

Auto manuals search

<http://auto.somanuals.com>

TV manuals search

<http://tv.somanuals.com>