

ONKYO®

CD Receiver

CR-305FX

Instruction Manual



Thank you for purchasing the Onkyo CD Receiver.
Please read this manual thoroughly before making connections and turning on the power.
Following the instructions in this manual will enable you to obtain optimum performance and listening enjoyment from your new CD Receiver.
Please retain this manual for future reference.

Contents

Before using

Important Safety Instructions	2
Precautions	3
Features	4
Supplied accessories	5
Before operating this unit	5

Preparation

Audio equipment connections	6
Connecting speaker systems	8
Connecting the AC power cord (mains lead)	9
Making antenna connections	10
Control positions and names	12
Remote controller RC-617S	13

Operation

Setting the clock	14
Choosing the required source	16
Adjusting the sound	16
Muting / Listening with the headphones	17
Playing a CD	18
Receiving stations	22
Using the timer	26

Appendix

Troubleshooting	32
Specifications	34

Control guide

Using the remote controller	35
-----------------------------------	----

WARNING:

TO REDUCE THE RISK OF FIRE OR ELECTRIC SHOCK, DO NOT EXPOSE THIS APPARATUS TO RAIN OR MOISTURE.

CAUTION:

TO REDUCE THE RISK OF ELECTRIC SHOCK, DO NOT REMOVE COVER (OR BACK). NO USER-SERVICEABLE PARTS INSIDE. REFER SERVICING TO QUALIFIED SERVICE PERSONNEL.



WARNING
RISK OF ELECTRIC SHOCK
DO NOT OPEN

AVIS
RISQUE DE CHOC ELECTRIQUE
NE PAS OUVRIR



The lightning flash with arrowhead symbol, within an equilateral triangle, is intended to alert the user to the presence of uninsulated "dangerous voltage" within the product's enclosure that may be of sufficient magnitude to constitute a risk of electric shock to persons.



The exclamation point within an equilateral triangle is intended to alert the user to the presence of important operating and maintenance (servicing) instructions in the literature accompanying the appliance.

Important Safety Instructions

1. Read these instructions.
2. Keep these instructions.
3. Heed all warnings.
4. Follow all instructions.
5. Do not use this apparatus near water.
6. Clean only with dry cloth.
7. Do not block any ventilation openings. Install in accordance with the manufacturer's instructions.
8. Do not install near any heat sources such as radiators, heat registers, stoves, or other apparatus (including amplifiers) that produce heat.
9. Do not defeat the safety purpose of the polarized or grounding-type plug. A polarized plug has two blades with one wider than the other. A grounding type plug has two blades and a third grounding prong. The wide blade or the third prong are provided for your safety. If the provided plug does not fit into your outlet, consult an electrician for replacement of the obsolete outlet.
10. Protect the power cord from being walked on or pinched particularly at plugs, Important Safety Instructions convenience receptacles, and the point where they exit from the apparatus.
11. Only use attachments/accessories specified by the manufacturer.
12. Use only with the cart, stand, tripod, bracket, or table specified by the manufacturer, or sold with the apparatus. When a cart is used, use caution when moving the cart/apparatus combination to avoid injury from tip-over.

PORTABLE CART WARNING
S3125A
13. Unplug this apparatus during lightning storms or when unused for long periods of time.
14. Refer all servicing to qualified service personnel. Servicing is required when the apparatus has been damaged in any way, such as power-supply cord or plug is damaged, liquid has been spilled or objects have fallen into the apparatus, the apparatus has been exposed to rain or moisture, does not operate normally, or has been dropped.
15. Damage Requiring Service
Unplug the apparatus from the wall outlet and refer servicing to qualified service personnel under the following conditions:
 - A. When the power-supply cord or plug is damaged,
 - B. If liquid has been spilled, or objects have fallen into the apparatus,
 - C. If the apparatus has been exposed to rain or water,
 - D. If the apparatus does not operate normally by following the operating instructions. Adjust only those controls that are covered by the operating instructions as an improper adjustment of other controls may result in damage and will often require extensive work by a qualified technician to restore the apparatus to its normal operation,
 - E. If the apparatus has been dropped or damaged in any way, and
 - F. When the apparatus exhibits a distinct change in performance this indicates a need for service.
16. Object and Liquid Entry
Never push objects of any kind into the apparatus through openings as they may touch dangerous voltage points or short-out parts that could result in a fire or electric shock.
The apparatus shall not be exposed to dripping or splashing and no objects filled with liquids, such as vases shall be placed on the apparatus.
Don't put candles or other burning objects on top of this unit.
17. Batteries
Always consider the environmental issues and follow local regulations when disposing of batteries.
If you install the apparatus in a built-in installation, such as a bookcase or rack, ensure that there is adequate ventilation.
18. Leave 20 cm (8") of free space at the top and sides and 10 cm (4") at the rear. The rear edge of the shelf or board above the apparatus shall be set 10 cm (4") away from the rear panel or wall, creating a flue-like gap for warm air to escape.

Precautions

- 1. Recording Copyright**—Unless it's for personal use only, recording copyrighted material is illegal without the permission of the copyright holder.
- 2. AC Fuse**—The AC fuse inside the unit is not user-serviceable. If you cannot turn on the unit, contact your Onkyo dealer.
- 3. Care**—Occasionally you should dust the unit all over with a soft cloth. For stubborn stains, use a soft cloth dampened with a weak solution of mild detergent and water. Dry the unit immediately afterwards with a clean cloth. Don't use abrasive cloths, thinners, alcohol, or other chemical solvents, because they may damage the finish or remove the panel lettering.
- 4. Power**
WARNING
BEFORE PLUGGING IN THE UNIT FOR THE FIRST TIME, READ THE FOLLOWING SECTION CAREFULLY.
AC outlet voltages vary from country to country. Make sure that the voltage in your area meets the voltage requirements printed on the unit's rear panel (e.g., AC 230 V, 50 Hz or AC 120 V, 60 Hz).

Setting the STANDBY/ON switch to STANDBY does not fully shutdown the unit. If you do not intend to use the unit for an extended period, remove the power cord from the AC outlet.
- 5. Never Touch this Unit with Wet Hands**—Never handle this unit or its power cord while your hands are wet or damp. If water or any other liquid gets inside this unit, have it checked by your Onkyo dealer.
- 6. Handling Notes**
 - If you need to transport this unit, use the original packaging to pack it how it was when you originally bought it.
 - Do not leave rubber or plastic items on this unit for a long time, because they may leave marks on the case.
 - This unit's top and rear panels may get warm after prolonged use. This is normal.
 - If you do not use this unit for a long time, it may not work properly the next time you turn it on, so be sure to use it occasionally.
 - When you've finished using this unit, remove all discs and turn off the power.
- 7. Installing this Unit**
 - Install this unit in a well-ventilated location.
 - Ensure that there's adequate ventilation all around this unit, especially if it's installed in an audio rack. If the ventilation is inadequate, the unit may overheat, leading to malfunction.
 - Do not expose this unit to direct sunlight or heat sources, because its internal temperature may rise, shortening the life of the optical pickup.
 - Avoid damp and dusty places, and places subject to vibrations from loudspeakers. Never put the unit on top of, or directly above a loudspeaker.
 - Install this unit horizontally. Never use it on its side or on a sloping surface, because it may cause a malfunction.
 - If you install this unit near a TV, radio, or VCR, the picture and sound quality may be affected. If this occurs, move this unit away from the TV, radio, or VCR.

8. Moisture Condensation

Moisture condensation may damage this unit.

Read the following carefully:

Moisture may condense on the lens of the optical pickup, one of the most important parts inside this unit.

- Moisture condensation can occur in the following situations:
 - The unit is moved from a cold place to a warm place.
 - A heater is turned on, or cold air from an air conditioner is hitting the unit.
 - In the summer, when this unit is moved from an air conditioned room to a hot and humid place.
 - The unit is used in a humid place.
- Do not use this unit when there's the possibility of moisture condensation occurring. Doing so may damage your discs and certain parts inside this unit.

If condensation does occur, remove all discs and leave this unit turned on for two to three hours. By this time, the unit will have warmed up and any condensation will have evaporated.

For British models

Replacement and mounting of an AC plug on the power supply cord of this unit should be performed only by qualified service personnel.

IMPORTANT

The wires in the mains lead are coloured in accordance with the following code:

Blue: Neutral
Brown: Live

As the colours of the wires in the mains lead of this apparatus may not correspond with the coloured markings identifying the terminals in your plug, proceed as follows:

The wire which is coloured blue must be connected to the terminal which is marked with the letter N or coloured black.

The wire which is coloured brown must be connected to the terminal which is marked with the letter L or coloured red.

IMPORTANT

The plug is fitted with an appropriate fuse. If the fuse needs to be replaced, the replacement fuse must be approved by ASTA or BSI to BS1362 and have the same ampere rating as that indicated on the plug. Check for the ASTA mark or the BSI mark on the body of the fuse.

If the power cord's plug is not suitable for your socket outlets, cut it off and fit a suitable plug. Fit a suitable fuse in the plug.

For European Models

Declaration of Conformity	
We, ONKYO EUROPE ELECTRONICS GmbH LIEGNITZERSTRASSE 6, 82194 GROEBENZELL, GERMANY	
declare in own responsibility, that the ONKYO product described in this instruction manual is in compliance with the corresponding technical standards such as EN60065, EN55013, EN55020 and EN61000-3-2, -3-3.	
GROEBENZELL, GERMANY	 I. MORI
ONKYO EUROPE ELECTRONICS GmbH	

Precautions

This unit contains a semiconductor laser system and is classified as a "CLASS 1 LASER PRODUCT". So, to use this model properly, read this Instruction Manual carefully. In case of any trouble, please contact the store where you purchased the unit.

To prevent being exposed to the laser beam, do not try to open the enclosure.

DANGER:

VISIBLE AND/OR INVISIBLE LASER RADIATION WHEN OPEN AND INTERLOCK FAILED OR DEFEATED. DO NOT STARE INTO BEAM.

CAUTION:

THIS PRODUCT UTILIZES A LASER. USE OF CONTROLS OR ADJUSTMENTS OR PERFORMANCE OF PROCEDURES OTHER THAN THOSE SPECIFIED HEREIN MAY RESULT IN HAZARDOUS RADIATION EXPOSURE.

The label on the right is applied on the right side of the unit.

1. This unit is a CLASS 1 LASER PRODUCT and employs a laser inside the cabinet.
2. To prevent the laser from being exposed, do not remove the cover. Refer servicing to qualified personnel.



* In catalogs and on packaging, the letter added to the end of the product name indicates the color of the CR-305FX. Specifications and operation are the same regardless of color.

Features

- 2 × 20 watts min RMS at 4 ohms, 1 kHz no more than 1.0 % THD (FTC rating)
- 2 × 20 watts at 4 ohms, 1 kHz, DIN
- 2 × 25 watts at 4 ohms, EIAJ
- 4-Ohm Drive capability
- High-Grade Discrete Outputs Stage Circuits
- Brushed Aluminium Front Panel
- 4-step Acoustic Presence control
- Optical Digital Output
- **RI** Full-Function Remote Control
- RDS (PS) (European models)
- Subwoofer Preout
- CDR and Tape Inputs/Outputs

Memory Preservation

This unit does not require memory preservation batteries. A built-in memory power back-up system preserves the contents of the memory during power failures and even when the unit is unplugged. The unit must be plugged in order to charge the back-up system.

The memory preservation period after the unit has been unplugged varies depending on climate and placement of the unit. On the average, memory contents are protected over a period of a few weeks after the last time the unit has been unplugged. This period is shorter when the unit is exposed to a highly humid climate.

Supplied accessories

Check that the following accessories are supplied with this unit.

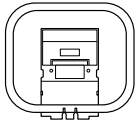

AM loop antenna × 1



FM indoor antenna × 1

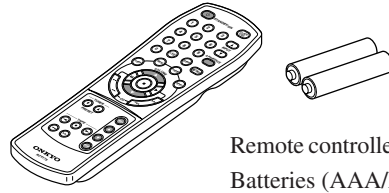

Remote controller (RC-617S) × 1
Batteries (AAA/R03) × 2

Before operating this unit

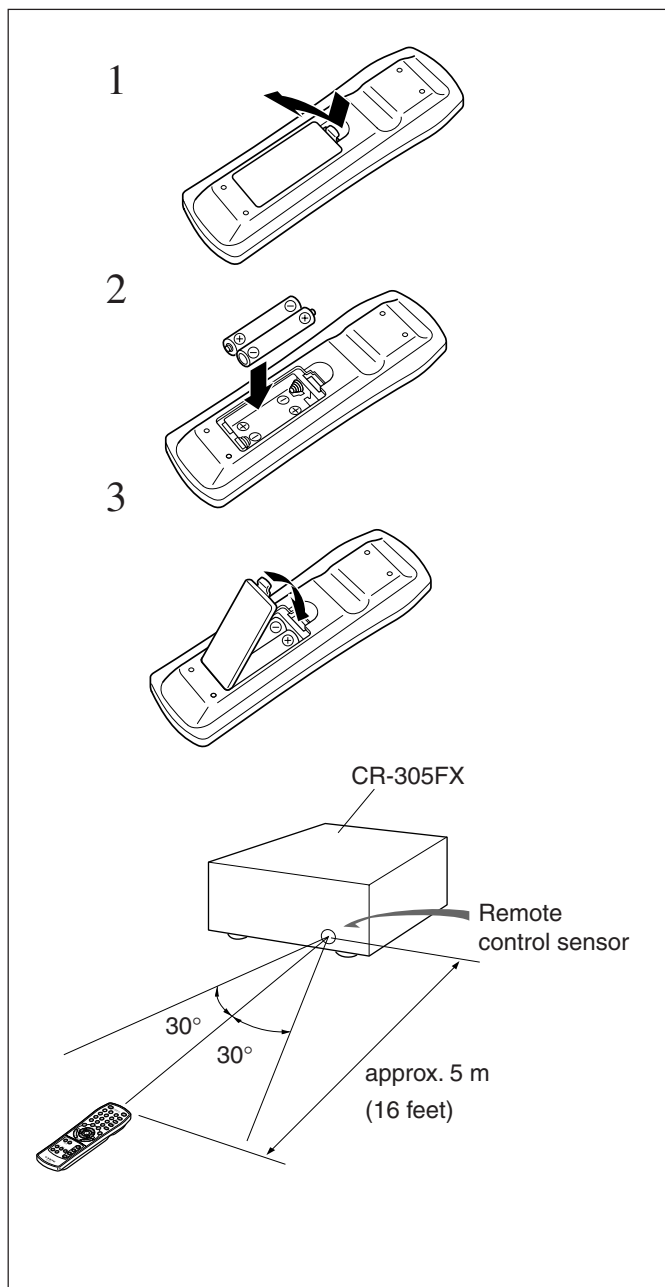

Installing the remote controller batteries

1. Remove the battery compartment cover, as shown.
2. Insert two AAA (R03)-size batteries into the battery compartment. Carefully follow the polarity diagram (positive (+) and negative (-) symbols) inside the battery compartment.
3. After batteries are installed and seated correctly, replace the compartment cover.

Notes

- Do not mix new batteries with old batteries or different kinds of batteries.
- To avoid corrosion, remove the batteries if the remote controller is not to be used for a long time.
- Remove dead batteries immediately to avoid damage from corrosion. If the remote controller doesn't operate smoothly, replace both the batteries at the same time.

Using the remote controller

Point the remote controller toward the remote control sensor.

Notes

- Place the unit away from strong light such as direct sunlight or inverted fluorescent light which can prevent proper operation of the remote controller.
- Using another remote controller of the same type in the same room or using the unit near equipment which uses infrared rays may cause operational interference.
- Do not put any object such as a book on the remote controller. The buttons of the remote controller may be pressed by mistake and drain the batteries.
- Make sure the audio rack doors do not have colored glass. Placing the unit behind such doors may prevent proper remote controller operation.
- If there is any obstacle between the remote controller and the remote control sensor, the remote controller will not operate.

Audio equipment connections

- Do not connect the AC power cord (mains lead) to the wall outlet (the mains) until you have completed all the other connections including the **RI** connections on page 7, and the speaker connections on page 8.
- On each pair of connectors, a red connector (marked R) corresponds to the right channel, and a white connector (marked L) to the left channel. Connect white plugs of audio connection cables to L connectors and connect red plugs of audio connection cables to R connectors .

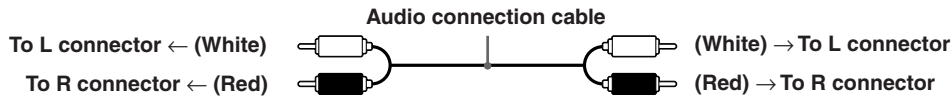

- Please refer to the instruction manual for each component when you make any connections.
- Insert the plug securely. If the connection is incomplete, noise or malfunction may result.

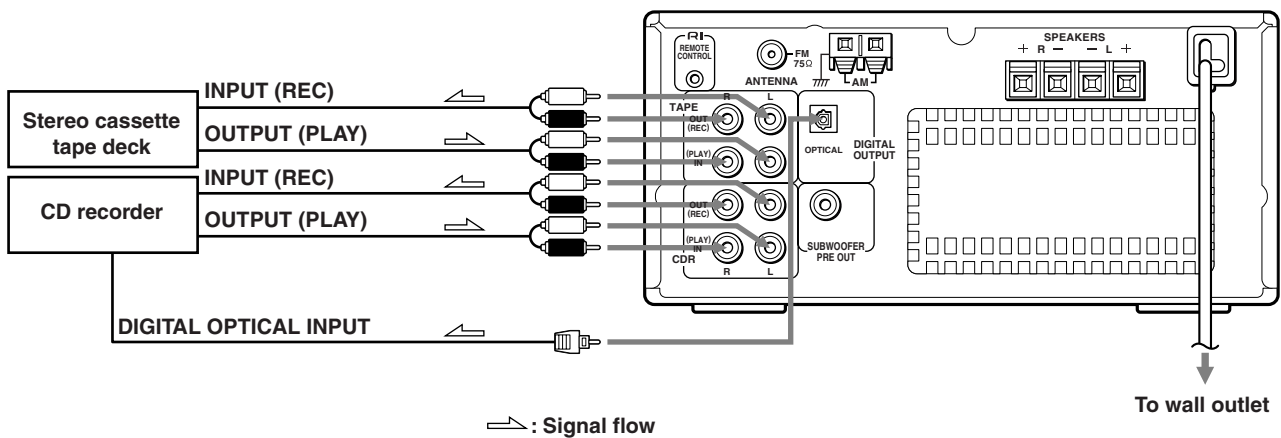
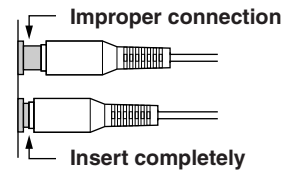

About the OPTICAL DIGITAL OUTPUT connector

- An optical digital audio input equipped CD recorder may be connected with an optical fiber audio cable for digital recording of this unit.

Audio equipment connections

Connecting the **RI** remote control cables

If your other components are made by ONKYO and those components are equipped with **RI** connectors, you can control the **RI**-connected components with the supplied remote controller.

- The unit must be connected in the **RI** system hookups for **RI** control operations.
- Each component has two **RI** connectors except for this unit. There is no difference between these connectors.
- The components may be connected in any order.
- The hookups on the previous page are necessary independently of the **RI** system hookups.
- The illustration below is an example of a **RI** hookup.

Note

- This is not an example of stacking the components.

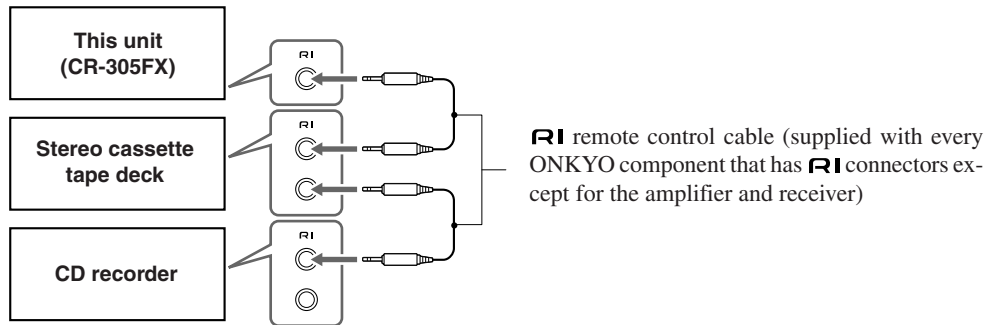

What can you do with the other ONKYO components by connecting with an **RI** remote control cables?

Combination use of the unit with the stereo cassette tape deck or CD recorder, enables you to operate the following convenient functions. Note that the available components may vary according to the area.

- **Remote control of the components**
The cassette tape deck can be operated using the supplied remote controller. (Refer to "Using the remote controller" on page 35.)
- **Program timer**
You can operate timer playback and recording using this unit. (With the CD recorder, you can operate timer playback only.) (Refer to "Using the timer" on page 26.)
- **CD dubbing**
Simple CD dubbing using the CD recorder or stereo cassette tape deck is possible with the pressing of a single button. The unit begins a search for the peak level and the CD recorder, or stereo cassette tape deck sets the optimum recording level to match that peak level. (Refer to Onkyo CDR, cassette deck component instruction manual for details.)
- **CD synchro recording**
With the CD recorder or stereo cassette tape deck in recording pause, starting CD playback causes these components to start recording. (Refer to Onkyo CDR, cassette deck component instruction manual for details.)

Note

- Make sure the unit and each component are firmly connected with the **RI** remote control cable, audio connection cable, and optical fiber cable. If the connection is incomplete, the above functions does not work.

Connecting speaker systems

Connecting left and right speakers

- The load impedance of each speaker must be at least 4 ohms.
- Do not use unnecessarily long or extremely thin speaker cords. Otherwise, the DC resistance of the speaker cords may become too high, lowering the damping factor and causing the sound quality to deteriorate.
- Do not connect the speaker cord to the L and R connectors at the same time and do not connect two or more speakers to the same speaker connectors.

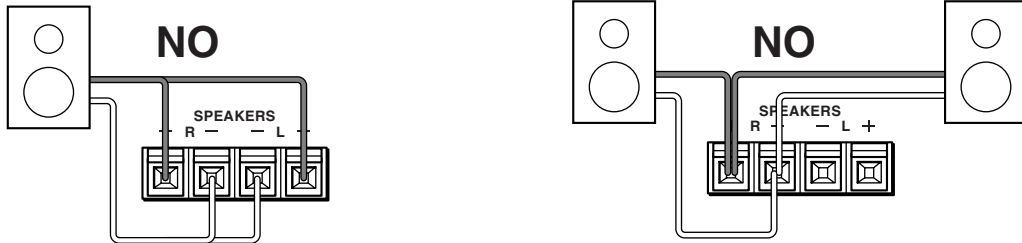

Preparing the speaker cords for connection

1. Strip 12 mm from the end of each cord.
2. Twist the stripped end of the cord.

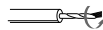
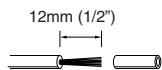

Note

To prevent damage to circuits never short-circuit the positive (+) and negative (-) speaker wires.

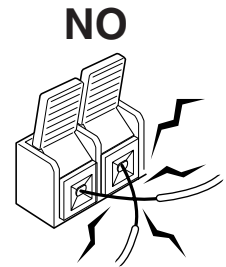

Connecting the speaker cords to the speaker connectors

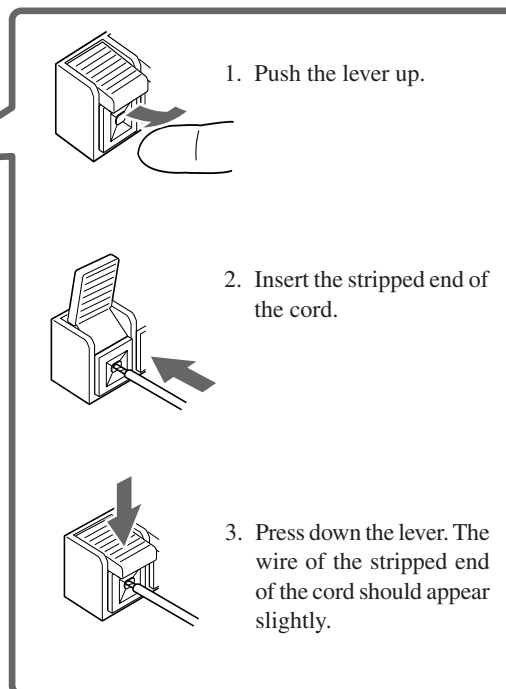
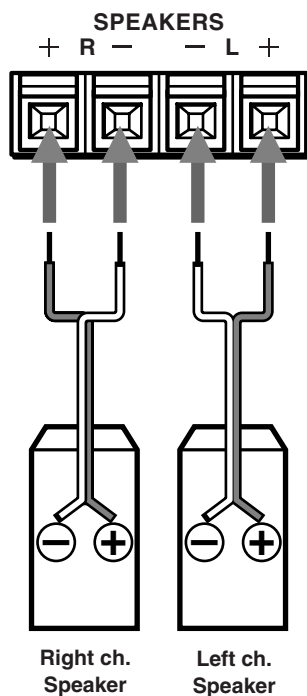

Connecting speaker systems

Connecting a sub-woofer

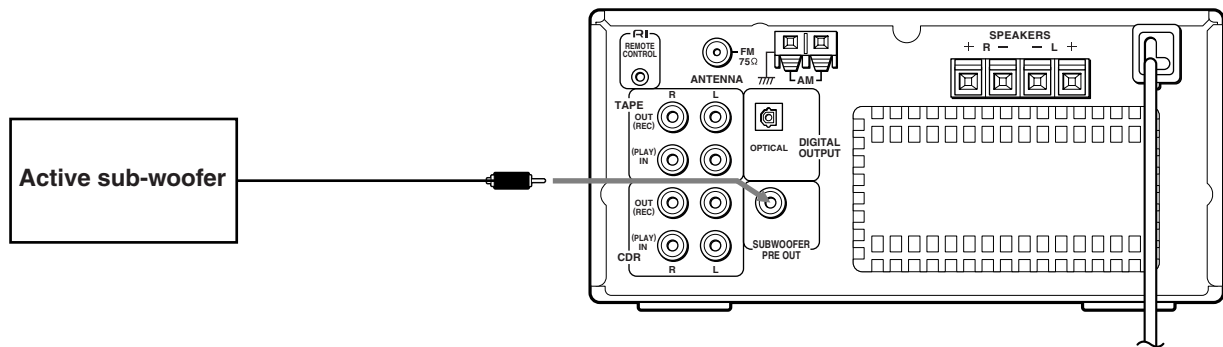

- The SUBWOOFER PRE OUT jack supplies the left and right mixed monaural signals to the sub-woofer.

Connecting the AC power cord (mains lead)

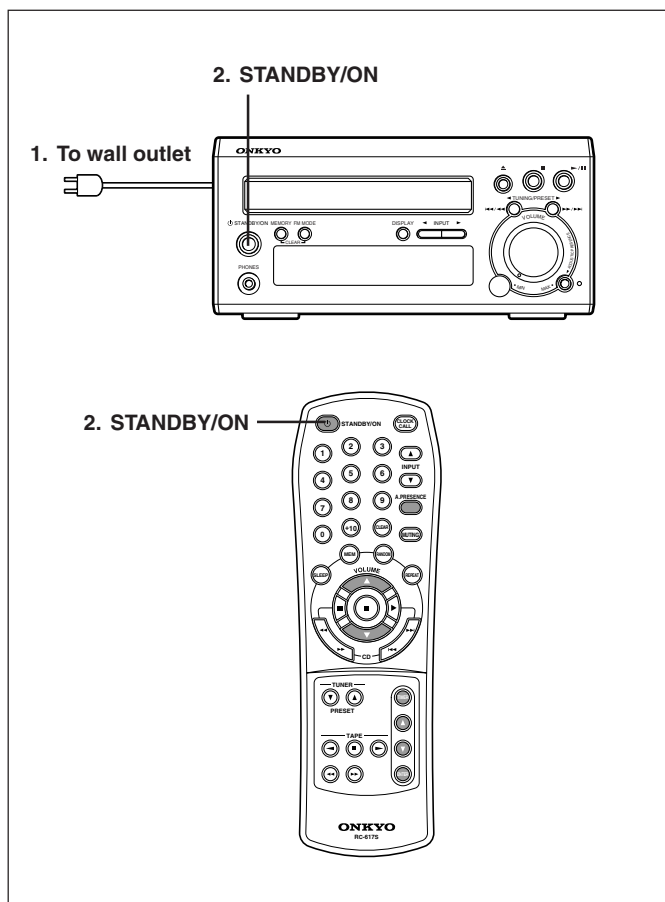

Connecting the AC power cord (mains lead)

1. Connect the AC power cord (mains lead) to the wall outlet (the mains).
“- -: - -” appears on the display.

2. Press the STANDBY/ON button.

Notes

- If the AC power cord (mains lead) is connected to the AC outlet of another component, that component's AC power cord (mains lead) must be connected to the wall outlet (the mains) to supply power to the unit. If the component has a power switch, it must be set to On.
- If you do not use the unit for a long time, remove the power cord of the CR-305FX from the AC outlet.
- The unit may cause a power surge on your home circuit when you turn it on. If this interferes with any other devices connected to the same circuit, plug this unit into another outlet on a separate circuit.

Making antenna connections

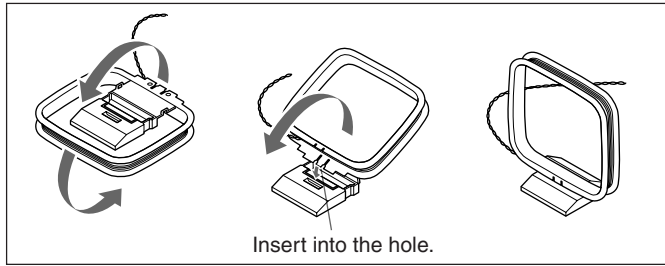

Assembling the AM loop antenna

Assemble the loop antenna as shown in the illustration.

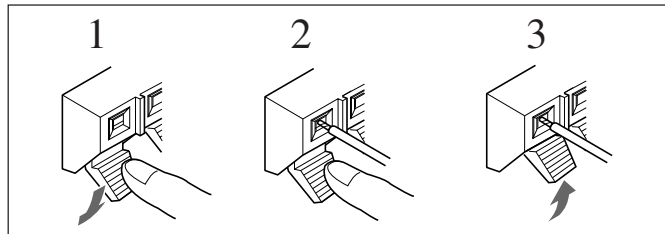

Connecting the antenna cable

1. Press down the lever.
2. Insert the wire into the hole.
3. Release the lever to replace it.

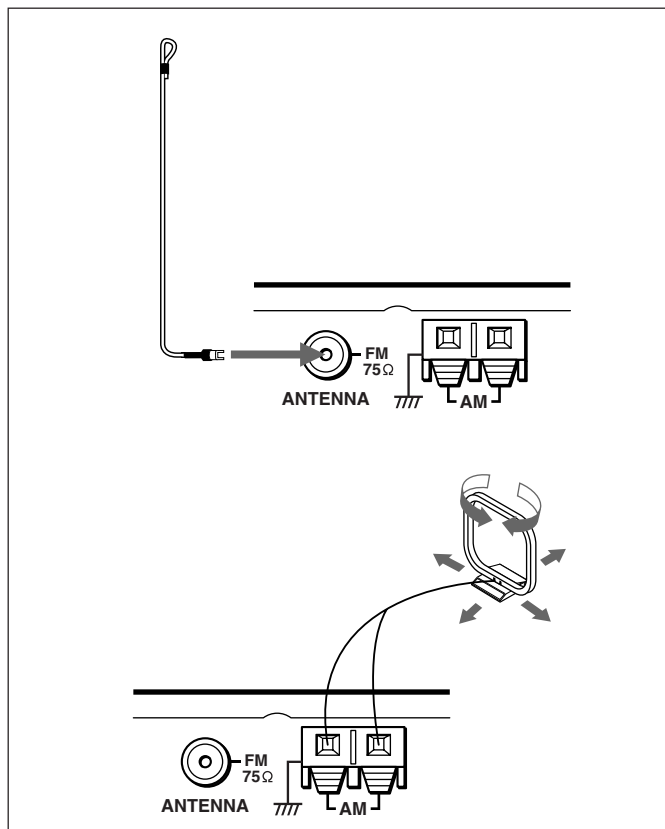

Connecting the included antennas

Connecting the FM indoor antenna

The FM indoor antenna is for indoor use only. Extend the antenna and move it in various directions until the clearest signal is received. Fix it with push pins or similar implements in the position that will cause the least amount of distortion.

If the reception is not very clear with the attached FM indoor antenna, the use of an outdoor antenna is recommended.

Connecting the AM loop antenna

The AM loop antenna is for indoor use only. Set it in the direction and position where you receive the clearest sound. Put it as far away as possible from the unit, TVs, speaker cables, and power cords. When reception is not satisfactory with the attached AM loop antenna alone, connection of an outdoor antenna is recommended.

Making antenna connections

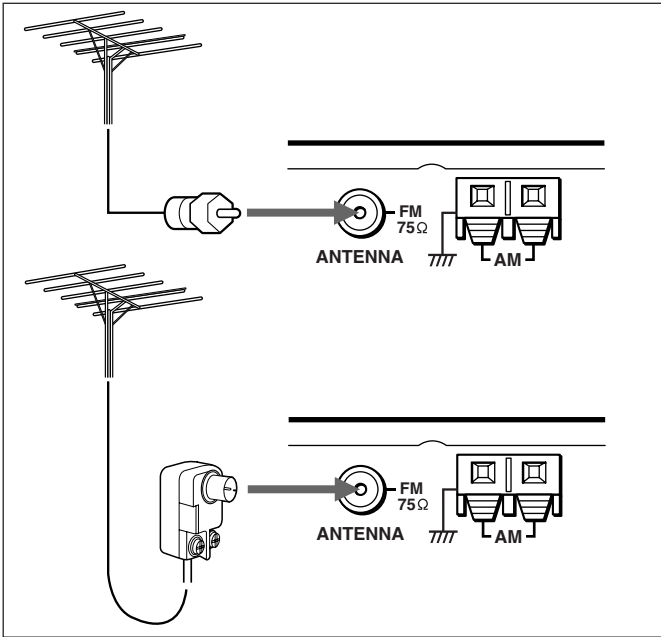

Connecting an FM outdoor antenna

Please make sure that you follow the considerations below regarding the location.

Keep the antenna away from noise sources (neon signs, busy roads, etc.).

It is dangerous to put the antenna close to power lines. Keep it well away from power lines, transformers, etc.

- To avoid the risk of lightning and electrical shock, grounding is necessary.

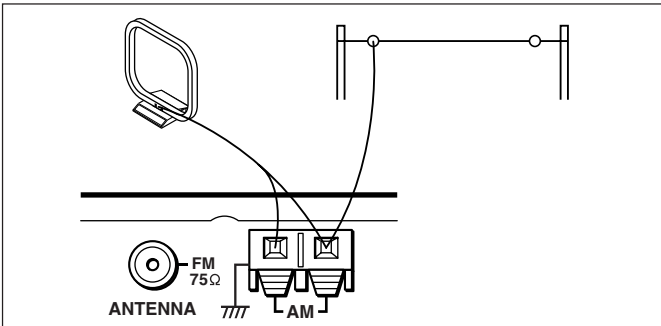

Connecting an AM outdoor antenna

The outdoor antenna will be more effective if it is stretched horizontally above a window or outside.

- Do not remove the AM loop antenna.
- To avoid the risk of lightning and electrical shock, grounding is necessary.

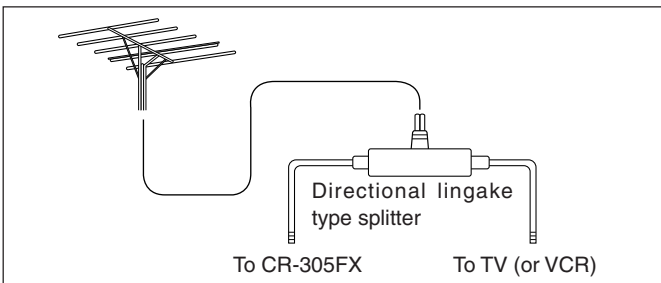

Directional linkage

Do not use the same antenna for both FM and TV (or VCR) reception since the FM and TV (or VCR) signals can interfere with each other. If you must use a common FM/TV (or VCR) antenna, use a directional linkage type splitter.

Control positions and names

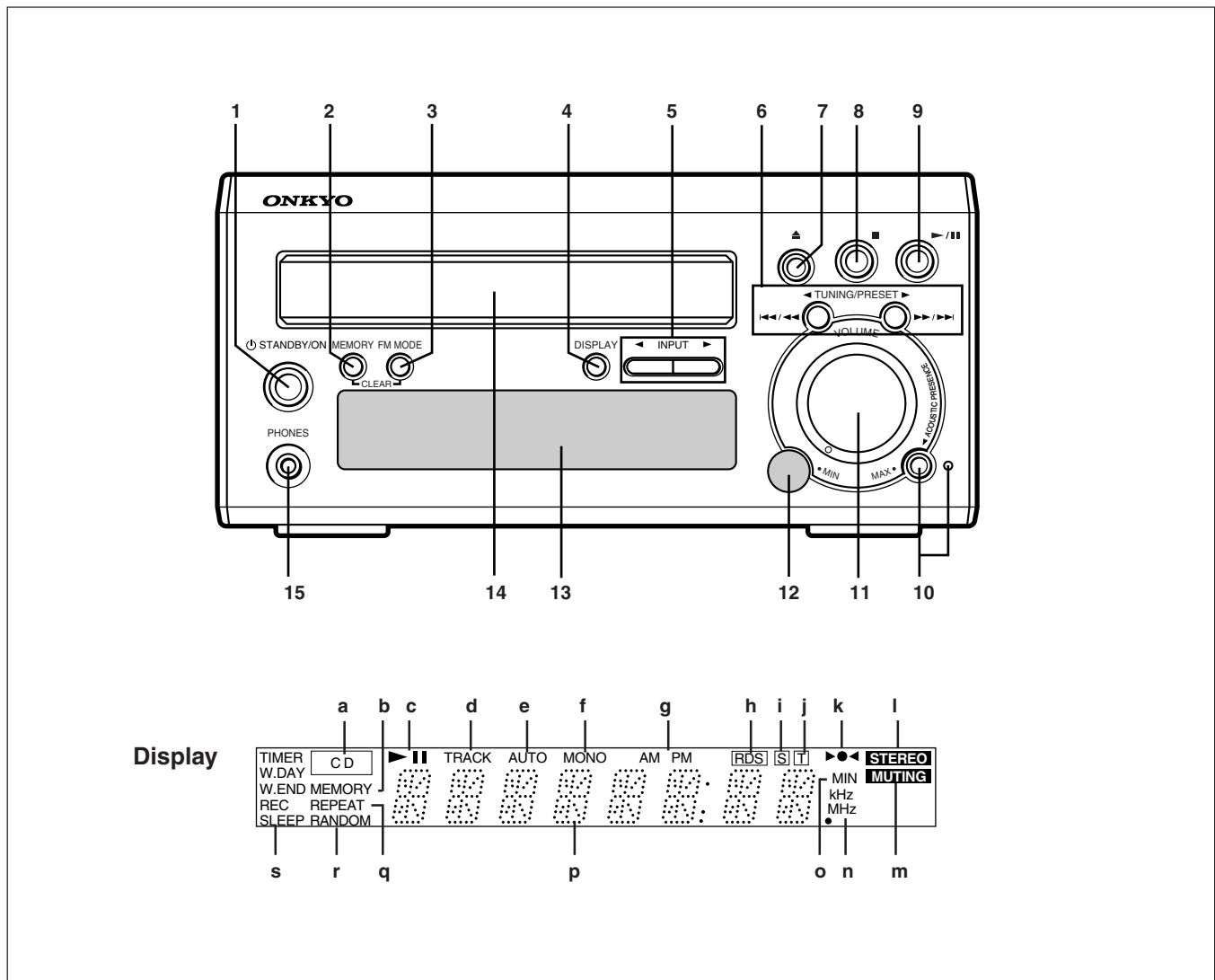

Front panel

For more information about buttons or knobs, refer to the pages listed in the brackets ([]) below.

1. STANDBY/ON button [9, 28, 30]
2. MEMORY button [20, 22 to 24]
3. FM MODE button [24]
4. DISPLAY button [21, 25]
5. INPUT ◀/▶ buttons [16, 18, 22 to 24]
6. TUNING/PRESET ◀/▶ buttons [22 to 24]
◀◀/▶▶ buttons [18, 20]
7. ▲ button [18, 20]
8. ■ button [18, 20]
9. ▶/■ button [16, 18, 20]
10. ACOUSTIC PRESENCE button and indicator [16]
11. VOLUME control knob [16]
12. Remote control sensor [5]
13. Display (Refer to the "Display" illustration.)
14. Disc tray [18]
15. PHONES jack [17]

Display

If a protective film on the surface of the screen making it difficult to read the display, remove the film.

- a. CD indicator
- b. MEMORY indicator
- c. ▶ II (play/pause) indicator
- d. TRACK indicator
- e. AUTO indicator
- f. MONO indicator
- g. AM/PM indicator
AM or PM lights up when you switch the clock setting to "12H" (12 hour display).
- h. RDS indicator (European models only)
- i. Single remaining time indicator
- j. Total remaining time indicator
- k. Tuning indicator
- l. STEREO indicator
- m. MUTING indicator
- n. Frequency indicators
- o. Sleep time indicator
- p. Multi display
- q. REPEAT indicator
- r. RANDOM indicator
- s. Timer setting indicators

Remote controller RC-617S

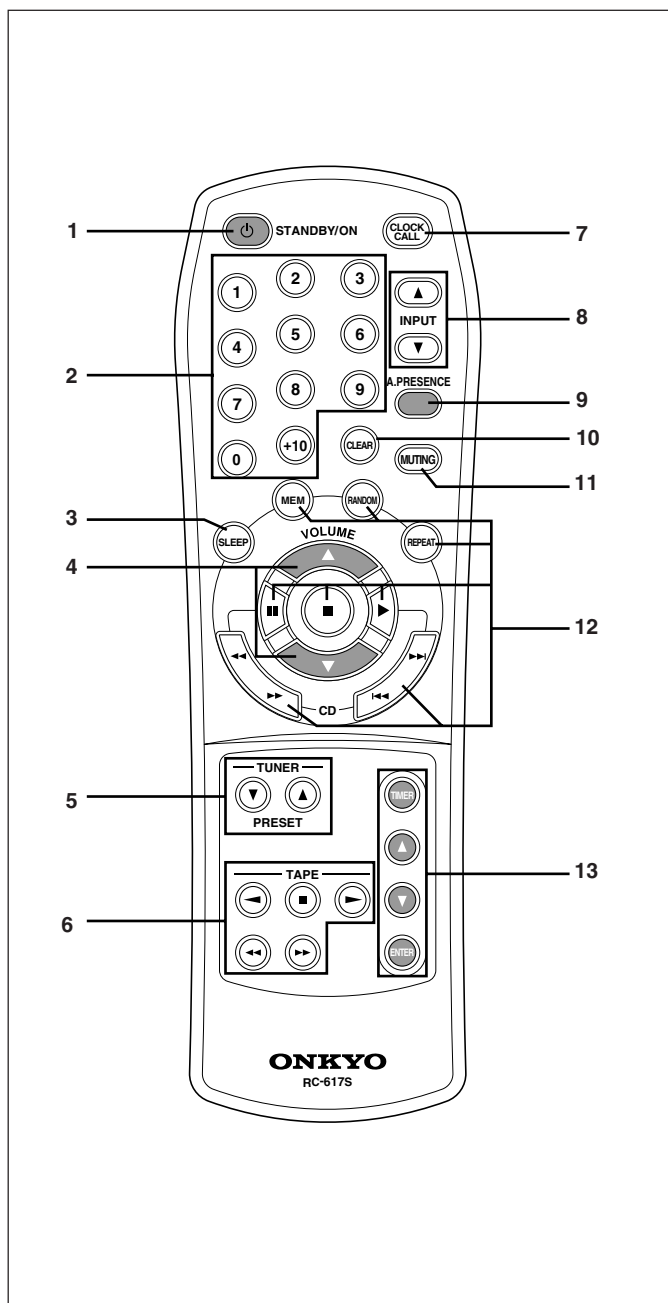

For more information about buttons or knobs, refer to the pages listed in the brackets ([]) below.

1. **STANDBY/ON button [9]**
Toggles between STANDBY and ON.
2. **Number buttons [18, 24]**
Used to select CD tracks or desired preset station.
3. **SLEEP button [31]**
Enables you to make the sleep time setting.
4. **VOLUME Δ (UP)/ ∇ (DOWN) buttons [16, 17]**
Enables you to increase or decrease the volume level.
5. **TUNER PRESET ∇ / Δ buttons [24]**
Enables you to select the PRESET stations.
6. **TAPE operation buttons [35]**
7. **CLOCK CALL button [15]**
Enables you to display the current time.
8. **INPUT ∇ / Δ buttons [16, 18, 22 to 24]**
Enables you to select a listening source.
9. **A. PRESENCE button [16]**
Enables you to switch acoustic presence off and types.
10. **CLEAR button [20]**
Used with memory playback.
11. **MUTING button [17]**
Enables you to mute the sound temporarily.
12. **CD operation buttons [16, 18 to 20]**
(MEM/RANDOM/REPEAT/II/■/▶/◀◀, ▶▶/◀◀, ▶▶)
13. **TIMER operation buttons [14, 15, 26 to 30]**
(TIMER/ ∇ / Δ /ENTER)
Enables you to make the settings of the clock, timer playback and recording.

Setting the clock

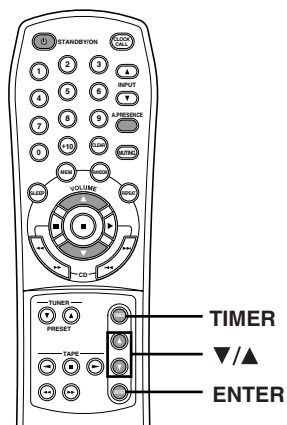

1	<p>↓</p>	ADJUST
2	<p>↓</p>	SUN
3	<p>↓</p>	SUN 9:30
4	<p>↓</p>	9:30

Setting the clock

- 1. Press the TIMER button until "ADJUST" is selected on the display, then press the ENTER button.**
The day of the week will flash on the display.
- 2. Press the ▼/▲ buttons until the desired day of the week is selected, then press the ENTER button.**
The time will flash on the display.
- 3. Use the ▼/▲ buttons to set the desired time.**
- 4. Press the ENTER button.**
The clock will start operating. When you set the clock while the unit is in the standby mode, the present time will continue to be displayed. When you set the clock while the unit is on, the normal display will be resumed.

Setting the clock

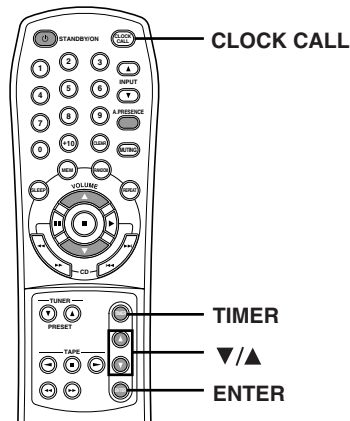

1

2

3

4

Switching between the 24 hour and 12 hour display settings

1. Press the **TIMER** button repeatedly to display “24H/12H.”
2. Press the **ENTER** button.
“24H” or “12H” flashes on the display.
3. Use the **▼/▲** buttons to select 24H (24 hour display) or 12H (12 hour display).
4. Press the **ENTER** button to confirm the setting.

Clock Call function

Press the **CLOCK CALL** button to display the time, press again to cancel the time display.

Note

- If the time has not been set, “ADJUST” will flash on the display. In this case, press again the **CLOCK CALL** button, then set the clock. (Refer to “Setting the clock” on page 14.)

Choosing the required source

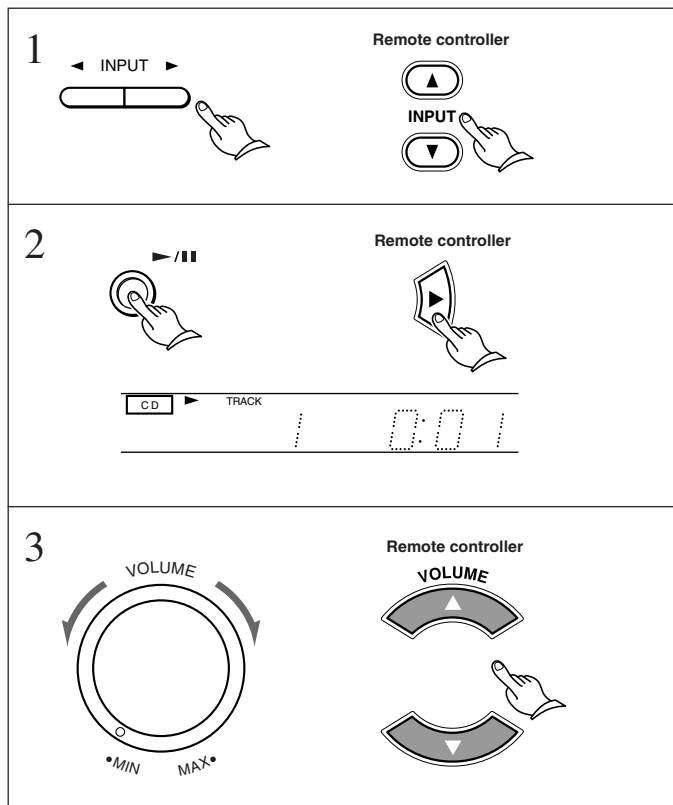
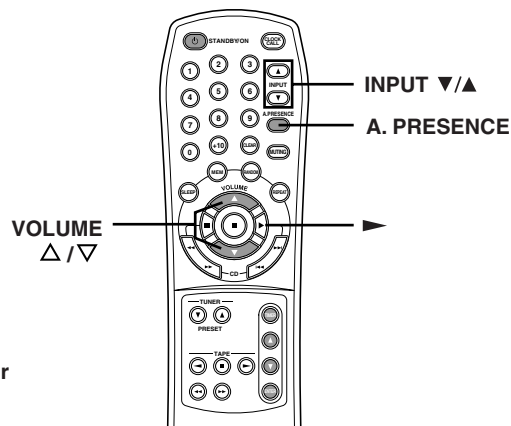
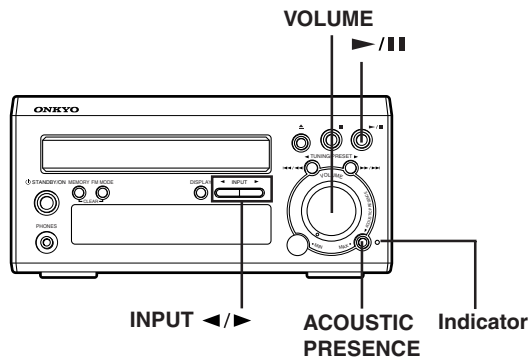

Choosing the required source

1. Press the INPUT ◀/▶ buttons or the INPUT ▼/▲ buttons on the remote controller to select the desired source.
Each time you press these buttons, the display changes as follows.
CD, CDR, TAPE, FM or AM
2. Start playing the source you selected in step 1.
The example shown on the left indicates that you have selected the CD as the source.
3. Set the volume to appropriate level using the VOLUME control or the VOLUME Δ (UP)/ ▽ (DOWN) buttons on the remote controller.
Turn the VOLUME control clockwise to increase the volume or counterclockwise to decrease the volume.

Adjusting the sound

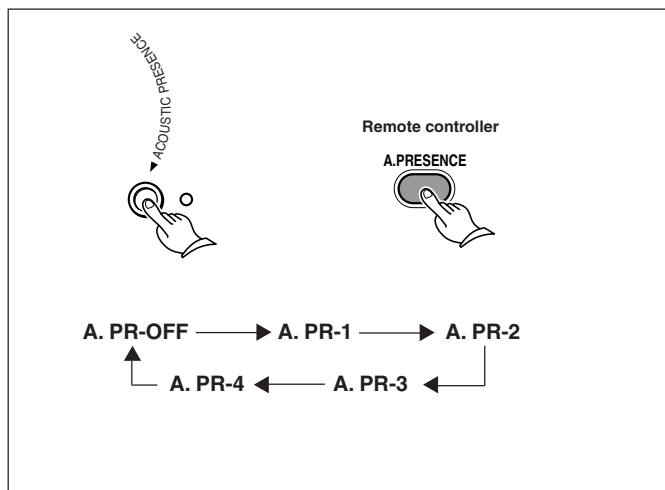

ACOUSTIC PRESENCE

Acoustic Presence reinforces super bass, bass and treble of the music through the use of exclusive Onkyo circuitry. You can enjoy the powerful sound with the following 4 presence settings.

Each press of the ACOUSTIC PRESENCE button or the A. PRESENCE button on the remote controller changes the mode as follows, and the indicator lights up while you are activating Acoustic Presence.

- A. PR-OFF:** Acoustic Presence is off.
- A. PR-1:** Super bass is reinforced.
- A. PR-2:** Bass is reinforced.
- A. PR-3:** Super bass and bass are reinforced at the same time.
- A. PR-4:** Treble is reinforced in addition to super bass and bass that are reinforced in the A. PR-3 mode.

Muting / Listening with the headphones

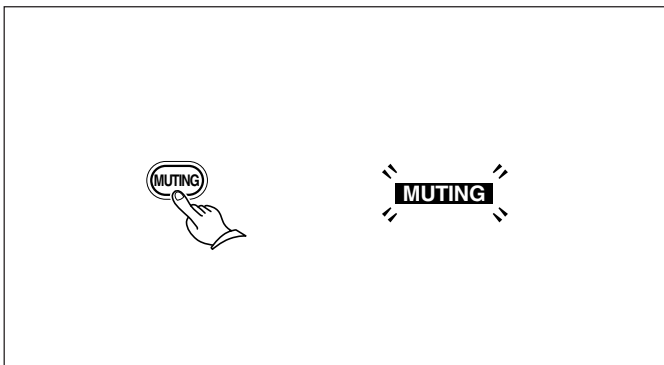
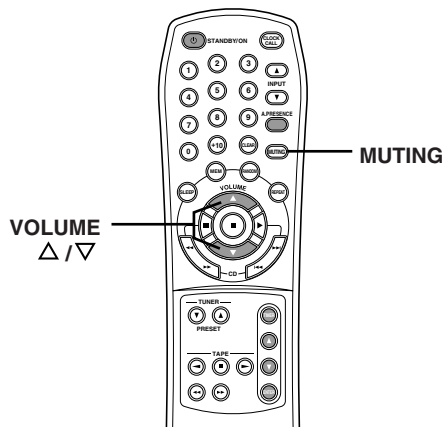
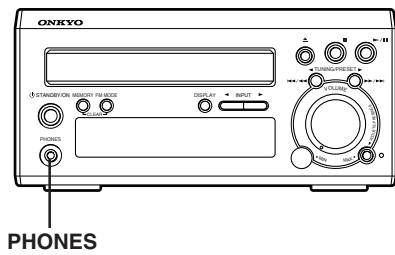

Muting the sound

Press the MUTING button on the remote controller to mute the sound. The MUTING indicator flashes on the display. To restore the sound, press the MUTING button again.

Tip

During muting,

- if you press the VOLUME Δ (UP)/ ▽ (DOWN) buttons on the remote controller, the MUTING indicator disappears then the sound will be restored, and
- if you turn the unit in Standby mode, and turn it on again, the MUTING indicator disappears.

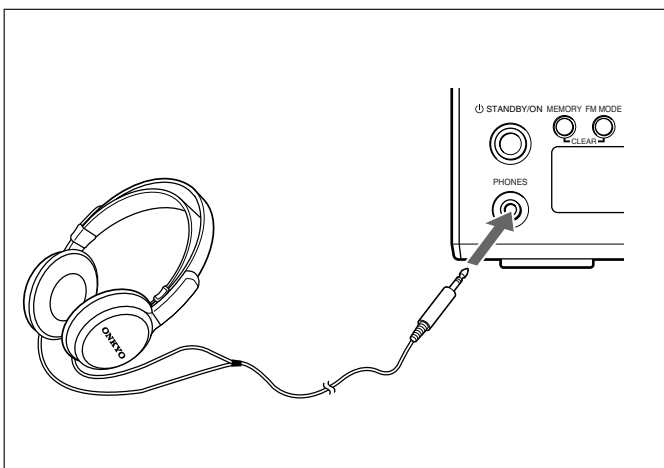

Listening with the headphones

Connect the stereo headphones mini plug to the PHONES jack. The speakers will reproduce no sound while the headphones are connected.

Tip

- You can adjust the sound through the headphones as well as through the speakers. See "Adjusting the sound" on the previous page for operations.

Playing a CD

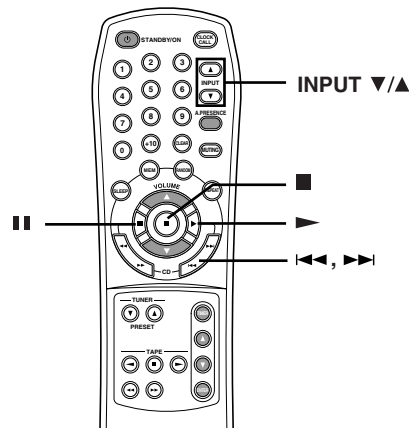
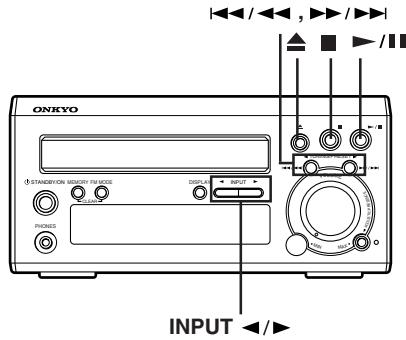

1

Label side

2

Remote controller

3

Remote controller

Playing a CD

1. Press the **▲** button to open the disc tray, and put the CD in the tray with the label side facing up. Put 8-cm discs within the center circle of the tray.

To close the disc tray, press the **▲** button.

2. Press the **INPUT ◀/▶** buttons or the **INPUT ▼/▲** buttons on the remote controller to switch the input source to CD.

The CD indicator lights up on the display.

3. Press the **▶/||** button or the **▶** button on the remote controller to start playback.

- Playback automatically stops when the last track has been played.
- If the unit is in Standby mode and there is a CD in the disc tray, it tunes on automatically and starts playback even if another source is selected when the **▶/||** button is pressed.
- If you switch the input source to FM or AM during playback, the unit pauses playback of the CD for as long as FM or AM is selected. To resume playback of the CD, switch the input source back to CD, then press the **▶/||** button or the **▶** button on the remote controller.

To stop playback,

- press the **■** button.

To pause,

- press the **▶/||** button or the **||** button on the remote controller. The **▶ ||** indicator lights up on the display.
- To restart playback, press the **▶/||** button or the **▶** button on the remote controller. Playback starts again from exactly where it left off.

Remote controller

Selecting the track to play

To locate the beginning of the playing track, press the **◀◀/◀◀** button or the **◀◀** button on the remote controller. To select the former track in reverse order, press the **◀◀/◀◀** button or the **◀◀** button on the remote controller. To select the next track in order, press the **▶▶/▶▶** button or the **▶▶** button on the remote controller.

If you have selected the track while the CD is stopped, press the **▶/||** button or the **▶** button on the remote controller to start playback.

Note

- It may take a while to start playing back CDs with many tracks.

Playing a CD

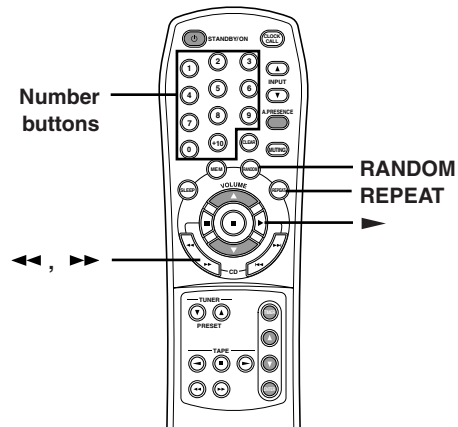
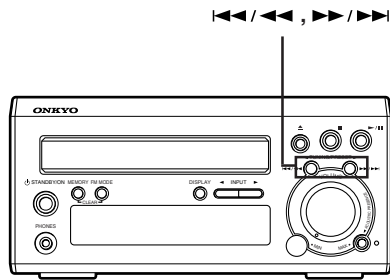

Examples:

- To select track 5: press **5**
- To select track 10: press **0**
- To select track 15: press **+10** → **1** → **5**

Tracks can also be selected by using the number buttons (remote controller only).

- Use buttons 1 to 9 to select tracks 1 to 9. Use button 0 to select track 10. To select track 11 and upwards, press the +10 button followed by the corresponding two number buttons. Playback starts automatically when tracks are selected by using the number buttons.

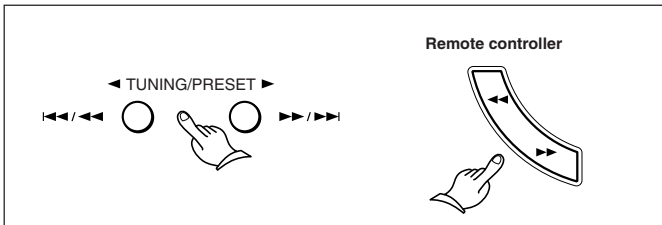

Locating a particular point of the track

Press and hold the **▶▶/▶▶▶** button or **▶▶** button on the remote controller for fast forwarding, and the **◀◀/◀◀◀** button or the **◀◀** button on the remote controller for fast reversing during playback or pause until you find the point you want.

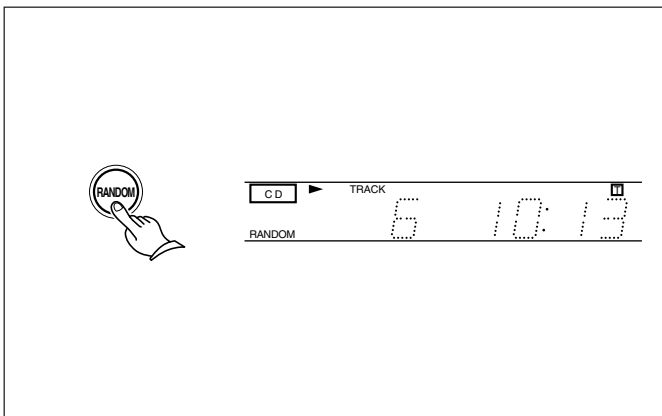

RANDOM playback (remote controller only)

All the tracks on the disc will be shuffled, then played back. To start RANDOM playback, press the RANDOM button while the CD is stopped, or press the RANDOM button during playback.

- You can combine the RANDOM mode with the MEMORY mode. In this case, the programmed tracks are played back in random order. (Refer to "MEMORY playback" on page 20.)

To cancel RANDOM playback,

- press the RANDOM button again. The RANDOM indicator disappears.

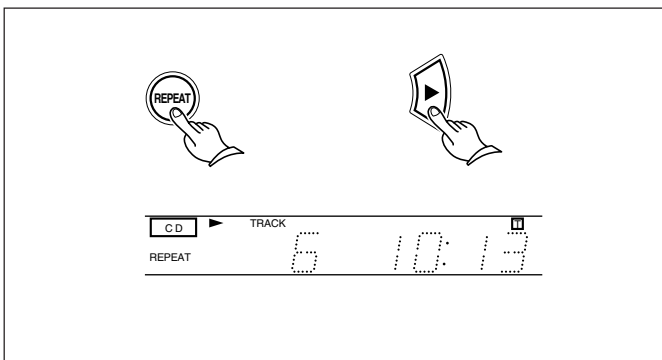

REPEAT playback (remote controller only)

The REPEAT mode plays back a CD repeatedly. Press the REPEAT button and then press the **▶** button, or press the REPEAT button during playback.

- You can combine the REPEAT mode with the MEMORY mode. In this case, the programmed tracks are played back repeatedly. (Refer to "MEMORY playback" on page 20.)

To cancel REPEAT playback,

- press the REPEAT button again. The REPEAT indicator disappears.

Playing a CD

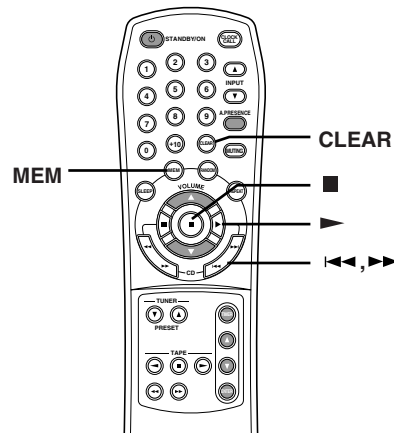
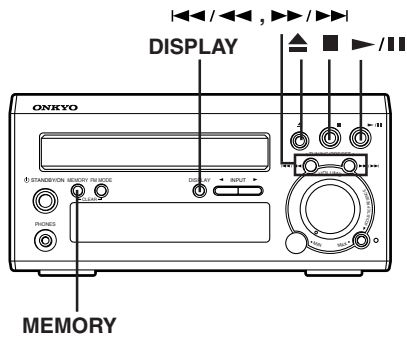

1

MEMORY Remote controller

CD MEMORY TRACK 0 0:00

2

Remote controller

← TUNING/PRESET →

CD MEMORY TRACK 6 10:13

MEMORY Remote controller

CD MEMORY TRACK 6 P-1

↓

CD MEMORY TRACK 6 10:13

3

Remote controller

CD MEMORY TRACK 6 0:01

MEMORY playback

You can select and store track numbers (up to 20) in the desired playback order.

1. Press the **MEMORY** button while the CD is stopped.
2. Press the **◀◀/▶▶** buttons to select the first track you would like to play back, then press the **MEMORY** button.
 - To select the next track to be played, repeat this step.
3. Press the **▶/||** button to start **MEMORY** playback.
 - When the unit finishes playing the track which number you stored last, playback stops. The track numbers stored in memory will be retained.

Remote controller operation

1. Press the **MEM** button while the CD is stopped.
2. Press the **◀◀**, **▶▶** buttons to select the first track you would like to play back, then press the **MEM** button.
 - To select the next track to be played, repeat this step.
3. Press the **▶** button to start **MEMORY** playback.
 - When the unit finishes playing the track which number you stored last, playback stops. The track numbers stored in memory will be retained.

Notes

- If you try to store more than 20 tracks into memory, "FULL" flashes on the display to indicate that the memory is full.
- If the **MEMORY** button (or **MEM** button on the remote controller) is pressed during playback, the playing track is stored into memory.

To stop MEMORY playback,

- press the **■** button during MEMORY playback.

To remove the last track in the program,

- while MEMORY playback is stopped, press the **CLEAR** button on the remote controller. Each time you press it the last track in the program is removed.

To cancel MEMORY playback mode,

- press the **MEMORY** button (or **MEM** button on the remote controller). The **MEMORY** indicator disappears.

To erase all track numbers from memory,

- while in MEMORY playback mode, and the CD is stopped, press the **▲** button.

Playing a CD

Changing the display information

Pressing the DISPLAY button repeatedly during playback will change the display information as follows:

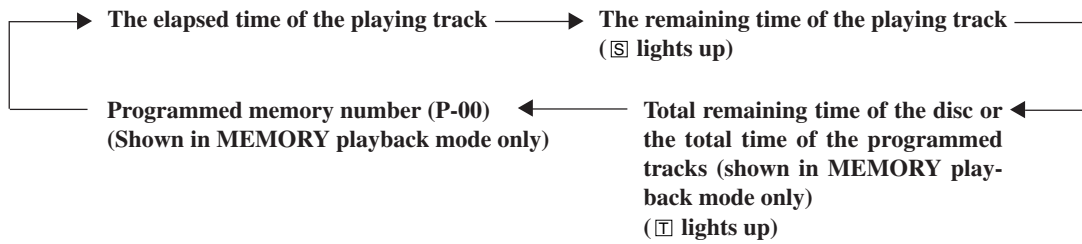

Note

- “- -: -” will be displayed,
- if the playing track number is 21 or more, or
 - if the total playing time of the programmed tracks exceeds 99 minutes and 59 seconds, or
 - if you try to store more than 20 tracks into memory.

Precautions for handling the Compact Disc (CD)

This section shows you how to handle, clean, and store discs.

On handling Discs

- Do not touch the playback side of the disc.
- Do not attach paper or tape to discs.

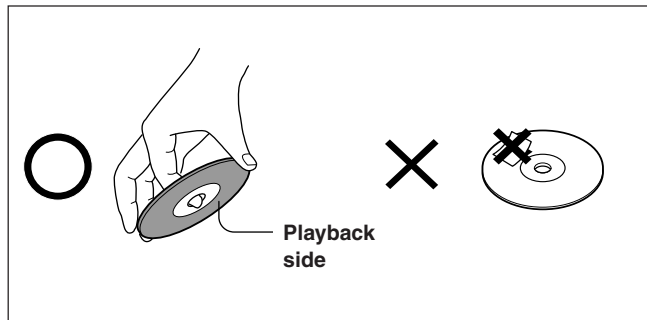

On Cleaning discs

- Fingerprints and dust on the disc cause sound deterioration. Wipe the disc from the center outwards with a soft cloth. Always keep the disc clean.
- If you cannot wipe off the dust with a soft cloth, wipe the disc lightly with a slightly moistened soft cloth and finish with a dry cloth.
- Do not use any type of solvent such as thinner, benzene, commercially available cleaners or antistatic spray for vinyl LPs. It may damage the disc.

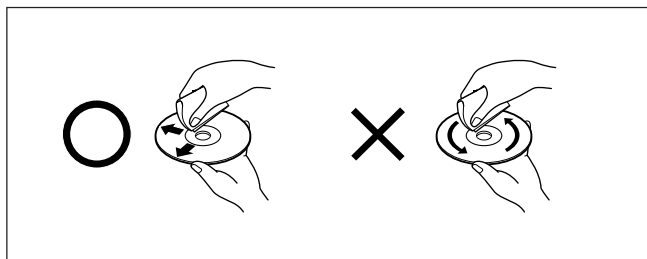

On storing Discs

- Do not store discs in a place subject to direct sunlight or near heat sources.
- Do not store discs in places subject to moisture and dust such as bathroom or near a humidifier.
- Store discs vertically in a case. Stacking or placing objects on discs outside of their case may cause warping.

Playable Discs

This unit can play back the following discs.

	Disc mark	Contents	Disc size	Maximum playback time
Audio CDs		Audio	12 cm	Approx. 74 minutes
			8 cm (CD single)	Approx. 20 minutes

- You cannot play back discs other than those listed above.
- You cannot play discs such as CD-R, CD-RW, CD-ROM, etc., even if the marks in the above table are labeled on those discs.
- Avoid using heart-shaped or octagonal discs. Playing irregularly shaped discs may damage the internal mechanism of this unit.

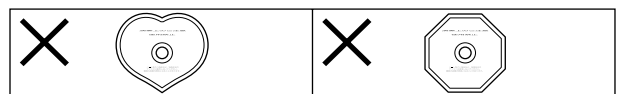

- Do not use discs that have residue from adhesive tape, rental discs that have peeling labels, or discs that have custom labels or stickers. Otherwise, you may not be able to eject the discs, or the unit may become inoperative.

Receiving stations

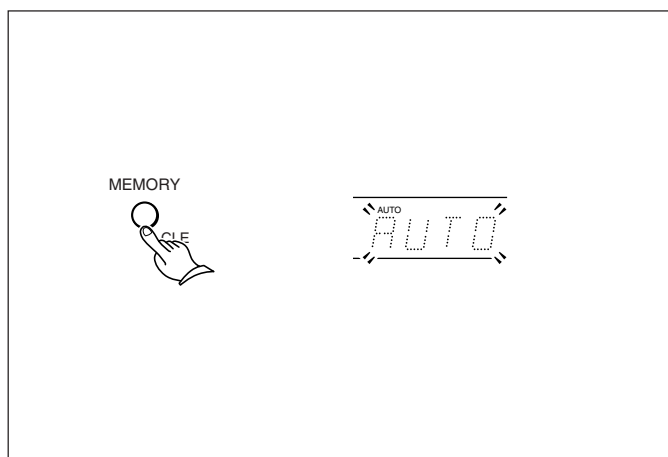
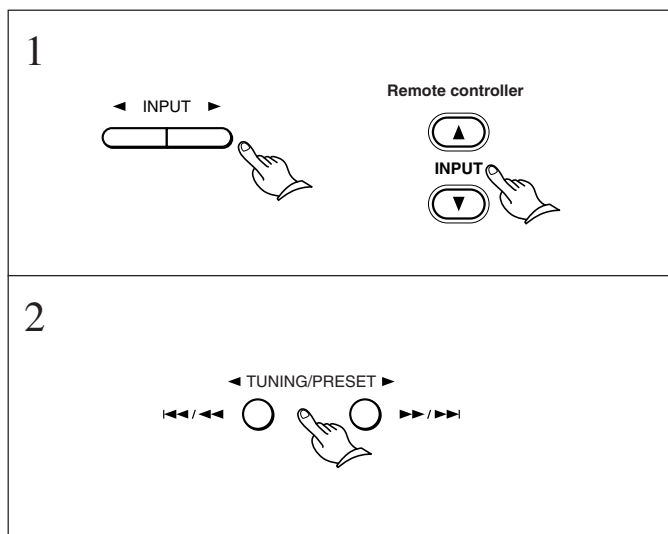
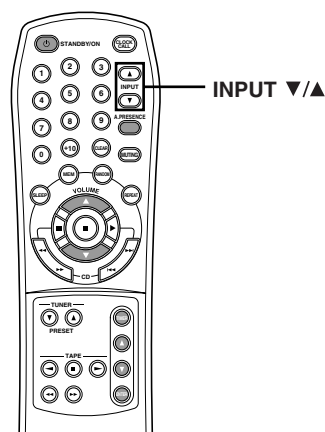
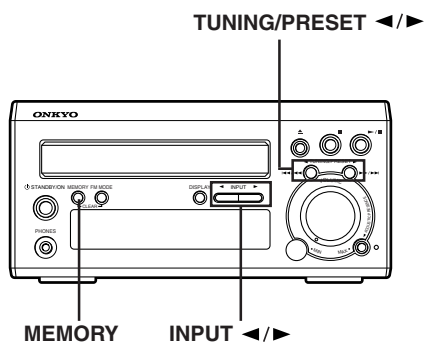

Tuning the radio

1. Select FM or AM using the INPUT ◀/▶ buttons or the INPUT ▼/▲ buttons on the remote controller.
2. Press and hold the TUNING/PRESET ◀/▶ buttons for about 0.5 seconds to change the frequency.

The indoor antenna should be installed on a wall or other surface in the position which gives the best reception. For more information on how to install the antenna, refer to pages 10 and 11.

To fine-tune the frequency, use the TUNING/PRESET ◀/▶ buttons while the frequency is flashing.

Using Auto Memory (FM only)

This function enables you to store the frequencies into memory automatically, without having to go through and store each frequency manually.

In FM mode, hold down the MEMORY button for a few seconds. The MEMORY indicator lights up on the display and "AUTO" will start flashing on the display. Keep holding down the button for a few more seconds to start the Auto Memory function.

The frequencies are scanned from low to high. Up to 30 FM stations with the best signal quality are selected, sorted in order from low to high frequency, and stored into the preset memory.

Note

- All stations previously stored in memory will be replaced with new Auto Memory stations.

Receiving stations

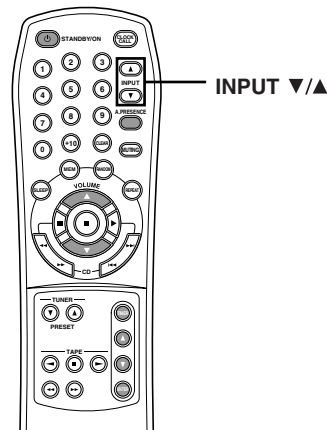
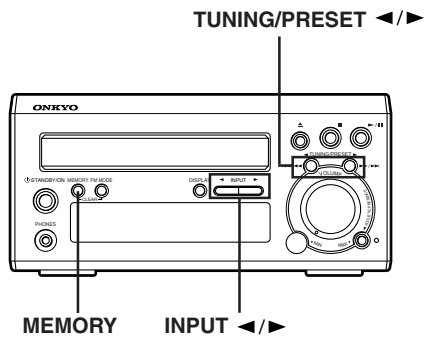

1	<p>Remote controller</p> <p>INPUT</p>
2	<p>TUNING/PRESET</p>
3	<p>MEMORY</p> <p>Lit</p> <p>Flash</p> <p>MEMORY FM P- STEREO</p>
4	<p>TUNING/PRESET</p> <p>Lit</p> <p>Flash</p> <p>MEMORY FM AUTO P- 1 MHz STEREO</p>
5	<p>MEMORY</p> <p>Disappear</p> <p>Selected preset number</p> <p>MEMORY FM AUTO P- 1 MHz STEREO</p> <p>After the brief appearance of the above information, the display shows the frequency that is stored into the selected preset number.</p>

Presetting your favorite stations

You can store your favorite stations in the preset memory. Follow the procedure below:

1. Select FM or AM using the INPUT ◀/▶ buttons or the INPUT ▼/▲ buttons on the remote controller.
2. Press and hold the TUNING/PRESET ◀/▶ buttons for about 0.5 seconds to select the frequency of your favorite station. The ▶◀ indicator lights up on the display when the broadcasting station is properly tuned in. The frequency is changed in 50 kHz steps in FM and 9 kHz steps in AM. To fine-tune the frequency, use the TUNING/PRESET ◀/▶ buttons while the frequency is flashing.
3. Press the MEMORY button. The MEMORY indicator lights up and “-” will flash.
4. While “-” is flashing, use the TUNING/PRESET ◀/▶ buttons to select the preset number into which to store the station frequency. The preset number will flash on the display.

Note

If you select a preset number into which a station has already been programmed, the number will flash rapidly. If you proceed with this number, the original station will be replaced by a new station.

5. While the number is flashing, press the MEMORY button. The frequency will be stored into the selected preset number.

Notes

- Up to 30 stations can be stored in the preset memory.
- If you try to store more than 30 stations, “FULL” appears on the display and you cannot store any more.
- If the FM station received is an RDS station that has a PS (Program Service Name), the frequency display will change to the PS display. (Refer to page 25 for more information on the RDS function.) RDS reception is available only on the European models.

Receiving stations

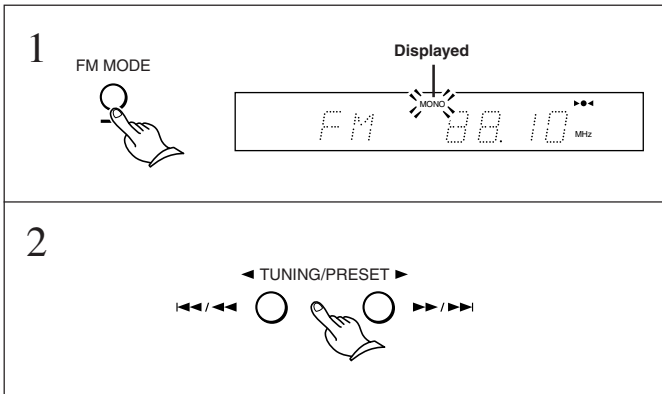
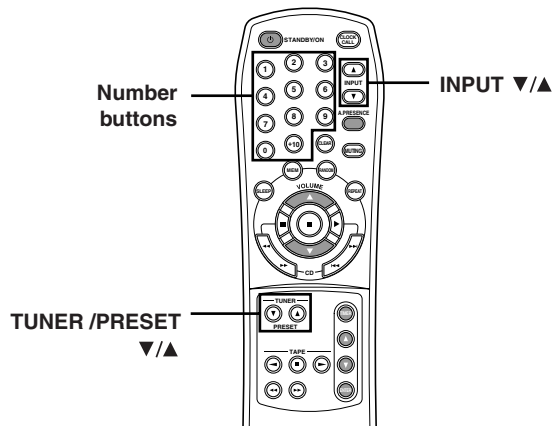
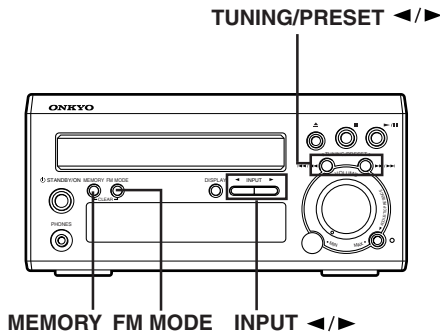

Listening to a stereo radio station

When you tune in a stereo FM station, the STEREO indicator lights up if the signal is sufficiently strong. If the signal is weak, you can still listen to the station in mono mode. In this case, tune in as follows.

1. **Press the FM MODE button.**
The MONO indicator lights up.
2. **Select the station you would like to listen to using the TUNING/PRESET </> buttons.**

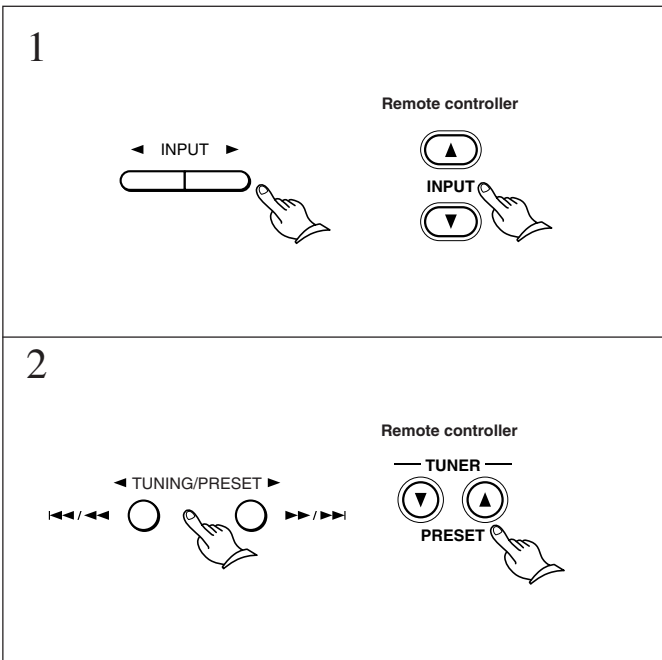

Selecting preset stations

Follow the procedure below to select a preset station stored in memory.

1. **Select FM or AM using the INPUT </> buttons or the INPUT <v>/<^> buttons on the remote controller.**
2. **Use the TUNING/PRESET </> buttons or the TUNER PRESET <v>/<^> buttons on the remote controller to select the desired preset station.**

The preset station can also be selected by using the number buttons on the remote controller.

- Use buttons 1 to 9 to select presets 1 to 9. Use button 0 to select preset 10. To preset station 11 and upwards, press the +10 button followed by the corresponding two number buttons.

Examples:

- 5: (5)
- 12: (+10) → (1) → (2)
- 25: (+10) → (2) → (5)

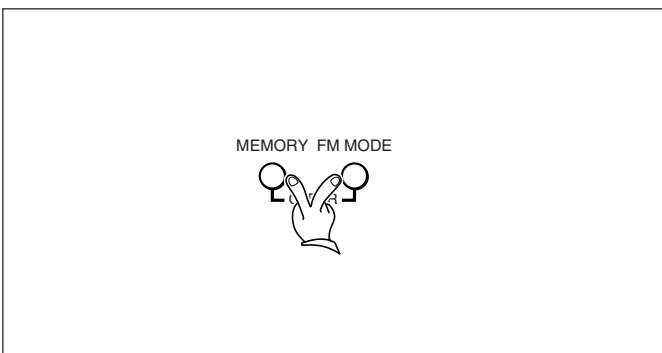

Clearing preset stations

You can clear preset stations from the preset memory.

1. **Select the station as explained in the previous section.**
2. **Press and hold the MEMORY button and press the FM MODE button within a second.**
“—” appears on the display.

Note

- If you fail to press the FM MODE button while holding down the MEMORY button immediately, the AUTO MEMORY function will start operating.

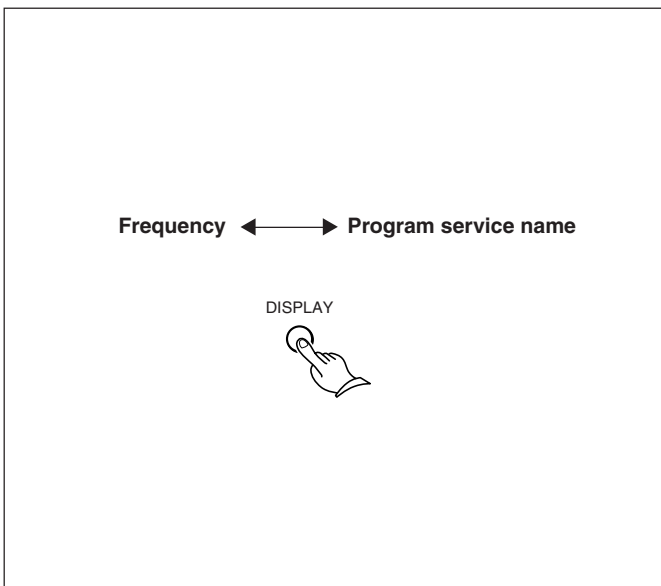
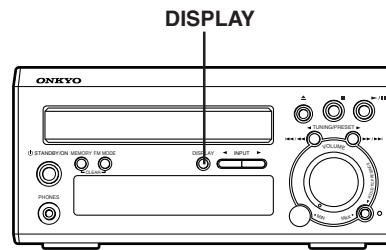

Receiving RDS (European models only)

RDS reception is available only on the European models, and only in areas where RDS broadcasts are available.

What is RDS?

Many FM stations now transmit RDS signals which contain additional information. RDS provides you with various services so that you can choose a station broadcasting your favorite categories of music or other information. The information below is available through the CR-305FX.

PS: Program Service Name

The RDS indicator lights up when an RDS station is received.

Note

- If radio signals are weak, RDS may not be received.

Displaying Program Service Name (PS)

If the current station you are listening to is an RDS station which contains PS information, the display changes as on the left each time you press the DISPLAY button.

Using the timer

The CR-305FX features a Timer function that enables you to start playing or recording a specified component at a specified time. To use this function, you need to connect this unit to other components via **RI** REMOTE CONTROL jacks. Refer to “Connecting the **RI** remote control cables” and “What can you do with the other ONKYO components by connecting with an **RI** remote control cables?” on page 7 for more information on making the connections. The timer function can be performed only by using the remote controller.

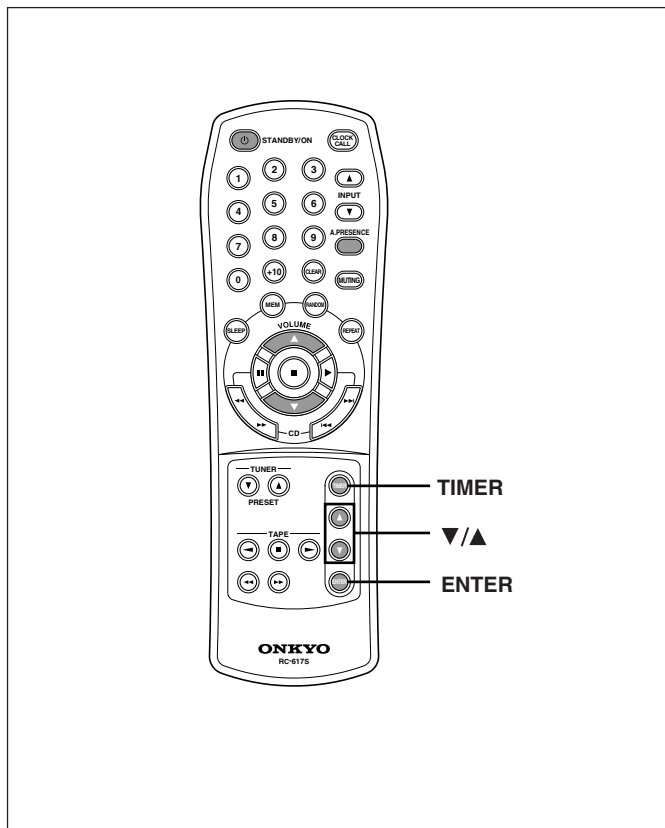

Buttons and modes for the Timer function (remote controller only)

The following buttons and setting modes are used to operate the Timer function.

TIMER button

Use this button to select a timer mode. The timer mode will change each time you press this button.

▼/▲ buttons

Use these buttons to select the details of the mode or to change values.

ENTER button

Use this button to enter the selected mode or numbers.

Timer setting modes

- **WEEKDAY:** This mode enables you to listen to a specified component at a designated time on weekdays.
- **WEEKEND:** This mode enables you to listen to a specified component at a designated time on weekends.
- **REC:** This mode enables you to record your favorite broadcasting program(s) starting at a designated time.
- **DAY SET:** This mode enables you to change the day setting (definition) of WEEKDAY or WEEKEND.
- **ADJUST:** This mode enables you to set and adjust the clock. If you have adjusted the clock, you do not need to set it again.

Using the timer

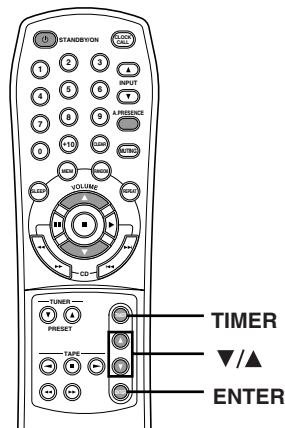

1

SMTWTFSS

DAY SET

2

SMTWTFSS

WEEKEND

3

SMTWTFSS

S _ _ _ S

4

SMTWTFSS

S _ _ _ S

5

SMTWTFSS

S _ _ _ T _ S

6

Changing the WEEKDAY and WEEKEND settings

You can define or change which day is WEEKDAY or WEEKEND. You can also define the day as both WEEKDAY and WEEKEND in order to program two timer settings on the same day.

The initial factory settings are:

WEEKDAY : Monday - Friday
 WEEKEND : Saturday and Sunday

1. Press the **TIMER** button repeatedly until “DAY SET” appears on the display, then press the **ENTER** button.
2. Press the **▼/▲** buttons to select “WEEKEND” or “WEEKDAY”. “END” or “DAY” flashes.
3. Press the **ENTER** button.
The current WEEKDAY or WEEKEND setting will be displayed.
4. Press the **ENTER** button repeatedly to display the flashing bar cursor of the day you would like to select.
5. Press the **▼/▲** buttons to display the desired day of the week. Pressing the **▼/▲** buttons repeatedly toggles between the day indication and the bar cursor (_).
6. Press the **ENTER** button to confirm the selection.
When you press the **ENTER** button while the character or bar cursor at the right end is flashing, the unit completes the setting.

Using the timer

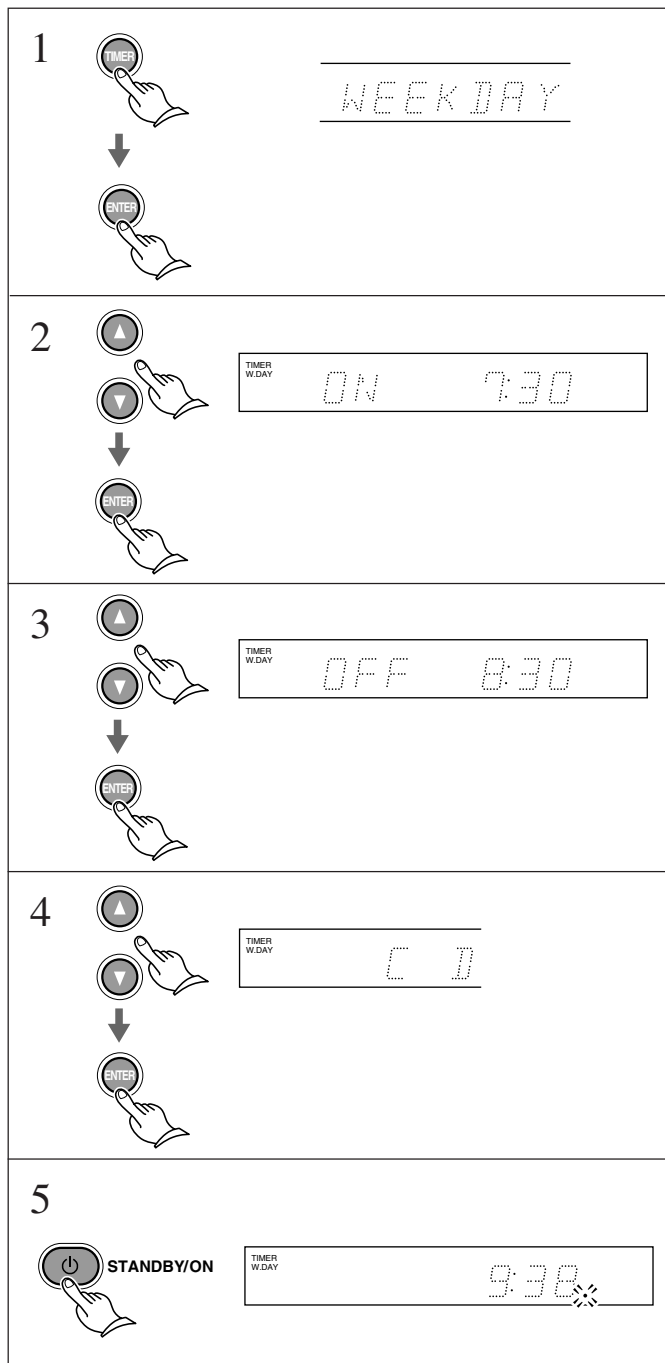
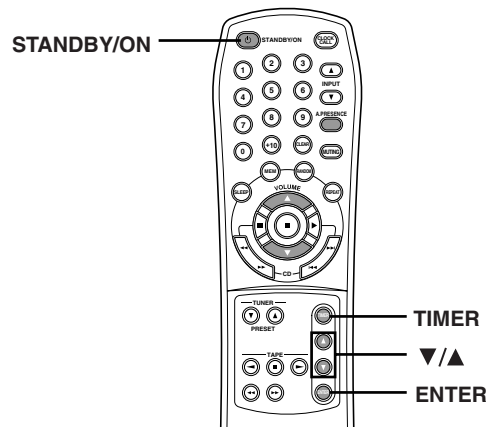

Programming to play at a specified time

The clock of this unit must be set correctly before programming the timer. Before using the timer for listening to or recording broadcast programs, you need to store the preset stations. (Refer to "Presetting your favorite stations" on page 23 for information how to preset stations.)

1. Press the **TIMER** button repeatedly until "WEEKDAY" or "WEEKEND" is displayed, and press the **ENTER** button.
2. Press the **▼/▲** buttons to set the **ON** time, and press the **ENTER** button.

Note

When you store the ON time, the display automatically indicates that the OFF time is one hour after the ON time you specified.

3. Press the **▼/▲** buttons to select the **OFF** time, and press the **ENTER** button.
4. Press the **▼/▲** buttons to select the **source**, and press the **ENTER** button.

Each time you press the **▼/▲** buttons, the display changes as follows.

FM, AM, CD, CDR, TAPE

If you select "FM" or "AM", press the **▼/▲** buttons again to select the preset number and press the **ENTER** button.

5. Press the **STANDBY/ON** button on the remote controller to set the **Standby mode**.

Note

- Make sure that the specified source component is connected to this unit, and that the CD-R, or cassette tape has been inserted into the appropriate component.

Using the timer

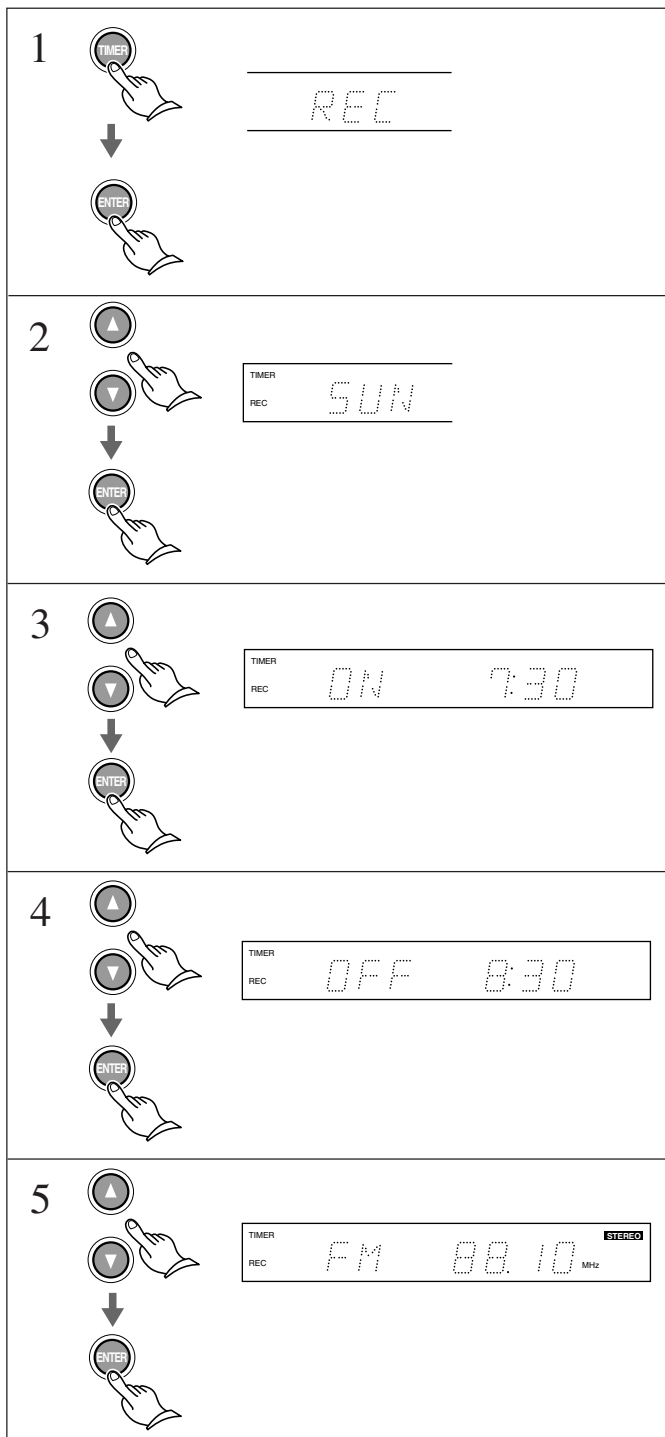
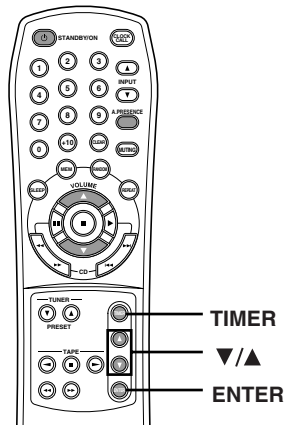

Programming to record at a specified time

REC mode of the Timer function enables you to record a specified source at a specified time.

To perform timer recording, you need to use a stereo cassette tape deck that is made by ONKYO, featuring the **RI** mark. Make sure the unit and the recording component are correctly connected with the **RI** remote control cable before timer recording. (Refer to “Connecting the **RI** remote control cables” on page 7.)

1. Press the **TIMER** button repeatedly until “REC” appears on the display, then press the **ENTER** button.
2. Press the **▼/▲** buttons to select the day of the week when you would like to start recording, then press the **ENTER** button. You can select “NEXT” instead of the day of the week. If you do so, recording will start at the next occurrence of the indicated time.
3. Press the **▼/▲** buttons to set the **ON** time, and press the **ENTER** button.

Note

When you store the ON time, the display automatically indicates that the OFF time is one hour after the ON time you specified.

4. Press the **▼/▲** buttons to set the **OFF** time, then press the **ENTER** button.
5. Press the **▼/▲** buttons to select **FM** or **AM**, and press the **ENTER** button. Press the **▼/▲** buttons again to select the preset number, then press the **ENTER** button.

Using the timer

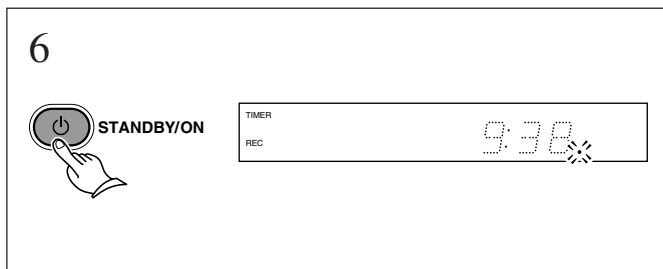
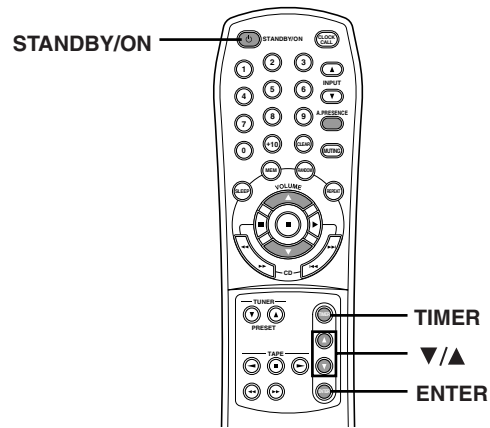

6. Press the STANDBY/ON button on the remote controller to set the Standby mode.

Notes

- Since muting is automatically turned on when the timer is used to record, the sound cannot be heard during recording. To monitor recording, press the MUTING button on the remote controller to cancel muting.
- Timer recording is activated once. After recording, the REC mode setting will be cancelled.

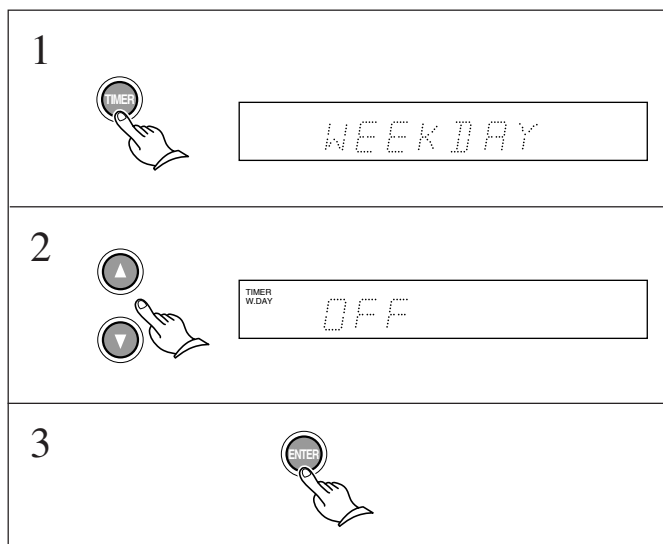

Switching the timer ON/OFF

You can switch the timer ON/OFF to cancel the timer setting, to enable the timer again, or to perform timer recording again. When the Timer function is enabled, the selected timer mode such as "WEEKDAY", "WEEKEND", and "REC" appears in the upper left corner of the display.

Note

To switch the timer ON, first you need to program the time value.

1. Press the **TIMER** button repeatedly until the timer mode (**WEEKDAY**, **WEEKEND** or **REC**) that you would like to enable or disable appears on the upper left corner of the display.
2. Press the **▼/▲** buttons to switch the selected mode **ON** or **OFF**.
3. Press the **ENTER** button to confirm the selection.

Using the timer

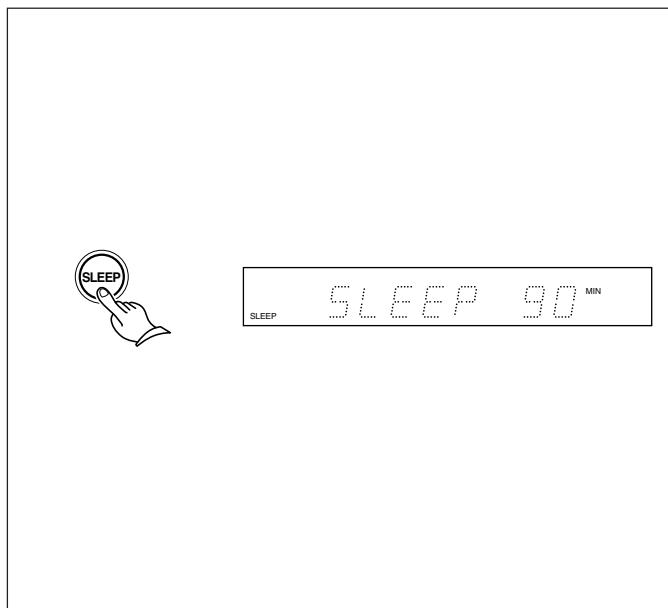
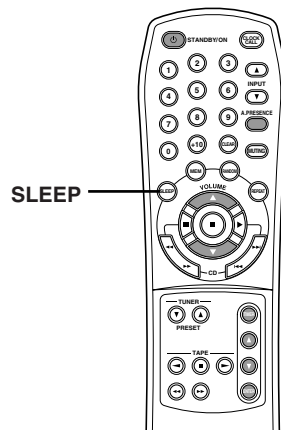

Sleep function

The Sleep function can be performed only by using remote controller.

The SLEEP timer automatically sets the entire system to Standby mode after a specified period of time.

1. Start playing something you would like to listen to.
2. Press the SLEEP button repeatedly to set the desired sleep time.

The time value will decrease from 90 minutes to 10 minutes in steps of 10 minutes.

After a specified period of time, the unit will be automatically placed in Standby mode.

- To check the remaining time while the SLEEP function is active, press the SLEEP button.
- After CD dubbing is complete, the unit will be placed in Standby mode.

Cancelling the SLEEP setting

Press the SLEEP button repeatedly until the SLEEP indicator on the display disappears.

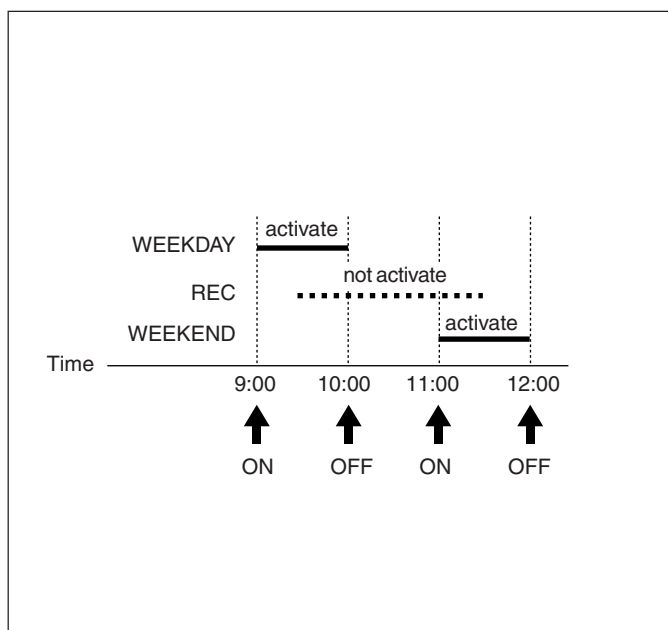

Notes for timer setting

- Make sure that the clock has been set correctly before setting the timer.
- After setting the timer, be sure to set this unit in Standby mode. If this unit is not in Standby mode, the timer will not work.
- When the power is turned on by one of the timer mode settings, the other timer modes may not be activated at their ON time. The power will be switched off by the first timer mode at its OFF time. Set a gap of one minute or more between the OFF time and ON time for each timer setting. (See the figure on the left.)
- If you press the SLEEP button during timer play or timer recording, the power will be switched off at the SLEEP timer's OFF time.
- If more than two timer mode settings are made at the same time, the "WEEKDAY" setting has the priority over the "WEEKEND" setting. The "REC" mode setting has no priority.
- The timer recording setting will be cancelled if the recording does not start at the ON time (for example, if the power is already on).

Troubleshooting

If you have any problems with the unit, please check the troubleshooting table below first. For any problems not covered in the table, please consult your nearest ONKYO authorized service center.

Trouble	Cause	Remedy	See page
The unit doesn't turn on.	<ul style="list-style-type: none"> The AC power cord is not fully inserted into the wall outlet. 	<ul style="list-style-type: none"> Insert the AC power cord (mains lead) plug into the wall outlet (the mains) securely. 	9
Sound is reproduced from neither left or right speaker.	<ul style="list-style-type: none"> The wire of the speaker cord is touching the other jacks, connectors, or metal parts. The volume level is turned down to the minimum. The sound is muted with the muting function. The headphones are connected to the PHONES jack. 	<ul style="list-style-type: none"> Check the speaker connections. 	8
		<ul style="list-style-type: none"> Adjust the volume level. 	16
		<ul style="list-style-type: none"> Press MUTING button on the remote controller to restore the sound. 	17
		<ul style="list-style-type: none"> Turn down the volume level first, then disconnect the headphones. Then, readjust the volume level. 	17
Sound is reproduced from only one speaker.	<ul style="list-style-type: none"> The speaker cord is not connected properly or firmly, or is disconnected. 	<ul style="list-style-type: none"> Check the speaker connections. 	8
No sound is reproduced when the (wake-up) timer operates.	<ul style="list-style-type: none"> The volume level is turned down to the minimum. 	<ul style="list-style-type: none"> Adjust the volume to the proper level when you set the timer. 	16
The remote controller doesn't operate.	<ul style="list-style-type: none"> The batteries in the remote controller are dead. The remote controller is out of the control range. There is some obstruction between the remote controller and the unit. 	<ul style="list-style-type: none"> Replace the batteries with new ones. 	5
		<ul style="list-style-type: none"> Operate the remote controller within the control range. 	5
		<ul style="list-style-type: none"> Try to operate the remote controller from a different angle, or remove the obstruction. 	5
AM stations cannot be received.	<ul style="list-style-type: none"> AM loop antenna is not attached. 	<ul style="list-style-type: none"> Connect the supplied AM loop antenna to the AM antenna terminals. 	10
Buzzing noise on AM (particularly conspicuous at night or with weak stations).	<ul style="list-style-type: none"> Noise from electrical apparatus such as fluorescent lamp. 	<ul style="list-style-type: none"> Move the AM loop antenna to different position. 	10
		<ul style="list-style-type: none"> Set up an outdoor AM antenna. 	11
High-pitched noise or buzzing noise on AM.	<ul style="list-style-type: none"> Noise from TV set. 	<ul style="list-style-type: none"> Place the AM loop antenna as far as possible from the TV. Move unit away from TV set. 	10 –
Crackling noise on AM, FM.	<ul style="list-style-type: none"> Noise caused by turning a fluorescent lamp on and off. Noise from automobile ignition. 	<ul style="list-style-type: none"> Move the antenna as far away as possible from the fluorescent lamp. 	10
		<ul style="list-style-type: none"> Install an outdoor FM antenna as far away as possible from the road. 	11
Tuning indicators and stereo indicator light but sound is distorted and separation is bad.	<ul style="list-style-type: none"> Station is too strong. Multiple reflection of the radio waves because of tall buildings or mountains. 	<ul style="list-style-type: none"> Change to FM indoor antenna. 	–
		<ul style="list-style-type: none"> Use antenna that has better directivity and select a point with the least distortion. 	–
Tuning indicators and stereo indicator flicker and hiss is heard on FM.	<ul style="list-style-type: none"> Station is too weak. Stereo FM broadcasts cover only about half the distance of an ordinary broadcast. 	<ul style="list-style-type: none"> Install an outdoor FM antenna. 	11
		<ul style="list-style-type: none"> Change the position or direction of the outdoor antenna. 	–
		<ul style="list-style-type: none"> Switch to mono reception. (Even stereo broadcasts will be heard in mono.) 	24
No station or undesired station is recalled when a Preset button is pressed.	<ul style="list-style-type: none"> The power cord has been unplugged for a long time. 	<ul style="list-style-type: none"> The memory contents are lost if the power is not turned on and off a few times each month. Store all stations in the memory again and remember to turn the power on and off a few times each month. 	–
The RDS function does not work.	<ul style="list-style-type: none"> The station is not an RDS station. The reception station signal is too weak. 	<ul style="list-style-type: none"> Receive an RDS station. 	25
		<ul style="list-style-type: none"> Install an outdoor FM antenna. 	11
		<ul style="list-style-type: none"> Change the position or direction of the outdoor antenna. 	–
	<ul style="list-style-type: none"> Move the antenna as far away as possible from fluorescent lamps. 	10	
	<ul style="list-style-type: none"> Install an outdoor FM antenna. 	11	

Troubleshooting

Trouble	Cause	Remedy	See page
The disc skips sounds.	<ul style="list-style-type: none"> • Vibrations are being transmitted to the unit. • The disc is severely scratched. • The disc is extremely dirty. 	<ul style="list-style-type: none"> • Place the unit in a vibration free location. • Replace the disc with a new one. • Clean the disc. 	– 21 21
Track numbers cannot be stored when setting MEMORY playback.	<ul style="list-style-type: none"> • There is no disc inserted in the unit. • A track number not on the disc is being input. 	<ul style="list-style-type: none"> • Insert a disc into the unit. • Input only the track numbers on the disc. 	18 20
The disc is loaded in the disc tray, but playback will not begin.	<ul style="list-style-type: none"> • The disc is inserted with the wrong side facing upward. • The disc is extremely dirty. • Moisture has formed inside the unit. 	<ul style="list-style-type: none"> • Insert the disc with the label side facing upward. • Clean the disc. • Take the disc out and leave the unit for several hours until the moisture evaporates. 	18 21 3
Search time (when moving to a specific track) is extremely long.	<ul style="list-style-type: none"> • The disc is dirty. • The disc is scratched. 	<ul style="list-style-type: none"> • Clean the disc. • Replace the disc with a new one. 	21 21

Excessive electrical interference may temporarily render this system's sensitive microcomputer inoperable. If this happens, unplug the system for at least five seconds.

Specifications

AMPLIFIER

Power Output:	2 × 20 watts at 4 ohms 1 kHz DIN 2 × 17 watts at 6 ohms 1 kHz DIN 2 × 15 watts at 8 ohms 1 kHz DIN 2 × 20 watts min, RMS at 4 ohms 1 kHz no more than 1 % THD (FTC rating) 2 × 25 watts at 4 ohms EIAJ
Dynamic Power:	2 × 24 watts at 4 ohms 2 × 18 watts at 8 ohms
Total Harmonic Distortion:	0.2 % at 10 watts output
IM Distortion:	0.2 % at 10 watts output
Damping Factor:	25 at 8 ohms
Sensitivity and Impedance:	TAPE/CDR/MD IN : 150 mV, 50 kohms
Frequency Response:	10 to 50,000 Hz : +0 / -3 dB
Acoustic Presence:	1 40 Hz +6.0 dB 2 80 Hz +7.5 dB 3 40 Hz +10 dB 80 Hz +8.0 dB 4 40 Hz +10 dB 80 Hz +8.0 dB 10 kHz +4.5 dB
Single-to-Noise Ratio:	100 dB (IHF A)
Muting	-55 dB

CD PLAYER

Signal Readout System:	Optical non-contact
Reading Rotation:	About 500 – 200 r.p.m. (constant linear velocity)
Linear Velocity:	1.2 – 1.4 m / s
Error Correction System:	Cross Interleave Reed Solomon code
D / A Converter:	1 bit
Digital Filter:	352.8 kHz 8 times over sampling
Number of Channels:	2 (stereo)
Frequency Response:	5 Hz – 20 kHz

TUNER

Tuning range	FM: 87.5 to 108.00 MHz (50 kHz steps) AM: 522 to 1611 kHz (9 kHz steps)
Usable sensitivity	FM: Mono 11.2 dBf, 1.0 μV (75 ohms IHF) 0.9 μV (75 ohms DIN) Stereo 17.2 dBf, 2.0 μV (75 ohms IHF) 23.0 μV (75 ohms DIN) AM: 30 μV
50 dB Quieting sensitivity	FM: Mono 17.2 dBf, 2.0 μV (75 ohms) Stereo 37.2 dBf, 20.0 μV (75 ohms)
Capture ratio	FM: 2.0 dB
Image rejection ratio	FM: 85 dB AM: 40 dB
IF rejection ratio	FM: 90 dB AM: 40 dB
Signal to noise ratio	FM: Mono 73 dB, IHF Stereo 67 dB, IHF AM: 40 dB
Selectivity	FM: 50 dB DIN (±300 kHz at 40 kHz Devi.)
AM Suppression Ratio:	50 dB
Harmonic distortion	FM: Mono 0.2% Stereo 0.3% AM: 0.7 %
Frequency response	FM: 30 to 15,000 Hz (±1.5 dB)
Stereo separation	FM: 35 dB at 1,000 Hz 25 dB at 100 to 10,000 Hz
Stereo threshold	FM: 17.2 dBf, 2.0 μV (75 ohms)

GENERAL

Power Supply:	AC 120 V, 60 Hz (some Asian models) AC 230-240 V, 50 Hz (European models) AC 220-230 V, 50/60 Hz (Other area models)
Power Consumption:	60 W (some Asian models) 55 W (Other area models)
Dimensions:	205 W x 103 H x 362 D mm (8-1/6" x 4-1/16" x 14-1/4")
Weight:	4.0 kg (8.8 lbs)

Specifications and features are subject to change without notice.

Power supply and voltage vary depending on the area in which the unit is purchased.

Using the remote controller

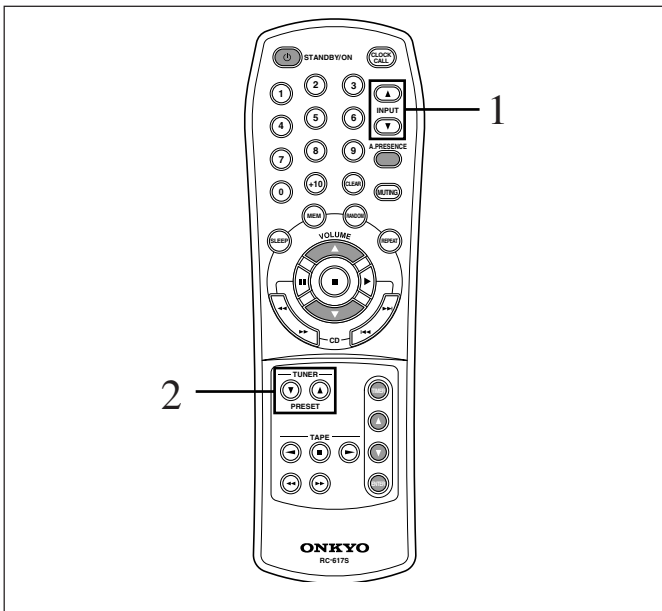

Listening to the radio

1. Select FM or AM using the INPUT ▼/▲ buttons.
2. Use the TUNER PRESET ▼/▲ buttons to select the desired preset station.

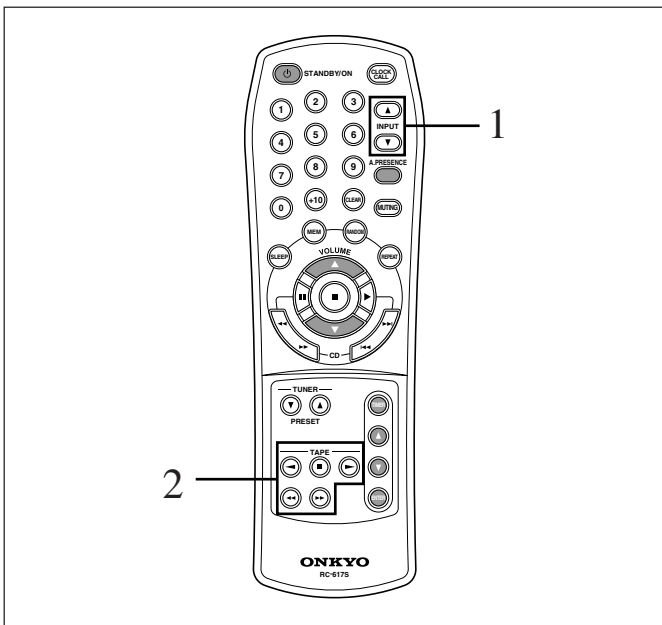

Using an Onkyo stereo cassette tape deck

These buttons enable you to control ONKYO stereo cassette tape decks that can be remotely controlled. (Refer to page 7.)

1. Use the INPUT ▼/▲ buttons to select TAPE as the source.
2. Press the transport buttons.

- ◀ Reverse play
- ▶ Forward play
- Stop
- ◀◀ Fast Rewind
- ▶▶ Fast Forward

ONKYO CORPORATION

Sales & Product Planning Div. : 2-1, Nisshin-cho, Neyagawa-shi, OSAKA 572-8540, JAPAN
Tel: 072-831-8023 Fax: 072-831-8124

ONKYO U.S.A. CORPORATION

18 Park Way, Upper Saddle River, N.J. 07458, U.S.A.
Tel: 201-785-2600 Fax: 201-785-2650 <http://www.us.onkyo.com/>

ONKYO EUROPE ELECTRONICS GmbH

Liegnitzerstrasse 6, 82194 Groebenzell, GERMANY
Tel: +49-8142-4401-0 Fax: +49-8142-4401-555 <http://www.eu.onkyo.com/>

ONKYO EUROPE UK Office

Suite 1, Gregories Court, Gregories Road, Beaconsfield, Buckinghamshire, HP9 1HQ
UNITED KINGDOM Tel: +44-(0)1494-681515 Fax: +44(0)-1494-680452

ONKYO CHINA LIMITED

Units 2102-2107, Metroplaza Tower I, 223 Hing Fong Road, Kwai Chung,
N.T., HONG KONG Tel: 852-2429-3118 Fax: 852-2428-9039
<http://www.ch.onkyo.com/>



I0504-1

SN 29344035

(C) Copyright 2005 ONKYO CORPORATION Japan. All rights reserved.

Download from [Www.Somanuals.com](http://www.Somanuals.com). All Manuals Search And Download.



Free Manuals Download Website

<http://myh66.com>

<http://usermanuals.us>

<http://www.somanuals.com>

<http://www.4manuals.cc>

<http://www.manual-lib.com>

<http://www.404manual.com>

<http://www.luxmanual.com>

<http://aubethermostatmanual.com>

Golf course search by state

<http://golfingnear.com>

Email search by domain

<http://emailbydomain.com>

Auto manuals search

<http://auto.somanuals.com>

TV manuals search

<http://tv.somanuals.com>