

ONKYO®

BLU-RAY DISC PLAYER

DV-BD507

Instruction Manual

Contents

Introduction.....	2
Connections.....	13
Playback.....	19
Function Setup.....	33
Others.....	50

Thank you for purchasing an Onkyo BLU-RAY DISC PLAYER. Please read this manual thoroughly before making connections and plugging in the unit.

Following the instructions in this manual will enable you to obtain optimum performance and listening enjoyment from your new BLU-RAY DISC PLAYER.

Please retain this manual for future reference.



WARNING:

TO REDUCE THE RISK OF FIRE OR ELECTRIC SHOCK, DO NOT EXPOSE THIS APPARATUS TO RAIN OR MOISTURE.

CAUTION:

TO REDUCE THE RISK OF ELECTRIC SHOCK, DO NOT REMOVE COVER (OR BACK). NO USER-SERVICEABLE PARTS INSIDE. REFER SERVICING TO QUALIFIED SERVICE PERSONNEL.

**WARNING**

**RISK OF ELECTRIC SHOCK
DO NOT OPEN**

AVIS

**RISQUE DE CHOC ELECTRIQUE
NE PAS OUVRIR**



The lightning flash with arrowhead symbol, within an equilateral triangle, is intended to alert the user to the presence of uninsulated "dangerous voltage" within the product's enclosure that may be of sufficient magnitude to constitute a risk of electric shock to persons.

The exclamation point within an equilateral triangle is intended to alert the user to the presence of important operating and maintenance (servicing) instructions in the literature accompanying the appliance.

The caution marking is located on the rear or bottom of the cabinet.

Important Safety Instructions

1. Read these instructions.
2. Keep these instructions.
3. Heed all warnings.
4. Follow all instructions.
5. Do not use this apparatus near water.
6. Clean only with dry cloth.
7. Do not block any ventilation openings. Install in accordance with the manufacture's instructions.
8. Do not install near any heat sources such as radiators, heat registers, stoves, or other apparatus (including amplifiers) that produce heat.
9. Do not defeat the safety purpose of the polarized or grounding-type plug. A polarized plug has two blades with one wider than the other. A grounding type plug has two blades and a third grounding prong. The wide blade or the third prong are provided for your safety. If the provided plug does not fit into your outlet, consult an electrician for replacement of the obsolete outlet.
10. Protect the power cord from being walked on or pinched particularly at plugs, convenience receptacles, and the point where they exit from the apparatus.
11. Only use attachments/accessories specified by the manufacturer.
12. Use only with the cart, stand, tripod, bracket, or table specified by the manufacturer, or sold with the apparatus. When a cart is used, use caution when moving the cart/apparatus combination to avoid injury from tip-over.
 
13. Unplug this apparatus during lightning storms or when unused for long periods of time.
14. Refer all servicing to qualified service personnel. Servicing is required when the apparatus has been damaged in any way, such as power-supply cord or plug is damaged, liquid has been spilled or objects have fallen into the apparatus, the apparatus has been exposed to rain or moisture, does not operate normally, or has been dropped.
15. **Damage Requiring Service**
Unplug the apparatus from the wall outlet and refer servicing to qualified service personnel under the following conditions:
 - A. When the power-supply cord or plug is damaged,
 - B. If liquid has been spilled, or objects have fallen into the apparatus,
 - C. If the apparatus has been exposed to rain or water,
 - D. If the apparatus does not operate normally by following the operating instructions. Adjust only those controls that are covered by the operating instructions as an improper adjustment of other controls may result in damage and will often require extensive work by a qualified technician to restore the apparatus to its normal operation,
 - E. If the apparatus has been dropped or damaged in any way, and
 - F. When the apparatus exhibits a distinct change in performance this indicates a need for service.
16. **Object and Liquid Entry**
Never push objects of any kind into the apparatus through openings as they may touch dangerous voltage points or short-out parts that could result in a fire or electric shock.
The apparatus shall not be exposed to dripping or splashing and no objects filled with liquids, such as vases shall be placed on the apparatus.
Don't put candles or other burning objects on top of this unit.
17. **Batteries**
Always consider the environmental issues and follow local regulations when disposing of batteries.
18. If you install the apparatus in a built-in installation, such as a bookcase or rack, ensure that there is adequate ventilation.
Leave 20 cm (8") of free space at the top and sides and 10 cm (4") at the rear. The rear edge of the shelf or board above the apparatus shall be set 10 cm (4") away from the rear panel or wall, creating a flue-like gap for warm air to escape.

PRECAUTIONS

Do not place the unit on the furniture that is capable of being tilted by a child and an adult leaning, pulling, standing or climbing on it. A falling unit can cause serious injury or even death.

- 1. Recording Copyright**—Unless it's for personal use only, recording copyrighted material is illegal without the permission of the copyright holder.
- 2. AC Fuse**—The AC fuse inside the unit is not user-serviceable. If you cannot turn on the unit, contact your Onkyo dealer.
- 3. Care**—Occasionally you should dust the unit all over with a soft cloth. For stubborn stains, use a soft cloth dampened with a weak solution of mild detergent and water. Dry the unit immediately afterwards with a clean cloth. Don't use abrasive cloths, thinners, alcohol, or other chemical solvents, because they may damage the finish or remove the panel lettering.
- 4. Power**
WARNING
BEFORE PLUGGING IN THE UNIT FOR THE FIRST TIME, READ THE FOLLOWING SECTION CAREFULLY.
AC outlet voltages vary from country to country. Make sure that the voltage in your area meets the voltage requirements printed on the unit's rear panel (AC 120 V, 60 Hz).
The power cord plug is used to disconnect this unit from the AC power source. Make sure that the plug is readily operable (easily accessible) at all times.
Pressing [**I/O ON / STANDBY**] to select Standby mode does not fully shutdown the unit. If you do not intend to use the unit for an extended period, remove the power cord from the AC outlet.
- 5. Preventing Hearing Loss**
Caution
Excessive sound pressure from earphones and headphones can cause hearing loss.
- 6. Batteries and Heat Exposure**
Warning
Batteries (battery pack or batteries installed) shall not be exposed to excessive heat as sunshine, fire or the like.
- 7. Never Touch this Unit with Wet Hands**—
Never handle this unit or its power cord while your hands are wet or damp. If water or any other liquid gets inside this unit, have it checked by your Onkyo dealer.
- 8. Handling Notes**
 - If you need to transport this unit, use the original packaging to pack it how it was when you originally bought it.
 - Do not leave rubber or plastic items on this unit for a long time, because they may leave marks on the case.
- This unit's top and rear panels may get warm after prolonged use. This is normal.
 - If you do not use this unit for a long time, it may not work properly the next time you turn it on, so be sure to use it occasionally.
 - When you've finished using this unit, remove all discs and turn off the power.
- 9. Installing this Unit**
 - Install this unit in a well-ventilated location.
 - Ensure that there's adequate ventilation all around this unit, especially if it's installed in an audio rack. If the ventilation is inadequate, the unit may overheat, leading to malfunction.
 - Do not expose this unit to direct sunlight or heat sources, because its internal temperature may rise, shortening the life of the optical pickup.
 - Avoid damp and dusty places, and places subject to vibrations from loudspeakers.
 - Never put the unit on top of, or directly above a loud-speaker.
 - Install this unit horizontally. Never use it on its side or on a sloping surface, because it may cause a malfunction.
 - If you install this unit near a TV, radio, or VCR, the picture and sound quality may be affected. If this occurs, move this unit away from the TV, radio, or VCR.
- 10. To Obtain a Clear Picture**—This unit is a high-tech, precision device. If the lens on the optical pickup, or the disc drive mechanism becomes dirty or worn, the picture quality may be affected. To maintain the best picture quality, we recommend regular inspection and maintenance (cleaning or worn part replacement). Contact your Onkyo dealer.
- 11. Moisture Condensation**
Moisture condensation may damage this unit.
Read the following carefully:
Moisture may condense on the lens of the optical pickup, one of the most important parts inside this unit.
 - Moisture condensation can occur in the following situations:
 - The unit is moved from a cold place to a warm place.
 - A heater is turned on, or cold air from an air conditioner is hitting the unit.
 - In the summer, when this unit is moved from an air conditioned room to a hot and humid place.
 - The unit is used in a humid place.

PRECAUTIONS

- Do not use this unit when there's the possibility of moisture condensation occurring. Doing so may damage your discs and certain parts inside this unit. If condensation does occur, remove all discs and leave this unit turned on for two to three hours. By this time, the unit will have warmed up and any condensation will have evaporated.

12. Region Codes—The BD/DVD standard uses region codes to control how discs can be played around the world, the world being divided into three regions (BD) or six regions (DVD). This unit will only play BD/DVD discs that match its region code, which can be found on its rear panel ().

13. About this Manual—This manual explains how to use all of this unit's functions. Although the BD/DVD standard offers many special features, not all discs use them all, so depending on the disc being played, this unit may not respond to certain functions. See the disc's sleeve notes for supported features.

This unit contains a semiconductor laser system and is classified as a "CLASS 1 LASER PRODUCT". So, to use this model properly, read this Instruction Manual carefully. In case of any trouble, please contact the store where you purchased the unit.

To prevent being exposed to the laser beam, do not try to open the enclosure.

DANGER:

VISIBLE AND INVISIBLE LASER RADIATION WHEN OPEN AND INTERLOCK FAILED OR DEFEATED. DO NOT STARE INTO BEAM.

CAUTION:

THIS PRODUCT UTILIZES A LASER. USE OF CONTROLS OR ADJUSTMENTS OR PERFORMANCE OF PROCEDURES OTHER THAN THOSE SPECIFIED HEREIN MAY RESULT IN HAZARDOUS RADIATION EXPOSURE.

The label on the right is applied on the rear panel.



1. This unit is a CLASS 1 LASER PRODUCT and employs a laser inside the cabinet.
2. To prevent the laser from being exposed, do not remove the cover. Refer servicing to qualified personnel.

For U.S. Models

FCC Information for User

CAUTION:

The user changes or modifications not expressly approved by the party responsible for compliance could void the user's authority to operate the equipment.

NOTE:

This equipment has been tested and found to comply with the limits for a Class B digital device, pursuant to Part 15 of the FCC Rules. These limits are designed to provide reasonable protection against harmful interference in a residential installation.

This equipment generates, uses and can radiate radio frequency energy and, if not installed and used in accordance with the instructions, may cause harmful interference to radio communications. However, there is no guarantee that interference will not occur in a particular installation. If this equipment does cause harmful interference to radio or television reception, which can be determined by turning the equipment off and on, the user is encouraged to try to correct the interference by one or more of the following measures:

- Reorient or relocate the receiving antenna.
- Increase the separation between the equipment and receiver.
- Connect the equipment into an outlet on a circuit different from that to which the receiver is connected.
- Consult the dealer or an experienced radio/TV technician for help.

For Canadian Models

NOTE: THIS CLASS B DIGITAL APPARATUS COMPLIES WITH CANADIAN ICES-003.

Modèle pour les Canadien

REMARQUE: CET APPAREIL NUMÉRIQUE DE LA CLASSE B EST CONFORME À LA NORME NMB-003 DU CANADA.

PRECAUTIONS

Supplied Accessories

remote control with batteries (AAx2)

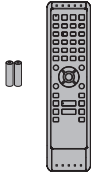

RCA audio / video cables

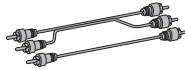

instruction manual

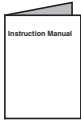

quick start guide



Note about Recycling

- This unit's packaging materials are recyclable and can be reused. Please dispose of any materials in accordance with your local recycling regulations.
- Batteries should never be thrown away or incinerated but disposed of in accordance with your local regulations concerning chemical wastes.



Maintenance

Servicing

- Please refer to relevant topics on "TROUBLESHOOTING" on page 50 before returning the product.
- If this unit becomes inoperative, do not try to correct the problem by yourself. There are no user-serviceable parts inside. Turn the unit to the standby mode, unplug the power plug, and please contact your Onkyo dealer.

Disc handling

- For best results, keep your discs clean. Fingerprints and dust can affect the sound and picture quality and should be removed as follows. Using a clean, soft cloth, wipe from the center outwards, as shown. Never wipe in a circular direction.



- To remove stubborn dust or dirt, wipe the disc with a damp, soft cloth, and then dry it with a dry cloth.
- Never use solvent-based cleaning fluids, such as thinner or benzene, commercially available cleaners, or antistatic sprays intended for vinyl records, because they may damage the disc.

IR signal check

- If the remote control is not working properly, you can use an AM radio or digital camera (including a cellular phone with built-in camera) to see if it is sending out an infrared signal.
- **With an AM radio:**
Tune the AM radio station to a non-broadcasting frequency. Point the remote control towards it, push any button and listen. If the sound from the radio flutters, it is receiving the remote control's infrared signal.
- **With a digital camera (including built-in cell phone cameras):**
Point a digital camera towards the remote control. Push any button on the remote control and look through the digital camera. If the infrared light appears through the camera, the remote control is working.

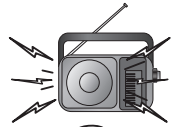

Copyright

- It is forbidden by law to copy, broadcast, show, broadcast on cable, play in public, or rent copyrighted material without permission. Commercial BD-video/DVD-video discs are copy-protected, and any recordings made from these discs will be distorted. This product incorporates copyright protection technology that is protected by U.S. patents and other intellectual property rights. Use of this copyright protection technology must be authorized by Macrovision, and is intended for home and other limited viewing uses only unless otherwise authorized by Macrovision. Reverse engineering or disassembly is prohibited.

PRECAUTIONS

Trademark Information



"BD-LIVE" logo is trademark of Blu-ray Disc Association.



HDMI, the HDMI logo and High-Definition Multimedia Interface are trademarks or registered trademarks of HDMI Licensing LLC.



Manufactured under license from Dolby Laboratories. Dolby and the double-D symbol are trademarks of Dolby Laboratories.



Manufactured under license under U.S. Patent #'s: 5,451,942; 5,956,674; 5,974,380; 5,978,762; 6,226,616; 6,487,535; 7,392,195; 7,272,567; 7,333,929; 7,212,872 & other U.S. and worldwide patents issued & pending. DTS is a registered trademark and the DTS logos, Symbol, DTS-HD and DTS-HD Master Audio | Essential are trademarks of DTS, Inc. ©1996-2008 DTS, Inc. All Rights Reserved.

x.v.Color

"x.v.Color" and "x.v.Color" logo are trademarks of Sony Corporation.

"Blu-ray Disc" and  are trademarks.  is a trademark of DVD Format/Logo Licensing Corporation.



Java and all other Java trademarks and logos are trademarks or registered trademarks of Sun Microsystems, Inc. in the United States and / or other countries.



"AVCHD" and the "AVCHD" logo are trademarks of Panasonic Corporation and Sony Corporation.

BONUS VIEW™

"BONUSVIEW" is trademark of Blu-ray Disc Association.

CONTENTS

Introduction

PRECAUTIONS	3
FEATURES	8
Features	8
Symbols Used in this Manual	8
FUNCTIONAL OVERVIEW	9
Front Panel	9
Rear Panel	9
Remote Control	10
Front Panel Display	12

Connections

CONNECTIONS	13
Connection to the TV	13
Connection to an Audio System	16
Network Connection with LAN	18

Playback

INFORMATION ON PLAYBACK	19
BASIC PLAYBACK	22
Playing Back a BD, DVD or a Disc with AVCHD Files ...	22
Operations Using Title Menu, Disc Menu, and Pop-up Menu	23
Pause	23
Resume Playback	23
Playing Back an Audio CD or a Disc with MP3 Files ..	24
Reading the SD Memory Card	25
SPECIAL PLAYBACK	26
Fast Forward / Fast Reverse	26
Slow Forward Playback	26
Step by Step Playback	26
Repeat Playback	26
A-B Repeat	27
PIP (Picture in Picture) (BONUSVIEW) Setting	27
Program Playback	27
Random Playback	28
Rapid Playback	29
Camera Angle	29
Enjoying BD-Live Discs with Internet	29
SEARCH	30
SPECIAL SETTINGS	31
Switching Subtitles	31
Switching Audio Soundtrack	31
Setting the BD Audio Mode	32
Adjusting the Picture	32

Function Setup

FUNCTION SETUP	33
Using the Setup Menu	33
Network Connection	45
Software Upgrade	48

Others

TROUBLESHOOTING	50
GLOSSARY	52
LANGUAGE CODE	54
SPECIFICATIONS	55

Features

Full high-definition video playback

Watch movies in the highest picture quality available for your HDTV. This unit offers full high-definition video playback up to 1080p resolution for an amazing viewing experience. A highly detailed picture and increased sharpness delivers a more true-to-life picture.

Upconvert DVD for enhanced picture quality

Your current DVD will look even better than before thanks to video upconversion. Upconversion will increase the resolution of standard definition DVD to high definition up to 1080p over an HDMI connection. The picture will be less jagged and more realistic for a near high-definition experience.

Enjoy your content on different kinds of media

Full backwards compatibility with DVD, CD and SD Card ensures that you can continue to enjoy your current audio-video collection. Additionally, you can listen to MP3 files.

Listen to the rich multi-channel surround sound

Multi-channel surround sound, which realizes real-to-life sound and makes you feel that you are really there.

Easy and simple connection to your HDTV via HDMI

Connect this unit to your HDTV with one single HDMI (high definition multimedia interface) cable. It is recommended to use High Speed HDMI Cable for better compatibility. The high definition video output signal will be transferred to your HDTV without conversion to analogue signals, so you will get an excellent picture and sound quality, completely free from noise.

Thanks to other multiple outputs, you can also easily connect to your home theater system or amplifier.

About HDMI CEC (consumer electronics control)

This unit supports HDMI CEC, which allows integrated system control over HDMI and is part of the HDMI standard. Onkyo does not guarantee 100% interoperability with other brands of HDMI CEC compliant devices.

PIP (Picture in Picture) (BONUSVIEW) setting

Some BD-video have the PIP (picture-in-picture) function which enables you to display the secondary video in the primary video. You can call up the secondary video by pressing **[PIP]** whenever the scene contains the secondary video.

BD-Live

BD-Live (BD-ROM ver. 2 (Profile 2.0/Profile 1.1)) that allows interactive functions to be used when this unit is connected to the Internet in addition to be BONUSVIEW function. The various functions differ depending on the disc.

Pop-up menu

Some BD-video have pop-up menu which is a navigation menu that can be called up and be operated on the TV screen without interrupting the playback. You can call up the pop-up menu by pressing **[POP UP MENU / MENU]**. Contents in the pop-up menu vary depending on the disc.

Rapid playback

Playback in slightly faster speed while keeping the sound output.

Rapid playback is available only on discs recorded in the Dolby Digital format.

HDMI Deep Color

Deep Color reduces the posterization effect of the playback image. Refer to "HDMI Deep Color" in "FUNCTION SETUP" on page 36.

HDMI 1080p / 24 fps output (BD only)

This unit is equipped with the feature which can provide the smooth movement in the playback of film originated material with the frame rate of 24 frames per second with progressive. (Available only when the TV is connected by an HDMI cable and compatible with 1080p24 frame input.) Refer to "HDMI Video Resolution" in "FUNCTION SETUP" on page 36.

Playing back the contents in SD Memory Card

You can play back AVCHD/MP3 stored in an SD Memory Card. You can store picture-in-picture commentary, subtitles or other extras for BD-ROM Ver. 2 (Profile 2.0/Profile 1.1) files in an SD Memory Card and play back with the BD-video.

Playing back AVCHD files





This unit supports playback of AVCHD format files (new format for high definition video camcorders) recorded on disc/SD card. Your high definition personal archive is playable in HD quality.

x.v.Color

This unit supports playback of video contents on discs recorded with "x.v.Color" technology. To watch this video content with the "x.v.Color" space, a TV or other display device supporting both video image reproduction using "x.v.Color" standard and capability of manual switching of its color space setting is required. Please refer to the owner's manual of your display device for further information.

Symbols Used in this Manual

To specify for which media type each function is, we put the following symbols at the beginning of each item to operate.

Symbol	Description
	Description refers to BD-video and BD-RE (ver. 2.1) / BD-R (ver. 1.1/1.2/1.3) recorded in BDMV format
	Description refers to DVD-video
	Description refers to DVD+RW/+R/-RW/-R and SD Card / SDHC Card with AVCHD files
	Description refers to audio CD / DTS-CD
	Description refers to BD, DVD, CD-RW/-R and SD Memory Card with MP3 files

If you do not find any of the symbols listed above under the function heading, the operation is applicable to all media.

FUNCTIONAL OVERVIEW

Front Panel

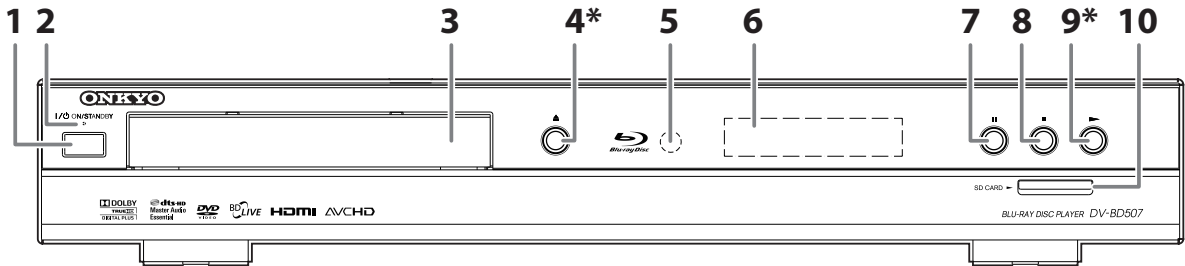

* The unit can also be turned on by pressing these buttons.

1. I/O ON / STANDBY button

- Press to turn on the unit, or to turn the unit into the standby mode. (To completely shut down the unit, you must unplug the AC power cord)

2. STANDBY indicator

- This indicator lights up in red when the unit is in standby mode and turns off when the unit is active.

3. Disc tray

- Place a disc when opening the disc tray.

4. OPEN / CLOSE ▲ button*

- Press to open or close the disc tray.

5. Infrared sensor window

- Receive signals from your remote control so that you can control the unit from a distance.

6. Display

- Refer to "Front Panel Display" on page 12.

7. PAUSE ■■ button

- Press to pause playback.

8. STOP ■ button

- Press to stop playback.

9. PLAY ► button*

- Press to start or resume playback.

10. SD CARD slot

- Insert an SD Memory Card, and play back the contents in it.

Rear Panel

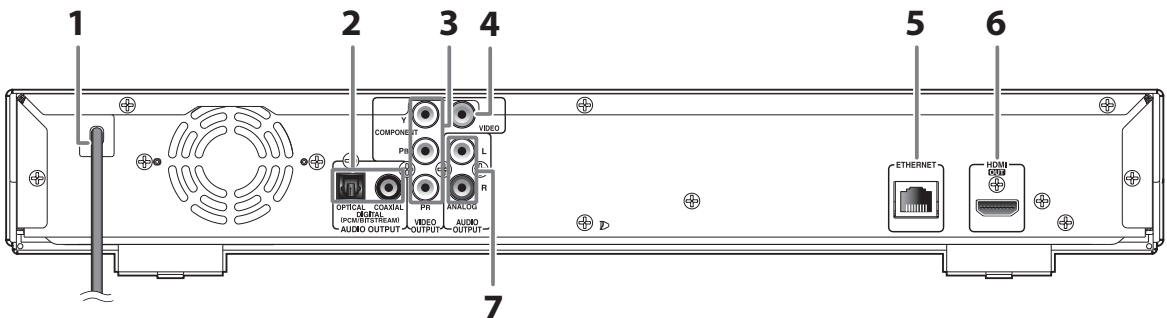

1. AC power cord

- Connect to a standard AC outlet to supply power to this unit.
- Unplug this cord from the AC outlet to completely shut down the unit.

2. AUDIO OUTPUT (DIGITAL OPTICAL / COAXIAL) jacks

- Use to connect an AV receiver / amplifier, Dolby Digital / DTS decoder or other device with a digital audio optical / coaxial input jack with a digital audio optical / coaxial cable.

3. VIDEO OUTPUT (COMPONENT) jacks

- Use to connect a TV or AV receiver with component video inputs with an RCA component video cable.

4. VIDEO OUTPUT (VIDEO) jack

- Use to connect a TV, an AV receiver or other device with an RCA video cable.

5. ETHERNET terminal

- Use to connect a telecommunications equipment with LAN cable.

6. HDMI OUT jack

- Use to connect a TV with an HDMI compatible port with an HDMI cable.

7. AUDIO OUTPUT (ANALOG L / R) jacks

- Use to connect a TV, an AV receiver / amplifier or other device with an RCA audio cable.

Note

- Do not touch the inner pins of the jacks on the rear panel. Electrostatic discharge may cause permanent damage to the unit.
- This unit does not have the RF modulator.

Remote Control

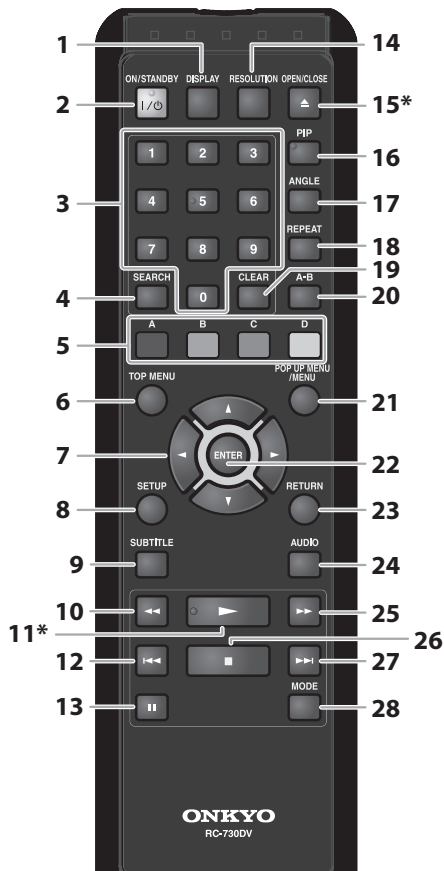

* The unit can also be turned on by pressing these buttons.

- 1. DISPLAY button**
 - Press to display the on-screen display menu.
- 2. ON/STANDBY I/O button**
 - Press to turn on the unit, or to turn the unit into the standby mode. (To completely shut down the unit, you must unplug the AC power cord)
- 3. Number buttons**
 - Press to enter the title, chapter, track or file number.
 - Press to enter values in the input field.
- 4. SEARCH button**
 - Press to display the search menu.
- 5. A / B / C / D button**
 - Press to select items on some BD menus.
 - When file list / thumbnail list is shown, press to switch between pages.
- 6. TOP MENU button**
 - Press to display the top menu.
- 7. Cursor ▲ / ▼ / ◀ / ▶ buttons**
 - Press to select items or settings.
- 8. SETUP button**
 - Press to display the setup menu.
- 9. SUBTITLE button**
 - Press to display the subtitle menu.
- 10. REV ◀◀ button**
 - During playback, press to fast reverse the playback.

- 11. PLAY ► button***
 - Press to start playback or resume playback.
- 12. SKIP ◀◀ button**
 - During playback, press once to return to the beginning of the current title, chapter, track or file.
 - During playback, press twice to return to the previous title, chapter, track or file.
- 13. PAUSE || button**
 - Press to pause playback.
 - When playback is in pause mode, press repeatedly to forward the playback step by step.
- 14. RESOLUTION button**
 - Press to set the HDMI output mode.
- 15. OPEN/CLOSE ▲ button***
 - Press to open or close the disc tray.
- 16. PIP button**
 - Press to switch picture-in-picture feature on or off (only applicable to BD-video which supports the PIP function).
- 17. ANGLE button**
 - Press to access various camera angles on the disc.
- 18. REPEAT button**
 - Press to toggle between various repeat modes.
- 19. CLEAR button**
 - Press to clear the information once entered, to clear the marker settings, or to cancel the programming for audio CD, etc.
- 20. A-B button**
 - Press to play back a defined section between point A and B repeatedly.
- 21. POP UP MENU/MENU button**
 - Press to display the pop-up menu / disc menu.
- 22. ENTER button**
 - Press to confirm or select menu items.
- 23. RETURN button**
 - Press to return to the previously displayed menu screen.
- 24. AUDIO button**
 - Press to display the audio menu.
- 25. FWD ►► button**
 - During playback, press to fast forward the playback.
 - In pause mode, press to slow forward the playback.
- 26. STOP ■ button**
 - Press to stop playback.
- 27. SKIP ►►| button**
 - During playback, press to skip to the next title, chapter, track or file.
- 28. MODE button**
 - During BD, DVD or AVCHD files playback, press to display the setting for the rapid playback and the picture adjustment.
 - During BD playback, press to turn the picture-in-picture feature on or off (only applicable to BD-video which supports the PIP function).
 - In stop mode with BD inserted, press to display a menu for setting the BD audio mode.
 - In stop mode with audio CD, or a disc with MP3 files inserted, press to display menus for program and random playback.

Installing the Batteries in the Remote Control

Install the batteries (AAx2) matching the polarity indicated inside battery compartment of the remote control.

1 Open the cover.

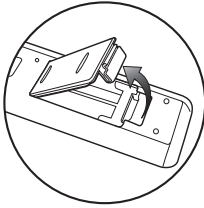

2 Insert batteries.

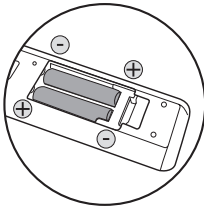

Make sure to match + and - on the batteries to the marks indicated in the battery compartment.

3 Close the cover.

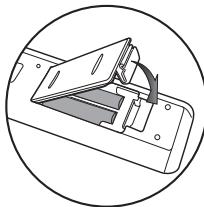

Note

Incorrect use of batteries can result in hazards such as leakage and bursting. Please observe the following:

- Do not mix new and old batteries together.
- Do not use different kinds of batteries together. Although they may look similar, different batteries may have different voltages.
- Make sure that the + and - ends of each battery match the indications in the battery compartment.
- Remove batteries from battery compartment that is not going to be used for a month or more.
- When disposing of used batteries, please comply with governmental regulations or environmental public instruction's rules that apply in your country or area.
- Do not recharge, short-circuit, heat, burn or disassemble batteries.

Using a Remote Control

Keep in mind the following when using the remote control:

- Make sure that there are no obstacles between the remote control and the infrared sensor window on the unit.
- Remote operation may become unreliable if strong sunlight or fluorescent light is shining on the infrared sensor window of the unit.
- Remote control for different devices can interfere with each other. Avoid using remote control for other device located close to the unit.
- Replace the batteries when you notice a fall off in the operating range of the remote control.
- The maximum operable ranges from the unit are as follows.

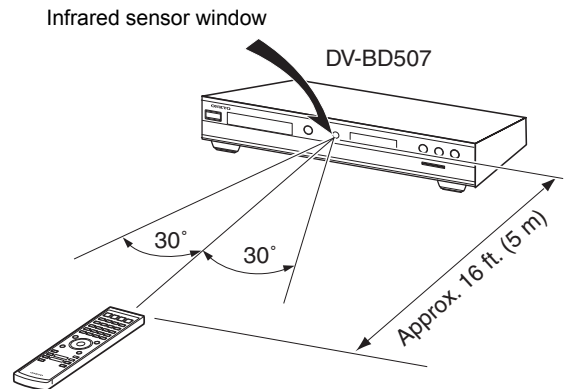

Front Panel Display

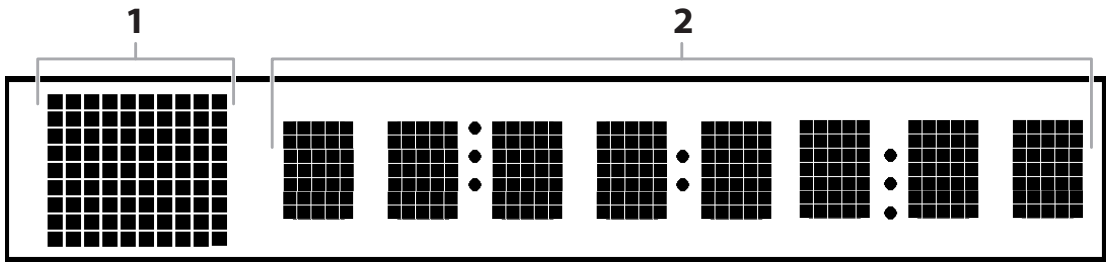

• Brightness of the display can be adjusted. Refer to "Panel Display" in "FUNCTION SETUP" on page 43.

1. Displays playback status icon. Refer to the table below.
2. Displays various kinds of information such as title number, elapsed time, repeat mode, etc.

Playback status icon		Mode
Disc	SD Memory Card	
		Playback is in progress
		Stop mode
		Pause mode
		Fast forward mode
		Fast reverse mode
	 (for AVCHD only)	Slow forward mode
		Appears while repeat function is set

Example of Display Message



Title is being played back. Indicating the current title number and the elapsed time.



Loading a disc.



Current chapter is in chapter repeat mode.



Dolby Digital audio is being played back.

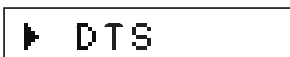

DTS audio is being played back.

CONNECTIONS

Connection to the TV

- Make one of the following connections, depending on the capabilities of your existing device.

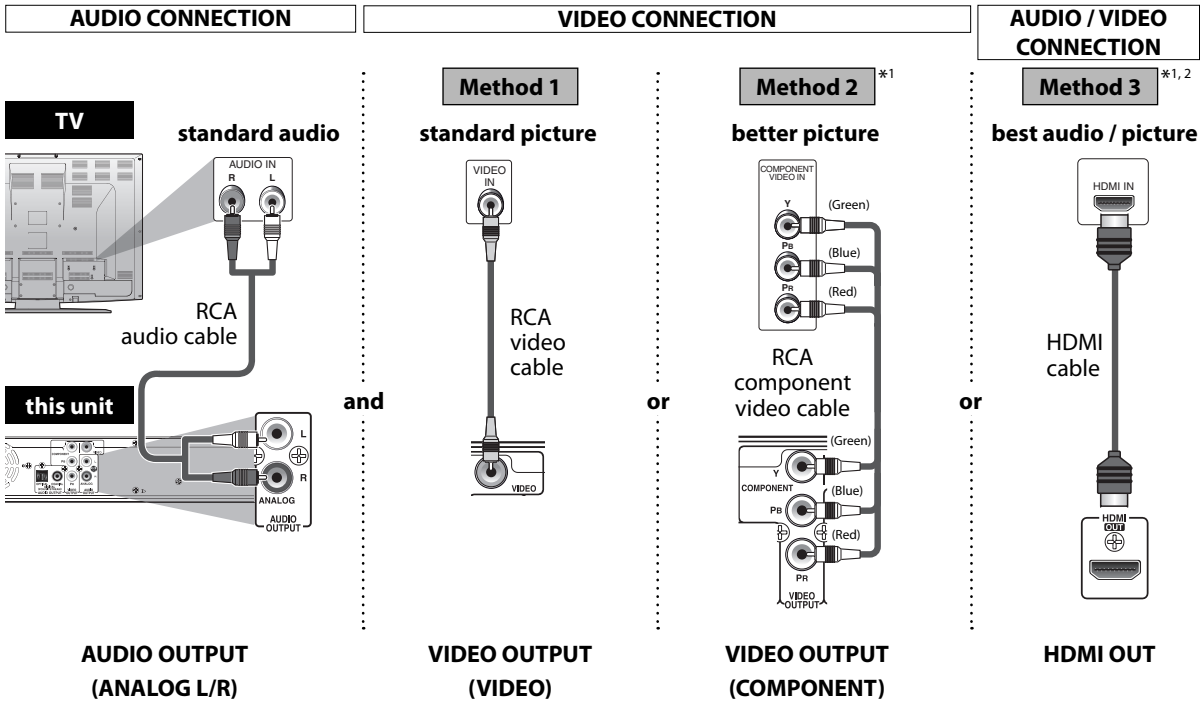

*1 This unit is compatible with the progressive scan system. The feature provides you with the higher quality pictures than traditional output system does. To utilize this feature, a component or an HDMI connection is required. Refer to "HDMI Video Resolution" or "Component Output" setting on page 36 to set the video resolution.

*2 Analog audio connection is not required for this connection.

Supplied cables used in this connection are as follows:

- RCA audio cable (L/R) x 1
- RCA video cable x 1

Please purchase the rest of the necessary cables at your local store.

Note

- Connect this unit directly to the TV. If the RCA audio / video cables are connected to a VCR, pictures may be distorted due to the copy-protection system.
- If the picture is not output properly to the TV because of "HDMI Video Resolution" or "Component Output" setting, press and hold **[PLAY ►]** on the front panel for more than 5 seconds. "HDMI Video Resolution" and "Component Output" setting will be reset to the default automatically. You cannot change the video resolution during Blu-ray Disc playback. To change the resolution, stop playback.
- A simple 1-cable connection with a device having an HDMI (high-definition multimedia interface) jack allows digital transfer of both digital video signals and multi-channel audio signals.

HDMI Output Mode and Actual Output Signals

Press **[RESOLUTION]** to change the resolution of the video signal being output from HDMI OUT jack. The video resolution changes as follows every time **[RESOLUTION]** is pressed.

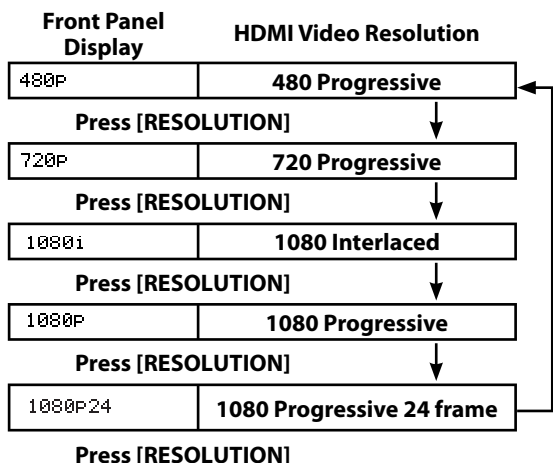

Copyright protection system

To play back the digital video images of a BD / DVD via an HDMI connection, it is necessary that both the unit and the TV (or an AV receiver) support a copyright protection system called HDCP (high-bandwidth digital content protection system). HDCP is copy protection technology that comprises data encryption and authentication of the connected AV device. This unit supports HDCP. Please read the operating instructions of your TV (or AV receiver) for more information.

Note

- When using HDCP-incompatible TV, the image will not be viewed properly.
- The audio signals from HDMI OUT jack (including the sampling frequency, the number of channels and bit length) maybe limited by the device that is connected.
- Among the devices that support HDMI, some do not support audio output (e.g. projectors). In connections with device such as this unit, audio signals are not output from HDMI OUT jack.
- Video and audio signals may be distorted temporarily when switching to / from the HDMI output mode.
- You cannot change the video resolution during Blu-ray Disc playback. To change the resolution, stop playback.
- You can also change the HDMI output mode from "HDMI Video Resolution" setting in "Video" menu. In this menu, you can confirm what HDMI video resolutions are supported by connected TV. Refer to page 36.
- In order to get natural and high quality film reproduction of 24-frame film material, use an HDMI cable (High Speed HDMI Cable is recommended) and select "1080p24" if the connected TV is compatible with 1080p24 frame input.
- Even if you set "HDMI Video Resolution" setting to "1080p24", when the contents of the disc is not compatible for 1080p24 frame, 1080p60 frame will be output.
- It is recommended to use High Speed HDMI Cable (also known as HDMI category 2 cable) for better compatibility.

HDMI Audio Out Setting

When using HDMI connections make "HDMI Audio Out" setting in "Audio" menu according to the specifications of the device to be connected. Refer to page 38.

Device to be connected	"HDMI Audio Out" setting	Output HDMI audio signal
Device compatible with Dolby Digital, Dolby Digital Plus, Dolby TrueHD, DTS or DTS-HD decoding	HDMI Multi (Normal)	Dolby Digital, Dolby Digital Plus, Dolby TrueHD, DTS, or DTS-HD bitstream are output from HDMI OUT jack. Make the speaker settings on the connected AV receiver, etc.
Device compatible with 3 or more channels of audio inputs (not Dolby Digital, Dolby Digital Plus, Dolby TrueHD, DTS or DTS-HD compatible)	HDMI Multi (LPCM)	Multi-channel audio signals are output from HDMI OUT jack. Make the speaker settings with the speaker setting items appear after you select "HDMI Multi(LPCM)". Refer to page 38.
Device compatible with 2-channel audio input or device not compatible with audio input	HDMI 2ch	Down-mixed 2-channel audio signals are output from HDMI OUT jack.
HDMI connection to a TV and digital audio connection (optical/coaxial) to an AV receiver	Audio Mute	HDMI audio will be mute, and Dolby Digital / DTS bitstream or LPCM will be output from AUDIO OUTPUT (DIGITAL OPTICAL / COAXIAL) jacks depending on "Digital Out" setting. Refer to page 39.

■ Audio signals output from HDMI OUT jack

	"HDMI Audio Out" setting →	"HDMI Multi (Normal)"		"HDMI Multi (LPCM)"		"HDMI 2ch"	
	"BD Audio Mode" setting →	"HD Audio Output"	"Mix Audio Output"	"HD Audio Output"	"Mix Audio Output"	"HD Audio Output"	"Mix Audio Output"
Media ↓	Audio Source ↓	Which audio format can be output depends on the compatibility of the connected device.					
BD-video	Dolby Digital	Dolby Digital	Dolby Digital	Multi PCM	Multi PCM	Downmix 2ch PCM	Downmix 2ch PCM
	Dolby Digital Plus	Dolby Digital Plus	Dolby Digital	Multi PCM* ¹	Multi PCM* ²	Downmix 2ch PCM* ¹	Downmix 2ch PCM* ²
	Dolby TrueHD	Dolby TrueHD	Dolby Digital	Multi PCM* ³	Multi PCM* ⁴	Downmix 2ch PCM* ³	Downmix 2ch PCM* ⁴
	DTS	DTS	DTS	Multi PCM* ⁷	Multi PCM* ⁷	Downmix 2ch PCM	Downmix 2ch PCM
	DTS-HD	DTS-HD	DTS	Multi PCM* ^{5,7}	Multi PCM* ^{6,7}	Downmix 2ch PCM* ⁵	Downmix 2ch PCM* ⁶
	LPCM	Multi PCM	Multi PCM	Multi PCM	Multi PCM	Downmix 2ch PCM	Downmix 2ch PCM
AVCHD	Dolby Digital	Dolby Digital		Multi PCM		Downmix 2ch PCM	
	LPCM	Multi PCM		Multi PCM		Downmix 2ch PCM	
DVD-video	Dolby Digital	Dolby Digital		Multi PCM		Downmix 2ch PCM	
	DTS	DTS		Multi PCM		Downmix 2ch PCM	
	LPCM	2ch PCM		2ch PCM		2ch PCM	
Audio CD / MP3	PCM	2ch PCM		2ch PCM		2ch PCM	
DTS-CD	DTS	DTS		Multi PCM		Downmix 2ch PCM	

*¹ Full decoded.

*² Only the independent substream is decoded.

*³ Dolby TrueHD stream is decoded.

*⁴ Only the Dolby Digital substream is decoded.

*⁵ Full decoded.

*⁶ Only the core substream is decoded.

*⁷ When audio source is Multi-channel, decoded as 7.1 ch. However, number of the output audio channel will depend on the number of the connected speakers.

• If the connected device is not compatible with the HDMI BITSTREAM, audio will be output as multi LPCM or 2-channel down-mixed LPCM depending on the capability of the connected device even if you select "HDMI Multi(Normal)" in "HDMI Audio Out" setting. Refer to page 38.

• When playing back a BD-video which only contains the primary audio, the audio output will be the same case as the "HD Audio Output" even if the "BD Audio Mode" is set to "Mix Audio Output".

Note

- The audio signals from HDMI OUT jack (including the sampling frequency, the number of channels and bit length) maybe limited by the device that is connected.
- Among the devices that support HDMI, some do not support audio output (e.g. projectors). In connections with device such as this unit, audio signals are not output from HDMI OUT jack.
- Video and audio signals may be distorted temporarily when switching to / from the HDMI output mode.

Connection to an Audio System

- When you change the connections, all devices should be turned off.
- Refer to the manual accompanying external devices for more information.

2-Channel Analog Audio Connection

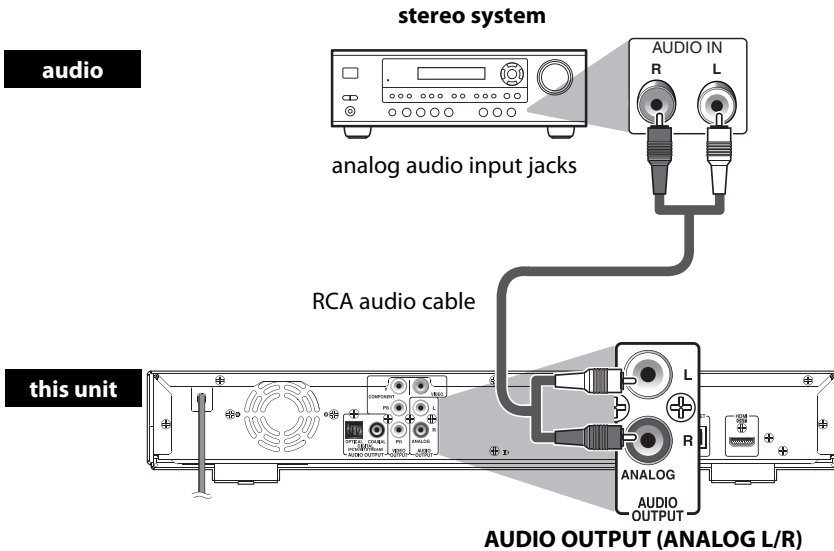

Digital Audio Connection

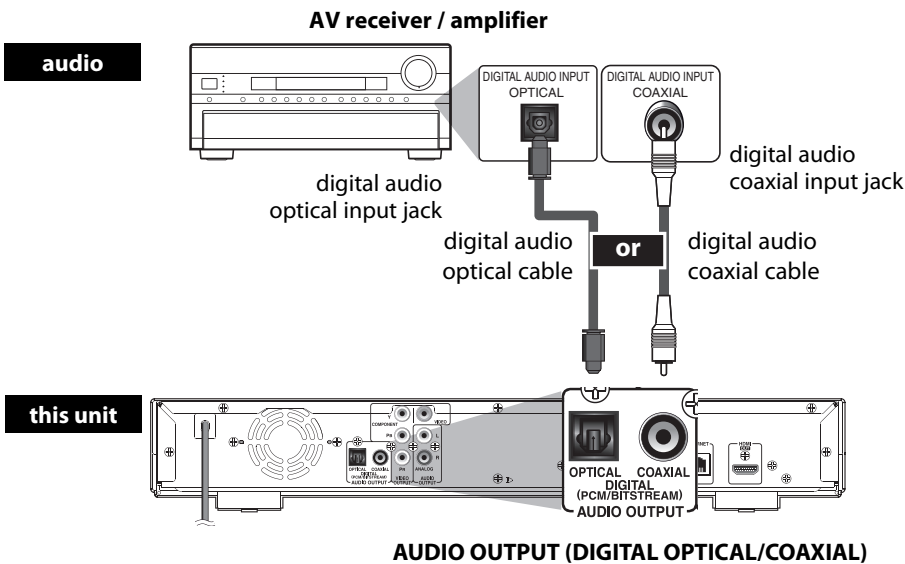

Supplied cables used in this connection are as follows:

- RCA audio cable (L/R) x 1

Please purchase the rest of the necessary cables at your local store.

Note for Digital Audio Optical Cable

- Digital audio optical cable may be damaged when bent at sharp angles. Endure cables are coiled in loops with a diameter of 6 inches (15cm) or more when storing them.
- Use a cable which is 9.8 feet (3m) or shorter.
- Insert cable plugs firmly into the connectors when making connections.
- If a plug has dust or is dirty, clean it with a soft cloth before inserting it into a connector.

■ Audio signals output from AUDIO OUTPUT (DIGITAL OPTICAL / COAXIAL) jacks

For the settings in the “Digital Out” to take effect, “HDMI Audio Out” should be set to “Audio Mute”. Otherwise, the settings made in the “HDMI Audio Out” will have a priority, and the same signal as being output from the HDMI OUT jack will be output from the AUDIO OUTPUT (DIGITAL OPTICAL / COAXIAL) jacks as well. (Except that Dolby Digital will be output instead of Dolby Digital Plus and Dolby TrueHD, and DTS signal will be output instead of DTS-HD.)

	“Digital Out” setting →	“Bitstream”		“LPCM”	
	“BD Audio Mode” setting →	“HD Audio Output”	“Mix Audio Output”	“HD Audio Output”	“Mix Audio Output”
Media ↓	Audio Source ↓	Which audio format can be output depends on the compatibility of the connected device.			
BD-video	Dolby Digital	Dolby Digital	Dolby Digital	Downmix 2ch PCM	Downmix 2ch PCM
	Dolby Digital Plus	Dolby Digital	Dolby Digital	Downmix 2ch PCM* ¹	Downmix 2ch PCM* ²
	Dolby TrueHD	Dolby Digital	Dolby Digital	Downmix 2ch PCM* ³	Downmix 2ch PCM* ⁴
	DTS	DTS	DTS	Downmix 2ch PCM	Downmix 2ch PCM
	DTS-HD	DTS	DTS	Downmix 2ch PCM* ⁵	Downmix 2ch PCM* ⁶
	LPCM	Downmix 2ch PCM	Downmix 2ch PCM	Downmix 2ch PCM	Downmix 2ch PCM
AVCHD	Dolby Digital	Dolby Digital		Downmix 2ch PCM	
	LPCM	Downmix 2ch PCM		Downmix 2ch PCM	
DVD-video	Dolby Digital	Dolby Digital		Downmix 2ch PCM	
	DTS	DTS		Downmix 2ch PCM	
	LPCM	2ch PCM		2ch PCM	
Audio CD / MP3	PCM	2ch PCM		2ch PCM	
DTS-CD	DTS	DTS		Downmix 2ch PCM	

*¹ Full decoded.

*² Only the independent substream is decoded.

*³ Dolby TrueHD stream is decoded.

*⁴ Only the Dolby Digital substream is decoded.

*⁵ Full decoded.

*⁶ Only the core substream is decoded.

- When playing back a BD-video which only contains the primary audio, the audio output will be the same case as the “HD Audio Output” even if the “BD Audio Mode” is set to “Mix Audio Output”.

Note

- In order to output LPCM signal from AUDIO OUTPUT (DIGITAL OPTICAL / COAXIAL) jacks while outputting the HDMI audio signal, set “HDMI Audio Out” setting to “HDMI Multi(LPCM)”.

Network Connection with LAN

- You can use a disc which offers BD-Live function by connecting the unit to the Internet.
(For BD-Live information, please refer to page 29)

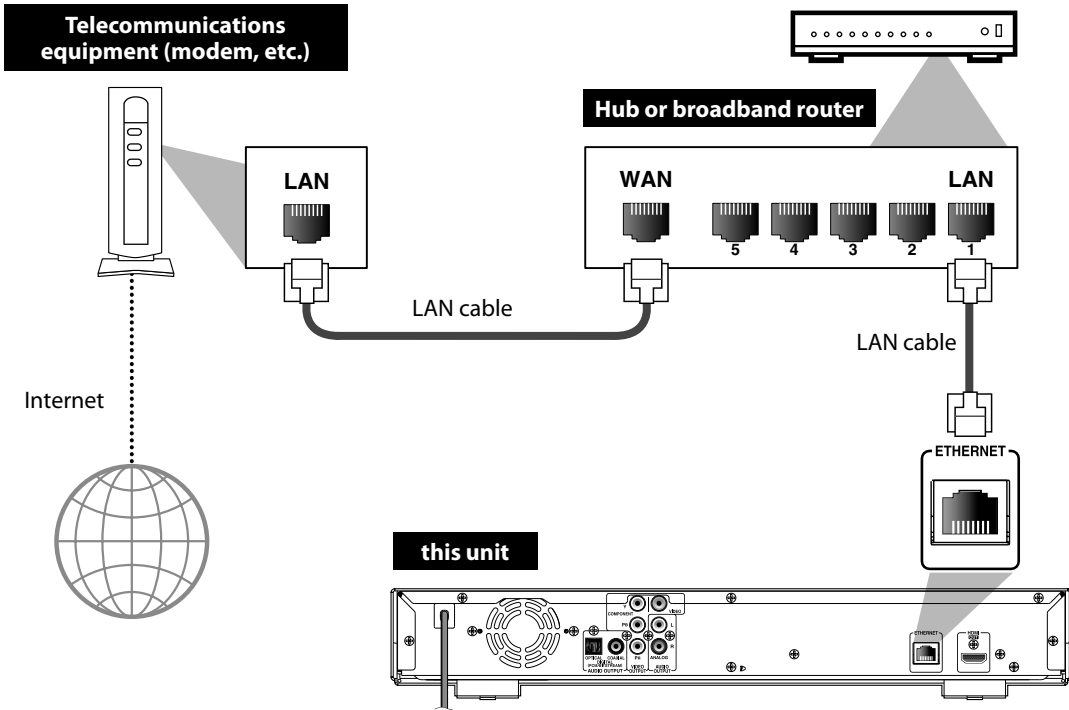

No supplied cables are used in this connection:

Please purchase the necessary cables at your local store.

Note









- After connecting to the Internet, set up necessary network settings.
- Do not insert any cable other than a LAN cable to the ETHERNET terminal to avoid damaging the unit.
- If your telecommunications equipment (modem, etc.) does not have broadband router functions, connect a broadband router.
- If your telecommunications equipment (modem, etc.) has broadband router functions but there is no vacant port, use a hub.
- For a broadband router, use a router which supports 10BASE-T/100BASE-TX.
- Do not connect your PC directly to the ETHERNET terminal of this unit.
- For the network setup, refer to "Network Connection" on pages 45-48.

INFORMATION ON PLAYBACK

Before you start playing back a disc, read the following information.

Playable Discs and Files

This unit is compatible to play back the following discs / files. To play back a disc / file, make sure that it meets the requirements for region codes and color systems as described below. You can play back discs that have the following logos. Other disc types are not guaranteed to play back.

Playable discs	Logos
Blu-ray Disc - BD-video (single / double layer) - BD-RE* (ver. 2.1) (single / double layer) (Recorded in BDMV format) - BD-R (ver. 1.1/1.2/1.3) (single / double layer) (Recorded in BDMV format) (Unclosed discs may not be played back.)	
DVD-video	
DVD+RW (single layer)	
DVD+R (single / double layer) (finalized discs only)	
DVD-RW (single layer) (finalized video mode discs only)	
DVD-R (single / double layer) (finalized video mode discs only)	
CD-DA (audio CD)	
CD-RW	
CD-R	
DTS-CD	—

* Due to the intentional progression of the Blu-ray Disc format by its standard setting authority, the company cannot guarantee or warrant the playability of future extensions of the Blu-ray Disc format with this product.

Playable files	Media
AVCHD	DVD, SD Memory Card (including SDHC), miniSD Card, microSD
MP3	BD, DVD, CD-RW/-R, SD Memory Card (including SDHC), miniSD Card, microSD Card

Readable cards	Playable files / data
SD Memory Card (8MB - 2GB)	AVCHD, MP3, picture-in-picture commentary, subtitles or other extras
SDHC Memory Card (4GB - 8GB)	for BD-ROM ver. 2 (Profile 2.0/Profile 1.1)
miniSD Card (8MB - 2GB)	
microSD Card (8MB - 2GB)	

Note for SD Memory Cards

- Do not remove the SD Memory Card or turn the unit to the standby mode while the contents of the card is in playback. It may result in malfunction or loss of the card's data.
- Please keep the SD Memory Cards in their cases when you are not using them.
- Do not try to open or modify the card.
- Do not touch the terminal surface with your fingers or any metals.
- Do not attach additional labels or stickers to cards.
- Do not remove the label of the SD Memory Cards.
- This unit supports SD Memory Card with FAT12/ FAT16 file system, and SDHC Memory Card with FAT32 file system.
- This unit may not read the SD Memory Cards formatted on computer. If that is the case, please reformat the SD Memory Cards in this unit and try again.
- This unit does not support miniSDHC and microSDHC Memory Card.
- For miniSD Card and microSD Card, the adapter is necessary.

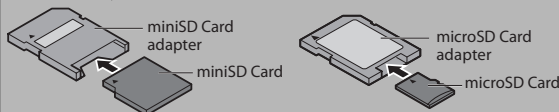

- Portions of this product are protected under copyright law and are provided under license by ARIS / SOLANA / 4C.

Unplayable Discs and Files

The following discs will not be played back in this unit.

- CD-ROM
- CD-I (compact disc-interactive)
- DVD-RAM
- VSD (video single disc)
- DVD-audio
- video CD
- HD DVD
- SVCD
- unfinalized disc
- BD / DVD / CD / SD Memory Card contains DivX®, Windows Media™ Audio and JPEG files.
- Multi-session born BD-RE/-R with MP3 files.
- super audio CD - Only the sound on the CD layer can be heard. The sound on the high-density super audio CD layer cannot be heard.
- Playability of dual discs are not guaranteed.
- BD-RE / -R recorded in BDAV format or non compatible recording format.

INFORMATION ON PLAYBACK

Color Systems

BD-video and DVD-video are recorded in different color systems throughout the world. The most common color system is NTSC (which is used primarily in the United States and Canada).

This unit employs NTSC color system, so the disc you play back must be recorded in the NTSC system. You cannot play back the disc recorded in other color systems.

Region Codes

This unit has been designed to play back BD-video with region "A" and DVD-video with region "1" or "ALL". You cannot play back BD-video or DVD-video that are labeled for other regions. Look for the symbols on the right on your BD-video or DVD-video.

If these region symbols do not appear on your BD-video or DVD-video, you cannot play back the disc in this unit. The letter or number inside the globe refers to region of the world. A BD-video or DVD-video labeled for a specific region can only be played back in the unit with the same region code.

BD-video



DVD-video



Structure of Disc / SD Memory Card Contents

The contents of BD/DVD are generally divided into titles. Titles may be further subdivided into chapters.

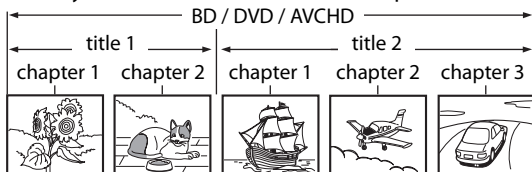

Audio CDs are divided into tracks.



Data discs or SD Memory Cards containing MP3 are divided into folders, and the folders are subdivided into files.

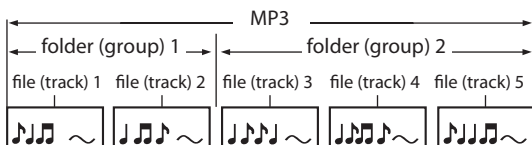

On-Screen Display

You can check information about the current disc by pressing **[DISPLAY]**.

To call the on-screen display menu, press **[DISPLAY]** during playback. Every time you press **[DISPLAY]**, the information changes. Depending on the media, available information varies.

BD-V **AVCHD**

- off → Title / Chapter information
- Title information (elapsed time)
- Title information (remaining time)
- HDMI information → off

DVD-V

- off → Chapter information (elapsed time)
- Chapter information (remaining time)
- Title information (elapsed time)
- Title information (remaining time)
- Bit rate information → HDMI information → off

CD

- off (Track information (elapsed time))
 - Track information (remaining time)
 - Disc information* (elapsed time)
 - Disc information* (remaining time)
 - off (Track information (elapsed time))
- (*not available during the program/random playback)

MP3

- off (File information (elapsed time))
- File name information
- off (File information (elapsed time))

Chapter information

<Title / Chapter information for BD and AVCHD>



<Chapter information for DVD>



- 1 Current title number
- 2 Current chapter number / Total number of chapters
- 3 Current repeat setting (Only when repeat setting is active)
(C: Chapter repeat, T: Title repeat, AB : A-B repeat)
- 4 Indicates that the multi camera angle images are available on the scene
- 5 Current playback status
- 6 Elapsed time / Remaining time of the current chapter

Title information

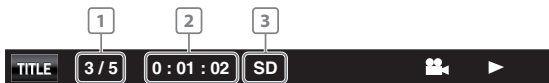

- 1 Current title number / Total number of titles
- 2 Elapsed time / Remaining time of the current title
- 3 Indication of SD Memory Card playback

Bit rate information



- 1 Bit rate (The amount of video data currently being read)
- 2 Layer number
(L0: Layer 0 is played back. L1: Layer 1 is played back)

HDMI information

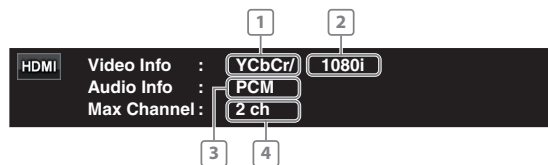

- 1 HDMI video format
- 2 Resolution of the HDMI output image
- 3 HDMI audio format
- 4 Maximum numbers of audio channels that can be accepted by the connected device

Note

- If the HDMI cable is not connected, "----" will be displayed for HDMI information.

Track / File information

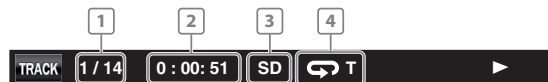

- 1 Current track (file) number / Total number of track (file)
- 2 Elapsed time of the current track and file / Remaining time of the current track
- 3 Indication of SD Memory Card playback
- 4 Current repeat setting
(Only when repeat setting is active)
(T: Track / File repeat, G: Group repeat, A: All repeat, AB: A-B repeat)

Disc information



- 1 Current track number / Total number of tracks
- 2 Elapsed time / Remaining time of the current disc

File name information



- 1 Media icon and file name

 : MP3 file

BASIC PLAYBACK

Playing Back a BD, DVD or a Disc with AVCHD Files

BD-V DVD-V AVCHD

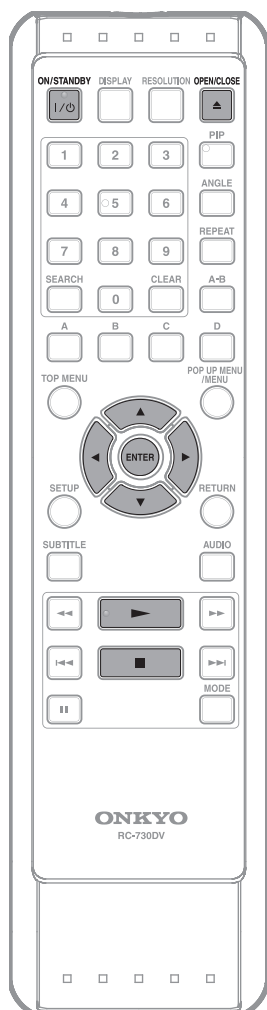

- 1** Press [ON /STANDBY I /⏻].
- 2** Turn on the TV and select the appropriate input on the TV to which the unit is connected.
- 3** Press [OPEN / CLOSE ▲] to open the disc tray.
- 4** Place the disc on the disc tray with its label side facing up.

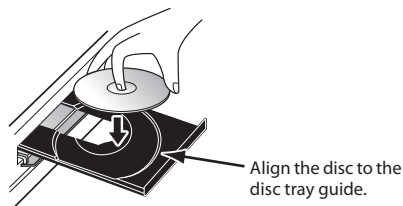

- 5** Press [OPEN / CLOSE ▲] to close the disc tray.

It may take a while to load the disc.

Some discs may start playback automatically.

- 6** Press [PLAY ►] to start playback.
For many of BD-video and DVD-video, a menu screen may appear.
In this case, use [▲ / ▼ / ◀ / ▶] to select the desired item, then press [ENTER].

- 7** Press [STOP ■] once to stop playback temporarily.

Refer to "Resume Playback" on page 23.

To eject the disc:

Press [OPEN / CLOSE ▲] to open the disc tray, then remove the disc before turning off the unit.

Note

- ⊘ may appear at the top-right on the TV screen when the operation is prohibited by the disc or this unit.
- During the playback of 2-layered disc, pictures may stop for a moment. This happens when the 1st layer switches to the 2nd layer. This is not a malfunction.
- BD/DVD/AVCHD/menu varies depending on discs.

Operations Using Title Menu, Disc Menu, and Pop-up Menu

BD-V DVD-V AVCHD

Many of BD-video and DVD-video disc contains title menu (BD-video / DVD-video / AVCHD), disc menu (DVD-video) or pop-up menu (BD-video) which guides you through the available functions in the disc. The contents of the menus may differ depending on the discs.

Title menu (BD-video / DVD-video / AVCHD)

- 1 Press [TOP MENU].
 - The title menu will appear.
- 2 Use [▲ / ▼ / ◀ / ▶] to select an item, then press [ENTER].
- 3 Press [TOP MENU] to exit.

Disc menu (DVD-video)

- 1 Press [POP UP MENU / MENU].
 - The disc menu will appear.
- 2 Use [▲ / ▼ / ◀ / ▶] to select an item, then press [ENTER].
- 3 Press [POP UP MENU / MENU] to exit.

Pop-up menu (BD-video)

• This is a special feature available for some BD-video. When you press [POP UP MENU / MENU], a menu pops out on the TV screen while the contents still play back.

- 1 During the playback of BD-video, press [POP UP MENU / MENU].
 - The pop-up menu will appear.
- 2 Use [▲ / ▼ / ◀ / ▶] to select an item, then press [ENTER].
- 3 Press [POP UP MENU / MENU] to exit.

Note

- Contents of menus and corresponding menu operations may vary among discs. Refer to the manual accompanying the disc for details.

Pause

- 1 During playback, press [PAUSE II].
 - Playback will be paused.



- 2 Press [PLAY ►] to return to normal playback.

Note

- For BD and DVD, set "Still Mode" setting to "Field" in "Video" menu if pictures in the pause mode are blurred (refer to page 37).

Resume Playback

- 1 During playback, press [STOP ■].
 - Resume message will appear on the TV screen.

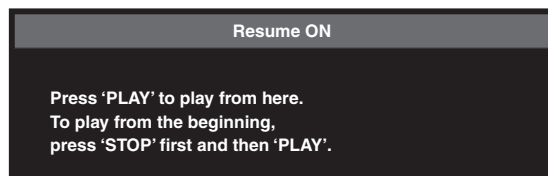

e.g.) BD

- 2 Press [PLAY ►].
 - In a few seconds, playback will resume from the point at which it stopped last. To cancel the resume playback and start playback the disc from the beginning, press [STOP ■] again in stop mode.
 - For MP3, playback will resume from the beginning of the current file.

Note

- Resume playback may not be available for the BD that supports Java applications (BD-Java).
- In the "Disc" mode, the resume information will be cleared when;
 - [STOP ■] is pressed while in stop mode.
 - the parental level is changed.
 - the disc tray is opened.
- In the "SD Card" mode, the resume information will be cleared when;
 - [STOP ■] is pressed while in stop mode.
 - the SD Memory Card is removed.
 - the unit is turned into the standby mode.

Playing Back an Audio CD or a Disc with MP3 Files

CD MP3

1 Insert an audio CD or a disc with MP3 files.

- The file list will appear on the TV screen.

To return to the first item:

- Press [TOP MENU].

To return to the track/file played last:

- Press [POP UP MENU / MENU].

2 Use [▲ / ▼] to select a desired folder or file, then press [ENTER]. Use [◀ / ▶] to go back and forward between the hierarchies.

- If you press [ENTER] on the desired file, playback will start.

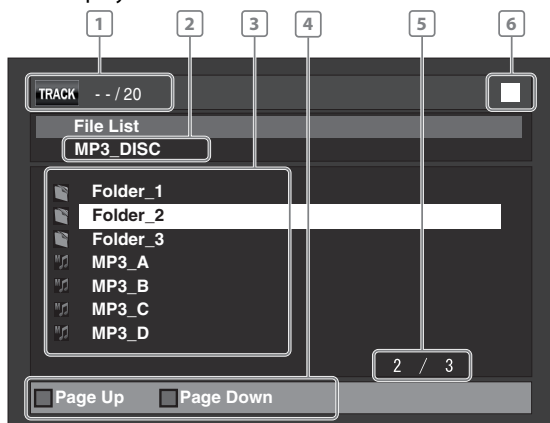

e.g.) MP3

- 1 Track / File information
- 2 audio CD: "CD-DA" will be displayed.
MP3: Current folder name (Disc or SD Memory Card name will be displayed for the top of the hierarchies.)
- 3 audio CD: List of the track number and time
MP3: List of the file / folder names in the current folder / disc)
- 4 Operation Press [A] to go to the previous page.
guide: Press [B] to go to the next page.
- 5 Current page / Total page number
- 6 Playback status

Icons:

- : Folder
- : audio CD track
- : MP3 file

It is recommended that MP3 files to be played back in this unit are recorded under the following specifications:

- Sampling frequency: 32 kHz, 44.1 kHz or 48 kHz
- Constant bit rate: 112 kbps - 320 kbps

Note

- The system can recognize up to 255 folders / 999 files for CD, 999 folders / 9999 files for BD, DVD and SD Memory Card (including the files other than MP3). When number of folder / files exceeds the limit, they will be recognized by the order recorded.
- The name of folder and file can be displayed up to 28 characters. Unrecognizable characters will be replaced with asterisks.
- The 9th and deeper hierarchies cannot be displayed for CD and the 10th and deeper hierarchies cannot be displayed for BD, DVD and SD Memory Card.
- Files whose extension is other than ".mp3 / .MP3" will not be listed.
- Some unplayable folders or files may be listed due to the recording status.
- This unit recognizes up to 8 characters of file name in the SD Memory Card. Characters after 8th will not be displayed.
- For the SD Memory Card playback, refer to "Reading the SD Memory Card" on page 25.
- If a disc contains AVCHD files, the playback of other files which are in the same disc is not available.

Reading the SD Memory Card

AVCHD MP3

You can play back the AVCHD/MP3 files in an SD Memory Card. With the SD Memory Card, you can also enjoy the special additional contents for BD-ROM ver. 2 (Profile 2.0/ Profile 1.1) which can be downloaded from the Internet. You can store the contents on an SD Memory Card via computer and play them back with the BD-video. For more information about the special additional contents, please refer to the instruction book that came with the disc.



■ Setting the media mode

1 In stop mode, press [SETUP].

2 Use [▲ / ▼] to select , then press [ENTER].



3 Use [▲ / ▼] to select "Media Select" setting.

4 Press [ENTER] repeatedly to select "SD Card".

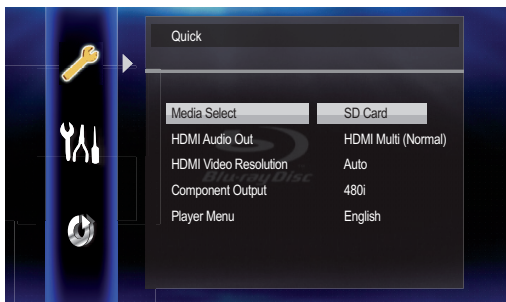

- This will set the unit to "SD Card" mode. To play back the contents in any discs, exit "SD Card" mode by selecting "Disc".

5 Press [SETUP] to exit.

Inserting the SD Memory Card and Playback

1 Insert an SD Memory Card, with the label side facing up, into the SD CARD slot until it clicks.

If no disc is in operation, "Media Select" screen will appear on the TV screen.



2 Use [▲ / ▼] to select "SD Card", then press [ENTER].

The file list will appear.

3 Follow the step 2 in "Playing Back an Audio CD or a Disc with MP3 Files" on page 24.

Removing the SD Memory Card

1 In stop mode, push the SD Memory Card and then slowly remove your finger.

2 Grasp the card and pull it out from the SD CARD slot.

This will set the unit to "Disc" mode.

Compatible Cards:

- SD Memory Card (8MB - 2GB)
- SDHC Memory Card (4GB - 8GB)
- miniSD Card (8MB - 2GB)
- microSD Card (8MB - 2GB)
- For miniSD Card and microSD Card, the adapter will be required.

Note

- The "Media Select" screen will disappear under the conditions listed below:
 - when [RETURN] is pressed.
 - when the setup menu is called up.
- Do not remove the card during its playback.
- This unit supports SD Memory Card with FAT12 / FAT16 file system, and SDHC Memory Card with FAT32 file system.
- Do not delete the folders or files in the SD Memory Card with your computer. This unit might not read the SD Memory Card.
- This unit recognizes up to 8 characters (including "~1") of file name in the SD Memory Card. Characters after 8th will not be displayed.

SPECIAL PLAYBACK

Fast Forward / Fast Reverse

BD-V DVD-V AVCHD CD MP3

1 During playback, press [FWD ►►] repeatedly for fast forward.

During playback, press [REV ◀◀] repeatedly for fast reverse.

Every time you press [FWD ►►] or [REV ◀◀], the playback speed will change.

2 Press [PLAY ►] to return to normal playback.

Note

- For BD, DVD and AVCHD, speed changes in 5 different levels.
- For audio CD and MP3, speed changes in 3 different levels.
- For audio CD, fast forward / fast reverse search between different tracks are not available during program and random playback.
- For MP3, fast forward / fast reverse search between different files are not available.

Slow Forward Playback

BD-V DVD-V AVCHD

1 During playback, press [PAUSE III], then press [FWD ►►].

Every time you press [FWD ►►], playback speed will change.

2 Press [PLAY ►] to return to normal playback.

Note

- Slow forward speed changes in 3 different levels.
- Only slow forward is available.
- Set "Still Mode" setting to "Field" in "Video" menu if pictures in the slow forward playback mode are blurred (refer to page 37).

Step by Step Playback

BD-V DVD-V AVCHD

1 In pause mode, press [PAUSE III] repeatedly.

Every time you press [PAUSE III], playback will advance one step at a time.

2 Press [PLAY ►] to return to normal playback.

Note

- Only step by step forward is available.
- Set "Still Mode" setting to "Field" in "Video" menu if pictures in step by step playback mode are blurred (refer to page 37).

Repeat Playback

Available repeat function may vary depending on the discs.

1 During playback, press [REPEAT] repeatedly to select the desired repeat mode.

Repeat mode	Available media
Chapter repeat The current chapter will be played back repeatedly.	BD-V DVD-V AVCHD
Title repeat The current title will be played back repeatedly.	BD-V DVD-V AVCHD
Track repeat The current track or file will be played back repeatedly.	CD MP3
Group repeat The current folder will be played back repeatedly.	MP3
All repeat All tracks in the media will be played back repeatedly.	CD MP3

Note

- The repeat setting will be canceled when you stop playback.
- The chapter, title, track or group repeat will be cleared when moving to other chapter, title, track / file or folder.
- Repeat playback does not function during A-B repeat playback.
- Chapter and title repeat are not available with some scenes.
- When the repeat setting is set for an MP3 folder, the repeat setting will be cancelled if you select other MP3 folder to playback.

A-B Repeat

BD-V DVD-V AVCHD CD

You can play back the specific part (between point A and point B) repeatedly.

- 1 During playback, press [A-B] at the desired starting point A.
- 2 During playback, press [A-B] at the desired ending point B.

As soon as you set the point B, the part between point A and point B will start playback repeatedly.

- To cancel the A-B repeat, press [A-B] again.

Note

- Point B should be set within the same title or track as point A.
- A-B repeat is not available with some scenes.
- To cancel the A point which was set, press [CLEAR].
- A-B repeat does not function during chapter, title, track, group or all repeat playback.

PIP (Picture in Picture) (BONUSVIEW) Setting

BD-V

Some BD-video have the PIP (picture-in-picture) function which enables you to display the secondary video in the primary video. You can call up the secondary video by pressing [PIP] whenever the scene contains the secondary video.

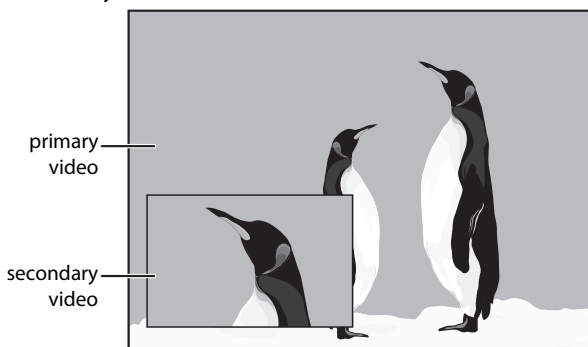

- 1 During playback, press [PIP].
PIP information will appear.
- 2 Use [▲ / ▼] to select the secondary video you want.
• The secondary video will be displayed and the secondary audio will be output.
- 3 Press [RETURN] or [PIP] to remove the PIP information.

Note

- The secondary audio will not be output when the secondary audio is set to "Off" or when "BD Audio Mode" is set to "HD Audio Output". Refer to "Switching Audio Soundtrack" on page 31 and "Setting the BD Audio Mode" on page 32.

Program Playback

CD MP3

You can play back the disc in your desired order.

- 1 In stop mode, press [MODE].
• The program screen will appear.
- 2 Use [▲ / ▼] to select a track / file, then press [ENTER].

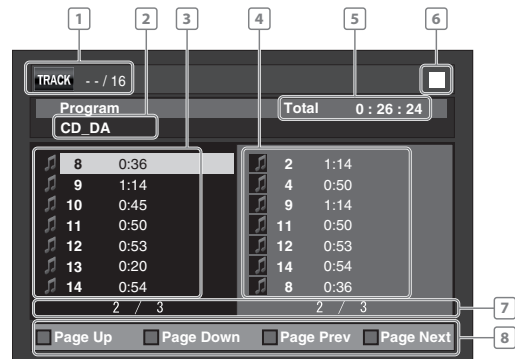

e.g.) audio CD

- 1 Track / File information
- 2 audio CD: "CD-DA" will be displayed.
MP3: Current disc, SD Memory Card, or folder name will be displayed.
- 3 Track / File list: Track / File list in the original order
- 4 Programmed list: Track / File list in the programmed order
- 5 Cumulative playback time of all tracks in the programmed list
- 6 Playback status
- 7 Current page / Total page number
- 8 Operation Guide: Press [A] to go to the previous page in the track / file list.
Press [B] to go to the next page in the track / file list.
Press [C] to go to the previous page in the programmed list.
Press [D] to go to the next page in the programmed list.

- For MP3 files, use [▲ / ▼] to select a folder, then press [ENTER] first, and then use [▲ / ▼] to select a file, then press [ENTER].
- Press [CLEAR] to erase the last file of the program.
- Use [▲ / ▼] to select "All Clear" at the bottom of the list to erase all the tracks / files in the program.
- The programmed tracks / files is displayed in the right hand screen.
- Use [◀ / ▶] to go back forward between the hierarchy of folders.

3 Press [PLAY ►] to start program playback.

- Program playback will start.

To exit from the program playback mode:

- Press [RETURN] in stop mode.

Note

- During program playback, press [STOP ■] once to set the resume point, and then press [PLAY ►] to resume program playback from where [STOP ■] was pressed (audio CD) or from beginning of the file where [STOP ■] was pressed (MP3).
- During program playback, press [STOP ■]. To go back to the normal program playback, press [RETURN] to exit from the program screen, then press [PLAY ►].
- The program will be cleared when:
 - the unit is turned into the standby mode.
 - the media mode is switched to the other mode.
 - the disc / card is removed. (as for "Disc" mode, just opening the disc tray will clear the program info.)
- Up to 99 tracks / files can be entered.
- To repeat the current track / file in the program, press [REPEAT] repeatedly until "Track" appears during playback. To repeat the entire program, press [REPEAT] repeatedly until "All" appears during playback.
- Playback from a desired track / file and random playback are not available during program playback.
- Press [MODE] to switch to the random playback mode.

Random Playback



This function shuffles the playback order of tracks / files.

1 In stop mode, press [MODE] twice.

- The random screen will appear.

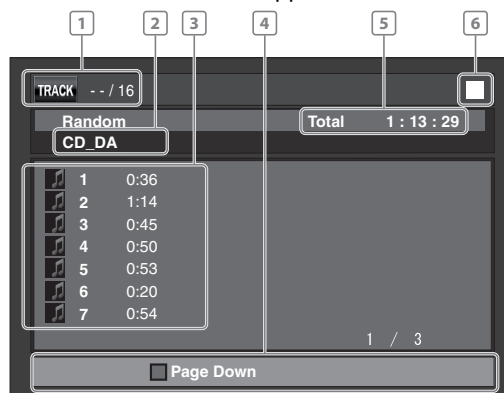

e.g.) audio CD

- Track / File information**
- audio CD:** "CD-DA" will be displayed.
MP3: Current disc, SD Memory Card, or folder name will be displayed.
- Track / File list:** Track / File list in the original order
- Operation guide:** Press [A] to go to the previous page in the track / file list. Press [B] to go to the next page in the track / file list.
- Total playback time of all tracks**
- Playback status**

2 Press [PLAY ►] to start random playback.

To exit from the random playback mode:

- Press [MODE] in stop mode.

Note

- During the random playback, press [STOP ■] once to set the resume point, and then press [PLAY ►] to resume random playback from where [STOP ■] was pressed (audio CD) or from beginning of the file where [STOP ■] was pressed (MP3).
- During random playback, press [STOP ■]. To cancel the random playback, press [MODE] when the random playback screen is displayed.
- Up to 99 tracks / files can be entered.
- To repeat the current track / file in the random selection, press [REPEAT] repeatedly until "Track" appears during playback. To repeat the entire random selection press [REPEAT] repeatedly until "All" appears during playback.
- You cannot go back to the previous track / file during random playback.

Rapid Playback

BD-V DVD-V AVCHD

This function plays back approximately at 1.3 times the normal playback while keeping the sound output. This function is available only on discs recorded in the Dolby Digital format.

- 1 During playback, press [MODE] repeatedly until the Rapid playback setting appears.**

 Off

- 2 Press [ENTER] or [◀/▶] to switch  (x1.3), or off.**

“Off”: Plays back in normal speed.

“”: Plays back approximately at 1.3 times of normal playback.

- 3 Press [▶] to return to normal playback.**

Note

- Picture adjustment and audio language setting cannot be changed during this function.
- This function may not work at some points on a disc.
- During this function, 2ch LPCM will be output from HDMI OUT jack and AUDIO OUTPUT (DIGITAL OPTICAL / COAXIAL) jacks.

Camera Angle

BD-V DVD-V

Some BD-video and DVD-video contain scenes which have been shot simultaneously from various angles. You can change the camera angle when  appears on the TV screen.

- 1 During playback, press [ANGLE].**

- The selected angle will be displayed on the display bar at the top of the TV screen.

- 2 Use [▲ / ▼] to select your desired angle.**

 1 / 3 

Note

- If “Angle Icon” setting is “Off” in “Others” menu,  will not appear. Refer to page 43.

Enjoying BD-Live Discs with Internet

BD-V

You can enjoy the BD-Live functions which enable you use the interactive functions when the unit is connected the Internet. (For the Network connection, refer to pages 45-48.)

Examples for BD-Live interactive functions :

- Download the additional contents such as the movie’s trailer, subtitles and BD-J, etc.
- While downloading, special video data may be played back.

Service and functions differ depending on the disc. Follow the instructions given by the disc when using the BD-Live function.

Note

- You must connect the unit to the Internet and set up necessary settings in order to use the BD-Live function.
- For certain discs, setting for “BD-Live Setting” may need to be changed.
- Depending on your connection environment, it may take time to connect to the Internet or the Internet may not be connected.
- When BD-Live functions are used and the unit is connected to the Internet, you may be charged for this communication.
- You must insert an SD memory card when using the BD-Live function. (SD memory card of 1GB is recommended.)
- Do not remove the SD memory Card when using the BD-Live function.

Note for AACs Online

- The player or disc IDs may be sent to the content provider when playing back a disc with BD-Live function.
- If you save your viewing history on the server by using these IDs, you will be introduced to other similar movies.
- You can save game score histories.

Using [SKIP |◀◀ / ▶▶|]

- 1 During playback, press [SKIP ▶▶|] to move to the next track. Press it repeatedly to skip to subsequent tracks. Press [SKIP |◀◀] once to go back to the beginning of the current track. Press it repeatedly to go to the previous tracks.

Note

- For BD and DVD, if title contains no chapters, [SKIP |◀◀ / ▶▶|] changes the title.

Using [SEARCH]

By using [SEARCH], you can select following search modes.

Search mode	Available media
CHAPTER / TITLE Chapter / Title search	BD-V DVD-V AVCHD
TRACK Track search	CD MP3
TIME Time search	BD-V DVD-V AVCHD CD
MARKER Marker search	BD-V DVD-V AVCHD

- 1 During playback, press [SEARCH] repeatedly until your desired search mode appears.
- 2 Enter the desired chapter, title, track, file number or time to search for using [the Number buttons].
 - Chapter, title, track or time search will start.
 - Press [CLEAR] to erase an incorrect input.

Note

- During program and random playback, search functions are not available except the search using [SKIP |◀◀ / ▶▶|].
- Time search is available only in the same track, file or title.
- For BD/AVCHD, chapter and time search are available only during playback.

Using [the Number buttons] (Direct Search)

Title Search

- 1 In stop mode, enter the title number you want to search using [the Number buttons].
 - Playback of the title will start in a few seconds.

Chapter Search

- 1 During playback of a title, enter the chapter number you want to search using [the Number buttons].
 - Playback of the chapter will start in a few seconds.

Note

- As for the BD-video, how it performs will be strongly determined by the disc, and may not perform as described here.

Marker search

This feature allows you to assign a specific point on a title or track to be called back later.

- 1 During playback, press [SEARCH] repeatedly until the marker setting menu appears.
- 2 Use [◀ / ▶] to select a marker number (1-9).



- 3 When the disc reaches the point at which you want to set a marker, press [ENTER].
 - The title or track and elapsed playback time will appear on the TV screen.
- 4 Press [SEARCH] or [RETURN] to exit.
- 5 To return to the marker later, call the marker setting by pressing [SEARCH] repeatedly during playback or in stop mode, and use [◀ / ▶] to select a desired marker, then press [ENTER].

Note

- Opening the disc tray, changing to the standby mode or selecting "AC" at step 2 and pressing [ENTER] will erase all markers.
- To clear a marker, use [◀ / ▶] to select the marker number to be cleared and press [CLEAR].
- You can mark up to 9 points.
- For BD/AVCHD, marker search between different titles is not available.
- For BD/AVCHD, you can return to the maker only during playback.

SPECIAL SETTINGS

You can select the format of audio and video as you prefer depending on the contents of the disc you are playing back.

Switching Subtitles

Some BD and DVD may have subtitles in 1 or more languages. For commercially available discs, the supported languages can be found on the disc case. Follow the steps below to switch the subtitle languages during playback.

BD-V

1 During playback, press [SUBTITLE] repeatedly to display "Primary Subtitle", "Secondary Subtitle" or "Subtitle Style".

"Primary Subtitle": Sets the subtitle for the primary video.

"Secondary Subtitle": Sets the subtitle for the secondary video.

"Subtitle Style": Sets style of the subtitle.

2 Use [▲ / ▼] to select your desired subtitle or style.



• Use [◀ / ▶] to switch between current subtitle setting and "Off".

3 Press [SUBTITLE] repeatedly to exit.

DVD-V AVCHD

1 During playback, press [SUBTITLE].

2 Use [▲ / ▼] to select your desired subtitle.



• Use [◀ / ▶] to switch between current subtitle setting and "Off".

3 Press [SUBTITLE] to exit.

Note

- Some discs will only allow you to change the subtitles from the disc menu or pop-up menu. Press [TOP MENU] or [POP UP MENU / MENU] to display the disc menu or pop-up menu.
- If 4-digit-language code appears in the subtitle menu, refer to "LANGUAGE CODE" on page 54.
- If the disc has no subtitle language or subtitle style, "Not Available" will be displayed on the TV screen.
- During playback of the secondary video, the primary subtitle setting is not available except when there is no subtitle for the secondary video.
- Secondary subtitle setting is only available during playback of the secondary video.
- If you choose a language that has a 3-letter-language code, the code will be displayed every time you change the subtitle language setting. If you choose any other Languages, "----" will be displayed instead (refer to page 54).

Switching Audio Soundtrack

Some BD and DVD contain multiple audio streams. Those are often in different audio languages or audio formats. For BD, available audio varies depending on "BD Audio Mode" setting. Refer to page 38 for more information.

BD-V

1 During playback, press [AUDIO] repeatedly to display "Primary" or "Secondary".

"Primary": Sets the audio for the primary video.

"Secondary": Sets the audio for the secondary video.

2 Use [▲ / ▼] to select your desired audio stream channel.



• For "Secondary", use [◀ / ▶] to switch between current audio setting and "Off".

3 Press [AUDIO] repeatedly to exit.

DVD-V AVCHD CD

1 During playback, press [AUDIO].

2 Use [▲ / ▼] to select your desired audio stream channel.



e.g.) DVD-video

• For audio CD, you can select following options.

"Stereo": Both right and left channels are active (stereo).

"L-ch": Only left channel is active.

"R-ch": Only right channel is active.

3 Press [AUDIO] to exit.

Note

- The secondary audio will not be output when the secondary video is not displayed or when "BD Audio Mode" is set to "HD Audio Output". (For some BD, secondary audio will be output even when secondary video is off.)
- The sound mode cannot be changed during playback of discs not recorded in multiple audio.
- Some discs allow to change audio language setting on the disc menu. (Operation varies depending on the discs. Refer to the manual accompanying the disc.)
- [AUDIO] may not work on some discs with multiple audio streams or channels (e.g. DVD which allow to change audio setting on the disc menu).
- If you select a language that has a 3-letter-language code, the code will be displayed every time you change the audio language setting. If you select any other languages, "----" will be displayed instead (refer to page 54).
- If 4-digit-language code appears in the subtitle menu, refer to "LANGUAGE CODE" on page 54.
- If the disc has no audio language, "Not Available" will be displayed on the TV screen.
- For DTS-CD (5.1 music disc), "DTS" will be displayed. (Selecting audio streams or channels is not available.)

Setting the BD Audio Mode

BD-V

There are 2 ways to set "BD Audio Mode" setting; whether to output the secondary and interactive audio accompanied by the primary audio or only the primary audio. Depending on the setting of the mode, Dolby Digital, Dolby Digital Plus, Dolby TrueHD, DTS, or DTS-HD output changes between multi LPCM and bitstream.

- 1 In stop mode with BD inserted, press [MODE].
- 2 Use [▲ / ▼] to select your desired setting.



"Mix Audio Output":

If it is available, BD-video's secondary and interactive audio will be output with the primary audio.

- The secondary audio is the audio for the secondary video (Director's comment etc.) and the interactive audio is the audio for the interactive application (Button click sounds etc.).

"HD Audio Output":

Only the primary audio will be output. Set this mode in order to output Dolby Digital, Dolby Digital Plus, Dolby TrueHD, DTS or DTS-HD audio of BD through HDMI connection.

- 3 Press [RETURN] to exit.

- You can also set "BD Audio Mode" from the setup menu. Refer to page 38.

Note

- In "Mix Audio Output" mode, if there is no secondary and interactive audio, the audio will be output as "HD Audio Output" mode.
- In "Mix Audio Output" mode, even if you set "HDMI Multi(Normal)" in "HDMI Audio Out" setting, multi LPCM will be output from HDMI OUT jack for BD audio. Refer to page 14.
- In "Mix Audio Output" mode with HDMI audio being output, 2-channel down-mixed LPCM will be output from AUDIO OUTPUT (DIGITAL OPTICAL / COAXIAL) jacks for BD audio.
- In "Mix Audio Output" mode with "HDMI Audio Out" setting set to "Audio Mute" and "Digital Out" setting set to "Bitstream", DTS, DTS-HD and LPCM will be output as Dolby Digital for BD audio. Refer to pages 14, 17.
- You can also set "BD Audio Mode" setting from the setup menu. Refer to page 38.

Adjusting the Picture

BD-V DVD-V AVCHD

You can adjust the picture quality and store the setting you have adjusted on memory 1-5.

- 1 During playback, press [MODE] repeatedly until the picture adjustment menu appears.



- 2 Use [▲ / ▼] to select a memory from "Memory 1" to "Memory 5" to store your setting, then press [ENTER].
- 3 Use [▲ / ▼] to select a item to be adjusted, then use [◀ / ▶] or [ENTER] to adjust the setting.



item	Description	adjustment range
1. Contrast	Adjusts the difference between the bright and dark parts of the picture.	-7 to +7(0*)
2. Brightness	Adjusts the brightness of the picture.	0 to +15(0*)
3. Sharpness	Adjusts the sharpness of the picture for frequency range.	-6 to +6(0*)
4. Gamma Correction	Detailed adjustment of the picture's brightness.	0 to +5(0*)
5. Color	Adjusts the balance between green and red.	-7 to +7(0*)
6. Black Level	Adjusts the black level.	On*:Makes the dark parts brighter. Off :Shows the original picture as recorded.
7. Noise Reduction (Not available for BD/AVCHD)	Reduces the noise of the playback picture.	Off* 1 :Executes MPEG noise reduction which reduces the block noise and mosquito noise on the subtitle on movie. 2 :Executes 3D noise reduction which detects and deletes the noise by comparing each picture frames. 3 :Executes both MPEG noise reduction and 3D noise reduction.

* Default setting

Note

- The setting remains even you turn the unit into the standby mode except unplug the AC cord.
- For the picture output from HDMI OUT jack, "Black Level" is not effective.
- For BD and AVCHD files, noise reduction is not effective.

FUNCTION SETUP

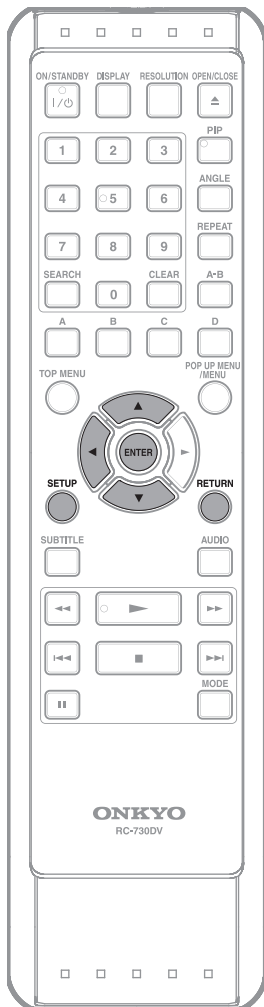

Using the Setup Menu

In the setup menu you can change the setting for audio, video, language, etc. You cannot change the setting during playback.

Setting items displayed in gray indicates they are not available under the conditions at the time.

Quick

“Quick” menu contains setting items extracted from “Custom” menu which may be used frequently.

1 In stop mode, press [SETUP].

2 Use [▲ / ▼] to select , then press [ENTER].

3 Use [▲ / ▼] to select your desired setting items.



4 Follow the procedure below depending on the setting items.

- A) If “▶” does not appear on the right side of the setting items when you highlight the items:
Press [ENTER] repeatedly to change options.
- B) If “▶” appears on the right side of the setting items when you highlight the items:
 - 1) Press [ENTER].
 - 2) Use [▲ / ▼] to select options, then press [ENTER].
 - Use [◀] or [RETURN] to go back to the previous screen.

5 Press [SETUP] to exit.

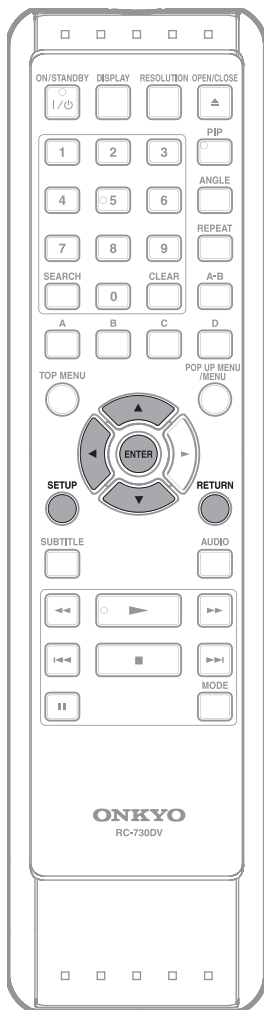

Custom

"Custom" menu contains all the setting items.

1 In stop mode, press [SETUP].

2 Use [▲ / ▼] to select , then press [ENTER].

3 Use [▲ / ▼] to select your desired setting category, then press [ENTER].

 : Language

 : Video

 : Audio

 : Parental

 : Others

- For "Parental" menu, follow the procedure on page 42.

4 Use [▲ / ▼] to select your desired setting items.

- The setting items which are not available with current situation of this unit will be displayed in gray and you cannot select them.

5 Follow the procedure below depending on the setting items.

A) If "▶" does not appear on the right side of the setting items when you highlight the items:

Press [ENTER] repeatedly to change options.

B) If "▶" appears on the right side of the setting items when you highlight the items:

1) Press [ENTER].

2) Use [▲ / ▼] to select options, then press [ENTER].

- Use [◀] or [RETURN] to go back to the previous screen.

6 Press [SETUP] to exit.

■ Language



- For how to select the setting items and options, refer to “Custom” on page 34.

Setting items	Options
Audio Sets the language for audio.	Original* / English / French / Spanish / German / Italian / Swedish / Dutch / Russian / Chinese / Japanese / Korean / Danish / Finnish / Norwegian / Icelandic / Hungarian / Romanian / Turkish / Greek / Irish / Portuguese / Polish / Czech / Slovak / Bulgarian / Other
Subtitle Sets the language for subtitle.	Off* / English / French / Spanish / German / Italian / Swedish / Dutch / Russian / Chinese / Japanese / Korean / Danish / Finnish / Norwegian / Icelandic / Hungarian / Romanian / Turkish / Greek / Irish / Portuguese / Polish / Czech / Slovak / Bulgarian / Other
Disc Menu Sets the language for disc menu or pop-up menu.	English* / French / Spanish / German / Italian / Swedish / Dutch / Russian / Chinese / Japanese / Korean / Danish / Finnish / Norwegian / Icelandic / Hungarian / Romanian / Turkish / Greek / Irish / Portuguese / Polish / Czech / Slovak / Bulgarian / Other
Player Menu  Sets the language for OSD (on-screen display).	Auto(XXXX)* ¹ / English* / Français / Español

) Settings with () are the default.

*¹) “Auto” activates the Get & Set Menu Language function. (Refer to page 44)

- “Auto” is available only when “HDMI CEC” is set to “On”.

- Inside the parentheses next to “Auto” will be the language which is currently selected by your TV.



• “Quick” menu consists of the setting menus frequently used, and they are accompanied with .

• If you select “Other”, enter the 4-digit-number code for the desired language (Refer to “LANGUAGE CODE” on page 54). Only the languages supported by the disc can be selected.

Video



- For how to select the setting items and options, refer to “Custom” on page 34.

Setting items	Options
TV Aspect Sets the picture size according to aspect ratio of the connected TV.	16:9 Wide*: Select this when a wide-screen TV is connected. Discs recorded in wide-screen format is played back over the entire TV screen. 4:3 Pan & Scan: Select this to play back the discs recorded in wide-screen format with 4:3 TV in the pan & scan mode (with the sides of the picture cut off). Discs which are not specified for pan & scan are played back in the letter box mode. 4:3 Letter Box: Select this to play back the discs recorded in wide-screen format with 4:3 TV in the letter box mode. (with black strips at the top and bottom). 16:9 Squeeze: When playing back 4:3 images, the picture is displayed in the center of the 16:9 screen with a 4:3 aspect ratio.
HDMI Video Resolution  Sets the HDMI video resolution.	Auto*: HDMI video resolution will be selected automatically depending on the connected HDMI device. 480p 720p 1080i 1080p 1080p24: Gives a natural and high quality film reproduction of 24-frame film material. The connected TV has to be compatible with 1080p24 frame input.
HDMI Deep Color Sets whether to output the picture from HDMI OUT jack with Deep Color or not.	Auto*: The picture from HDMI OUT jack will be output with Deep Color to the connected TV which supports HDMI Deep Color. Off: The picture from HDMI OUT jack will be output without Deep Color.
Component Output  Sets the video resolution for component output.	480i* 480p 720p 1080i
Progressive Mode Sets the optimum progressive mode for the image material output from HDMI OUT jack and VIDEO OUTPUT (COMPONENT) jacks.	Auto*: The progressive mode will detect 24-frame film material (movies) and automatically select appropriate progressive mode. Video: Suited for playing back video material discs (TV shows or animation).

Setting items	Options
Still Mode ^{*1} Adjusts picture resolution and quality in still mode.	Auto [*] : Automatically selects the best resolution setting ("Frame" or "Field") based on the data characteristics of the pictures.
	Field : Stabilizes the pictures, although the picture quality may become coarse due to the limited amount of data. Select "Field" when the pictures are still unstable even if "Auto" is selected.
	Frame : Displays relatively motionless pictures in higher resolution. "Frame" improves the picture quality, although it may unstabilize the pictures due to alternate output of 2-field data.

) Settings with () are the default.

*1) An individual picture on the TV screen is called "Frame", which consists of two separate images called "Field".

Some pictures may be blurred at the auto setting in "Still Mode" setting due to their data characteristics.

- "Quick" menu consists of the setting menus frequently used, and they are accompanied with .
- If you set "HDMI Video Resolution" setting to "1080p24" and the contents of the BD are not compatible for 1080p24 frame, 1080p60 frame will be output.
- If the picture is not output properly to the TV because of "HDMI Video Resolution" or "Component Output" setting, press and hold [PLAY ►] on the front panel for more than 5 seconds. Both settings will be reset to the default automatically.
- If an HDMI cable is connected, for video resolution for the component output, you can only select video resolution that currently output from HDMI OUT jack or "480i".
- If the video resolution for the component output and HDMI video resolution do not match, the video resolution for the component output will be switched to "480i". VIDEO OUTPUT (COMPONENT) jacks may not output any signals depending on the disc material.
- If you play back copy-protected DVD-video, 480p signal will be output from VIDEO OUTPUT (COMPONENT) jacks, when "Component Output" setting is set to "720p" or "1080i".

■ Audio



- For how to select the setting items and options, refer to “Custom” on page 34.

Setting items	Options
BD Audio Mode For BD, selects whether to output the secondary and interactive audio with primary audio if it is available or only the primary audio. Refer to “Setting the BD Audio Mode” on page 32.	HD Audio Output*: Outputs only the primary audio. Set this mode in order to output Dolby Digital, Dolby Digital Plus, Dolby TrueHD, DTS or DTS-HD audio of BD through HDMI connection.
	Mix Audio Output: Outputs the secondary and interactive audio with primary audio if it is available.
HDMI Audio Out  Sets the audio format for the audio output from HDMI OUT and AUDIO OUTPUT (DIGITAL OPTICAL / COAXIAL) jacks.	HDMI Multi(Normal)*: The multi-channel audio signals are output from HDMI OUT jack with bitstream or LPCM.
	HDMI Multi(LPCM): The multi-channel audio signals are output from HDMI OUT jack with LPCM. • Refer to pages 39-41 for setting options.
	HDMI 2ch: The audio signals are output from the HDMI OUT jack with a downmixed to 2ch LPCM.
	Audio Mute: Mutes the HDMI audio signal, and set the signal format from AUDIO OUTPUT (DIGITAL OPTICAL / COAXIAL) jacks. • Refer to “Digital out setting” on page 39 for setting options.
Down Sampling Sets the digital audio output when playing back BD or DVD recorded in LPCM.	On*: LPCM signals are converted to 48 kHz for output. • Set to “On” when using digital connections to an AV receiver that is not compatible with sampling frequencies of 96 kHz.
	Off: For BD and DVD recorded in LPCM without copyright protection, 2-channel audio signals up to 192 kHz are output as LPCM signals with no conversion.
DRC Sets whether to compress the range of sound volume (dynamic range control) when Dolby Digital, Dolby Digital Plus or Dolby TrueHD audio is played back.	Auto*: When the discs recorded in Dolby TrueHD format are in playback, this unit detects DRC setting of the disc and set “DRC” setting to “On” or “Off” automatically.
	Off
	On

) Settings with () are the default.

- “Quick” menu consists of the setting menus frequently used, and they are accompanied with .
- Under following circumstances, “HDMI Multi(Normal)”, “HDMI Multi(LPCM)” and “HDMI 2ch” are not available.
 - HDMI cable is not connected to HDMI OUT jack.
 - Connected TV is off.
 - Connected TV is not compatible with audio output.

■ Digital out setting

When "Audio Mute" is selected in "HDMI Audio Out" setting, HDMI audio signal will be muted and the audio signals output from AUDIO OUTPUT (DIGITAL OPTICAL / COAXIAL) jacks change depending on "Digital Out" setting.

Quick → HDMI Audio Out → Audio Mute → Digital Out

Bitstream*:

When playing back discs recorded in Dolby Digital, Dolby Digital Plus, Dolby TrueHD, DTS or DTS-HD, the corresponding core stream (Dolby Digital or DTS) are output.

LPCM:

LPCM signal will be output from AUDIO OUTPUT (DIGITAL OPTICAL / COAXIAL) jacks.

- This setting is not effective when the HDMI audio signal is output.

■ Speaker setting

This unit allows you to enjoy multi-channel surround sound such as 7.1-channel / 5.1-channel surround.

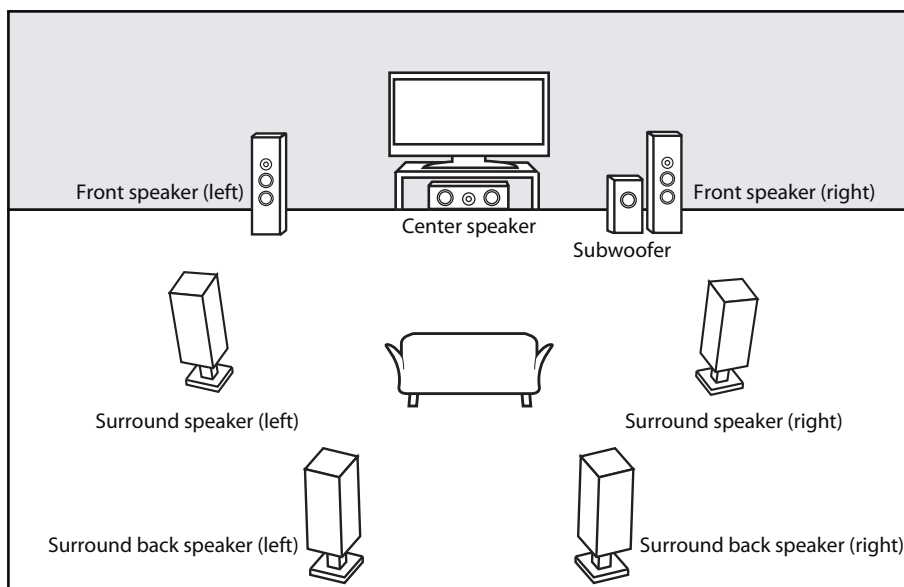

e.g.) basic layout with 7.1-channel surround system

To make the most of its feature, set up your speakers appropriately by referring to the following table.

Speaker setting options are available at the following locations;

<Speaker setting for the audio signal output from HDMI OUT jack>

(Available when you have HDMI cable connected to HDMI OUT jack)

Quick → HDMI Audio Out → HDMI Multi(LPCM)

Custom → Audio → HDMI Audio Out → HDMI Multi(LPCM)

FUNCTION SETUP

How to navigate through "HDMI Multi(LPCM)".

1 Use [▲ / ▼] to select your desired menu item then press [ENTER].

2 Use [▲ / ▼] to select your setting items.

- Press [RETURN] to go back to the previous screen.

3 Use [◀ / ▶] to select desired options. (Except for "Test Tone", "Default" and setting options in "Speaker Size" setting.)

For setting options in "Speaker Size" setting:

Press [ENTER] to select desired options.

For "Test Tone":

Use [◀ / ▶] to select "Off", "Manual" or "Auto", then press [ENTER].

- The test tone will be output. If you select "Manual", use [▲ / ▼] to select desired speaker, then use [◀ / ▶] to adjust the volume. If you select "Auto", use [◀ / ▶] to adjust the volume of the speaker that outputs the test tone.
- If you want to stop the test tone, press [RETURN].

For "Default":

Press [ENTER] to reset to the default.

4 Press [SETUP] to exit.

Menu	Setting items	Options	Descriptions
Speaker Size Selects the desired speaker to set. Then change the setting appropriately by referring to the descriptions.	Front	Large*	Large: For the large speakers with strong low frequency reproduction capabilities. Small: For the small speakers which do not provide strong bass sound. You cannot change the setting of "Subwoofer". If connected device is not compatible with subwoofer, "Subwoofer" will be displayed in gray.
		Small	
	Center	Large*	
		Small	
	Subwoofer	On	
	Surround	Large*	
		Small	
Surround Back	Large*		
	Small		
Default			Select "Default", then press [ENTER] to reset "Speaker Size" setting to the default.
Channel Level Tests or sets the volume for each speaker.	Test Tone: "Test Tone" is the test tone which can be output from the speakers so that you can adjust the volume for each speaker.	Off*	Select "Off" to deactivate "Test Tone".
		Manual	Select "Manual", then press [ENTER] to manually set the volume for the desired speaker.
		Auto	Select "Auto", then press [ENTER] to automatically output the test tone from each speaker.
	Front Lch	0 dB to -12 dB (0 dB*)	If you have selected "Manual" in "Test Tone", select the desired speaker to set and adjust the volume for the selected speaker. If you select "Auto" in "Test Tone", test tone will automatically be output in order. Adjust the volume of the speaker that outputs the test tone.
	Center	0 dB to -12 dB (0 dB*)	
	Subwoofer	0 dB to -12 dB (0 dB*)	
	Front Rch	0 dB to -12 dB (0 dB*)	
	Surround Rch	0 dB to -12 dB (0 dB*)	
	Surround Back Rch	0 dB to -12 dB (0 dB*)	
	Surround Back Lch	0 dB to -12 dB (0 dB*)	
Surround Lch	0 dB to -12 dB (0 dB*)		
Default			

FUNCTION SETUP

Menu	Setting items	Options	Descriptions
Delay Time This is a parameter for optimizing the timing at which the sound is output from the speakers according to their distance from the listening position.	Distance	Feet*	Set the desired measure system. This measure system will be used for "Delay Time" setting. Press [ENTER] (or [◀/▶]) to switch the settings.
		Meters	
	Front	0ft to 60ft (12ft*) (0m to 18m (3.6m*))	Select the distance from the listening position to the speaker to get the ideal delay time.
	Center	0ft to 60ft (12ft*) (0m to 18m (3.6m*))	
	Surround	0ft to 60ft (10ft*) (0m to 18m (3.0m*))	
	Surround Back	0ft to 60ft (10ft*) (0m to 18m (3.0m*))	
Default			Select "Default", then press [ENTER] to reset "Delay Time" setting to the default.

) Settings with () are the default.

- For "Speaker Size" setting, the settings of each speaker size may be adjusted automatically corresponding to each setting. (e.g. If "Front" is set to "Small", you cannot set "Center", "Surround", and "Surround Back" to "Large".)
- For "Delay Time", the difference between the value of the "Front", "Surround" and "Surround Back" setting cannot exceed 15 ft (4.5m), and the difference between the value of the "Front" and "Center" setting cannot exceed 5 ft (1.5m).

■ Parental

Ratings control allows you to set a limit, which prevents your children from viewing inappropriate materials. Playback will be stopped if the ratings exceed the levels you set, and it will require you to enter a password before playing back the disc.

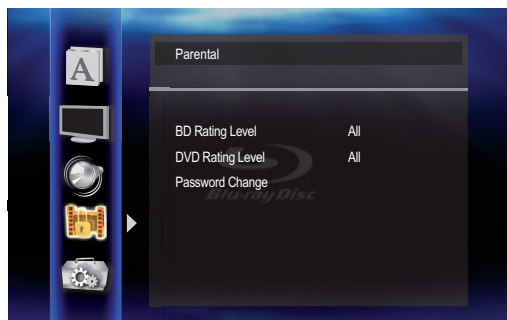

1 Use [**▲** / **▼**] to select , then press [ENTER].

2 Use [the Number buttons] to enter your 4-digit password.

For the first time use: Use [the Number buttons] to enter any 4-digit number (except for 4737), then press [ENTER]. That number will be used as the password from the second time. Record your password in case you forget it.

- If you forget the password, enter [4], [7], [3], [7]. The password will be cleared and rating level will be set to "All".
- While you input the password, press [CLEAR] to clear the number, then re-enter the password.

3 Proceed to A – C

A) BD Rating Level

1) Use [**▲** / **▼**] to select "BD Rating Level", then press [ENTER].

2) Use [**▲** / **▼**] to select your desired option, then press [ENTER].

"All": To release the limitation.

"Age Setting": To set the age limitation.

- After selecting "Age Setting", use [the Number buttons] to enter the age from 0 – 254. (e.g. for age 15, press [0], [1], [5])

3) Press [SETUP] to exit.

B) DVD Rating Level

1) Use [**▲** / **▼**] to select "DVD Rating Level", then press [ENTER].

2) Use [**▲** / **▼**] to select your desired level, then press [ENTER].

3) Press [SETUP] to exit.

RATING EXPLANATIONS

- All : Parental control is inactive; all discs can be played back.
- 8 [Adult] : DVD software of any grades (adult/general/children) can be played back.
- 7 [NC-17] : No one under 17 admitted.
- 6 [R] : Restricted; under 17 requires accompanying parent or adult guardian.
- 5 [PGR] : Parental guidance recommended.
- 4 [PG-13] : Unsuitable for children under 13.
- 3 [PG] : Parental guidance suggested.
- 2 [G] : General audience.
- 1 [Kid Safe] : Suitable for children.

C) Password Change

1) Use [**▲** / **▼**] to select "Password Change", then press [ENTER].

2) Enter a new 4-digit password, then press [ENTER].

3) Press [SETUP] to exit.

Note

- The resume information will be cleared if you change the parental level when the resume information is on.

Others



• For how to select the setting items and options, refer to “Custom” on page 34.

Setting items	Options				
Angle Icon	On*: The angle icon appears on the TV screen when playing back the scene with various angle.				
	Off: The angle icon disappears on the TV screen.				
Auto Power Off	On*: If this unit is left with no activity for more than 30 minutes, this unit turns into the standby mode automatically.				
	Off: Sets off the auto power off.				
Panel Display Sets the brightness of the front panel display.	Auto*: Front panel display gets darker during playback.				
	Bright: Front panel display gets brighter.				
	Dimmer: Front panel display gets darker.				
HDMI CEC Sets whether to utilize HDMI CEC function.	On*				
	Off				
Media Select  Selects the media to playback. Setting will be back to “Disc” when you turn the unit to the standby mode.	Disc*: Select this when you play back a disc.				
	SD Card: Select this when you play back an SD Memory Card.				
Network Connection	Connection Test			Perform the network connection test. After you change the IP address or DNS setting, always perform this test.	
	Enable(Easy)*			If you select “Enable(Easy)”, Connection test will automatically start.	
	Enable (Custom)	IP Address Setting	Auto(DHCP)*		Set the IP address. In most cases, you can connect to the Internet without making any changes to the default setting.
			Manual	IP Address	
Subnet Mask					
DNS Setting	Manual	Auto(DHCP)*		Set the DNS setting. In most cases, you can connect to the Internet without making any changes to the default setting.	
		Primary DNS	Secondary DNS		

FUNCTION SETUP

Setting items	Options				
Network Connection	Enable (Custom)	Proxy Setting	Do Not Use*		Set the proxy server. In most cases, you can connect to the Internet without using proxy server.
			Use	Proxy Address	
				Proxy Port	
	Connection Speed	Auto*		Set the connection speed. In most cases, you can connect to the Internet without making any changes to the default setting.	
		10BASE Half			
		10BASE Full			
100BASE Half					
100BASE Full					
BD-Live Setting	Allow*		You can restrict Internet access Limited Allow when BD-Live functions are used.		
	Limited Allow				
	Prohibit				
Disable		Deactivate the network connection.			
Software Upgrade Allows you to upgrade this unit's firmware. Refer to page 48.	Current Version : Indicates the current firmware version.				
	Disc Upgrade : Allows you upgrade this unit's firmware using a disc.				
	Network Upgrade : You can upgrade the firmware version by connecting this unit to the Internet.				

) Settings with () are the default.

- HDMI CEC allows integrated system control over HDMI and is part of the HDMI standard. In addition to Onkyo AV components, it allows interoperability with CEC-compatible AV components and TVs made by other manufacturers.
- When "HDMI CEC" setting is set to "On", functions listed below will be available.

Direct Change

When this unit is turned on, the TV also is turned on and the appropriate external input channel will be selected automatically. The appropriate external input channel can also be selected on your TV automatically when you press **[PLAY ►]** when the unit's power is on.

Standby

When you press and hold **[I / ON / STANDBY]** on the front panel for 2 seconds, it turns off the power of the TV first and then turns off the power of this unit also.

System Information

Get & Set Menu Language

- The unit recognizes the OSD language set for the TV and automatically sets the same language as the player menu language (OSD menu language) for this unit.
- This feature is available only when "Auto(XXXX)" is selected in "Player Menu" in the setup menu. (Refer to "Player Menu" on page 35.)

Note

- HDMI CEC is available only when the display device is connected by an HDMI cable, and when it supports HDMI CEC feature.

Network Connection

Set up the network connection settings in order to use the BD-Live function with a BD-Live disc.

Connection Test

After you made IP address/DNS settings or when a LAN cable is connected, always perform the connection test to check if the connection is correctly made.

- 1** In stop mode, press [SETUP].
- 2** Use [▲ / ▼] to select , then press [ENTER].
- 3** Use [▲ / ▼] to select "Others", then press [ENTER].
- 4** Use [▲ / ▼] to select "Network Connection", then press [ENTER].
- 5** Use [▲ / ▼] to select "Connection Test", then press [ENTER].

Connection test will start automatically and the test result will appear right after the connection test finishes.

- "Testing..." : The test is in progress.
- "Pass" : Connection test is successfully completed.
- "Fail" : Connection test failed. Check the connection settings.

Press [ENTER] to go to the list of network status confirmation screen.

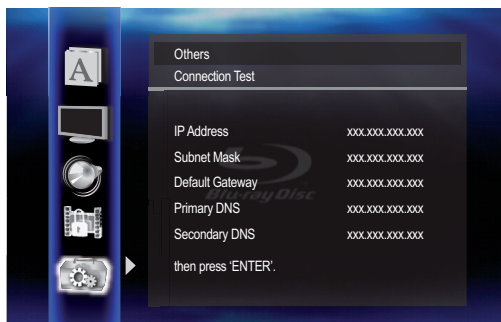

- 6** Press [ENTER] to go back to the previous screen, or press [SETUP] to exit.

Note

- If the connection test passes, you can enjoy the BD-Live functions using the Internet without making any extra settings.
- If the connection test fails, you may need to change the MAC address settings of your router.
- "Connection Test" is not available when "Disable" is selected in "Network Connection".

Enable(Easy)

Network settings are set to the following settings initially. (In most cases, you can connect to the Internet without making any changes to the default settings.)

- IP Address Setting	Auto(DHCP)
- DNS Setting	Auto(DHCP)
- Proxy Setting	Do Not Use
- Connection Speed	Auto
- BD-Live Setting	Allow

If you want to set the network settings back to the default settings as above (except "BD-Live Setting"), follow the procedure below.

- 1** Follow steps 1 to 4 in "Connection Test" on this page.
- 2** Use [▲ / ▼] to select "Enable(Easy)", then press [ENTER].
 - The unit will start the connection test automatically and the test result will appear right after the test finishes.
 - After the connection test finishes, press [ENTER] to go to network status confirmation screen.
- 3** Press [ENTER] to activate the network settings and set the network connection automatically. Press [SETUP] to exit.

Note

- The setting of "BD-Live Setting" will not be set back to the default, even if you follow the procedure.

Enable(Custom)

In following cases, select "Enable(Custom)" to set each setting as necessary.

- When connection test failed with the setting of "Enable(Easy)".
- When instructed by your Internet service provider to make specific settings in accordance with your network environment.

• IP Address Setting / DNS Setting

- 1** Follow steps 1 to 4 in "Connection Test" on this page.
- 2** Use [▲ / ▼] to select "Enable(Custom)", then press [ENTER].
- 3** Use [▲ / ▼] to select "IP Address Setting", then press [ENTER] repeatedly to select the desired setting.

"Auto(DHCP)":	If your router has DHCP server function, select "Auto(DHCP)".
"Manual":	If your router does not have DHCP server function, select "Manual".

If you select "Manual", follow the following instruction to set the IP address and DNS.

- 3-a) Use **[▲ / ▼]** to select "IP Address", "Subnet Mask" or "Default Gateway", then press **[ENTER]**. IP address setting screen will appear. Enter IP address, subnet mask and default gateway with cursor buttons and number buttons.

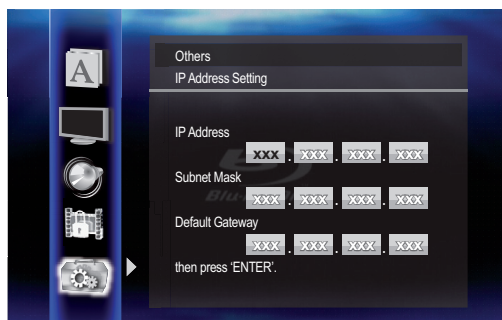

- Enter the IP address number after checking the specifications of your router.
- If the IP address number is unknown, check the IP address number of other devices. (e.g. PC connected via LAN cable) and assign a different number from those of other devices.

- 3-b) After you enter all correctly, press **[ENTER]**.
- Confirmation message will appear. Select "Yes" to complete the settings.

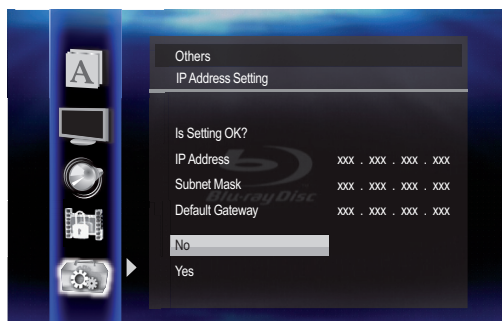

- 3-c) Use **[▲ / ▼]** to select "Primary DNS" or "Secondary DNS", then press **[ENTER]**. DNS setting screen will appear. Enter primary DNS and secondary DNS with cursor buttons and number buttons.

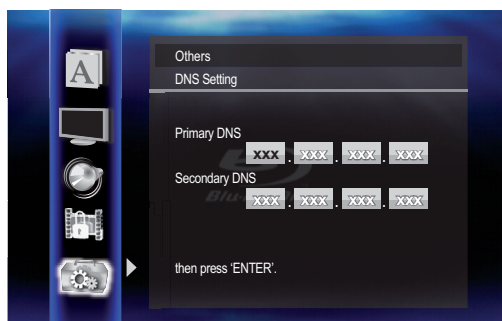

- Enter the numbers instructed by your Internet provider.
- If the number is unknown, check the number of other devices (e.g. PC connected via LAN cable) and assign the same number.

- 3-d) After you enter all correctly, press **[ENTER]**.
- Confirmation message will appear. Select "Yes" to complete the settings.

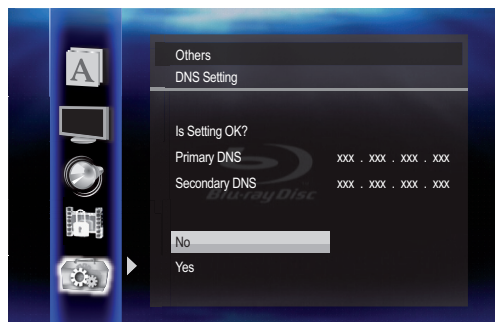

- 4 Press [RETURN] to go back to the previous screen, or press [SETUP] to exit.**

Note

- The range of input number is between 0 and 255.
- If you enter a number larger than 255, the number will automatically be 255.
- The manually entered number will be saved even if you change the setting to "Auto(DHCP)".
- When you enter a wrong number, press **[CLEAR]** to cancel. (the number will be back to "0".)
- If you want to enter 1 or 2 digit number in one cell, press **[▶]** to move on to the next cell.
- If the entered IP address or the default gateway or primary DNS number is same as the default setting, IP address setting will be set to "Auto(DHCP)". (The manually entered number will be saved.)
- When IP address setting is set to "Manual", the setting of DNS setting will automatically be "Manual" and when IP address setting is set to "Auto(DHCP)", you can set either "Auto(DHCP)" or "Manual" for DNS setting.

• Proxy Setting

- 1 Follow steps 1 to 4 in "Connection Test" on page 45.**
- 2 Use [▲ / ▼] to select "Enable(Custom)", then press [ENTER].**
- 3 Use [▲ / ▼] to select "Proxy Setting", then press [ENTER] repeatedly to select the desired setting.**
 - For default settings, select "Do Not Use".
 - If you need to change the proxy setting as instructed by your Internet service provider to set the designated proxy address and port, select "Use".

If you select "Use", follow the following instructions to set the proxy address and proxy port.

- 3-a) Use [▲ / ▼] to select "Proxy Address", then press [ENTER]. Proxy address setting screen will appear.
 Enter proxy address.
- The keyboard screen will appear.



[▲ / ▼ / ◀ / ▶]: Move the highlight.
 [the Number buttons]: Enter number.
 [ENTER]: Enter the highlighted number/word.
 [A]: Clear the entered number or word.
 [B]: Clear all the entered numbers or words.
 [C]: Switch between abc ? ABC ? @!?
 [D]: Set the entered number or word.

- 3-b) After you enter proxy address correctly, press [D].
- Confirmation message will appear. Select "Yes" to complete the settings.

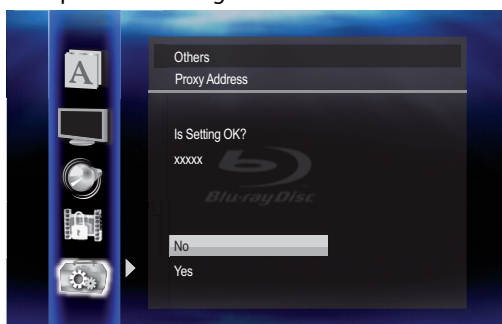

- 3-c) Use [▲ / ▼] to select "Proxy Port", then press [ENTER]. Proxy port setting screen will appear.
 Enter proxy port number with number buttons.



- 3-d) After you enter proxy port correctly, press [ENTER].

- 4 Press [RETURN] to go back to the previous screen, or press [SETUP] to exit.**

Note

- The range of input number for the port number is between 0 and 65535. (If you enter a number larger than 65535, it will be regarded as 65535.)
- For proxy port, the selected ports may be blocked and not be able to use depending on your network environment.

• Connection Speed

You can set connection speed as your preference. (The default setting is "Auto".)

- 1 Follow steps 1 to 4 in "Connection Test" on page 45.**
- 2 Use [▲ / ▼] to select "Enable(Custom)", then press [ENTER].**
- 3 Use [▲ / ▼] to select "Connection Speed", then press [ENTER].**
- 4 Use [▲ / ▼] to select the desired setting, then press [ENTER].**

"Auto":

Set the appropriate connection speed automatically, in accordance with your network environment.

"10BASE Half":

Set the connection speed to "10BASE Half".

"10BASE Full":

Set the connection speed to "10BASE Full".

"100BASE Half":

Set the connection speed to "100BASE Half".

"100BASE Full":

Set the connection speed to "100BASE Full".

- 5 Press [RETURN] to go back to the previous screen, or press [SETUP] to exit.**

Note

- Choose a connection speed in accordance with your network environment.
- The network connection may be disabled depending on the device, when the settings are changed.

• BD-Live Setting

You can limit the Internet access from the BD-Live functions. (The default setting is "Allow".)

- 1 Follow steps 1 to 4 in "Connection Test" on page 45.**
- 2 Use [▲ / ▼] to select "Enable(Custom)", then press [ENTER].**
- 3 Use [▲ / ▼] to select "BD-Live Setting", then press [ENTER].**
- 4 Use [▲ / ▼] to select the desired setting, then press [ENTER].**

"Allow":

Internet access is permitted from all BD-Live contents.

"Limited Allow":

Internet access is permitted only for BD-Live contents which have content owner certificates. Internet access without the certificates are prohibited.

"Prohibit":

Internet access is prohibited from all BD-Live contents.

- 5 Press [RETURN] to go back to the previous screen, or press [SETUP] to exit.

Disable

Deactivate all the network connection and settings.

- 1 Follow steps 1 to 4 in "Connection Test" on page 45.
- 2 Use [▲ / ▼] to select "Disable", then press [ENTER].
- 3 Press [RETURN] to go back to the previous screen, or press [SETUP] to exit.

Note

- The network connection can be reactivated by setting the network connection to "Enable(Easy)" or "Enable(Custom)".

Software Upgrade

Current Version

You can confirm the current software version.

- 1 Follow steps 1 to 3 in "Connection Test" on page 45.
- 2 Use [▲ / ▼] to select "Software Upgrade", then press [ENTER].
- 3 Use [▲ / ▼] to select "Current Version", then press [ENTER].



- 4 Press [ENTER] or [RETURN] to exit.

Note

- Please visit www.onkyo.com to download the latest firmware version.

Disc Upgrade

You can upgrade the software by using disc.

- 1 Follow steps 1 to 3 in "Connection Test" on page 45.
- 2 Use [▲ / ▼] to select "Software Upgrade", then press [ENTER].
- 3 Use [▲ / ▼] to select "Disc Upgrade", then press [ENTER].
- 4 Use [▲ / ▼] to select "Yes", then press [ENTER].

- 5 Disc tray will open automatically.

- Insert the disc for software upgrade and then press [OPEN/CLOSE ▲].

- 6 After completing loading disc, confirmation message will appear. Select "Yes" and press [ENTER] to start upgrading.

- It may take a while to complete the upgrading. (Please wait until "100%" appears on the front panel display.)

- 7 After the disc upgrade finishes, this unit will restart and eject the disc.

Note

- Please do not unplug the AC power code while executing the "Disc Upgrade".
- All settings will remain the same even if you upgrade the firmware version.

Network Upgrade

You can upgrade the software by connecting the unit to the Internet.

- 1 Follow steps 1 to 3 in "Connection Test" on page 45.
- 2 Use [▲ / ▼] to select "Software Upgrade", then press [ENTER].
- 3 Use [▲ / ▼] to select "Network Upgrade", then press [ENTER].
- 4 Use [▲ / ▼] to select "Yes", then press [ENTER].
 - This unit will then start checking for the latest firmware version.
- 5 Confirmation message will appear. Use [▲ / ▼] to select "Yes", then press [ENTER].
 - The unit will start downloading the latest firmware version.
- 6 When the download completes, confirmation message will appear. Press [ENTER].
 - The unit will start upgrading the firmware version.
 - It may take a while to complete the upgrading. (Please wait until "100%" appears on the front panel display.)
- 7 After upgrading finishes, this unit will restart and open the disc tray automatically.

Note

- Please do not unplug the AC power code or LAN cable while executing the "Network Upgrade".
- All settings will remain the same even if you upgrade the software version.
- The disc tray will open automatically after upgrading finishes. This is not a malfunction.

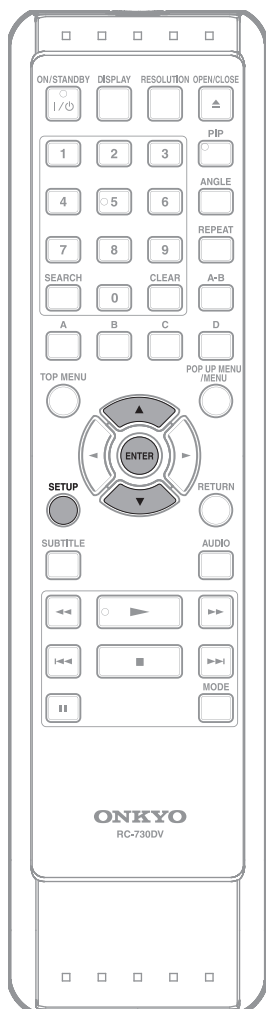

Initialize

Initialize the setting or SD Memory Card.

1 In stop mode, press [SETUP].

2 Use [▲ / ▼] to select , then press [ENTER].

3 Use [▲ / ▼] to select a desired option, then press [ENTER].

“Setup”: Resets the setup menu to the default.

The setting for “Parental”, “Network Connection” and “Media Select” will not be reset.

“Format SD Card” (Available only when an SD Memory Card is inserted.):

Initializes the SD Memory Card.

“Erase Saved BD-ROM Data (Player)”:

Clears the data saved for the BD-ROM contents, such as BD-ROM game scores, from this player.

“Erase Saved BD-ROM Data (SD Card)” (Available only when an SD Memory Card is inserted.):

Clears the supplemental data for the BD-ROM playback, such as subtitle data, from the SD Memory Card.

“Network Settings”:

Resets the Network Settings menu to the default.

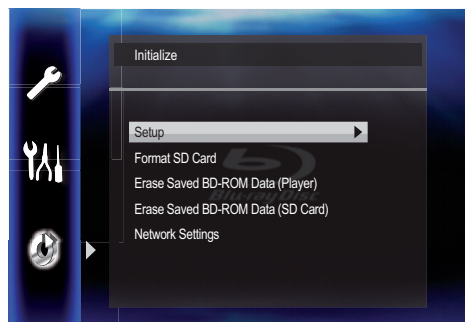

4 Confirmation message will appear. Use [▲ / ▼] to select “Yes”, then press [ENTER].

5 Press [SETUP] to exit.

Caution

- Do not remove the SD Memory Card while executing the “Format SD Card” or the “Erase Saved BD-ROM Data (SD Card)”. It damages the card.

TROUBLESHOOTING

If the unit does not perform properly when operated as instructed in this manual, check the unit, consulting the following checklist.

Problem	Solution
No power	<ul style="list-style-type: none"> - Check if the AC cord is properly connected. - Unplug the AC cord once, and wait for 5-10 seconds and then plug it in again.
No sound or picture	<ul style="list-style-type: none"> - Check if the connected TV is turned on. - Check if the connections are made securely and correctly. - Check whether the connected TV or other device supports HDCP. (This unit will not output a video signal unless the other device supports HDCP.) - Check whether the output format of this unit (HDMI FORMAT) matches the supported input format of other connected device. - When this unit is connected to the DVI jack on your TV or AV receiver, you cannot hear any sound from the HDMI OUT if your TV or AV receiver only supports DVI.
Distorted picture	<ul style="list-style-type: none"> - Sometimes a small amount of picture distortion may appear. This is not a malfunction. - Connect this unit directly to the TV. If the RCA audio / video cables are connected to a VCR, pictures may be distorted due to the copy right protection system.
Completely distorted picture or black / white picture with BD / DVD	<ul style="list-style-type: none"> - Make sure the disc is compatible with this unit.
No sound or distorted sound	<ul style="list-style-type: none"> - Adjust the volume. - Check that the speakers are connected correctly. - Check the HDMI connections. - Check the settings in "Audio" menu.
Picture freezes momentarily during playback	<ul style="list-style-type: none"> - Check the disc for fingerprints / scratches and clean with a soft cloth wiping from center to edge. - Clean the disc.
Disc cannot be played back	<ul style="list-style-type: none"> - Clean the disc. - Ensure the disc label is facing up. - Check if the disc is defective by trying another disc. - Cancel the ratings control or change the control level. - Insert a correct disc that can be played back on this unit.
SD Memory Card cannot be read.	<ul style="list-style-type: none"> - The format of the card does not match to this unit or the card is not compatible.
No return to start-up screen when disc is removed	<ul style="list-style-type: none"> - Reset this unit by turning it off, then on again.
The unit does not respond to the remote control	<ul style="list-style-type: none"> - Aim the remote control directly at infrared sensor window on the front panel. - Reduce the distance to infrared sensor window. - Replace the batteries in the remote control. - Re-insert the batteries with their polarities (+ / - signs) as indicated. - Check if a strong light source is not interfering with this unit's infrared sensor. Make sure that the unit is not subjected to direct sunshine or inverter-type fluorescent lights. Relocate if necessary. - If the BD player is installed in a cabinet with colored glass doors, the remote control may not work reliably when the doors are closed. Open the doors, or use a cabinet without colored glass.
Buttons do not work or the unit stops responding	<ul style="list-style-type: none"> - To completely reset the unit, unplug the AC cord from the AC outlet for 5-10 seconds.
The unit does not respond to some operating commands during playback	<ul style="list-style-type: none"> - Operations may not be permitted by the disc. Refer to the instructions of the disc.
The unit cannot read BD / DVD / CD	<ul style="list-style-type: none"> - Condensation? (Let sit 1 or 2 hours) - You are attempting to playback a disc other than one with one of the marks on page 19. - Wipe the dirt off the disc or replace the disc.
Angle does not switch	<ul style="list-style-type: none"> - The angle cannot be switched for BD / DVD which do not contain multiple angles. In some cases multiple angles are only recorded for specific scenes.
Playback does not start when the title is selected	<ul style="list-style-type: none"> - Check the settings in "Parental" menu.

TROUBLESHOOTING

Problem	Solution
The password for rating level has been forgotten	- Enter the default password "4737", then your forgotten password will be cleared.
Cannot connect the network	- Check if the LAN cable connection is properly made. - Turn on the modem or broadband router. - Check the network setting. - Check if the broadband router and/or modem is correctly connected. - Check the "BD-Live Setting".
Cannot connect to the network while my PC is connected to the network	- Check the content of your Internet service contract to see if your Internet service provider prevents multiple terminals connecting at the same time.
Cannot use the BD-Live function	- Use an SD card with enough space.
The playback of BD-video or download of data does not perform properly.	- Check if an SD Card is correctly inserted. Do not remove the card during playback as some BD-videos require an SD Card during playback.
"HDCP NOK" appears on the front panel display	"HDCP NOK" appears under the following conditions: - When the connected device does not support HDCP. - When the connected device is recognized as an HDCP incompatible by HDMI SRM. - When the connected device supports HDCP but cannot be recognized as an HDCP compatible for some reason.

The BD player contains a microcomputer for signal processing and control functions. In very rare situations, severe interference, noise from an external source, or static electricity may cause it to lockup. In the unlikely event that this happens, unplug the power cord from the wall outlet, wait at least 5 seconds, and then plug it back in again.

Note

- Some functions are not available in specific modes, but this is not a malfunction. Read the description in this manual for details on correct operations.
- Some functions are prohibited on some discs.

Analog Audio

An electrical signal that directly represents sound. Compare this to digital audio which can be an electrical signal, but is an indirect representation of sound. See also "Digital Audio".

Aspect Ratio

The width of a TV screen relative to its height. conventional TVs are 4:3 (in other words, the TV screen is almost square); widescreen models are 16:9 (the TV screen is almost twice as wide as it is high).

AVCHD

AVCHD is a new format for high definition video camcorders which can record and play high-resolution HD images.

BD-Java

With some BD which support Java applications, you can enjoy the interactive functions such as games or interactive menus.

BD-Live

BD-Live is a BD-video (BD-ROM version 2 Profile 2.0/ Profile 1.1) which contains new functions (e.g. Internet connection), in addition to the BONUSVIEW function.

Blu-ray Disc (BD)

Blu-ray Disc is a next generation optical video disc which is capable of storing much more data than a conventional DVD. The large capacity makes it possible to benefit from the features such as high-definition videos, multi-channel surround sounds, interactive menus and so on.

Chapter

Just as a book is split up into several chapters, a title on a BD-video or DVD-video is usually divided into chapters. See also "Title".

Component Video Output

Each signal of luminance (Y) and component (P_B/C_B, P_R/C_R) is independent to output so that you can experience picture color as it is.

Also, due to compatibility with progressive video (525p/480p), you can experience higher-density picture than that in interlace (525i/480i).

Digital Audio

An indirect representation of sound by numbers. During recording, the sound is measured at discrete intervals (44,100 times a second for CD audio) by an analog-to-digital converter, generating a stream of numbers. On playback, a digital-to-analog converter generates an analog signal based on these numbers. See also "Sampling Frequency" and "Analog Audio".

DNS Server

A server which translates Internet domain names into IP addresses.

Dolby Digital

The system to compress digital sound developed by Dolby Laboratories. It offers you sound of stereo (2ch) or multi-channel audio.

Dolby Digital Plus

Dolby Digital Plus is the next generation digital audio compression technology developed as an extension to Dolby Digital. Blu-ray Disc supports 7.1 multi-channel surround sound output.

Dolby TrueHD

Dolby TrueHD is a lossless coding technology developed for next generation optical discs. Blu-ray Disc supports 7.1 multi-channel surround sound output.

DTS (Digital Theater System)

DTS is a multi-channel surround sound system. You can enjoy movie dynamic and realistic sound like movie theater. DTS surround sound technologies were developed by DTS, Inc.

DTS-HD

DTS-HD is a lossless coding technology developed as an extension of the original DTS Coherent Acoustics format. Blu-ray Disc supports 7.1 multi-channel surround sound output.

Gateway

IP address of the electronic devices (such as router) which provide Internet access.

HDMI (high-definition multimedia interface)

A digital interface between audio and video source. It can transmit component video, audio, and control signal with one cable connection.

Hub

A device used for connecting multiple device to the network.

IP Address

A set of numbers which are assigned to devices participating in a computer network.

LAN (Local Area Network)

A group of computer networks covering a small area like a company, school or home.

Local Storage

A storage area of sub contents for playing virtual packages on BD-video.

MP3 (MPEG audio layer 3)

MP3 is a method of compressing files. You can copy MP3 files on BD, DVD, CD-RW/-R or SD Memory Card from the computer and play back the files on this unit.

PCM (Pulse Code Modulation)

The most common system of encoding digital audio, found on CD and DAT. Excellent quality, but requires a lot of data compared to formats such as Dolby Digital and MPEG audio. For compatibility with digital audio recorders (CD, MD and DAT) and AV receivers with digital inputs, this unit can convert Dolby Digital and MPEG audio to PCM. See also "Digital Audio".

Proxy Server

Proxy server is a server which acts as an intermediary between a workstation user and the Internet to ensure security.

Region Code

Regions associate discs and players with particular areas of the world. This unit will only play back discs that have compatible region codes. You can find the region code of your unit by looking on the rear panel. Some discs are compatible with more than one region (or all regions).

Router

A networking device which distinguishes the IP address assigned to each device and routing and forwarding information in the computer network.

Sampling Frequency

The rate which sound is measured by a specified interval to turn into digital audio data. The numbers of sampling in one second defines as sampling frequency. The higher the rate, the better the sound quality.

Subnet Mask

A mask which is used to determine what subnet an IP address belongs to.

Title

A collection of chapters on BD-video or DVD-video. See also "Chapter".

Track

Audio CD use tracks to divide up the content of a disc. The BD-video or DVD-video equivalent is called a chapter. See also "Chapter".

Virtual Package

The function which copies data to other media (local storage) from the Internet and play the secondary video, secondary audio and the subtitle at the same time. The method of the playback varies depending on discs.

x.v.Color

"x.v.Color" is a promotion name given to the products that have the capability to realize a wide color space based on the xvYCC specifications and is a trademark of Sony Corporation.

LANGUAGE CODE

Language	Code	Language	Code	Language	Code	Language	Code
A-B		French [FRE]	5264	Macedonian	5957	Siswat	6565
Abkhazian	4748	Frisian	5271	Malagasy	5953	Slovak [SLO]	6557
Afar	4747	Galician	5358	Malay	5965	Slovenian	6558
Afrikaans	4752	Georgian	5747	Malayalam	5958	Somali	6561
Albanian	6563	German [GER]	5051	Maltese	5966	Spanish [SPA]	5165
Amharic	4759	Greek [GRE]	5158	Maori	5955	Sundanese	6567
Arabic	4764	Greenlandic	5758	Marathi	5964	Swahili	6569
Armenian	5471	Guarani	5360	Moldavian	5961	Swedish [SWE]	6568
Assamese	4765	Gujarati	5367	Mongolian	5960	T	
Aymara	4771	Hausa	5447	Nauru	6047	Tagalog	6658
Azerbaijani	4772	Hebrew	5569	Nepali	6051	Tajik	6653
Bashkir	4847	Hindi	5455	Norwegian [NOR]	6061	Tamil	6647
Basque	5167	Hungarian [HUN]	5467	O-R		Tatar	6666
Bengali;Bangla	4860	I-K		Occitan	6149	Telugu	6651
Bhutani	5072	Icelandic [ICE]	5565	Oriya	6164	Thai	6654
Bihari	4854	Indonesian	5560	Oromo(Afan)	6159	Tibetan	4861
Bislama	4855	Interlingua	5547	Panjabi	6247	Tigrinya	6655
Breton	4864	Interlingue	5551	Pashto;Pushto	6265	Tonga	6661
Bulgarian [BUL]	4853	Inupiak	5557	Persian	5247	Tsonga	6665
Burmese	5971	Irish [IRI]	5347	Polish [POL]	6258	Turkish [TUR]	6664
Byelorussian	4851	Italian [ITA]	5566	Portuguese [POR]	6266	Turkmen	6657
C-E		Japanese [JPN]	5647	Quechua	6367	Twi	6669
Cambodian	5759	Javanese	5669	Rhaeto-Romance	6459	U-Z	
Catalan	4947	Kannada	5760	Romanian [RUM]	6461	Ukrainian	6757
Chinese [CHI]	7254	Kashmiri	5765	Russian [RUS]	6467	Urdu	6764
Corsican	4961	Kazakh	5757	S		Uzbek	6772
Croatian	5464	Kinyarwanda	6469	Samoaan	6559	Vietnamese	6855
Czech [CZE]	4965	Kirghiz	5771	Sangho	6553	Volapuk	6861
Danish [DAN]	5047	Kirundi	6460	Sanskrit	6547	Welsh	4971
Dutch [DUT]	6058	Korean [KOR]	5761	Scots Gaelic	5350	Wolof	6961
English [ENG]	5160	Kurdish	5767	Serbian	6564	Xhosa	7054
Esperanto	5161	L-N		Serbo-Croatian	6554	Yiddish	5655
Estonian	5166	Laothian	5861	Sesotho	6566	Yoruba	7161
F-H		Latin	5847	Setswana	6660	Zulu	7267
Faroese	5261	Latvian;Lettish	5868	Shona	6560		
Fiji	5256	Lingala	5860	Sindhi	6550		
Finnish [FIN]	5255	Lithuanian	5866	Singhalese	6555		

Note

- If you choose a language that has a 3-letter-language code (written in bracket), the code will be displayed every time you change the audio or subtitle language setting on page 31. If you choose any other languages, '----' will be displayed instead.

SPECIFICATIONS

General

Signal system	NTSC color
Power requirements	120V AC, 60Hz
Power consumption	22W (standby: 0.7W)
Dimensions (width x height x depth)	17 ^{-1/8} x 2 ^{-3/4} x 12 ^{-3/16} inches (435 x 69.3 x 310mm)
Weight	6.6 lbs (3.0kg)
Operating temperature	41°F (5°C) to 104°F (40°C)
Operating humidity	Less than 80% (no condensation)

Terminals

Rear	Audio output (Analog)	
	RCA jack x 2	L/R: 2Vrms (output impedance: more than 1kΩ)
	Video output	
	RCA jack x 1	1Vp-p (75Ω)
	Component video output	
	RCA jack x 3	Y: 1Vp-p (75Ω) PB: 700mVp-p (75Ω) PR: 700mVp-p (75Ω)
	Audio output (Digital)	
	RCA jack x 1	500mVp-p (75Ω)
	Optical jack x 1	Digital connector
	HDMI output	
HDMI jack x 1	Video: 480p, 720p, 1080i, 1080p, 1080p24 / Audio	
ETHERNET terminal	10BASE-T/100BASE-TX	

Note

- The specifications and design of this product are subject to change without notice.

ONKYO CORPORATION

Sales & Product Planning Div. : 2-1, Nisshin-cho, Neyagawa-shi, OSAKA 572-8540, JAPAN
Tel: 072-831-8023 Fax: 072-831-8163

ONKYO U.S.A. CORPORATION

18 Park Way, Upper Saddle River, N.J. 07458, U.S.A.
Tel: 201-785-2600 Fax: 201-785-2650 <http://www.us.onkyo.com/>

ONKYO EUROPE ELECTRONICS GmbH

Liegnitzerstrasse 6, 82194 Groebenzell, GERMANY
Tel: +49-8142-4401-0 Fax: +49-8142-4401-555 <http://www.eu.onkyo.com/>

ONKYO EUROPE UK Office

Suite 1, Gregories Court, Gregories Road, Beaconsfield, Buckinghamshire, HP9 1HQ
UNITED KINGDOM Tel: +44-(0)1494-681515 Fax: +44(0)-1494-680452

ONKYO CHINA LIMITED

Unit 1&12, 9/F, Ever Gain Plaza Tower 1, 88, Container Port Road, Kwai Chung,
N.T., HONG KONG Tel: 852-2429-3118 Fax: 852-2428-9039
<http://www.ch.onkyo.com/>



Free Manuals Download Website

<http://myh66.com>

<http://usermanuals.us>

<http://www.somanuals.com>

<http://www.4manuals.cc>

<http://www.manual-lib.com>

<http://www.404manual.com>

<http://www.luxmanual.com>

<http://aubethermostatmanual.com>

Golf course search by state

<http://golfingnear.com>

Email search by domain

<http://emailbydomain.com>

Auto manuals search

<http://auto.somanuals.com>

TV manuals search

<http://tv.somanuals.com>