

ONKYO®

DVD Changer

DV-C503

Instruction Manual

Thank you for purchasing the Onkyo DVD Changer. Please read this manual thoroughly before making connections and turning on the power. Following the instructions in this manual will enable you to obtain optimum performance and listening enjoyment from your new DVD Changer. Please retain this manual for future reference.

Contents

Before Using Your DVD Changer 2

Getting Started 6

Facilities and Connections 10

Basic Operation 17

Advanced Operation 20

Function Setup 30

Others 37



WARNING:

TO REDUCE THE RISK OF FIRE OR ELECTRIC SHOCK, DO NOT EXPOSE THIS APPLIANCE TO RAIN OR MOISTURE.

CAUTION:

TO REDUCE THE RISK OF ELECTRIC SHOCK, DO NOT REMOVE COVER (OR BACK). NO USER-SERVICEABLE PARTS INSIDE. REFER SERVICING TO QUALIFIED SERVICE PERSONNEL.



WARNING
RISK OF ELECTRIC SHOCK
DO NOT OPEN

AVIS
RISQUE DE CHOC ELECTRIQUE
NE PAS OUVRIR



The lightning flash with arrowhead symbol, within an equilateral triangle, is intended to alert the user to the presence of uninsulated "dangerous voltage" within the product's enclosure that may be of sufficient magnitude to constitute a risk of electric shock to persons.



The exclamation point within an equilateral triangle is intended to alert the user to the presence of important operating and maintenance (servicing) instructions in the literature accompanying the appliance.

Important Safeguards

- 1. Read Instructions** – All the safety and operating instructions should be read before the appliance is operated.
- 2. Retain Instructions** – The safety and operating instructions should be retained for future reference.
- 3. Heed Warnings** – All warnings on the appliance and in the operating instructions should be adhered to.
- 4. Follow Instructions** – All operating and use instructions should be followed.
- 5. Cleaning** – Unplug the appliance from the wall outlet before cleaning. The appliance should be cleaned only as recommended by the manufacturer.
- 6. Attachments** – Do not use attachments not recommended by the appliance manufacturer as they may cause hazards.
- 7. Water and Moisture** – Do not use the appliance near water – for example, near a bath tub, wash bowl, kitchen sink, or laundry tub; in a wet basement; or near a swimming pool; and the like.
- 8. Accessories** – Do not place the appliance on an unstable cart, stand, tripod, bracket, or table. The appliance may fall, causing serious injury to a child or adult, and serious damage to the appliance. Use only with a cart, stand, tripod, bracket, or table recommended by the manufacturer, or sold with the appliance. Any mounting of the appliance should follow the manufacturer's instructions, and should use a mounting accessory recommended by the manufacturer.
- 9. An appliance and cart combination should be moved with care. Quick stops, excessive force, and uneven surfaces may cause the appliance and cart combination to overturn.**
- 10. Ventilation** – Slots and openings in the cabinet are provided for ventilation and to ensure reliable operation of the appliance and to protect it from overheating, and these openings must not be blocked or covered. The openings should never be blocked by placing the appliance on a bed, sofa, rug, or other similar surface. The appliance should not be placed in a built-in installation such as a bookcase or rack unless proper ventilation is provided. There should be free space of at least 5 cm (2 in.) and an opening behind the appliance.
- 11. Power Sources** – The appliance should be operated only from the type of power source indicated on the marking label. If you are not sure of the type of power supply to your home, consult your appliance dealer or local power company.
- 12. Grounding or Polarization** – The appliance may be equipped with a polarized alternating current line plug (a plug having one blade wider than the other). This plug will fit into the power outlet only one way. This is a safety feature. If you are unable to insert the plug fully into the outlet, try reversing the plug. If the plug should still fail to fit, contact your electrician to replace your obsolete outlet. Do not defeat the safety purpose of the polarized plug.
- 13. Power-Cord Protection** – Power-supply cords should be routed so that they are not likely to be walked on or pinched by items placed upon or against them, paying particular attention to cords at plugs, convenience receptacles, and the point where they exit from the appliance.
- 14. Lightning** – For added protection for the appliance during a lightning storm, or when it is left unattended and unused for long periods of time, unplug it from the wall outlet and disconnect the antenna or cable system. This will prevent damage to the appliance due to lightning and power-line surges.
- 15. Overloading** – Do not overload wall outlets, extension cords, or integral convenience receptacles as this can result in a risk of fire or electric shock.
- 16. Object and Liquid Entry** – Never push objects of any kind into the appliance through openings as they may touch dangerous voltage points or short-out parts that could result in a fire or electric shock. Never spill liquid of any kind on the appliance.
- 17. Servicing** – Do not attempt to service the appliance yourself as opening or removing covers may expose you to dangerous voltage or other hazards. Refer all servicing to qualified service personnel.
- 18. Damage Requiring Service** – Unplug the appliance from the wall outlet and refer servicing to qualified service personnel under the following conditions:
 - A.** When the power-supply cord or plug is damaged,
 - B.** If liquid has been spilled, or objects have fallen into the appliance,
 - C.** If the appliance has been exposed to rain or water,
 - D.** If the appliance does not operate normally by following the operating instructions. Adjust only those controls that are covered by the operating instructions as an improper adjustment of other controls may result in damage and will often require extensive work by a qualified technician to restore the appliance to its normal operation,
 - E.** If the appliance has been dropped or damaged in any way, and
 - F.** When the appliance exhibits a distinct change in performance – this indicates a need for service.
- 19. Replacement Parts** – When replacement parts are required, be sure the service technician has used replacement parts specified by the manufacturer or have the same characteristics as the original part. Unauthorized substitutions may result in fire, electric shock, or other hazards.
- 20. Safety Check** – Upon completion of any service or repairs to the appliance, ask the service technician to perform safety checks to determine that the appliance is in proper operation condition.
- 21. Wall or Ceiling Mounting** – The appliance should be mounted to a wall or ceiling only as recommended by the manufacturer.
- 22. Heat** – The appliance should be situated away from heat sources such as radiators, heat registers, stoves, or other appliances (including amplifiers) that produce heat.

PORTABLE CART WARNING



S3125A

Precautions

This unit contains a semiconductor laser system and is classified as a "CLASS 1 LASER PRODUCT". So, to use this model properly, read this Instruction Manual carefully. In case of any trouble, please contact the store where you purchased the unit. To prevent being exposed to the laser beam, do not try to open the enclosure.

CAUTION:

VISIBLE LASER RADIATION WHEN OPEN AND INTERLOCK FAILED OR DEFEATED. DO NOT STARE INTO BEAM.

CAUTION:

THIS PRODUCT UTILIZES A LASER. USE OF CONTROLS OR ADJUSTMENTS OR PERFORMANCE OF PROCEDURES OTHER THAN THOSE SPECIFIED HEREIN MAY RESULT IN HAZARDOUS RADIATION EXPOSURE.

**"CLASS 1 LASER
PRODUCT"**

1. This unit is a CLASS 1 LASER PRODUCT and employs a laser inside the cabinet.
2. To prevent the laser from being exposed, do not remove the cover. Refer servicing to qualified personnel.

The laser is covered by a housing which prevents exposure during operation or maintenance. However, this product is classified as a Laser Product by CDRH (Center for Devices and Radiological Health) which is a department of the Food and Drug Administration. According to their regulations 21 CFR section 1002.30, all manufactures who sell Laser Products must maintain records of written communications between the manufacturer, dealers and customers concerning radiation safety. If you have any complaints about instructions or explanations affecting the use of this product, please feel free to write to the address on the back page of this manual. When you write us, please include the model number and serial number of your unit.

In compliance with Federal Regulations, the certification, identification and the period of manufacture are indicated on the rear panel.

FCC INFORMATION FOR USER

CAUTION:

The user changes or modifications not expressly approved by the party responsible for compliance could void the user's authority to operate the equipment.

NOTE:

This equipment has been tested and found to comply with the limits for a Class B digital device, pursuant to Part 15 of the FCC Rules. These limits are designed to provide reasonable protection against harmful interference in a residential installation. This equipment generates, uses and can radiate radio frequency energy and, if not installed and used in accordance with the instructions, may cause harmful interference to radio communications. However, there is no guarantee that interference will not occur in a particular installation. If this equipment does cause harmful interference to radio or television reception, which can be determined by turning the equipment off and on, the user is encouraged to try to correct the interference by one or more of the following measures:

- Reorient or relocate the receiving antenna.
- Increase the separation between the equipment and receiver.
- Connect the equipment into an outlet on a circuit different from that to which the receiver is connected.
- Consult the dealer or an experienced radio/TV technician for help.

For Canadian model

This class B digital apparatus complies with Canadian ICES-003.

For models having a power cord with a polarized plug:

CAUTION: TO PREVENT ELECTRIC SHOCK, MATCH WIDE BLADE OF PLUG TO WIDE SLOT, FULLY INSERT.

Modèle pour les Canadien

Cet appareil numérique de la classe B est conforme à la norme NMB-003 du Canada.

Sur les modèles dont la fiche est polarisée:

ATTENTION: POUR ÉVITER LES CHOCS ÉLECTRIQUES, INTRODUIRE LA LAME LA PLUS LARGE DE LA FICHE DANS LA BORNE CORRESPONDANTE DE LA PRISE ET POUSSER JUSQU'AU FOND.

Precautions

1. Regional Restriction Codes (Region Number)

Regional restriction codes are built into DVD Changers and DVD-Video media for each sales region. If the regional code of the DVD Changer does not match one of the regional codes on the DVD-Video, playback is not possible.

The regional number can be found on the rear panel of the DVD Changer.

(e.g.  for Region 1)

2. About This Manual

This manual explains the basic procedures for operating the DVD Changer. Some DVD-Video discs do not support the full potential of the DVD technology. Your DVD Changer may therefore not respond to all operating commands. Refer to instruction notes on discs.

A “” mark may appear on the TV screen during operation. It means that the operation is not permitted by the DVD Changer or the disc.

3. Recording Copyright

Recording of copyrighted material for other than personal use is illegal without permission of the copyright holder.

4. Power

WARNING

BEFORE PLUGGING IN THE UNIT FOR THE FIRST TIME, READ THE FOLLOWING SECTION CAREFULLY.

The voltage of the available power supply differs according to country or region. Be sure that the power supply voltage of the area where the unit will be used meets the required voltage (e.g., AC 120 V, 60 Hz) written on the rear panel.

5. Do not touch the unit with wet hands

Do not handle the unit or power cord when your hands are wet or damp. If water or any other liquid enters the case, take the unit to an authorized service center for inspection.

6. Location of the unit

- Place the unit in a well-ventilated location. Take special care to provide plenty of ventilation on all sides of the unit especially when it is placed in an audio rack. If ventilation is blocked, the unit may overheat and malfunction.
- Do not expose the unit to direct sunlight or heating units as the unit's internal temperature may rise and shorten the life of the pickup.
- Avoid damp and dusty places and places directly affected by vibrations from the speakers. In particular, avoid placing the unit on or above one of the speakers.
- Be sure the unit is placed in a horizontal position. Never place it on its side or on a slanted surface as it may malfunction.
- When you place the unit near a TV, radio, or VCR, the playback picture may become poor and the sound may be distorted. In this case, place the unit away from the TV, radio, or VCR.

7. Care

From time to time you should wipe the front and rear panels and the cabinet with a soft cloth. For heavier dirt, dampen a soft cloth in a weak solution of mild detergent and water, wring it out dry, and wipe off the dirt. Following this, dry immediately with a clean cloth.

Do not use rough material, thinners, alcohol or other chemical solvents or cloths since these could damage the finish or remove the panel lettering.

8. Notes on Handling

- When shipping the unit, use the original shipping carton and packing materials. For maximum protection, repack the unit as it was originally packed at the factory.
- Do not use volatile liquids, such as insect spray, near the unit. Do not leave rubber or plastic products in contact with the unit for a long time. They will leave marks on the finish.
- The top and rear panels of the unit **may become warm after a long period of use. This is not a malfunction.**
- When the unit is not in use, be sure to remove the disc and turn off the power.
- If you do not use the unit for a long period, the unit may not function properly in the future. Turn on and use the unit occasionally.

9. To Obtain a Clear Picture

The unit is a high technology, precision device. If the optical pick-up lens and disc drive parts are dirty or worn down, the picture quality becomes poor. To obtain a clear picture, we recommend regular inspection and maintenance (cleaning or parts replacement) every 1,000 hours of use depending on the operating environment. For details, contact your nearest dealer.

10. Notes on Moisture Condensation

Moisture condensation damages the unit.

Please read the following carefully.

• What is moisture condensation?

Moisture condensation occurs, for example, when you pour a cold drink into a glass on a warm day. Drops of water form on the outside of the glass. In the same way, moisture may condense on the optical pick-up lens inside the unit, one of the most crucial internal parts of the unit.

• Moisture condensation occurs in the following cases.

- When you bring the unit directly from a cold place to a warm place.
- When you use the unit in a room where you just turned on the heater, or a place where the cold wind from the air conditioner directly hits the unit.
- In summer, when you use the unit in a hot and humid place just after you move the unit from an air conditioned room.
- When you use the unit in a humid place.

• Do not use the unit when moisture condensation may occur.

If you use the unit in such a situation, it may damage discs and internal parts. Remove the disc, connect the power cord of the unit to the wall outlet, turn on the unit, and leave it for two or three hours. After a few hours, the unit will have warmed up and evaporated any moisture. Keep the unit connected to the wall outlet and moisture condensation will seldom occur.

Table of Contents

Important Safeguards / Precautions / Table of Contents	2 - 5
--	-------

Getting Started

Notes on Discs	6
Playable Discs / The Structure of the Disc Content / About Video CDs / MP3 compatibility information / Handling Discs / Cleaning Discs / Storing Discs / Notes on Copyright	
Features/Supplied Accessories	8
Features / Supplied Accessories	
Preparing the Remote Controller	9
Inserting the Batteries / Using the Remote Controller	

Facilities and Connections

Control Position and Names	10
Front Panel / Rear Panel / Display / Remote Controller	
Making Connections	14
Connections to a TV / Optional Video Connections / Optional Audio Connections	

Basic Operations

Turning on	17
Connecting the POWER	
Basic Playback	18
Starting Playback / Various Playback	

Advanced Operations

Using Banner Display	20
Using the on-screen Banner Display / Selecting a Title / Selecting a Chapter or Track / Selecting a Playback Audio Setting / Changing the Subtitle Language / Changing the Camera Angle / Using IntroScan function / Using a bookmark	
Other Operations	25
Random Play / Repeat Play / A-B Repeat Play / CD PLAY function / Memory Play	
MP3 Function	28
Playing back MP3 / Selecting MP3 files / MP3 memory playback	

Function Setup

Customizing the Settings	30
Making Adjustments to Setting / Language Setting / Operation Setting / Picture Setting / Audio Setting	
Table of Languages	36
Table of Language and Their Code No.	

Others



Troubleshooting	37
Specifications	38

Notes on Discs

This section shows you how to handle, clean, and store discs.

Playable Discs

This DVD Changer can playback the following discs.

	Disc mark	Contents	Disc size
DVD-Video		Audio + Video (moving pictures)	12 cm
			8 cm
Video CD		Audio + Video (moving pictures)	12 cm
			8 cm
CD CD-R* CD-RW*		Audio	12 cm
			8 cm (CD single)

* The DVD Changer can play CD-R/RW discs recorded in CD-DA format, or with MP3 audio files. Some CD-R/RW discs may not be able to be played back.

- You cannot play discs such as DVD-Audio, DVD-RAM etc., even if the marks in the above table are labeled on those discs.
- This DVD Changer uses the NTSC color system, and cannot playback video media recorded in any other color system (SECAM, etc.).
- Avoid using heart-shaped or octagonal discs. Playing irregularly shaped discs may damage the internal mechanism of the DVD Changer.

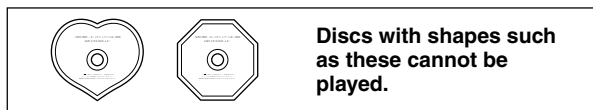

- Do not use discs that have residue from adhesive tape, rental discs that have peeling labels, or discs that have custom labels or stickers. Otherwise, you may not be able to eject the discs or the DVD Changer may become inoperative.

The Structure of the Disc Content

DVD-Video

Normally, the contents of DVD-Video are divided into titles, and the titles are subdivided into chapters.

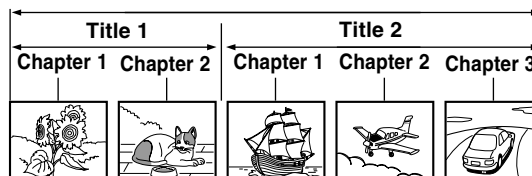

Video CD/CD

Video CD and CD are divided into tracks.



About Video CDs

This DVD Changer supports Video CDs equipped with the PBC (Version 2.0) function. (PBC is the abbreviation of Playback Control.) You can enjoy two playback variations depending on the type of disc.

- Video CD not equipped with PBC function (Version 1.1)**
Sound and movies can be played on this DVD Changer in the same way as a CD.
- Video CD equipped with PBC function (Version 2.0)**
In addition to operation of the Video CD not equipped with the PBC function, you can enjoy playback with interactive software and search function using the menu displayed on the TV screen (Menu Playback). Some of the functions described in this Instruction Manual may not work with some discs.

MP3 compatibility information

- The CD-R or CD-RW must be ISO 9660 level 1 compatible.
- Files should be MPEG1 Audio Layer 3 format, 32 kHz, 44.1 kHz (recommended) or 48 kHz, 32 kbps - 320 kbps (128 kbps recommended). Incompatible files will not play.
- This system only plays tracks that are named with the file extension ".mp3" or ".MP3".
- Use CD-R or CD-RW media for recording your MP3 files. The disc must be finalized in order to play.

Handling Discs

- Do not touch the playback side of the disc.

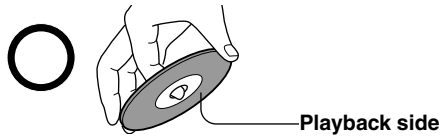

- Do not attach paper or tape to discs.



Cleaning Discs

- Fingerprints and dust on the disc cause picture and sound deterioration. Wipe the disc from the center outwards with a soft cloth. Always keep the disc clean.

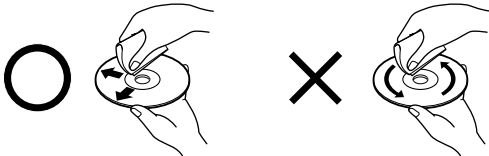

- If you cannot wipe off the dust with a soft cloth, wipe the disc lightly with a slightly moistened soft cloth and finish with a dry cloth.
- Do not use any type of solvent such as thinner, benzine, commercially available cleaners or antistatic spray for vinyl LPs. It may damage the disc.

Storing Discs

- Do not store discs in a place subject to direct sunlight or near heat sources.
- Do not store discs in places subject to moisture and dust such as a bathroom or near a humidifier.
- Store discs vertically in a case. Stacking or placing objects on discs outside of their case may cause warping.

Notes on Copyright

It is forbidden by law to copy, broadcast, show, broadcast on cable, play in public, and rent copyrighted material without permission. The video recorded on DVD-Video is copy protected, and any recordings made from these discs will be distorted.

This product incorporates copyright protection technology that is protected by method claims of certain U.S. patents and other intellectual property rights owned by Macrovision Corporation and other rights owners. Use of this copyright protection technology must be authorized by Macrovision Corporation, and is intended for home and other limited viewing uses only unless otherwise authorized by Macrovision Corporation. Reverse engineering or disassembly is prohibited.

Features/Supplied Accessories

Features

- Plays DVD-Video Discs, Video CDs, CDs
- 10-bit Video DAC
- Parallel Video Output
- Digital Outputs pass DTS[®]*1, Dolby[®]*2 Digital and PCM Signals
- Built-In Dolby[®] Digital decoder
- Full-function remote controller
- Direct Digital path
- Plays 5 Discs
- CD-R and CD-RW playable
- Plays MP3
- CD PLAY function for audiophile
- Pass 96 kHz PCM digital stream

*1 "DTS" and "DTS Digital Out" are trademarks of Digital Theater Systems, Inc.

*2 Manufactured under license from Dolby Laboratories. "Dolby" and the double-D symbol are trademarks of Dolby Laboratories. Confidential Unpublished Works. ©1992-1997 Dolby Laboratories, Inc. All rights reserved.

Supplied Accessories

Make sure your box contains everything listed below.
If any pieces are missing, contact your nearest Onkyo dealer.
The number of accessories is indicated in brackets [].

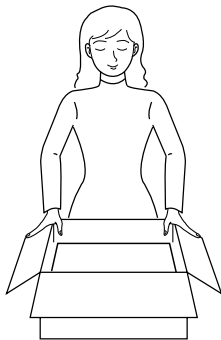

Remote controller (RC-469DV) [1]

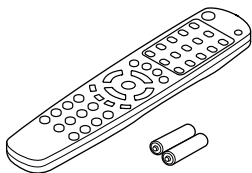

Batteries (size AAA/R3) [2]

Audio/video cable [1]

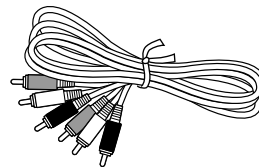

Preparing the Remote Controller

Inserting the Batteries

- 1 Remove the battery compartment cover by pressing the tab and lifting up the cover.

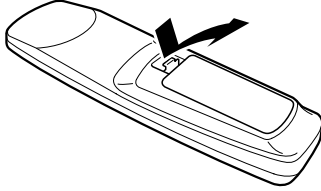

- 2 Insert the two batteries (size AAA/R3). Be sure to match the + and - ends of the batteries with the diagram inside the battery compartment.

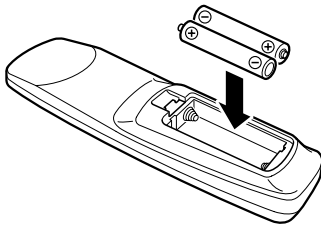

- 3 Replace the battery compartment cover.

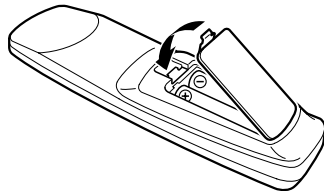

Using the Remote Controller

Point the remote controller toward the remote control sensor.

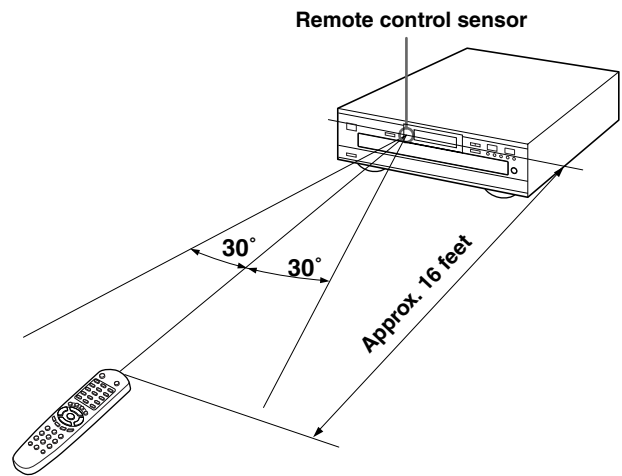

Notes

- Place the unit away from strong light such as direct sunlight or inverted fluorescent light which can prevent proper operation of the remote controller.
- Using another remote controller of the same type in the same room or using the unit near equipment which uses infrared rays may cause operational interference.
- Do not put any object such as a book on the remote controller. The buttons of the remote controller may be pressed by mistake and drain the batteries.
- Make sure the audio rack doors do not have colored glass. Placing the unit behind such doors may prevent proper remote controller operation.
- If there is any obstacle between the remote controller and the remote control sensor, the remote controller will not operate.

Notes

- Do not mix new batteries with old batteries or different kinds of batteries.
- To avoid corrosion, remove the batteries if the remote controller is not to be used for a long time.
- Remove dead batteries immediately to avoid damage from corrosion. If the remote controller does not operate smoothly, replace both batteries at the same time.
- The life of the batteries supplied is about six months but this will vary depending on usage.

Control Position and Names

Front Panel

For operational instructions, see the page indicated in brackets [].

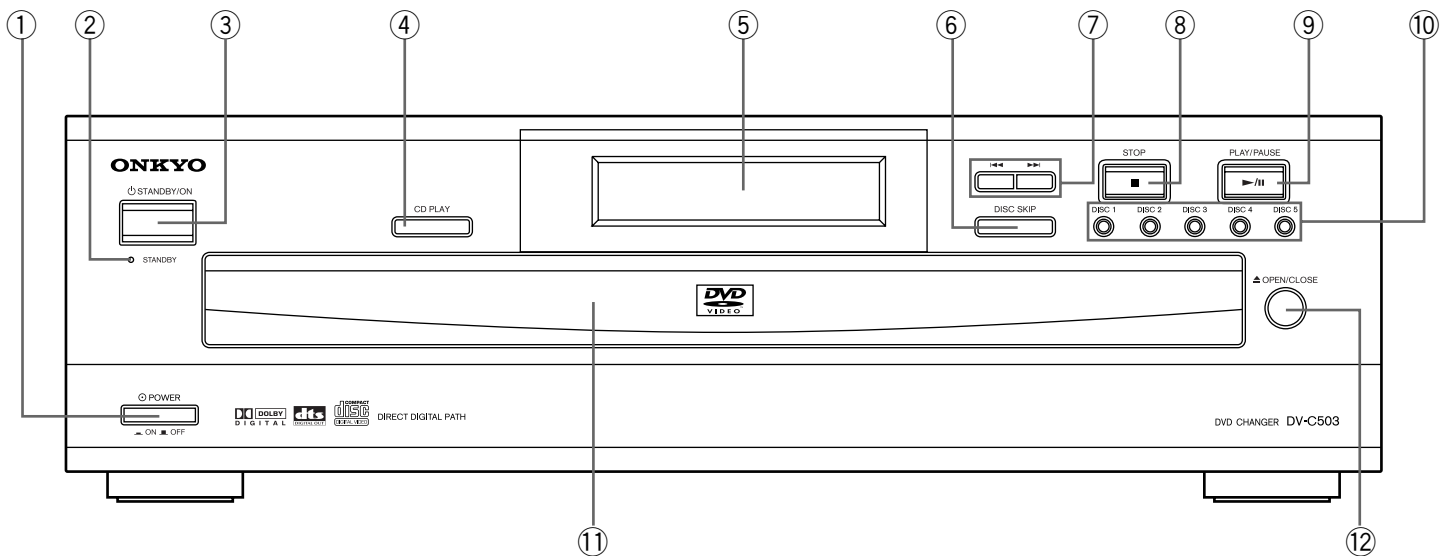

- ① **POWER button [17]**
Turns on the main power supply.
- ② **STANDBY indicator [17]**
Lights in the standby mode.
- ③ **STANDBY/ON button [17]**
Toggle for standby on and off.
- ④ **CD PLAY button [26]**
Press to use the DVD Changer as CD player.
- ⑤ **Front panel display [12]**
- ⑥ **DISC SKIP button [18]**
Press to select a disc. When the DISC SKIP button is pressed while the disc tray open, the tray simply rotates.
- ⑦ **◀◀/▶▶ buttons [19]**
Allow you to move to the previous chapter or track / the next chapter or track on a disc.
- ⑧ **STOP ■ button [18]**
Stops playing a disc. When disc is playing, if you press ■ and ▶, the disc will start resume play. When ■ is pressed again during stop mode, the resume function is canceled.
- ⑨ **PLAY/PAUSE ▶/|| button [18]**
Begins to play disc (close disc tray first if it is open.)
Temporarily stops playback when a disc is playing. Press this button again for normal playback.
- ⑩ **DISC 1-5 buttons [18]**
Press to select a disc.
- ⑪ **Disc tray [18]**
- ⑫ **▲ OPEN/CLOSE button [18]**
Press to open or close the disc tray.

Control Position and Names

Rear Panel

For operational instructions, see the page indicated in brackets [].

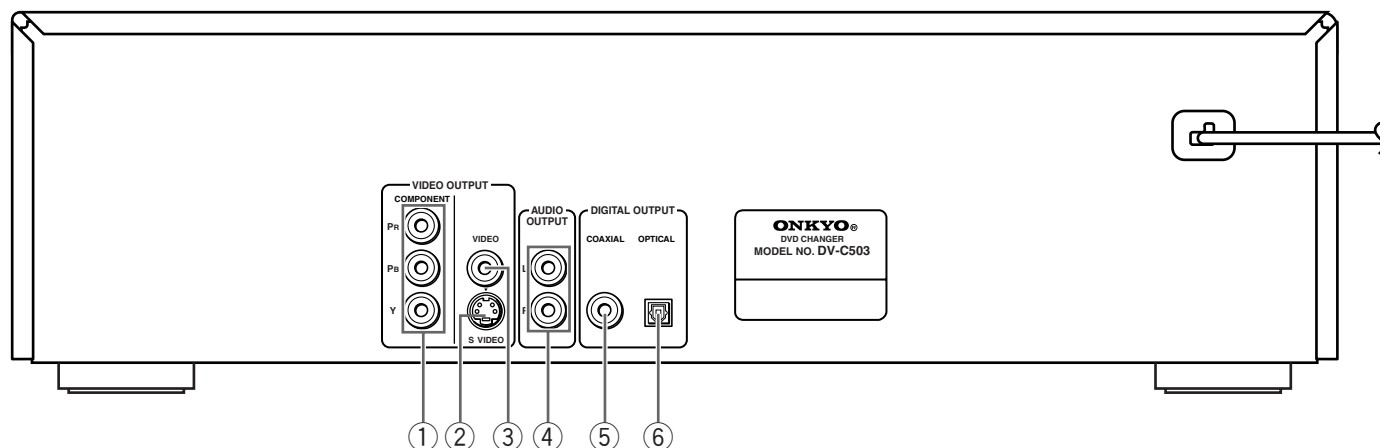

① **VIDEO OUTPUT COMPONENT (Pr/Pb/Y) jacks [15]**

If your TV has component inputs, you can connect a component video cable to your TV and to your DVD Changer for ideal video quality. The component video cable only carries the video signal; remember to connect the left and right audio cables.

② **VIDEO OUTPUT S VIDEO jack [15]**

If your TV has a S-Video jack, you can connect an S-Video cable to your TV and to your DVD Changer for improved video quality. The S-Video cable only carries the video signal; remember to connect the left and right audio cables.

③ **VIDEO OUTPUT VIDEO jack [14]**

Connect a video cable to this jack and to the Video Input jack on your TV.

④ **AUDIO OUTPUT jacks [14-16]**

Insert audio cables (left and right) to these jacks on your DVD Changer and to the corresponding Audio Input jacks (left and right) on your TV or receiver.

⑤ **DIGITAL OUTPUT COAXIAL jack [16]**

Use coaxial cable (not provided) to connect your DVD Changer to an AV component that features digital input capability. If the component has a Dolby Digital or DTS decoder, you can enjoy theater-quality multichannel sound.

⑥ **DIGITAL OUTPUT OPTICAL jack [16]**

Use optical cable (not provided) to connect your DVD Changer to an AV component that features digital input capability. If the component has a Dolby Digital or DTS decoder, you can enjoy theater-quality multichannel sound.

Control Position and Names

Display

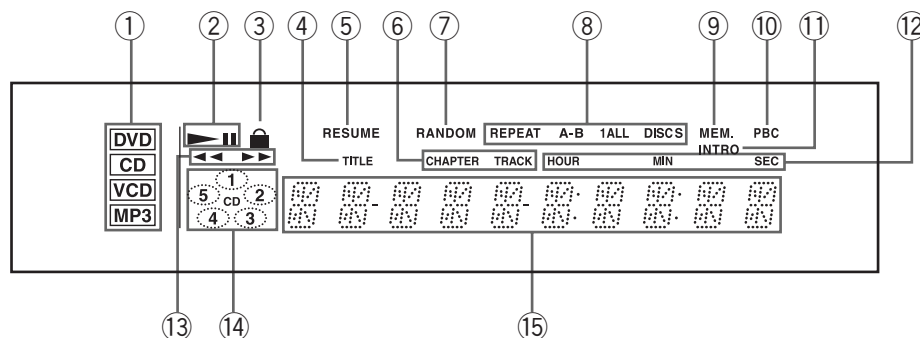

- ① **Inserted disc indicators**
Indicate the type of current disc that is loaded.
- ② **Play/Pause indicators**
Illuminate in play or pause mode.
- ③ **Parental Lock indicator**
Illuminates in parental lock mode.
- ④ **TITLE indicator**
Illuminates to indicate the current title number.
- ⑤ **RESUME indicator**
Illuminates when the player is ready for resume playback.
- ⑥ **CHPTER/TRACK indicators**
Indicate display mode of the current chapter of DVD disc or track number of Video CD or CD.
- ⑦ **RANDOM indicator**
Illuminates during random playback.
- ⑧ **REPEAT indicators**
Illuminate during repeat playback.
- ⑨ **MEM. indicator**
Illuminates during memory playback.
- ⑩ **PBC indicator**
Illuminates when PBC is on for Video CD.
- ⑪ **INTRO indicator**
Illuminates during intro-scan playback.
- ⑫ **Elapsed time indicators**
Indicate playing time.
- ⑬ **Search indicators**
Illuminate during search and slow playback mode.
- ⑭ **Disc number indicator/CD indicator**
Disc number indicators indicate the presence of a disc. CD indicator illuminates when the DVD Changer is in CD PLAY mode.
- ⑮ **Multifunction indicator**
Indicates operating status, messages, etc.

■ Display Examples

During DVD-Video playback:

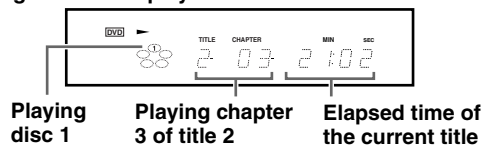

Notes

- Some discs may not display chapter numbers.
- A time indication not accompanied with a chapter number shows elapsed time of a segment within the current time.

During Video CD playback:

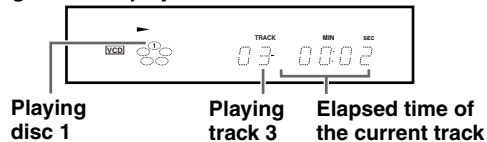

Note

Some discs may not display track numbers or elapsed time.

During CD playback:

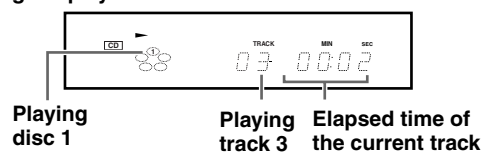

Control Position and Names

Remote Controller

For operational instructions, see the page indicated in brackets [].

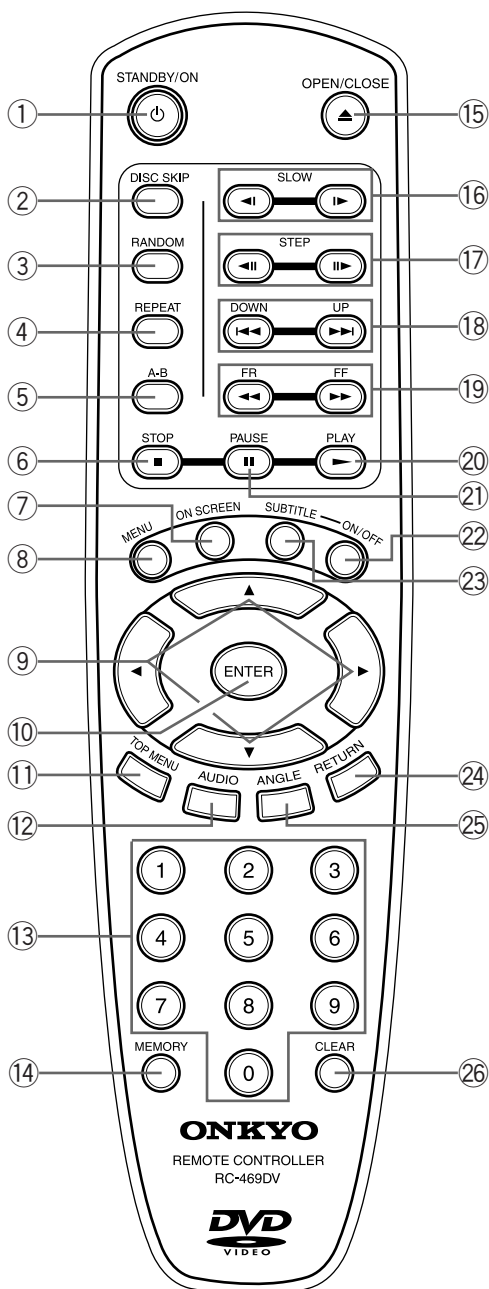

① **STANDBY ON** button [17]

Toggle for standby on and off.

② **DISC SKIP** button [18]

Press to skip a disc.

③ **RANDOM** button [25]

Press to do random playback.

④ **REPEAT** button [26]

Press to go to the Repeat menu. You can repeat a title, chapter, track or one or entire discs.

⑤ **A-B** button [26]

Press to play section A-B repeatedly.

⑥ **STOP** button [18]

Stops playing a disc. When disc is playing, if you press and , the disc will start resume play. When is pressed again during stop mode, the resume function is canceled.

⑦ **ON SCREEN** button [20-24]

Press this button while you're playing a disc to see Banner Display on the screen. The Banner Display contains various playback features and gives you the information about the disc you're playing.

⑧ **MENU** button [30]

Displays the DVD Disc Menu on the TV screen in play mode and Setup Menu in stop mode.

⑨ **Cursor buttons** (, , ,) [20-24, 27, 29, 30]

Use the cursor buttons to select the items or settings.

⑩ **ENTER** button [20-24, 27, 29, 30]

Press this button to select and execute a highlighted menu item.

⑪ **TOP MENU** button [31]

Press to call up the top menu programmed on the DVD. Depending on the DVD, the top menu may be identical to DVD menu or title menu. In case of Video CD, it will be used for PBC on/off.

⑫ **AUDIO** button [22]

Press to select various audio languages on a DVD disc. In case of Video CD, it will be used to select the audio channel.

⑬ **Number buttons (0~9)** [21]

Allow to select numbers by pressing these buttons.

⑭ **MEMORY** button [27]

Press to see Memory Edit Display on the screen in stop mode.

⑮ **OPEN/CLOSE** button [18]

Press to open or close the disc tray.

⑯ **SLOW** buttons [19]

Allow you to play movie in slow mode. Each time you press this button, slow speed will be changed.

⑰ **STEP** buttons [19]

Freeze a picture when a disc is playing. Also the picture advances frame by frame each time to press this buttons. In case of VCD, reverse STEP can not be activated.

⑱ **DOWN** / **UP** buttons [19]

Allow you to move to the previous chapter or track / the next chapter or track on a disc.

⑲ **FR** / **FF** buttons [19]

Allow you to search in reverse or forward through a disc while it is in play mode. Each time you press this button, search speed changes.

⑳ **PLAY** button [18]

Begins to play disc (close disc tray first if it is open.)

㉑ **PAUSE** button [19]

Temporarily stops playback when a disc is playing. Press **PLAY** button for normal playback.

㉒ **SUBTITLE ON/OFF** button [22]

Turns the subtitles on and off when playing a DVD.

㉓ **SUBTITLE** button [22]

Press to select various subtitle language on a disc.

㉔ **RETURN** button [30]

When you're using the DVD Changer's menu system, press this button to return to the preceding menu screen.

㉕ **ANGLE** button [23]

Press to select various camera angles on a disc.

㉖ **CLEAR** button [20, 22-24, 26, 29]

Press to clear entered values and settings. Also Banner menu and OSD menu is removed from the screen when this button is pressed.

Making Connections

To accommodate a wide range of home entertainment systems, this player features numerous connection types for both audio and video. Please refer to the instructions on this and the following pages to determine the best possible type of connections for your system.

Before Connecting

- Refer to the instruction manuals supplied with any and all components that you plan to connect the DVD Changer to.
- Be sure to turn off the power of all components to be connected and unplug them from the wall outlet before making any connections.
- Connect the DVD Changer to the TV or AV component directly. If you connect the DVD Changer to a VCR, TV/VCR combination, or video selector, the playback picture may be distorted as DVD Video images are copy protected.
- Please note that video connections to a TV or monitor are necessary because some discs require on-screen menu interaction before they can be played.

- Connect the plugs securely.

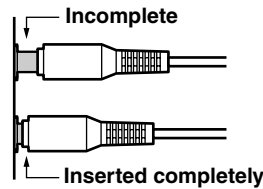

Connections to a TV

The diagram below shows how to make connections to a TV with built-in stereo speakers using the supplied audio/video cable. After making the connections on this page, you will be able to start using the DVD Changer.

Be sure to set TV Aspect after connection using the setup menu explained in "Customizing the Settings" starting on page 30.

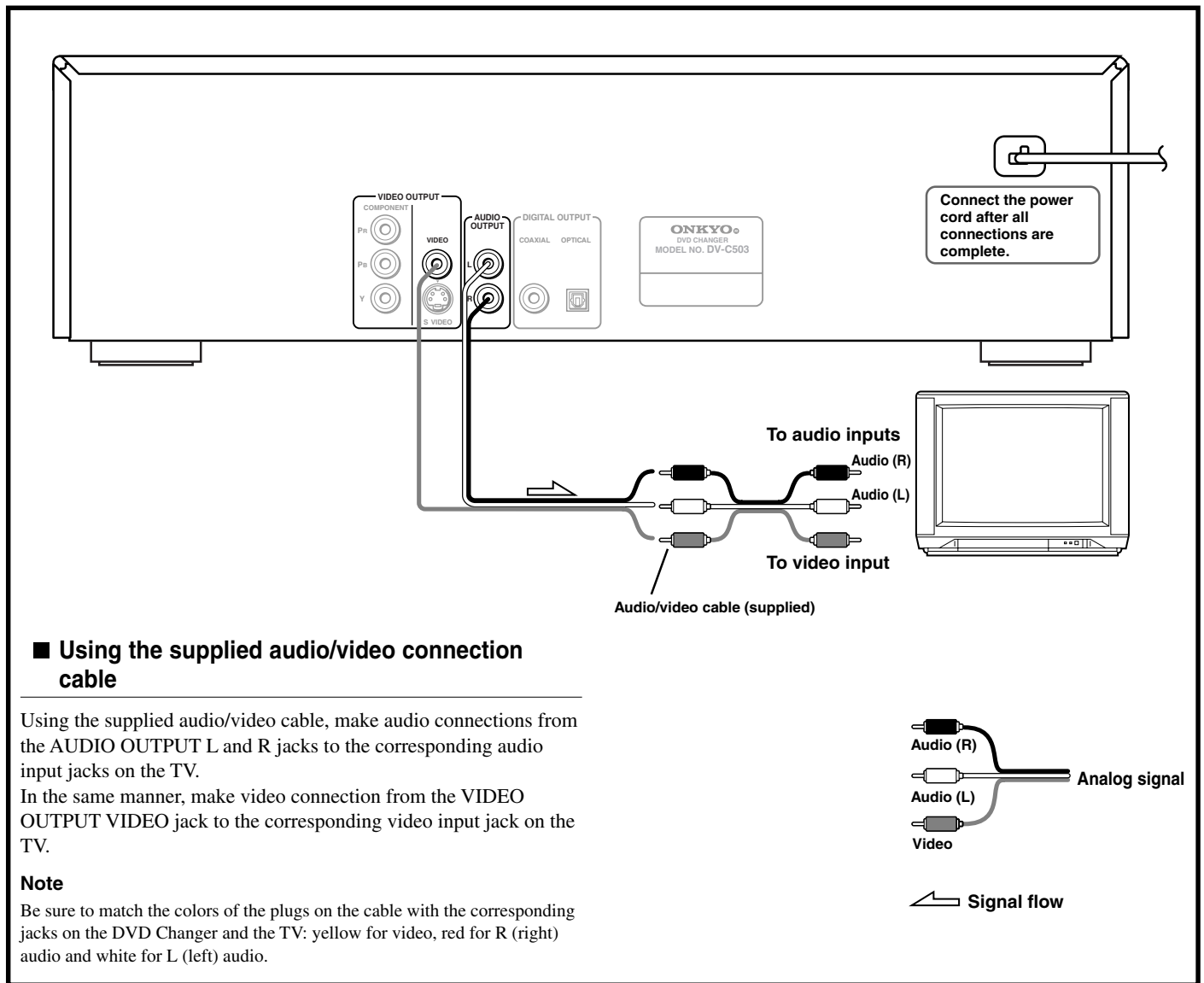

Making Connections

Optional Video Connections

Visible improvements in DVD-Video quality can be achieved by making either S-video or component video connections to a TV or monitor compatible with these types of connections.

Note

When either S-video or component video connection is made, it is not necessary to make composite video connections using the yellow cord of the audio-video cable.

Be sure to set TV Aspect after connection using the setup menu explained in "Customizing the Settings" starting on page 30.

■ Making S-video connections

If the TV or monitor has an S-video input, making this type of video connection will produce improved picture quality. Using an S-video cable, connect the VIDEO OUTPUT S VIDEO jack to the corresponding S-video input jack on the TV.

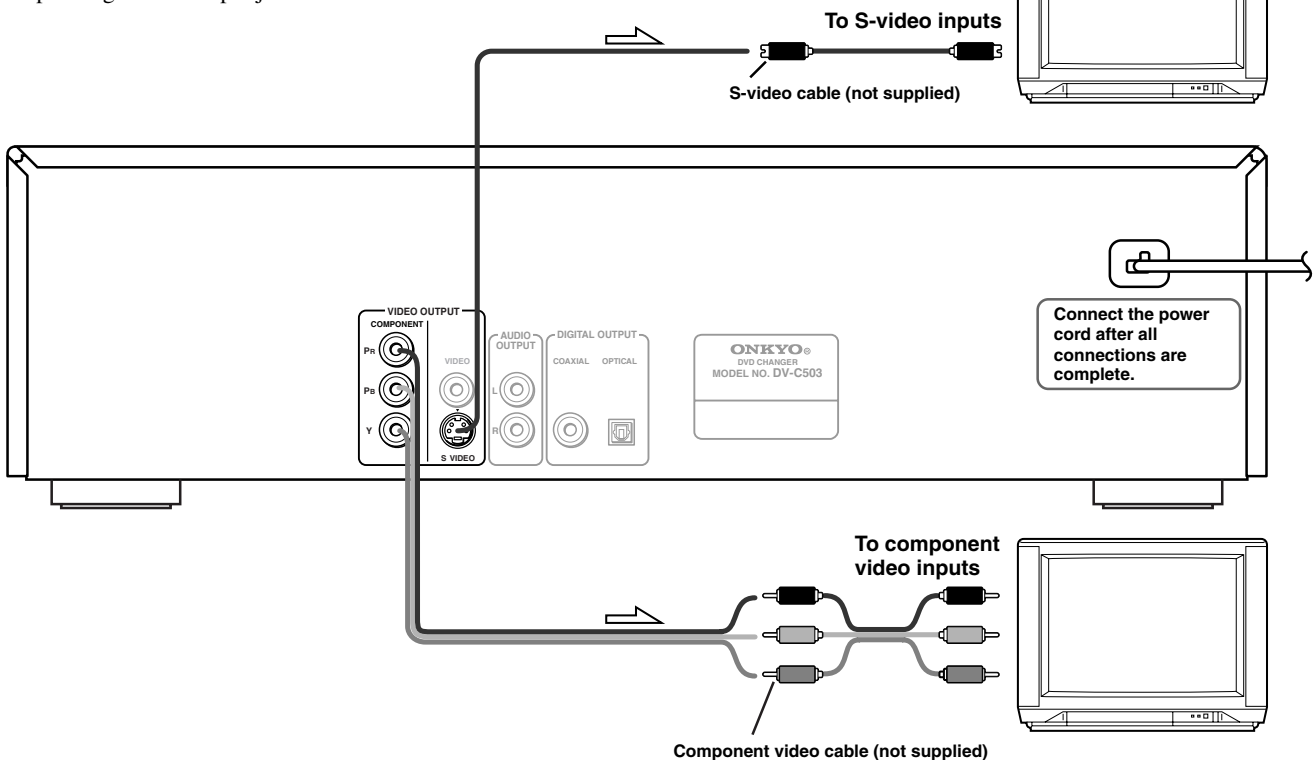

■ Making component video connections

If the TV or monitor has component video inputs, making this type of video connection will produce the ideal picture quality for the presentation of DVD-Video. Using a component video cable (sold separately), connect the VIDEO OUTPUT COMPONENT jacks to the corresponding component video input jacks on the TV.

Actual labels for component video inputs may vary depending on the TV manufacturer. (e.g., Y, R-Y, B-Y or Y, CB, CR)

In some TVs or monitors, the color levels of the playback picture may be reduced slightly or the tint may change. In such a case, adjust the TV or monitor for optimum performance.

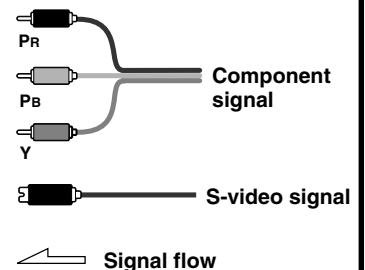

Making Connections

Optional Audio Connections

This DVD Changer provides numerous ways to take full advantage of the digital multi-channel sound recorded on DVD and some CD media. **Be sure to set Digital Audio Out after connection using the setup menu explained in “Customizing the Settings” starting on page 30.**

■ Digital connections

Make digital connections from the DVD Changer to an AV component that features digital input capability or one or more multi-channel audio decoders to realize the full cinematic experience made possible by the DVD format. This DVD Changer features optical and coaxial digital audio output jacks and can output Dolby Digital and DTS bitstreams as well as outputting standard PCM.

Make connections from the DIGITAL OUTPUT OPTICAL jack to the digital optical input jack on the AV component using an optical fiber cable (sold separately). Make connections from the DIGITAL OUTPUT COAXIAL jack to the digital coaxial input jack on the AV component using a coaxial cable (sold separately). It is not necessary to make more than one type of digital connection to a single component.

When you are making connections to an amplifier or receiver that has internal Dolby Digital or DTS decoding capabilities, set Digital Audio Out to “Dolby Digital” or “DTS” using the setup menu explained in “Customizing the Settings” starting on page 30. See page 35 for direct information.

When you are making connections to an amplifier or receiver that has digital input capabilities, but no internal decoder, set Digital Audio Out to “PCM” using the on-screen menu explained in “Customizing the Settings” starting on page 30. See page 35 for direct information. Setting Digital Audio Out to any other setting could result in digital noise being output that could cause harm your hearing and may also damage your speakers.

Notes

- Refer to the instructions supplied with the AV component for details on what digital audio formats it is compatible with.
- Even if digital audio connections are made, it is also recommended to make analog connections, because some conditions or media may prohibit digital audio output.

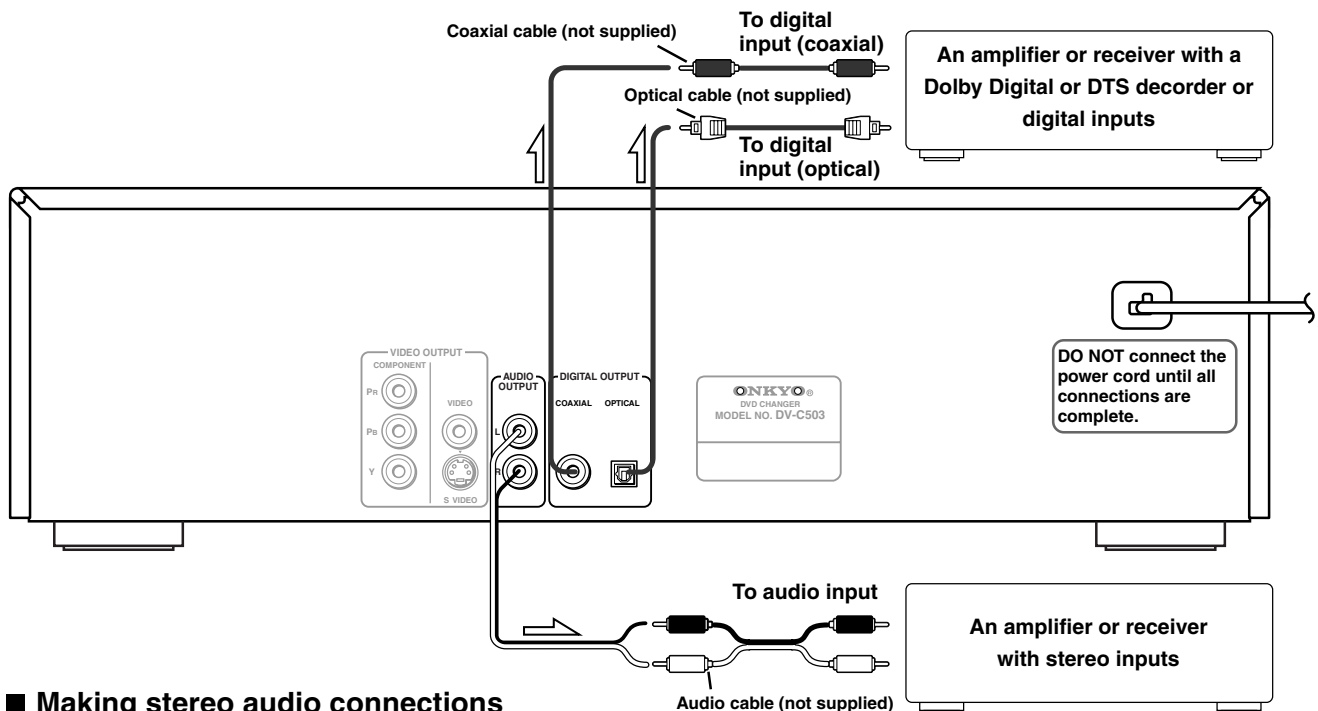

■ Making stereo audio connections

Using an audio cable (sold separately), make audio connections from the AUDIO OUTPUT L and R jacks to the corresponding jacks on the stereo component.

Be sure to set Digital Audio Out setting to “PCM” using the setup menu explained in “Customizing the Settings” starting on page 30. See page 35 for direct information.

Notes

- Be sure to match the colors of the plugs on the cable with the corresponding jacks on the DVD Changer and the stereo component: red for R (right) audio and white for L (left) audio.
- Do not make connections to the PHONO or TUNER jacks on the stereo component.

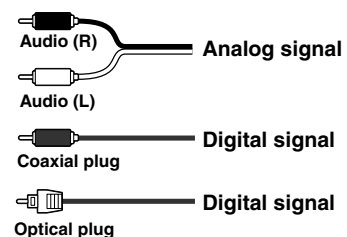

Signal flow

Turning on

Connecting the POWER

The DV-C503 is shipped with the main power (POWER) switch in the on position (ON). When the power cord is plugged in for the first time, the DV-C503 will automatically enter the standby mode and the STANDBY indicator will light (same condition after step 2 below).

Notes

- Make sure that all appropriate connections have been completed as described on pages 14 to 16.
- Turning on the DVD Changer may cause a momentary power surge, which might interfere with other electrical equipment such as computers. To prevent interference, use a wall outlet on a different circuit.

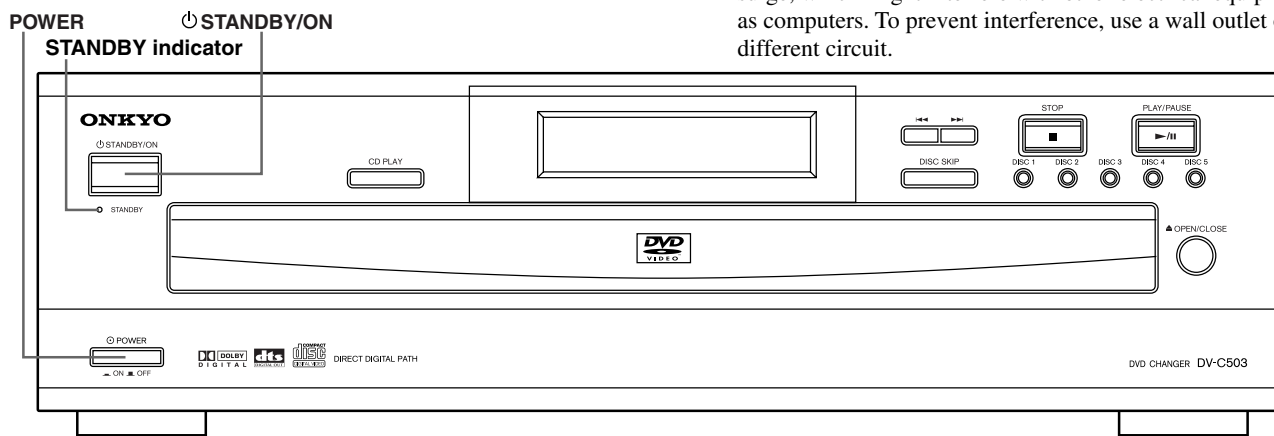

1 Plug the power cord into the power outlet on the wall.

2 Press **POWER** to switch on the main power.

The DVD Changer enters standby mode. The STANDBY indicator lights up.

Notes

- The buttons on the remote controller do not operate if the POWER switch is set to OFF.
- To switch off the main power, press **POWER** again.

3 Press **STANDBY/ON** on the DVD Changer or remote controller.

The DVD Changer turns on and the STANDBY indicator turns off. It takes several seconds to read the disc in the disc tray.

Notes

- You can turn on the DVD Changer by pressing **▲** or **▶/II**.
- To put the DVD Changer in the standby mode, press **STANDBY/ON** on the DVD Changer, or remote controller. Be sure to set the volume to minimum before putting the DVD Changer in the standby mode for the next use to avoid sudden loud sound reproduction.
- While the STANDBY indicator lights up, the DVD Changer can receive signals from the remote controller. However, if you press **POWER** on the DVD Changer to switch off the main power, the remote controller cannot be used to turn on the DVD Changer.
- Setting the **STANDBY** button to standby does not shut off the power completely.

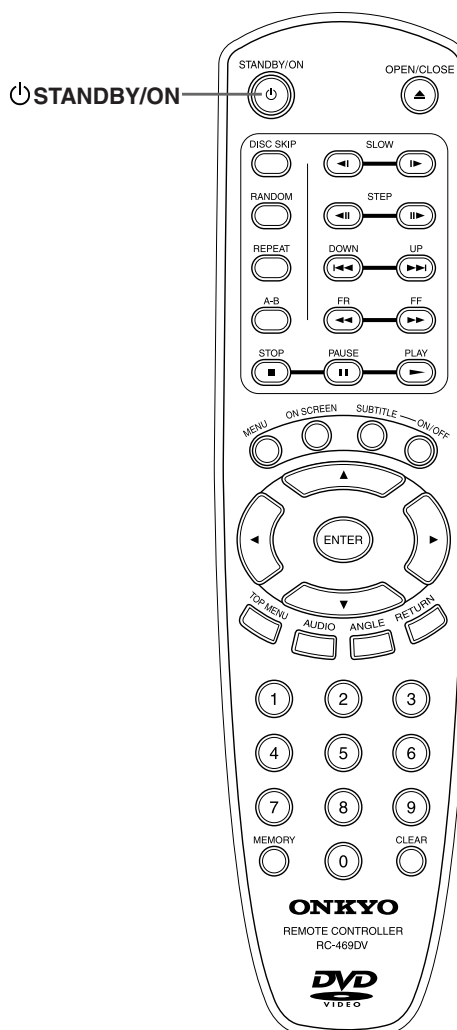

Basic Playback

Before playing

- DVD-Video, Video CD, CD can be played with the DVD Changer (see “Playable Discs” on page 6). Do not play anything else.
- When playing DVD-Video or Video CD with video features, turn on the TV and set the TV to the DVD Changer’s input.
- If an audio system is connected to the DVD Changer, turn on the audio system and set it to the DVD Changer’s input.

About the DVD, VCD and CD marks in the pages related to disc operation

DVD means the function or title is related to DVD-Video operation.

VCD means the function or title is related to Video CD operation.

CD means the function or title is related to audio CD operation.

Warning

If the DVD Changer is connected to the TV or amplifier through the analog audio jacks, do not play DTS-encoded discs. Excessive noise may be output from the analog stereo jacks, which may damage the connected equipment.

To reproduce DTS surround sounds, digital connection to an amplifier with a DTS decoder is needed.

Starting Playback

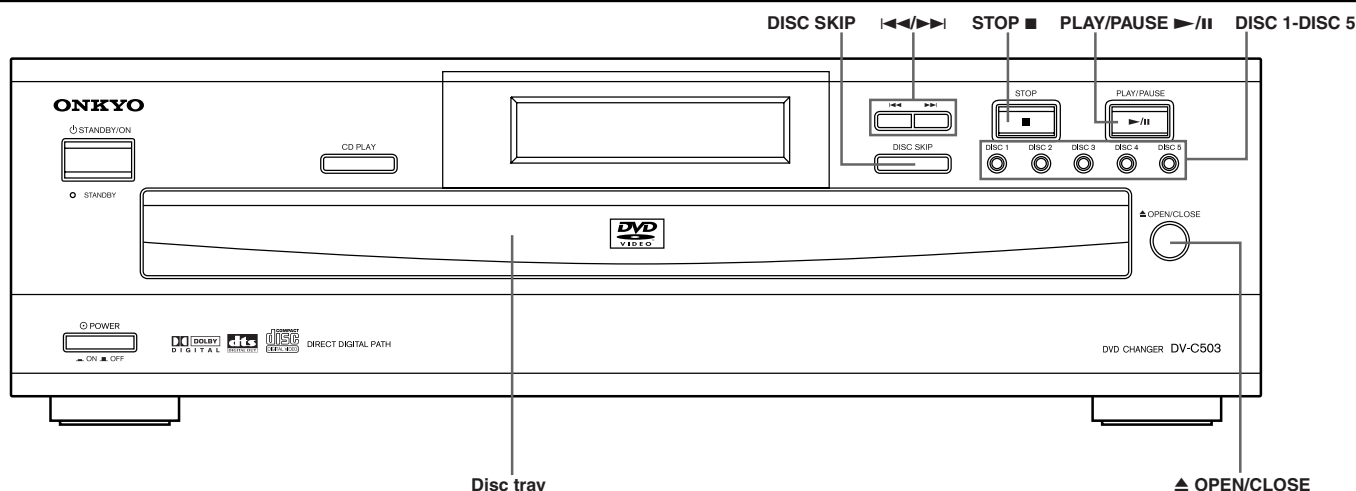

1 Press **▲ OPEN/CLOSE**.

The disc tray opens.

If the DVD Changer is in standby mode when **▲ OPEN/CLOSE button is pressed**

The DVD Changer turns on and the disc tray opens. In this case, it takes several seconds until the disc tray opens.

2 Place a disc on the disc tray.

To insert or remove another disc by changing the tray position, press **DISC SKIP.**

Put the disc in the tray with the label side facing up.

There are two different disc sizes.

Place the disc in the correct guide on the disc tray.

3 Press **▶/|| PLAY/PAUSE**.

The disc tray closes and playback starts.

If you press **▲ OPEN/CLOSE** to close the tray after step 2, playback may automatically start.

The appropriate disc indicator and the play indicator light.

For the other information that appears in the display, see page 12.

If the DVD Changer is in standby mode when **▶/|| PLAY/PAUSE button is pressed**

The DVD Changer turns on and playback starts. In this case, it takes several seconds until playback starts.

■ To stop playback

Press **STOP.**

When you press **▶/|| PLAY/PAUSE** to restart playback, playback starts from the location where you stopped playback because the location index is stored in memory.

Note

The location where playback resumes may vary depending on the disc or the scene where you stopped.

Resuming playback from the beginning

Press **STOP** again after stopping playback to clear the location index memory, then press **▶/|| PLAY/PAUSE** to start playback.

- DVD** Playback starts from the beginning of the current title.
- VCD** Playback starts from the beginning of the disc.
- CD**

To start playback from the beginning of the DVD-Video, press **▲ OPEN/CLOSE** to open the disc tray then press **▶/|| PLAY/PAUSE** to close the disc tray and start playback.

■ To select a disc

Press one of **DISC 1 to **DISC 5** buttons or press **DISC SKIP** repeatedly.**

CAUTION

Keep your fingers well clear of the disc tray as it is closing. Neglecting to do so may cause serious personal injury.

Basic Playback

Various Playback

■ To remove the disc

Press  to open the disc tray.

Remove the disc after the disc tray opens completely.

After removing the disc, be sure to press the button again to close the tray.

Press **DISC SKIP** to rotate the disc tray while the tray open.

■ To play in fast reverse or fast forward

During normal playback, press .

Each press of the same button changes the playback speed.

(At the time of DVD playback)

F.SEARCH 1 (approx. x2) → F.SEARCH 2 (approx. x4) →



F.SEARCH 3 (approx. x8) → F.SEARCH 4 (approx. x16) →

F.SEARCH 1 (back to the beginning)

(At the time of VCD/CD playback)

F.SEARCH 1 (approx. x2) → F.SEARCH 2 (approx. x4) →

F.SEARCH 3 (approx. x8) → F.SEARCH 1 (back to the beginning)

The rate and direction of playback is indicated by search indicators ( or ) in the display.

To resume normal playback, press .

Notes

- The DVD Changer mutes sounds and omits subtitles during reverse and forward scan of DVD-Video.
- The playback speed may differ depending on the disc.

■ To skip chapters or tracks

During playback, press .

The chapter (or track) in the direction of the button pressed is skipped, and the selected chapter (or track) will be played from the beginning.

When  is pressed once during playback, the chapter (or track) being played will be played from the beginning.

■ To pause playback (still mode)

Press  during playback.

To start playback, press .

■ Playing frame by frame

Press  repeatedly.

Each time you press the button the picture advances one frame.

To resume normal playback, press .

Note

The sound is muted during still mode and frame by frame playback.



■ To play in slow-motion

Press  during playback.

Each press of the same button changes the playback speed.

F.SLOW 1/16 → F.SLOW 1/8 → F.SLOW 1/4 → F.SLOW 1/2 →

F.SLOW 1/16 (back to the beginning)

The rate and direction of playback is indicated by search indicators ( or ) in the display.

To resume normal playback, press .

Notes

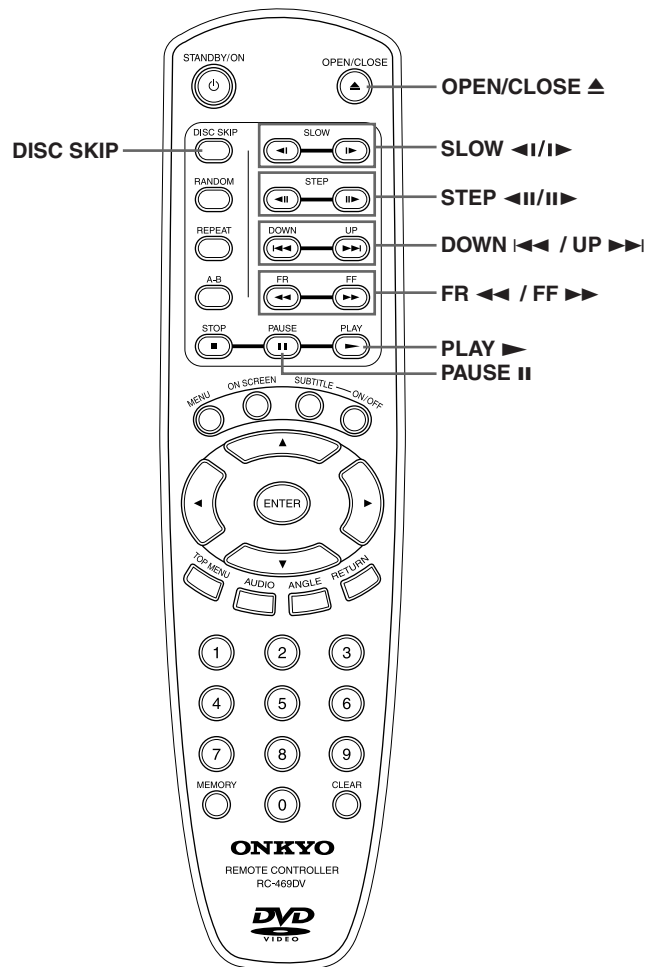

- The sound is muted during slow-motion playback.
- The playback speed may differ depending on the disc.



Tip to obtain a higher quality picture

Occasionally, some picture noise not usually visible during a normal broadcast may appear on the TV screen while playing a DVD-Video because the high resolution pictures on these discs include a lot of information. While the amount of noise depends on the TV you use, you should generally adjust the TV to reduce sharpness when viewing DVD-Videos.

Notes

- Do not move the DVD Changer during playback. Doing so may damage the disc.
- Use  on the remote controller or DVD Changer to open and close the disc tray. Do not touch the disc tray while it is moving. Doing so may cause the DVD Changer to malfunction.
- Do not press down on the disc tray or put any objects other than playable discs on the disc tray. Doing so may cause the DVD Changer to malfunction.
- In many instances, a menu screen appears when playback of a DVD movie is complete. Prolonged display of an on-screen menu may damage your television set, permanently etching that image onto its screen. To avoid this, be sure to press  once the movie is complete.

Using Banner Display

Using the on-screen Banner Display

The on-screen Banner Display contains many playback features. To see the Banner Display, press ON SCREEN on the remote controller while a disc is playing. Use ◀▶ to move through the different features in the Banner Display. Each feature is illustrated with an icon.

1 ON SCREEN



During playback, press ON SCREEN.
The Banner Display appears on the screen.

When playing a DVD

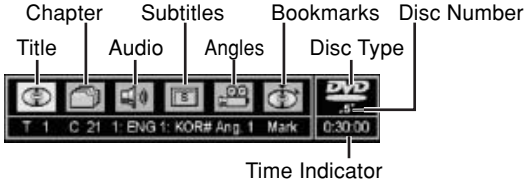

When playing a Video CD/CD

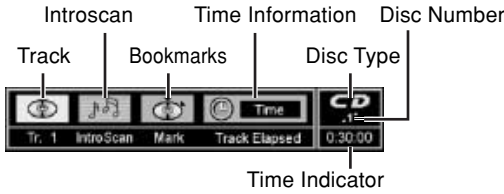

2

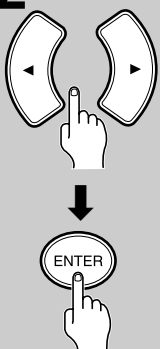

Press ◀▶ to select a desired item, and press ENTER.
Corresponding menu appears on the screen.

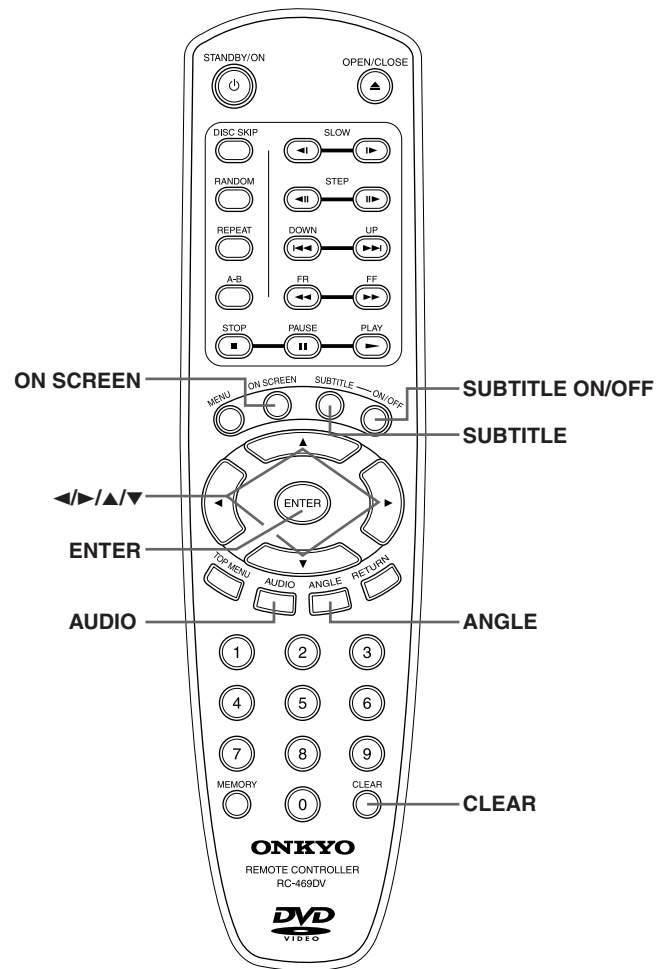

■ To turn off the Banner Display

Press **ON SCREEN** or **CLEAR**.

Notes

- You can only access the banner display when you're playing a disc.
- The banner display features are only available if the disc was created with that particular feature (i.e., if you select the Subtitle icon, you won't be able to change the subtitle language unless the author of the disc created the disc with subtitles).
- The invalid symbol ⊘ appears on the screen when you press a button that doesn't have any function. If one of the icons is "glayed out," the banner feature isn't available for the disc you're playing.
- Depending on the disc, pressing **AUDIO**, **ANGLE** or **SUBTITLE** may display a disc menu. For more details, refer to the instruction notes on the disc.

Using Banner Display



DVD

Selecting a Title

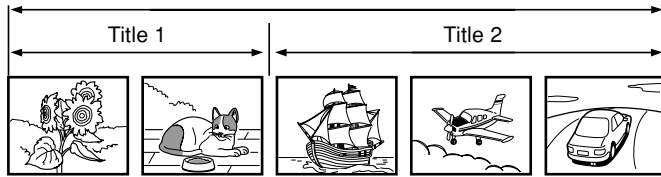
DVD-Video

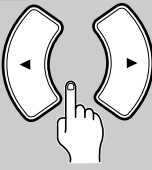

Some discs contain more than one title. For example, there might be four movies on one disc (each movie might be considered a title).

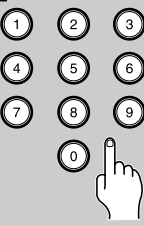
1 ON SCREEN 	Press ON SCREEN.
2  ↓ 	Press ◀/▶ until the TITLE icon is highlighted.
3 	Press ENTER. “T --” appears.
4 	Press the numeric buttons to enter the title number. When you enter a one-digit title number, you may have to press ENTER on the remote controller after pressing the number (1~9) on the remote controller. Otherwise press 0 first and the other value. Then play starts. This varies depending on number of title within the disc you're playing.

Note

Some discs only have one title.

DVD VCD CD

Selecting a Chapter or Track

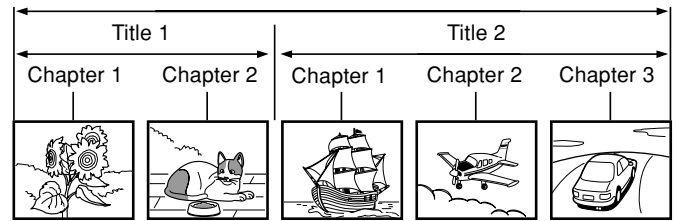

DVD-Video

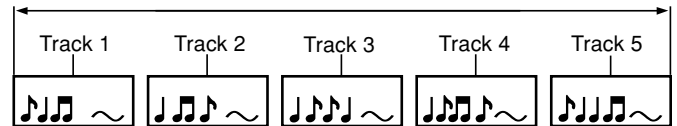

Video CD/CD

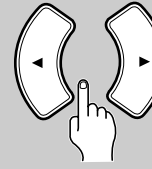

Because DVD discs use digital technology, a title can be divided into individual chapters (similar to tracks on a CD). You can skip a specific chapter by using the Chapter section in the Banner Display.

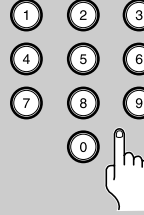
1 ON SCREEN 	Press ON SCREEN.
2  ↓ 	Press ◀/▶ until the CHAPTER or TRACK icon is highlighted.
3 	Press ENTER. “C --” or “Tr. --” appears.
4 	Press the numeric buttons to enter the chapter or track number. When you enter a one-digit chapter or track number, you may have to press ENTER on the remote controller after pressing the number (1~9) on the remote controller. Otherwise press 0 first and the other value. Then play starts. This varies depending on number of chapter or track within the disc you're playing.

Note

The chapter feature won't work if the disc isn't formatted with separate chapters.

Using Banner Display

DVD

Selecting a Playback Audio Setting

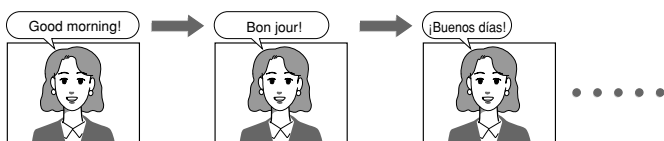

You can select the preferred audio language and sound system as a set from those included on the disc. This function lets you temporarily change the audio language which you selected as the automatic setting in the setting menu (see pages 30 and 31), and choose the sound system if the disc is recorded in more than one sound format.

1 ON SCREEN 	Press On SCREEN during playback.
2 	Press ◀▶ until the AUDIO icon is highlighted.
3 ENTER 	Press ENTER. The audio menu appears.
4 ENTER 	Press ENTER to select the audio. Each time you press ENTER , the audio recording system set changes.

■ To turn off the audio menu

Press **ON SCREEN** or **CLEAR**.

The menu is switched off when no operation is performed for about 5 seconds.

■ Using AUDIO on the remote controller

- 1 Press **AUDIO** on the remote controller during playback.
- 2 Press **AUDIO** or **ENTER** to select the audio language.

Notes

- Dolby Digital 5.1 Channel sound may be displayed as “6ch. Dolby Digital”.
- Before changing the setting, read through the explanation on “Digital Audio Out” on page 35 and carefully select the setting.
- Depending on the disc, it may be necessary to select the audio sound track using the DVD menu. When this is the case, press **MENU** to open the DVD menu and select the appropriate sound track as indicated on the DVD menu screen.
- When the DVD Changer is turned on or when the disc is changed, the audio settings are restored to the presets. In some cases, a language recorded on the disc may be given priority and selected automatically when the disc is loaded regardless of the setting.

DVD

Changing the Subtitle Language



You can display subtitles on the TV screen and select a subtitle language from those included on the DVD-Video.

1 ON SCREEN 	Press On SCREEN during playback.
2 	Press ◀▶ until the SUBTITLE icon is highlighted.
3 ENTER 	Press ENTER. The subtitle menu appears. Displayed when SUBTITLE is on
4 ENTER 	Press ENTER to select the subtitle language. Each time you press ENTER , the subtitle language changes.
5 ON/OFF 	Press SUBTITLE ON/OFF to select subtitle on or off. Switching between display of subtitles and no display of subtitle is done each time the key is pressed.

■ To turn off the subtitle menu

Press **ON SCREEN** or **CLEAR**.

The menu is switched off when no operation is performed for about 5 seconds.

■ Using SUBTITLE on the remote controller

- 1 Press **SUBTITLE** on the remote controller during playback.
- 2 Press **SUBTITLE** or **ENTER** to select the subtitle language.
- 3 Press **SUBTITLE ON/OFF** to select sub title on or off.

Notes

- When you turn on the DVD Changer or replace a disc, the DVD Changer returns to the automatic setting in the setting menu (see pages 30 and 31). When you select a subtitle language which is not included on the disc, the DVD Changer plays the prior language programmed on the disc.
- During some scenes, the subtitles may not appear immediately after you change the subtitle setting.
- Some DVD-Video are set to display subtitles automatically, and you cannot turn them off even if you set the subtitle function to off.



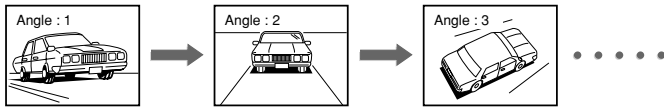

Using Banner Display

DVD

Changing the Camera Angle

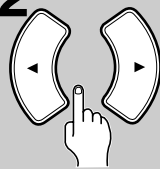

If the scene was recorded from multiple angles, you can easily change the camera angle of the scene you are watching.

1 ON SCREEN 	Press ON SCREEN during playback.
2 	Press ◀/▶ until the Angle icon is highlighted.
3 	Press ENTER. The angle menu appears. 
4 	Press ENTER to select the angle. Each time you press ENTER , the angle changes.

■ To turn off the angle menu

Press **ON SCREEN** or **CLEAR**.

The menu is switched off when no operation is performed for about 5 seconds.

■ Using ANGLE on the remote controller

- 1 Press **ANGLE** on the remote controller during playback.
- 2 Press **ANGLE** or **ENTER** to select the camera angle.

Notes



- You can change the camera angle during still playback. The camera angle changes to the new setting when you resume normal playback.
- If you pause a picture immediately after changing the camera angle, the resumed playback picture may not use the new camera angle.

VCD CD

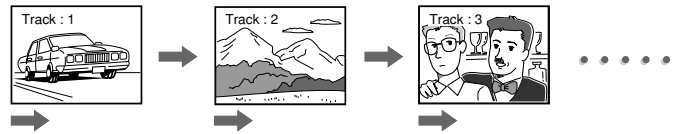
Using IntroScan function

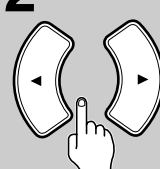

IntroScan plays the first few seconds of each track on the Video CD or CD similar to the scan feature that's on many car radios.

1 ON SCREEN 	When playing a Video CD, press ON SCREEN to display the Banner Display. When playing a CD, the Banner Display appears on the screen automatically.
2 	Press ◀/▶ until the IntroScan icon is highlighted.
3 	Press ENTER. The INTRO indicator lights. The first 10 seconds of each track will be played. Press ▶ to stop IntroScan playback and start playing the current track entirely.

Note

After IntroScan goes through all of the tracks, it stops.

Using Banner Display



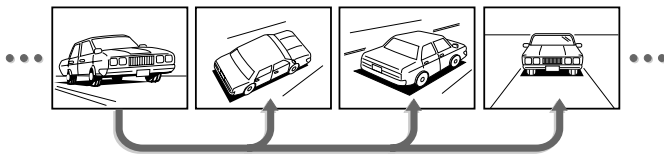

DVD VCD CD

Using a bookmark

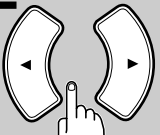

The bookmark feature lets you mark a point on the disc that you can go to quickly. You can store up to 9 bookmarks.

■ Marking a scene

1	ON SCREEN 	Press ON SCREEN during playback.
2	 ↓ 	Press ◀/▶ until the bookmark icon is highlighted and press ENTER The bookmark menu appears.  Exit icon
3		When you reach the scene you want to mark, press ENTER. The bookmark appears on under square. You can store up to 9 bookmarks by repeating this step.

■ To return to the Banner Display

Press ◀/▶ to select the exit icon and press ENTER.





■ To clear the bookmark

The bookmark is cleared when a disc is removed from the DVD Changer, when the power is turned off, or when the DVD Changer enters the standby mode.

Notes

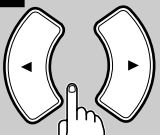
- If all 9 bookmarks are in use, you can still mark new scenes, but the previous bookmarks will be erased.
- Depending on the disc, the bookmark function may not work.

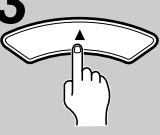
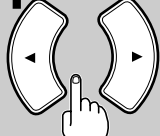
■ Recalling a bookmarked scene

1	ON SCREEN 	Press ON SCREEN during playback.
2	 ↓ 	Press ◀/▶ until the bookmark icon is highlighted and press ENTER The bookmark menu appears. 
3		Press ▲ to move the cursor to the "Go To" parts of the bookmark menu.
4		Press ◀/▶ to select the bookmarked scene you want to activate.
5		Press ENTER to activate the bookmark.

■ To turn off the bookmark menu

Press ON SCREEN or CLEAR.

Other Operations

The following operations can be performed directly from the remote controller.

- Random Play
- Repeat Play
- A-B Repeat Play
- Memory Play

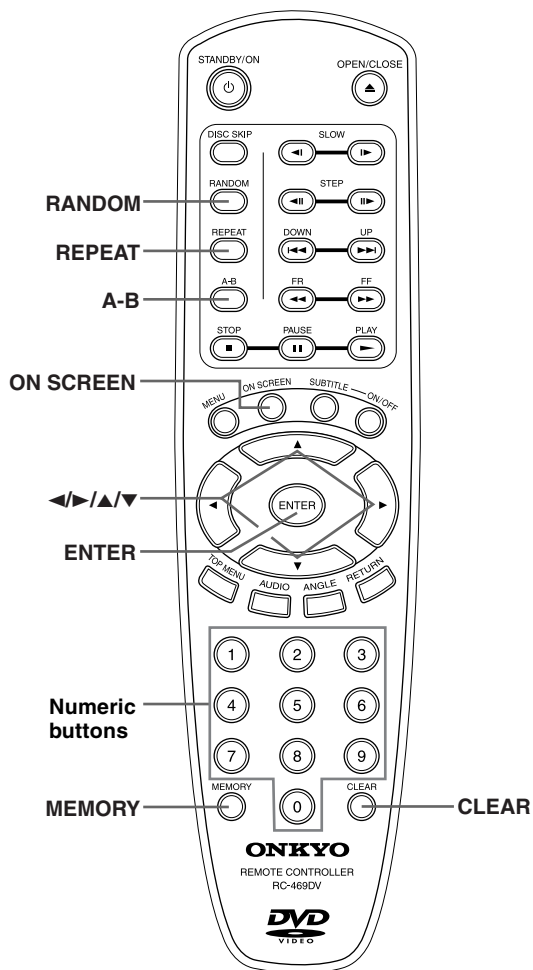

Random play

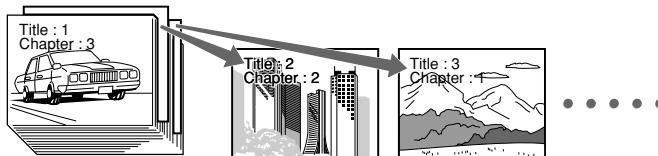

The chapters or tracks of the disc are played in random order.

RANDOM

Press RANDOM.
The random playback starts.

Display	Lights
	<p>RANDOM</p>

The Random Play display appears on the screen.

Random Play

■ To turn off the Random Play display

Press **ON SCREEN** or **CLEAR**.

The menu is switched off when no operation is performed for about 5 seconds.

Note

When playing a DVD, the Random function may not work.

■ To cancel random play

Press **RANDOM** so that RANDOM goes off or to select “Standard Play”.

Each time you press **RANDOM**, random play will be on and off.
Random Play ↔ Standard Play

The Standard Play display appears when random is off.



Other operations

DVD VCD CD

Repeat play

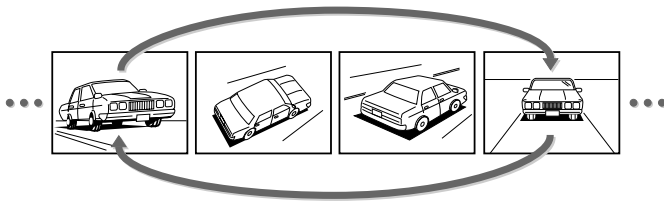

Desired disc or title can be played back repeatedly.
There are five repeat options:

- All Discs Repeat all discs.
- 1 Disc Repeat the disc that is playing.
- Title Repeat the title that is playing.
- Chapter Repeat the chapter that is playing.
- Track Repeat the track that is playing.

REPEAT



Press REPEAT repeatedly during playback.

The Repeat display appears on the screen.



Each time you press **REPEAT**, the repeat option changes.

At the time of DVD playback

- Repeat All Discs Repeats all discs.
- ↓
- Repeat 1 Disc Repeats the entire disc.
- ↓
- Repeat Title Repeats the current title.
- ↓
- Repeat Chapter Repeats the current chapter.
- ↓
- Repeat Off Resumes normal playback.

At the time of Video CD/CD playback

- Repeat All Discs Repeats all discs.
- ↓
- Repeat 1 Disc Repeats the entire disc.
- ↓
- Repeat Track Repeats the current track.
- ↓
- Repeat Off Resumes normal playback.

■ To turn off the Repeat display

Press **ON SCREEN** or **CLEAR**.

The menu is switched off when no operation is performed for about 5 seconds.

■ To cancel repeat playback

Press **REPEAT** so that REPEAT goes off or to select "Repeat Off".

DVD VCD CD

A-B Repeat play

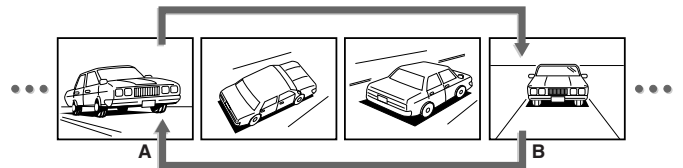

The A-B repeat function lets you mark a segment to repeat between the beginning "A" and the end "B" of the segment you want to replay.

1



Press **A-B** when you want to choose a scene (sound) as the beginning point.

Display

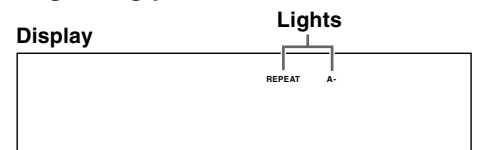

The Repeat A- display appears on the screen.



2



Press **A-B** again to choose a scene (sound) as the end point.

The Repeat A-B display appears.

Display

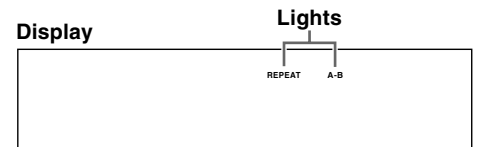

The DVD Changer automatically returns to point A and starts repeat playback of the selected segment (A-B).

■ To turn off the Repeat A-B display

Press **ON SCREEN** or **CLEAR**.

The menu is switched off when no operation is performed for about 5 seconds.

■ To cancel A-B Repeat playback

Press **A-B** so that A-B REPEAT goes off or to select "Repeat off".

CD

CD PLAY function

Since the DVD Changer allows you to insert up to five discs in any combination, there may be times when you only want to listen to music. In that case, proceed as follows:

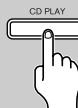

Press **CD PLAY** on the unit.

Playback of DVD and Video CD discs is skipped in order not to interrupt sequential playback.



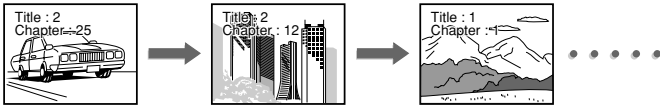

Other operations

DVD VCD CD

Memory Play

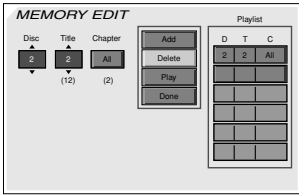
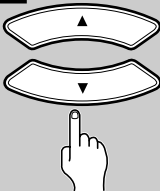

The DVD Changer automatically plays discs, titles, chapters, or tracks in the order you program.

1 	<p>Press MEMORY during stop mode. The MEMORY EDIT display appears and the MEM. indicator lights.</p> 
2 	<p>Press ▲/▼ or numeric buttons to select specific disc/title/chapter or track.</p>
3 	<p>Press ENTER.</p>
4 	<p>Select Add button on the screen to register selected value onto Playlist, then press ENTER.</p>
5	<p>You can select maximum 32 values by repeating steps 2-4.</p>
6 	<p>Press ► or select Play button on the screen and press ENTER to start playback.</p>

■ To delete memory

- 1 Press MEMORY during stop mode.
- 2 Move the cursor with ► to the "Playlist" and press ▲/▼ to select the column to be deleted from the "Playlist". (The color of the column where the cursor is located will change.)
- 3 Press ◀ and press ▲/▼ to move the cursor to the Delete button on the screen, and press ENTER.

■ Insert chapter or track

- 1 Press MEMORY during stop mode.
The MEMORY EDIT display appears.

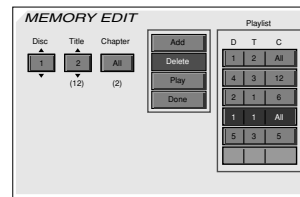

- 2 Press ▲/▼ or numeric buttons to select specific disc/title/chapter or track.
- 3 Move the cursor with ► to the "Playlist" and press ▲/▼ to select the column to be added.
The cursor of the column where the cursor is located will change.
- 4 Press ◀ to move the cursor to the Insert button on the screen and press ENTER.
The new chapter or track will be insert before (above) the selected column.

■ To cancel memory playback

In following cases, Memory play would be released.

- 1 When you open and close tray.
- 2 When you press ■ twice.
- 3 When you turn power off.

Notes

- When you don't add values onto Playlist and return to play mode, select Done button and press ENTER on the remote controller.
- While a disc is playing, press MEMORY on the remote controller to start memory play.

MP3 Function

Playing back MP3

The DVD Changer can play back MP3 files recorded on CD-R or CD-RW.

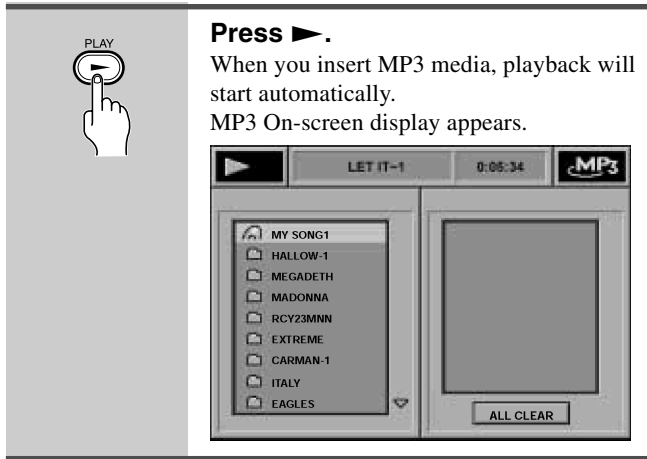

■ To stop playback

Press ■.

■ To skip files

Press ◀◀/▶▶.

Notes

- It is not possible to play back folders and files (up to 223) that exceed the maximum limitations of the media.
- A certain amount of time is required for the player to confirm the media on which MP3 files have been recorded before playback will commence.
- The files will be played back in the sequence in which they were recorded (written).

■ MP3 On-screen display

When you insert MP3 media, the MP3 On-screen display appears.

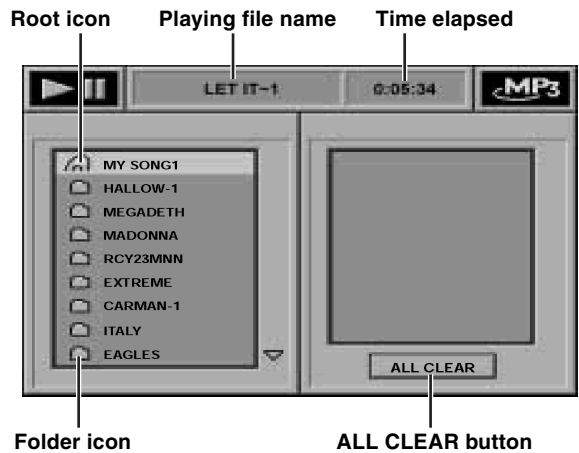

Return folder icon

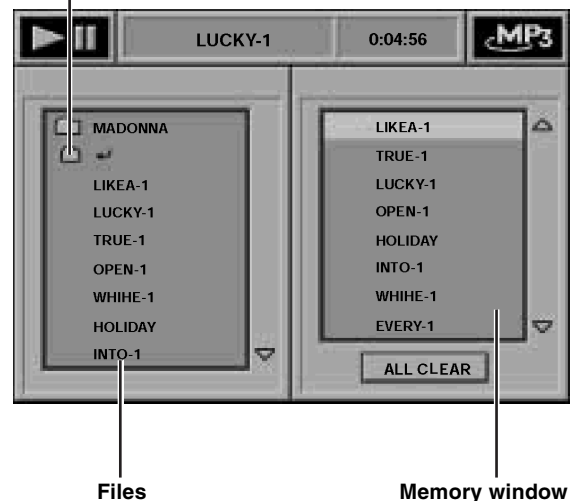

Note

Single-byte characters between A and Z, single-byte numerals between 0 and 9, and the single-byte underscore (_) can be displayed.

MP3 Function

Selecting MP3 files

You can select the files to be played back directly.

1

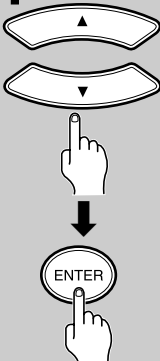

Press ▲/▼ to select the folder, then press ENTER



2

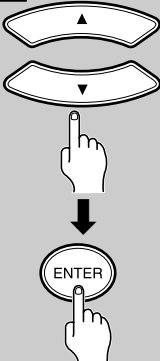

Press ▲/▼ to select the file, then press ENTER.



Playback will start from selected file.
Files in the next folder will be played back when no files exist in the selected folder.

■ To move to the upper layer

Press **ENTER** on return folder icon.

■ To select the folders to be played directly

1 During stop mode, press ▲/▼ to select the folder, then press **ENTER**.

2 Press ▲/▼ to select the upper folder icon, then press ►.

Playback will start from selected folder.

Files in the next folder will be played back when no file exist in the selected folder.

MP3 memory playback

You can listen to the desired files in any desired order.

1



During stop mode, press **MEMORY**.

2

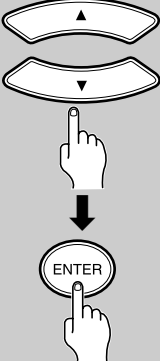

Press ▲/▼ to select the file, then press ENTER.



The selected file goes to memory window.
You can select maximum 1025.

3



Press ►.

■ To delete memory

During stop mode, press ◀/▶ to select the ALL CLEAR button, then press **ENTER**.

You can delete file one by one by selecting and pressing **CLEAR**.

Customizing the Settings

When you insert a DVD-Video, Video CD, or CD, the various functions of the DVD Changer will be set (reset) according to the setting menu. You can customize this setting menu according to your preferences.

Making Adjustments to Setting

- 1** Press **MENU** during stop mode. Current setup menu display appears.

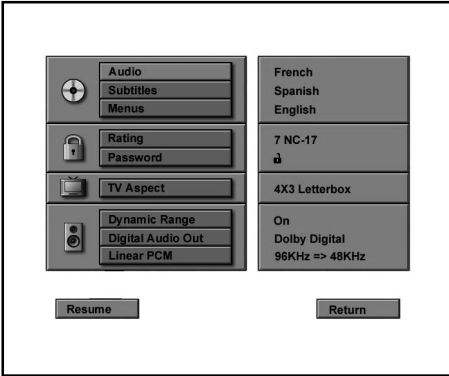

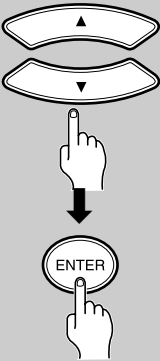
- 2** Press **▲/▼** to select the item you want to change, then press **ENTER**.

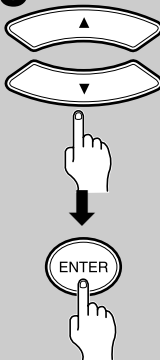
- 3** Press **▲/▼** to change the setting, then press **ENTER**. Further steps may be needed depending on the item or setting. Follow the steps described in the explanation of each item starting from page 31.

- 4** Repeat steps 2 to 3 to change the setting of other items.
- 5** Press **MENU** to turn off the setup menu display.

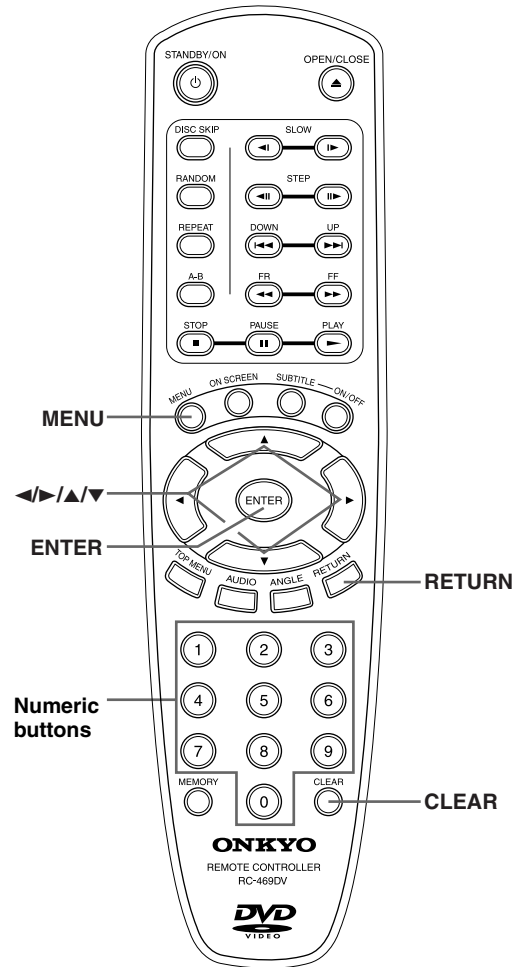



■ How to use RETURN

When **RETURN** is pressed, the display returns to the previous screen (stop mode).

Customizing the Settings



Language-related settings

Language Setting

Audio Language DVD

This sets the language to be used when playing a disc. If a disc does not contain the selected language, it is played in the priority language set for each disc.

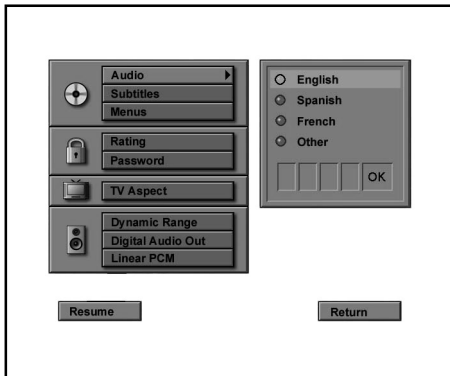

English: To play sound tracks in English.

Spanish: To play sound tracks in Spanish.

French: To play sound tracks in French.

Others: To make a further choice. Follow steps 1 - 3 below.

- 1 Select "Other" and press ENTER.
- 2 Press the numeric buttons to enter the 4-digit code.
- 3 Select OK button and press ENTER.

Note

Depending on the disc, a language recorded on the disc may be given priority and selected automatically when the disc is loaded regardless of the setting.

Subtitle Language DVD

This sets the language to be used when playing a disc. If a disc does not contain the selected language, it is played in the priority language set for each disc.

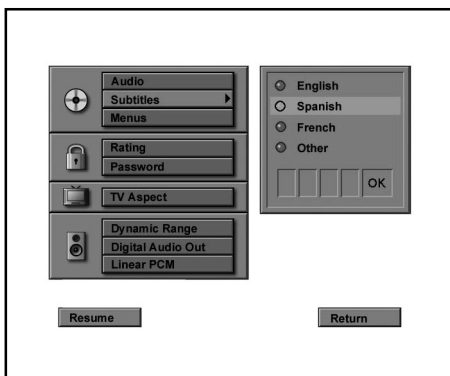

English: To display subtitles in English.

Spanish: To display subtitles in Spanish.

French: To display subtitles in French.

Others: To make a further choice. Follow steps 1 - 3 below.

- 1 Select "Other" and press ENTER.
- 2 Press the numeric buttons to enter the 4-digit code.
- 3 Select OK button and press ENTER.

Notes

- Some DVD-Video may be set to display subtitles in a different language than you selected. A prior subtitle language may be programmed on the disc.
- Some DVD-Video allow you to change audio and subtitle selections only via the disc menu. If this is the case, Press **TOP MENU** or **MENU** and choose the appropriate audio and subtitle language from the selection on the disc menu.
- Instruction notes of discs may refer to the button that displays the top menu as title button.

Menu Language DVD

This sets the initial setup of language as well as the language used in on-screen messages such as "PLAY".

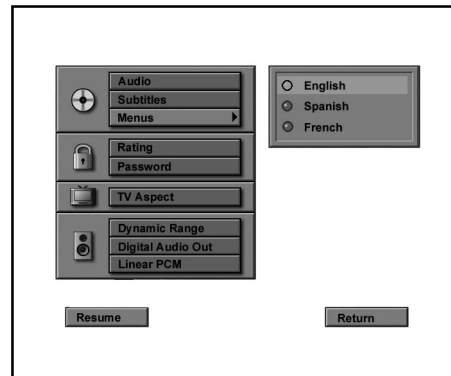

English: To display disc menus in English.

Spanish: To display disc menus in Spanish.

French: To display disc menus in French.

Note

Some DVD-Video may not include your pre-selected language. In this case, the DVD Changer automatically displays disc menus consistent with the disc's initial language setting.

Customizing the Settings



General utility settings

Operation Setting

Rating/Parental lock



This can restrict playback of adult-oriented DVD discs that you do not want to be seen by children.

However, even when a DVD disc is marked "Adult-oriented" or so on the label, its viewing cannot be restricted unless the restriction level is recorded in the disc itself.

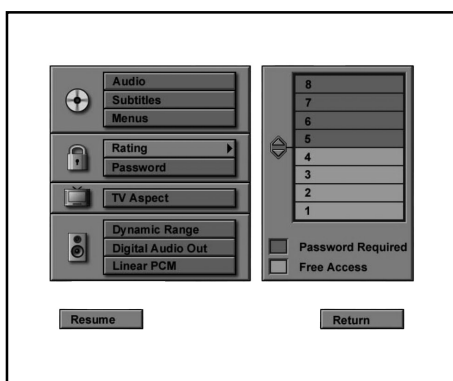

You cannot play DVD Video rated higher than the level you selected unless you cancel the parental lock function.

For example, when you select level 7, discs rated higher than level 7 are locked out and cannot be played.

The Rating level is equivalent to the following U.S. movie ratings.

- Level 7: NC-17
- Level 6: R
- Level 4: PG 13
- Level 3: PG
- Level 1: G

Notes

- DVD-Video may or may not respond to the parental lock setting. This is not a defect in the DVD Changer. Make sure this function works with your DVD-Video.
- When the password already has been set, the screen for change of the entered password will be displayed. In that case, enter the password (See "Password" below).

Password



The password for rating setting, change, cancellation, etc. is set.

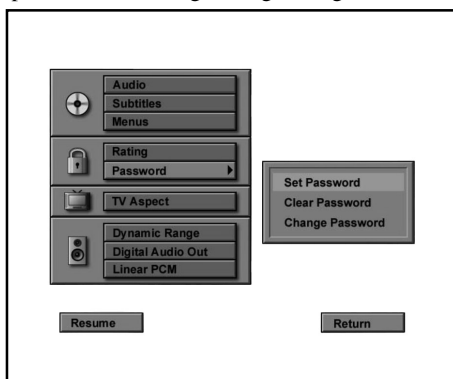

To input password

- 1 Select "Set Password".
- 2 Press the numeric buttons to enter password.

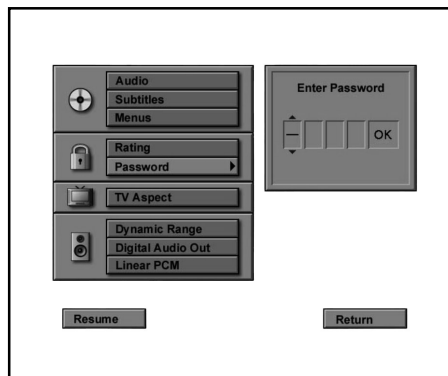

- 3 Select OK button and press **ENTER**. Confirm Password display appears below Enter Password display.

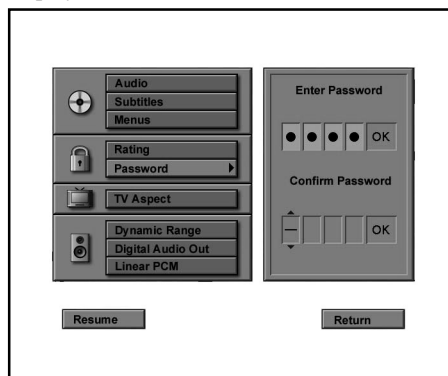

- 4 Press the numeric buttons to enter password.

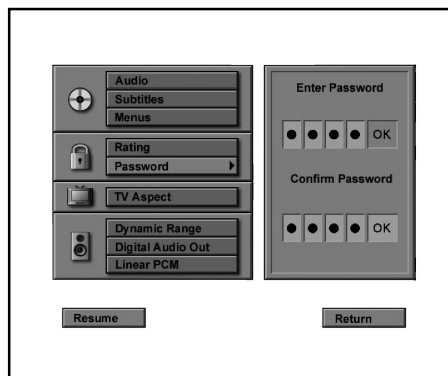

- 5 Select OK button and press **ENTER**.

Note

Be sure not to forget your password. If you should forget it, press CD PLAY button while holding down the DISC 4 button to clear the password. If the display on the unit disappears with this operation, press the POWER switch on the unit and then press it again to recover the display.

Customizing the Settings

Operation Setting (continued)

To change password

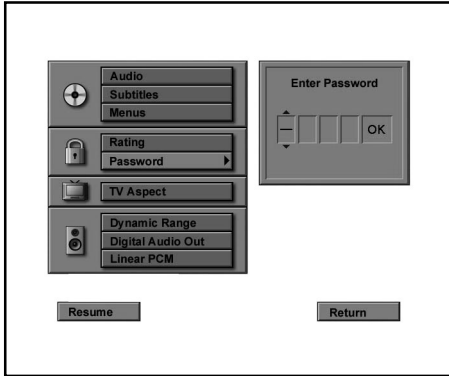

- 1 Press the numeric buttons to enter password.
- 2 Select OK button and press **ENTER**.
Password setup menu appears.

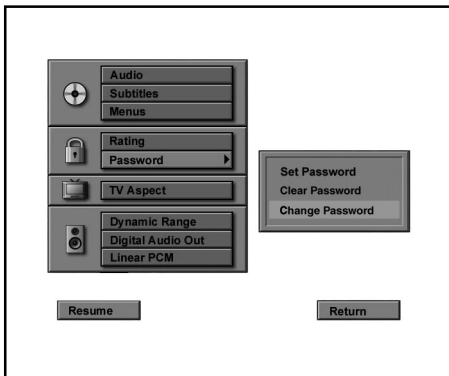

- 3 Select "Change Password".
Enter Password menu appears.
- 4 Press the numeric buttons to enter new password.
- 5 Select OK button and press **ENTER**.
Confirm Password display appears below Enter Password display.

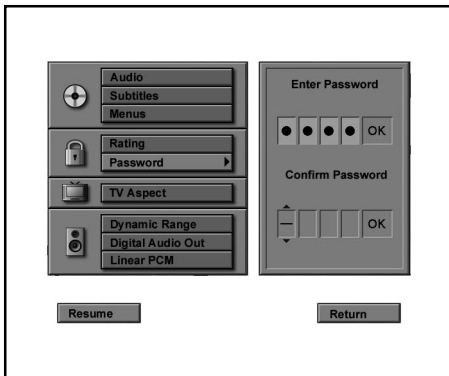

- 6 Press the numeric buttons to enter new password.

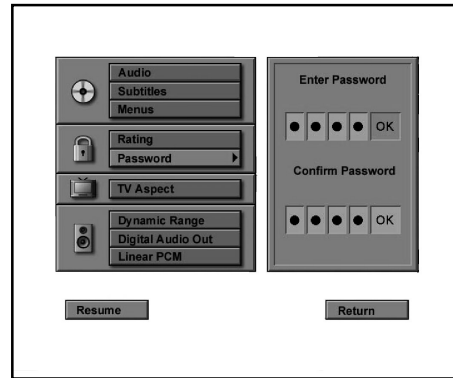

- 7 Select OK button and press **ENTER**.

To clear password

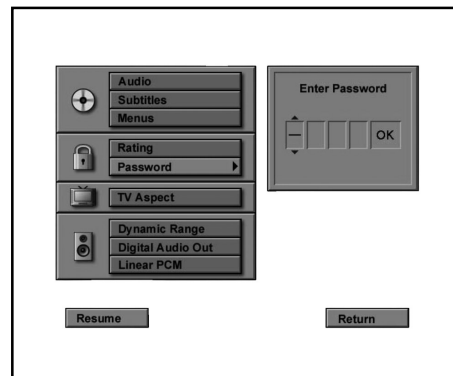

- 1 Press the numeric buttons to enter password.
- 2 Select OK button and press **ENTER**.
Password setup menu appears.

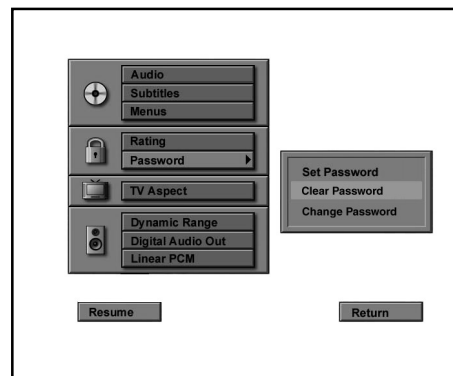

- 3 Select "Clear Password" and press **ENTER**.

Customizing the Settings



Picture-related setting

Picture Setting

TV Aspect



This sets the screen size (4:3 or 16:9 aspect ratio) according to the connected TV.

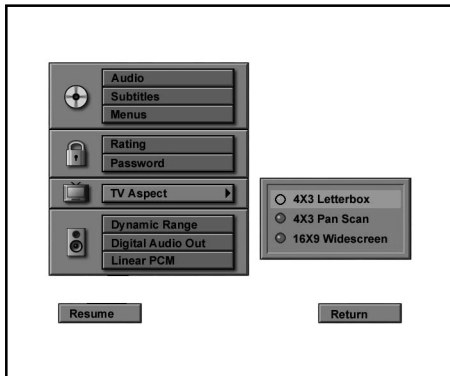

4 x 3 Letterbox:



Choose this setting if you would prefer to see movies in their original aspect ratio. You will see the entire frame of the movie, but it will occupy a smaller portion of the screen. This setting may result in the movie appearing with black bars at the top and bottom of the screen.

4 x 3 Pan Scan:



Choose this setting if you want the movie to fill the entire screen of your TV. You won't see part of the picture (particularly the right and left edge). Some disc produced in a wide screen format can't be cropped in this fashion, which means the black bars would appear at the top and bottom of the screen.

16 x 9 Widescreen:



Notes

- The displayable picture size is preset on each DVD-Video. Therefore, the playback picture of some DVD-Video may not conform to the picture size you select.
- When you play a DVD-Video recorded in the 4:3 picture size only, the playback picture always appears in the 4:3 picture size regardless of the TV shape setting.
- If you select "16:9 Widescreen" and you own a 4:3 TV set, the DVD playback picture will be horizontally distorted during playback. Images will appear to be horizontally compressed. Make sure the TV Shape conforms to the actual TV in use.



Audio output setting

Audio Setting

Dynamic Range



Dynamic Range setting allows you to "compress" the dynamic range of a DVD's sound track, so that you can lower the volume without losing extremely soft signals. This is especially useful when you are watching a movie late at night.

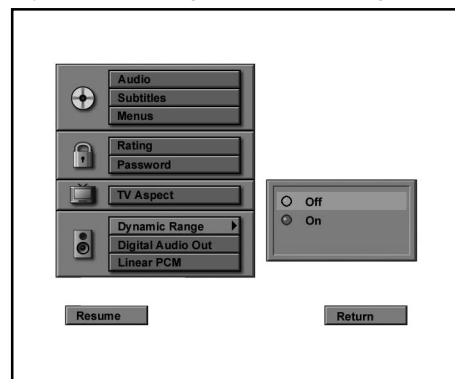

Off: Full dynamic range is maintained.

On: Dynamic range is reduced.

Notes

- This function works only during playback of Dolby Digital recorded discs.
- The level of Dynamic Range Reduction may differ depending on the DVD.

Customizing the Settings

Audio Setting (continued)

Digital Audio Out



This sets the type of audio output from the digital audio output jack.

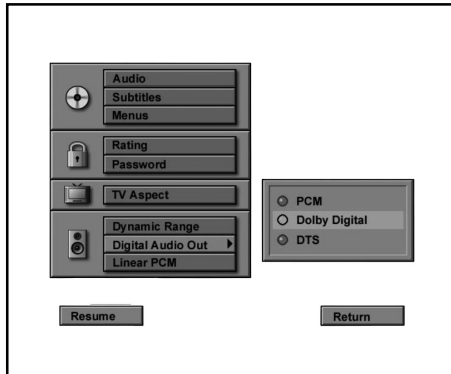

PCM: Select when connected to a 2 channel digital stereo amplifier (see page 16).

The DVD Changer outputs sounds in the PCM format when you play a DVD-Video disc recorded on the Dolby Digital.

The DVD Changer does not output sounds in the PCM format when you play a DVD-Video disc recorded on the DTS recording system.

Dolby Digital: Select when you connected to an amplifier equipped with a Dolby Digital decoder (see page 16).

The DVD Changer outputs digital audio information in the Dolby Digital format when you play a DVD-Video recorded in the Dolby Digital recording system.

The DVD Changer does not output sounds in the PCM format when you play a DVD-Video disc recorded on the DTS recording system.

DTS: Select when you connected to an amplifier equipped with a DTS decoder (see page 16).
The DVD Changer outputs digital audio information in the DTS format when you play a DVD-Video recorded in the DTS recording system.
The DVD Changer outputs sounds in the Dolby Digital format when you play a DVD-Video disc recorded on the Dolby Digital recording system.

Dolby Digital and DTS

The 5.1-channel digital surround format of DOLBY DIGITAL/DTS enables you to individually play five full-range (20 Hz-20 kHz) channels (left and right front, center, two surround channels) plus an LFE (Low Frequency Effect) channel for the low-range effect sound. It will create a realistic sound as heard in theaters and concert halls.

DOLBY DIGITAL Surround

DVD Video that have the  mark are recorded using this system.

DTS Surround

DVD Video and CD that have the  mark are recorded using this system.

Important: DTS information

If you set the Digital Audio Out setting to DTS, you must have your DVD Changer connected to a receiver or decoder with the DTS feature and the disc you play must support the DTS audio format. If you choose DTS and your receiver, decoder or disc doesn't support DTS, you won't hear any audio when you play the disc.

Linear PCM

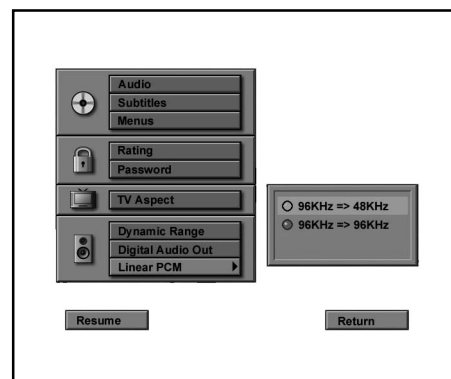

96KHz => 48KHz: Even in case of 96 kHz digital signal, the DVD Changer will deliver 48 kHz signal out.

96KHz => 96KHz: In case of 96 kHz digital signal, the DVD Changer will deliver 96 kHz signal out. In this case, your receiver should control 96 kHz signal.

Table of Languages

Table of Languages and Their Code No.

Code No.	Language
6566	Abkhazian
6565	Afar
6570	Afrikaans
8381	Albanian
6577	Ameharic
6582	Arabic
7289	Armenian
6583	Assamese
6588	Aymara
6590	Azerbaijani
6665	Bashkir
6985	Basque
6678	Bengali; Bangla
6890	Bhutani
6672	Bihari
6673	Bislama
6682	Breton
6671	Bulgarian
7789	Burmese
6669	Byelorussian
7577	Cambodian
6765	Catalan
9072	Chinese
6779	Corsican
7282	Croatian
6783	Czech
6865	Danish
7876	Dutch
6978	English
6979	Esperanto
6984	Estonian
7079	Faroese
7074	Fiji
7073	Finnish
7082	French
7089	Frisian
7176	Galician
7565	Georgian
6869	German
6976	Greek
7576	Greenlandic
7178	Guarani
7185	Gujarati
7265	Hausa
7387	Hebrew
7273	Hindi

Code No.	Language
7285	Hungarian
7383	Icelandic
7378	Indonesian
7365	Interlingua
7369	Interlingue
7375	Iunpiak
7165	Irish
7384	Italian
7465	Japanese
7487	Javanese
7578	Kannada
7583	Kashmiri
7575	Kazakh
8287	Kinyarwanda
7589	Kirghiz
8278	Kirundi
7579	Korean
7585	Kurdish
7679	Laothian
7665	Latin
7686	Latvian, Lettish
7678	Lingala
7684	Lithuanian
7775	Macedonian
7771	Malagasy
7783	Malay
7776	Malayalam
7784	Maltese
7773	Maori
7782	Marathi
7779	Moldavian
7778	Mongolian
7865	Naru
7869	Nepali
7879	Norwegian
7967	Occitan
7982	Oriya
7977	Oromo (Afan)
8065	Panjabi
8083	Pashto, Pushto
7065	Persian
8076	Polish
8084	Portuguese
8185	Quechua
8277	Rhaero-Romance
8279	Romanian

Code No.	Language
8285	Russian
8377	Samoaan
8371	Sangho
8365	Sanskrit
7168	Scots Gaelic
8382	Serbian
8372	Servo-Groatian
8384	Sesotho
8478	Setswana
8378	Shona
8368	Sindhi
8373	Singhalese
8383	Siswati
8375	Slovak
8376	Slovenian
8379	Somali
6983	Spanish
8385	Sundanese
8387	Swahili
8386	Swedish
8476	Tagalog
8471	Tajik
8465	Tamil
8484	Tatar
8469	Telugu
8472	Thai
6679	Tibetan
8473	Tigrinya
8479	Tonga
8483	Tsonga
8482	Turkish
8475	Turkmen
8487	Twi
8575	Ukrainian
8582	Urdu
8590	Uzbek
8673	Vietnamese
8679	Volapuk
6789	Welsh
8779	Wolof
8872	Xhosa
7473	Yiddish
8979	Yoruba
9085	Zulu

Troubleshooting

Check the following guide for the possible cause of a problem before contacting service. Refer also to the respective instruction manuals of the connected components and TV.

	Symptoms	Causes	Remedies	Pages
DVD Changer	The DVD Changer doesn't switch on.	<ul style="list-style-type: none"> The power cord is disconnected. The main power is set to OFF. There is external noise in the computer circuits of the DVD Changer. The AC fuse is blown. 	<ul style="list-style-type: none"> Check the connection of the power cord. Turn on the main power. Switch off the main power, then switch it on again. If not recovered, disconnect the power cord, then connect it again. Contact your nearest Onkyo service center. 	17 17 17 –
	The DVD Changer doesn't start playback.	<ul style="list-style-type: none"> No disc is inserted. The region number of the disc does not match that of the DVD Changer. An unplayable disc is inserted. The disc is placed upside down. The disc is not placed within the disc tray guide. The disc is dirty. The parental lock function is activated. 	<ul style="list-style-type: none"> Insert a disc. (Check that "DVD," "VCD," or "CD" is lit in the DVD Changer's display). See "1. Regional Restriction Codes (Region Number)" on page 4. Check the playable discs. Place the disc with the playback side down. Place the disc within the proper guide on the disc tray. Eject the disc and clean it. Deactivate the parental lock function or change the parental lock level. 	18 4 6 18 18 7 32
	Brightness is unstable or noise is visible on the playback picture.	<ul style="list-style-type: none"> Copy protection is activated. 	<ul style="list-style-type: none"> Connect the DVD Changer directly to the TV. Avoid connecting the DVD Changer to the TV through a VCR. 	14
	The playback picture is occasionally distorted.	<ul style="list-style-type: none"> The disc is dirty. It is in fast forward or fast reverse playback. 	<ul style="list-style-type: none"> Eject the disc and clean it. Sometimes a small amount of picture distortion may appear. This is not a malfunction. 	7 –
	Playback doesn't follow the course of the disc's programs.	<ul style="list-style-type: none"> The DVD Changer is in repeat playback mode, memory playback mode, or random playback mode, etc. 	<ul style="list-style-type: none"> Resume normal playback. 	18
	The picture from the DVD Changer doesn't appear on the TV screen.	<ul style="list-style-type: none"> The TV is not set to receive the output signals from the DVD Changer. The DVD Changer is not properly connected. 	<ul style="list-style-type: none"> Set the TV to the DVD Changer's input. Check the connections to the DVD Changer. 	– 14, 15
	No sound or inaccurate sound is reproduced.	<ul style="list-style-type: none"> A wrong sound signal conversion method (Digital Audio Out) is selected. The TV is not set to receive the output signals from the DVD Changer. The DVD Changer is not properly connected. 	<ul style="list-style-type: none"> Check the current sound signal conversion method, and select the right setting for "Digital Audio Out". Set the TV to the DVD Changer's input. Check the connections to the DVD Changer. 	35 – 14-16
	DVD disc cannot be played.	<ul style="list-style-type: none"> DVD disc cannot be played when the DVD Changer is set to CD PLAY mode. 	<ul style="list-style-type: none"> Press CD PLAY . 	26
	The buttons on the remote controller and DVD Changer do not operate.	<ul style="list-style-type: none"> Power supply fluctuations or other abnormalities such as static electricity may interrupt correct operation. 	<ul style="list-style-type: none"> Switch off the main power, then switch it on again. If not recovered, disconnect the power cord, then connect it again. 	17
Remote Controller	The buttons on the DVD Changer operate but the buttons on the remote controller do not operate.	<ul style="list-style-type: none"> No batteries are inserted in the remote controller. The batteries are worn out. The remote controller is not pointed at the remote sensor of the DVD Changer. The remote controller is too far from the DVD Changer. 	<ul style="list-style-type: none"> Insert new batteries. Replace with new batteries. Point the remote controller at the remote sensor of the DVD Changer. Operate the remote controller within 5 m (16 feet). 	9 9 9 9

Because the unit contains a microcomputer to provide advanced functions, it may malfunction due to external noise or static electricity. If this happens, press the POWER switch on the unit and then press it again after about five seconds.

Specifications

■ DVD Changer

Power supply	AC 120 V, 60 Hz
Power consumption	20 W
Weight	15.0 lbs
External dimensions	17 1/8" x 5 1/16" x 16 15/16" (W/H/D)
Signal system	NTSC
Frequency range (digital audio)	48 kHz sampling 4 Hz to 22 kHz 96 kHz sampling 4 Hz to 42 kHz
Signal-to-noise ratio (digital audio)	More than 98 dB
Audio dynamic range (digital audio)	More than 95 dB
Harmonic distortion (digital audio)	Less than 0.005 %
Wow and flutter	Below measurable level
Operating conditions	Temperature: 5°C to 35°C (41°F to 95°F), Operation status: Horizontal

■ Outputs

Video output	1.0 V (p-p), 75 Ω, negative sync., pin jack × 1
S-video output	(Y) 1.0 V (p-p), 75 Ω, negative sync. (C) 0.286 V (p-p), 75 Ω, Mini DIN 4-pin × 1
Component video output	(Y) 1.0 V (p-p), 75 Ω, negative sync., pin jack × 1 (P _B)/(P _R) 0.7 V (p-p), 75 Ω, pin jack × 2
Audio output (digital output Optical)	Optical connector × 1
Audio output (digital output Coaxial)	0.5 V (p-p), 75 Ω, pin jack × 1
Audio output (analog output)	2.0 V (rms), 320 Ω, pin jack (L, R) × 2

■ Supplied Accessories

Audio/video connection cable	1
Remote controller (RC-469DV)	1
Batteries (size AAA/R3)	2

Specifications and features are subject to change without notice.

Memo



ONKYO CORPORATION

Sales & Product Planning Div. : 2-1, Nisshin-cho, Neyagawa-shi, OSAKA 572-8540, JAPAN
Tel: 072-831-8111 Fax: 072-833-5222

ONKYO U.S.A. CORPORATION

18 Park Way, Upper Saddle River, N.J. 07458, U.S.A.
Tel: 201-785-2600 Fax: 201-785-2650 <http://www.onkyousa.com>

ONKYO EUROPE ELECTRONICS GmbH

Industriestrasse 20, 82110 Germering, GERMANY
Tel: 089-849-320 Fax: 089-849-3265 E-mail: info@onkyo.de

ONKYO CHINA LIMITED

Units 2102-2107, Metroplaza Tower I, 223 Hing Fong Road, Kwai Chung,
N.T., HONG KONG Tel: 852-2429-3118 Fax: 852-2428-9039



Free Manuals Download Website

<http://myh66.com>

<http://usermanuals.us>

<http://www.somanuals.com>

<http://www.4manuals.cc>

<http://www.manual-lib.com>

<http://www.404manual.com>

<http://www.luxmanual.com>

<http://aubethermostatmanual.com>

Golf course search by state

<http://golfingnear.com>

Email search by domain

<http://emailbydomain.com>

Auto manuals search

<http://auto.somanuals.com>

TV manuals search

<http://tv.somanuals.com>