

# ONKYO®

## 7.1ch Home Theater System

# HT-S6200

**AV Receiver (HT-R670)**

**Speaker Package (HTP-670)**

**Front Speakers (SKF-670)**

**Center Speaker (SKC-670)**

**Surround Speakers (SKR-670)**

**Surround Back Speakers (SKB-670)**

**Powered Subwoofer (SKW-770)**

**Dock for iPod (UP-A1)**

## Instruction Manual

Thank you for purchasing an Onkyo 7.1ch Home Theater System. Please read this manual thoroughly before making connections and plugging in the unit. Following the instructions in this manual will enable you to obtain optimum performance and listening enjoyment from your new 7.1ch Home Theater System.

Please retain this manual for future reference.

## Contents

Introduction .....2

Connection ..... 19

Turning On & First Time Setup ...40

Basic Operations.....49

Using the Listening Modes .....61

Advanced Setup ..... 68

Zone 2.....80

Controlling Other Components...84

Others.....93



## WARNING:

TO REDUCE THE RISK OF FIRE OR ELECTRIC SHOCK, DO NOT EXPOSE THIS APPARATUS TO RAIN OR MOISTURE.

## CAUTION:

TO REDUCE THE RISK OF ELECTRIC SHOCK, DO NOT REMOVE COVER (OR BACK). NO USER-SERVICEABLE PARTS INSIDE. REFER SERVICING TO QUALIFIED SERVICE PERSONNEL.



**WARNING**  
RISK OF ELECTRIC SHOCK  
DO NOT OPEN

**AVIS**  
RISQUE DE CHOC ELECTRIQUE  
NE PAS OUVRIR



The lightning flash with arrowhead symbol, within an equilateral triangle, is intended to alert the user to the presence of uninsulated "dangerous voltage" within the product's enclosure that may be of sufficient magnitude to constitute a risk of electric shock to persons.



The exclamation point within an equilateral triangle is intended to alert the user to the presence of important operating and maintenance (servicing) instructions in the literature accompanying the appliance.

## Important Safety Instructions

1. Read these instructions.
2. Keep these instructions.
3. Heed all warnings.
4. Follow all instructions.
5. Do not use this apparatus near water.
6. Clean only with dry cloth.
7. Do not block any ventilation openings. Install in accordance with the manufacturer's instructions.
8. Do not install near any heat sources such as radiators, heat registers, stoves, or other apparatus (including amplifiers) that produce heat.
9. Do not defeat the safety purpose of the polarized or grounding-type plug. A polarized plug has two blades with one wider than the other. A grounding type plug has two blades and a third grounding prong. The wide blade or the third prong are provided for your safety. If the provided plug does not fit into your outlet, consult an electrician for replacement of the obsolete outlet.
10. Protect the power cord from being walked on or pinched particularly at plugs, convenience receptacles, and the point where they exit from the apparatus.
11. Only use attachments/accessories specified by the manufacturer.
12. Use only with the cart, stand, tripod, bracket, or table specified by the manufacturer, or sold with the apparatus. When a cart is used, use caution when moving the cart/apparatus combination to avoid injury from tip-over.  

PORTABLE CART WARNING  
S3125A
13. Unplug this apparatus during lightning storms or when unused for long periods of time.
14. Refer all servicing to qualified service personnel. Servicing is required when the apparatus has been damaged in any way, such as power-supply cord or plug is damaged, liquid has been spilled or objects have fallen into the apparatus, the apparatus has been exposed to rain or moisture, does not operate normally, or has been dropped.
15. Damage Requiring Service  
Unplug the apparatus from the wall outlet and refer servicing to qualified service personnel under the following conditions:
  - A. When the power-supply cord or plug is damaged,
  - B. If liquid has been spilled, or objects have fallen into the apparatus,
  - C. If the apparatus has been exposed to rain or water,
  - D. If the apparatus does not operate normally by following the operating instructions. Adjust only those controls that are covered by the operating instructions as an improper adjustment of other controls may result in damage and will often require extensive work by a qualified technician to restore the apparatus to its normal operation,
  - E. If the apparatus has been dropped or damaged in any way, and
  - F. When the apparatus exhibits a distinct change in performance this indicates a need for service.
16. Object and Liquid Entry  
Never push objects of any kind into the apparatus through openings as they may touch dangerous voltage points or short-out parts that could result in a fire or electric shock.  
The apparatus shall not be exposed to dripping or splashing and no objects filled with liquids, such as vases shall be placed on the apparatus.  
Don't put candles or other burning objects on top of this unit.
17. Batteries  
Always consider the environmental issues and follow local regulations when disposing of batteries.
18. If you install the apparatus in a built-in installation, such as a bookcase or rack, ensure that there is adequate ventilation.  
Leave 20 cm (8") of free space at the top and sides and 10 cm (4") at the rear. The rear edge of the shelf or board above the apparatus shall be set 10 cm (4") away from the rear panel or wall, creating a flue-like gap for warm air to escape.

# Precautions

---

- 1. Recording Copyright**—Unless it's for personal use only, recording copyrighted material is illegal without the permission of the copyright holder.
- 2. AC Fuse**—The AC fuse inside the unit is not user-serviceable. If you cannot turn on the unit, contact your Onkyo dealer.
- 3. Care**—Occasionally you should dust the unit all over with a soft cloth. For stubborn stains, use a soft cloth dampened with a weak solution of mild detergent and water. Dry the unit immediately afterwards with a clean cloth. Don't use abrasive cloths, thinners, alcohol, or other chemical solvents, because they may damage the finish or remove the panel lettering.
- 4. Power**  
**WARNING**  
BEFORE PLUGGING IN THE UNIT FOR THE FIRST TIME, READ THE FOLLOWING SECTION CAREFULLY.  
AC outlet voltages vary from country to country. Make sure that the voltage in your area meets the voltage requirements printed on the unit's rear panel (e.g., AC 230 V, 50 Hz or AC 120 V, 60 Hz).  
The power cord plug is used to disconnect this unit from the AC power source. Make sure that the plug is readily operable (easily accessible) at all times.  
For North American model  
Pressing the [ON/STANDBY] button to select Standby mode does not fully shutdown the unit. If you do not intend to use the unit for an extended period, remove the power cord from the AC outlet.
- 5. Preventing Hearing Loss**  
**Caution**  
Excessive sound pressure from earphones and headphones can cause hearing loss.
- 6. Batteries and Heat Exposure**  
**Warning**  
Batteries (battery pack or batteries installed) shall not be exposed to excessive heat as sunshine, fire or the like.
- 7. Never Touch this Unit with Wet Hands**—Never handle this unit or its power cord while your hands are wet or damp. If water or any other liquid gets inside this unit, have it checked by your Onkyo dealer.
- 8. Handling Notes**
  - If you need to transport this unit, use the original packaging to pack it how it was when you originally bought it.
  - Do not leave rubber or plastic items on this unit for a long time, because they may leave marks on the case.
  - This unit's top and rear panels may get warm after prolonged use. This is normal.
  - If you do not use this unit for a long time, it may not work properly the next time you turn it on, so be sure to use it occasionally.

## For U.S. models

### FCC Information for User

#### CAUTION:

The user changes or modifications not expressly approved by the party responsible for compliance could void the user's authority to operate the equipment.

#### NOTE:

This equipment has been tested and found to comply with the limits for a Class B digital device, pursuant to Part 15 of the FCC Rules. These limits are designed to provide reasonable protection against harmful interference in a residential installation.

This equipment generates, uses and can radiate radio frequency energy and, if not installed and used in accordance with the instructions, may cause harmful interference to radio communications. However, there is no guarantee that interference will not occur in a particular installation. If this equipment does cause harmful interference to radio or television reception, which can be determined by turning the equipment off and on, the user is encouraged to try to correct the interference by one or more of the following measures:

- Reorient or relocate the receiving antenna.
- Increase the separation between the equipment and receiver.
- Connect the equipment into an outlet on a circuit different from that to which the receiver is connected.
- Consult the dealer or an experienced radio/TV technician for help.

## For Canadian Models

**NOTE:** THIS CLASS B DIGITAL APPARATUS COMPLIES WITH CANADIAN ICES-003.

For models having a power cord with a polarized plug:

**CAUTION:** TO PREVENT ELECTRIC SHOCK, MATCH WIDE BLADE OF PLUG TO WIDE SLOT, FULLY INSERT.

## Modèle pour les Canadien

**REMARQUE:** CET APPAREIL NUMÉRIQUE DE LA CLASSE B EST CONFORME À LA NORME NMB-003 DU CANADA.

Sur les modèles dont la fiche est polarisée:

**ATTENTION:** POUR ÉVITER LES CHOCS ÉLECTRIQUES, INTRODUIRE LA LAME LA PLUS LARGE DE LA FICHE DANS LA BORNE CORRESPONDANTE DE LA PRISE ET POUSSER JUSQU'AU FOND.

# Speaker Precautions

---

## Placement

---

- The subwoofer cabinet is made out of wood and is therefore sensitive to extreme temperatures and humidity, do not put it in locations subject to direct sunlight or in humid places, such as near an air conditioner, humidifier, bathroom, or kitchen.
- Do not put water or other liquids close to the speakers. If liquid is spilled over the speakers, the drive units may be damaged.
- Speakers should only be placed on sturdy, flat surfaces that are free from vibration. Putting them on uneven or unstable surfaces, where they may fall and cause damage, will affect the sound quality.
- Subwoofer is designed to be used in the upright vertical position only. Do not use it in the horizontal or tilted position.
- If the unit is used near a turntable, CD player or DVD/BD player, howling or slipping of sound may occur. To prevent this, move the unit away from the turntable, CD player or DVD/BD player, otherwise lower the unit's output level.

## Using Close to a TV or Computer

---

TVs and computer monitors are magnetically sensitive devices and as such are likely to suffer discoloration or picture distortion when conventional speakers are placed nearby. In such situations, try moving the speakers away from your TV or monitor. If discoloration should occur, turn off your TV or monitor, wait 15 to 30 minutes, and then turn it back on again. This normally activates the degaussing function, which neutralizes the magnetic field, thereby removing any discoloration effects. Note that discoloration can also be caused by a magnet or demagnetizing tool that's too close to your TV or monitor.

## Input Signal Warning

---

The speakers can handle the specified input power when used for normal music reproduction. If any of the following signals are fed to them, even if the input power is within the specified rating, excessive current may flow in the speaker coils, causing burning or wire breakage:

1. Interstation noise from an untuned FM radio.
2. Sound from fast-forwarding a cassette tape.
3. High-pitched sounds generated by an oscillator, electronic musical instrument, and so on.
4. Amplifier oscillation.
5. Special test tones from audio test CDs and so on.
6. Thumps and clicks caused by connecting or disconnecting audio cables (always turn off your amplifier before connecting or disconnecting cables).
7. Microphone feedback.

# Package Contents

---

Make sure you have the following items:

## AV receiver HT-R670

---

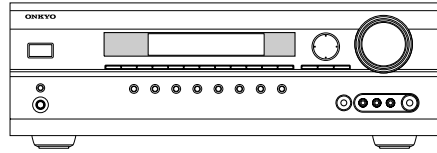

## HT-R670

---

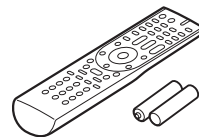

## Remote controller and two batteries (AA/R6)

---

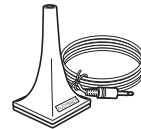

## Speaker setup microphone

---



## Indoor FM antenna

---

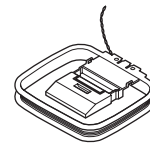

## AM loop antenna

---

- \* In catalogs and on packaging, the letter at the end of the product name indicates the color. Specifications and operation are the same regardless of color.

## Package Contents—Continued

### Speaker Package HTP-670

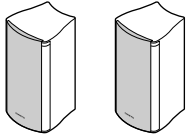

Front speakers  
(SKF-670)

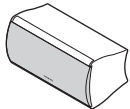

Center speaker  
(SKC-670)

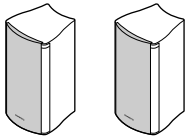

Surround speakers  
(SKR-670)

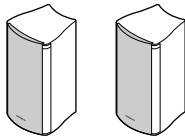

Surround back  
speakers  
(SKB-670)

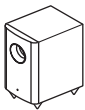

Powered Subwoofer  
(SKW-770)

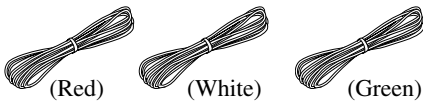

(Red)

(White)

(Green)

Speaker cable for front speakers and center speaker  
Front speakers 11 ft (3.5 m)  
Center speaker 10 ft (3.0 m)

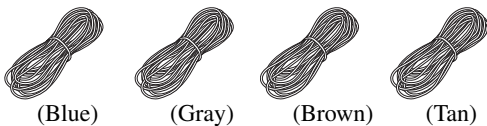

(Blue)

(Gray)

(Brown)

(Tan)

Speaker cables for surround and surround back  
speakers 26 ft (8 m)



RCA cable for subwoofer connection 10 ft (3 m)

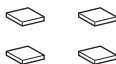

4 floor pads for the subwoofer

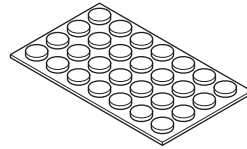

28 rubber stoppers



Power-plug adapter (SKW-770)

Only supplied in certain countries. Use this adapter if your AC outlet does not match with the plug on the AV receiver's power cord (adapter varies from country to country).

\*How to mount the AC plug:

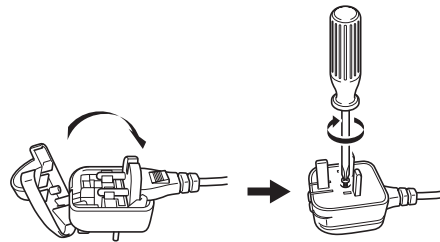

### Dock for iPod UP-A1

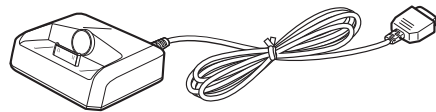

\* In catalogs and on packaging, the letter at the end of the product name indicates the color. Specifications and operation are the same regardless of color.

# Contents

Introduction	
Important Safety Instructions.....	2
Precautions.....	3
Speaker Precautions.....	4
Package Contents.....	4
AV receiver HT-R670.....	4
Speaker Package HTP-670.....	5
Dock for iPod UP-A1.....	5
Features.....	7
AV Receiver HT-R670.....	7
Speaker Package HTP-670.....	7
Dock for iPod UP-A1.....	8
Multiroom Capability.....	9
Front & Rear Panels.....	10
Front Panel.....	10
Display.....	11
Rear Panel.....	12
Speaker Package.....	14
Subwoofer (SKW-770).....	14
Front, Center, Surround, Surround Back speakers (SKF-670, SKC-670, SKR-670, SKB-670).....	15
Remote Controller.....	16
Installing the Batteries.....	16
Aiming the Remote Controller.....	16
Controlling the AV receiver.....	17
About Home Theater.....	18
Enjoying Home Theater.....	18

Connection	
Connecting the AV receiver.....	19
Connecting Your Speakers.....	19
Wall Mounting.....	21
Using the Rubber Stoppers for a More Stable Platform.....	21
Using the Floor Pads for Subwoofer.....	21
Bi-amping the Front Speakers.....	22
Connecting Antenna.....	23
About AV Connections.....	25
Connecting Both Audio & Video.....	26
Which Connections Should I Use?.....	26
Connecting Components with HDMI.....	27
Connecting a TV or Projector.....	29
Connecting a DVD/BD Player.....	30
Connecting a VCR or DVR for Playback.....	31
Connecting a VCR or DVR for Recording.....	32
Connecting a Satellite, Cable, Terrestrial Set-top box, or Other Video Source.....	33
Connecting a Camcorder, Game Console, or Other Device.....	34
Connecting a Portable Audio player.....	34
Connecting a CD Player or Turntable.....	35
Connecting a Cassette, CDR, MiniDisc, or DAT Recorder.....	36
Connecting an RI Dock.....	37
Connecting a Dock with the Universal Port connector.....	38
Connecting Onkyo <b>RI</b> Components.....	39
Connecting the Power Cord.....	39

Turning On & First Time Setup	
Turning On the AV receiver.....	40
Turning On and Standby.....	40
First Time Setup.....	41
HDMI Input Setup.....	41
Component Video Input Setup.....	42
Digital Input Setup.....	43
Speaker Settings.....	44
Changing the Input Display.....	45
Audyssey 2EQ™ Room Correction and Speaker Setup.....	46

Basic Operations	
Basic Operations.....	49
Basic AV receiver Operation.....	49
Adjusting the Bass & Treble.....	50
Displaying Source Information.....	50
Setting the Display Brightness.....	51
Muting the AV receiver.....	51
Using the Sleep Timer.....	51
Using Headphones.....	51
Using the Music Optimizer.....	52
Specifying the Digital Signal Format.....	52
Listening to the Radio.....	53
AM/FM Frequency Step Setup.....	53
Using the Tuner.....	54
Presetting AM/FM Stations.....	56
UP-A1 series Dock for iPod/iPhone.....	57
About the UP-A1 series Dock.....	57
Compatible iPod/iPhone models.....	57
Putting Your iPod/iPhone in the Dock.....	57
Function Overview.....	57
Controlling iPod/iPhone.....	58
Recording.....	60

Using the Listening Modes	
Using the Listening Modes.....	61
Selecting Listening Modes.....	61
Listening Modes Available for Each Source Format.....	62
About the Listening Modes.....	66

Advanced Setup	
Advanced Setup.....	68
Common Procedures in Setup Menu.....	68
Speaker Setup.....	68
Audio Adjust.....	71
Using the Audio Settings.....	73
Assigning Listening Modes to Input Sources.....	75
Source Setup.....	76
Miscellaneous (Volume) Setup.....	77
Hardware Setup.....	78

Zone 2	
Zone 2.....	80
Connecting Zone 2.....	80
Setting the Powered Zone 2.....	81
Using Zone 2.....	82

Controlling Other Components	
Controlling Other Components.....	84
Preprogrammed Remote Control Codes.....	84
Entering Remote Control Codes.....	84
Remote Control Codes for Onkyo Components Connected via <b>RI</b> .....	85
Resetting REMOTE MODE Buttons.....	85
Resetting the Remote Controller.....	85
Controlling a TV.....	86
Controlling a DVD Player, or DVD Recorder.....	87
Controlling a VCR or PVR.....	88
Controlling a Satellite Receiver or Cable Receiver.....	89
Controlling a CD Player.....	90
Controlling an RI Dock.....	91
Controlling a Cassette Recorder.....	92

Others	
Troubleshooting.....	93
Specifications.....	97

\* To reset the AV receiver to its factory defaults, turn it on and, while holding down the [VCR/DVR] button, press the [ON/STANDBY] button (see page 93).

# Features

---

## AV Receiver HT-R670

### Amplifier

---

- 130 Watts/Channel @ 6 ohms
- 160 Watts/Channel @ 6 ohms (JEITA)
- WRAT-Wide Range Amplifier Technology
- High-Current Low-Impedance Drive
- Optimum Gain Volume Circuitry
- H.C.P.S. (High Current Power Supply) Massive High Power Transformer

### Processing

---

- Dolby TrueHD<sup>\*1</sup> and DTS<sup>\*2</sup>-HD Master Audio Decoding
- Dolby Pro Logic IIz<sup>\*1</sup> (with "Front High" Direction Mode)
- Pure Audio Mode (Asian models)
- Direct Mode
- Music Optimizer<sup>\*3</sup> for Compressed Music
- CinemaFILTER
- Non-Scaling Configuration
- A-Form Listening Mode Memory
- 192 kHz/24-bit D/A Converters
- Powerful and Highly Accurate 32-bit DSP Processing

### Connections

---

- 4 HDMI<sup>\*4</sup> Inputs and 1 Output (ver.1.3a to Support Deep Color, x.v. Color\*, Lip Sync, DTS-HD Master Audio, DTS-HD High Resolution Audio, Dolby TrueHD, Dolby Digital Plus, DSD and Multichannel PCM)
- Onkyo **RIHD** for System Control
- HDTV-Ready Component Video Switching (2 Inputs/1 Output)
- Front "Portable" Input for iPod\* and MP3 Players
- Universal Port for the Dock for the iPod\* / HD Radio<sup>TM</sup><sup>\*5</sup> Dock (North American models)
- 4 Digital Inputs (2 Optical/2 Coaxial)
- Color-Coded Banana Plug Speaker Posts
- Powered Zone 2 and Zone 2 Line Out
- Subwoofer Pre Out
- Bi-Amp Capability for Music and Movie Sound Effects

### Miscellaneous

---

- 40 AM/FM Presets
- Audyssey Dynamic EQ<sup>TM</sup><sup>\*6</sup> for Loudness Correction
- Audyssey 2EQ<sup>TM</sup><sup>\*6</sup> to Correct Room Acoustic Problems
- Audyssey Dynamic Volume<sup>\*6</sup> to Maintain Optimal Listening Level and Dynamic Range
- Crossover Adjustment (40/50/60/70/80/90/100/120/150/200 Hz)
- A/V Sync Control Function (up to 100 ms in 10 ms Steps)
- Theater Dimensional Virtual Surround Function<sup>\*7</sup>
- Compatible with RI Dock for iPod\*
- Preprogrammed **RI**-Compatible Remote

## Speaker Package HTP-670

### SKF-670 L/R 2-Way Front Speakers

- 4" (10 cm) cone woofer
- 1" (2.5 cm) Balanced dome tweeter
- Max. input power:130 W
- Gloss Finished
- 6-ohm impedance
- Color-coded speaker terminals and speaker cable

### SKC-670 2-Way Center Speaker

- 4" (10 cm) cone woofer
- 1" (2.5 cm) Balanced dome tweeter
- Max. input power:130 W
- Gloss Finished
- 6-ohm impedance
- Color-coded speaker terminals and speaker cable

### SKR-670 L/R Full-Range Surround Speakers

### SKB-670 L/R Full-Range Surround Back Speakers

- 3-1/4" (8 cm) Full-Range Speaker
- Max. input power:130 W
- Gloss Finished
- 6-ohm impedance
- Color-coded speaker terminals and speaker cable

### SKW-770 Bass Reflex Powered Subwoofer

- 10" (25 cm) cone
- Output Level Control
- Max. power:290 W

### Dock for iPod UP-A1

- Easily links all iPhone, iPod Touch (1G, 2G), iPod Classic, iPod (4G, 5G), iPod nano (1G, 2G, 3G, 4G), iPod mini with Onkyo A/V Systems



Manufactured under license from Dolby Laboratories. “Dolby”, “Pro Logic” and the double-D symbol are trademarks of Dolby Laboratories.



Manufactured under license under U.S. Patent #'s: 5,451,942; 5,956,674; 5,974,380; 5,978,762; 6,226,616; 6,487,535; 7,212,872; 7,333,929; 7,392,195; 7,272,567 & other U.S. and worldwide patents issued & pending. DTS is a registered trademark and the DTS logos, Symbol, DTS-HD and DTS-HD Master Audio are trademarks of DTS, Inc. ©1996-2008 DTS, Inc. All Rights Reserved.

\*3 Music Optimizer™ is a trademark of Onkyo Corporation.



HDMI, the HDMI logo and High Definition Multimedia Interface are trademarks or registered trademarks of HDMI Licensing, LLC.

\*5 HD Radio™ and the HD Radio Ready logo are proprietary trademarks of iBiquity Digital Corporation. To receive HD Radio broadcasts, you must install an Onkyo UP-HT1 HD Radio tuner module (sold separately).



Manufactured under license from Audyssey Laboratories. U.S. and foreign patents pending. Audyssey 2EQ™, Audyssey Dynamic Volume™ and Audyssey Dynamic EQ™ are trademarks of Audyssey Laboratories.



Theater-Dimensional is a trademark of Onkyo Corporation.

- \* iPod is trademark of Apple Inc., registered in the U.S. and other countries.
- \* iPhone is trademark of Apple Inc.
- \* “Made for iPod” means that an electronic accessory has been designed to connect specifically to iPod and has been certified by the developer to meet Apple performance standards. “Works with iPhone” means that an electronic accessory has been designed to connect specifically to iPhone and has been certified by the developer to meet Apple performance standards. Apple is not responsible for the operation of this device or its compliance with safety and regulatory standards.
- \* “x.v.Color” is a trademark of Sony Corporation.



# Multiroom Capability

You can use two speaker systems with this AV receiver—a surround-sound speaker system (up to 7.1 channels) in your main listening room, a stereo speaker system in a second room, or Zone 2, as we call it. And, you can select a different audio source for each room.

**Main Room:** In your main listening room, you can enjoy up to 7.1-channel playback (see page 18).

You can enjoy the various listening modes such as Dolby and DTS (see pages 61–67).

\* While Powered Zone 2 is being used, playback is reduced to 5.1-channels (see page 80).

**Zone 2:** In your Zone 2 room, you can enjoy 2-channel stereo playback (see page 80).

\* The listening modes cannot be used with Zone 2.

## Main Room

### Front high left and right speakers (Optional)

- \* When you connect the front high left and right speakers, prepare it separately.
- \* While Powered Zone 2 is being used, nothing is output by these speakers (page 81).
- \* Front high and surround back speakers produce no sound at the same time.

### Front left and right speakers

### Surround back left and right speakers

- \* While Powered Zone 2 is being used, nothing is output by these speakers (page 81).
- \* Front high and surround back speakers produce no sound at the same time.

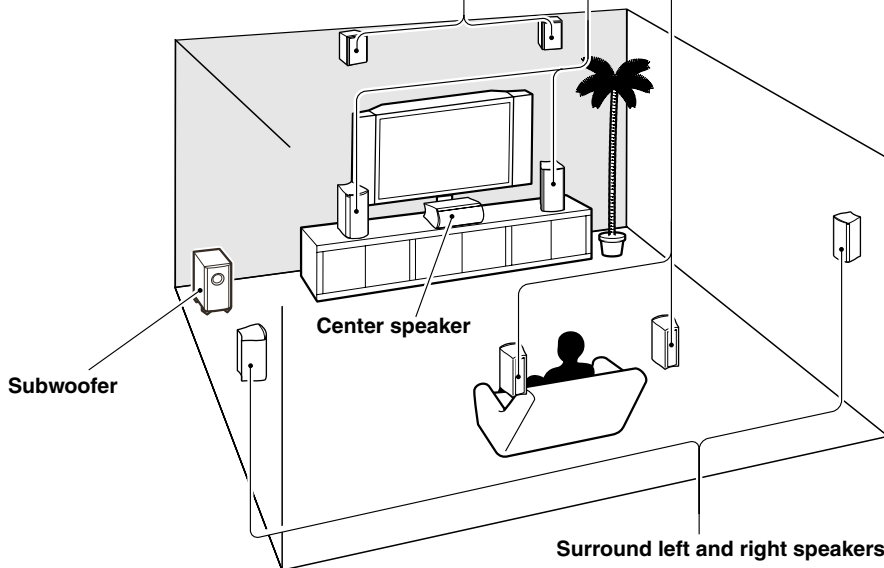

## Zone 2 Room

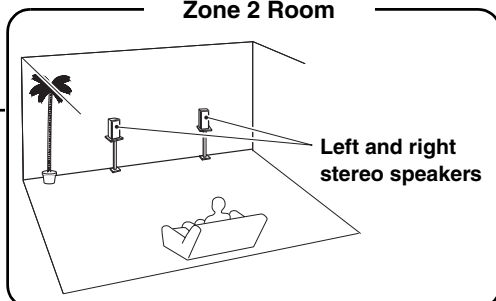

# Front & Rear Panels

## Front Panel

### North American models

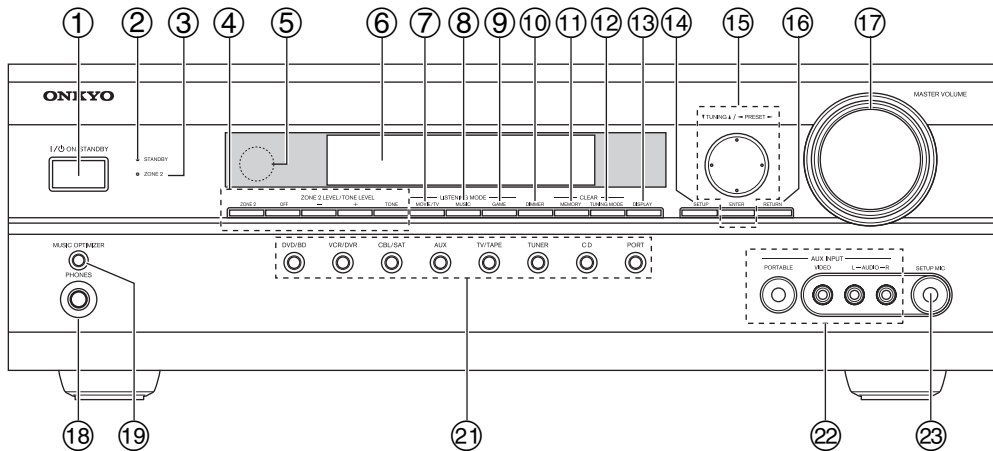

### Asian models

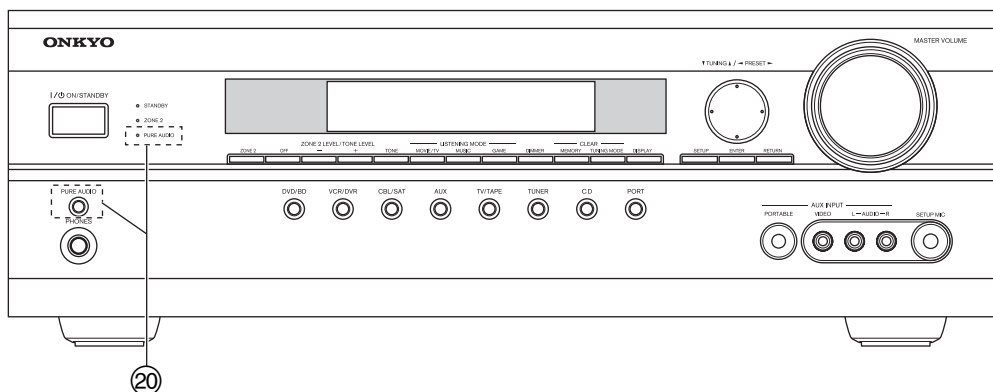

The actual front panel has various logos printed on it. They are not shown here for clarity.

The page numbers in parentheses show where you can find the main explanation for each item.

- ① **ON/STANDBY button (40)**  
Sets the AV receiver to On or Standby.
- ② **STANDBY indicator (40)**  
Lights up when the AV receiver is on Standby and flashes while a signal is being received from the remote controller.
- ③ **ZONE 2 indicator (82)**  
Flashes when Zone 2 is being set. Lights up when Zone 2 is on.
- ④ **ZONE 2 LEVEL/TONE LEVEL buttons**  
**ZONE 2 and OFF buttons (82)**  
The [ZONE 2] button is used to turn on the output of Zone 2.  
The [OFF] button is used to turn off the output of Zone 2.
- ⑤ **Remote-control sensor (16)**  
Receives control signals from the remote controller.
- ⑥ **Display**  
See "Display" on page 11.
- ⑦ **MOVIE/TV button (61)**  
Selects the listening modes intended for use with movies and TV.
- ⑧ **MUSIC button (61)**  
Selects the listening modes intended for use with music.
- [-] & [+] buttons (50, 83)**  
Used to adjust the tone (bass and treble) and the level of Zone 2.
- TONE button (50)**  
Used to select either bass or treble.

## Front & Rear Panels—Continued

For detailed information, see the pages in parentheses.

- ⑨ **GAME button (61)**  
Selects the listening modes intended for use with video games.
- ⑩ **DIMMER button (51)**  
Adjusts the display brightness.
- ⑪ **MEMORY button (56)**  
Used when storing or deleting radio presets.
- ⑫ **TUNING MODE button (54)**  
Selects the Auto or Manual tuning mode for AM and FM radio.
- ⑬ **DISPLAY button (50)**  
Displays various information about the currently selected input source.
- ⑭ **SETUP button**  
Opens and closes the setup menus.
- ⑮ **TUNING, PRESET, Arrow, and ENTER buttons**  
When AM or FM is selected, the TUNING [▲]/[▼] buttons are used for radio tuning, and the PRESET [◀]/[▶] buttons are used to select radio presets (see pages 54, 56). With the setup menus, they work as arrow buttons and are used to select and set items. The [ENTER] button is also used with the setup menus.
- ⑯ **RETURN button**  
Selects the previously displayed setup menu.
- ⑰ **MASTER VOLUME control (49)**  
Sets the volume of the AV receiver to Min, 1 through 79, or Max.
- ⑱ **PHONES jack (51)**  
This 1/4-inch phone jack is for connecting a standard pair of stereo headphones for private listening.
- ⑲ **MUSIC OPTIMIZER button (52) (North American models)**  
Turns the Music Optimizer on or off.
- ⑳ **PURE AUDIO button and indicator (61) (Asian models)**  
Selects the Pure Audio listening mode. The indicator lights up when this mode is selected. Pressing this button again selects the previous listening mode.
- ㉑ **Input selector buttons (49)**  
Select the following input sources: DVD/BD, VCR/DVR, CBL/SAT, AUX, TV/TAPE, TUNER, CD, PORT.
- ㉒ **AUX INPUT (34, 60)**  
Used to connect a camcorder, game console, and so on. There are input jacks for composite video and analog audio.
- PORTABLE (34):**  
Used to connect a portable Audio Player.
- ㉓ **SETUP MIC (46)**  
The Audyssey 2EQ™ Room Correction and Speaker Setup microphone connects here.

## Display

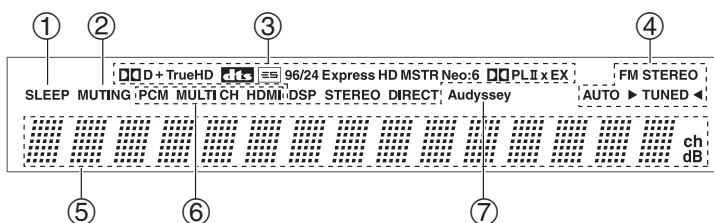

For detailed information, see the pages in parentheses.

- ① **SLEEP indicator (51)**  
Lights up when the Sleep function has been set.
- ② **MUTING indicator (51)**  
Flashes while the AV receiver is muted.
- ③ **Listening mode and format indicators (61)**  
Show the selected listening mode and audio input signal format.
- ④ **Tuning indicators (54)**  
**FM STEREO (54):**  
Lights up when tuned to a stereo FM station.  
**AUTO (54):**  
Lights up when Auto Tuning mode is selected for AM or FM radio. Goes off when Manual Tuning mode is selected.
- TUNED (54):**  
Lights up when tuned to a radio station.
- ⑤ **Message area**  
Displays various information.
- ⑥ **Audio input indicators**  
Indicate the type of audio input that's selected as the audio source: PCM, MULTI CH, or HDMI.
- ⑦ **Audyssey indicator (47, 70)**  
Flashes during Audyssey 2EQ™ Room Correction and Speaker Setup. Lights up when the "Equalizer Settings" is set to "Audyssey".

Rear Panel

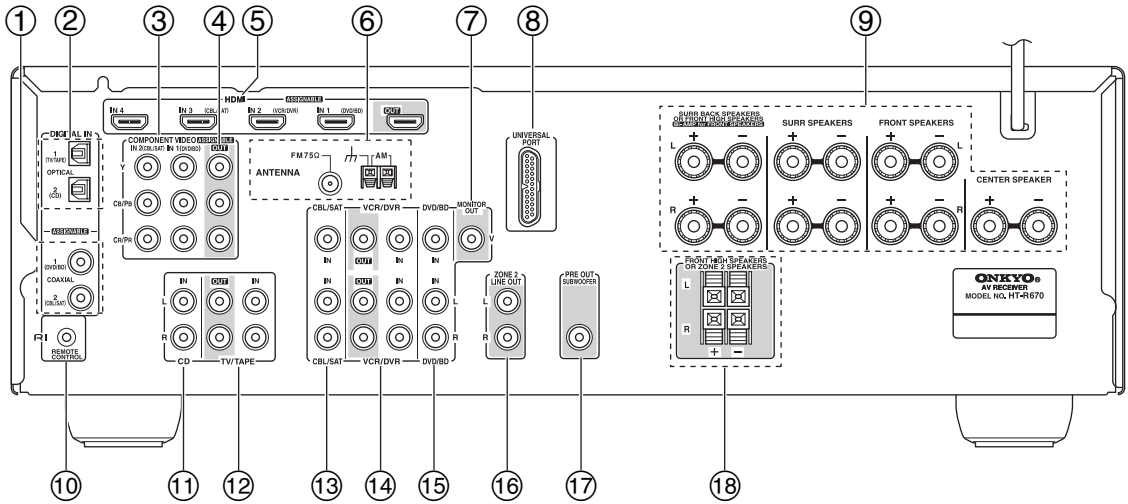

① **DIGITAL IN COAXIAL 1 and 2**

These coaxial digital audio inputs are for connecting components with a coaxial digital audio output, such as a CD player or DVD/BD player. They're assignable, which means you can assign each one to an input selector to suit your setup. See "Digital Input Setup" on page 43.

② **DIGITAL IN OPTICAL 1 and 2**

These optical digital audio inputs are for connecting components with an optical digital audio output, such as a CD player or DVD/BD player. They're assignable, which means you can assign each one to an input selector to suit your setup. See "Digital Input Setup" on page 43.

③ **COMPONENT VIDEO IN 1 and 2**

These RCA component video inputs are for connecting components with a component video output, such as a DVD/BD player, DVD/BD recorder, or DVR (digital video recorder). They're assignable, which means you can assign each one to an input selector to suit your setup. See "Component Video Input Setup" on page 42.

④ **COMPONENT VIDEO OUT**

This RCA component video output is for connecting a TV or projector with a component video input.

⑤ **HDMI IN 1–4 and OUT**

HDMI (High Definition Multimedia Interface) connections carry digital audio and digital video. The HDMI inputs are for connecting components with an HDMI output, such as a DVD/BD player, DVD/BD recorder, or DVR (digital video recorder). They're assignable, which means you can assign each one to an input selector to suit your setup. See "HDMI Input Setup" on page 41. The HDMI outputs are for connecting a TV or projector with an HDMI input.

⑥ **AM and FM ANTENNA**

The AM push terminals are for connecting an AM antenna. The FM jack is for connecting an FM antenna.

⑦ **MONITOR OUT**

The composite video jack should be connected to a video input on your TV or projector.

⑧ **UNIVERSAL PORT**

This jack is for connecting the component with the Universal Port connector such as UP-A1 series Dock.

⑨ **FRONT L/R, CENTER, SURR L/R, and SURR BACK L/R SPEAKERS**

These terminal posts are for connecting the front L/R, center, surround L/R, and surround back L/R speakers. The FRONT L/R and SURR BACK L/R terminal posts can be used with front speakers and surround back speakers, respectively, or used to bi-amp front Speakers. See "Bi-amping the Front Speakers" on page 22. The SURR BACK L/R terminals can be used to connect the front high L/R speakers. See "Speaker Settings" on page 44.

- ⑩ **RI REMOTE CONTROL**  
This **RI** (Remote Interactive) jack can be connected to the **RI** jack on another **RI**-capable Onkyo component for remote and system control. To use **RI**, you must make an analog audio connection (RCA) between the AV receiver and the other component, even if they are connected digitally.
- ⑪ **CD IN**  
This analog audio input is for connecting a CD player's analog audio output.
- ⑫ **TV/TAPE IN/OUT**  
These analog audio input and output jacks are for connecting a recorder with an analog audio input and output, such as a cassette deck, MD recorder, etc.
- ⑬ **CBL/SAT IN**  
A cable or satellite receiver can be connected here. There is composite video input jack for connecting the video signal, and there are analog audio input jacks for connecting the audio signal.
- ⑭ **VCR/DVR IN/OUT**  
A video component, such as a VCR or DVR, can be connected here for recording and playback. There is composite video input and output jack for connecting the video signal, and there are analog audio input jacks for connecting the audio signal.
- ⑮ **DVD/BD IN**  
This input is for connecting a DVD/BD player. There is composite video input jack for connecting the video signal.
- ⑯ **ZONE 2 LINE OUT L/R**  
These analog audio outputs can be connected to the line inputs on amplifiers in Zone 2.
- ⑰ **SUBWOOFER PRE OUT**  
This analog audio output can be connected to a powered subwoofer.
- ⑱ **FRONT HIGH L/R speakers**  
These terminals are for connecting the front high L/R speakers.  
The FRONT HIGH L/R terminal can be used with front high speakers respectively, or used to connect the speakers in Zone 2.  
See "Connecting Zone 2" on page 80.

See pages 19–39 for hookup information.

# Speaker Package

## Subwoofer (SKW-770)

For detailed information, see the pages in parentheses.

### ■ Front

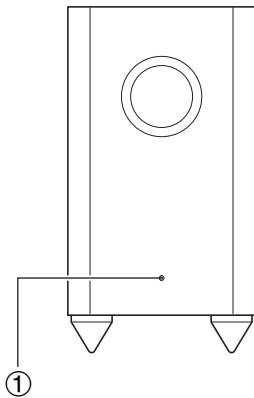

### ■ Rear

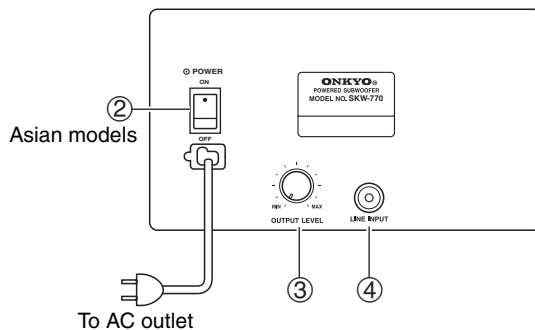

### ① STANDBY/ON indicator

Red: Subwoofer in standby mode  
Blue: Subwoofer on

With the Auto Standby function, the SKW-770 automatically turns on when an input signal is detected in Standby mode. When there's no input signal for a while, the SKW-770 automatically enters Standby mode.

### ② POWER switch (Asian models)

Press this switch to the ON position to turn on the power. Press it to the OFF position to turn off the power.

### ③ OUTPUT LEVEL control (49)

This control is used to adjust the volume of the subwoofer.

### ④ LINE INPUT (20)

This RCA input should be connected to the subwoofer pre out on the AV receiver with supplied RCA cable.

### Note:

The Auto Standby function turns the subwoofer on when the input signal exceeds a certain level. If the Auto Standby function does not work reliably, try slightly increasing or decreasing the subwoofer output level on the AV receiver (page 70).

### Front, Center, Surround, Surround Back speakers (SKF-670, SKC-670, SKR-670, SKB-670)

#### ■ Rear

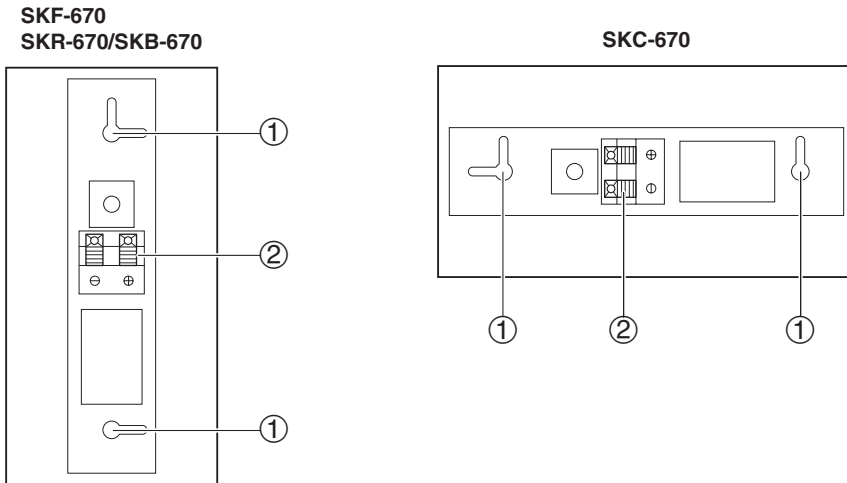

① **Keyhole slots**

These keyhole slots can be used to wall-mount the speaker. See page 21 for mounting instructions.

② **Speaker terminals**

These push terminals are for connecting the speaker to the HT-R670 with the supplied speaker cables. The supplied speaker cables are color-coded for easy identification. Simply connect each cable to the same-colored positive speaker terminal.

# Remote Controller

## Installing the Batteries

- 1 To open the battery compartment, press the small lever and remove the cover.

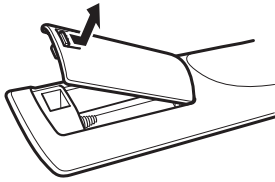

- 2 Insert the two supplied batteries (AA/R6) in accordance with the polarity diagram inside the battery compartment.

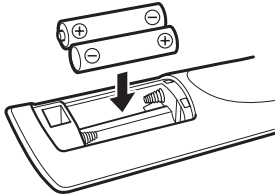

- 3 Replace the cover and push it shut.

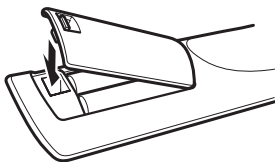

### Notes:

- If the remote controller doesn't work reliably, try replacing the batteries.
- Don't mix new and old batteries or different types of batteries.
- If you intend not to use the remote controller for a long time, remove the batteries to prevent damage from leakage or corrosion.
- Expired batteries should be removed as soon as possible to prevent damage from leakage or corrosion.

## Aiming the Remote Controller

When using the remote controller, point it toward the AV receiver's remote control sensor, as shown below.

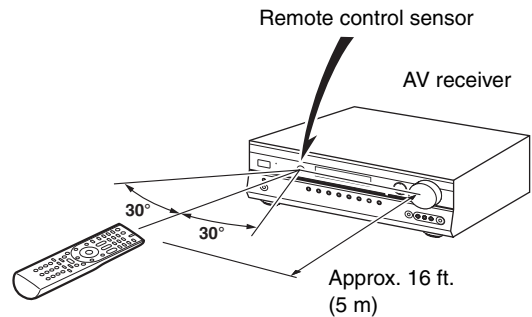

### Notes:

- The remote controller may not work reliably if the AV receiver is subjected to bright light, such as direct sunlight or inverter-type fluorescent lights. Keep this in mind when installing.
- If another remote controller of the same type is used in the same room, or the AV receiver is installed close to equipment that uses infrared rays, the remote controller may not work reliably.
- Don't put anything on top of the remote controller, such as a book or magazine, because a button may be pressed continuously, thereby draining the batteries.
- The remote controller may not work reliably if the AV receiver is installed in a rack behind colored glass doors. Keep this in mind when installing.
- The remote controller will not work if there's an obstacle between it and the AV receiver's remote control sensor.
- When the remote control codes have been registered and you want to operate another component (page 84), or when you want to operate an Onkyo component without **RI** connection, point the remote controller at the other component to use it.
- When you want to operate an Onkyo component with **RI** connection or an **RIHD**-compatible component connected via HDMI (pages 86, 87), point the remote controller at the AV receiver's remote control sensor.



## Controlling the AV receiver

To control the AV receiver, press the **[RECEIVER]** button to select Receiver mode.

You can also use the remote controller to control your DVD/BD player, CD player, and other components. See page 84 for more details.

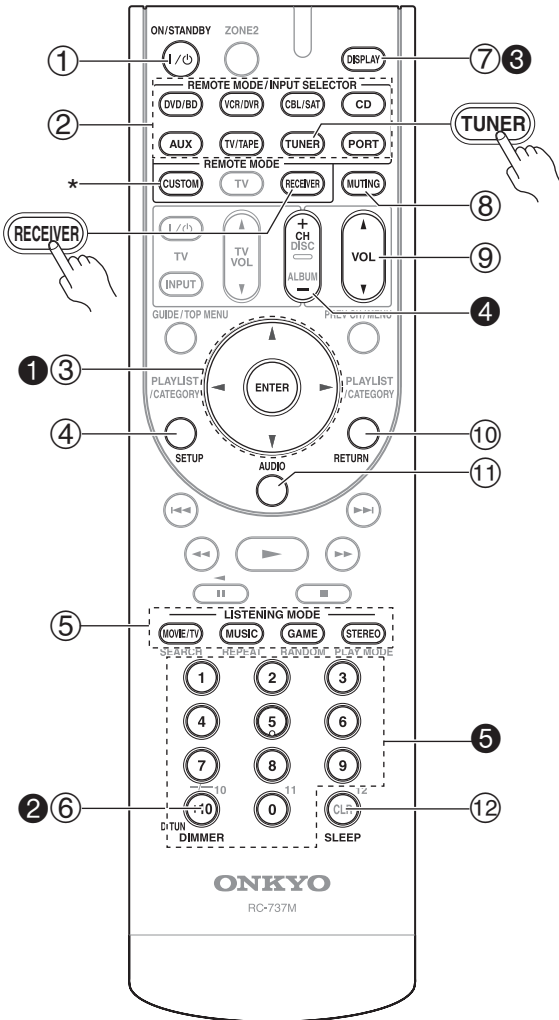

For detailed information, see the pages in parentheses.

- ① **ON/STANDBY button (40)**  
Sets the AV receiver to On or Standby.
- ② **REMOTE MODE/INPUT SELECTOR buttons (49, 58, 86–92)**  
Selects the remote controller modes and the input sources.
- ③ **Arrow [▲]/[▼]/[◀]/[▶] and ENTER buttons**  
Used to select and adjust settings.

- ④ **SETUP button**  
Used to change settings.
- ⑤ **LISTENING MODE buttons (61)**  
Used to select the listening modes.
- ⑥ **DIMMER button (51)**  
Adjusts the display brightness.
- ⑦ **DISPLAY button (50)**  
Displays information about the current input source.
- ⑧ **MUTING button (51)**  
Mutes or unmutes the AV receiver.
- ⑨ **VOL [▲]/[▼] button (49)**  
Adjusts the volume of the AV receiver regardless of the currently selected remote controller mode.
- ⑩ **RETURN button**  
Returns to the previous display when changing settings.
- ⑪ **AUDIO button (73)**  
Used to change audio settings.  
When the “AudioTVOut” setting is set to “On” (page 78), this button is disabled.
- ⑫ **SLEEP button (51)**  
Used with the Sleep function.

### ■ Controlling the tuner

To control the AV receiver’s tuner, press the **[TUNER]** (or **[RECEIVER]**) button.

You can select AM or FM by pressing the **[TUNER]** button repeatedly.

- ① **Arrow [▲]/[▼] buttons**  
Used to tune into radio stations.
- ② **D.TUN button (55)**  
Selects the Direct tuning mode.
- ③ **DISPLAY button (55)**  
Displays information about the band, frequency, preset number, and so on.
- ④ **CH +/- button (56)**  
Selects radio presets.
- ⑤ **Number buttons (55)**  
Used to select radio stations directly in the Direct tuning mode. Also you can select a preset directly.

\* To control component, you must first enter remote control code.

For details on entering a remote control code for a different component, see page 84.

### Note:

An Onkyo cassette recorder connected via **RI** can also be controlled in Receiver mode (see page 92).

# About Home Theater

## Enjoying Home Theater

Thanks to the AV receiver's superb capabilities, you can enjoy surround sound with a real sense of movement in your own home—just like being in a movie theater or concert hall. You can enjoy DVDs featuring Dolby Digital or DTS. With analog or digital TV, you can enjoy Dolby Pro Logic IIx, DTS Neo:6, or Onkyo's original DSP listening modes.

### Front left and right speakers

These output the overall sound. Their role in a home theater is to provide a solid anchor for the sound image. They should be positioned facing the listener at about ear level, and equidistant from the TV. Angle them inward so as to create a triangle, with the listener at the apex.

### Front high left and right speakers (Optional)

These speakers are necessary to enjoy Dolby Pro Logic IIz Height, etc. They enhance significantly the spatial experience. Position them at least 3.3 ft (100 cm) above the front left and right speakers (and as high as possible). Although it is acceptable to place left and right at an angle slightly wider than the front left and right speakers. Ideally they should be positioned directly above the front left and right speakers. Front high and surround back speakers produce no sound at the same time. When you connect the front high left and right speakers, prepartate it separately.

### Center speaker

This speaker enhances the front left and right speakers, making sound movements distinct and providing a full sound image. In movies it's used mainly for dialog. Position it close to your TV facing forward at about ear level, or at the same height as the front left and right speakers.

### Subwoofer

The subwoofer handles the bass sounds of the LFE (Low-Frequency Effects) channel. The volume and quality of the bass output from your subwoofer will depend on its position, the shape of your listening room, and your listening position. In general, a good bass sound can be obtained by installing the subwoofer in a front corner, or at one-third the width of the wall, as shown.

**Tip:** To find the best position for your subwoofer, while playing a movie or some music with good bass, experiment by placing your subwoofer at various positions within the room, and choose the one that provides the most satisfying results.

### Surround back left and right speakers

These speakers are necessary to enjoy Dolby Digital EX, DTS-ES Matrix, DTS-ES Discrete, etc. They enhance the realism of surround sound and improve sound localization behind the listener. Position them behind the listener about 2–3 ft (60–100 cm) above ear level. Front high and surround back speakers produce no sound at the same time.

### Surround left and right speakers

These speakers are used for precise sound positioning and to add realistic ambience. Position them at the sides of the listener, or slightly behind, about 2–3 ft (60–100 cm) above ear level. Ideally they should be equidistant from the listener.

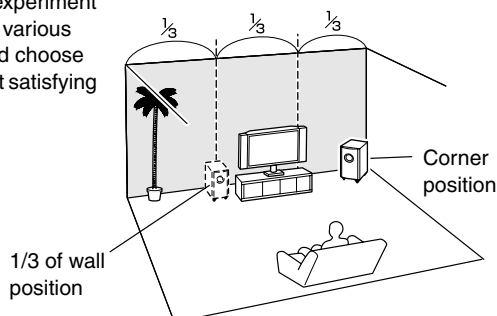

# Connecting the AV receiver

## Connecting Your Speakers

### Speaker Configuration

For 7.1-channel surround-sound playback, you need seven speakers and a powered subwoofer.

The following table shows which channels you should use based on the number of speakers you have.

Number of speakers:	2	3	4	5	6	7	7	8	9
Front left	✓	✓	✓	✓	✓	✓	✓	✓	✓
Front right	✓	✓	✓	✓	✓	✓	✓	✓	✓
Center		✓		✓	✓	✓	✓	✓	✓
Surround left			✓	✓	✓	✓	✓	✓	✓
Surround right			✓	✓	✓	✓	✓	✓	✓
Surround back <sup>*1</sup>					✓			✓	
Surround back left						✓			✓
Surround back right						✓			✓
Front high left							✓	✓	✓
Front high right							✓	✓	✓

\*1 If you're using only one surround back speaker, connect it to the power amplifier's left terminals.

No matter how many speakers you use, a powered subwoofer is recommended for a powerful and solid bass.

To get the best from your surround-sound system, you must set the speaker settings. You can do this automatically (see page 46) or manually (see page 68).

#### Notes:

- Front high and surround back speakers produce no sound at the same time.
- When you connect the front high left and right speakers, separate it separately.

### Speaker Connection Precautions

Read the following before connecting your speakers:

- **North American models:** You can connect speakers with an impedance of between 6 and 16 ohms. If you use speakers with a lower impedance, and use the amplifier at high volume levels for a long period of time, the built-in amp protection circuit may be activated.
- **Asian models:** You can connect speakers with an impedance of between 4 and 16 ohms. If the impedance of any of the connected speakers is 4 ohms or more, but less than 6 ohms, be sure to set the minimum speaker impedance to "4 ohms" (see page 44). If you use speakers with a lower impedance, and use the amplifier at high volume levels for a long period of time, the built-in amp protection circuit may be activated.
- Disconnect the power cord from the wall outlet before making any connections.
- Read the instructions supplied with your speakers.
- Pay close attention to speaker wiring polarity. Connect positive (+) terminals to only positive (+) terminals, and negative (-) terminals to only negative (-) terminals. If you get them the wrong way around, the sound will be out of phase and will sound unnatural.
- Unnecessarily long or very thin speaker cables may affect the sound quality and should be avoided.
- Be careful not to short the positive and negative wires. Doing so may damage the AV receiver.
- Don't connect more than one cable to each speaker terminal. Doing so may damage the AV receiver.
- Don't connect a speaker to several terminals.

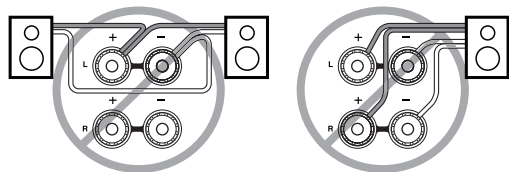
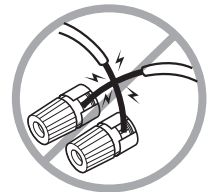

# Connecting the AV receiver—Continued

## Connecting the Speaker Cables

### Terminal posts

**1** Strip 1/2"-5/8" (12-15 mm) of insulation from the ends of the speaker cables. (Supplied speaker cables are already stripped.)

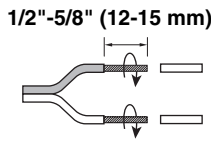

**2** Unscrew the terminal. Fully insert the bare wire, making sure that it's touching the threaded shaft in the center. Screw the terminal tight.

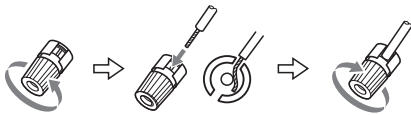

### Push terminals

**1** Strip 3/8"-1/2" (10-12 mm) of insulation from the ends of the speaker cables, and twist the bare wires tightly, as shown.

3/8"-1/2" (10-12 mm)

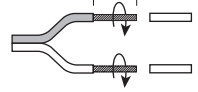

**2** While pressing the lever, insert the wire into the hole, and then release the lever.

Make sure that the terminals are gripping the bare wires, not the insulation.

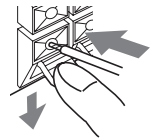

The following illustration shows which speaker should be connected to each pair of terminals for up to 7.1-channel playback.

If you're using only one surround back speaker, connect it to the power amplifier's left terminals.

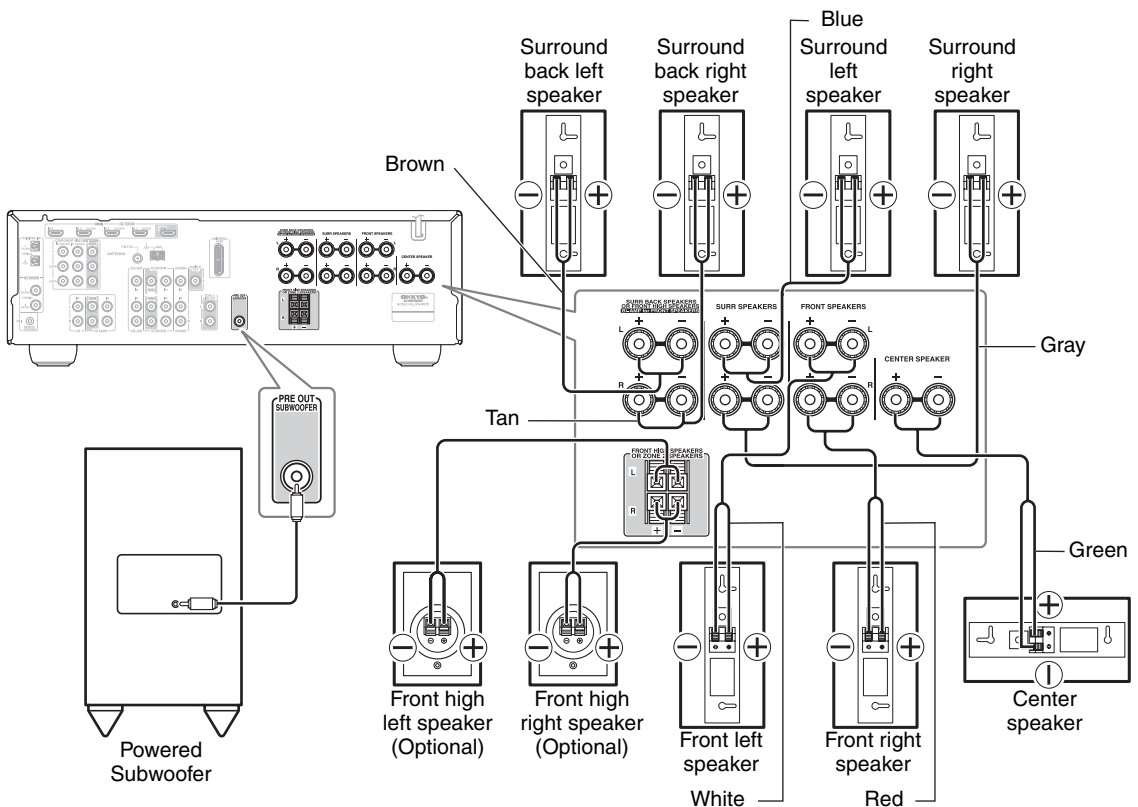

### Notes:

- The speakers are configured by using the "Speaker Settings" on page 44 and "Speaker Setup" on page 68.
- When you connect the front high left and right speakers, prepare it separately.

## Connecting the AV receiver—Continued

### Wall Mounting

The speakers can easily be wall mounted by using the keyhole slots.

To mount the front or surround speakers vertically, use the keyhole slot shown to hang each speaker on a screw that's securely screwed into the wall.

#### Front speakers (SKF-670)

#### Surround speakers/Surround back speakers (SKR-670/SKB-670)

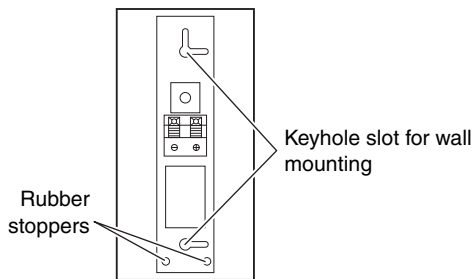

To mount the center speaker horizontally, use the two keyhole slots shown to hang each speaker on two screws that are securely screwed into the wall.

#### Center speaker (SKC-670)

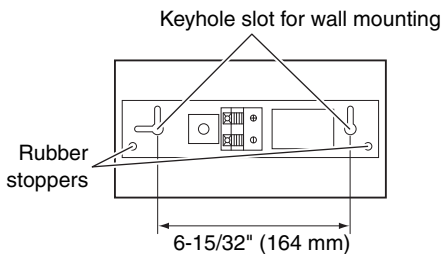

#### Tip:

If the center speaker is tilted, loosen the screw on the declined side to move upward so that the speaker could be adjusted vertically.

#### Caution:

A mounting screw's ability to support a speaker depends on how well it's anchored to the wall. If you have hollow walls, screw each mounting screw into a stud. If there are no studs, or the walls are solid, use suitable wall anchors. Use screws with a head diameter of 5/16" (8 mm) or less and a shank diameter of 5/32" (4 mm) or less. With hollow walls, use a cable/pipe detector to check for any power cables or water pipes before making any holes.

Leave a gap of between 5/32" (4 mm) and 5/16" (8 mm) between the wall and the base of the screw head, as shown. (We recommend that you consult a home installation professional.)

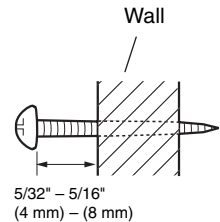

### Using the Rubber Stoppers for a More Stable Platform

We recommend using the provided rubber stoppers to achieve the best possible sound from your speakers. The rubber stoppers prevent the speakers from moving, providing a more stable platform.

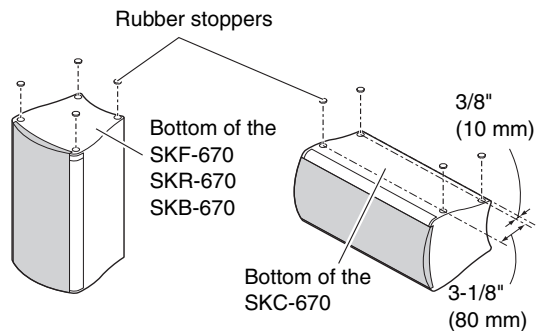

### Using the Floor Pads for Subwoofer

If the subwoofer is placed on a hard floor (wood, vinyl, tile, etc.) and playback is very loud, the subwoofer's feet may damage the flooring. To prevent this, place the supplied pads underneath the subwoofer's feet. The pads also provide a stable base for the subwoofer.

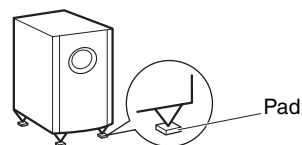

## Bi-amping the Front Speakers

The FRONT L/R and SURR BACK L/R terminal posts can be used with front speakers and surround back speakers respectively, or bi-amped to provide separate tweeter and woofer feeds for front speakers, providing improved bass and treble performance.

- When bi-amping is used, the AV receiver is able to drive up to 5.1 speakers in the main room.
- For bi-amping, the FRONT L/R terminal posts connect to the front speakers' woofer terminals. And the SURR BACK L/R terminal posts connect to the front speakers' tweeter terminals.
- Once you've completed the bi-amping connections shown below and turned on the AV receiver, you must set the "Sp Type" setting to "Bi-Amp" to enable bi-amping (see page 44).

### Important:

- **When making the bi-amping connections, be sure to remove the jumper bars that link the speakers' tweeter (high) and woofer (low) terminals.**
- Bi-amping can only be used with speakers that support bi-amping. Refer to your speaker manual.

## Bi-amping Speaker Hookup

- 1 Connect the AV receiver's FRONT R positive (+) terminal to the right speaker's positive (+) woofer (low) terminal. And connect the AV receiver's FRONT R negative (-) terminal to the right speaker's negative (-) woofer (low) terminal.
- 2 Connect the AV receiver's SURR BACK R positive (+) terminal to the right speaker's positive (+) tweeter (high) terminal. And connect the AV receiver's SURR BACK R negative (-) terminal to the right speaker's negative (-) tweeter (high) terminal.
- 3 Connect the AV receiver's FRONT L positive (+) terminal to the left speaker's positive (+) woofer (low) terminal. And connect the AV receiver's FRONT L negative (-) terminal to the left speaker's negative (-) woofer (low) terminal.
- 4 Connect the AV receiver's SURR BACK L positive (+) terminal to the left speaker's positive (+) tweeter (high) terminal. And connect the AV receiver's SURR BACK L negative (-) terminal to the left speaker's negative (-) tweeter (high) terminal.

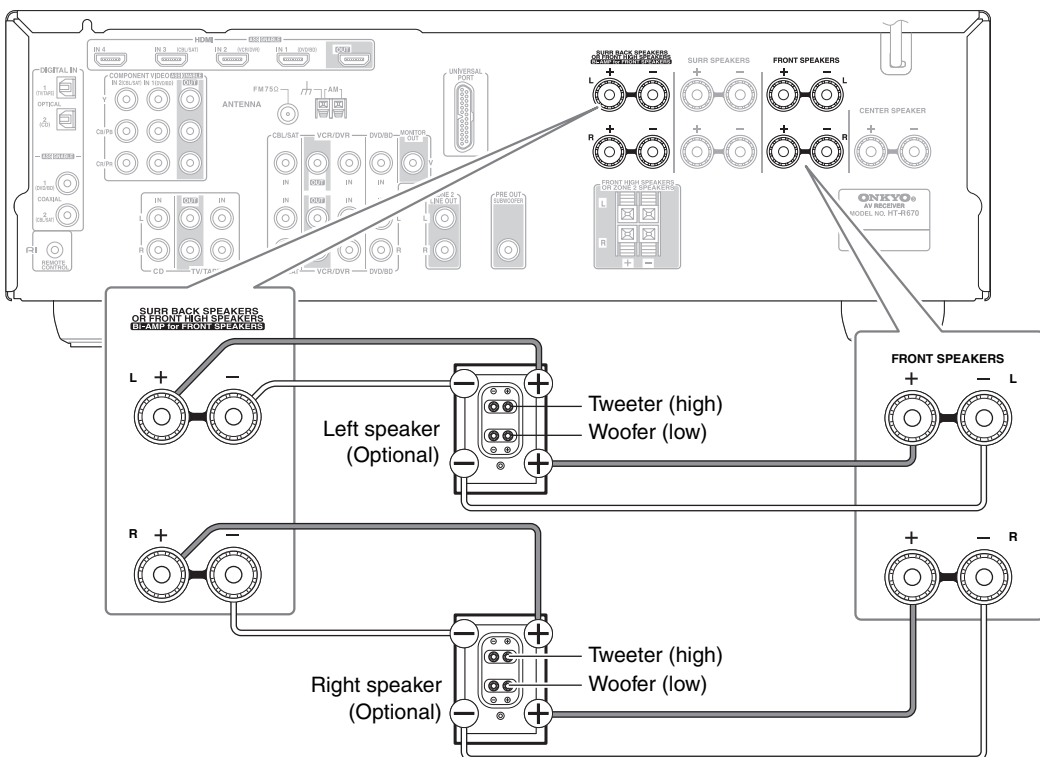

## Connecting the AV receiver—Continued

### Connecting Antenna

This section explains how to connect the supplied indoor FM antenna and AM loop antenna, and how to connect commercially available outdoor FM and AM antennas. The AV receiver won't pick up any radio signals without any antenna connected, so you must connect the antenna to use the tuner.

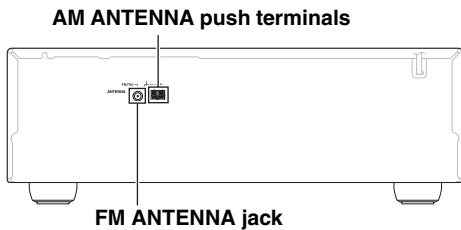

### Connecting the Indoor FM Antenna

The supplied indoor FM antenna is for indoor use only.

#### 1 Attach the FM antenna, as shown.

##### ■ North American models

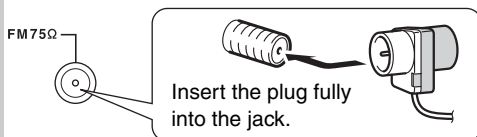

##### ■ Asian models

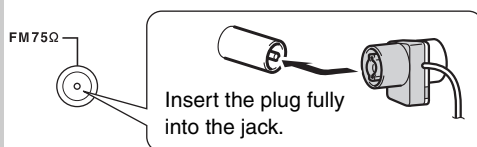

Once your AV receiver is ready for use, you'll need to tune into an FM radio station and adjust the position of the FM antenna to achieve the best possible reception.

#### 2 Use thumbtacks or something similar to fix the FM antenna into position.

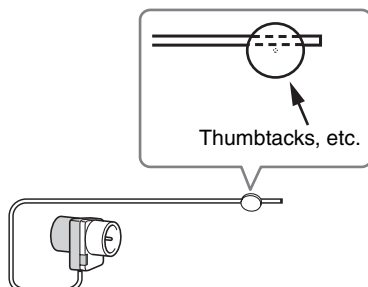

**Caution:** Be careful that you don't injure yourself when using thumbtacks.

If you cannot achieve good reception with the supplied indoor FM antenna, try a commercially available outdoor FM antenna instead (see page 24).

### Connecting the AM Loop Antenna

The supplied indoor AM loop antenna is for indoor use only.

#### 1 Assemble the AM loop antenna, inserting the tabs into the base, as shown.

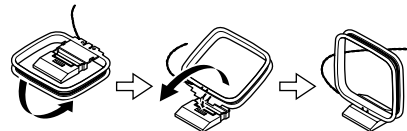

#### 2 Connect both wires of the AM loop antenna to the AM push terminals, as shown.

(The antenna's wires are not polarity sensitive, so they can be connected either way around.) Make sure that the wires are attached securely and that the push terminals are gripping the bare wires, not the insulation.

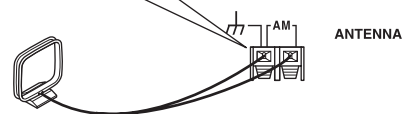
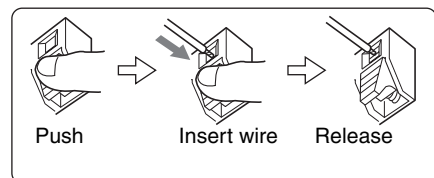

Once your AV receiver is ready for use, you'll need to tune into an AM radio station and adjust the position of the AM antenna to achieve the best possible reception.

Keep the antenna as far away as possible from your AV receiver, TV, speaker cables, and power cords.

If you cannot achieve good reception with the supplied indoor AM loop antenna, try using it with a commercially available outdoor AM antenna (see page 24).

## Connecting the AV receiver—Continued

### Connecting an Outdoor FM Antenna

If you cannot achieve good reception with the supplied indoor FM antenna, try a commercially available outdoor FM antenna instead.

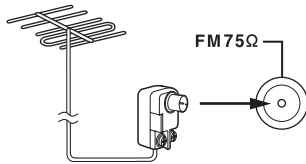

#### Notes:

- Outdoor FM antennas work best outside, but usable results can sometimes be obtained when installed in an attic or loft.
- For best results, install the outdoor FM antenna well away from tall buildings, preferably with a clear line of sight to your local FM transmitter.
- Outdoor antenna should be located away from possible noise sources, such as neon signs, busy roads, etc.
- For safety reasons, outdoor antenna should be situated well away from power lines and other high-voltage equipment.
- Outdoor antenna must be grounded in accordance with local regulations to prevent electrical shock hazards.

#### ■ Using a TV/FM Antenna Splitter

It's best not to use the same antenna for both FM and TV reception, as this can cause interference problems. If circumstances demand it, use a TV/FM antenna splitter, as shown.

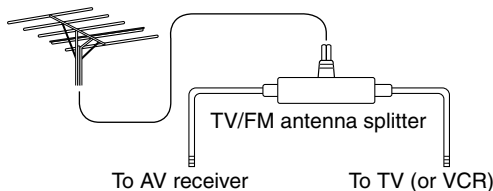

### Connecting an Outdoor AM Antenna

If good reception cannot be achieved using the supplied AM loop antenna, an outdoor AM antenna can be used in addition to the loop antenna, as shown.

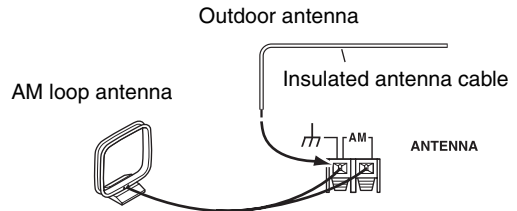

Outdoor AM antennas work best when installed horizontally outside, but good results can sometimes be obtained indoors by mounting horizontally above a window. Note that the AM loop antenna should be left connected.

Outdoor antenna must be grounded in accordance with local regulations to prevent electrical shock hazards.



## Connecting the AV receiver—Continued

### About AV Connections

- Before making any AV connections, read the manuals supplied with your other AV components.
- Don't connect the power cord until you've completed and double-checked all AV connections.

### Optical Digital Jacks

The AV receiver's optical digital jacks have shutter-type covers that open when an optical plug is inserted and close when it's removed. Push plugs in all the way.

**Caution:** To prevent shutter damage, hold the optical plug straight when inserting and removing.

### AV Connection Color Coding

RCA-type AV connections are usually color coded: red, white, and yellow. Use red plugs to connect right-channel audio inputs and outputs (typically labeled "R"). Use white plugs to connect left-channel audio inputs and outputs (typically labeled "L"). And use yellow plugs to connect composite video inputs and outputs.

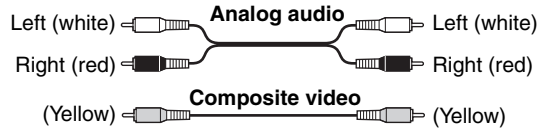

- Push plugs in all the way to make good connections (loose connections can cause noise or malfunctions).
- To prevent interference, keep audio and video cables away from power cords and speaker cables.

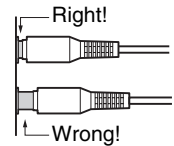

### AV Cables and Jacks

#### Video / Audio

	Cable	Jack	Description
<b>HDMI</b>			HDMI connections can carry uncompressed standard- or high-definition digital video and audio and offer the best picture and sound quality.

#### Video

<b>Component video cable</b>			Component video separates the luminance (Y) and color difference signals (PR, PB), providing the best picture quality. (Some TV manufacturers label their component video jacks slightly differently.)
<b>Composite video cable</b>			Composite video is commonly used on TVs, VCRs, and other video equipment.

#### Audio

<b>Optical digital audio cable</b>			This offers the best sound quality and allows you to enjoy Dolby Digital and DTS. The audio quality is the same as for coaxial.
<b>Coaxial digital audio cable</b>			This offers the best sound quality and allows you to enjoy Dolby Digital and DTS. The audio quality is the same as for optical.
<b>Analog audio cable (RCA)</b>			This cable carries analog audio. It's the most common connection format for analog audio and can be found on virtually all AV components.
<b>Stereo mini plug cable</b>			This cable carries analog audio.

**Note:** The AV receiver does not support SCART connections.

## Connecting the AV receiver—Continued

### Connecting Both Audio & Video

By connecting both the audio and video outputs of your DVD player and other AV components to the AV receiver, you can switch the audio and video signals simultaneously simply by changing the input source on the AV receiver.

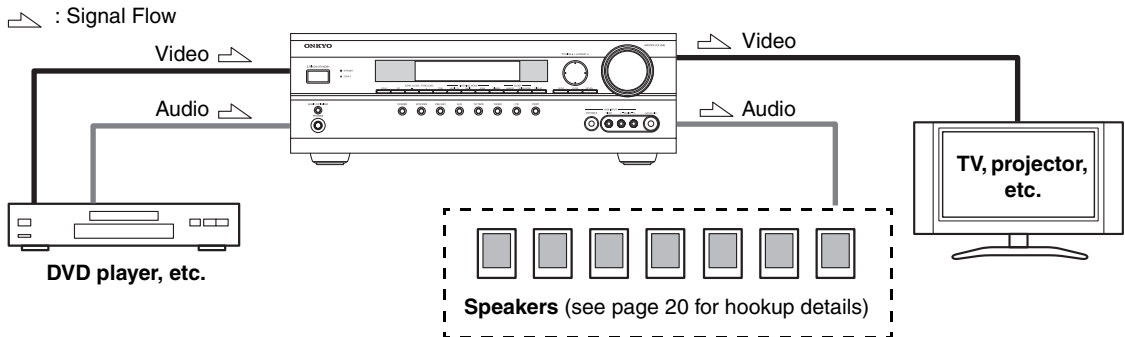

### Which Connections Should I Use?

The AV receiver supports several connection formats for compatibility with a wide range of AV equipment. The format you choose will depend on the formats supported by your other components. Use the following sections as a guide.

#### Video Connection Formats

Video equipment can be connected to the AV receiver by using any one of the following video connection formats: composite video, component video, or HDMI, the latter offering the best picture quality.

When choosing a connection format, bear in mind that the AV receiver doesn't convert between formats, so only outputs of the same format as the input will output the signal.

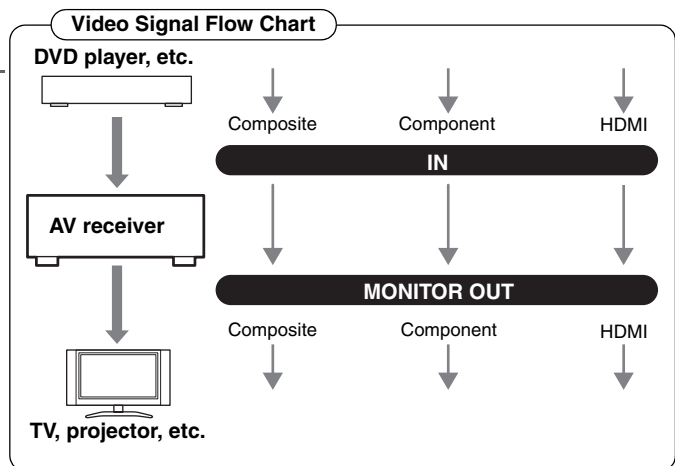

#### Audio Connection Formats

Audio equipment can be connected to the AV receiver by using any of the following audio connection formats: analog, optical, coaxial, or HDMI.

When you connect audio equipment to an HDMI, OPTICAL, or COAXIAL input, you must assign that input to an input selector (see pages 41 and 43).

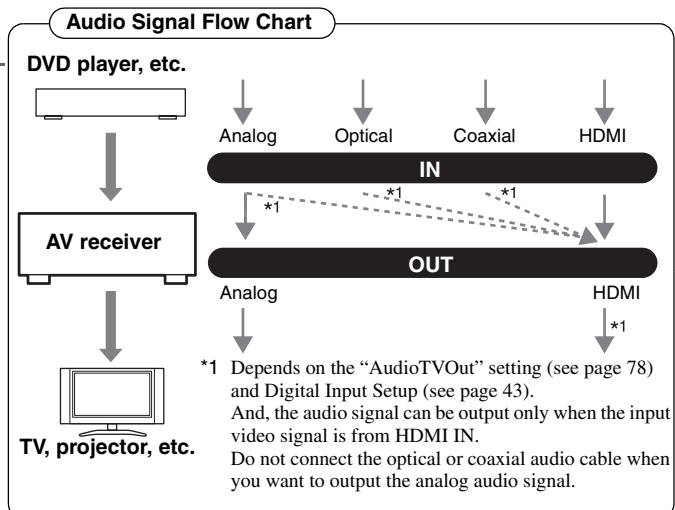

If signals are present at more than one input, the inputs will be selected automatically in the following order of priority: HDMI, digital, analog.

### Connecting Components with HDMI

#### About HDMI

Designed to meet the increased demands of digital TV, HDMI (High Definition Multimedia Interface) is a new digital interface standard for connecting TVs, projectors, DVD players, set-top boxes, and other video components. Until now, several separate video and audio cables have been required to connect AV components. With HDMI, a single cable can carry control signals, digital video, and up to eight channels of digital audio (2-channel PCM, multichannel digital audio, or multichannel PCM).

The HDMI video stream (i.e., video signal) is compatible with DVI (Digital Visual Interface)<sup>\*1</sup>, so TVs and displays with a DVI input can be connected by using an HDMI-to-DVI adapter cable. (This may not work with some TVs and displays, resulting in no picture.)

The AV receiver uses HDCP (High-bandwidth Digital Content Protection), so only HDCP-compatible components will display a picture.

The AV receiver's HDMI interface is based on the following standard:

**Deep Color, x.v. Color, Lip Sync, DTS-HD Master Audio, DTS-HD High Resolution Audio, Dolby TrueHD, Dolby Digital Plus, DSD and Multichannel PCM**

#### Supported Audio Formats

- 2-channel linear PCM (16/20/24 bit/32–192 kHz)
- Multichannel linear PCM (7.1 ch, 32–192 kHz)
- Bitstream (DSD, Dolby Digital, Dolby Digital Plus, Dolby TrueHD, DTS, DTS-HD High Resolution Audio, DTS-HD Master Audio)

Your DVD player must be able to output these formats from its HDMI OUT.

#### ■ Onkyo **RIHD** for System Control

**RIHD**, which stands for Remote Interactive over HDMI, is the name of the system control function found on Onkyo components. The AV receiver can be used with CEC (Consumer Electronics Control), which allows system control over HDMI and is part of the HDMI standard. CEC provides interoperability between various components, however, operation with components other than **RIHD**-compatible components cannot be guaranteed.

- Set "HDMI Ctrl" to "On" (page 79).
- See "Controlling a TV" (page 86) and "Controlling a DVD Player, or DVD Recorder" (page 87) for operation.

#### Note:

Do not connect the **RIHD**-compatible component more than the following number to the HDMI input terminal so that the linked operations work properly.

- DVD/BD player is up to three.
- DVD/BD recorder is up to three.
- Cable/Satellite Set-top box is up to four.

Do not connect the AV receiver to the other AV receiver /AV amplifier via HDMI.

When the **RIHD**-compatible component more than the above-mentioned is connected, the linked operations are not guaranteed.

#### About Copyright Protection

The AV receiver supports HDCP (High-bandwidth Digital Content Protection)<sup>\*2</sup>, a copy-protection system for digital video signals. Other devices connected to the AV receiver via HDMI must also support HDCP.

\*1 DVI (Digital Visual Interface): The digital display interface standard set by the DDWG<sup>\*3</sup> in 1999.

\*2 HDCP (High-bandwidth Digital Content Protection): The video encryption technology developed by Intel for HDMI/DVI. It's designed to protect video content and requires a HDCP-compatible device to display the encrypted video.

\*3 DDWG (Digital Display Working Group): Led by Intel, Compaq, Fujitsu, Hewlett Packard, IBM, NEC, and Silicon Image, this open industry group's objective is to address the industry's requirements for a digital connectivity specification for high-performance PCs and digital displays.

## Connecting the AV receiver—Continued

### Making HDMI Connections

#### Step 1:

Use HDMI cables to connect the AV receiver's HDMI jacks to your HDMI-compatible DVD/BD player, TV, projector, and so on.

#### Step 2:

Assign each HDMI IN to an input selector in the HDMI Input Setup (see page 41).

#### ■ Video Signals

Digital video signals received by the HDMI IN jacks are normally output by the HDMI OUT for display on your TV.

#### ■ Audio Signals

Digital audio signals received by the HDMI IN jacks are output by the speakers and headphones connected to the AV receiver. Normally, they are not output by the HDMI OUT, unless the “AudioTVOut” setting is set to “On” (see page 78).



To listen to audio received by the HDMI IN jacks through your TV's speakers, set the “AudioTVOut” setting to “On” (see page 78), and set your DVD player's HDMI audio output setting to PCM.

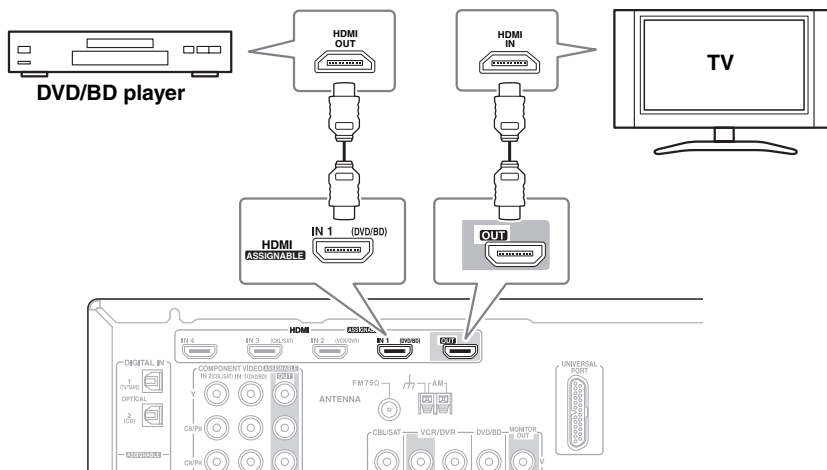

#### Notes:

- The HDMI video stream is compatible with DVI (Digital Visual Interface), so TVs and displays with a DVI input can be connected by using an HDMI-to-DVI adapter cable. (Note that DVI connections only carry video, so you'll need to make a separate connection for audio.) However, reliable operation with such an adapter is not guaranteed. In addition, video signals from a PC are not supported.
- When listening to an HDMI component through the AV receiver, set the HDMI component so that its video can be seen on the TV screen (on the TV, select the input of the HDMI component connected to the AV receiver). If the TV power is off or the TV is set to another input source, this may result in no sound from the AV receiver or the sound may be cut off.
- When the “AudioTVOut” setting is set to “On” (see page 78), or “TV Ctrl” is set to “On” (see page 79) and you're listening through your TV's speakers, if you turn up the AV receiver volume control, the sound will be output by the AV receiver's speakers. To stop the AV receiver's speakers producing sound, change the settings, change your TV's settings, or turn down the AV receiver's volume.
- The HDMI audio signal (sampling rate, bit length, etc.) may be restricted by the connected source component. If the picture is poor or there's no sound from a component connected via HDMI, check its setup. Refer to the connected component's instruction manual for details.

# Connecting the AV receiver—Continued

## Connecting a TV or Projector

### Step 1: Video Connection

Choose a video connection that matches your TV (**A** or **B**), and then make the connection.

### Step 2: Audio Connection

Choose an audio connection that matches your TV (**a**, **b**, or **c**), and then make the connection.

- With connection **a**, you can listen to and record audio from your TV or listen in Zone 2.
- To enjoy Dolby Digital and DTS, use connection **b** or **c**. (To record or listen in Zone 2 as well, use **a** and **b**, or **a** and **c**.)

Connection	AV receiver	Signal flow	TV
<b>A</b>	COMPONENT VIDEO OUT	⇒	Component video input
<b>B</b>	MONITOR OUT V	⇒	Composite video input
<b>a</b>	TV/TAPE IN L/R	⇐	Analog audio L/R output
<b>b</b>	DIGITAL IN COAXIAL 2 (CBL/SAT)	⇐	Digital coaxial output
<b>c</b>	DIGITAL IN OPTICAL 1 (TV/TAPE)	⇐	Digital optical output

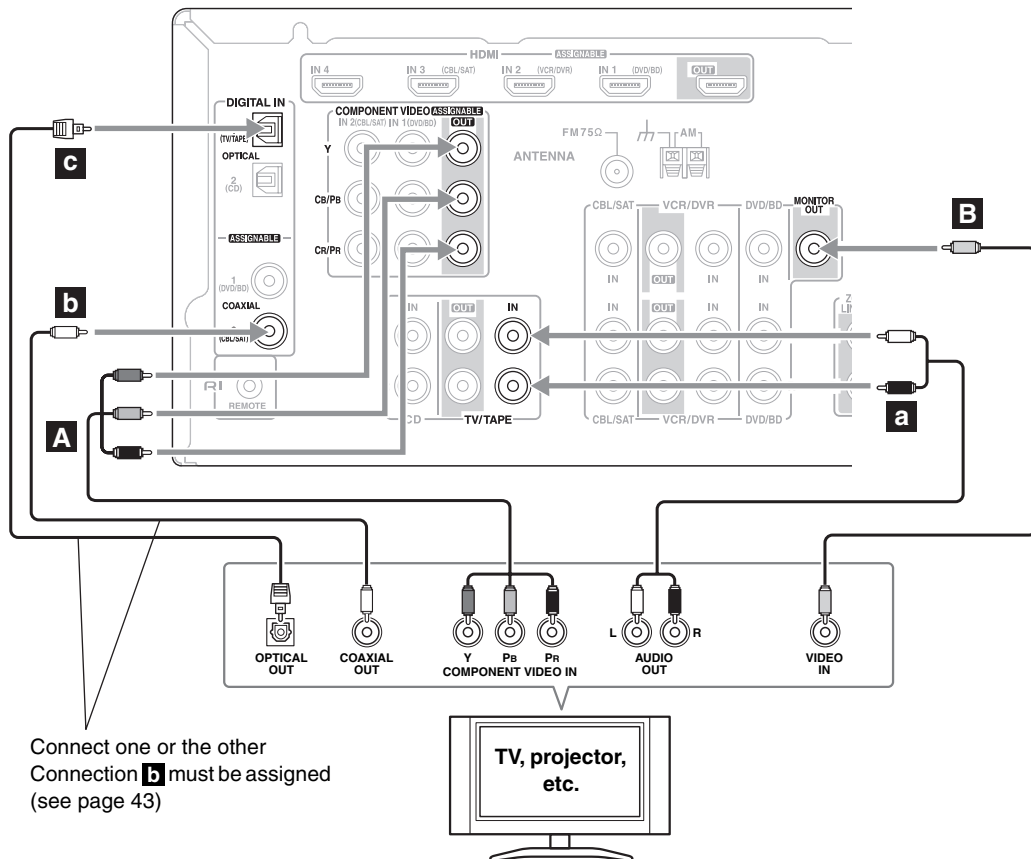

**Hint!** If your TV has no audio outputs, connect an audio output from your VCR or cable or satellite receiver to the AV receiver and use its tuner to listen to TV programs through the AV receiver (see pages 31 and 33).

## Connecting the AV receiver—Continued

### Connecting a DVD/BD Player

#### Step 1: Video Connection

Choose a video connection that matches your DVD/BD player (**A** or **B**), and then make the connection. You must connect the AV receiver to your TV with the same type of connection.

#### Step 2: Audio Connection

Choose an audio connection that matches your DVD/BD player (**a**, **b**, or **c**), and then make the connection.

- With connection **a**, you can listen to and record audio from a DVD or listen in Zone 2.
- To enjoy Dolby Digital and DTS, use connection **b** or **c**. (To record or listen in Zone 2 as well, use **a** and **b**, or **a** and **c**.)
- If your DVD player has main left and right outputs and multichannel left and right outputs, be sure to use the main left and right outputs for connection **a**.

Connection	AV receiver	Signal flow	DVD/BD player
<b>A</b>	COMPONENT VIDEO IN 1 (DVD/BD)	←	Component video output
<b>B</b>	DVD/BD IN V	←	Composite video output
<b>a</b>	DVD/BD IN L/R	←	Analog audio L/R output
<b>b</b>	DIGITAL IN COAXIAL 1 (DVD/BD)	←	Digital coaxial output
<b>c</b>	DIGITAL IN OPTICAL 1 (TV/TAPE)	←	Digital optical output

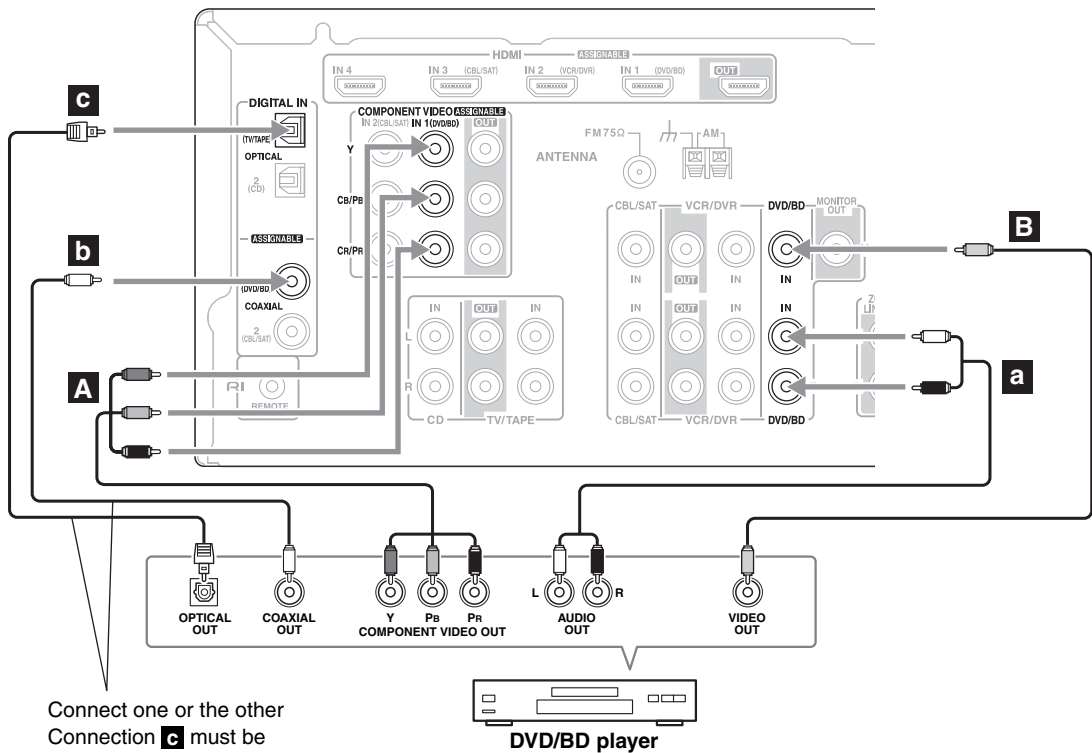

Connect one or the other Connection **c** must be assigned (see page 43)

DVD/BD player

## Connecting the AV receiver—Continued

### Connecting a VCR or DVR for Playback



With this hookup, you can use your VCR's tuner to listen to your favorite TV programs via the AV receiver, useful if your TV has no audio outputs.

#### Step 1: Video Connection

Choose a video connection that matches your VCR or DVR (**A** or **B**), and then make the connection. You must connect the AV receiver to your TV with the same type of connection.

#### Step 2: Audio Connection

Choose an audio connection that matches your VCR or DVR (**a**, **b**, or **c**), and then make the connection.

- With connection **a**, you can listen to the VCR or DVR even in Zone 2.
- To enjoy Dolby Digital and DTS, use connection **b** or **c**. (To listen in Zone 2 as well, use **a** and **b**, or **a** and **c**.)

Connection	AV receiver	Signal flow	VCR or DVR
<b>A</b>	COMPONENT VIDEO IN 1 (DVD/BD)	←	Component video output
<b>B</b>	VCR/DVR IN V	←	Composite video output
<b>a</b>	VCR/DVR IN L/R	←	Analog audio L/R output
<b>b</b>	DIGITAL IN COAXIAL 1 (DVD/BD)	←	Digital coaxial output
<b>c</b>	DIGITAL IN OPTICAL 1 (TV/TAPE)	←	Digital optical output

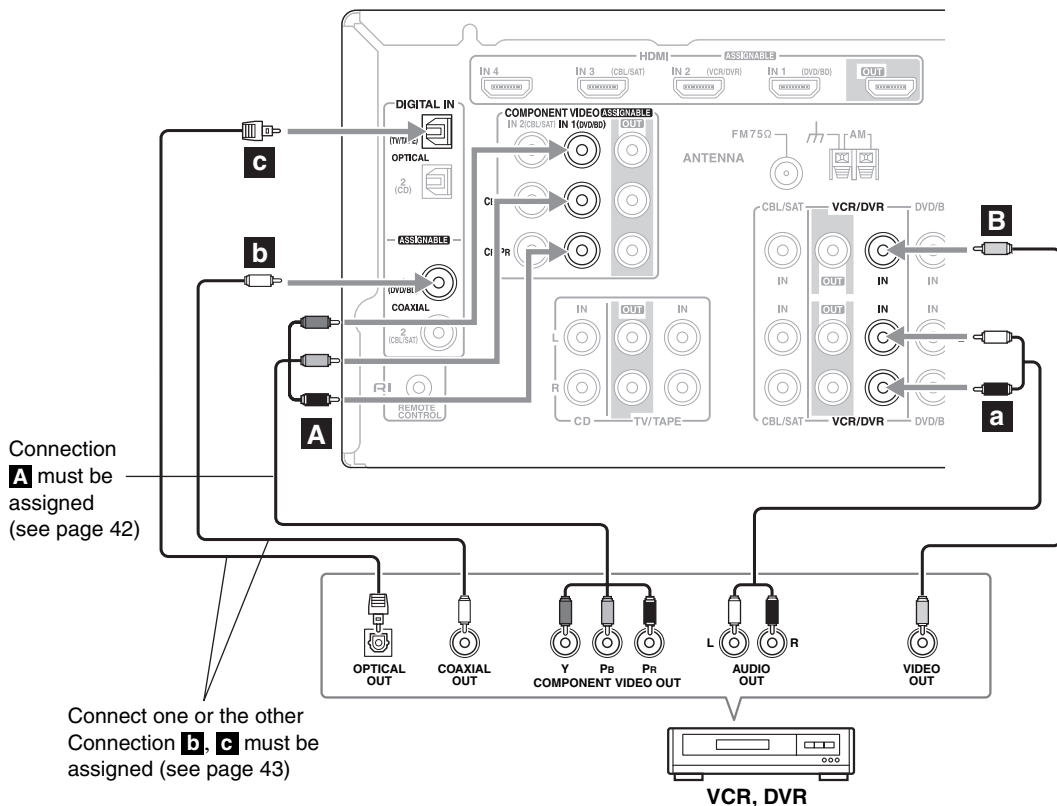

## Connecting the AV receiver—Continued

### Connecting a VCR or DVR for Recording

#### Step 1: Video Connection

Make the video connection **A**.

The video source to be recorded must be connected to the AV receiver via the same type of connection.

#### Step 2: Audio Connection

Make the audio connection **a**.

Connection	AV receiver	Signal flow	VCR or DVR
<b>A</b>	VCR/DVR OUT V	⇒	Composite video input
<b>a</b>	VCR/DVR OUT L/R	⇒	Audio L/R input

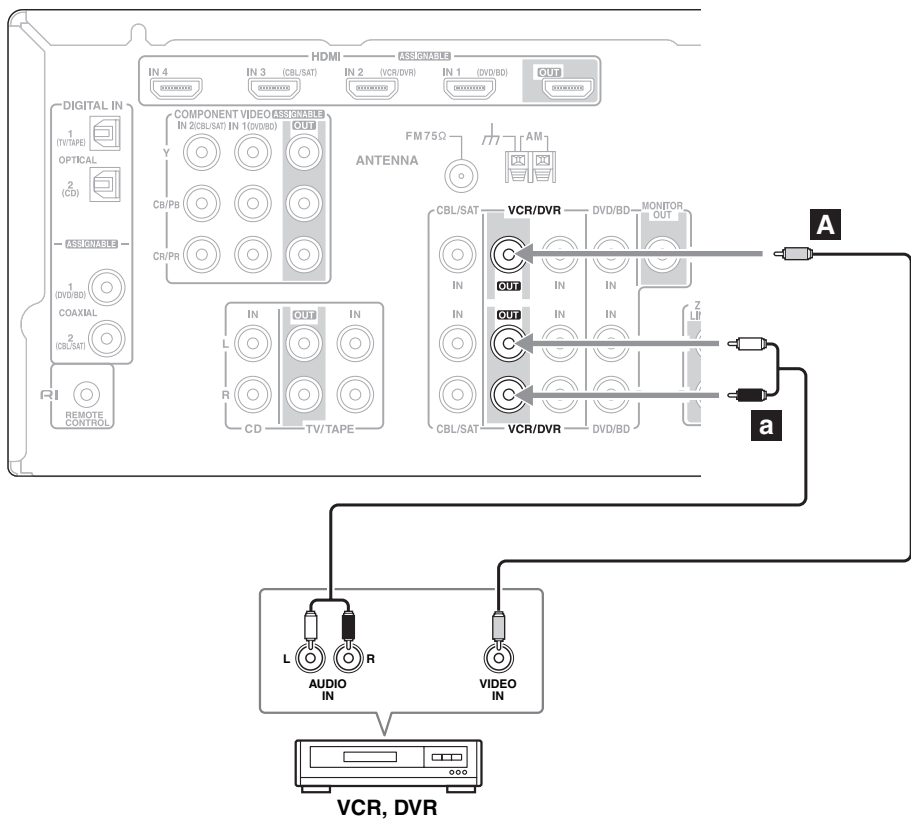

#### Notes:

- The AV receiver must be turned on for recording. Recording is not possible while it's on Standby.
- If you want to record directly from your TV or another video source without going through the AV receiver, connect the audio and video outputs from your TV or other video component directly to the recording VCR/DVR's audio and video inputs. See the manuals supplied with your TV or VCR/DVR for details.
- Video signals connected to composite video inputs can only be recorded via composite video outputs. If your TV/VCR is connected to a composite video input, the recording VCR must be connected to a composite video output.



# Connecting the AV receiver—Continued

## Connecting a Satellite, Cable, Terrestrial Set-top box, or Other Video Source



With this hookup, you can use your satellite or cable receiver to listen to your favorite TV programs via the AV receiver, which is useful if your TV has no audio outputs.

### Step 1: Video Connection

Choose a video connection that matches the video source (**A** or **B**), and then make the connection. You must connect the AV receiver to your TV with the same type of connection.

### Step 2: Audio Connection

Choose an audio connection that matches the video source (**a**, **b**, or **c**), and then make the connection.

- With connection **a**, you can listen to and record audio from the video source or listen in Zone 2.
- To enjoy Dolby Digital and DTS, use connection **b** or **c**. (To record or listen in Zone 2 as well, use **a** and **b**, or **a** and **c**.)

Connection	AV receiver	Signal flow	Video source
<b>A</b>	COMPONENT VIDEO IN 2 (CBL/SAT)	←	Component video output
<b>B</b>	CBL/SAT IN V	←	Composite video output
<b>a</b>	CBL/SAT IN L/R	←	Analog audio L/R output
<b>b</b>	DIGITAL IN COAXIAL 2 (CBL/SAT)	←	Digital coaxial output
<b>c</b>	DIGITAL IN OPTICAL 1 (TV/TAPE)	←	Digital optical output

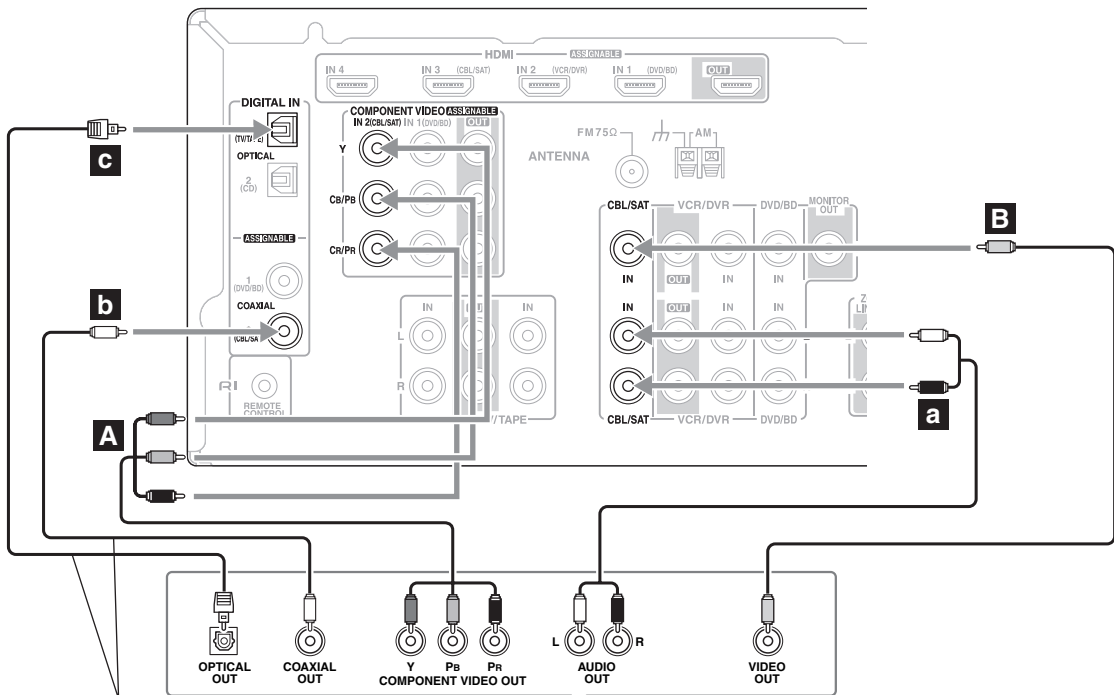

Connect one or the other  
Connection **c** must be  
assigned (see page 43)

Satellite, cable, set-top box, etc.

## Connecting the AV receiver—Continued

### Connecting a Camcorder, Game Console, or Other Device

**Step 1: Make the video connection **A**.**

**Step 2: Make the audio connection **a**.**

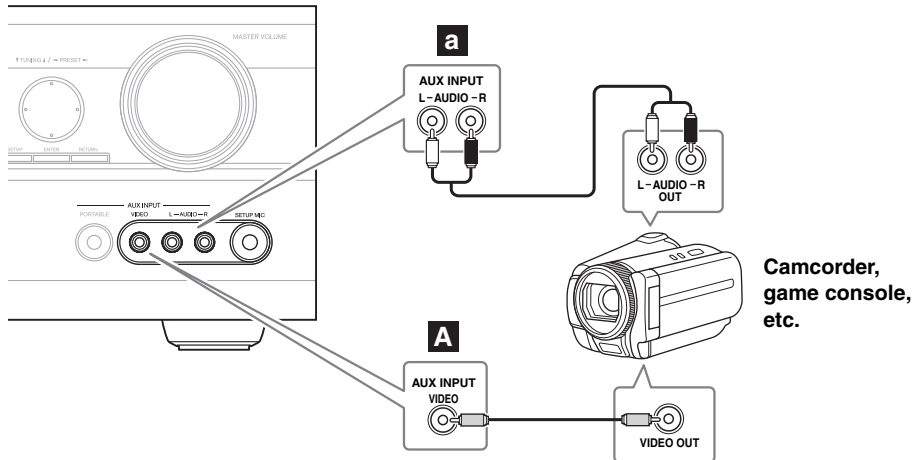

Connection	AV receiver	Signal flow	Camcorder or console
<b>A</b>	AUX INPUT VIDEO	←	Composite video output
<b>a</b>	AUX INPUT L-AUDIO-R	←	Analog audio L/R output

### Connecting a Portable Audio player

**Step 1: Make the audio connection **a**.**

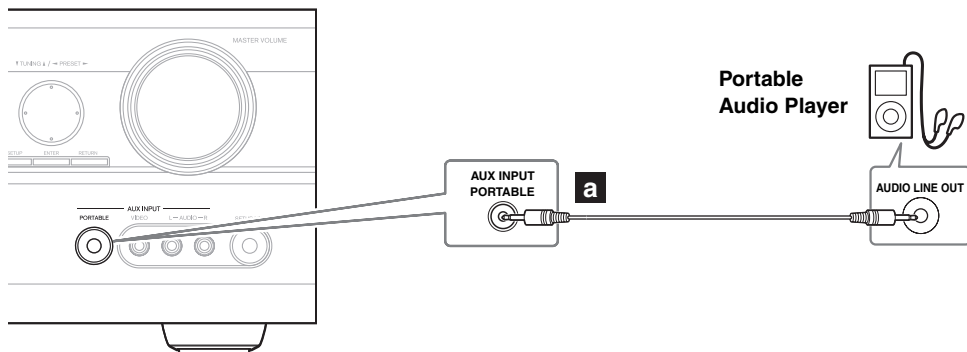

Connection	AV receiver	Signal flow	Portable Audio Player
<b>a</b>	AUX INPUT PORTABLE	←	Analog audio Line output

**Note:**

When it is connected at the same time as AUX INPUT AUDIO L/R terminal, the input of PORTABLE is given priority to and outputted.

# Connecting the AV receiver—Continued

## Connecting a CD Player or Turntable

### ■ CD Player or Turntable (MM) with Built-in Phono Preamp

#### Step 1:

Choose a connection that matches your CD player (**a**, **b**, or **c**).

Use connection **a** for a turntable with a built-in phono preamp.

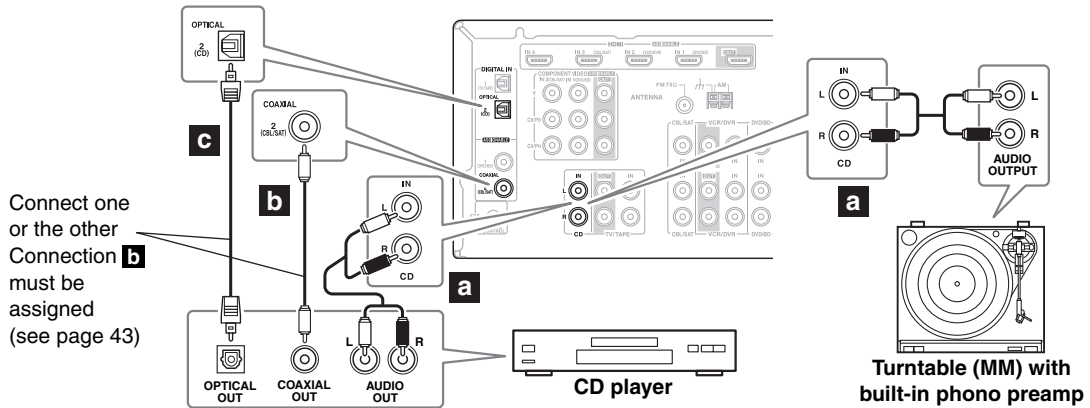

- With connection **a**, you can listen to and record audio from the CD player or listen in Zone 2.
- To connect the CD player digitally, use connection **b** or **c**. (To record or listen in Zone 2 as well, use **a** and **b**, or **a** and **c**.)

Connection	AV receiver	Signal flow	CD or turntable
<b>a</b>	CD IN L/R	←	Analog audio L/R output
<b>b</b>	DIGITAL IN COAXIAL 2 (CBL/SAT)	←	Digital coaxial output
<b>c</b>	DIGITAL IN OPTICAL 2 (CD)	←	Digital optical output

### ■ Turntable (MM) with no Phono Preamp Built-in

A phono preamp is necessary to connect a turntable that doesn't have a phono preamp built-in.

### ■ Turntable with an MC (Moving Coil) Cartridge

An MC head amp and phono preamp are necessary to connect a turntable with an MC (Moving Coil) cartridge.

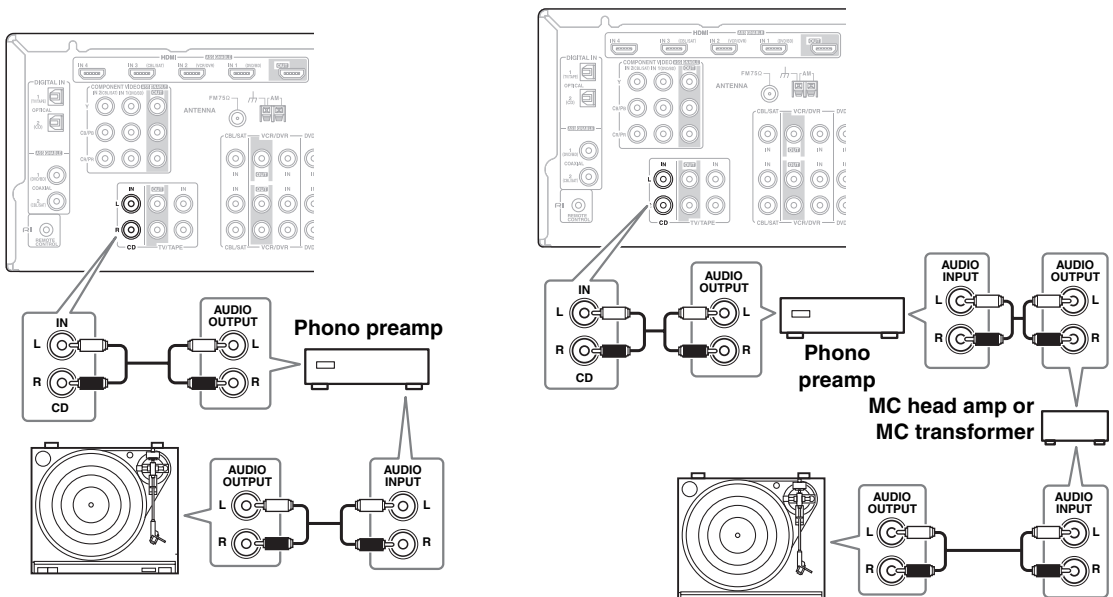

## Connecting the AV receiver—Continued

### Connecting a Cassette, CDR, MiniDisc, or DAT Recorder

#### Step 1:

Choose a connection that matches your recorder (**a**, **b**, or **c**), and then make the connection.

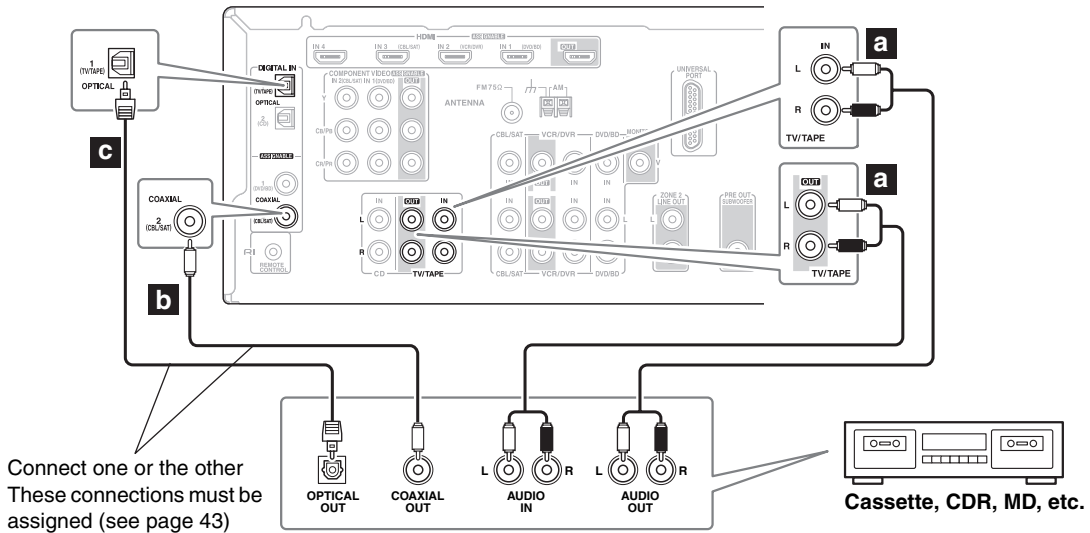

- With connection **a**, you can play and record or listen in Zone 2.
- To connect the recorder digitally for playback, use connections **a** and **b**, or **a** and **c**.

Connection	AV receiver	Signal flow	Cassette, CDR, MD, or DAT recorder
<b>a</b>	TV/TAPE IN L/R TV/TAPE OUT L/R	← →	Analog audio L/R output Analog audio L/R input
<b>b</b>	DIGITAL IN COAXIAL 2 (CBL/SAT)	←	Digital coaxial output
<b>c</b>	DIGITAL IN OPTICAL 1 (TV/TAPE)	←	Digital optical output

### Connecting an RI Dock

**Not all iPod models output video.**  
**For information about which iPod models are supported by the RI Dock, see the RI Dock's instruction manual.**

#### ■ If Your iPod or iPhone Supports Video:

Connect your RI Dock's audio output jacks to the AV receiver's CBL/SAT IN or VCR/DVR IN L/R jacks, and connect its video output jack to the AV receiver's CBL/SAT IN or VCR/DVR IN V jacks.

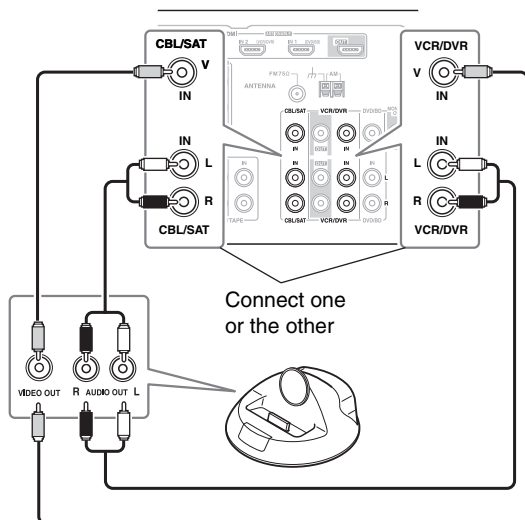

#### ■ If Your iPod or iPhone Don't Support Video:

Connect your RI Dock's audio output jacks to the AV receiver's TV/TAPE IN L/R jacks.

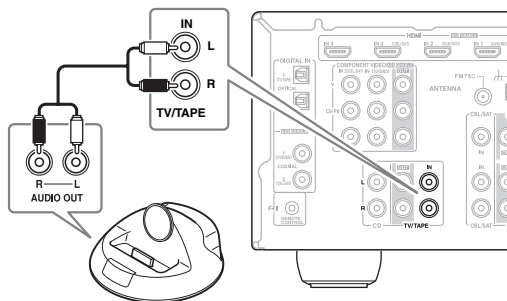

#### Notes:

- Enter the appropriate remote control code before using the AV receiver's remote controller for the first time (see page 85).
- Connect the RI Dock to the AV receiver with an **RI** cable (see page 39).
- Set the RI Dock's RI MODE switch to "HDD" or "HDD/DOCK".
- Set the AV receiver's Input Display to "DOCK" (see page 45).
- See the RI Dock's instruction manual for more information.

### Connecting a Dock with the Universal Port connector

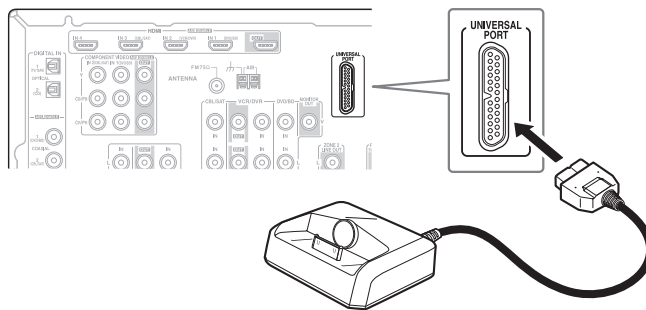

#### Notes:

- Do not connect components other than the Universal Port Option Dock with the UNIVERSAL PORT jack.
- While your iPod or iPhone is seated in the Dock, its battery will be charged when the AV receiver is set to On or Standby.
- When UP-A1 series Dock that seated iPod or iPhone is connected, the power consumption on standby mode slightly increases.
- Make a connection with the MONITOR OUT V when you watch videos on the TV (see page 29).

## Connecting the AV receiver—Continued

### Connecting Onkyo RI Components

**Step 1:** Make sure that each Onkyo component is connected to the AV receiver with an analog audio cable (RCA).

**Step 2:** Make the necessary **RI** connections (see illustration below).

**Step 3:** If you're using an MD, CDR, or RI DOCK component, change the Input Display (see page 45).

With **RI** (Remote Interactive), you can use the following special functions:

#### ■ Auto Power On/Standby

When you start playback on a component connected via **RI**, if the AV receiver is on Standby, it will automatically turn on and select that component as the input source. Similarly, when the AV receiver is set to Standby, all components connected via **RI** will also go on Standby.

#### ■ Direct Change

When playback is started on a component connected via **RI**, the AV receiver automatically selects that component as the input source.

#### ■ Remote Control

You can use the AV receiver's remote controller to control your other **RI**-capable Onkyo components. You must enter the appropriate remote control code first (see page 85). And remember to point the remote controller at the AV receiver and not the other component.

#### Notes:

- Use only **RI** cables for **RI** connections. **RI** cables are supplied with Onkyo players (DVD, CD, etc.).
- Some components have two **RI** jacks. You can connect either one to the AV receiver. The other jack is for connecting additional **RI**-capable components.
- Connect only Onkyo components to **RI** jacks. Connecting other manufacturer's components may cause a malfunction.
- Some components may not support all **RI** functions. Refer to the manuals supplied with your other Onkyo components.
- While Zone 2 is on, the Auto Power On/Standby and Direct Change **RI** functions do not work.

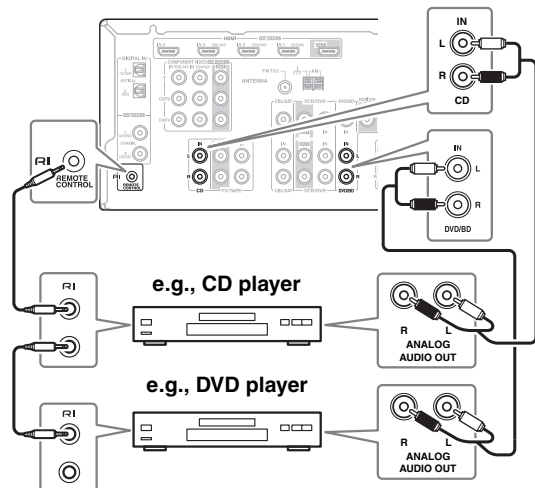

### Connecting the Power Cord

- **Before connecting the power cord, connect all your speakers and AV components.**
- Plug the end of the power cord into a suitable wall outlet.
- Turning on the AV receiver may cause a momentary power surge that might interfere with other electrical equipment on the same circuit. If this is a problem, plug the AV receiver into a different branch circuit.

# Turning On the AV receiver

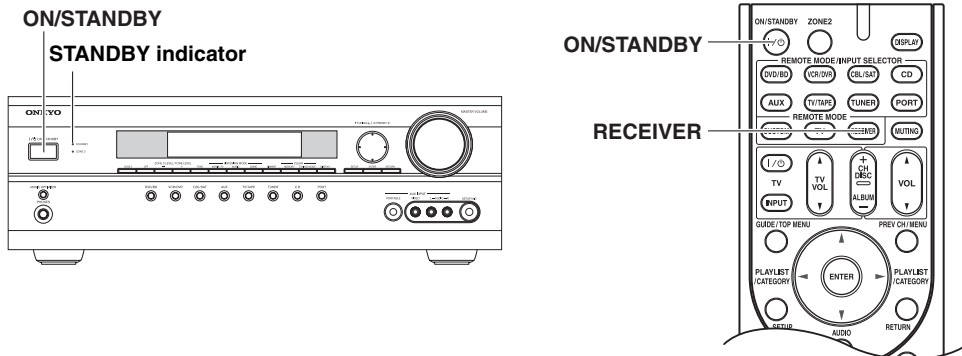

## Turning On and Standby

**AV receiver**

**Remote controller**

or

**On the AV receiver, press the [ON/STANDBY] button.**

**On the remote controller, press the [RECEIVER] button, followed by the [ON/STANDBY] button.**

The AV receiver comes on, the display lights up, and the STANDBY indicator goes off.

To turn the AV receiver off, press the [ON/STANDBY] button, or press the remote controller's [ON/STANDBY] button. The AV receiver will enter Standby mode. To prevent any loud surprises the next time you turn on the AV receiver, turn down the volume before you turn it off.

## Up and Running in a Few Easy Steps

To get your system up and running with the minimum of fuss, here's a few pointers to help you configure the AV receiver before you use it for the very first time. These settings only need to be made once.

■ **Do the 2EQ Room Correction and Speaker Setup—this is essential!**

See “Audyssey 2EQ™ Room Correction and Speaker Setup” on page 46.

■ **Did you connect a component to an HDMI input, component video input, or digital audio input?**

If you did, see “HDMI Input Setup” on page 41, “Component Video Input Setup” on page 42, or “Digital Input Setup” on page 43 respectively.

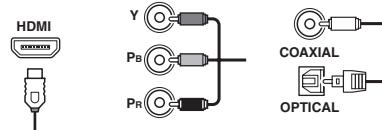

■ **Did you connect a UP-A1 series Dock?**

If you did, see “Connecting a Dock with the Universal Port connector” on page 38.

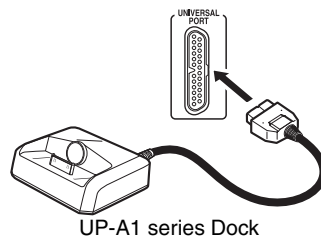



# First Time Setup

This section explains the settings that you need to make before using the AV receiver for the very first time.

## HDMI Input Setup

If you connect a video component to an HDMI IN, you must assign that input to an input selector. For example, if you connect your DVD player to HDMI IN1, you must assign HDMI IN1 to the DVD/BD input selector.

Input selector	Default assignment
DVD/BD	HDMI1
VCR/DVR	HDMI2
CBL/SAT	HDMI3
AUX	-----
TV/TAPE	-----
CD	-----
PORT	-----

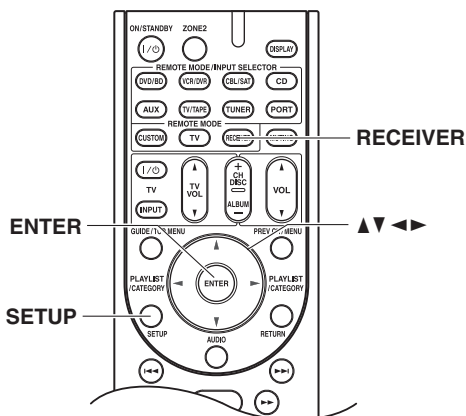

**1** Press the [RECEIVER] button, followed by the [SETUP] button.

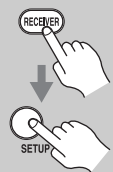

**2** Use the Up and Down [▲]/[▼] buttons to select “1. Input Assign”, and then press [ENTER].

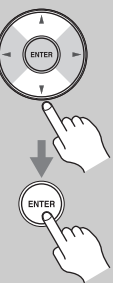

**3** Use the Up and Down [▲]/[▼] buttons to select “1-1. HDMI”, and then press [ENTER].

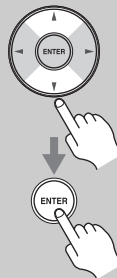

**4** Use the Up and Down [▲]/[▼] buttons to select an input selector, and use the Left and Right [◀]/[▶] buttons to select:

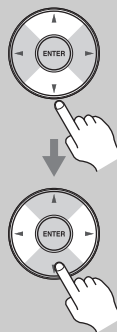

**HDMI1:** Select if the video component is connected to HDMI IN 1.

**HDMI2:** Select if the video component is connected to HDMI IN 2.

**HDMI3:** Select if the video component is connected to HDMI IN 3.

**HDMI4:** Select if the video component is connected to HDMI IN 4.

-----: Select if you're not using the HDMI OUT.

**5** Press the [SETUP] button. Setup closes.



### Notes:

- Each HDMI IN cannot be assigned to more than one input selector.
- When an HDMI IN is assigned to an input selector as explained here, the digital audio input for that input selector is automatically set to the same HDMI IN. See “Digital Input Setup” on page 43.
- If you connect an input component (such as UP-A1 series Dock that seated iPod or iPhone) to the UNIVERSAL PORT jack, you cannot assign any input to PORT selector.
- This procedure can also be performed on the AV receiver by using its [SETUP] button, arrow buttons, and [ENTER] button.
- Do not assign the component connected with the HDMI input to the TV/TAPE selector when you set “TV Ctrl” setting to “On” (see page 79). Otherwise, appropriate CEC (Consumer Electronics Control) operation is not guaranteed.

### Component Video Input Setup

If you connect a video component to a COMPONENT VIDEO IN, you must assign that input to an input selector. For example, if you connect your DVD player to COMPONENT VIDEO IN 2, you must assign COMPONENT VIDEO IN 2 to the DVD/BD input selector.

Input selector	Default assignment
DVD/BD	IN1
VCR/DVR	-----
CBL/SAT	IN2
AUX	-----
TV/TAPE	-----
CD	-----
PORT	-----

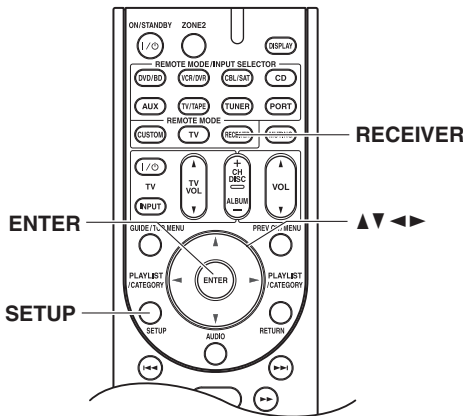

**1** Press the [RECEIVER] button, followed by the [SETUP] button.

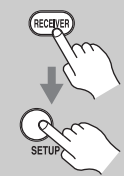

**2** Use the Up and Down [▲]/[▼] buttons to select “1. Input Assign”, and then press [ENTER].



**3** Use the Up and Down [▲]/[▼] buttons to select “1-2. Component”, and then press [ENTER].

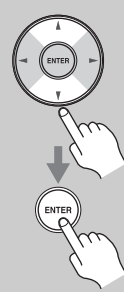

**4** Use the Up and Down [▲]/[▼] buttons to select an input selector, and use the Left and Right [◀]/[▶] buttons to select:

IN1: Select if the video component is connected to COMPONENT VIDEO IN 1.

IN2: Select if the video component is connected to COMPONENT VIDEO IN 2.

-----: Select if you're not using the COMPONENT VIDEO OUT.



**5** Press the [SETUP] button. Setup closes.



**Notes:**

- If you connect an input component (such as UP-A1 series Dock that seated iPod or iPhone) to the UNIVERSAL PORT jack, you cannot assign any input to PORT selector.
- This procedure can also be performed on the AV receiver by using its [SETUP] button, arrow buttons, and [ENTER] button.

**Digital Input Setup**

If you connect a component to a digital audio input, you must assign that input to an input selector. For example, if you connect your CD player to OPTICAL IN 1, you must assign OPTICAL IN 1 to the CD input selector. These are the default assignments.

Input selector	Default assignment
DVD/BD	COAX1
VCR/DVR	-----
CBL/SAT	COAX2
AUX	-----
TV/TAPE	OPT1
CD	OPT2
PORT	-----

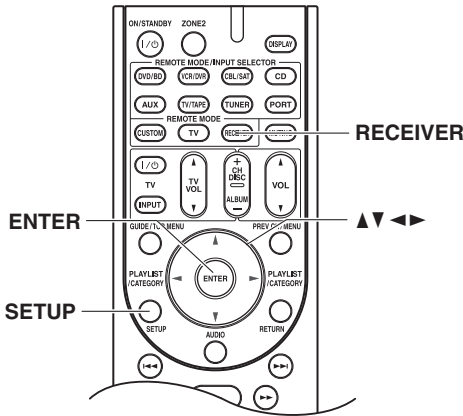

**1** Press the [RECEIVER] button, followed by the [SETUP] button.

**2** Use the Up and Down [▲]/[▼] buttons to select “1. Input Assign”, and then press [ENTER].

**3** Use the Up and Down [▲]/[▼] buttons to select “1-3. Digital”, and then press [ENTER].

**4** Use the Up and Down [▲]/[▼] buttons to select an input selector, and then use the Left and Right [◀]/[▶] buttons to select:

**COAX1:** Select if the component is connected to DIGITAL IN COAXIAL 1.

**COAX2:** Select if the component is connected to DIGITAL IN COAXIAL 2.

**OPT1:** Select if the component is connected to DIGITAL IN OPTICAL 1.

**OPT2:** Select if the component is connected to DIGITAL IN OPTICAL 2.

-----: Select if the component is connected to an analog input.

**Notes:**

- Press the [ENTER] button when you do not use the signal of audio from the HDMI IN. The “\*” mark is displayed like “COAX1 \*”.
- For the input selector that you want to listen the analog audio, set to “-----” in the Digital Audio Input setting and HDMI Input setting (see page 41).

**5** Press the [SETUP] button. Setup closes.

- Notes:**
- When an HDMI IN is assigned to an input selector in “HDMI Input Setup” on page 41, this input assignment is automatically set to the same HDMI IN. And in addition to the usual inputs (e.g., COAX1, COAX2, etc.), you can also select HDMI inputs.
  - If you connect an input component (such as UP-A1 series Dock that seated iPod or iPhone) to the UNIVERSAL PORT jack, you cannot assign any input to PORT selector.
  - This procedure can also be performed on the AV receiver by using its [SETUP] button, arrow buttons, and [ENTER] button.

## Speaker Settings

If you change these settings, you must run the Audyssey 2EQ™ Room Correction and Speaker Setup again (see page 46).



If the impedance of any speaker is 4 ohms or more but less than 6, set the Speaker Impedance to 4 ohms.



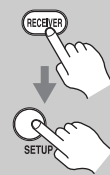

**North American models do not support speakers with an impedance of less than 6 ohms.**

To use bi-amping, you must change the Speaker Type setting. For hookup information, see page 22.

**Notes:**

- When bi-amping is used, the AV receiver is able to drive up to 5.1 speakers in the main room.
- Before you change these settings, turn down the volume.

<b>1</b>	 <p><b>Press the [RECEIVER] button, followed by the [SETUP] button.</b></p>
<b>2</b>	 <p><b>Use the Up and Down [▲]/[▼] buttons to select “2. Speaker Setup”, and then press [ENTER].</b></p>
<b>3</b>	 <p><b>Use the Up and Down [▲]/[▼] buttons to select “2-1. Sp Settings”, and then press [ENTER].</b></p>

<b>4</b>	 <p><b>(Asian models) Use the Up and Down [▲]/[▼] buttons to select “Impedance”, and use the Left and Right [◀]/[▶] buttons to select:</b></p> <p><b>4 ohms:</b> Select if the impedance of any speaker is 4 ohms or more but less than 6.</p> <p><b>6 ohms:</b> Select if the impedances of all speakers are between 6 and 16 ohms.</p>
<b>5</b>	 <p><b>Use the Up and Down [▲]/[▼] buttons to select “Sp Type”, and use the Left and Right [◀]/[▶] buttons to select:</b></p> <p><b>Normal:</b> Select this if you’ve connected your front speakers normally.</p> <p><b>Bi-Amp:</b> Select this if you’ve connected your front speakers for bi-amped operation.</p> <p><b>Note:</b> Powered Zone2 cannot be used if “Sp Type” is set to “Bi-Amp”.</p>
<b>6</b>	 <p><b>Use the Up and Down [▲]/[▼] buttons to select “SB/FH”, and then use the Left and Right [◀]/[▶] buttons to select:</b></p> <p><b>FrontHigh:</b> Select this if you’ve connected your front high speakers to the SURR BACK L/R terminal posts.</p> <p><b>SurrBack:</b> Select this if you’ve connected your surround back speakers to the SURR BACK L/R terminal posts.</p> <p><b>Note:</b> If the “Sp Type” setting is set to “Bi-Amp”, or Powered Zone 2 is set to “Not Act” (page 81), this setting cannot be selected.</p>
<b>7</b>	 <p><b>Press the [SETUP] button.</b> Setup closes.</p>

**Note:**

This procedure can also be performed on the AV receiver by using its [SETUP] button, arrow buttons, and [ENTER] button.

### Changing the Input Display

If you connect an **RI**-capable Onkyo RI Dock to the TV/TAPE IN, CBL/SAT IN or VCR/DVR IN jacks, for **RI** to work properly, you must change this setting. This setting can only be changed on the AV receiver.

VCR/DVR CBL/SAT TV/TAPE

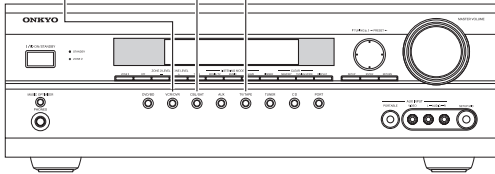

**1**

Press the [TV/TAPE], [CBL/SAT] or [VCR/DVR] input selector button so that “TV/TAPE”, “CBL/SAT” or “VCR/DVR” appears on the display.

**2**

Press and hold down the [TV/TAPE], [CBL/SAT] or [VCR/DVR] input selector button (about 3 seconds) to change the setting.

Repeat this step to select DOCK.

For the TV/TAPE input selector, the setting changes in this order:

TV/TAPE → MD → CDR  
 ↑ DOCK ←

For the CBL/SAT input selector, the setting changes in this order:

CBL/SAT ↔ DOCK

For the VCR/DVR input selector, the setting changes in this order:

VCR/DVR ↔ DOCK

See “Controlling Other Components” on pages 90, 91

**Note:**  
DOCK can be selected for the TV/TAPE, CBL/SAT or VCR/DVR input selector, but not at the same time.

## Audyssey 2EQ™ Room Correction and Speaker Setup

With the supplied calibrated microphone, Audyssey 2EQ automatically determines the number of speakers connected, their size for purposes of bass management, optimum crossover frequencies to the subwoofer (if present), and distances from the primary listening position. Audyssey 2EQ then removes the distortion caused by room acoustics by capturing room acoustical problems over the listening area in both the frequency and time domain. The result is clear, well-balanced sound for everyone. Enabling Audyssey 2EQ allows you to also use Audyssey Dynamic EQ™, which maintains the proper octave-to-octave balance at any volume level (see page 72).

Before using this function, connect and position all of your speakers.

If Audyssey Dynamic EQ is set to “On”, Audyssey Dynamic Volume™ becomes available.

### About Audyssey Dynamic EQ

Audyssey Dynamic EQ solves the problem of deteriorating sound quality as volume is decreased by taking into account human perception and room acoustics. Dynamic EQ selects the correct frequency response and surround levels moment-by-moment at any user-selected volume setting. The result is bass response, tonal balance, and surround impression that remain constant despite changes in volume. Dynamic EQ combines information from incoming source levels with actual output sound levels in the room, a prerequisite for delivering a loudness correction solution. Audyssey Dynamic EQ works in tandem with Audyssey 2EQ to provide well-balanced sound for every listener at any volume level.

### About Audyssey Dynamic Volume

Audyssey Dynamic Volume solves the problem of large variations in volume level between television programs, commercials, and between the soft and loud passages of movies. Dynamic Volume looks at the preferred volume setting by the user and then monitors how the volume of program material is being perceived by listeners in real time to decide whether an adjustment is needed. Whenever necessary, Dynamic Volume makes the necessary rapid or gradual adjustments to maintain the desired playback volume level while optimizing the dynamic range. Audyssey Dynamic EQ is integrated into Dynamic Volume so that as the playback volume is adjusted automatically, the perceived bass response, tonal balance, surround impression, and dialog clarity remain the same whether watching movies, flipping between television channels, or changing from stereo to surround sound content.

## Measurement Positions

To create a listening environment in which several people can enjoy your home theater simultaneously, Audyssey 2EQ takes measurements at three positions within the listening area.

- ① **First measurement point**  
Also referred to as the Main Listening Position this refers to the most central position where one would normally sit within the listening environment. 2EQ uses the measurements from this position to calculate speaker distance, level, polarity, and the optimum crossover value for the subwoofer.
- ② **Second measurement point**  
The right side of the listening area.
- ③ **Third measurement point**  
The left side of the listening area.

The distances between points ① and ② and points ① and ③ must be at least 1 meter.

From the examples below, choose the listening area that best matches yours and place the microphone accordingly when prompted.

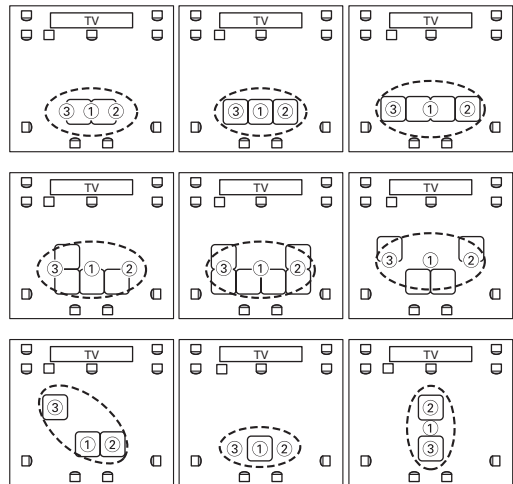

- : Listening area
- : Listening position

## Using Audyssey 2EQ™

### Notes:

- (Asian models) If any of your speakers is 4 ohms, change the Speaker Impedance setting before running the Audyssey 2EQ Room Correction and speaker setup (see page 44).
- If the AV receiver is muted, it will be unmuted automatically when the Audyssey 2EQ Room Correction and Speaker Setup starts.
- Room correction and speaker setup cannot be performed while a pair of headphones is connected.
- It takes about 10 minutes to complete the room correction and speaker setup for three positions. Total measurement time varies depending on the number of speakers.
- Do not connect or disconnect any speakers during room correction and speaker setup.

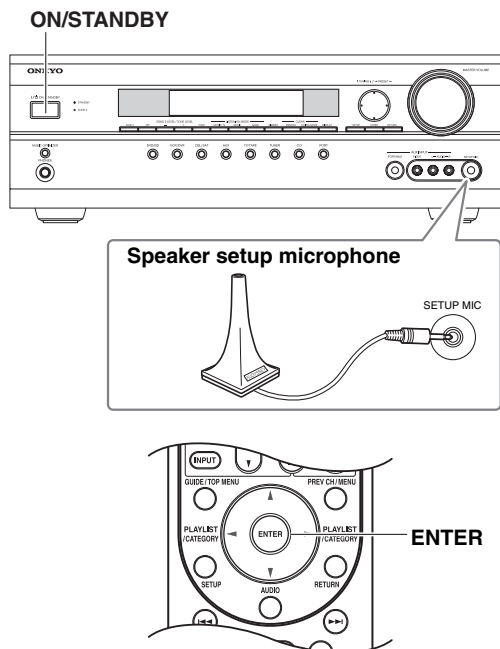

<b>1</b>	<b>Turn on the AV receiver.</b>
<b>2</b>	<p><b>Set the speaker setup microphone at the Main Listening Position ① (page 46), and connect it to the SETUP MIC jack.</b></p> <p style="text-align: center;">Audyssey indicator</p> <div style="text-align: center;"> </div> <p>The speaker setting menu appears. If you change these settings, refer to steps 5–6 on “Speaker Settings” (page 44) or step 5 on “Setting the Powered Zone 2” (page 81).</p>

### Notes:

- Before starting Audyssey 2EQ™ Room Correction and Speaker Setup, arrange the room and connect the speakers as you would for enjoying movies. Changes to the room after auto setup requires you run the auto setup again, as room EQ characteristics may have changed.
- When starting the room correction and speaker setup, do not stand between the speakers and microphone, and avoid obstacles blocking the path between speakers and microphone. This will produce inaccurate results.
- Position the microphone at ear height of a seated listener with the microphone tip pointed directly at the ceiling using a tripod. Do not hold the microphone in your hand during measurements as this will produce inaccurate results.
- Make the room as quiet as possible. Background noise can disrupt the room measurements. Close windows, silence cell phones, televisions, radios, air conditioners, fluorescent lights, home appliances, light dimmers, or other devices.
- Cell phones should be turned off or placed away from all audio electronics during the measurement process as Radio Frequency Interference (RFI) may cause measurement disruptions (even if the cell phone is not in use).

**3 Press [ENTER].**  
The room calibration and speaker setup starts.

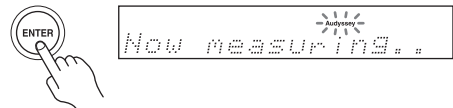

Test tones are played through each speaker as Audyssey 2EQ Room Correction and Speaker Setup runs. This process takes a few minutes. Please refrain from talking during measurements and do not stand between speakers and the microphone.

### Note:

You can cancel the Room Correction and Speaker Setup at any point in this procedure simply by disconnecting the setup microphone.

**4 When the following display appears, move the speaker setup microphone to measurement point ② (page 46), and then press [ENTER].**

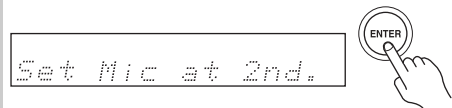

Audyssey 2EQ performs more measurements. This takes a few minutes.

- 5** When the following display appears, move the speaker setup microphone to measurement point ③ (page 46), and then press [ENTER].



Set Mic at 3rd.



Audyssey 2EQ™ performs more measurements.

This takes a few minutes.

When the measurements are complete, the results are calculated and saved automatically.

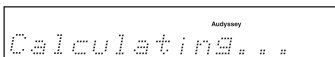

Calculating...

- 6** When the room correction and speaker setup is complete, disconnect the speaker setup microphone.



Unplug Setup Mic

### Notes:

- When the room correction and speaker setup is complete, the Equalizer Settings (page 70) will be set to “Audyssey” and the “Dynamic EQ” (page 72) will be set to “On”.
- You can cancel the Room Correction and Speaker Setup at any point in this procedure simply by disconnecting the setup microphone.

### Error Messages

While the room correction and speaker setup is in progress, one of the following error messages may appear:

- Ambient noise is too high**

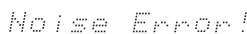

Noise Error!

This message appears if there's too much background noise and the measurements cannot be performed properly. Remove the source of the noise and try again.

- Speaker Detect Errors**

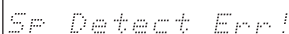

Sp Detect Err!

This message appears if one of the speaker-related errors below occurs.

- One of the front speakers has not been detected.
- One of the surround speakers has not been detected.
- The surround back speakers have been detected but the surround speakers haven't.

- The right surround back speaker has been detected but the left surround back speaker hasn't.

- Write Error**

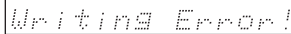

Writing Error!

This message appears if saving fails.

- Mismatch Error**



Sp Matching Err!

This message appears if a speaker that was detected during the 1st measurement is not detected during the 2nd or 3rd measurements. If this message appears, check your speaker connections, and then try again.

### To Retry the Room Correction and Speaker Setup

Press the [ENTER] button.

Make sure speakers that cannot be detected are connected properly.



### Changing the Speaker Settings Manually

If you wish to make changes to the settings found during the automatic speaker setup, follow the directions on pages 68–70.

### Using a Powered Subwoofer

If you're using a powered subwoofer, as it outputs very low-frequency sound and its position is usually low down, it may not be detected by the Audyssey 2EQ Room Correction and Speaker Setup. When “Subwoofer” is set to “No” in the “2-2.Sp Config (Speaker Configuration)” (page 68), increase the subwoofer's volume, select its highest crossover frequency, and then try running the Audyssey 2EQ Room Correction and Speaker Setup again. Note that if the volume is set too high and the sound distorts, it may not be detected, so use an appropriate volume level.



# Basic Operations

## Basic AV receiver Operation

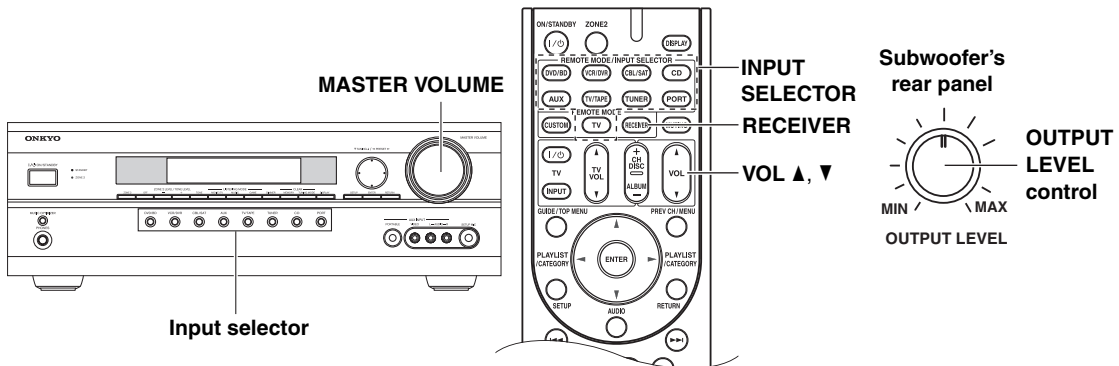

- 1**

**AV receiver**

**Remote controller**

**Use the AV receiver's input selector buttons to select an input source.**  
**To select an input source with the remote controller, press its [RECEIVER] button, and then use its INPUT SELECTOR buttons.**
- 2**

**Start playback on the source component.**  
 To watch a BD, DVD, or other video source, on your TV, select the video input that's connected to the AV receiver's COMPONENT VIDEO OUT, HDMI OUT, or MONITOR OUT.  
 On some DVD players, you may need to change the digital or HDMI audio output settings.
- 3**

**AV receiver**

**Remote controller**

**To adjust the volume, use the MASTER VOLUME control or the remote controller's VOL [▲]/[▼] button.**  
 Since the AV receiver is designed for home theaters, it has a wide volume range for precise adjustment. The volume can be set to Min, 1 through 79, or Max.  
**To set the level of the subwoofer, use the OUTPUT LEVEL control.**  
 Because our ears are less sensitive to very low bass sounds, there's a temptation to set the level of the subwoofer too high. As a rule of thumb, set the subwoofer level to what you think is the optimal level, and then back it off slightly.
- 4**

**Select a listening mode and enjoy!**  
 See "Using the Listening Modes" on page 61.

## Basic Operations—Continued

This section explains functions that can be used with any input source.

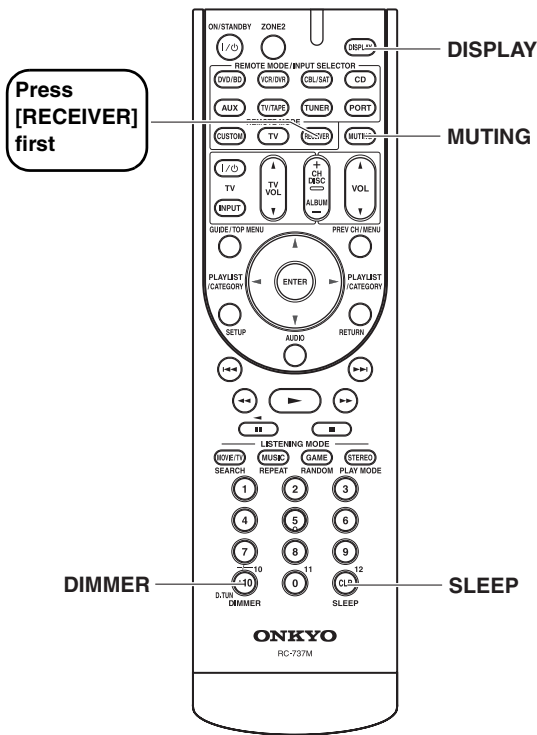

### MUSIC OPTIMIZER DIMMER DISPLAY

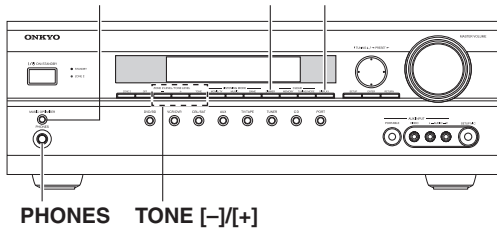

## Adjusting the Bass & Treble

You can adjust the bass and treble for the front speakers, except when the Direct, Pure Audio listening mode is selected.

AV receiver  
TONE

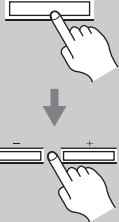

Press the [TONE] button repeatedly to select either "Bass" or "Treble". Use the TONE [-]/[+] buttons to adjust.

### Tip:

This procedure can also be performed on the remote controller by using [AUDIO] button (see page 73).

### ■ Bass

You can boost or cut low-frequency sounds output by the front speakers from -10 dB to +10 dB in 2 dB steps.

### ■ Treble

You can boost or cut high-frequency sounds output by the front speakers from -10 dB to +10 dB in 2 dB steps.

## Displaying Source Information

You can display various information about the current input source as follows.

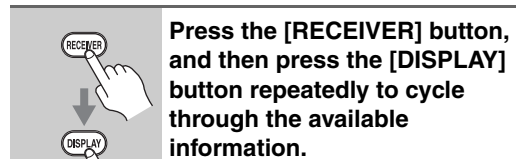

Press the [RECEIVER] button, and then press the [DISPLAY] button repeatedly to cycle through the available information.

### Note:

This procedure can also be performed on the AV receiver by using its [DISPLAY] button.

The following information can typically be displayed:

Input source & volume\*1 DVD/BD 48

Signal format\*2 or sampling frequency Dolby D 5.1

Input source & listening mode DVD Dolby D

\*1 When AM or FM radio is used, the band, preset number, and frequency are displayed.

\*2 If the input signal is analog, or AM or FM radio is selected, no format information is displayed. If the input signal is PCM, the sampling frequency is displayed. If the input signal is digital but not PCM, the signal format is displayed. Information is displayed for about 3 seconds, then the previous display reappears.

### Setting the Display Brightness

You can adjust the brightness of the display.

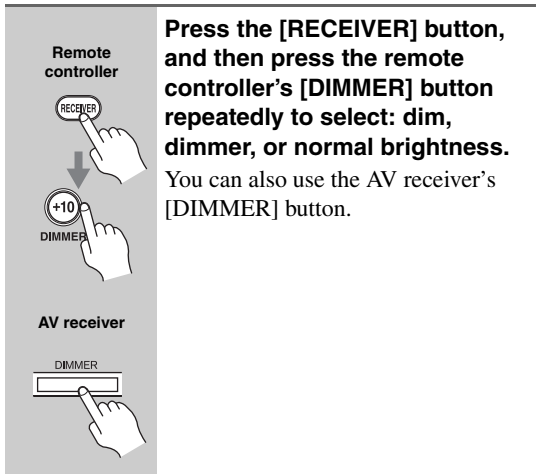

### Muting the AV receiver

You can temporarily mute the output of the AV receiver.

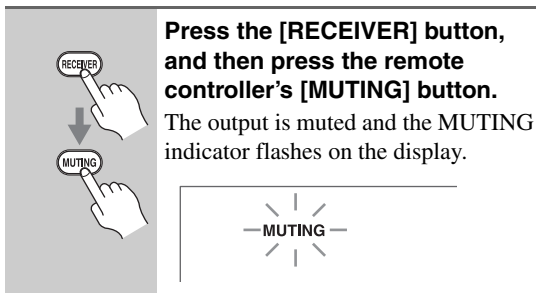

**To unmute the AV receiver,** press the remote controller's [MUTING] button again, or adjust the volume. The output is unmuted and the MUTING indicator goes off.

Muting is cancelled when the AV receiver is set to Standby.

### Using the Sleep Timer

With the sleep timer, you can set the AV receiver so that it turns off automatically after a specified period.

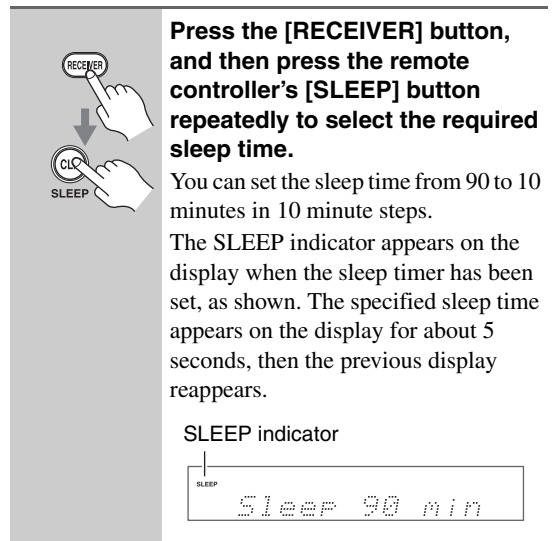

**To cancel the sleep timer,** press the [SLEEP] button repeatedly until the SLEEP indicator disappears.

**To check the remaining sleep time,** press the [SLEEP] button. Note that if you press the [SLEEP] button while the sleep time is being displayed, you'll shorten the sleep time by 10 minutes.

### Using Headphones

For private listening, you can connect a pair of stereo headphones (1/4-inch phone plug) to the AV receiver's PHONES jack.

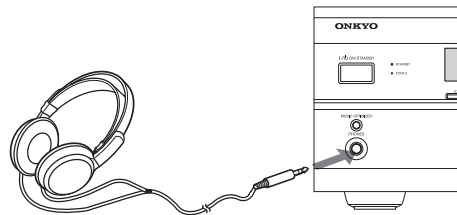

#### Notes:

- Always turn down the volume before connecting your headphones.
- While the headphones plug is inserted in the PHONES jack, the speakers are turned off. (The Powered Zone 2 speakers are not turned off.)
- When you connect a pair of headphones, the listening mode is set to Stereo, unless it was already set to Pure Audio, Mono, Stereo, or Direct, in which case it stays the same. (Pure Audio listening mode is not available for North American models.)

## Using the Music Optimizer

The Music Optimizer function enhances the sound quality of compressed music files. Use it with music files that use “lossy” compression, such as MP3.

### MUSIC OPTIMIZER



**(North American models) To turn the Music Optimizer “On” or “Off”, use the AV receiver’s [MUSIC OPTIMIZER] button .**

The setting is stored individually for each input selector.

**Off:** Music Optimizer off (default).  
**On:** Music Optimizer on.

#### Tip:

This procedure can also be performed on the remote controller by using [AUDIO] button (see page 74).

#### Note:

The Music Optimizer function only works with PCM digital audio input signals with a sampling rate below 48 kHz and analog audio input signals. The Music Optimizer is disabled when the Direct or Pure Audio listening mode is selected.

## Specifying the Digital Signal Format

The following table shows the display indicator for each digital signal format.

Format	Display
Dolby Digital	D
DTS	
PCM	PCM

Normally, the AV receiver detects the format of digital input signals automatically. However, if you experience either of the following issues when playing PCM or DTS sources, you can specify the signal format manually.

- If the beginnings of tracks from a PCM source are cut off, try the PCM setting.
- If noise is produced when fast forwarding or rewinding a DTS CD, try the DTS setting.
- The setting is stored individually for each input selector.

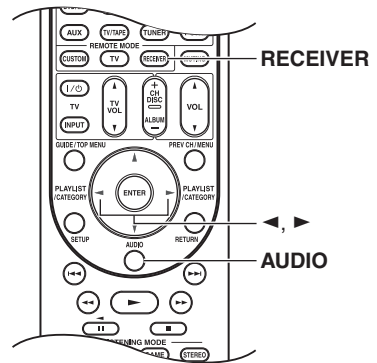

**1**



Press the [RECEIVER] button, and then press and hold [AUDIO] button for about 8 seconds.

**2**



While “Auto” is displayed (about 3 seconds), use the Left and Right [◀/▶] buttons to select: PCM, DTS, or Auto.

#### PCM:

Only 2-channel PCM format input signals will be heard. If the input signal is not PCM, the PCM indicator will flash and there will be no sound.

#### DTS:

Only DTS format input signals will be heard. If the input signal is not DTS, the DTS indicator will flash and there will be no sound.

#### Auto (default):

The format is detected automatically. If no digital input signal is present, the corresponding analog input is used instead.

# Listening to the Radio

## AM/FM Frequency Step Setup

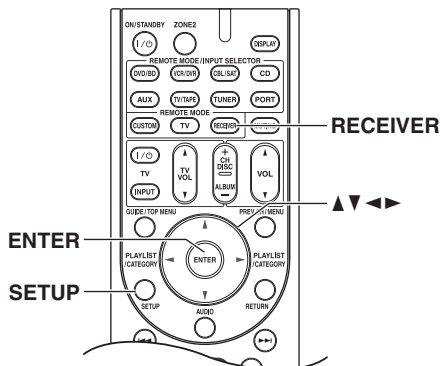

For AM/FM tuning to work properly, you must specify the AM/FM frequency step used in your area. Note that when this setting is changed, all radio presets are deleted.

**1** Press the [RECEIVER] button, followed by the [SETUP] button.



**2** Use the Up and Down [▲]/[▼] buttons to select "7. HardwareSetup", and then press [ENTER].

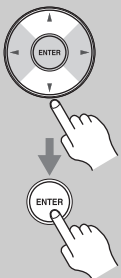

**3** Use the Up and Down [▲]/[▼] buttons to select "7-2. Tuner", and then press [ENTER].

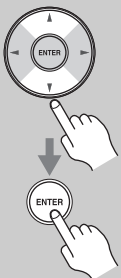

**4** Use the Up and Down [▲]/[▼] buttons to select "FM/AM" (North American models) or "AM Freq" (Asian models).



(North American models)

FM/AM : 50k/ 9k

(Asian models)

AM Freq : 9kHz

**5** Use the Left and Right [◀]/[▶] buttons to select:



(North American models)

**200k/10k:**

Select if 200 k/10 k steps are used in your area.

**50k/9k:** Select if 50 k/9 k steps are used in your area.

(Asian models)

**10kHz:** Select if 10 kHz steps are used in your area.

**9kHz:** Select if 9 kHz steps are used in your area.

**6** Press the [SETUP] button.



Setup closes.

### Note:

This procedure can also be performed on the AV receiver by using its [SETUP] button, arrow buttons, and [ENTER] button.

## Listening to the Radio—Continued

### Using the Tuner

With the built-in tuner, you can enjoy AM and FM radio stations and store your favorite stations as presets for easy selection.

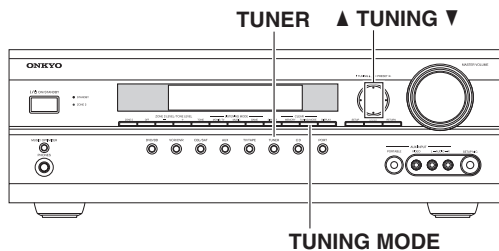

### Listening to the Radio

TUNER



Use the [TUNER] input selector button to select “AM” or “FM”.

In this example, FM has been selected.

Band                      Frequency

FM 87.5 MHz

(Actual display depends on country.)

### Tuning into AM/FM Radio Stations

#### ■ Auto Tuning Mode

1

TUNING MODE



Press the [TUNING MODE] button so that the AUTO indicator appears on the display.

2

▼ TUNING ▲

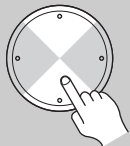

Press the TUNING Up or Down [▲]/[▼] button.

Searching stops when a station is found.

When tuned into a station, the TUNED indicator appears. When tuned into a stereo FM station, the FM STEREO indicator also appears.

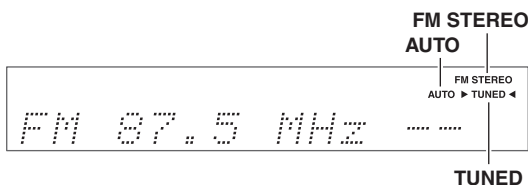

#### ■ Manual Tuning Mode

1

TUNING MODE



Press the [TUNING MODE] button so that the AUTO indicator disappears from the display.

2

▼ TUNING ▲

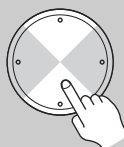

Press and hold the TUNING Up or Down [▲]/[▼] button.

The frequency stops changing when you release the button.

Press the button repeatedly to change the frequency one step at a time.

This model changes FM/AM frequency in 200 k/10 k (or 50 k/9 k) Hz steps.

In Manual Tuning mode, FM stations will be in mono.

#### Tuning into Weak FM Stereo Stations

If the signal from a stereo FM station is weak, it may be impossible to get good reception. In this case, switch to Manual Tuning mode and listen to the station in mono.

#### Note:

You can also use the remote controller's Up and Down [▲]/[▼] buttons to tune the radio.

# Listening to the Radio—Continued

## ■ Tuning into Stations by Frequency

You can tune into AM and FM stations directly by entering the appropriate frequency.

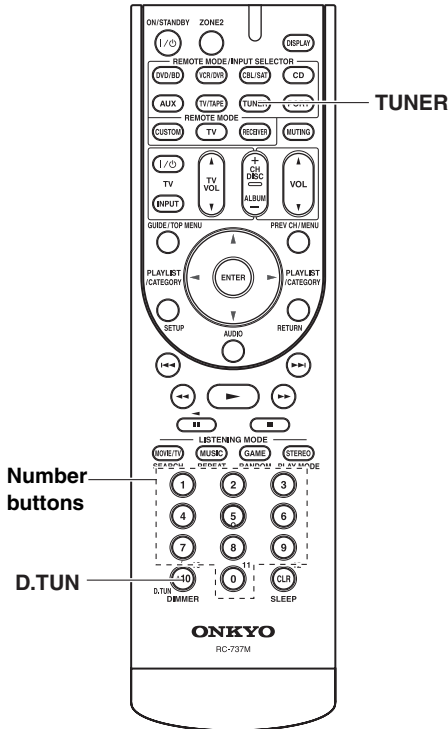

## Displaying AM/FM Radio Information

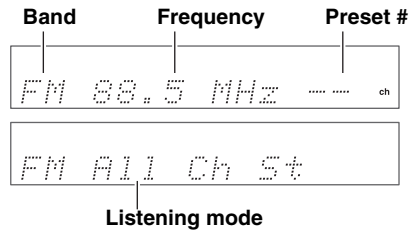
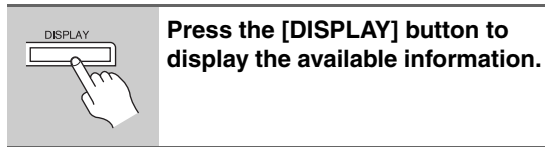
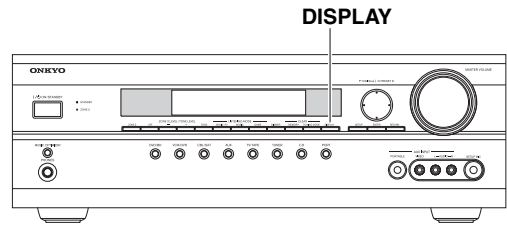

**1**

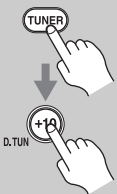

Press the [TUNER] button repeatedly to select “AM” or “FM”, followed by the [D.TUN] button.

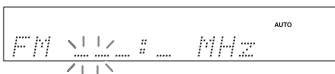

(Actual display depends on country.)

**2**



Within 8 seconds, use the number buttons to enter the frequency of the radio station.

For example, to tune to 87.5 (FM), press 8, 7, 5.

## Presetting AM/FM Stations

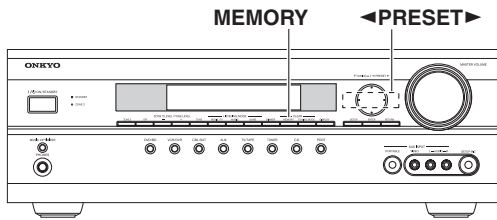

You can store a combination of up to 40 of your favorite AM and FM radio stations.

- 1** **Tune into the AM or FM station you want to store as a preset.**
- 2** **Press the [MEMORY] button.**  
The preset number flashes.
- 3** **While the preset number is flashing (about 8 seconds), use the PRESET [◀]/[▶] buttons to select a preset from 1 through 40.**
- 4** **Press the [MEMORY] button again to store the station.**  
The station is stored and the preset number stops flashing.  
Repeat this procedure for all of your favorite stations.

## Deleting Presets

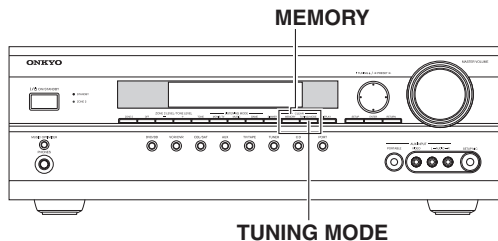

- 1** **Select the preset that you want to delete.**  
See the next section.
- 2** **While holding down the [MEMORY] button, press the [TUNING MODE] button.**  
The preset is deleted and its number disappears from the display.

## Selecting Presets

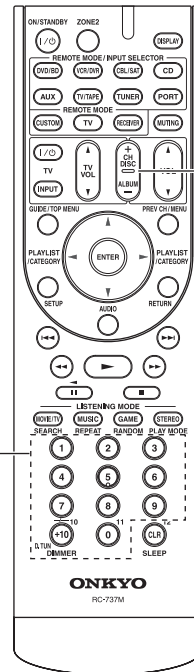
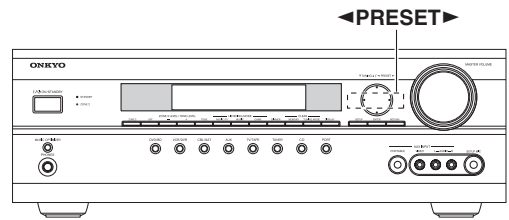

- AV receiver**  
**or**  
**Remote controller**  
**or**
- To select a preset, use the PRESET [◀]/[▶] buttons or the remote controller's CH [+/-] button.**
- You can also use the remote controller's number buttons to select a preset directly.**



# UP-A1 series Dock for iPod/iPhone

## About the UP-A1 series Dock

With the UP-A1 series Dock, you can easily play the music, photo, or movie stored on your Apple iPod or iPhone through the AV receiver and enjoy great sound. You can use the AV receiver's remote controller to operate your iPod or iPhone.

For the latest information on the Dock, see the Onkyo Web site at: [www.onkyo.com](http://www.onkyo.com)

Adapter

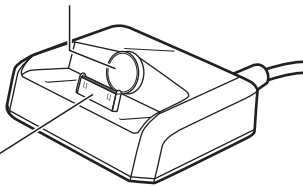

Dock connector

## Compatible iPod/iPhone models

### ■ Made for:

- All iPhone models
- iPod touch (2nd generation)
- iPod touch (1st generation)
- iPod classic
- iPod (5th generation)
- iPod (4th generation)
- iPod nano (4th generation)
- iPod nano (3rd generation)
- iPod nano (2nd generation)
- iPod nano (1st generation)
- iPod mini

### Note:

Before using the UP-A1 series Dock, update your iPod or iPhone with the latest software, available from the Apple Web site.

## Putting Your iPod/iPhone in the Dock

1. Turn on the AV receiver, and select the [PORT] selector.
2. Align your iPod or iPhone with the Dock connector, and carefully place your iPod or iPhone in the slot, as shown.

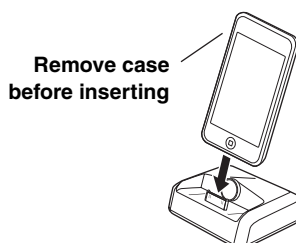

## ■ Adjusting the Adapter

The adapter needs to be adjusted to match your particular iPod or iPhone. If there's a gap between the back of your iPod or iPhone and the adapter, turn the adapter counterclockwise to close the gap. Turning the adapter counterclockwise moves it forward. Turning it clockwise moves it backward.

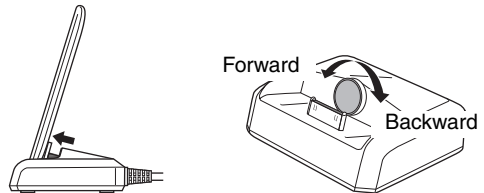

### Notes:

- Make sure that the output level of the AV receiver is set to minimum.
- To prevent damage to the dock connector, don't twist your iPod or iPhone when inserting or removing it, and be careful not to knock over the dock while your iPod or iPhone is inserted.
- Do not take off your iPod or iPhone from the Dock when you play back the music, photo, or movie stored on your iPod or iPhone.
- Don't use the UP-A1 with any other iPod or iPhone accessories, such as FM transmitters and microphones, because they may cause a malfunction.
- It is recommended that you update your iPod or iPhone software before using it with this unit. The updater for the iPod or iPhone software is available at the Apple website.

## Function Overview

### ■ Basic Operation

#### Note:

The AV receiver may take several seconds to startup, so you might not hear the first few seconds of the first song.

#### • Auto Power On Function

If you start iPod or iPhone playback while the AV receiver is on Standby, the AV receiver will automatically turn on and select your iPod or iPhone as the input source. Then, your iPod or iPhone will start playback.

#### • Direct Change Function

If you start iPod or iPhone playback while listening to another input source, the AV receiver will automatically select your iPod or iPhone as the input source.

#### • Using the AV receiver's Remote Controller

You can use the AV receiver's remote controller to control basic iPod or iPhone functions.

## Operating Notes:

- Before selecting a different input source, stop iPod or iPhone playback to prevent the AV receiver from selecting the iPod or iPhone input source by mistake.
- If any accessories are connected to your iPod or iPhone, the AV receiver may not be able to select the input source properly.
- While your iPod or iPhone is in the UP-A1 series Dock, its volume control has no effect. If you adjust your iPod or iPhone models volume control while it's in the UP-A1 series Dock, make sure it's not set too high before you reconnect your headphones.

## ■ Using Your iPod or iPhone models Alarm Clock

You can use your iPod or iPhone models Alarm Clock function to automatically turn on your iPod or iPhone and the AV receiver at a specified time. The AV receiver's input source will automatically be set to the [PORT] selector.

### Notes:

- To use this function, your iPod or iPhone must be in the UP-A1 series Dock, and the UP-A1 series Dock must be connected to the AV receiver.
- When you use this function, be sure to set the AV receiver's volume control to a suitable level.
- The AV receiver may take several seconds to startup, so you might not hear the first few seconds of the first song.

## ■ Charging Your iPod or iPhone models Battery

The UP-A1 series Dock charges your iPod or iPhone models battery while your iPod or iPhone is in the UP-A1 series Dock and connected to the UNIVERSAL PORT jacks on the AV receiver. While your iPod or iPhone is seated in the UP-A1 series Dock, its battery will be charged when the AV receiver is set to "On" or "Standby".

### Note:

When UP-A1 series Dock that seated iPod or iPhone is connected, the power consumption on standby mode slightly increases.

## Controlling iPod/iPhone

By pressing the REMOTE MODE button that's been programmed with the remote control code for your Dock, you can control your iPod or iPhone in the Dock with the following buttons.

The [PORT] button is preprogrammed with the remote control code for controlling a Dock with Universal Port connector.

For details on entering a remote control code, see page 84.

### When Using a Dock with Universal Port connector:

- Connect the Dock to the UNIVERSAL PORT jack.
- See to the Dock's instruction manual for more information.

You can control your iPod or iPhone when "PORT" is selected as the input source.

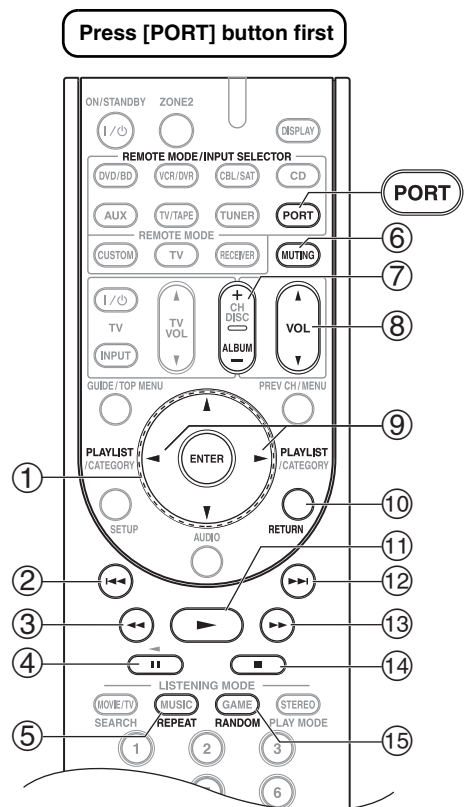

### Note:

For detailed operation of the iPod or iPhone, please refer to the instruction manual.

- ① **Arrow [▲]/[▼] and ENTER buttons**  
Used to navigate menus and select items.
- ② **Previous [◀◀] button**  
Restarts the current song. Press it twice to select the previous song.
- ③ **Rewind [◀◀] button**  
Press and hold to rewind.
- ④ **Pause [⏸] button**  
Pauses playback.
- ⑤ **REPEAT button**  
Used with the repeat function.
- ⑥ **MUTING button (51)**  
Mutes or unmutes the AV receiver.
- ⑦ **ALBUM +/- button**  
Selects the next or previous album.
- ⑧ **VOL [▲]/[▼] button (49)**  
Adjusts the volume of the AV receiver.
- ⑨ **PLAYLIST [◀]/[▶] buttons**  
Selects the previous or next playlist on the iPod or iPhone.
- ⑩ **RETURN button**  
Exits the menu or returns to the previous menu.
- ⑪ **Play [▶] button**  
Starts playback. If the component is off, it will turn on automatically.
- ⑫ **Next [▶▶] button**  
Selects the next song.
- ⑬ **Fast Forward [▶▶] button**  
Press and hold to fast forward.
- ⑭ **Stop [■] button**  
Stops playback and displays a menu.
- ⑮ **RANDOM button**  
Used with the shuffle function.

### Status messages

- The AV receiver is checking the connection with the dock**



PORT Reading

- The AV receiver do not support the connected dock**



PORT NotSupport

- UP-A1 series Dock is connected**



PORT UP-A1

Your iPod or iPhone is properly stationed in a UP-A1 series Dock connected to the UNIVERSAL PORT jack of this unit, and the connection between your iPod or iPhone and this unit is complete.

When connection is confirmed, “UP-A1” is displayed for about 8 seconds.

- Dock is not connected**



PORT

Your iPod or iPhone was removed from a UP-A1 series Dock connected to the UNIVERSAL PORT jack of this unit.

#### Note:

When the status message is not displayed on the AV receiver’s display, check the connection to your iPod or iPhone.

# Recording

This section explains how to record the input source and how to record audio and video from separate sources.

## Notes:

- The surround sound and DSP listening modes cannot be recorded.
- Copy-protected DVDs cannot be recorded.
- Sources connected to a digital input cannot be recorded. Only analog inputs can be recorded.
- DTS signals will be recorded as noise, so don't attempt analog recording of DTS CDs or LDs.
- While the Pure Audio listening mode is selected, the VCR/DVR OUT V jack don't output video signal, so select another mode when recording.

## Recording the Input Source

Audio sources can be recorded to a recorder (e.g., cassette deck, CDR, MD) connected to the TV/TAPE OUT jack. Video sources can be recorded to a video recorder (e.g., VCR, DVR) connected to the VCR/DVR OUT jacks. See pages 25 to 39 for hookup information.

**1**

**AV receiver**

DIVIDED VCR/DVR CBL/SAT  
AUX TV/TAPE TUNER  
CD PORT



**Remote controller**

DVD/BD VCR/DVR  
CBL/SAT CD  
AUX TV/TAPE  
TUNER PORT



**Use the input selector buttons to select the source that you want to record.**

See “Which Connections Should I Use?” on page 26 to see which signals can be output and recorded.

You can watch the source while recording it. The AV receiver's MASTER VOLUME control has no effect on recording.

---

**2**

**On your recorder, start recording.**

---

**3**

**On the source component, start playback.**

## Note:

If you select a different input source during recording, that input source will be recorded instead.

## Recording from Different AV Sources

You can overdub audio onto your video recordings by simultaneously recording audio and video from two separate sources. This is possible because only the audio source is switched when an audio-only input source, such as TV/TAPE, TUNER, or CD, is selected, the video source remains the same.

In the following example, audio from the CD player connected to the CD IN and video from the camcorder connected to the AUX INPUT VIDEO jack are recorded by the VCR connected to the VCR/DVR OUT jacks.

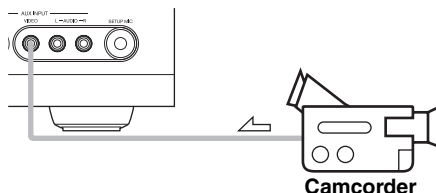

↗ : video signal  
↘ : audio signal

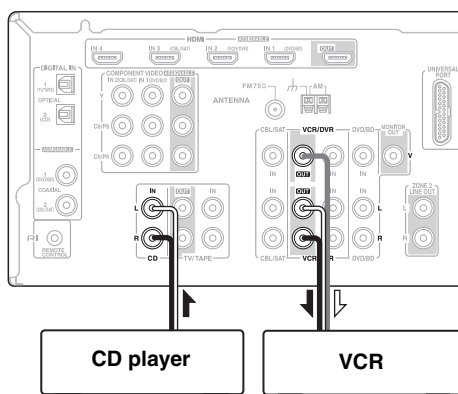

- 1** Prepare the camcorder and CD player for playback.
- 2** Prepare the VCR for recording.
- 3** Press the [AUX] input selector button.
- 4** Press the [CD] input selector button.  
This selects the CD player as the audio source but leaves the camcorder as the video source.
- 5** Start recording on the VCR, then start playback on the camcorder and CD player.  
Video from the camcorder and audio from the CD player are recorded by the VCR.

# Using the Listening Modes

## Selecting Listening Modes

For a description of each listening mode, see “About the Listening Modes” on page 66.

- The Dolby Digital and DTS listening modes can only be selected if your DVD player is connected to the AV receiver with a digital audio connection (COAXIAL, OPTICAL, or HDMI).
- The listening modes you can select depends on the format of the input signal. To check the format, see “Displaying Source Information” on page 50.
- While a pair of headphones is connected, you can only select the Pure Audio, Mono, Direct, or Stereo listening mode.

## Selecting on the AV receiver

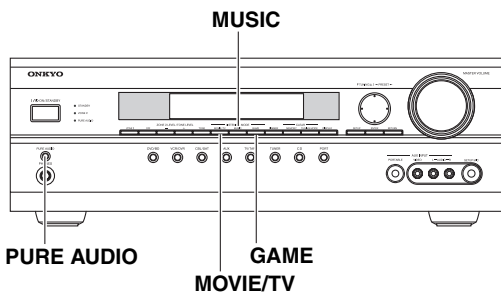

### ■ [PURE AUDIO] button (Asian models)

This button selects the Pure Audio listening mode. When this mode is selected, the AV receiver's display is turned off and only the HDMI outputs output video signals. Pressing this button again will select the previous listening mode.

### ■ LISTENING MODE buttons

#### [MOVIE/TV] button

This button selects the listening modes intended for use with movies and TV.

#### [MUSIC] button

This button selects the listening modes intended for use with music.

#### [GAME] button

This button selects the listening modes intended for use with video games.

## Selecting with the Remote Controller

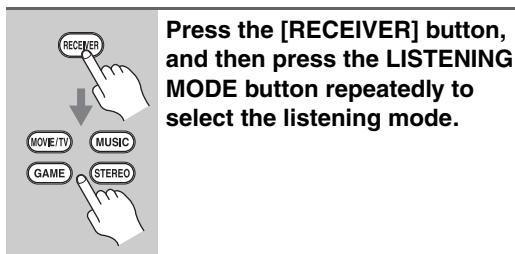
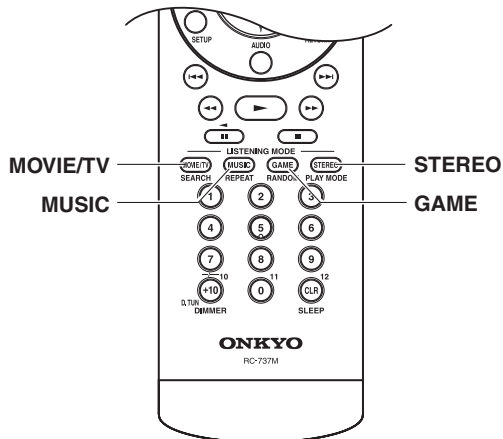

### ■ LISTENING MODE buttons

#### [MOVIE/TV] button

This button selects the listening modes intended for use with movies and TV.

#### [MUSIC] button

This button selects the listening modes intended for use with music.

#### [GAME] button

This button selects the listening modes intended for use with video games.

#### [STEREO] button

This button selects the Stereo listening mode and All Channel Stereo listening mode.

**Listening Modes Available for Each Source Format**

The Speaker layout illustration shows which speakers are set to active in the “Sp Config” setting (see page 68).

The LISTENING MODE button illustration shows that listening modes can be selected.

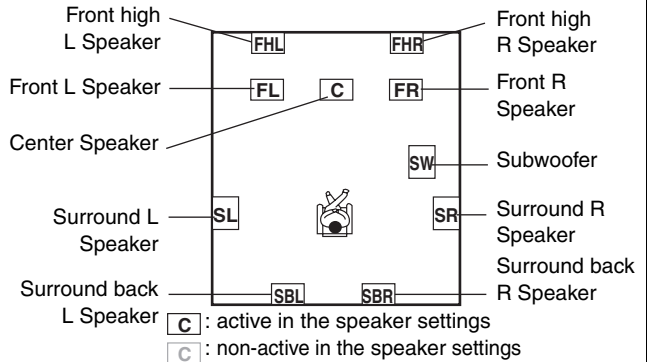

**Mono/Multiplex Sources**

✓: Available Listening Modes

Listening Mode	Button	Speaker layout			
Pure Audio <sup>*1</sup>		✓	✓	✓	✓
Direct		✓	✓	✓	✓
Stereo		✓	✓	✓	✓
Mono		✓	✓	✓	✓
Orchestra				✓	✓ <sup>*2</sup>
Unplugged				✓	✓ <sup>*2</sup>
Studio-Mix				✓	✓ <sup>*2</sup>
TV Logic				✓	✓ <sup>*2</sup>
Game-RPG				✓	✓ <sup>*2</sup>
Game-Action				✓	✓ <sup>*2</sup>
Game-Rock				✓	✓ <sup>*2</sup>
Game-Sports				✓	✓ <sup>*2</sup>
AllChStereo	 		✓	✓	✓ <sup>*2</sup>
FullMono			✓	✓	✓ <sup>*2</sup>
T-D (Theater-Dimensional)		✓	✓	✓	✓

**Notes:**

\*1 Pure Audio listening mode is not available for North American models.

\*2 Which Front high speakers or Surround back speakers outputs the sound is switched by the “SpLayout” setting on page 74.

- Available sampling rate for PCM input signal is 32/44.1/48/88.2/96/176.4/192 kHz.
- The listening modes cannot be selected with some source formats.

# Using the Listening Modes—Continued

## Stereo Source

✓: Available Listening Modes

Listening Mode	Button	Speaker layout			
Pure Audio <sup>*1</sup>		✓	✓	✓	✓
Direct		✓	✓	✓	✓
Stereo		✓	✓	✓	✓
Mono		✓	✓	✓	✓
PLII/PLIIX Movie <sup>*3</sup>			✓	✓	✓ (Surround Back)
PLII/PLIIX Music <sup>*3</sup>			✓	✓	✓ (Surround Back)
PLII/PLIIX Game <sup>*3</sup>			✓	✓	✓ (Surround Back)
PLIIZ Height					✓ (Front High)
Neo:6 Cinema			✓	✓	✓ (Surround Back)
Neo:6 Music			✓	✓	✓ (Surround Back)
Orchestra				✓	✓ <sup>*2</sup>
Unplugged				✓	✓ <sup>*2</sup>
Studio-Mix				✓	✓ <sup>*2</sup>
TV Logic				✓	✓ <sup>*2</sup>
Game-RPG				✓	✓ <sup>*2</sup>
Game-Action				✓	✓ <sup>*2</sup>
Game-Rock				✓	✓ <sup>*2</sup>
Game-Sports				✓	✓ <sup>*2</sup>
AllChStereo			✓	✓	✓ <sup>*2</sup>
FullMono			✓	✓	✓ <sup>*2</sup>
T-D (Theater-Dimensional)		✓	✓	✓	✓

**Notes:**

- \*1 Pure Audio listening mode is not available for North American models.
- \*2 Which Front high speakers or Surround back speakers outputs the sound is switched by the “SpLayout” setting on page 74.
- \*3 If there are no surround back speakers or Powered Zone 2 is being used, Dolby Pro Logic II is used.
- Available sampling rate for PCM input signal is 32/44.1/48/88.2/96/176.4/192 kHz.
- The listening modes cannot be selected with some source formats.

# Using the Listening Modes—Continued

## 5.1 channel Sources

✓: Available Listening Modes

Listening Mode	Button	Speaker layout			
Pure Audio <sup>*1</sup>		✓	✓	✓	✓
Direct		✓	✓	✓	✓
Stereo		✓	✓	✓	✓
Mono		✓	✓	✓	✓
DolbyDigital/ DolbyDigital Plus/TrueHD/ Multichannel/ DTS/DTS-HD High Resolution Audio/DTS-HD Master Audio/ DTS Express/ DSD <sup>*3</sup>			✓	✓	✓
Neo:6					✓ (Surround Back)
PLIIx Movie					✓ (Surround Back)
PLIIx Music					✓ (Surround Back)
PLIIz Height					✓ (Front High)
DolbyEX					✓ (Surround Back)
Orchestra				✓	✓ <sup>*2</sup>
Unplugged				✓	✓ <sup>*2</sup>
Studio-Mix				✓	✓ <sup>*2</sup>
TV Logic				✓	✓ <sup>*2</sup>
Game-RPG				✓	✓ <sup>*2</sup>
Game-Action				✓	✓ <sup>*2</sup>
Game-Rock				✓	✓ <sup>*2</sup>
Game-Sports				✓	✓ <sup>*2</sup>
AllChStereo			✓	✓	✓ <sup>*2</sup>
FullMono			✓	✓	✓ <sup>*2</sup>
T-D (Theater-Dimensional)		✓	✓	✓	✓

### Notes:

\*1 Pure Audio listening mode is not available for North American models.

\*2 Which Front high speakers or Surround back speakers outputs the sound is switched by the “SpLayout” setting on page 74.

\*3 AV receiver can input the DSD signal from HDMI IN. Setting the output setting on the player side to PCM might obtain a better sound according to the player. In that case, set the output setting on the player side to PCM.

- Available sampling rate for PCM input signal is 32/44.1/48/88.2/96/176.4/192 kHz.
- The listening modes cannot be selected with some source formats.



# Using the Listening Modes—Continued

## 7.1 channel Sources

✓: Available Listening Modes

Listening Mode	Button	Speaker layout			
Pure Audio <sup>*1</sup>		✓	✓	✓	✓ <sup>*3</sup> (Surround Back)
Direct		✓	✓	✓	✓ <sup>*3</sup> (Surround Back)
Stereo		✓	✓	✓	✓
Mono		✓	✓	✓	✓
Multichannel/Dolby Digital Plus/TrueHD/DTS-HD High Resolution Audio/DTS-HD Master Audio			✓	✓	✓ <sup>*3</sup> (Surround Back)
PLIiz Height					✓ (Front High)
Orchestra				✓	✓ <sup>*2</sup>
Unplugged				✓	✓ <sup>*2</sup>
Studio-Mix				✓	✓ <sup>*2</sup>
TV Logic				✓	✓ <sup>*2</sup>
Game-RPG				✓	✓ <sup>*2</sup>
Game-Action				✓	✓ <sup>*2</sup>
Game-Rock				✓	✓ <sup>*2</sup>
Game-Sports				✓	✓ <sup>*2</sup>
AllChStereo			✓	✓	✓ <sup>*2</sup>
FullMono			✓	✓	✓ <sup>*2</sup>
T-D (Theater-Dimensional)		✓	✓	✓	✓

## DTS-ES Discrete/Matrix Sources

DTS-ES Discrete					✓ (Surround Back)
DTS-ES Matrix					✓ (Surround Back)

### Notes:

- \*1 Pure Audio listening mode is not available for North American models.
- \*2 Which Front high speakers or Surround back speakers outputs the sound is switched by the “SpLayout” setting on page 74.
- \*3 When the input source contains the encoded front high channel, front high speakers output the sound.
- Available sampling rate for PCM input signal is 32/44.1/48/88.2/96/176.4/192 kHz.
- The listening modes cannot be selected with some source formats.

### About the Listening Modes

The AV receiver's listening modes can transform your listening room into a movie theater or concert hall, with high fidelity and stunning surround sound.

#### Pure Audio

In this mode, the display and video circuitry are turned off, minimizing possible noise sources for the ultimate in high-fidelity reproduction. (As the video circuitry is turned off, only video signals input through HDMI IN can be output.)

#### Direct

In this mode, audio from the input source is output directly with minimal processing, providing high-fidelity reproduction. All of the source's audio channels are output as they are.

#### Stereo

Sound is output by the front left and right speakers and subwoofer.

#### Mono

Use this mode when watching an old movie with a mono soundtrack, or use it with the foreign language soundtracks recorded in the left and right channels of some movies. It can also be used with DVDs or other sources containing multiplexed audio, such as karaoke DVDs.

#### Multichannel

This mode is for use with PCM multichannel sources.

#### Dolby Pro Logic IIx

##### Dolby Pro Logic II

**Dolby Pro Logic IIx** expands any 2-channel source for 7.1-channel playback. It provides a very natural and seamless surround-sound experience that fully envelops the listener. As well as music and movies, video games can also benefit from the dramatic spatial effects and vivid imaging. If you're not using any surround back speakers, **Dolby Pro Logic II** will be used instead of Dolby Pro Logic IIx.

- **Dolby PLIIx Movie**

Use this mode with any stereo or Dolby Surround (Pro Logic) movie (e.g., TV, DVD, VHS).

- **Dolby PLIIx Music**

Use this mode with any stereo or Dolby Surround (Pro Logic) music source (e.g., CD, radio, cassette, TV, VHS, DVD).

- **Dolby PLIIx Game**

Use this mode with video games, especially those that bear the Dolby Pro Logic II logo.

#### Dolby Pro Logic IIz Height

**Dolby Pro Logic IIz Height** is designed to more effectively use existing program material when height channel speaker outputs are present. **Dolby Pro Logic IIz Height** can be used to upmix a variety of sources from movies and music, but are particularly well-suited to upmix game content.

#### Dolby Digital

Use this mode with DVDs that bear the Dolby Digital logo, and Dolby Digital TV broadcasts. This is the most common digital surround-sound format, and it'll put you right in the middle of the action, just like being in a movie theater or concert hall.

#### 5.1-channel source + Dolby EX

These modes expand 5.1-channel sources for 6.1/7.1-channel playback. They're especially suited to Dolby EX soundtracks that include a matrix-encoded surround back channel. The additional channel adds an extra dimension and provides an enveloping surround sound experience, perfect for rotating and fly-by sound effects.

#### Dolby Digital Plus

Developed for use with HDTV, including the new video disc formats Blu-ray and HD DVD, this is the latest multichannel audio format from Dolby. It supports up to 7.1 channels with 48 kHz sampling rate.

#### Dolby TrueHD

Designed to take full advantage of the additional storage space offered by the new Blu-ray and HD DVD disc formats, this new Dolby format offers up to 7.1 discrete channels of digital audio with 48/96 kHz, up to 5.1-channels with 192 kHz sampling rate.

#### 5.1-channel source + Dolby PLIIx Music

These modes use the Dolby Pro Logic IIx Music mode to expand 5.1-channel sources for 6.1/7.1-channel playback.

#### 5.1-channel source + Dolby PLIIx Movie

These modes use the Dolby Pro Logic IIx Movie mode to expand 5.1-channel sources for 7.1-channel playback.

#### DTS

The DTS digital surround-sound format supports up to 5.1 discrete channels and uses less compression for high-fidelity reproduction. Use it with DVDs and CDs that bear the DTS logo.

#### DTS 96/24

This mode is for use with DTS 96/24 sources. This is high-resolution DTS with a 96 kHz sampling rate and 24-bit resolution, providing superior fidelity. Use it with DVDs that bear the DTS 96/24 logo.

#### DTS-ES Discrete

This mode is for use with DTS-ES Discrete soundtracks, which use a discrete surround back channel for true 6.1/7.1-channel playback. The seven totally separate audio channels provide better spatial imaging and 360-degree sound localization, perfect for sounds that pan across the surround channels. Use it with DVDs that bear the DTS-ES logo, especially those with a DTS-ES Discrete soundtrack.

### **DTS-ES Matrix**

This mode is for use with DTS-ES Matrix soundtracks, which use a matrix-encoded back-channel for 6.1/7.1-channel playback. Use it with DVDs that bear the DTS-ES logo, especially those with a DTS-ES Matrix soundtrack.

### **DTS Neo:6**

This mode expands any 2-channel source for up to 7.1-channel playback. It uses seven full-bandwidth channels of matrix decoding for matrix-encoded material, providing a very natural and seamless surround sound experience that fully envelops the listener.

- **Neo:6 Cinema**

Use this mode with any stereo movie (e.g., TV, DVD, VHS).

- **Neo:6 Music**

Use this mode with any stereo music source (e.g., CD, radio, cassette, TV, VHS, DVD).

### **5.1-channel source + Neo:6**

This mode uses Neo:6 to expand 5.1-channel sources for 6.1/7.1-channel playback.

### **DTS-HD High Resolution Audio**

Developed for use with HDTV, including the new video disc formats Blu-ray and HD DVD, this is the latest multichannel audio format from DTS. It supports up to 7.1 channels with 96 kHz sampling rate.

### **DTS-HD Master Audio**

Designed to take full advantage of the additional storage space offered by the new Blu-ray and HD DVD disc formats, this new DTS format offers up to 7.1 discrete channels of digital audio with 48/96 kHz, up to 5.1-channels with 192 kHz sampling rate.

### **DTS Express**

This format supports up to 5.1 channels and a lower sampling rate of 48 kHz. Applications include interactive audio and commentary encoding for HD DVD Sub Audio and Blu-ray Secondary Audio. Also broadcast and media servers.

### **DSD**

DSD stands for Direct Stream Digital and is the format used to store digital audio on Super Audio CDs (SACD). This mode can be used with SACDs that feature multichannel audio.

## **Onkyo Original DSP Modes**

---

### **Orchestra**

Suitable for classical or operatic music, this mode emphasizes the surround channels in order to widen the stereo image, and simulates the natural reverberation of a large hall.

### **Unplugged**

Suitable for acoustic instruments, vocals, and jazz, this mode emphasizes the front stereo image, giving the impression of being right in front of the stage.

### **Studio-Mix**

Suitable for rock or pop music, listening to music in this mode creates a lively sound field with a powerful acoustic image, like being at a club or rock concert.

### **TV Logic**

This mode adds realistic acoustics to TV shows produced in a TV studio, surround effects to the entire sound, and clarity to voices.

### **Game-RPG**

Use this mode when playing role playing game discs.

### **Game-Action**

Use this mode when playing action game discs.

### **Game-Rock**

Use this mode when playing rock game discs.

### **Game-Sports**

Use this mode when playing sports game discs.

### **All Ch Stereo**

Ideal for background music, this mode fills the entire listening area with stereo sound from the front, surround, and surround back speakers.

### **Full Mono**

In this mode, all speakers output the same sound in mono, so the sound you hear is the same regardless of where you are within the listening room.

### **T-D (Theater-Dimensional)**

With this mode you can enjoy a virtual surround sound even with only two or three speakers. This works by controlling how sounds reach the listener's left and right ears. Good results may not be possible if there's too much reverb, so we recommend that you use this mode in an environment with little or no natural reverb.

# Advanced Setup

## Common Procedures in Setup Menu

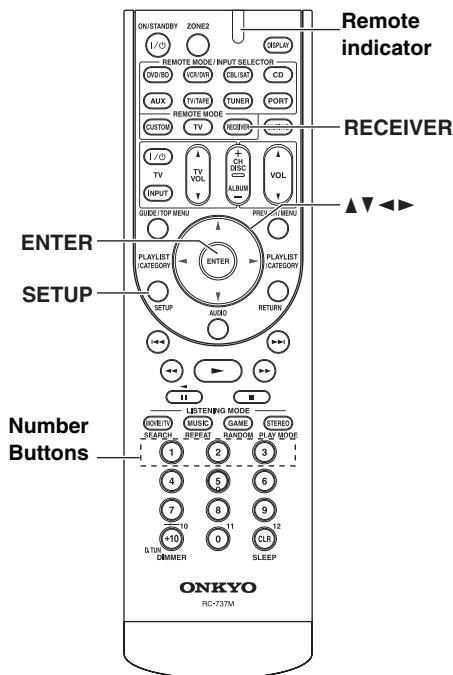

- 1** Press the [RECEIVER] button followed by the [SETUP] button.
- 2** Use the Up and Down [▲]/[▼] buttons to select main menu, and then press [ENTER].
- 3** Use the Up and Down [▲]/[▼] buttons to select the function, and then press the [ENTER] button.
- 4** Use the Up and Down [▲]/[▼] button to select item, and then use the Left and Right [◀]/[▶] buttons to set them.
- 5** When you've finished, press the [SETUP] button.  
Setup closes.

### Note:

This procedure can also be performed on the AV receiver by using its [SETUP] button, arrow buttons, and [ENTER] button.

## Speaker Setup

This section explains how to check the speaker settings and how to set them manually, which is useful if you change a speaker after performing the Audyssey 2EQ™ Room Correction and Speaker Setup.

Some of the speaker settings are set automatically by the Audyssey 2EQ Room Correction and Speaker Setup function (see page 46).

### 2-1. Sp Settings

See "Speaker Settings" on page 44.

### 2-2. Sp Config (Speaker Configuration)

With these settings, you can specify which speakers are connected and a crossover frequency for each speaker. Specify "FullBand" for speakers that can output low frequency bass sounds adequately, for example, speakers with a good sized woofer. For smaller speakers, specify a crossover frequency. Sounds below the crossover frequency will be output by the subwoofer instead of the speaker. Refer to your speaker's manuals to determine the optimum crossover frequencies.

<b>Subwoofer</b>	<b>Yes:</b> Select if a subwoofer is connected (default). <b>No:</b> Select if no subwoofer is connected.
<b>Front*<sup>1</sup></b>	<b>FullBand, 40 Hz to 100 Hz (default), 120 Hz, 150 Hz, 200 Hz</b>
<b>Center*<sup>2</sup></b>	<b>FullBand, 40 Hz to 100 Hz, 120 Hz, 150 Hz, 200 Hz</b>
<b>Surr*<sup>2</sup></b>	<b>None:</b> Select if no speaker is connected.
<b>FrontH*<sup>2</sup>*<sup>3</sup>*<sup>5</sup>*<sup>6</sup></b>	
<b>SurrBk*<sup>3</sup>*<sup>4</sup>*<sup>5</sup>*<sup>7</sup></b>	
<b>SurrBack ch*<sup>8</sup></b>	<b>1ch:</b> Select if only one surround back L speaker is connected. <b>2ch:</b> Select if two (left and right) surround back speakers are connected (default).

---

**LPFofLFE**                    **80 Hz, 90 Hz, 100 Hz (default), 120 Hz**

(Low-Pass Filter for the LFE Channel)

This setting is not set automatically by the Audyssey 2EQ™ Room Correction and Speaker Setup function (see page 46).

With this setting, you can specify the cutoff frequency of the LFE channel's low-pass filter (LPF), which can be used to filter out unwanted hum. The LPF only applies to sources that use the LFE channel.

---

**DoubleBass**<sup>\*9</sup>

This setting is not set automatically by the Audyssey 2EQ Room Correction and Speaker Setup function (see page 46).

With the Double Bass function, you can boost bass output by feeding bass sounds from the front left, right, and center to the subwoofer.

**On:** Double Bass function on (default).

**Off:** Double Bass function off.

---

**Notes:**

- \*1 If the "Subwoofer" setting is set to "No", the "Front" setting is fixed at "FullBand".
  - \*2 If the "Front" setting is set to anything other than "FullBand", "FullBand" cannot be selected here.
  - \*3 If the "Surr" setting is set to "None", this setting cannot be selected.
  - \*4 If the "Surr" setting is set to anything other than "FullBand", "FullBand" cannot be selected here.
  - \*5 If the "Sp Type" setting is set to "Bi-Amp" (page 44), or Powered Zone 2 is being used (page 81), this setting cannot be selected.
  - \*6 If the "SB/FH" setting is set to "SurrBack" (page 44), this setting cannot be selected.
  - \*7 If the "SB/FH" setting is set to "FrontHigh" (page 44), this setting cannot be selected.
  - \*8 If the "SurrBk" Setting is set to "None" (page 68), this setting cannot be selected.
  - \*9 This function can be set only if the "Subwoofer" setting is set to "Yes", and the "Front" setting is set to "FullBand".
- 

### 2-3. Sp Distance (Speaker Distance)

These settings are set automatically by the Audyssey 2EQ Room Correction and Speaker Setup function (see page 46).

With these settings, you can specify the distance from each speaker to the listening position.

Measure and make a note of the distance from each speaker to the listening position.

**Notes:**

- Speakers that you set to "No" or "None" in the "2-2. Sp Config (Speaker Configuration)" (page 68) cannot be selected.
  - The speaker distance setting cannot be changed while a pair of headphones is connected.
  - The Center, Subwoofer and Front High distances can be set up to 5 ft. (1.5 m) more or less than the Left distance. For example, if the Left distance is set to 20 ft. (6 m), the Center, Subwoofer, Front High Left and Front High Right distances can be set between 15 and 25 ft. (4.5 and 7.5 m).
  - The Surround and Surround Back distances can be set up to 5 ft. (1.5 m) more or 15 ft. (4.5 m) less than the Left distance. For example, if the Left distance is set to 20 ft. (6 m), the Surr Right, Surr Left, Surr Back R, and Surr Back L distances can be set between 5 and 25 ft. (1.5 and 7.5 m).
- 

**Unit**                    **feet:** Distances can be set in feet. Range: 1 to 30 feet in 1-foot steps.

**meters:** Distances can be set in meters. Range: 0.3 to 9 meters in 0.3-meter steps.

---

**Left, FrontH L, Center, FrontH R, Right, Surr R, SurrBk R,  
SurrBk L, Surr L, Subwfr**

Specify the distance from the each speaker to your listening position.

---

### 2-4. Level Cal (Speaker Levels Calibration)

These settings are set automatically by the Audyssey 2EQ™ Room Correction and Speaker Setup function (see page 46).

You can set the volume level of each speaker so that all speakers can be heard equally at the listening position. A pink noise test tone is output by the front left speaker.

**Notes:**

- Speakers that you set to “No” or “None” in the “2-2. Sp Config (Speaker Configuration)” (page 68) do not output the test tone.
- The speaker levels cannot be adjusted while a pair of headphones is connected or the AV receiver is muted.

**Left, FrontH L, Center, FrontH R, Right, Surr R, SurrBk R, SurrBk L, Surr L, Subwfr**

The levels can be adjusted from –12 to +12 dB in 1 dB steps (–15 to +12 dB for the subwoofer).

### 2-5. Equalizer (Equalizer Settings)

These settings are set automatically by the Audyssey 2EQ Room Correction and Speaker Setup function (see page 46). Here you can adjust the tone of individual speakers. To set the volume of individual speakers, see page 68.

**Notes:**

- You can select: “63Hz”, “250Hz”, “1000Hz”, “4000Hz”, or “16000Hz”. And for the subwoofer, “25Hz”, “40Hz”, “63Hz”, “100Hz”, or “160Hz”.
- While the Direct or Pure Audio listening mode is selected, the equalizer settings have no effect.
- The equalizer setting cannot be changed while a pair of headphones is connected.

**EQ**

**Manual:** You can adjust the equalizer for each speaker manually. If you select “Manual”, continue with this procedure.

**Select a frequency**

**1** Use the Down [▼] button to select “Ch”, and then use the Left and Right [◀]/[▶] buttons to select a speaker.

**2** Use the Up and Down [▲]/[▼] buttons to select a frequency. Use the Left and Right [◀]/[▶] buttons to adjust the level at that frequency.

A screenshot of the receiver's EQ menu. The display shows 'F' on the left, '250Hz' in the center, and '1+3dB' on the right, indicating the selected frequency and its level.

The volume at each frequency can be adjusted from –6 to +6 dB in 1 dB steps.

**Tip:**

Low frequencies (e.g., 63 Hz) affect bass sounds; high frequencies (e.g., 16000 Hz) affect treble sounds.

**3** Use the Up [▲] button to select “Ch”, and then use the Left and Right [◀]/[▶] buttons to select another speaker.

Repeat steps 1 and 2 for each speaker.

Speakers that you set to “No” or “None” in the “2-2. Sp Config (Speaker Configuration)” (page 68) cannot be selected.

**Audyssey:** The tone for each speaker is set automatically by the Audyssey 2EQ Room Correction and Speaker Setup function. Be sure to select this setting after having performed the Audyssey 2EQ Room Correction and Speaker Setup. “Dynamic EQ” and “Dyn Vol” become available (page 72).

**Off:** Tone off, response flat.

### Audio Adjust

With the Audio Adjust functions and settings, you can adjust the sound and listening modes as you like.

#### 3. Audio Adjust

##### 3-1. Mux/Mono (Multiplex/Mono)

**Input (Mux)**      **Main:** The main channel is output (default).  
                         **Sub:** The sub channel is output.  
                         **M/S:** Both the main and sub channels are output.

This setting determines which channel of a stereo multiplex source is output. Use it to select audio channels or languages with multiplex sources, multilingual TV broadcasts, and so on.

**Input (Mono)**      **L+R:** Both the left and right channels are output (default).  
                         **L:** Only the left channel is output.  
                         **R:** Only the right channel is output.

This setting determines which channel is output when the Mono listening mode is used with a stereo source.

##### 3-2. Dolby

These settings apply to only 2-channel stereo sources.

If you're not using any surround back speakers, these settings apply to Dolby Pro Logic II, not Dolby Pro Logic Ix.

**Panorama**            **On:** Panorama function on.  
                         **Off:** Panorama function off (default).

With this setting, you can broaden the width of the front stereo image when using the Dolby Pro Logic Ix Music listening mode.

**Dimension**            **-3 to +3 (default: 0)**

With this setting, you can move the sound field forward or backward when using the Dolby Pro Logic Ix Music listening mode. Higher settings move the sound field backward. Lower settings move it forward.

If the stereo image feels too wide, or there's too much surround sound, move the sound field forward to improve the balance. Conversely, if the stereo image feels like it's in mono, or there's not enough surround sound, move it backward.

**Center Width**        **0 to 7 (default: 3)**

With this setting, you can adjust the width of the sound from the center speaker when using the Dolby Pro Logic Ix Music listening mode. Normally, if you're using a center speaker, the center channel sound is output by only the center speaker. (If you're not using a center speaker, the center channel sound will be distributed to the front left and right speakers to create a phantom center.) This setting controls the front left, right, and center mix, allowing you to adjust the weight of the center channel sound.

##### Dolby EX

**Dolby EX**            **Auto:** If the source signal contains a Dolby EX flag, the Dolby EX listening mode is used.  
                         **Manual:** You can select any available listening mode (default).

This setting determines how Dolby EX encoded signals are handled. This setting is unavailable if no surround back speakers are connected. This setting is effective with Dolby Digital, Dolby Digital Plus and Dolby TrueHD only.

**Notes:**

- If the "SurrBack" Setting is set to "None", this setting cannot be selected (see page 68).
- If the "FrontH" setting is set to other than "None", this setting is fixed at "Manual" (see page 68).

### 3-3. DTS

#### Neo:6 Music

**Center Image**      **0 to 5 (default: 2)**

The DTS Neo:6 Music listening mode creates 6-channel surround sound from 2-channel stereo sources. With this setting, you can specify by how much the front left and right channel output is attenuated in order to create the center channel.

Setting a value [0] in the middle is set to hear a sound. Sound is spread in left and right (the outside) so that the set value is made big. Please adjust by liking.

### 3-4. Audyssey

When the room correction and speaker setup is complete, the “2-5. Equalizer (Equalizer Settings)” (page 70) will be set to “Audyssey” and the “Dynamic EQ” will be set to “On”.

**Dynamic EQ**      **Off:** Audyssey Dynamic EQ off (default).  
                         **On:** Audyssey Dynamic EQ on.

With Audyssey Dynamic EQ, you can enjoy great sound even when listening at low volume levels.

Audyssey Dynamic EQ solves the problem of deteriorating sound quality as volume is decreased by taking into account human perception and room acoustics. It does so by selecting the correct frequency response and surround volume levels moment-by-moment so that the content sounds the way it was created at any volume level--not just at reference level.

#### Dyn Vol (Dynamic Volume)

**Off:** Audyssey Dynamic Volume™ off.  
**Light:** Light Compression Mode becomes active (see page 46).  
**Medium:** Medium Compression Mode becomes active (see page 46).  
**Heavy:** Heavy Compression Mode becomes active. This setting affects volume the most, causing all sounds to be of equal loudness.

#### Note:

After the automatic speaker setting is completed, even if Equalizer Setting is set besides “Audyssey”, when Dynamic EQ is set to “On”, Equalizer Settings is set to “Audyssey”.

When Dynamic Volume is set to effective, Equalizer Setting is set to “Audyssey” and Dynamic EQ is set to “On”. When Dynamic EQ is set to “Off”, Dynamic Volume becomes “Off” automatically.

### 3-5. T-D (Theater-Dimensional)

#### LstnAngl (Listening Angle)

**Wide:** Select if the listening angle is 40 degrees (default).  
**Narrow:** Select if the listening angle is 20 degrees.

With this setting, you can optimize the Theater- Dimensional listening mode by specifying the angle of the front left and right speakers relative to the listening position. Ideally, the front left and right speakers should be equidistant from the listening position and at an angle close to one of the two available settings.

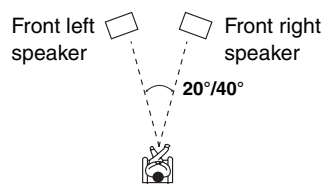



## Using the Audio Settings

You can change various audio settings by pressing the [AUDIO] button.

**Note:**

When the “AudioTVOut” setting is set to “On” (page 78), the [AUDIO] button is disabled.

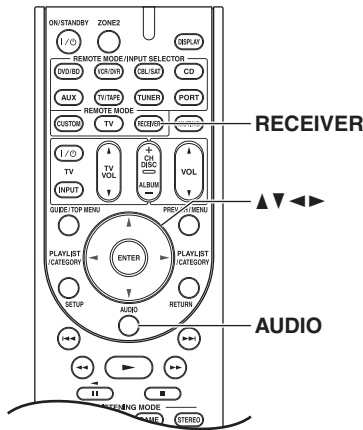

- 1** Press the [RECEPTOR] button followed by the [AUDIO] button.
- 2** Use the Up and Down [▲]/[▼] buttons to select an item.
- 3** Use the Left and Right [◀]/[▶] buttons to change the setting.  
Repeat this step for the other settings.

### Tone Control Settings

You can adjust the bass and treble for the front speakers, except when the Direct or Pure Audio listening mode is selected.

**Notes:**

- To bypass the bass and treble tone circuits, select the Direct or Pure Audio listening mode.
- This procedure can also be performed on the AV receiver by using its [TONE], [-], and [+] buttons.

<b>Bass</b>	<b>-10 dB to +10 dB in 2 dB steps (default: 0 dB)</b>
<b>Treble</b>	<b>-10 dB to +10 dB in 2 dB steps (default: 0 dB)</b>

### Late Night Function

With the Late Night function, you can reduce the dynamic range of Dolby Digital material so that you can still hear quiet parts even when listening at low volume levels—ideal for watching movies late at night when you don’t want to disturb anyone.

- Late Night** For **Dolby Digital and Dolby Digital Plus** sources, the options are:
- Off:** Late Night function off (default).
  - Low:** Small reduction in dynamic range.
  - High:** Large reduction in dynamic range.
- For **Dolby TrueHD** sources, the options are:
- Auto:** The Late Night function is set to “On” or “Off” automatically (default).
  - Off:** Late Night function off.
  - On:** Late Night function on.

**Notes:**

- The effect of the Late Night function depends on the material that you are playing and the intention of the original sound designer, and with some material there will be little or no effect when you select the different options.
- The Late Night function can be used only when the input source is Dolby Digital, Dolby Digital Plus, or Dolby TrueHD.
- The Late Night function is set to Off when the AV receiver is set to Standby. For Dolby TrueHD sources, it will be set to Auto.

### CinemaFILTER

With the CinemaFILTER, you can soften overly bright movie soundtracks, which are typically mixed for reproduction in a movie theater.

CinemaFILTER can be used with the following listening modes: Dolby Digital, Dolby Digital EX, Dolby Digital Plus, TrueHD, Dolby Pro Logic IIX Movie, Dolby Pro Logic II Movie, Multichannel, DTS, DTS-ES, DTS Neo:6 Cinema, DTS 96/24, Neo:6, DTS-HD High Resolution, DTS-HD Master and DTS Express.

---

<b>Cinema Fltr</b>	<b>Off:</b> CinemaFILTER off (default).
	<b>On:</b> CinemaFILTER on.

---

**Note:**

The CinemaFILTER may not work when used with certain input sources.

---

### Audyssey Dynamic Volume™

---

<b>Dyn Vol</b>	See “Dyn Vol” of “Audio Adjust” on page 72.
----------------	---

---

### Music Optimizer

The Music Optimizer function enhances the sound quality of compressed music files. Use it with music files that use “lossy” compression, such as MP3.

---

<b>M.Optimizer</b>	<b>Off:</b> Music Optimizer off (default).
	<b>On:</b> Music Optimizer on.

---

**Note:**

The Music Optimizer function only works with PCM digital audio input signals with a sampling rate below 48 kHz and analog audio input signals. The Music Optimizer is disabled when the Direct or Pure Audio listening mode is selected.

---

### Speaker Layout

You can select the priority of the use of SurrBack speakers or FrontHigh speakers.

---

**SpLayout**

**SurrBk:** The sound from surround back speakers is output by priority.

**FrontH:** The sound from front high speakers is output by priority.

---

**Notes:**

- If the “Sp Type” setting is set to “Bi-Amp” (page 44) or Powered Zone 2 is being used, this setting cannot be selected.
  - When the listening mode that doesn’t correspond to the switch of the speakers is used, the setting cannot be selected.
  - This setting can also be selected on the remote controller by using [GUIDE/TOP MENU] button.
- 

### Speaker Levels

You can adjust the volume of each speaker while listening to an input source.

These temporary adjustments are cancelled when the AV receiver is set to Standby.

---

**Subwfr (Subwoofer)**

–15 dB to +12 dB (default: 0 dB)

---

**Center** –12 dB to +12 dB (default: 0 dB)

---

**Notes:**

- You cannot use this function while the AV receiver is muted.
  - Speakers that are set to “No” or “None” in the “2-2. Sp Config (Speaker Configuration)” cannot be adjusted (see page 68).
- 

### A/V Sync

When using progressive scanning on your DVD player, you may find that the picture and sound are out of sync. With this setting, you can correct this by delaying the audio signals.

---

<b>A/V Sync</b>	<b>0 ms to 100 ms in 10 ms steps</b>
-----------------	--------------------------------------

---

**Notes:**

- A/V Sync is disabled when the Pure Audio listening mode is selected, or when the Direct listening mode is used with an analog input source.
  - The setting is stored individually for each input selector.
-

### Assigning Listening Modes to Input Sources

You can assign a default listening mode to each input source that will be selected automatically when you select each input source. For example, you can set the default listening mode to be used with Dolby Digital input signals. You can select other listening modes during playback, but the mode specified here will be resumed once the AV receiver has been set to Standby.

**1** Press the [RECEIVER] button followed by the [SETUP] button.

**2** Use the Up and Down [▲]/[▼] buttons to select “5. ListeningMode”, and then press [ENTER].

**3** Use the Up and Down [▲]/[▼] buttons to select the input source that you want to set, and then press [ENTER].  
For TUNER input selector only “Anlg (Analog)” will be available.

**4** Use the Up and Down [▲]/[▼] buttons to select the signal format that you want to set, and then use the Left and Right [◀]/[▶] buttons to select a listening mode.

Only listening modes that can be used with each input signal format can be selected (see pages 62-65).

The Last Valid option means that the listening mode selected last will be used.

**A/PCM:** With this setting, you can specify the listening mode to be used when an analog (CD, TV, LD, VHS, MD, turntable, radio, cassette, cable, satellite, etc.) or PCM digital (CD, DVD, etc.) audio signal is played.

**Dolby:** With this setting, you can specify the listening mode to be used when a Dolby Digital or Dolby Digital Plus format digital audio signal is played (DVD, etc.).

**DTS:** With this setting, you can specify the listening mode to be used when a DTS or DTS-HD High Resolution format digital audio signal is played (DVD, LD, CD, etc.).

**DF2ch:** Specifies the default listening mode for 2-channel (2/0) stereo sources in a digital format, such as Dolby Digital or DTS.

**Mono:** With this setting, you can specify the listening mode to be used when a mono digital audio signal is played (DVD, etc.).

**MCH P:** Specifies the default listening mode for multichannel PCM sources input via a HDMI IN, such as DVD-Audio.

**True:** Specifies the default listening mode for Dolby TrueHD sources, such as Blu-ray or HD DVD (input via HDMI).

**MSTR:** Specifies the default listening mode for DTS-HD Master Audio sources, such as Blu-ray or HD DVD (input via HDMI).

**DSD:** Specifies the default listening mode for DSD multichannel sources, such as SACD.

**5** When you've finished, press the [SETUP] button.  
Setup closes.

#### Notes:

- If you connect an input component (such as UP-A1 series Dock that seated iPod or iPhone) to the UNIVERSAL PORT jack, you can assign only “Anlg (Analog)” listening mode to PORT input selector.
- This procedure can also be performed on the AV receiver by using its [SETUP] button, arrow buttons, and [ENTER] button.

### Source Setup

This section explains items on the “Source Setup” menu. Items can be set individually for each input selector.

- 1** Press the input selector buttons to select an input source, and then press the [RECEIVER] button.
- 2** Press the [SETUP] button.
- 3** Use the Up and Down [▲]/[▼] buttons to select “4. Source Setup”, and then press [ENTER].
- 4** Use the Up and Down [▲]/[▼] buttons to select an item, and then press [ENTER].
- 5** Use the Left and Right [◀]/[▶] buttons to change it.  
The “Source Setup” menu items are explained below.
- 6** When you’ve finished, press the [SETUP] button.  
Setup closes.

### IntelliVolume

With IntelliVolume, you can set the input level for each input selector individually. This is useful if one of your source components is louder or quieter than the others.

Use the Left and Right [◀]/[▶] buttons to set the level.

If a component is noticeably louder than the others, use the Left [◀] button to reduce its input level. If it’s noticeably quieter, use the Right [▶] button to increase its input level. The input level can be adjusted from –12 dB to +12 dB in 1 dB steps.

**Note:**

IntelliVolume does not apply for Zone 2.

### A/V Sync

When using your DVD player’s progressive scanning function, you may find that the picture and sound are out of sync. With the A/V Sync setting, you can correct this by applying a delay to the audio signal.

The delay can be set from 0 to 100 milliseconds (msec) in 10 millisecond steps.

Use the Left and Right [◀]/[▶] buttons to set the delay. To view the TV picture while setting the delay.

If HDMI Lip Sync is “enabled” (see page 79), and your TV or display supports HDMI Lip Sync, the displayed delay time will be the A/V Sync delay time. The HDMI Lip Sync delay time is displayed underneath in parentheses.

**Note:**

A/V Sync is disabled when the Pure Audio listening mode is selected, or when the Direct listening mode is used with an analog input source.

### Miscellaneous (Volume) Setup

This section explains the items on the “Miscellaneous” menu.

- 1** Press the [RECEIVER] button followed by the [SETUP] button.
- 2** Use the Up and Down [▲]/[▼] buttons to select “6. Miscellaneous”, and then press [ENTER].
- 3** Press the [ENTER] button.
- 4** Use the Up and Down [▲]/[▼] buttons to select an item, and use the Left and Right [◀]/[▶] buttons to change it.  
The items are explained below.
- 5** When you’ve finished, press the [SETUP] button.  
Setup closes.

**Note:**

This procedure can also be performed on the AV receiver by using its [SETUP] button, arrow buttons, and [ENTER] button.

### Volume Setup

---

■ **MaxVolume**

With this setting, you can limit the maximum volume. The Maximum Volume range is “Off”, 79 to 30.

■ **POnVol**

With this preference, you can specify the volume setting to be used each time the AV receiver is turned on. The range is “Last”, “Min”, 1 to 79 or “Max”. To use the same volume level that was used when the AV receiver was turned off, select “Last”. The “POnVol” cannot be set higher than the “Max Volume” setting.

■ **HP Level**

With this preference, you can specify the headphone volume relative to the main volume. This is useful if there’s a volume difference between your speakers and your headphones. The headphones level can be set from -12 dB to +12 dB.

### Hardware Setup

This section explains items on the “Hardware Setup” menu.

- 1** Press the [RECEIVER] button followed by the [SETUP] button.
- 2** Use the Up and Down [▲]/[▼] buttons to select “7. HardwareSetup”, and then press [ENTER].
- 3** Use the Up and Down [▲]/[▼] buttons to select an item, and then press [ENTER].
- 4** Use the Up and Down [▲]/[▼] buttons to select an item, and use the Left and Right [◀]/[▶] buttons to change it.  
The items are explained below.
- 5** When you’ve finished, press the [SETUP] button.  
Setup closes.

#### Note:

This procedure can also be performed on the AV receiver by using its [SETUP] button, arrow buttons, and [ENTER] button.

### Remote ID

#### ■ Remote ID

When several Onkyo components are used in the same room, their remote ID codes may overlap. To differentiate the AV receiver from the other components, you can change its remote ID from 1, the default, to 2 or 3.

#### Note:

If you do change the AV receiver’s remote ID, be sure to change the remote controller to the same ID (see below), otherwise, you won’t be able to control it with the remote controller.

#### Changing the Remote Controller’s ID

- 1** While holding down the [RECEIVER] button, press and hold down the [SETUP] button until the Remote Indicator lights up (about 3 seconds).
- 2** Use the number buttons to enter ID 1, 2, or 3.  
The Remote Indicator flashes twice.

### Tuner

#### ■ FM/AM (North American models)

See “AM/FM Frequency Step Setup” on page 53.

#### ■ AM Freq (Asian models)

See “AM/FM Frequency Step Setup” on page 53.

### HDMI

#### ■ AudioTVOut

This preference determines whether audio received at the HDMI IN is output by the HDMI OUT. You may want to turn this preference on if your TV is connected to the HDMI OUT and you want to listen to the audio from a component that’s connected to an HDMI IN, through your TV’s speakers. Normally, this should be set to “Off”.

**Off:** HDMI audio is not output (default).

**On:** HDMI audio is output.

#### Notes:

- If “On” is selected and the signal can be output by the TV, the AV receiver will output no sound through its speakers.
- If “On” is selected, “TV Sp On” appears on the Display by pressing the [DISPLAY] button.
- When “TV Ctrl” is set to “On”, this setting is fixed to “Auto”.
- With some TVs and input signals, no sound may be output even when this setting is set to “On”.
- When the “AudioTVOut” setting is set to “On”, or “TV Ctrl” is set to “On” and you’re listening through your TV’s speakers (see page 28), if you turn up the AV receiver’s volume control, the sound will be output by the AV receiver’s front left and right speakers. To stop the AV receiver’s speakers producing sound, change the settings, change your TV’s settings, or turn down the AV receiver’s volume.

### ■ LipSync

The AV receiver can be set to automatically correct any delay between the video and the audio, based on the data from the connected monitor.

**Disable:** HDMI lip sync disabled (default).

**Enable:** HDMI lip sync enabled.

#### Notes:

- This function works only if your HDMI-compatible TV supports HDMI Lip Sync.
- You can check the amount of delay being applied by the HDMI Lip Sync function on the A/V Sync screen (see page 76).

### ■ xvColor

If your HDMI source and HDMI-compatible TV both support the “x.v.Color,” you can enable “xvColor” on the AV receiver with this setting.

**Disable:** “x.v.Color” disabled (default).

**Enable:** “x.v.Color” enabled.

#### Notes:

- If the color is unnatural when “xvColor” is set to “Enable”, change the setting to “Disable”.
- Refer to the connected component’s instruction manual for details.

### ■ HDMI Ctrl

This function allows **RIHD**-compatible components connected via HDMI to be controlled with the AV receiver.

**Off:** **RIHD** disabled (default).

**On:** **RIHD** enabled.

#### Notes:

- **RIHD**, which stands for Remote Interactive over HDMI, is the name of the system control function found on Onkyo components. The AV receiver can be used with CEC (Consumer Electronics Control), which allows system control over HDMI and is part of the HDMI standard. CEC provides interoperability between various components, however, operation with components other than **RIHD**-compatible components cannot be guaranteed.

When set to “On” and close the menu, the name of connected **RIHD**-compatible components and “RIHD On” are displayed on the AV receiver.

“Search...” → “(name)” → “RIHD On”

When the AV receiver cannot receive the name of the component, it is displayed as “Player\*\*\*” or “Recorder\*\*\*”, etc (“\*\*\*” means the number of two or more component).

When set to “Off” and close the menu, “RIHD Off” are displayed on the AV receiver.

“Disconnect” → “RIHD Off”

- When an **RIHD**-compatible component is connected to the AV receiver via the HDMI cable, the name of the connected component is displayed on the AV receiver display. For example, while you are watching TV broadcasting, if you operate a DVD player (being powered on) by the remote control of the

AV receiver, the name of the DVD player is displayed on the AV receiver.

- Set to “Off” when a connected piece of equipment is not compatible or it is unclear whether the equipment is compatible or not.
- If movement is unnatural when set to “On”, change the setting to “Off”.
- Refer to the connected component’s instruction manual for details.

### Power Ctrl

To link the power functions of **RIHD**-compatible components connected via HDMI, select “On”.

This setting is set to “On” automatically when the above “HDMI Ctrl” is set to “On” first time.

**Off:** Power Control disabled.

**On:** Power Control enabled.

#### Notes:

- The “Power Ctrl” setting can be set only when the above “HDMI Ctrl” setting is set to “On”.
- HDMI power control only works with **RIHD**-compatible components that support it and may not work properly with some components due to their settings or compatibility.
- When set to “On”, power consumption will increase.
- When set to “On”, regardless of whether the AV receiver is On or on Standby, both audio and video received by an HDMI input will be output by the HDMI OUT for playback on the TV or other component that’s connected to the HDMI OUT.
- Refer to the connected component’s instruction manual for details.

### TV Ctrl

Set to “On” when you want to control the AV receiver from an **RIHD**-compatible TV that is connected to HDMI.

**Off:** TV Control disabled.

**On:** TV Control enabled.

#### Notes:

- Do not assign the component connected with the HDMI input to the TV/TAPE selector when you set “TV Control” setting to “On”. Otherwise, appropriate CEC (Consumer Electronics Control) operation is not guaranteed.
- Set to “Off” when the TV is not compatible or when it is unclear whether the TV is compatible or not.
- The “TV Ctrl” setting can be set only when the above “HDMI Ctrl” and “Power Ctrl” settings are both set to “On”.
- Refer to the connected component’s instruction manual for details.

#### Note:

After changing the settings of the “HDMI Ctrl”, “Power Ctrl”, or “TV Ctrl”, turn off the power to all connected pieces of equipment and then turn them on again. Refer to the User’s Manuals for all connected pieces of equipment.

# Zone 2

In addition to your main listening room, you can also enjoy playback in the other room, or as we call Zone 2. And, you can select a different source for each room.

## Connecting Zone 2

### Connecting Your Zone 2 Speakers Directly to the AV receiver

This setup allows 5.1-channel playback in your main room and 2-channel stereo playback in Zone 2, with a different source in each room. This is called Powered Zone 2, as the Zone 2 speakers are powered by the AV receiver. Note that when Powered Zone 2 is turned off, you can enjoy 7.1-channel playback in your main room.

To use this setup, you must set the “Powered Zone 2” setting to “Act” (see page 81).

#### Hookup

Connect your Zone 2 speakers to the AV receiver’s ZONE 2 SPEAKERS L/R speaker terminals.

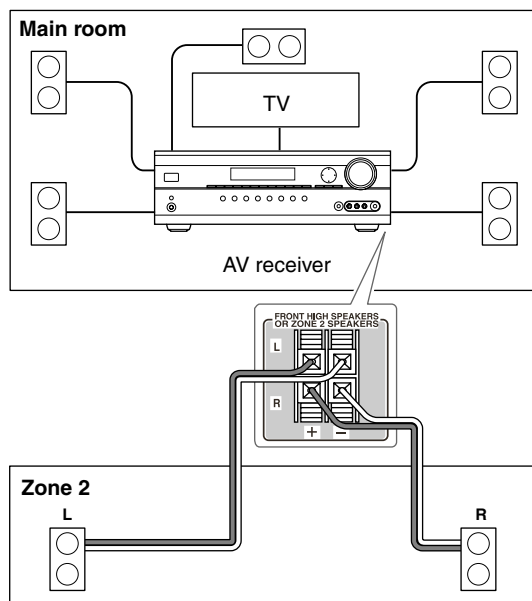

#### Notes:

- With this setup, the Zone 2 volume is controlled by the AV receiver.
- “Powered Zone 2” cannot be used if “Sp Type” is set to “Bi-Amp” (page 44).

### Connecting Your Zone 2 Speakers to an Amp in Zone 2

This setup allows 7.1-channel playback in your main listening room and 2-channel stereo playback in Zone 2, with a different source in each room.

#### Hookup

- Use an RCA audio cable to connect the AV receiver’s ZONE 2 LINE OUT L/R jacks to an analog audio input on your Zone 2 amp.
- Connect your Zone 2 speakers to the speaker terminals on your Zone 2 amp.

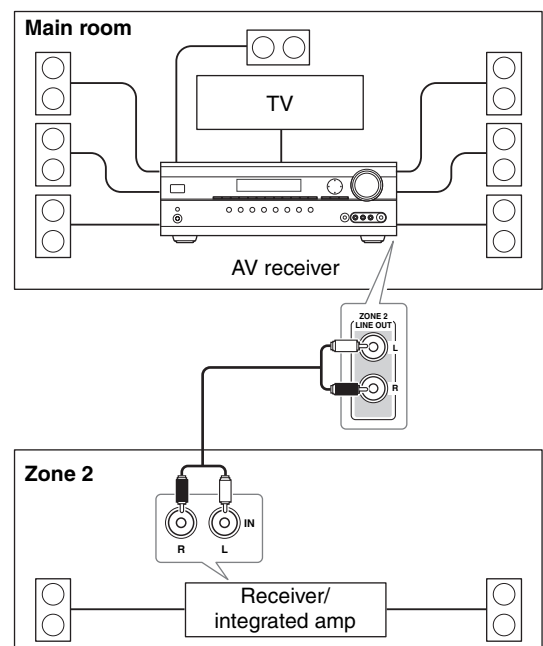

#### Note:

The Zone 2 volume must be set on the Zone 2 amp.



**Setting the Powered Zone 2**

If you've connected your Zone 2 speakers to the AV receiver, as explained in "Connecting Your Zone 2 Speakers Directly to the AV receiver" on page 80, you must set the "PwrZ2" (Powered Zone 2) setting to "Act" (Activated).

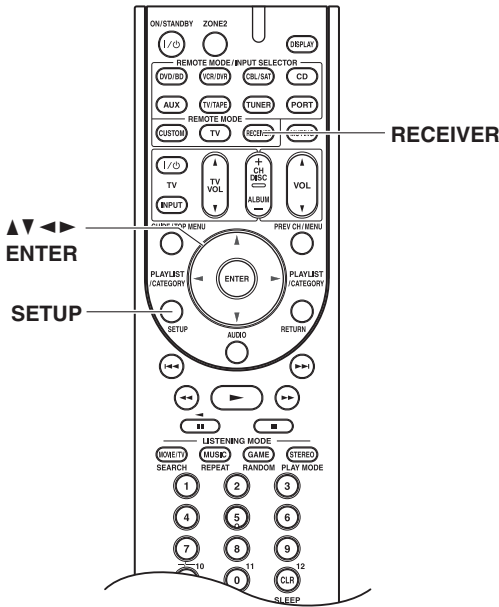

**1** Press the [RECEIVER] button, followed by the [SETUP] button.

**2** Use the Up and Down [▲]/[▼] buttons to select "2. Speaker Setup", and then press [ENTER].

**3** Use the Up and Down [▲]/[▼] buttons to select "2-1. Sp Settings", and then press [ENTER].

**4** Use the Up and Down [▲]/[▼] buttons to select "PwrZ2".

**5** Use the Left and Right [◀]/[▶] buttons to select:

**Not Act:** ZONE 2 SPEAKERS L/R speaker terminals not activated (Powered Zone 2 disabled).

**Act:** ZONE 2 SPEAKERS L/R speaker terminals activated (Powered Zone 2 enabled).

**6** Press the [SETUP] button. Setup closes.

**Notes:**

- When "Act" is selected and Zone 2 turned on, the Zone 2 speakers connected to the ZONE 2 SPEAKERS L/R speaker terminals output sound, but the surround back speakers connected to the SURR BACK L/R speaker terminals do not. When "Act" is selected and Zone 2 turned off, the surround back speakers output sound as normal.
- When the "Powered Zone 2" setting is set to "Act" and the input selector of Zone 2 is selected, power consumption on standby mode slightly increases.
- "Powered Zone 2" cannot be used if "Sp Type" is set to "Bi-Amp" (page 44).
- This procedure can also be performed on the AV receiver by using its [SETUP] button, arrow buttons, and [ENTER] button.

### Using Zone 2

This section explains how to turn Zone 2 on and off, how to select an input source for Zone 2, and how to adjust the volume for Zone 2.

### Controlling Zone 2 from the AV receiver

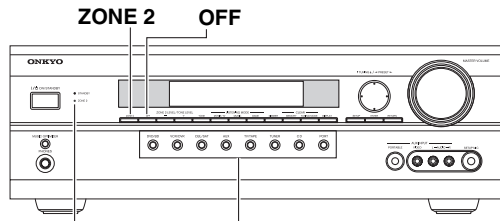

**ZONE 2 indicator**    **Input selector**

### Controlling Zone 2 with the Remote Controller

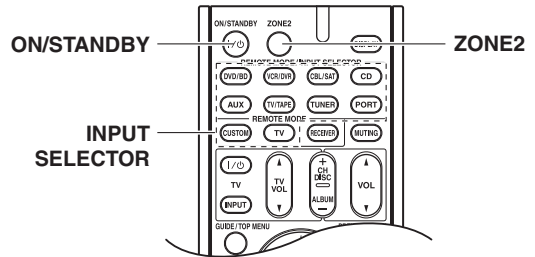

**Note:**

To control Zone 2, you must press the remote controller's [ZONE 2] button first.

<p><b>1</b></p>	<p><b>To turn on Zone 2 and select an input source, press the [ZONE 2] button followed by an input selector button within 8 seconds.</b></p> <p>Zone 2 turns on and ZONE 2 indicator lights up.</p> <p>To select the same source as that of the main room, press the [ZONE 2] button repeatedly until “Z2 Sel: Source” appears.</p> <p>To select AM or FM press the [TUNER] input selector button repeatedly.</p> <p><b>Note:</b> You cannot select different AM or FM radio stations for your main room, Zone 2. The same AM/FM radio station will be heard in each room.</p>
<p><b>2</b></p>	<p><b>To turn off Zone 2, press the ZONE 2 [OFF] button.</b></p>



**Notes:**

- Only analog input sources are output by Zone 2. Digital input sources are not output. If no sound is heard when an input source is selected, check to make sure it's connected to an analog input.
- While Zone 2 is on, the Auto Power On/Standby and Direct Change **RI** functions do not work.
- While Powered Zone 2 is being used, listening modes that require surround back or front high speakers (6.1/7.1), such as Dolby Digital EX, DTS-ES and Dolby Pro Logic IIz Height are unavailable.
- When the “Powered Zone 2” setting is set to “Act” and the input selector of Zone 2 is selected, power consumption on standby mode slightly increases.

<p><b>1</b></p>	<p><b>Press the [ZONE 2] button, then point the remote controller at the AV receiver and press the [ON/STANDBY] button.</b></p> <p>Zone 2 turns on and ZONE 2 indicator lights up.</p>
<p><b>2</b></p>	<p><b>To select an input source for Zone 2, press the [ZONE 2] button, followed by an INPUT SELECTOR button.</b></p> <p>To select AM or FM press the [TUNER] INPUT SELECTOR button repeatedly.</p> <p><b>Note:</b> You cannot select different AM or FM radio stations for your main room, Zone 2. The same AM/FM radio station will be heard in each room.</p>
<p><b>3</b></p>	<p><b>To turn off Zone 2, press the [ZONE 2] button, followed by the [ON/STANDBY] button.</b></p>

### Adjusting the Volume of Zones

---

<p>Remote controller</p>  <p>ZONE2</p>	<p>On the remote controller, press the [ZONE 2] button, and then use the VOL [▲]/[▼] button.</p>
<p>AV receiver</p>  <p>ZONE 2</p>	<p>On the AV receiver, press the [ZONE 2] button (the ZONE 2 indicator and Zone 2 selector on the display flashes) and then use the [-]/[+] buttons within 8 seconds.</p>

### Muting Zones

---

<p>Remote controller</p>  <p>ZONE2</p>	<p>On the remote controller, press the [ZONE 2] button, and then press the [MUTING] button.</p> <p>To unmute a zone, on the remote controller, press the [ZONE 2] button, and then press the [MUTING] button again.</p>
---	---

**Note:**

Zones can also be unmuted by adjusting the volume.





# Controlling Other Components

You can control your DVD player, CD player, and other components with the AV receiver's remote controller. To control another component, you must first enter that component's remote control code to a REMOTE MODE button.

This section explains how to enter remote control codes and how to control your other components.

## Preprogrammed Remote Control Codes

The following REMOTE MODE buttons are preprogrammed with remote control codes for controlling the components listed. You do not need to enter a remote control code to control these components. For details on controlling these components, see the pages indicated.

-  Onkyo DVD/BD player (page 87)
-  Onkyo CD player (page 90)
-  Onkyo cassette recorder with **RI** (page 92)
-  Onkyo Dock (pages 58, 91)

## Entering Remote Control Codes

You'll need to enter a code for each component that you want to control.

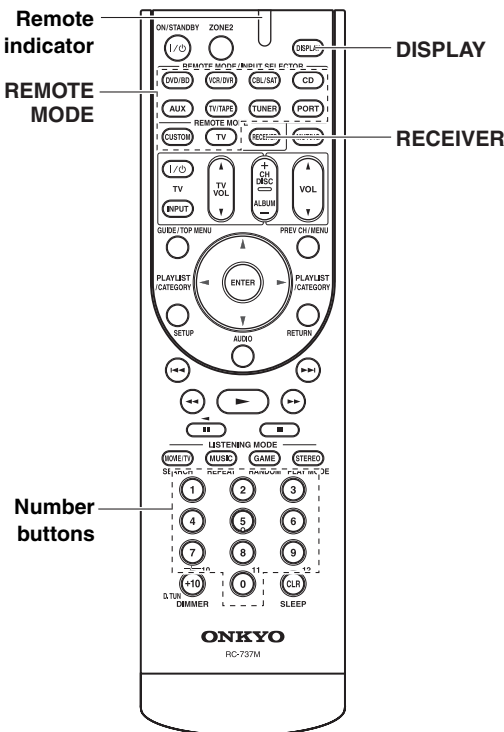

**1**

**Look up the component's remote control code in the separate Remote Control Codes list.**

The codes are organized by category.

**2**



(3 seconds)

**While holding down the REMOTE MODE button to which you want to enter a code, press and hold down the [DISPLAY] button until the Remote indicator lights up (about 3 seconds).**

**Notes:**

- Remote control codes cannot be entered for the [RECEIVER] and [ZONE 2] buttons.
- Only TV remote control codes can be entered for the [TV] button.
- Apart from the [RECEIVER], [TV], and [ZONE 2] buttons, remote control codes from any category can be entered for the REMOTE MODE buttons. However, these buttons also work as input selector buttons (page 49), so choose a REMOTE MODE button that corresponds with the input to which you connect your component. For example, if you connect your CD player to the CD input, choose the [CD] button when entering its remote control code.

**3**



**Within 30 seconds, use the number buttons to enter the 5-digit remote control code.**

The Remote indicator flashes twice.

If the remote control code is not entered successfully, the Remote indicator will flash once slowly.

**Note:**

The remote control codes provided are correct at the time of printing but subject to change.

## Remote Control Codes for Onkyo Components Connected via RI

Onkyo components that are connected via **RI** are controlled by pointing the remote controller at the AV receiver, not the component. This allows you to control components that are out of view, in a rack, for example.

- 1** Make sure the Onkyo component is connected with an **RI** cable and an analog audio cable (RCA).  
See page 39 for details.
- 2** Enter the appropriate remote control code to the **REMOTE MODE** button.
  - [DVD/BD] button  
**31612**: Onkyo DVD player with **RI**
  - [CD] button  
**71327**: Onkyo CD player with **RI**
  - [TV/TAPE] button  
**42157**: Onkyo cassette recorder with **RI** (default)
  - [PORT] button  
**82351**: Onkyo Dock
  - [TUNER] button  
**51805**: To control the AV receiver's tuner (default)

See the previous page for how to enter remote control codes.
- 3** Press the **REMOTE MODE** button, point the remote controller at the AV receiver, and operate the component.

If you want to control an Onkyo component by pointing the remote controller directly at it, or you want to control an Onkyo component that's not connected via **RI**, use the following remote control codes:

- [DVD/BD] button  
**30627**: Onkyo DVD player without **RI** (default)
- [CD] button  
**71817**: Onkyo CD player without **RI** (default)
- [TV] button  
**11807**: Onkyo TV (default)

If you want to control an Onkyo component by pointing the remote controller directly at it, use the following remote control codes:



- 32900**: Onkyo BD player
- 32901**: Onkyo HD-DVD player
- 70868**: Onkyo MD player
- 71323**: Onkyo CD recorder
- 82990**: Onkyo RI Dock

### Note:

If you connect an **RI**-capable Onkyo RI Dock to the TV/TAPE IN, CBL/SAT IN or VCR/DVR IN jacks, for **RI** to work properly, you must set the Input Display accordingly (see page 45).



## Resetting REMOTE MODE Buttons

You can reset a REMOTE MODE button to its default remote control code.

- 1** While holding down the **REMOTE MODE** button that you want to reset, press and hold down the [AUDIO] button until the Remote indicator lights up (about 3 seconds).  
  
 (3 seconds)
- 2** Within 30 seconds, press the **REMOTE MODE** button again.  
 The Remote indicator flashes twice, indicating that the button has been reset.  
 Each of the REMOTE MODE buttons is preprogrammed with a remote control code. When a button is reset, its preprogrammed code is restored.  

## Resetting the Remote Controller

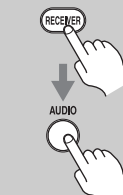
You can reset the remote controller to its default settings.

- 1** While holding down the [RECEIVER] button, press and hold down the [AUDIO] button until the Remote indicator lights up (about 3 seconds).  
  
 (3 seconds)
- 2** Within 30 seconds, press the [RECEIVER] button again.  
 The Remote indicator flashes twice, indicating that the remote controller has been reset.  

## Controlling a TV

By pressing the [TV] button that's been programmed with the remote control code for your TV (TV/DVD combination or TV/VCR combination), you can control your TV with the following buttons.

For details on entering a remote control code for a different component, see page 84.

The [TV] button is preprogrammed with the remote control code for controlling a TV that supports the **RIHD**\*1. The TV must be able to receive remote control commands via **RIHD** and be connected to the AV receiver via HDMI. If controlling your TV via **RIHD** doesn't work very well, program your TV's remote control code into the [TV] button and use the TV remote mode to control your TV.

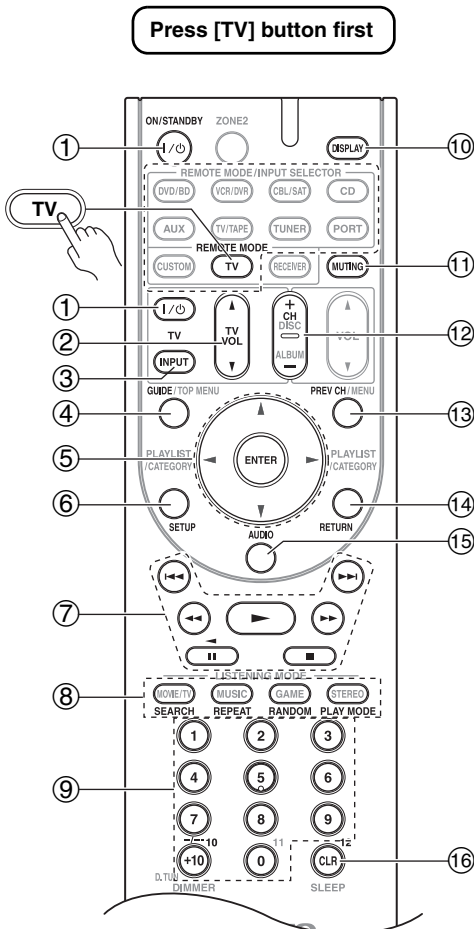

- ① **ON/STANDBY, TV [I/⏻] buttons**  
Set the TV to On or Standby.
- ② **TV VOL [▲]/[▼] button**  
Adjust the TV's volume.
- ③ **TV [INPUT] button**  
Selects the TV's external inputs.
- ④ **GUIDE button**  
Displays the program guide.
- ⑤ **Arrow [▲]/[▼]/[◀]/[▶] and ENTER buttons**  
Used to navigate menus and select items.
- ⑥ **SETUP button**  
Displays a menu.
- ⑦ **Playback buttons\***  
Play [▶], Pause [⏸], Stop [■], Fast Reverse [◀◀], Fast forward [▶▶], Previous [◀◀], and Next [▶▶].  
These buttons works for combination devices.
- ⑧ **SEARCH, REPEAT, RANDOM, and PLAY MODE buttons\***  
Function as colored buttons.
- ⑨ **Number buttons**  
Enter numbers. 0 button enters 11 on some components. +10 button\* works as "--/---" button or +10.
- ⑩ **DISPLAY button**  
Displays information.
- ⑪ **MUTING button**  
Mutes the TV.
- ⑫ **CH +/- button**  
Select channels on the TV.
- ⑬ **PREV CH button**  
Selects the previous or last channel.
- ⑭ **RETURN button**  
Exits the TV's setup menu.
- ⑮ **AUDIO button\***  
Selects foreign language soundtracks and audio formats (e.g., Dolby Digital or DTS).
- ⑯ **CLR button**  
Cancels functions and clears entered numbers, or enters 12.

### Notes:

- With some components, certain buttons may not work as expected, and some may not work at all.
- Buttons marked with an asterisk (\*) are not supported by the **RIHD** function.

\*1 The **RIHD** supported by the AV receiver is the CEC system control function of the HDMI standard.

## Controlling a DVD Player, or DVD Recorder

By pressing the REMOTE MODE button that's been programmed with the remote control code for your DVD player (Blu-ray, HD DVD, or TV/DVD combination), you can control your player with the following buttons.

The [DVD/BD] button is preprogrammed with the remote control code for controlling an Onkyo DVD player.

For details on entering a remote control code for a different component, see page 84.

The [DVD/BD] buttons are preprogrammed with the remote control code for controlling a component that supports the **RIHD**\*1. The component must be able to receive remote control commands via **RIHD** and be connected to the AV receiver via HDMI. If controlling your component via **RIHD** doesn't work very well, program your component's remote control code into the [DVD/BD] button and use the TV remote mode to control your component.

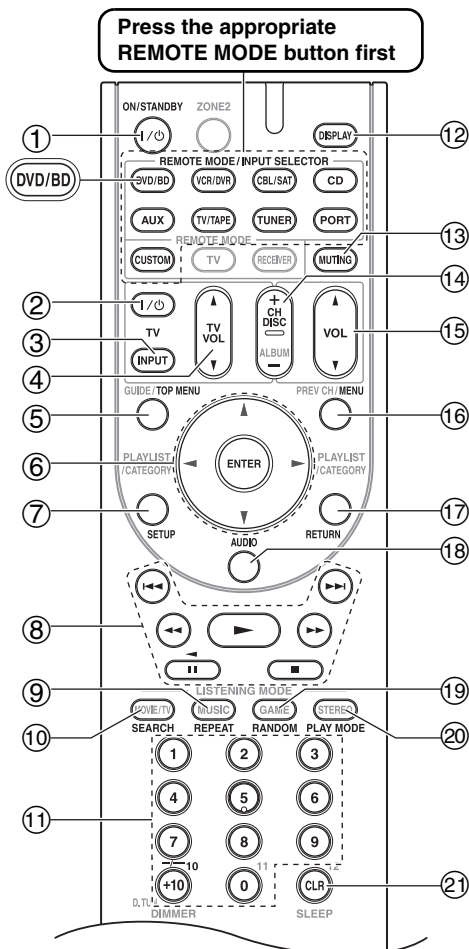

\*1 The **RIHD** supported by the AV receiver is the CEC system control function of the HDMI standard.

- ① **ON/STANDBY button**  
Sets the DVD player to On or Standby.
- ② **TV [I/O] button**  
Set the TV to On or Standby.
- ③ **TV [INPUT] button**  
Selects the TV's external inputs.
- ④ **TV VOL [▲]/[▼] button**  
Adjust the TV's volume.
- ⑤ **TOP MENU button**  
Displays a DVD's top menu or a DVD's title.
- ⑥ **Arrow [▲]/[▼]/[◀]/[▶] and ENTER buttons**  
Used to navigate menus and select items.
- ⑦ **SETUP button**  
Used to access the DVD player's settings.
- ⑧ **Playback buttons**  
Play [▶], Pause [⏸], Stop [■], Fast Reverse [◀◀], Fast forward [▶▶], Previous [◀◀], and Next [▶▶].
- ⑨ **REPEAT button**  
Used with the repeat playback function.
- ⑩ **SEARCH button\***  
Used to search title, chapter, and track numbers, and to search times for locating specific points.
- ⑪ **Number buttons**  
Used to enter title, chapter, and track numbers, and to enter times for locating specific points. The [+10] button\* works as a +10 button or "--/--" button.
- ⑫ **DISPLAY button**  
Displays information about the current disc, title, chapter, or track, including elapsed time, remaining time, total time, and so on.
- ⑬ **MUTING button (51)**  
Mutes or unmutes the AV receiver.
- ⑭ **DISC +/-, CH +/- button**  
Selects discs on a DVD changer. Selects TV channels on a component with a built-in tuner.
- ⑮ **VOL [▲]/[▼] button (49)**  
Adjusts the volume of the AV receiver.
- ⑯ **MENU button**  
Displays a DVD's menu.
- ⑰ **RETURN button**  
Exits the DVD player's setup menu or returns to the previous menu.
- ⑱ **AUDIO button\***  
Selects foreign language soundtracks and audio formats (e.g., Dolby Digital or DTS).
- ⑲ **RANDOM button\***  
Used with the random playback function.
- ⑳ **PLAY MODE button\***  
Selects play modes on components with selectable play modes.

## Controlling Other Components—Continued

### 21 CLR button

Cancels functions and clears entered numbers.

#### Notes:

- If you enter the remote control code for a HD DVD or Blu-ray player that has A, B, C, and D or colored buttons, the [SEARCH], [REPEAT], [RANDOM],

and [PLAY MODE] buttons will work as colored or A, B, C, D buttons. In this case, these buttons cannot be used to set repeat playback, random playback, or select play modes.

- Buttons marked with an asterisk (\*) are not supported by the **RHID** function.

## Controlling a VCR or PVR

By pressing the REMOTE MODE button that's been programmed with the remote control code for your VCR (TV/VCR, PVR, DBS/PVR combination or cable/PVR combination), you can control your video recorder with the following buttons.

For details on entering a remote control code for a different component, see page 84.

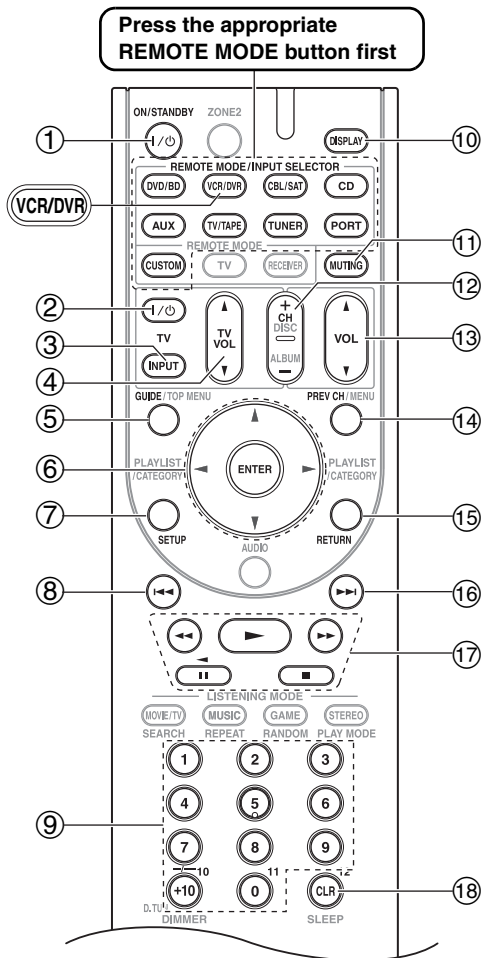

- ① **ON/STANDBY button**  
Set the video recorder to On or Standby.
- ② **TV [I/⏻] button**  
Set the TV to On or Standby.
- ③ **TV [INPUT] button**  
Selects the TV's external inputs.
- ④ **TV VOL [▲]/[▼] button**  
Adjust the TV's volume.
- ⑤ **GUIDE button**  
Displays the program guide or navigation list.
- ⑥ **Arrow [▲]/[▼]/[◀]/[▶] and ENTER buttons**  
Used to navigate menus and select items.
- ⑦ **SETUP button**  
Displays the video recorders setup menu.
- ⑧ **Previous [◀◀] button**  
Previous or instant replay function.
- ⑨ **Number buttons**  
Enter numbers. The [0] button enters 11 on some components. The [+10] button works as a +10 button or "--/--" button.
- ⑩ **DISPLAY button**  
Displays information.
- ⑪ **MUTING button (51)**  
Mutes or unmutes the AV receiver.
- ⑫ **CH +/- button**  
Selects TV channels on the video recorder.
- ⑬ **VOL [▲]/[▼] button (49)**  
Adjusts the volume of the AV receiver.
- ⑭ **PREV CH button**  
Selects the previous channel.
- ⑮ **RETURN button**  
Exits the menu or returns to the previous menu.
- ⑯ **Next [▶▶] button**  
Next or advance function.
- ⑰ **Playback buttons**  
Play [▶], Pause [⏸], Stop [■], Rewind [◀◀], and Fast forward [▶▶].
- ⑱ **CLR button**  
Cancels functions or enters the number 12.

#### Note:

With some components, certain buttons may not work as expected, and some may not work at all.



## Controlling a Satellite Receiver or Cable Receiver

By pressing the REMOTE MODE button that's been programmed with the remote control code for your satellite receiver, cable receiver, or DVD recorder (DBS/PVR combination or cable/PVR combination), you can control your player with the following buttons.

For details on entering a remote control code for a different component, see page 84.

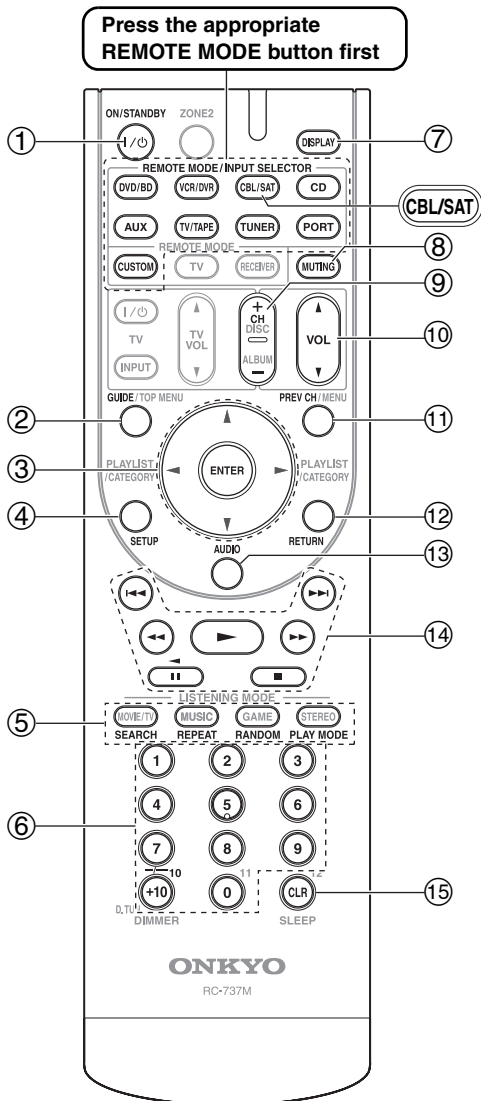

- ① **ON/STANDBY button**  
Set the component to On or Standby.
- ② **GUIDE button**  
Displays the onscreen program guide.
- ③ **Arrow [▲]/[▼]/[◀]/[▶] and ENTER buttons**  
Used to navigate menus and select items.
- ④ **SETUP button**  
Displays the setup menu.
- ⑤ **SEARCH, REPEAT, RANDOM, and PLAY MODE buttons**  
Function as colored buttons.
- ⑥ **Number buttons**  
Enter numbers. The [+10] button works as a +10 button or "--/--" button.
- ⑦ **DISPLAY button**  
Displays information.
- ⑧ **MUTING button (51)**  
Mutes or unmutes the AV receiver.
- ⑨ **CH +/- button**  
Selects satellite/cable channels.
- ⑩ **VOL [▲]/[▼] button (49)**  
Adjusts the volume of the AV receiver.
- ⑪ **PREV CH button**  
Selects the previous channel.
- ⑫ **RETURN button**  
Exits the menu.
- ⑬ **AUDIO button**  
Selects foreign language soundtracks and audio formats (e.g., Dolby Digital or DTS).
- ⑭ **Playback buttons**  
Play [▶], Pause [⏸], Stop [■], Fast Reverse [◀◀], Fast forward [▶▶], Previous [◀◀], and Next [▶▶].
- ⑮ **CLR button**  
Cancels functions and clears entered numbers.

**Note:**

With some components, certain buttons may not work as expected, and some may not work at all.

## Controlling a CD Player

By pressing the REMOTE MODE button that's been programmed with the remote control code for your CD player, you can control your player with the following buttons.

The [CD] button is preprogrammed with the remote control code for controlling an Onkyo CD player.

For details on entering a remote control code for a different component, see page 84.

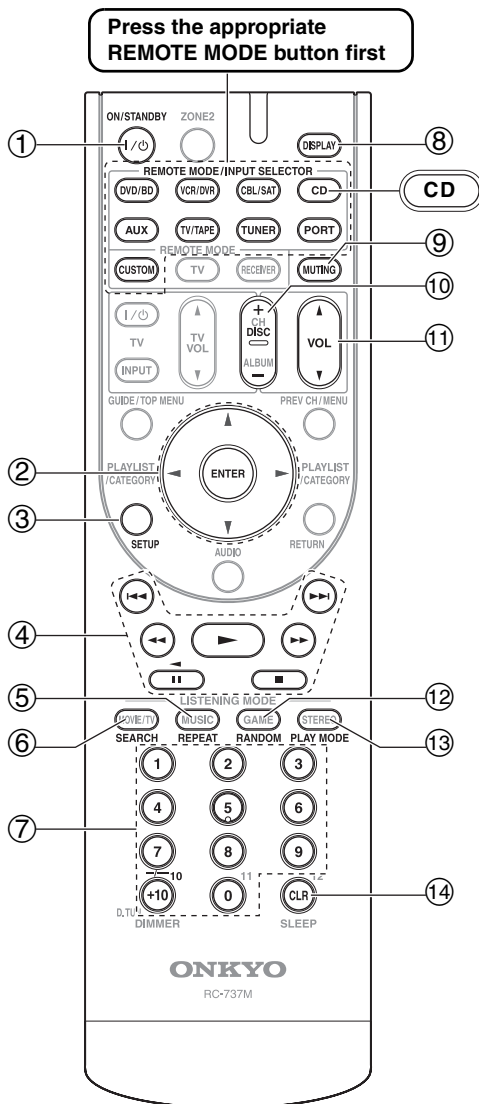

- ① **ON/STANDBY button**  
Set the component to On or Standby.
- ② **Arrow [▲]/[▼]/[◀]/[▶] and ENTER buttons\***  
Used to navigate menus and select items.
- ③ **SETUP button\***  
Used to access the Onkyo CD player's settings.
- ④ **Playback buttons**  
Play [▶], Pause [⏸], Stop [■], Fast Reverse [◀◀], Fast forward [▶▶], Previous [◀◀], and Next [▶▶].
- ⑤ **REPEAT button**  
Used with the repeat playback function.
- ⑥ **SEARCH button\***  
Used to locate specific points.
- ⑦ **Number buttons**  
Used to enter track numbers and times for locating specific points. The [+10] button works as a +10 button or “-/-” button.
- ⑧ **DISPLAY button**  
Displays information about the current disc or track, including elapsed time, remaining time, total time, and so on.
- ⑨ **MUTING button (51)**  
Mutes or unmutes the AV receiver.
- ⑩ **DISC +/- button**  
Selects discs on a CD changer.
- ⑪ **VOL [▲]/[▼] button (49)**  
Adjusts the volume of the AV receiver.
- ⑫ **RANDOM button**  
Used with the random playback function.
- ⑬ **PLAY MODE button\***  
Selects play modes on components with selectable play modes.
- ⑭ **CLR button**  
Cancels functions and clears entered numbers.

**Notes:**

- Buttons marked with an asterisk (\*) are not supported by the RI control.
- With some components, certain buttons may not work as expected, and some may not work at all.

## Controlling an RI Dock

By pressing the REMOTE MODE button that's been programmed with the remote control code for your Dock, you can control your iPod in the Dock with the following buttons.

For some RI docks, the "ON/STANDBY" button may not work with a remote control code **82990** (without **RI**).

In this case, make an **RI** connection and enter a remote control code **82351** (with **RI**).

For details on entering a remote control code, see page 84.

### When Using an RI Dock:

- Connect the RI Dock to the TV/TAPE IN, VCR/DVR IN, or CBL/SAT IN L/R jacks.
- Set the RI Dock's RI MODE switch to "HDD" or "HDD/DOCK".
- Set the AV receiver's Input Display to "DOCK" (see page 45).
- See to the Dock's instruction manual for more information.

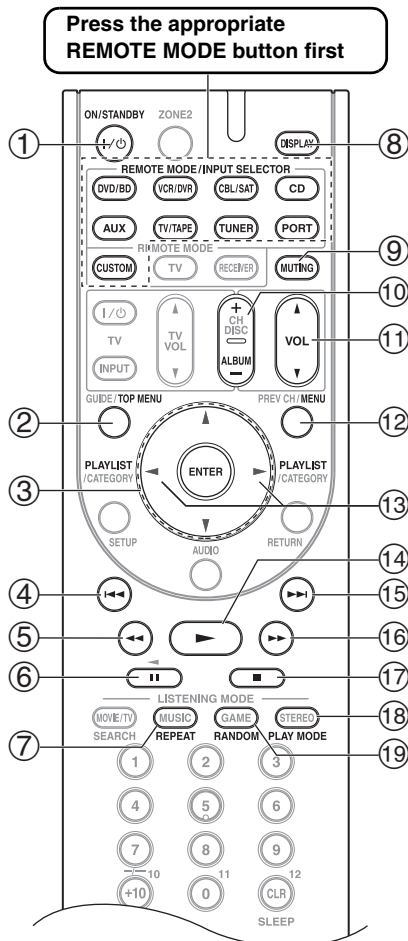

- ① **ON/STANDBY button**  
Turns the iPod on or off.

### Notes:

- This button does not turn the Onkyo DS-A2 or DS-A2X RI Dock on or off.

- Your iPod may not respond the first time you press this button, in which case you should press it again. This is because the remote controller transmits the On and Standby commands alternately, so if your iPod is already on, it will remain on when the remote controller transmits an On command. Similarly, if your iPod is already off, it will remain off when the remote controller transmits an Off command.

- ② **TOP MENU button**  
Works as a Mode button when used with a DS-A2 RI Dock.
- ③ **Arrow [▲]/[▼] and ENTER buttons**  
Used to navigate menus and select items.
- ④ **Previous [⏮] button**  
Restarts the current song. Press it twice to select the previous song.
- ⑤ **Rewind [◀◀] button**  
Press and hold to rewind.
- ⑥ **Pause [⏸] button**  
Pauses playback.
- ⑦ **REPEAT button**  
Used with the repeat function.
- ⑧ **DISPLAY button**  
Turns on the backlight for 30 seconds.
- ⑨ **MUTING button (51)**  
Mutes or unmutes the AV receiver.
- ⑩ **ALBUM +/- button**  
Selects the next or previous album.
- ⑪ **VOL [▲]/[▼] button (49)**  
Adjusts the volume of the AV receiver.
- ⑫ **MENU button**  
Exits the menu.
- ⑬ **PLAYLIST [◀]/[▶] button**  
Selects the previous or next playlist on the iPod.
- ⑭ **Play [▶] button**  
Starts playback. If the component is off, it will turn on automatically.
- ⑮ **Next [▶▶] button**  
Selects the next song.
- ⑯ **Fast Forward [▶▶▶] button**  
Press and hold to fast forward.
- ⑰ **Stop [■] button**  
Stops playback and displays a menu.
- ⑱ **PLAY MODE button**  
Selects play modes on components with selectable play modes.  
Works as a Resume button when used with a DS-A2 RI Dock.
- ⑲ **RANDOM button**  
Used with the shuffle function.

### Note:

With some components, certain buttons may not work as expected, and some may not work at all.

## Controlling a Cassette Recorder

By pressing the REMOTE MODE button that's been programmed with the remote control code for your cassette recorder, you can control your cassette recorder with the following buttons.

The [TV/TAPE] button is preprogrammed with the remote control code for controlling an Onkyo cassette recorder when used with an **RI** connection.

For details on entering a remote control code for a different component, see page 84.

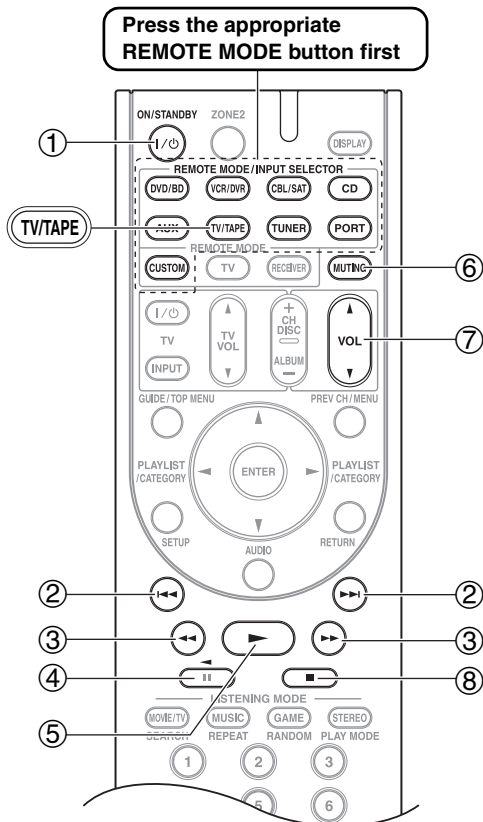

On twin cassette decks, only Deck B can be controlled.

- ① **ON/STANDBY button**  
Turns the cassette recorder on or off.
- ② **Previous and Next [◀◀]/[▶▶] buttons**  
The Previous [◀◀] button selects the previous track. During playback it selects the beginning of the current track. The Next [▶▶] button selects the next track.  
Depending on how they were recorded, the Previous and Next [◀◀]/[▶▶] buttons may not work properly with some cassette tapes.
- ③ **Rewind and Fast Forward [◀◀]/[▶▶] buttons**  
The Rewind [◀◀] button starts rewind. The Fast Forward [▶▶] button starts fast forward.
- ④ **Reverse Play [◀] button**  
Starts reverse playback.
- ⑤ **Play [▶] button**  
Starts playback.
- ⑥ **MUTING button (51)**  
Mutes or unmutes the AV receiver.
- ⑦ **VOL [▲]/[▼] button (49)**  
Adjusts the volume of the AV receiver.
- ⑧ **Stop [■] button**  
Stops playback.

### Notes:

- With some components, certain buttons may not work as expected, and some may not work at all.
- An Onkyo cassette recorder connected via **RI** can also be controlled in Receiver mode.

# Troubleshooting

If you have any trouble using the AV receiver, look for a solution in this section. If you can't resolve the issue yourself, contact your Onkyo dealer.

If you can't resolve the issue yourself, try resetting the AV receiver before contacting your Onkyo dealer.

**To reset the AV receiver to its factory defaults, turn it on and, while holding down the [VCR/DVR] button, press the [ON/STANDBY] button. "Clear" will appear on the display and the AV receiver will enter Standby mode.**

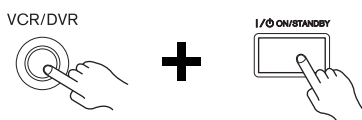

Note that resetting the AV receiver will delete your radio presets and custom settings.

## Power

### Can't turn on the AV receiver

- Make sure that the power cord is plugged into the wall outlet properly.
- Unplug the power cord from the wall outlet, wait 5 seconds or more, then plug it back in again.

### The AV receiver turns off as soon as it's turned on

- The amp protection circuit has been activated. Remove the power cord from the wall outlet immediately. Disconnect all speaker cables and input sources, and leave the AV receiver with its power cord disconnected for 1 hour. After that, reconnect the power cord and set the volume to maximum. If the AV receiver stays on, set the volume to minimum, disconnect the power cord, and reconnect your speakers and input sources. If the AV receiver turns off when you set the volume to maximum, disconnect the power cord, and contact your Onkyo dealer.

## Audio

### There's no sound or it's very quiet

- To listen to an audio source that's connected to an HDMI input, make sure that input is assigned to an input selector (page 41).
- To listen to an audio source that's connected to an OPTICAL or COAXIAL input, make sure that input is assigned to an input selector (page 43).
- Make sure that all audio connecting plugs are pushed in all the way (page 25).
- Make sure that the polarity of the speaker cables is correct, and that the bare wire is in contact with the metal part of each speaker terminal (page 19).
- Make sure that the speaker cables are not shorting.

- Check the volume (page 49). The AV receiver is designed for home theater enjoyment and has a wide volume range for precise adjustment.
- If the MUTING indicator is flashing on the display, press the remote controller's [MUTING] button to unmute the AV receiver (page 51).
- While a pair of headphones is connected to the PHONES jack, no sound is output by the speakers (page 51).
- Check the digital audio output settings on the source component. On some game consoles, such as those that can play DVDs, the default setting is off.
- With some DVD-Video discs, you need to select an audio format from a menu or with the [AUDIO] button on your DVD player's remote controller.
- If your turntable doesn't have a phono preamp built-in, you must connect one between it and the AV receiver.
- If your turntable uses an MC cartridge, you must connect an MC head amp, or an MC transformer and a phono preamp.
- Check the speaker settings (pages 68–70).
- If the digital signal format is set to PCM or DTS, set it to "Auto" (page 52).
- If there's no sound from a DVD player connected to an HDMI IN, check the DVD player's output settings, and be sure to select a compatible audio format.

### Only the front speakers produce sound

- When the Stereo or Mono listening mode is selected, only the front speakers and subwoofer produce sound.
- Check the "2-2. Sp Config (Speaker Configuration)" (page 68).

### Only the center speaker produces sound

- If you use the Dolby Pro Logic IIx Movie or Dolby Pro Logic IIx Music listening mode with a mono source, such as an AM radio station or mono TV program, the sound will be concentrated in the center speaker.
- Check the "2-2. Sp Config (Speaker Configuration)" (page 68).

### The center speaker produces no sound

- When the Stereo or Mono listening mode is selected, the center speaker produces no sound (page 66).
- Check the "2-2. Sp Config (Speaker Configuration)" (page 68).

### The surround speakers produce no sound

- When the T-D (Theater-Dimensional), Stereo or Mono listening mode is selected, the surround speakers produce no sound.
- Depending on the source and the current listening mode, not much sound may be produced by the surround speakers. Try another listening mode (page 61).
- Check the "2-2. Sp Config (Speaker Configuration)" (page 68).

### The front high speakers or surround back speakers produce no sound

- Depending on the current listening mode, no sound may be produced by the front high speakers or surround back speakers. Try another listening mode (page 61).
- Not much sound may be produced by the front high speakers or surround back speakers with some sources.
- Check the “2-2. Sp Config (Speaker Configuration)” (page 68).
- While Powered Zone 2 is being used, playback in the main room is reduced to 5.1-channels and the front high speakers or surround back speakers produce no sound (page 80).

### The subwoofer produces no sound

- If the source material contains no audio in the LFE channel, the subwoofer produces no sound.
- Check the “2-2. Sp Config (Speaker Configuration)” (page 68).

### The Zone 2 speakers produce no sound

- The Zone 2 speakers only output sources that are connected to an analog input. Check to see if the source component is connected to an analog input.
- “Powered Zone 2” cannot be used if “Sp Type” is set to “Bi-Amp” (page 44).

### There’s no sound with a certain signal format

- Check the digital audio output setting on the source component. On some game consoles, such as those that can play DVDs, the default setting is off.
- With some DVD-Video discs, you need to select an audio format from a menu or with the [AUDIO] button on your DVD player’s remote controller.

### Can’t get 6.1- or 7.1-channel playback

- While Powered Zone 2 is being used, playback in the main room is reduced to 5.1-channels and the surround back speakers produce no sound (page 80).

### Can’t select the Pure Audio listening mode

- The Pure Audio listening mode cannot be selected while Zone 2 is on.
- The Pure Audio listening mode is not available on the North American models.

### The volume cannot be set to 79

- Check to see if a maximum volume has been set (page 77).
- If the volume level of each individual speaker has been adjusted to high positive values (page 70), then the maximum master volume possible may be reduced. Note that the individual speaker volume levels are set automatically after the Audyssey 2EQ™ Room Correction and Speaker Setup function has been completed (page 46).
- When the levels of each speaker have been adjusted (page 70), the maximum possible volume may be reduced.

### Noise can be heard

- Using cable ties to bundle audio cables with power cords, speaker cables, and so on can degrade audio performance, so don’t use them.

- An audio cable may be picking up interference. Try repositioning your cables.

### The Late Night function doesn’t work

- Make sure that the source is Dolby Digital, Dolby Digital Plus, and Dolby TrueHD (page 73).

### About DTS signals

- When playing DTS program material, using the pause, fast forward, or fast reverse function on your player may produce a short audible noise. This is not a malfunction.
- When DTS program material ends and the DTS bitstream stops, the AV receiver remains in DTS listening mode and the DTS indicator remains on. This is to prevent noise when you use the pause, fast forward, or fast reverse function on your player. If you switch your player from DTS to PCM, as the AV receiver does not switch formats immediately, you may not hear anything, in which case you should stop your player for about 3 seconds, and then resume playback.
- With some CD players, you won’t be able to playback DTS material properly even though your player is connected to a digital input on the AV receiver. This is usually because the DTS bitstream has been processed (e.g., output level, sampling rate, or frequency response changed) and the AV receiver doesn’t recognize it as a genuine DTS signal. In such cases, you may hear noise.

### The beginning of audio received by an HDMI IN can’t be heard

- Since it takes longer to identify the format of an HDMI signal than it does for other digital audio signals, sound may not be output immediately.

## Video

### There’s no picture

- Make sure that all video connecting plugs are pushed in all the way (page 25).
- Make sure that each video component is properly connected.
- On your TV, make sure that the video input to which the AV receiver is connected is selected.
- While the Pure Audio listening mode is selected, the video circuitry is turned off and only the HDMI OUT outputs video signals.
- The AV receiver does not convert between formats, so if a video source component is connected to a component video input, your TV must be connected to the component video output (page 26).
- If the video source is connected to an HDMI input, your TV must be connected to the HDMI OUT (page 26).

### There’s no picture from a source connected to an HDMI IN

- Reliable operation with an HDMI-to-DVI adapter is not guaranteed. In addition, video signals from a PC are not supported (page 28).

- If the message “Resolution Error” appears on the AV receiver’s display, this indicates that your TV does not support the current video resolution and you need to select another resolution on your DVD player.

### Tuner

#### Reception is noisy, stereo FM reception suffers from hiss, or the FM STEREO indicator doesn’t light up

- Relocate your antenna.
- Move the AV receiver away from your TV or computer.
- When listening to an AM station, operating the remote controller may cause noise.
- Passing cars and airplanes can cause interference.
- Concrete walls weaken radio signals.
- If nothing improves the reception, install an outdoor antenna.

### Remote Controller

#### The remote controller doesn’t work

- Make sure that the batteries are installed with the correct polarity (page 16).
- Make sure that the remote controller is not too far away from the AV receiver and there’s no obstruction between the remote controller and the AV receiver’s remote control sensor (page 16).
- Make sure you’ve selected the correct remote controller mode (pages 17 and 86–92).
- Make sure you’ve entered the correct remote control code (page 84).

#### Can’t control other components

- Make sure you’ve selected the correct remote controller mode (pages 17 and 86–92).
- If you’ve connected an **RI**-capable Onkyo RI Dock to the TV/TAPE IN, CBL/SAT IN or VCR/DVR IN jacks, for the remote controller to work properly, you must set the Input Display to “DOCK” (page 45).
- The entered remote control code may not be correct. If more than one code is listed, try each one.
- With some AV components, certain buttons may not work as expected, and some may not work at all.
- To control an Onkyo component that’s connected via **RI**, point the remote controller at the AV receiver. Be sure to enter the appropriate remote control code first (page 85).
- To control an Onkyo component that’s not connected via **RI**, or another manufacturer’s component, point the remote controller at that component. Be sure to enter the appropriate remote control code first (page 84).

### Dock for iPod or iPhone

#### There’s no sound

- Make sure your iPod or iPhone is playing.
- Make sure your iPod or iPhone is inserted properly in the Dock.
- Make sure the UP-A1 series Dock is connected to the UNIVERSAL PORT jack on the AV receiver.
- Make sure the AV receiver is turned on, the correct input source is selected, and the volume is turned up.
- Make sure the plugs are pushed in all the way.
- Try resetting your iPod or iPhone.

#### There’s no video

- Make sure that your iPod or iPhone’s TV OUT setting is set to On.
- Make sure the correct input is selected on your TV or the AV receiver.
- Some versions of the iPod or iPhone do not output video.

#### The AV receiver’s remote controller doesn’t control your iPod or iPhone

- Make sure your iPod or iPhone is properly inserted in the Dock. If your iPod or iPhone is in a case, it may not connect properly to the Dock. Always remove your iPod or iPhone from the case before inserting it into the Dock.
- The iPod or iPhone cannot be operated while it’s displaying the Apple logo.
- Make sure you’ve selected the right remote mode.
- When you use the AV receiver’s remote controller, point it toward your amp.
- If you still can’t control your iPod or iPhone, start playback by pressing your iPod or iPhone’s Play button. Remote operation should then be possible.
- Try resetting your iPod or iPhone.
- Depending on your iPod or iPhone, some buttons may not work as expected.

#### The AV receiver unexpectedly selects your iPod or iPhone as the input source

- Always pause iPod or iPhone playback before selecting a different input source. If playback is not paused, the Direct Change function may select your iPod or iPhone as the input source by mistake during the transition between tracks.

### Recording

#### Can't record

- On your recorder, make sure the correct input is selected.
- To prevent signal loops and damage to the AV receiver, input signals are not fed through to outputs with the same name (e.g., TV/TAPE IN to TV/TAPE OUT or VCR/DVR IN to VCR/DVR OUT).
- When the Pure Audio listening mode is selected, video recording is not possible because no video signals are output. Select another listening mode.

### Others

#### The sound changes when I connect my headphones

- When a pair of headphones is connected, the listening mode is set to Stereo, unless it's already set to Stereo, Mono, Direct, or Pure Audio, in which case it stays the same. (Pure Audio listening mode is not available for North American models.)

#### How do I change the language of a multiplex source

- On the "Audio Adjust" menu, change the "Input (Mux)" setting to "Main" or "Sub" (page 71).

#### The **RI** functions don't work

- To use **RI**, you must make an **RI** connection and an analog audio connection (RCA) between the component and AV receiver, even if they are connected digitally (page 39).
- While Zone 2 is selected, the **RI** functions don't work.

#### The AV receiver's display doesn't work

- The display is turned off when the Pure Audio listening mode is selected. Select another listening mode.

#### The following settings can be made for the composite video inputs

You must use the buttons on the unit to make these settings.

1. While holding down the input selector button for the input source that you want to set, press the [SETUP] button.
2. Use the Left and Right [◀]/[▶] buttons to change the setting.
3. Press the input selector button for the input source that you want to set when you've finished.

- **Video Attenuation**

This setting can be made for the DVD/BD, VCR/DVR, CBL/SAT, or AUX input.

If you have a games console connected to the composite video input, and the picture isn't very clear, you can attenuate the gain.

**Video ATT:0:** (default).

**Video ATT:2:** Gain is reduced by 2 dB.

The AV receiver contains a microcomputer for signal processing and control functions. In very rare situations, severe interference, noise from an external source, or static electricity may cause it to lockup. In the unlikely event that this happens, unplug the power cord from the wall outlet, wait at least 5 seconds, and then plug it back in again.

Onkyo is not responsible for damages (such as CD rental fees) due to unsuccessful recordings caused by this unit's malfunction. Before you record important data, make sure that the material will be recorded correctly.

Before disconnecting the power cord from the wall outlet, set the AV receiver to Standby.



# Specifications

## HT-R670

### Amplifier Section

Rated Output Power	North American: <b>130 watts minimum continuous power per channel, 6 ohms, at 1 kHz with a maximum total harmonic distortion of 1%</b> Asian: 7 ch × 130 W at 6 ohms, 1kHz (IEC)
Maximum Output Power	Asian: 7 ch × 160 W at 6 ohms, 1kHz (JEITA)
Dynamic Power	180 W (3Ω Front) 160 W (4Ω Front) 100 W (8Ω Front)
THD (Total Harmonic Distortion)	0.08% (1 kHz 1 W)
Damping Factor	60 (Front, 1 kHz, 8Ω)
Input Sensitivity and Impedance	200 mV/ 47 kΩ (LINE)
Output Level and Impedance	200 mV/ 2.2 kΩ (REC OUT)
Frequency Response	5 Hz–100 kHz/ +1 dB–3 dB (Direct mode)
Tone Control	±10 dB, 50 Hz (BASS) ±10 dB, 20 kHz (TREBLE)
Signal to Noise Ratio	106 dB (LINE, IHF-A)
Speaker Impedance	North American: 6Ω–16Ω Asian: 4Ω–16Ω

### Video Section

Input Sensitivity/Output Level and Impedance	1 V <sub>p-p</sub> /75Ω (Component Y) 0.7 V <sub>p-p</sub> /75Ω (Component Pb/Cb, Pr/Cr) 1 V <sub>p-p</sub> /75Ω (Composite)
Component Video Frequency Response	5 Hz – 50 MHz, –3 dB

### Tuner Section

FM Tuning Frequency Range	North American: 87.5 MHz – 107.9 MHz Asian: 87.5 MHz – 108.0 MHz
AM Tuning Frequency Range	North American: 530 kHz – 1710 kHz Asian: 522/530 kHz – 1611/1710 kHz
Preset Channel	40

### General

Power Supply	North American: AC 120 V, 60Hz Asian: AC 220 V – 240V, 50/60 Hz
Power Consumption	North American: 4.9 A Asian: 470W
Dimensions (W × H × D)	435 × 151.5 × 329 mm (17-1/8" × 5-15/16" × 12-15/16")
Weight	North American: 8.9 kg 19.6 lbs. Asian: 9.7 kg 21.4 lbs.

#### ■ Video Inputs

HDMI	IN 1, IN 2, IN 3, IN 4
Component	IN 1, IN 2
Composite	DVD/BD, CBL/SAT, VCR/DVR, AUX

#### ■ Video Outputs

HDMI	OUT
Component	OUT
Composite	VCR/DVR (REC OUT), MONITOR OUT

#### ■ Audio Inputs

Digital Inputs	COAXIAL:2 OPTICAL :2
Analog Inputs	DVD/BD, VCR/DVR, CBL/SAT, TV/TAPE, CD, AUX (PORTABLE)

#### ■ Audio Outputs

Analog Outputs	VCR/DVR, TV/TAPE, ZONE 2
Subwoofer Pre Output	1
Speaker Outputs	Main (L, R, C, SL, SR, SBL, SBR) + ZONE2 /Front High (L, R)
Phones	1

#### ■ Control Terminal

MIC	Yes
-----	-----

Specifications and features are subject to change without notice.

## HTP-670

### ■ Powered Subwoofer (SKW-770)

Type:	Bass-reflex
Input sensitivity/Impedance:	140 mV/20 kΩ
Maximum output power:	290 W (Dynamic power)
Frequency response:	25 Hz–150 Hz
Cabinet capacity:	37 L (1.3 cubic feet)
Dimensions (W × H × D):	275 × 507 × 411 mm (10-13/16" × 19-15/16" × 16-3/16")
Weight:	11.6 kg (25.6 lbs.)
Drivers unit:	25 cm (10") Cone Woofer
Power supply	North American: AC 120 V, 60 Hz Asian: AC 220 V – 240V, 50/60 Hz
Power consumption	North American: 163 W Asian: 137 W
Other:	Auto Standby function

### ■ Front Speaker (SKF-670)

Type:	2 Way closed box
Impedance:	6 Ω
Maximum input power:	130 W
Sensitivity:	81 dB/W/m
Frequency response:	60 Hz–50 kHz
Crossover frequency:	4 kHz
Cabinet capacity:	2.1 L (0.074 cubic feet)
Dimensions (W × H × D):	120 × 231 × 122 mm (4-3/4" × 9-1/8" × 4-13/16") (incl. grille and projection)
Weight:	1.1 kg (2.4 lbs.)
Drivers unit:	10 cm (4") Cone woofer 2.5 cm (1") Balanced dome
Terminal:	Spring type color coded
Keyhole slot:	2
Grille:	Fixed

### ■ Center Speaker (SKC-670)

Type:	2 Way closed box
Impedance:	6 Ω
Maximum input power:	130 W
Sensitivity:	81 dB/W/m
Frequency response:	60 Hz–50 kHz
Crossover frequency:	4 kHz
Cabinet capacity:	2.1 L (0.074 cubic feet)
Dimensions (W × H × D):	231 × 121 × 128 mm (9-1/8" × 4-3/4" × 5-1/16") (incl. grille and projection)
Weight:	1.1 kg (2.4 lbs.)
Drivers unit:	10 cm (4") Cone woofer 2.5 cm (1") Balanced dome
Terminal:	Spring type color coded
Keyhole slot:	2
Grille:	Fixed

### ■ Surround/Surround Back Speaker (SKR-670/SKB-670)

Type:	Full-Range closed box
Impedance:	6 Ω
Maximum input power:	130 W
Sensitivity:	80 dB/W/m
Frequency response:	70 Hz–20 kHz
Cabinet capacity:	2.1 L (0.074 cubic feet)
Dimensions (W × H × D):	120 × 231 × 122 mm (4-3/4" × 9-1/8" × 4-13/16") (incl. grille and projection)
Weight:	0.8 kg (1.8 lbs.)
Drivers unit:	8 cm (3-1/4") Cone Speaker
Terminal:	Spring type color coded
Keyhole slot:	2
Grille:	Fixed

## UP-A1

Dimensions (W × H × D):	83 × 33 × 74 mm (3-1/4" × 1-5/16" × 2-15/16")
Weight:	170 g (6 ounces)

Specifications and features are subject to change without notice.

# Memo

---

---



## **ONKYO CORPORATION**

Sales & Product Planning Div. : 2-1, Nisshin-cho, Neyagawa-shi, OSAKA 572-8540, JAPAN  
Tel: 072-831-8023 Fax: 072-831-8163

### **ONKYO U.S.A. CORPORATION**

18 Park Way, Upper Saddle River, N.J. 07458, U.S.A.  
Tel: 201-785-2600 Fax: 201-785-2650 <http://www.us.onkyo.com/>

### **ONKYO EUROPE ELECTRONICS GmbH**

Liegnitzerstrasse 6, 82194 Groebenzell, GERMANY  
Tel: +49-8142-4401-0 Fax: +49-8142-4401-555 <http://www.eu.onkyo.com/>

### **ONKYO EUROPE UK Office**

Suite 1, Gregories Court, Gregories Road, Beaconsfield, Buckinghamshire, HP9 1HQ  
UNITED KINGDOM Tel: +44-(0)1494-681515 Fax: +44(0)-1494-680452

### **ONKYO CHINA LIMITED**

Unit 1&12, 9/F, Ever Gain Plaza Tower 1, 88, Container Port Road, Kwai Chung,  
N.T., HONG KONG Tel: 852-2429-3118 Fax: 852-2428-9039  
<http://www.ch.onkyo.com/>



Y0905-1

SN 29344937

(C) Copyright 2009 ONKYO CORPORATION Japan. All rights reserved.



Download from [www.Somanuals.com](http://www.Somanuals.com). All Manuals Search And Download. 2 9 3 4 4 9 3 7 \*

## Free Manuals Download Website

<http://myh66.com>

<http://usermanuals.us>

<http://www.somanuals.com>

<http://www.4manuals.cc>

<http://www.manual-lib.com>

<http://www.404manual.com>

<http://www.luxmanual.com>

<http://aubethermostatmanual.com>

Golf course search by state

<http://golfingnear.com>

Email search by domain

<http://emailbydomain.com>

Auto manuals search

<http://auto.somanuals.com>

TV manuals search

<http://tv.somanuals.com>