

Future Directions
in Home
Entertainment



Audio/Video
Products
2007-2008

Raising the Bar for High-Definition Entertainment

At Onkyo, we're on a mission to show the A/V industry what high-definition home entertainment is really all about. To get the most out of your movies, music, gaming and broadcasting, we blend the best new technologies with renowned Onkyo build quality and audio expertise. The result is an emotive performance from A/V products that remain intuitive and easy to use.

Leading our new A/V receiver range is the impressive home-network entertainment center, the TX-NR905. Backing it up, with the most advanced A/V processing available, are the high-spec TX-SR875 and TX-SR805. In the popular mid-range category, the TX-SR705 and TX-SR605 are two highly capable receivers to anchor your high-definition movies and music. And rounding out a stellar A/V receiver line-up is our affordable entry-level model, the TX-SR505E.

You are also invited to view the full suite of Onkyo components, such as our quality-focused playback components (pp. 13-14); our versatile home theater packages (p. 15); and our complete range of audiophile hi-fi components (pp. 17-21). As well, you can peruse our superb collection of CD receiver systems (pp. 22-23), home-style components/accessories (pp. 24-25) and speaker systems (p. 26).

CONTENTS

HOME THEATER COMPONENTS	4-14
HOME THEATER PACKAGES	15
VL DIGITAL TECHNOLOGY	16
PURE HI-FI COMPONENTS	17-21
SEPARATE COLLECTION	22-23
HOME STYLE COMPONENTS	24-25
iPod ACCESSORY	25
SPEAKER SYSTEMS	26
GLOSSARY	27
FEATURES	28-29
SPECIFICATIONS	30-31





Invigorating the 2007 A/V Receiver Line-Up— Core Technologies That Make All the Difference

High-Definition Multimedia Interface (HDMI) for Pure Digital Delivery

All the Onkyo A/V receivers released in 2007 incorporate HDMI, enabling a pure, all-digital 1080p video signal to be sent through one connection. Those with the latest version of HDMI (version 1.3a) become powerful control centers for high-definition media. Even multichannel audio—including the studio master quality of the latest Dolby® Digital and DTS® formats (see glossary for definitions)—can be digitally received and processed for up to five channels. HDMI 1.3a will also bring you greater bandwidth, Deep Color™, lip-sync correction and high frame rates.

HDMI



HQV Reon-VX Chip for High-Performance Video Processing

Representing the most sophisticated video processing to be seen in home theater components, the HQV Reon-VX chip provides the ultimate support for standard definition and high-definition deinterlacing; 1080p reconstruction of film sources; filtering of jaggies and artifacts; and the reduction of random, “mosquito” and block (codec) noise. HQV Reon-VX also enables color region enhancement and the rendering of more than one billion colors.

HQV



Standard chips process pixels in blocks, creating unwanted artifacts.



HQV chips process pixels individually for enhanced pixel accuracy.



Images scaled by Reon-VX contain 80% new pixels to augment the original video data.

1080p Video Upscaling and Analog Signal Upconversion

The TX-NR905 and TX-SR875 upscale the resolution of video signals all the way to 1080p, to enable a single HDMI cable connection to a high-definition display. Almost all Onkyo A/V receivers will upconvert video signals for output via either HDMI or component video.

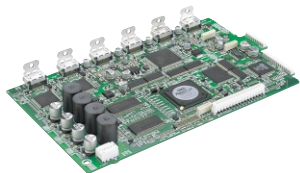
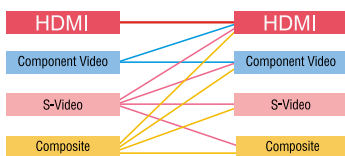

Audyssey Technologies for Room Acoustics Correction

Onkyo A/V receivers use Audyssey's MultEQ® XT or 2EQ™ to counter distortion in dedicated home theaters. Both solutions focus on frequency response and time domain (where most of the problems lie) across the entire listening area. The results are immediately obvious—a clear, well-balanced and natural sound.

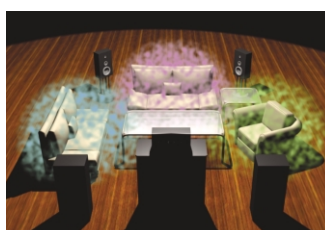

Sound stage is diffuse without Audyssey technologies.



Audyssey technologies create a clearer sound stage.

Fresh Approach to Internal Construction and Amplification Design

The TX-NR905, TX-SR875 and TX-SR805 have been designed so the power amplifier block and the pre-amplifier coexist, but are perfectly isolated. Also, the power supply parts of the left and right stages of each channel are separated. The same receivers use a dual push-pull amplification design with different transistors on each channel to separately amplify the positive and negative halves of the waveform. The whole design works to realize a highly efficient drive capability.

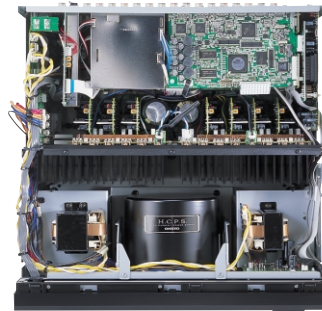

Dual “Push-Pull” Amplification Design with Three-Stage Inverted Darlington Circuitry

Dual push-pull amplification circuitry uses different transistors on each channel to separately amplify the positive and negative halves of the waveform. This circuitry has been shown to improve the efficiency of the relevant A/V receivers. Meanwhile, three-stage inverted Darlington circuitry helps reduce distortion.

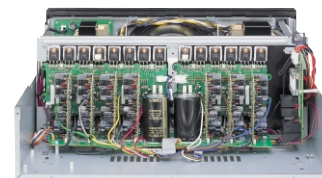

Harnessing Power for Audio Performance

Onkyo's High Current Power Supply (H.C.P.S.) concept is based around power transformers with the capability to respond to the wide dynamics of home theater. In the case of the TX-NR905, a massive toroidal transformer provides efficiency and radiates less noise into the surrounding circuitry, while two separate transformers cater specifically to audio and video processing. You'll also find two quality capacitors (operating at up to 18,000 microfarads) that store the charge demanded from an effective power supply.



Vector Linear Shaping Circuitry (VLSC™)

Onkyo's VLSC employs a unique digital-to-analog conversion circuit to mitigate the effect of signal noise. Data is converted between discrete sampling points, which are then joined with analog vectors in real-time to produce a smooth output wave form. The result—a noiseless, smooth analog signal based on the digital source.

VECTOR LINEAR SHAPING CIRCUITRY

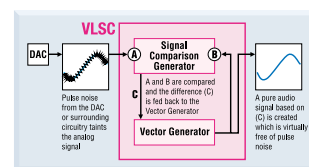

Wide Range Amplifier Technology (WRAT) Providing Amplification Backbone

The cornerstone of any Onkyo A/V receiver, WRAT supports high-quality audio reproduction of the latest high-definition A/V formats. It comprises three key components: (1) A low negative-feedback design for cleaner audio across the frequency range; (2) Closed ground-loop circuits to cancel individual circuit noise and keep the ground potential free of distortion; and (3) A high instantaneous-current capability to handle speaker reflex energy and impedance fluctuations.

WRAT
WIDE RANGE AMP TECHNOLOGY

Highly Precise Onboard Digital-to-Analog Converters

Our high-end receivers use Burr-Brown 192 kHz/24-bit audio DACs (PCM1796) to achieve excellent dynamic performance and improve tolerance to clock jitter. The TX-SR705, one of our mid-range models, draws on the efficiency of Cirrus Logic DACs (CS4398) to handle the complexity of multichannel sound.



Texas Instruments Digital Signal Processing (DSP) Chips

An Onkyo A/V receiver incorporates up to three Aureus™ DSP chips in the audio processing chain. They support the latest and most innovative audio signal processing features and help create a richer listening experience.



Faroudja DCDi Edge™ (Directional Correlational Deinterlacing) Technology

Deinterlacing chips featuring Faroudja DCDi Edge technology convert interlaced video signals to progressive scan signals. This technology helps effectively eliminate video artifacts from HDTV images.

FAROUDJA
DCDi EDGE



Jaggles visible on diagonals.



DCDi eliminates jaggles.

Network for Streaming Audio Files and Internet Radio

The TX-NR905's network gives you access to digital music files (AAC, WMA, MP3, WAV) via an Ethernet network between the TX-NR905 and your computer or through a front-panel USB port. At the heart of the network is Windows Media Connect or Windows Media Player (the TX-NR905 is Microsoft PlaysForSure certified). For internet radio, you can access stations that use MP3 or WMA streaming. The TX-NR905 network also enables installation configuration and set-up of Crestron and AMX controllers with your home theater system or network.



Playback of Different A/V Sources Throughout the Home

Powered Zone 2 and Zone 3 bring multi-zone entertainment to your home through dedicated line outs, pre outs and speaker connections. Independent control of volume levels, speaker balance and bass/treble levels for the separate zones is available on selected models.

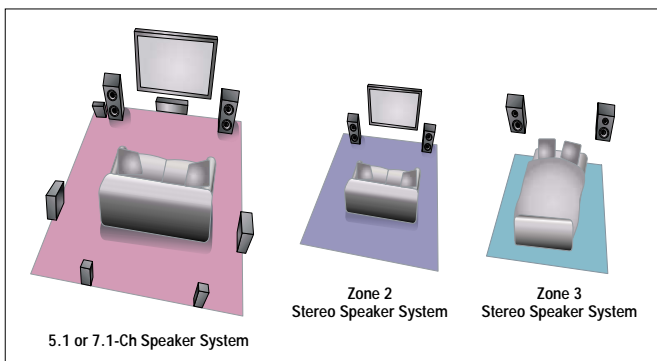
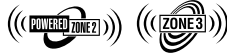

Neural-THX® Surround Decoding Technology

Neural-THX Surround enables content to be encoded into 5.1 or 7.1 channels and transmitted to an Onkyo A/V receiver, where it is decoded onboard. This technology reduces the bandwidth needed by broadcasters to deliver sound content and enables 7.1-channel support for gaming and movies.

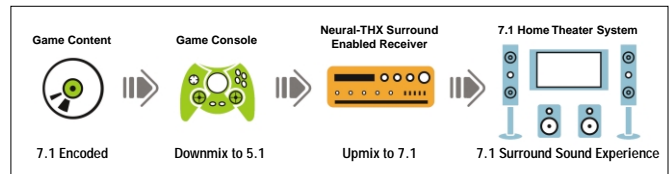

Bi-Amping and BTL (Bridged Transless) Connectivity

Like top-quality amplifiers in the high-end audio world, selected Onkyo A/V receivers have bi-amping and BTL capabilities. Whether it's home theater or music, you have the luxury of a number of different home theater set-ups beyond the standard surround sound configurations.

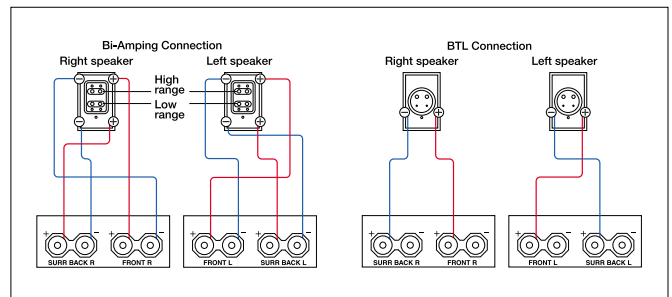

RIHD (Remote Interactive Over HDMI) for System Control

Onkyo receivers with HDMI 1.3a offer integrated system control with selected HDMI-compatible high-definition displays, DVD recorders, HD DVD and Blu-ray Disc players. RIHD lets you seamlessly integrate with other leading brand-name devices, including those in the Panasonic VIERA Link and Toshiba CE-Link™ ranges.

RIHD

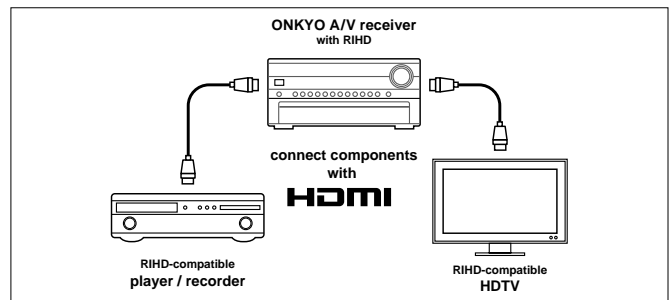

RI (Remote Interactive) System Capability and the iPod

With Onkyo's RI system, you can integrate and operate all components through a single remote control. RI also enables you to integrate virtually any iPod model with one of Onkyo's RI Docks for the iPod.

RI

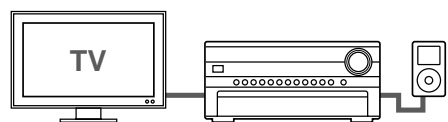

White model is also available.



TX-NR5000E **Integra** THX™ Ultra2™ Certified 7.1-Channel A/V Home Network Receiver

**WHAT HI-FI?
SOUND AND VISION**
★★★★★
(April Issue 2005)



The lesser-used controls are neatly tucked away behind the drop-down panel.

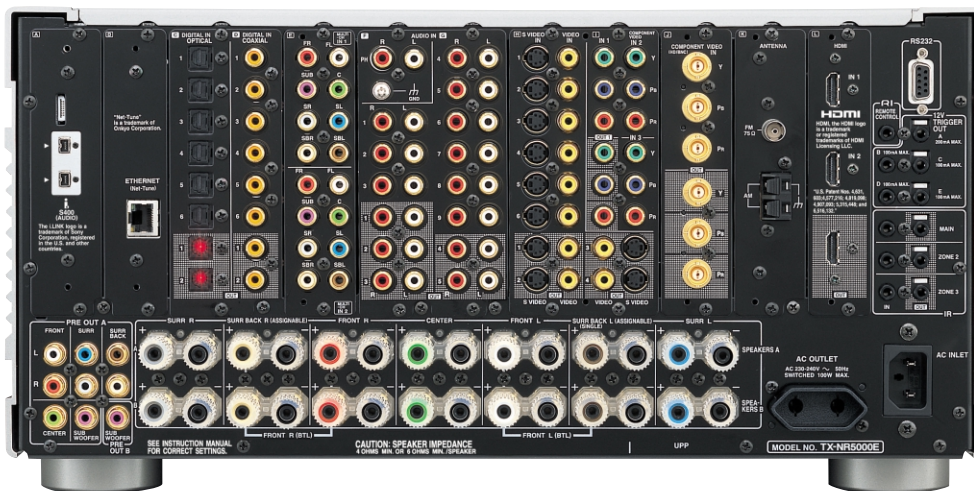

As Onkyo's only module-based home network receiver, the THX Ultra2 certified TX-NR5000E gives you the freedom to configure your home theater exactly as you wish. It's also the most powerful Onkyo receiver ever built, courtesy of its massive shielded toroidal transformer and high-capacity, low-ESR filter capacitors. That's enough power to drive a large home theater connected to multiple A/V sources with an advanced display or projector. You can even assign 7.1-channel set-ups in two different rooms for two independent home theater environments. HDMI and i.LINK ports carry high-resolution, high-bandwidth digital video and audio signals. These transports are ably supported by digital and multichannel analog inputs to handle all surround sound formats, including Dolby® True HD and DTS-HD® Master Audio. Also, an Ethernet port enables Onkyo's exclusive Net-Tune client processor to distribute digital music files on your PC—or internet radio—to up to 11 clients on the same network.

- 250 W/Ch, Continuous 6 Ω, 1 kHz, 1 Channel Driven, IEC
- THX™ Ultra2™ Certified (with THX Processing)
- THX™ Surround EX™, DTS®-ES™ Discrete/Matrix, DTS® Neo:6, DTS® 96/24, Dolby® Digital EX™, Dolby® Pro Logic® IIx, Dolby® Headphone, Dolby® Virtual Speaker
- VLSC (Vector Linear Shaping Circuitry)
- WRAT (Wide Range Amplifier Technology)
- Net-Tune™ Function with MP3/WMA/WAV Playback
- Ethernet Cable Plug-in Capability*
- 2 HDMI Inputs and 1 Output
- 4 Component Video Inputs (3 RCA/1 BNC) and 2 Outputs (RCA/BNC)
- HDMI and Component Video Upconversion
- Time Base Corrector (TBC) for Upconversion
- HDTV-Capable HDMI and Component Video Switching (100 MHz)
- 2 i.LINK Digital Ports
- Speaker A and B Mode for 7.1 Channels
- BTL and Bi-Wiring Connectable for FL/FR with SBL/SBR
- Dual 32-Bit Processing DSP Chips
- 192 kHz/24-Bit DACs for All Channels
- Powered Zone 2 and Zone 3 (Audio and Video)
- 5 12V Trigger Outputs and 3 IR Inputs and Outputs
- Bi-Directional RS232 Port for Interface Control
- 2 Sets of Color-Coded Heavy-Duty Dual Banana Plug-Compatible Transparent Speaker Posts
- Color-Coded 7.1 Multichannel Inputs (Receive 7.1 Surround Sound from Compatible Blu-ray Disc and HD DVD Players) and Pre Outs
- A/V Sync Control Function (Up to 300 ms)
- Elegant Aluminum-Faced RF (Remote Interactive) Remote Control with Scroll Wheel and LCD Display

*For copyright protection purposes, it is not possible to make a digital output signal from Ethernet input signals.

RF-EX6 RF Receiver for TX-NR5000E

- RF Receiver for Use with Onkyo RF-Capable Remote Controller
- Allows Your RF Remote to Control Your Devices by Radio Frequency
- Up to 16 Units in One System
- Integrated IR-Blaster
- 4 Outputs for IR-Emitters
- Range up to 30 m
- 4 Selectable Channels
- Easy Installation
- For Top Mounting and Stand Alone



TX-NR905 THX™ Ultra2™ Certified 7.1-Channel A/V Home Network Receiver



The lesser-used controls are neatly tucked away behind the drop-down panel.

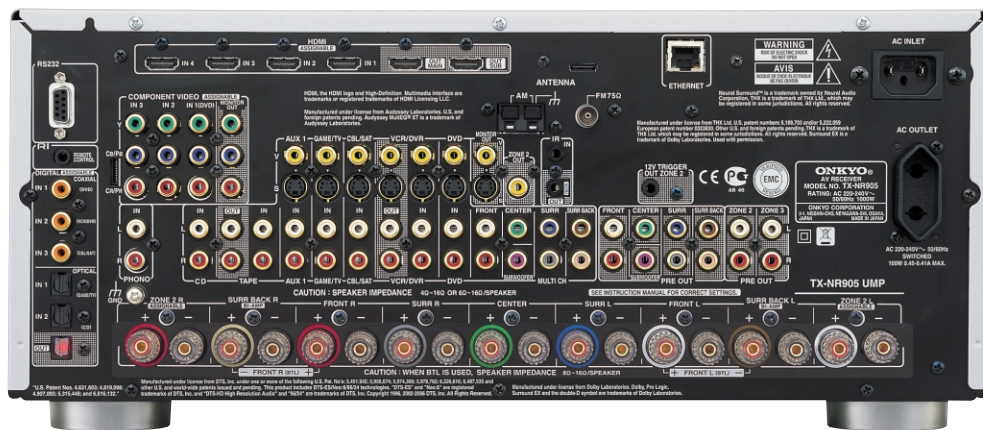

Meet the standout leader of Onkyo's new range of home theater heroes. Embracing all of the technologies synonymous with the 2007 line-up—including HDMI 1.3a, Dolby® TrueHD, DTS-HD® Master Audio, THX Ultra2 and Audyssey MultEQ® XT—the TX-NR905 7.1-channel home network receiver has a number of advantages that propel it into the home theater super league. Look to the TX-NR905's network (interfacing with Windows Media Player and Windows Media Connect) to open up a huge reservoir of internet and computer-based audio resources. And enjoy the edge in high-definition 1080p video processing from the world's first receiver to incorporate HQV Reon-VX. In line with Onkyo's impeccable track record, under the hood of the TX-NR905 you'll find an innovative power supply, remarkable amplification design, and high-performance parts from the likes of Texas Instruments. "Complete" is a tag not given lightly, but the TX-NR905 earns it in style.

- 220 W/Ch, Continuous 6 Ω, 1 kHz, 1 Channel Driven, IEC
- THX™ Ultra2™ Certified (with THX Processing)
- Network Capability for Streaming Internet Radio and Playing Audio Content (via Ethernet and USB Port) (Microsoft PlaysForSure Certified)
- DTS-HD® Master Audio, DTS-HD® High-Resolution Audio, Dolby® TrueHD, Dolby® Digital Plus Decoding
- Massive Toroidal Transformer and Two Separate Transformers for Audio and Video Processing
- VLSC (Vector Linear Shaping Circuitry) for All Channels
- Burr-Brown 192 kHz/24-Bit Audio DACs (PCM1796) for All Channels
- HDMI 1.3a Audio and Video Processing (4 Inputs and 2 Outputs)
- HQV Reon-VX Video Processing with 1080p Upscaling of All Video Sources via HDMI
- HDMI and Component Video Upconversion
- HDTV-Capable HDMI Switching
- HDTV-Capable (100 MHz) Component Video Switching (3 Inputs and 1 Output)
- Dual Push-Pull Amplifier Design with 3-Stage Inverted Darlington Circuitry
- WRAT (Wide Range Amplifier Technology)
- Three TI (Aureus™) 32-Bit DSP Chips for Advanced Processing
- Audyssey MultEQ® XT to Correct Room Acoustic Problems and to Calibrate Speakers
- Neural-THX® Surround Technology for Gaming, Movies and Broadcasting
- Powered Zone 2 (Audio and Video); Zone 2 and Zone 3 Pre Outs; Independent Control for Volume, Balance (Zone 2 and Zone 3) and Bass/Treble (Zone 2 Only)
- RS232, IR and 12V Trigger Connectivity
- Onkyo R1HD (Remote Interactive Over HDMI) for System Control
- Bi-Amping and BTL (Bridged Transless or Bridging) Capability
- Independent Crossover Adjustment for F/C/S/SB (40/50/60/70/80/90/100/120/150/200 Hz)
- Customized Gold-Plated Speaker Posts
- Gold-Plated A/V Inputs and Outputs
- Speaker A/B Configuration
- Compatible with RI (Remote Interactive) Dock for the iPod

TX-SR875 THX™ Ultra2™ Certified 7.1-Channel A/V Surround Home Theater Receiver

WHAT HI-FI? SOUND AND VISION
 ★★★★★
 (September Issue 2007)



The lesser-used controls are neatly tucked away behind the drop-down panel.

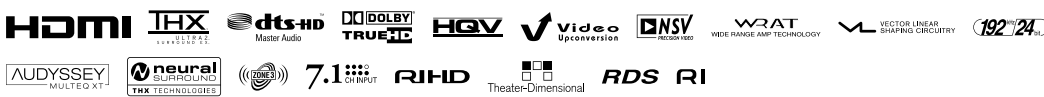

Performing beyond the highest expectations, the TX-SR875 A/V surround home theater receiver deserves all the accolades it gets. The foundations of the TX-SR875 are its isolated power amplifier block and preprocessor, which support a dual push-pull amplification design. In the engine room, you'll find a blend of onboard technologies to drive your home entertainment effortlessly into the high-definition realm. This HDMI-equipped Onkyo receiver can take up to four components with 1080p video and master-quality audio. Even if your input device lacks HDMI, HQV Reon-VX will upscale the resolution of any video signal to 1080p. THX, Audyssey and Texas Instruments lend the very best of their expertise to round out this high-quality package.

- 200 W/Ch, Continuous 6 Ω, 1 kHz, 1 Channel Driven, IEC
- THX™ Ultra2™ Certified (with THX Processing)
- DTS-HD® Master Audio, DTS-HD® High-Resolution Audio, Dolby® TrueHD, Dolby® Digital Plus Decoding
- H.C.P.S. (High Current Power Supply) Massive High Power Transformer
- VLSC (Vector Linear Shaping Circuitry) for All Channels
- Burr-Brown 192 kHz/24-Bit Audio DACs (PCM1796) for All Channels
- HDMI 1.3a Audio and Video Processing (4 Inputs and 1 Output)
- HQV Reon-VX Video Processing with 1080p Upscaling of All Video Sources via HDMI
- HDMI and Component Video Upconversion
- HDTV-Capable HDMI Switching
- HDTV-Capable (100 MHz) Component Video Switching (3 Inputs and 1 Output)
- Dual Push-Pull Amplifier Design with 3-Stage Inverted Darlington Circuitry
- WRAT (Wide Range Amplifier Technology)
- Three TI (Aureus™) 32-Bit DSP Chips for Advanced Processing
- Audyssey MultEQ® XT to Correct Room Acoustic Problems and to Calibrate Speakers
- Neural-THX® Surround Technology for Gaming, Movies and Broadcasting
- Powered Zone 2 (Audio and Video): Zone 2 and Zone 3 Pre Outs; Independent Control for Volume, Balance (Zone 2 and Zone 3) and Bass/Treble (Zone 2 Only)
- RS232, IR and 12V Trigger Connectivity
- Onkyo RIHD (Remote Interactive Over HDMI) for System Control
- IntelliVolume
- Bi-Amping and BTL (Bridged Transless or Bridging) Capability
- Color-Coded 7.1-Multichannel Inputs and Pre Outs
- Independent Crossover Adjustment for F/C/S/SB (40/50/60/70/80/90/100/120/150/200 Hz)
- Compatible with RI (Remote Interactive) Dock for the iPod
- Preprogrammed RI (Remote Interactive) Learning Remote Control with Macros and Mode-Key LEDs

Free Manuals Download Website

<http://myh66.com>

<http://usermanuals.us>

<http://www.somanuals.com>

<http://www.4manuals.cc>

<http://www.manual-lib.com>

<http://www.404manual.com>

<http://www.luxmanual.com>

<http://aubethermostatmanual.com>

Golf course search by state

<http://golfingnear.com>

Email search by domain

<http://emailbydomain.com>

Auto manuals search

<http://auto.somanuals.com>

TV manuals search

<http://tv.somanuals.com>