

ONKYO

Wireless Music System

ABX-N300

Instruction Manual

Thank you for purchasing an Onkyo Wireless Music System. Please read this manual thoroughly before making any connections and plugging it in. Following the instructions in this manual will enable you to obtain optimum performance and listening enjoyment from your new Wireless Music System. Please retain this manual for future reference.

Getting Started.....En-2

Connections En-13

Basic Operation..... En-15

Playing Your iPod/iPhone ... En-16

Listening via the Network... En-18

Clock and Timer En-23

Network Setup..... En-26

Requirements for Internet Radio and Media Servers En-32

Miscellaneous En-33



WARNING:

TO REDUCE THE RISK OF FIRE OR ELECTRIC SHOCK, DO NOT EXPOSE THIS APPARATUS TO RAIN OR MOISTURE.

CAUTION:

TO REDUCE THE RISK OF ELECTRIC SHOCK, DO NOT REMOVE COVER (OR BACK). NO USER-SERVICEABLE PARTS INSIDE. REFER SERVICING TO QUALIFIED SERVICE PERSONNEL.



WARNING
RISK OF ELECTRIC SHOCK
DO NOT OPEN

AVIS
RISQUE DE CHOC ELECTRIQUE
NE PAS OUVRIIR



The lightning flash with arrowhead symbol, within an equilateral triangle, is intended to alert the user to the presence of uninsulated "dangerous voltage" within the product's enclosure that may be of sufficient magnitude to constitute a risk of electric shock to persons.



The exclamation point within an equilateral triangle is intended to alert the user to the presence of important operating and maintenance (servicing) instructions in the literature accompanying the appliance.

Important Safety Instructions

1. Read these instructions.
2. Keep these instructions.
3. Heed all warnings.
4. Follow all instructions.
5. Do not use this apparatus near water.
6. Clean only with dry cloth.
7. Do not block any ventilation openings. Install in accordance with the manufacturer's instructions.
8. Do not install near any heat sources such as radiators, heat registers, stoves, or other apparatus (including amplifiers) that produce heat.
9. Do not defeat the safety purpose of the polarized or grounding-type plug. A polarized plug has two blades with one wider than the other. A grounding type plug has two blades and a third grounding prong. The wide blade or the third prong are provided for your safety. If the provided plug does not fit into your outlet, consult an electrician for replacement of the obsolete outlet.
10. Protect the power cord from being walked on or pinched particularly at plugs, convenience receptacles, and the point where they exit from the apparatus.
11. Only use attachments/accessories specified by the manufacturer.
12. Use only with the cart, stand, tripod, bracket, or table specified by the manufacturer, or sold with the apparatus. When a cart is used, use caution when moving the cart/apparatus combination to avoid injury from tip-over.

PORTABLE CART WARNING
S3125A
13. Unplug this apparatus during lightning storms or when unused for long periods of time.
14. Refer all servicing to qualified service personnel. Servicing is required when the apparatus has been damaged in any way, such as power-supply cord or plug is damaged, liquid has been spilled or objects have fallen into the apparatus, the apparatus has been exposed to rain or moisture, does not operate normally, or has been dropped.
15. Damage Requiring Service
Unplug the apparatus from the wall outlet and refer servicing to qualified service personnel under the following conditions:
 - A. When the power-supply cord or plug is damaged,
 - B. If liquid has been spilled, or objects have fallen into the apparatus,
 - C. If the apparatus has been exposed to rain or water,
 - D. If the apparatus does not operate normally by following the operating instructions. Adjust only those controls that are covered by the operating instructions as an improper adjustment of other controls may result in damage and will often require extensive work by a qualified technician to restore the apparatus to its normal operation,
 - E. If the apparatus has been dropped or damaged in any way, and
 - F. When the apparatus exhibits a distinct change in performance this indicates a need for service.
16. Object and Liquid Entry
Never push objects of any kind into the apparatus through openings as they may touch dangerous voltage points or short-out parts that could result in a fire or electric shock.
The apparatus shall not be exposed to dripping or splashing and no objects filled with liquids, such as vases shall be placed on the apparatus.
Don't put candles or other burning objects on top of this unit.
17. Batteries
Always consider the environmental issues and follow local regulations when disposing of batteries.
18. If you install the apparatus in a built-in installation, such as a bookcase or rack, ensure that there is adequate ventilation.
Leave 20 cm (8") of free space at the top and sides and 10 cm (4") at the rear. The rear edge of the shelf or board above the apparatus shall be set 10 cm (4") away from the rear panel or wall, creating a flue-like gap for warm air to escape.

Precautions

1. **Recording Copyright**—Unless it's for personal use only, recording copyrighted material is illegal without the permission of the copyright holder.
2. **Care**—Occasionally you should dust the unit all over with a soft cloth. For stubborn stains, use a soft cloth dampened with a weak solution of mild detergent and water. Dry the unit immediately afterwards with a clean cloth. Don't use abrasive cloths, thinners, alcohol, or other chemical solvents, because they may damage the finish or remove the panel lettering.

3. Power

WARNING

BEFORE PLUGGING IN THE UNIT FOR THE FIRST TIME, READ THE FOLLOWING SECTION CAREFULLY.

AC outlet voltages vary from country to country. Make sure that the voltage in your area meets the voltage requirements printed on the AC adapter.

The AC adapter is used to disconnect this unit from the AC power source. Make sure that the adapter is readily operable (easily accessible) at all times.

If you do not intend to use the unit for an extended period, remove the AC adapter from the AC outlet.

4. Batteries and Heat Exposure

Warning

Batteries (battery pack or batteries installed) shall not be exposed to excessive heat as sunshine, fire or the like.

5. **Never Touch this Unit with Wet Hands**—Never handle this unit or its power cord while your hands are wet or damp. If water or any other liquid gets inside this unit, have it checked by your Onkyo dealer.
6. **Handling Notes**
 - If you need to transport this unit, use the original packaging to pack it how it was when you originally bought it.
 - Do not leave rubber or plastic items on this unit for a long time, because they may leave marks on the case.
 - This unit's top and rear panels may get warm after prolonged use. This is normal.
 - If you do not use this unit for a long time, it may not work properly the next time you turn it on, so be sure to use it occasionally.

For U.S. models

FCC Statement

Federal Communication Commission Interference Statement

This equipment has been tested and found to comply with the limits for a Class B digital device, pursuant to Part 15 of the FCC Rules. These limits are designed to provide reasonable protection against harmful interference in a residential installation. This equipment generates, uses and can radiate radio frequency energy and, if not installed and used in accordance with the instructions, may cause harmful interference to radio communications. However, there is no guarantee that interference will not occur in a particular installation. If this equipment does cause harmful interference to radio or television reception, which can be determined by turning the equipment off and on, the user is encouraged to try to correct the interference by one or more of the following measures:

- Reorient or relocate the receiving antenna.
- Increase the separation between the equipment and receiver.
- Connect the equipment into an outlet on a circuit different from that to which the receiver is connected.
- Consult the dealer or an experienced radio/TV technician for help.

FCC Caution:

FCC WARNING

Changes or modifications not expressly approved by the party responsible for compliance could void the user's authority to operate the equipment. This device complies with Part 15 of FCC Rules. Operation is subject to the following two conditions: (1) this device may not cause interference, and (2) this device must accept any interference, including interference that may cause undesired operation of this device.

For product available in the USA/Canada market, only channel 1~11 can be operated. Selection of other channels is not possible. This device and its antenna(s) must not be colocated or operation in conjunction with any other antenna or transmitter.

IMPORTANT NOTE:

FCC Radiation Exposure Statement:

This equipment complies with FCC radiation exposure limits set forth for an uncontrolled environment and meets the FCC radio frequency (RF) Exposure Guidelines in Supplement C to OET65. This equipment should be installed and operated keeping the radiator at least 20 cm or more away from person's body (excluding extremities: hands, wrists, feet and ankles).

For Canadian Models

IC Statement

Changes or modifications not expressly approved by the party responsible for compliance could void the user's authority to operate the equipment.

This device complies with Industry Canada licence-exempt RSS standard(s). Operation is subject to the following two conditions: (1) this device may not cause interference, and (2) this device must accept any interference, including interference that may cause undesired operation of the device.

For product available in the USA/Canada market, only channel 1~11 can be operated. Selection of other channels is not possible. This device and its antenna(s) must not be collocated or operation in conjunction with any other antenna or transmitter.

IMPORTANT NOTE:

IC Radiation Exposure Statement:

This equipment complies with IC radiation exposure limits set forth for an uncontrolled environment and meets RSS-102 of the IC radio frequency (RF) Exposure rules. This equipment should be installed and operated keeping the radiator at least 20cm or more away from person's body (excluding extremities: hands, wrists, feet and ankles).

NOTE:

THIS CLASS B DIGITAL APPARATUS COMPLIES WITH CANADIAN ICES-003.

Modèle pour les Canadien

IC Statement

Le présent appareil est conforme aux CNR d'Industrie Canada applicables aux appareils radio exempts de licence.

L'exploitation est autorisée aux deux conditions suivantes :

(1) l'appareil ne doit pas produire de brouillage, et (2) l'utilisateur de l'appareil doit accepter tout brouillage radioélectrique subi, même si le brouillage est susceptible d'en compromettre le fonctionnement.

IMPORTANT NOTE:

IC Radiation Exposure Statement:

Cet équipement est conforme aux limites d'exposition aux rayonnements énoncées pour un environnement non contrôlé et respecte les règles d'exposition aux fréquences radioélectriques (RF) CNR-102 de l'IC. Cet équipement doit être installé et utilisé en gardant une distance de 20 cm ou plus entre le dispositif rayonnant et le corps (à l'exception des extrémités : mains, poignets, pieds et chevilles).

REMARQUE:

CET APPAREIL NUMÉRIQUE DE LA CLASSE B EST CONFORME À LA NORME NMB-003 DU CANADA.

For European Models

Hereby, ONKYO SOUND & VISION CORPORATION, declares that this ABX-N300 is in compliance with the essential requirements and other relevant provisions of Directive 1999/5/EC.

С настоящето, ONKYO SOUND & VISION CORPORATION, декларира, че ABX-N300 е в съответствие със съществените изисквания и другите приложими разпоредби на Директива 1999/5/EC.

ONKYO SOUND & VISION CORPORATION tímto prohlašuje, že ABX-N300 splňuje základní požadavky a všechna příslušná ustanovení Směrnice 1999/5/ES.

Undertegnede ONKYO SOUND & VISION CORPORATION erklærer herved, at følgende udstyr ABX-N300 overholder de væsentlige krav og øvrige relevante krav i direktiv 1999/5/EF.

Hiermit erklärt ONKYO SOUND & VISION CORPORATION, dass sich das Gerät ABX-N300 in Übereinstimmung mit den grundlegenden Anforderungen und den übrigen einschlägigen Bestimmungen der Richtlinie 1999/5/EG befindet.

Käesolevaga kinnitab ONKYO SOUND & VISION CORPORATION seadme ABX-N300 vastavust direktiivi 1999/5/EÜ põhinõuetele ja nimetatud direktiivist tulenevatele teistele asjakohastele sätetele.

ΜΕ ΤΗΝ ΠΑΡΟΥΣΑ Ο ΚΑΤΑΣΚΕΥΑΣΤΗΣ ONKYO SOUND & VISION CORPORATION ΔΗΛΩΝΕΙ ΟΤΙ ΑΒΧ-Ν300 ΣΥΜΜΟΡΦΩΝΕΤΑΙ ΠΡΟΣ ΤΙΣ ΟΥΣΙΩΔΕΙΣ ΑΠΑΙΤΗΣΕΙΣ ΚΑΙ ΤΙΣ ΛΟΙΠΕΣ ΣΧΕΤΙΚΕΣ ΔΙΑΤΑΞΕΙΣ ΤΗΣ ΟΔΗΓΙΑΣ 1999/5/ΕΚ

Por la presente, ONKYO SOUND & VISION CORPORATION, declara que este ABX-N300 cumple con los requisitos esenciales y otras exigencias relevantes de la Directiva 1999/5/EC.

Par la présente, ONKYO SOUND & VISION CORPORATION déclare que l'appareil ABX-N300 est conforme aux exigences essentielles et aux autres dispositions pertinentes de la directive 1999/5/CE.

Con la presente ONKYO SOUND & VISION CORPORATION dichiara che questo ABX-N300 è conforme ai requisiti essenziali ed alle altre disposizioni pertinenti stabilite dalla direttiva 1999/5/CE.

Ar šo ONKYO SOUND & VISION CORPORATION deklarē, ka ABX-N300 atbilst Direktīvas 1999/5/EK būtiskajām prasībām un citiem ar to saistītajiem noteikumiem.

Šiuo ONKYO SOUND & VISION CORPORATION deklaruoja, kad šis ABX-N300 atitinka esminius reikalavimus ir kitas 1999/5/EB Direktyvos nuostatas.

A ONKYO SOUND & VISION CORPORATION ezzennel kijelenti, hogy a ABX-N300 típusú beren-dezés teljesíti az alapvető követelményeket és más 1999/5/EK irányelvben meghatározott vonatkozó rendelkezéseket.

Precautions—Continued

Hierbij verklaart ONKYO SOUND & VISION CORPORATION dat het toestel 1 ABX-N300 in overeenstemming is met de essentiële eisen en de andere relevante bepalingen van richtlijn 1999/5/EG.

Niniejszym ONKYO SOUND & VISION CORPORATION deklaruje że ABX-N300 jest zgodny z zasadniczymi wymaganiami i innymi właściwymi postanowieniami Dyrektywy 1999/5/EC.

Eu, ONKYO SOUND & VISION CORPORATION, declaro que o ABX-N300 cumpre os requisitos essenciais e outras provisões relevantes da Directiva 1999/5/EC.

Prin prezenta, ONKYO SOUND & VISION CORPORATION, declară că aparatul ABX-N300 este în conformitate cu cerințele esențiale și cu alte prevederi pertinente ale Directivei 1999/5/CE.

ONKYO SOUND & VISION CORPORATION tímto vyhlasuje, že ABX-N300 a splňuje základné požiadavky a všetky príslušné ustanovenia Smernice 1999/5/ES.

ONKYO SOUND & VISION CORPORATION izjavlja, da je ta ABX-N300 v skladu z bistvenimi zahtevami in drugimi relevantnimi določili direktive 1999/5/ES.

ONKYO SOUND & VISION CORPORATION vakuuttaa täten että ABX-N300 tyyppinen laite on direktiivin 1999/5/EY oleellisten vaatimusten ja sitä koskevien direktiivin muiden ehtojen mukainen.

Härmed förklarar ONKYO SOUND & VISION CORPORATION att denna ABX-N300 följer de väsentliga kraven och andra relevanta stadgar i Direktiv 1999/5/EC.

Hér með lýsir ONKYO SOUND & VISION CORPORATION því yfir að varan ABX-N300 er í samræmi við grunnkröfur og aðrar kröfur sem gerðar eru í tilskipun 1999/5/EC.

ONKYO SOUND & VISION CORPORATION erklærer herved at denne ABX-N300 er i overensstemmelse med væsentlige krav og andre relevante bestemmelser i direktiv 1999/5/EC.

Declaration of Conformity

We, ONKYO EUROPE
ELECTRONICS GmbH
LIEGNITZERSTRASSE 6,
82194 GROEBENZELL,
GERMANY



declare in own responsibility, that the ONKYO product described in this instruction manual is in compliance with the corresponding technical standards such as EN60950-1, EN55022, EN55024 and EN61000-3-2, -3-3.

GROEBENZELL, GERMANY

A handwritten signature in black ink, appearing to read 'K. Miyagi', is written over a horizontal line.

K. MIYAGI

ONKYO EUROPE ELECTRONICS GmbH

Contents

Important Safety Instructions	2	Setting the Clock (remote controller only)....	23
Precautions.....	3	Setting the Time and Day of the Week	23
Features	7	Displaying the Clock	23
Supplied Accessories.....	7	Using the Timers (remote controller only)....	24
Using the Remote Controller	8	About the Timers.....	24
Replacing the Battery	8	Setting a Timer.....	24
About Your iPod/iPhone	9	Switching the Timer On (active) /	
iPod/iPhone Models that can be Connected... 9		Off (disabled)	25
Caution	9	Using the Snooze Function.....	25
Getting to Know the ABX-N300.....	10	Using the Sleep Timer	25
Top/Front Panel.....	10	Network Setup	26
Rear Panel.....	11	Network Essentials	26
Remote Controller (RC-806S)	12	Connecting via Wireless LAN	27
Connections	13	Connecting via Wired LAN.....	28
Basic Operation.....	14	About Standby Mode	30
Turning On the ABX-N300.....	14	Checking Network Information.....	30
Selecting the Input Source	14	Viewing the "WEB Setup Menu" Window....	31
Adjusting the Volume.....	14	About Internet Radio and Media Servers	32
Muting the ABX-N300		Internet Radio Function.....	32
(remote controller only)	14	Media Server Function.....	32
Changing the Downlight Brightness		Server Requirements.....	32
(remote controller only)	14	Troubleshooting	33
Adjusting the Bass and Treble		Power.....	33
(remote controller only)	15	Audio.....	33
Using Super Bass		iPod/iPhone.....	33
(remote controller only)	15	Network.....	34
Using Headphones	15	Internet Radio	34
Silencing the beep tone during operation		Playing Music Files Saved on a	
(remote controller only)	15	Network Server or Computer	34
Playing Your iPod/iPhone	16	Can't view the ABX-N300's Information	
Navigating the iPod/iPhone Menus	17	in your Web Browser	34
Random Playback		AirPlay.....	34
(remote controller only)	17	Rocketboost™	
Repeat Playback		(North American models only)	35
(remote controller only)	17	Remote Controller.....	35
Using the AirPlay	17	External Components	35
Listening to Internet Radio.....	18	Timers	35
Receiving a Broadcast.....	18	Specifications	36
Playing Music Files on a Server	19		
Setting Up a Network Server.....	19		
Rocketboost™			
(North American models only)	21		
Rocketboost Wireless Card Ready.....	21		
What is Rocketboost?.....	21		
Typical Rocketboost Applications.....	21		
Rocketboost Setup	22		

Features

- iPod/iPhone* dock digital connection
- AirPlay
- Media server capability
- Internet radio support
- iPod/iPhone charging capability
- Control your iPod/iPhone with the remote controller
- Bass and treble tone controls
- Super Bass (S.Bass) function for deeper bass sounds
- Line input for external audio source
- Downlight with adjustable dimmer
- 2 programmable timers
- Sleep timer
- Snooze function
- Rocketboost™ Expandable Wireless Audio Technology receives wireless audio from Rocketboost devices (Requires Rocketboost Wireless Card, WLC-TR1, sold separately) (North American models only)

Supplied Accessories

Make sure you have the following accessories:

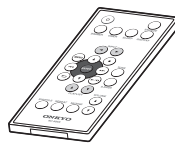

Remote controller (RC-806S) and battery (CR2025)

The lithium button battery (CR2025) is already installed in the remote control when you purchase the ABX-N300.

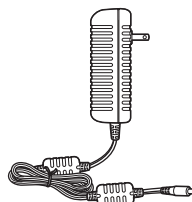

AC adapter (DC output 16V 3A)

(Adapter varies from country to country.)

Note:

Use only the AC adapter included with the ABX-N300. Using any other AC adapter may damage the ABX-N300. The included AC adapter is only for use with the ABX-N300. It cannot be connected to other devices and used.



* AirPlay, the AirPlay logo, iPad, iPhone, iPod, iPod classic, iPod nano, iPod shuffle, and iPod touch are trademarks of Apple Inc., registered in the U.S. and other countries.

“Made for iPod” and “Made for iPhone” mean that an electronic accessory has been designed to connect specifically to iPod or iPhone, respectively, and has been certified by the developer to meet Apple performance standards.

Apple is not responsible for the operation of this device or its compliance with safety and regulatory standards.

Please note that the use of this accessory with iPod or iPhone may affect wireless performance.

Windows and Windows Media Player are trademarks of Microsoft Corporation registered in the USA and in other countries.

In catalogs and on packaging, the letter at the end of the product name indicates the color. Specifications and operation are the same regardless of color.

Using the Remote Controller

Remove the plastic film before using the remote controller.

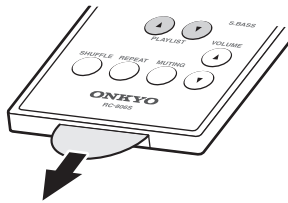

When using the remote controller, point it toward the ABX-N300's remote control sensor, as shown below.

Remote control sensor

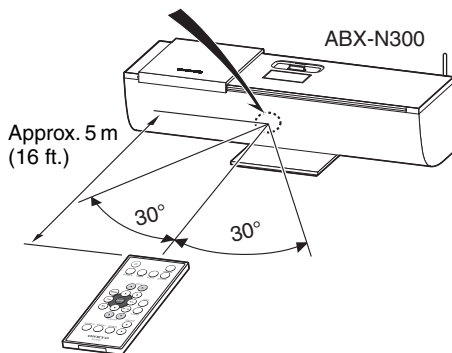

Notes:

- The remote controller may not work reliably if the ABX-N300 is subjected to bright light, such as direct sunlight or inverter-type fluorescent lights. Keep this in mind when installing.
- If another remote controller of the same type is used in the same room, or the ABX-N300 is installed close to equipment that uses infrared rays, the remote controller may not work reliably.
- Don't put anything, such as a book, on the remote controller because the buttons may be pressed inadvertently, thereby draining the batteries.
- The remote controller may not work reliably if the ABX-N300 is installed in a rack behind colored glass doors. Keep this in mind when installing.
- The remote controller will not work if there's an obstacle between it and ABX-N300's remote control sensor.

Replacing the Battery

- 1** While sliding the stopper to the side, pull out the battery holder.

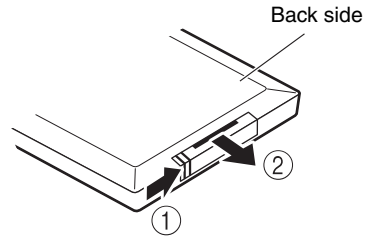

- 2** Insert a lithium button battery in the battery holder, and then replace the holder.

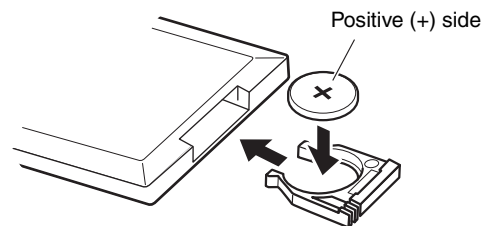

When replacing the battery

When you replace the battery, be sure to use the specified type of battery.

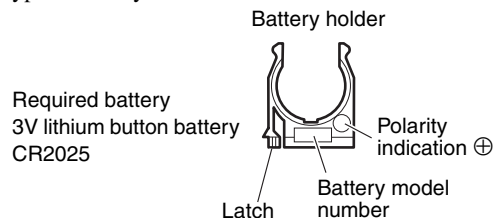

Notes:

- If the remote controller doesn't work reliably, try replacing the battery.
- If you intend not to use the remote controller for a long time, remove the battery to prevent damage from leakage or corrosion.
- Expired batteries should be removed as soon as possible to prevent damage from leakage or corrosion.
- Make sure that the battery is oriented in the correct polarity (observe the "+" and "-" indication).
- Never use a battery of a different model number.
- If not handled correctly, a lithium battery may ignite or chemically cause skin irritation. Keep lithium batteries out of the reach of children. Do not disassemble, recharge, or incinerate a lithium battery, and do not allow it to reach a temperature exceeding 100 °C (212 °F). When replacing the battery, use only the specified type of battery. If you use the wrong battery, you risk causing fire or explosion.

About Your iPod/iPhone

iPod/iPhone Models that can be Connected

Compatible iPod/iPhone models

Made for:

- iPod touch (1st, 2nd, 3rd and 4th generation)
- iPod classic
- iPod nano (2nd, 3rd, 4th, 5th and 6th generation)
- iPhone 4, iPhone 3GS, iPhone 3G, iPhone

Note:

Before you begin using it, please update your iPod/iPhone to the latest version. For details, refer to the Apple website.

■ About the Dock Adapter

The ABX-N300's dock uses the Universal Dock system. By attaching an interchangeable part called a dock adapter, you'll be able to insert your model of supported iPod/iPhone.

- Use a commercially available dock adapter or the one that was included with your iPod/iPhone.
- If your iPod is a compact and lightweight model, and has no compatible adapter, you may connect it directly.

Move the slide cover to the left to expose the dock.

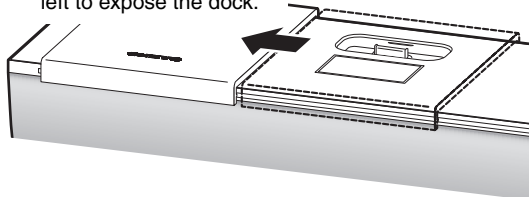

Dock adapter

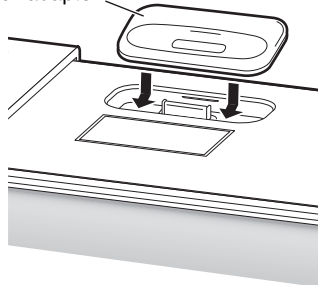

First align the front edge of the dock adapter, and then press down on the rear edge.

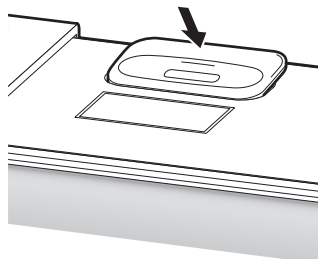

■ Removing the Dock Adapter

As shown in the illustration below, insert a slotted screwdriver or similar object into the slit of the dock adapter, and lift the adapter up.

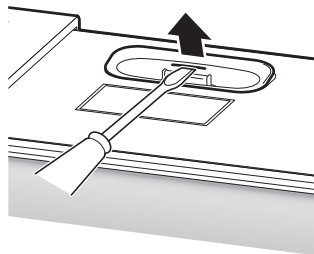

Caution

- If you connect an iPod/iPhone to the ABX-N300 without attaching a dock adapter, you risk straining and damaging the connector. Even if the dock adapter is connected, you should avoid straining the connector by moving or wiggling the connected iPod/iPhone.
- When inserting or removing your iPod/iPhone, take care to insert or remove it in a straight line with the angle of the connector, and do not use excessive force.
- Do not forcefully press the controls of your iPod/iPhone while it is connected to the ABX-N300, or wiggle your iPod/iPhone forward or backward. Doing so will cause damage or faulty contacts in the connector.
- Do not use the system in conjunction with other accessories such as an FM transmitter or microphone. Doing so may cause faulty operation.
- If your iPod/iPhone is in a case, it might not be able to fully connect with the connector, causing failure to sound or inability to operate the remote control. Remove your iPod/iPhone from its case before inserting it in the ABX-N300.

Getting to Know the ABX-N300

Top/Front Panel

The page numbers in parentheses show where you can find the main explanation for each item.

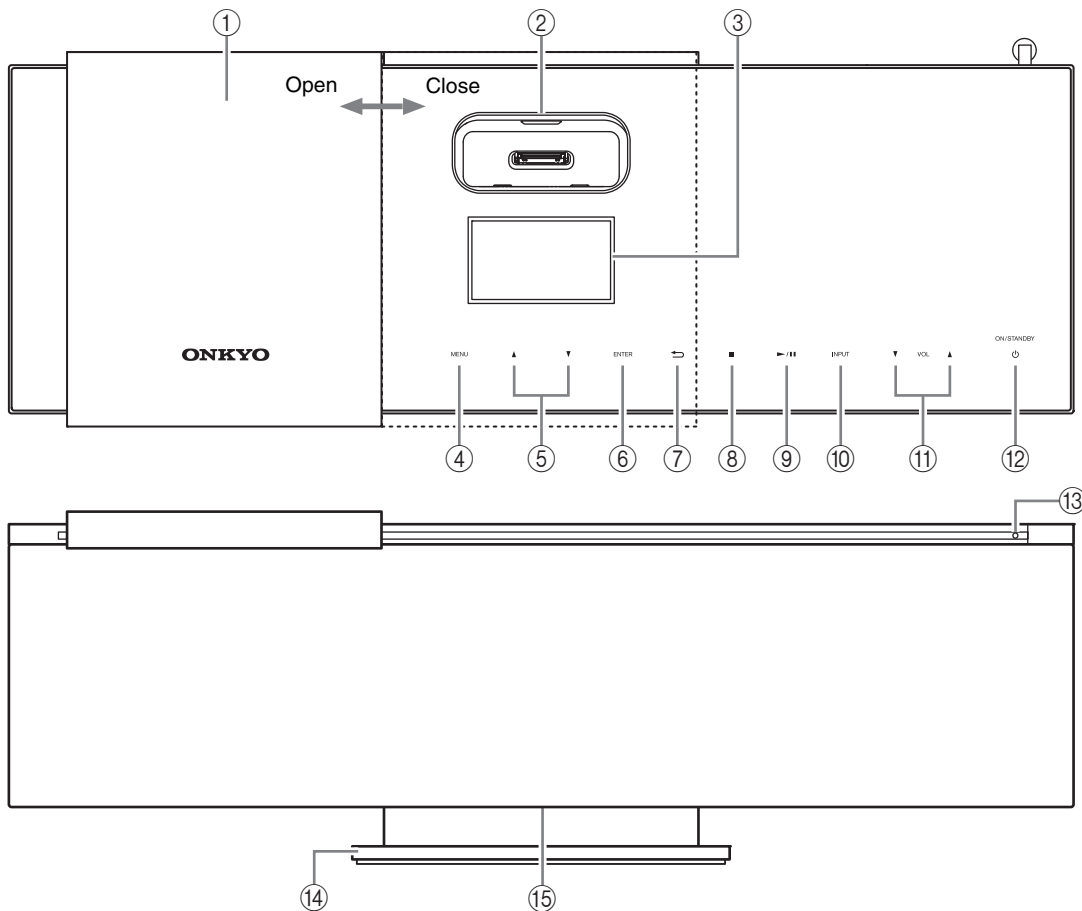

- ① **Slide cover**
Close the slide cover when transporting the ABX-N300 or when not using the dock.
- ② **iPod/iPhone dock (9, 16)**
Insert your iPod/iPhone here.
- ③ **Display**
- ④ **MENU button (17, 19)**
This button displays the menu, or returns to the previous screen.
- ⑤ **[▲]/[▼] buttons (17, 18, 20)**
When the menu is displayed, use these buttons to select a menu item.
- ⑥ **ENTER button (17– 20)**
Press this button to confirm a setting you've made in a menu, etc.
- ⑦ **[←] button (19)**
This button takes you back to the previous menu.
- ⑧ **[■] button (20)**
This button stops playback.
- ⑨ **[▶/||] button (16, 20, 22)**
This button starts playback on the iPod/iPhone. Pressing this during playback will pause the playback.
- ⑩ **INPUT button (14, 17, 18, 20, 22)**
This button selects the source that will be heard.
- ⑪ **VOL [▼]/[▲] buttons (14)**
These buttons adjust the volume.
- ⑫ **ON/STANDBY [⏻] button (14, 22)**
This button switches the power between on/standby.
- ⑬ **Network standby indicator (30)**
If the standby mode is set to "Network," this indicator will light orange when the ABX-N300 is in standby mode.
- ⑭ **Stand**
- ⑮ **Downlike (14)**
This will be lit when the power is on, and unlit in standby mode.

Rear Panel

The page numbers in parentheses show where you can find the main explanation for each item.

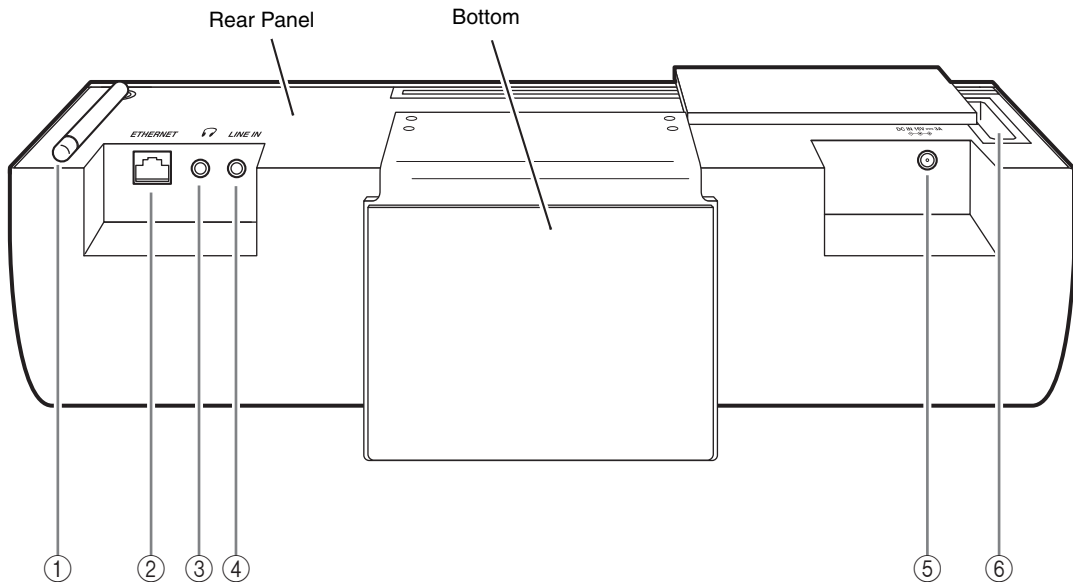

- ① **Wireless LAN antenna (13, 27)**
Unfold this antenna if you're connecting to the network wirelessly.
- ② **ETHERNET port (13, 28)**
Connect your Ethernet cable here if you're connecting to the network via a cable.
- ③ **[🎧] Headphones jack (13, 15)**
You can connect the stereo mini-plug of your headphones here.
- ④ **LINE IN jack (13)**
Use a commercially available stereo mini-plug audio cable to connect an external device's audio output to this jack. This allows the ABX-N300 to play back audio from a device such as a portable audio player, game device, television, or record player with built-in phono equalizer.
- ⑤ **AC adapter jack (DC IN 16V 3A) (13)**
Connect the included AC adapter here.
- ⑥ **Rocketboost™ Module Slot (North American models only) (22)**
Insert Rocketboost Wireless Card here if you're using the Rocketboost wireless digital audio.

About Installation

The ABX-N300 features a speaker bass reflex duct on each side panel. Allow a space of 20 cm or more on each side to avoid blocking the bass sound.

Remote Controller (RC-806S)

The page numbers in parentheses show where you can find the main explanation for each item.

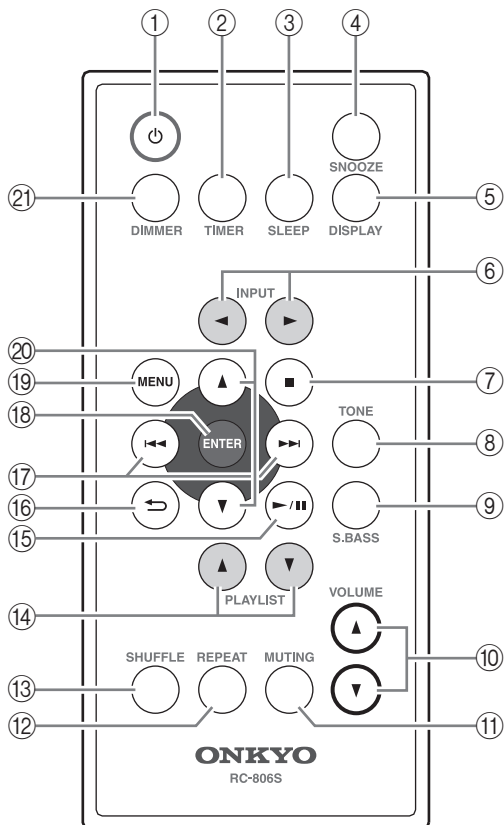

- ① **[⏻] (on/standby) button (14, 22, 23, 24, 27, 28)**
This button switches the power between on/standby.
- ② **TIMER button (23–25)**
This button lets you set the clock and timer.
- ③ **SLEEP button (25)**
This button is used to set the sleep timer.
- ④ **SNOOZE button (25)**
Press this button to use the snooze function (temporarily stopping timer playback).
- ⑤ **DISPLAY button (20, 23)**
The information (album title, artist name) shown in the display will change each time you press this button. If you press this button when the ABX-N300 is in standby mode, the clock will be displayed for eight seconds.
- ⑥ **INPUT [◀]/[▶] button (14, 17, 18, 20, 22)**
This button selects the source that will be heard.
- ⑦ **[■] button (20)**
This button stops playback.

- ⑧ **TONE button (15)**
Press this button when you want to adjust the bass (low range) or treble (high range).
- ⑨ **S.BASS (Super Bass) button (15)**
This button lets you make Super Bass settings.
- ⑩ **VOLUME [▲]/[▼] buttons (14)**
These buttons adjust the volume.
- ⑪ **MUTING button (14)**
This button temporarily silences the sound.
- ⑫ **REPEAT button (17)**
During iPod/iPhone playback, this button makes the songs play repeatedly.
- ⑬ **SHUFFLE button (17)**
During iPod/iPhone playback, this button makes the song play randomly.
- ⑭ **PLAYLIST [▲]/[▼] buttons**
These buttons are not used.
- ⑮ **[▶/||] button (16, 17, 20, 22)**
This button starts playback. During playback, you can press this button to pause.
- ⑯ **[↶] button (19, 23, 25, 28, 30)**
This button takes you back to the previous menu.
- ⑰ **[◀◀]/[▶▶] buttons (16, 20, 25, 28, 29)**
These buttons select the previous or next song.
- ⑱ **ENTER button (15, 17–20, 23–25, 27–31, 33)**
Press this button to confirm a setting you've made in a menu, etc.
- ⑲ **MENU button (15, 17, 19, 27, 29–31, 33)**
This button displays the menu, or returns to the previous screen.
- ⑳ **[▲]/[▼] buttons (15, 17, 18, 20, 23–25, 27–31, 33)**
When the menu is displayed, use these buttons to select a menu item.
- ㉑ **DIMMER button (14)**
This button switches the brightness of the downlight.

Basic Operation

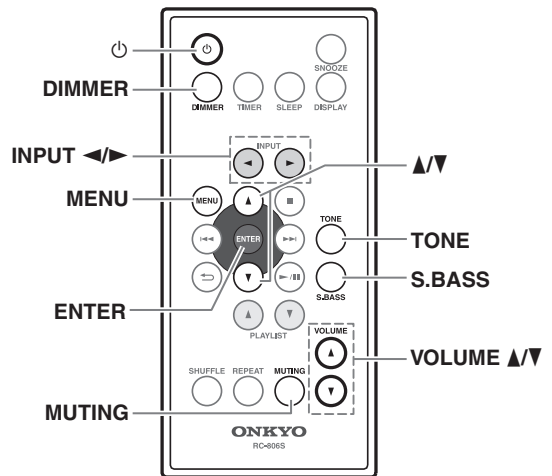
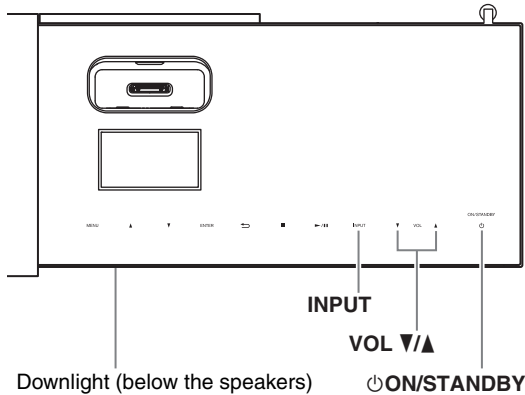

Buttons on the top panel can be operated via the touch screen.

Turning On the ABX-N300

To turn on the ABX-N300, press the [⏻] button on the ABX-N300 or remote controller.

The power will turn on, and the downlight located in the lower part of the ABX-N300 will illuminate.

Press the [⏻] button again to set the ABX-N300 to standby.

Selecting the Input Source

Press the ABX-N300's [INPUT] button or the remote controller's INPUT [◀]/[▶] button to switch the input source for playback.

You can choose from iPod, Rocketboost™ (North American models only), LINE (the connected external device), Internet Radio, Media Server, or AirPlay. Each time you press the [INPUT] button, the input will cycle through the following choices.

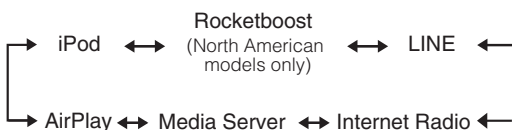

Adjusting the Volume

Press the VOL [▲] button to increase the volume or the VOL [▼] button to decrease it.

You can also use the remote controller's VOLUME [▲]/[▼] buttons.

You can adjust the volume in the range of "0" – "39," and "Max."

Muting the ABX-N300 (remote controller only)

To mute the ABX-N300, press the remote controller's [MUTING] button.

"Muting" will appear on the display.

To unmute the ABX-N300, press the [MUTING] button again.

Muting will also be disabled in the following cases.

- When you adjust the volume
- When you enter standby mode, and then turn the power on again

Changing the Downlight Brightness (remote controller only)

You can adjust the brightness of the downlight.

Press the remote controller's [DIMMER] button.

Each time you press the button, the brightness will cycle through the following settings.



Adjusting the Bass and Treble (remote controller only)

Note:

Tone adjustments (Bass, Treble, S.Bass) do not affect the headphones.

1 Press the [TONE] button to make the display indicate “Tone Control.”

The value of the Bass setting will blink.

2 Use the [▲]/[▼] buttons to adjust the value.

You can adjust the value in the range of -3 to +3.

Note:

If you press no buttons for eight seconds, the previous display will appear automatically.

3 Press the [ENTER] button.

The value of the Treble setting will blink.

4 Use the [▲]/[▼] buttons to adjust the value.

You can adjust the value in the range of -3 to +3.

Note:

If you press no buttons for eight seconds, the previous display will appear automatically.

5 Press the [ENTER] button.

The original display will reappear.

Using Super Bass (remote controller only)

To turn on Super Bass, press the [S.BASS] button.

The “S.BASS” indication will appear on the display.

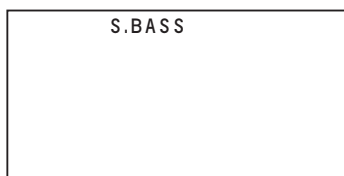

The strength of the ultra-low range will change each time you press the [S.BASS] button.

The “S.BASS” indication will disappear when this setting is off.

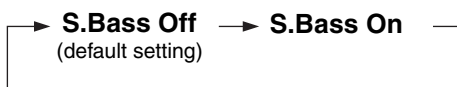

Using Headphones

You can connect a pair of stereo headphones (ø3.5 mm, 1/8-inch phone plug) to the ABX-N300's headphones [🎧] jack (see page 11) for private listening.

Notes:

- Always turn down the volume before connecting your headphones.
- If headphones are connected, no beep will be heard when you operate the touch screen of the ABX-N300.
- While the headphones plug is inserted in the headphones [🎧] jack, the speakers are turned off.
- If the input is set to iPod or Rocketboost™ (North American models only), no sound will be output from the headphones. Disconnect the headphones and listen via the speakers.

Silencing the beep tone during operation (remote controller only)

You can silence the beep tone that is heard when you operate the touch screen of the ABX-N300.

1 While the ABX-N300 is in standby mode, press the remote controller's [MENU] button.

2 Use the [▲]/[▼] buttons to select “Beep,” and press the [ENTER] button.

3 Use the [▲]/[▼] buttons to select “Off,” and press the [ENTER] button.

Tip:

If you want to re-enable the beep tone, choose “On” in step **3** of the procedure above.

Playing Your iPod/iPhone

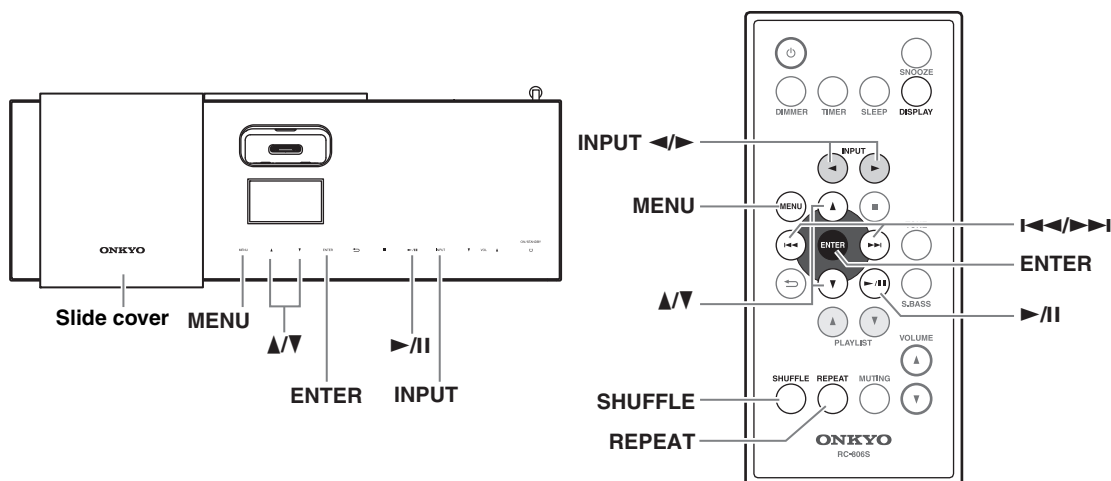

Notes:

- Before using your iPod/iPhone with the ABX-N300, be sure to update your iPod/iPhone with the latest software, available from the Apple website.
- If you leave your iPod/iPhone paused when using it on its own, eventually it will go into hibernation. If you insert it into the ABX-N300 dock in this state, you'll need to wait a few moments before your iPod/iPhone is ready for use.
- Always remove your iPod/iPhone before moving the ABX-N300.
- Depending on your iPod/iPhone, or the type of content being played, some functions may not work as expected.

1 Move the slide cover to the left.

2 Power-on the ABX-N300, and select "iPod" as the input source.

3 Insert your iPod or iPhone into the iPod/iPhone dock.

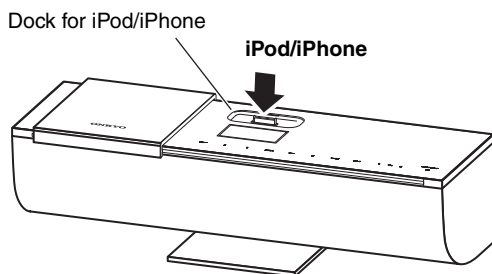

Insert your iPod/iPhone securely into the ABX-N300's dock.
If you use a dock adapter, refer to page 9.

Notes:

- To prevent damage to the dock connector, do not twist or force your iPod/iPhone into the dock, and be careful not to wiggle your iPod/iPhone while inserting it.
- If you use a case with your iPod/iPhone, always remove it before you insert it. Otherwise, it may not connect properly and a malfunction may occur.
- Do not close the slide cover while an iPod/iPhone is inserted. We recommend that you leave the slide cover closed when not using the ABX-N300.
- Do not use with any iPod/iPhone accessories, such as FM transmitters and microphones, as they may cause a malfunction.

4 Press the [▶/||] button. Playback will start.

Pausing Playback

To pause playback, press the [▶/||] button.

Press the button once again to resume playback from where you paused.

Selecting Songs (remote controller only)

To return to the beginning of the track that's currently playing or paused, press the [◀◀] button.

Press the [◀◀] button repeatedly to select earlier songs.

Press the [▶▶] button repeatedly to select subsequent songs.

Fast Forward and Fast Reverse (remote controller only)

To fast forward or fast reverse during playback or while playback is paused, press and hold down the [▶▶] or [◀◀] button, respectively.

Navigating the iPod/iPhone Menus

- 1 Press the [MENU] button on the ABX-N300 or the remote controller to display the menu/list on the iPod/iPhone.
- 2 Use the [▲]/[▼] buttons to select an item on the menu, and then press [ENTER].

Random Playback (remote controller only)

With random playback, the songs on the iPod/iPhone are played in random order.

- 1 Press the [SHUFFLE] button.
The \times symbol will appear in the screen of the iPod/iPhone.
- 2 To start random playback, press the [▶/||] button.
Random playback will start.

Cancelling Random Playback

To cancel random playback, press the [SHUFFLE] button.

The \times symbol will disappear from the screen of the iPod/iPhone.

Repeat Playback (remote controller only)

If you press the [REPEAT] button, the song on the iPod/iPhone will play repeatedly. The type of repeat playback will change as follows each time you press the [REPEAT] button.

- 🔄 : Repeat one song
- 🔄 : Repeat all songs

Cancelling Repeat Playback

Press the [REPEAT] button several times until the 🔄 or 🔄 symbol disappears from the screen of the iPod/iPhone.

Using the AirPlay

With this unit, you can enjoy the music of iOS-based devices or iTunes music library using Apple Inc.'s AirPlay.

Note:

To use AirPlay, you'll need one of the following equipments.

- iPod touch, iPhone, iPad with iOS 4.2 or greater
- A personal computer with iTunes 10 (or greater) installed

Tips:

- Before you use this feature, you must update your iPod touch/iPhone/iPad to the latest version.
- For optimal performance, we recommend you always use the latest version of iOS and iTunes.
- For details on AirPlay or how to obtain the latest version for your software, please visit Apple web site.



AirPlay, the AirPlay logo, iPad, iPhone, iPod, iPod classic, iPod nano, iPod shuffle, and iPod touch are trademarks of Apple Inc., registered in the U.S. and other countries.

Caution

In order to using the AirPlay, the ABX-N300 must be connected to a network. For details on connecting to a network, refer to "Network Setup" (see page 26).

Playback

Follow the procedure below to play back.

- 1 Select "AirPlay" as the input.
Use the ABX-N300's [INPUT] button or the remote controller's INPUT [◀]/[▶] buttons to select "AirPlay."
- 2 From the AirPlay icon [📺] of iTunes or your iPod touch/iPhone/iPad, select "Onkyo ABX-N300 *****" (default setting).
- 3 Start playback in iTunes or on your iPod touch/iPhone/iPad.

Notes:

- If there's no sound via AirPlay, temporarily select something other than the ABX-N300 from [📺], wait for a while, and then select the ABX-N300 once again.
- Elapsed time or other indicators may not be displayed correctly.

Listening to Internet Radio

The ABX-N300 supports vTuner Internet Radio.

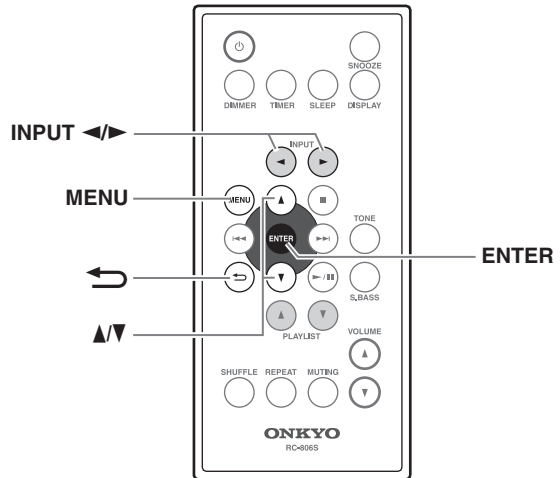
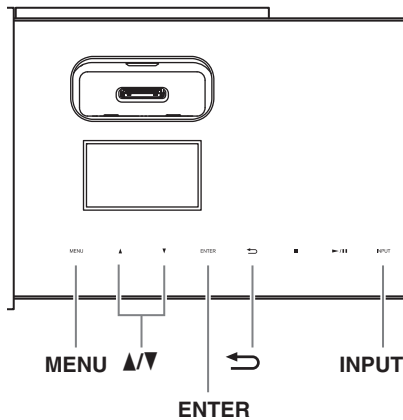

Caution

In order to listen to Internet radio, the ABX-N300 must be connected to a network. For details on connecting to a network, refer to “Network Setup” (see page 26).

Receiving a Broadcast

1 Select “Internet Radio” as the input.

Use the ABX-N300’s [INPUT] button or the remote controller’s INPUT [◀]/[▶] buttons to select “Internet Radio.”

A list of Internet radio stations will be automatically loaded from the vTuner radio station database service.



2 Use the [▲]/[▼] buttons to select “Stations By Location,” and press the [ENTER] button.

“Stations By Location” is merely an example. You are free to select any item.

3 Use the [▲]/[▼] buttons to select “Europe,” and press the [ENTER] button.

“Europe” is merely an example. You are free to select any region you like, not just “Europe.”

4 Use the [▲]/[▼] buttons to select “United Kingdom,” and press the [ENTER] button.

“United Kingdom” is merely an example. You are free to select any country you like, not just “United Kingdom.”



5 Use the [▲]/[▼] buttons to select the genre that you want to hear, and press the [ENTER] button.

If you don’t want to choose a genre, leave “All Stations” selected and simply press the [ENTER] button.

6 Use the [▲]/[▼] buttons to select a station, and press the [ENTER] button.

The ABX-N300 will automatically connect to the station, data will be loaded, and playback will begin.



Tips:

- The “+” shown at the left edge indicates a folder. By pressing the [ENTER] button at the “+” indication, you can move to the level below. The “>” indicates a broadcast station. When you press the [ENTER] button at the “>” indication, playback will begin.
- By pressing the [MENU] button, you can return to step **1** and select a station.
- By pressing the [↶] button, you can return to the previous step and re-select the station.
- “Recent Launches” contains the stations that you recently listened to.

Caution

Internet radio cannot be paused.

Using “Favorites” and “My Added Stations” of vTuner Internet Radio

You can save your favorite radio stations in vTuner’s “Favorites” and “My Added Stations.”

1 Make a note of the ABX-N300’s MAC Address (see page 30).

2 Turn on the power of the ABX-N300, and switch the input to “Internet Radio.”

The vTuner menu “+ Favorites” will appear. If this menu does not appear, check the network connections and settings.

3 Use your computer’s browser to access <http://onkyo.vtuner.com/>.

4 Sign in with the ABX-N300’s MAC Address as the ID#.

Enter only the 12 alphanumeric digits, omitting any “-” (hyphen).

As directed in the screen, register “Favorites” or “My Added Stations.”

The stations you registered will be available in “Favorites” or “My Added Stations” in the ABX-N300’s vTuner menu.

Playing Music Files on a Server

This section explains how to play music files on a computer or media server through the ABX-N300 (Server Playback).

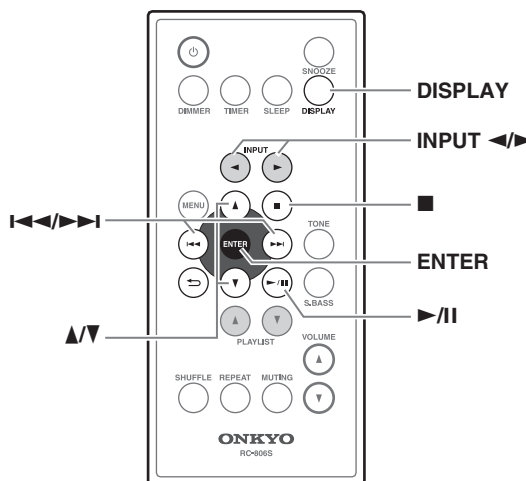
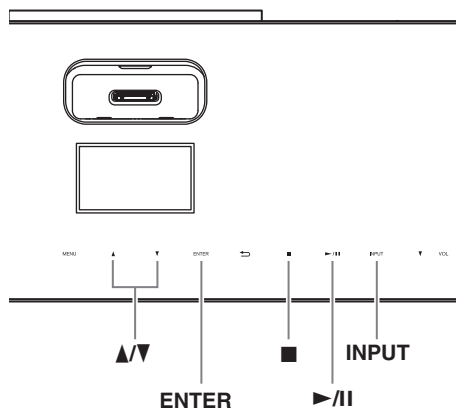

Caution

The ABX-N300 must be connected to a network. For details on connecting to a network, refer to “Network Setup” (see page 26).

Setting Up a Network Server

This section explains how to configure Windows Media® Player 11/12 so that the ABX-N300 can play the music files stored on your computer.

Windows Media® Player 11 Setup

- 1 Start Windows Media® Player 11.**
 - 2 On the “Library” menu, select “Media Sharing.”**

The “Media Sharing” dialog box will appear.
 - 3 Select the “Share my media” check box, and then click “OK.”**
 - 4 Select the ABX-N300 in the list, and then click “Allow.”**
 - 5 Click “OK” to close the dialog box.**

This completes the Windows Media® Player 11 configuration.

You can now play the music files in your Windows Media® Player 11 library through the ABX-N300.

Windows Media® Player 11 can be downloaded for free from the Microsoft web site.
-

Windows Media® Player 12 Setup

- 1 Start Windows Media® Player 12.**
 - 2 On the “Stream” menu, select “Turn on media streaming.”**

A dialog box will appear.
 - 3 Move your cursor and click on “Turn on media streaming.”**

A list of media server will appear. Wording may vary slightly depending on the network location.
 - 4 Select the ABX-N300 in the list, and then click “Allowed.”**
 - 5 Click “OK” to close the dialog box.**

This completes the Windows Media® Player 12 configuration.

You can now play the music files in your Windows Media® Player 12 library.
-

Playing Music Files

- 1 Start your computer or media server.**
 - 2 Start up the ABX-N300, and set the input to “Media Server.”**

Press the ABX-N300’s [INPUT] button or use the remote controls INPUT [◀]/[▶] buttons to select “Media Server.”

A list of network servers will appear.
 - 3 Use the [▲]/[▼] buttons to select the network server that you want to use, and then press the [ENTER] button.**

Notes:

 - The ABX-N300 cannot access photos or videos on a network server.
 - Some content might not be displayed depending on the sharing settings of the network server. Refer to the owner’s manual of the network server.
 - 4 Use the [▲]/[▼] buttons to select the music file that you want to hear, and press the [ENTER] button.**
-

Playback will start.

Tips:

- The “+” mark shown at the left edge indicates a folder. By pressing the [ENTER] button at the “+” mark, you can move to the lower level. The “>” mark indicates a file. When you press the [ENTER] button at the “>” mark, playback will begin.
 - Press the [MENU] button to resume from Step 2.
 - By pressing the [↶] button, you can return to the previous step and again select a file.
-

Pausing Playback

To pause playback, press the [▶/II] button.

Press the [▶/II] button again to resume playback from the pause point.

Stopping Playback

To stop playback, press the [■] button.

Switching to the previous or next song

To switch songs, use the remote controller’s [◀◀] or [▶▶] buttons.

Switching the information display

Press the remote controller’s [DISPLAY] button repeatedly to toggle the information display between album title and artist name.

Rocketboost™ (North American models only)

The ABX-N300 can play back music from another Rocketboost device (Sender).

Rocketboost Wireless Card Ready

Installing a Rocketboost Wireless Card (sold separately) enables this product to receive wireless audio from your other Rocketboost products.



What is Rocketboost?

Rocketboost is expandable wireless digital audio.

- Products with Rocketboost technology let you easily expand your listening experience throughout your home.
- Rocketboost does not interfere with other wireless products in your home.
- Rocketboost is uncompressed digital audio compatible with all audio formats.

When you see the Rocketboost logo on any product, it has been designed to work with other Rocketboost products, no matter who manufactures them.

How Can I Use Rocketboost with the ABX-N300?

A Rocketboost Wireless Card (WLC-TR1, sold separately) can be used to receive any Rocketboost audio stream from your other Rocketboost products. For example, you can play music from audio sources that are in other rooms.

You can learn more about Rocketboost products at www.rocketboost.com.

Typical Rocketboost Applications

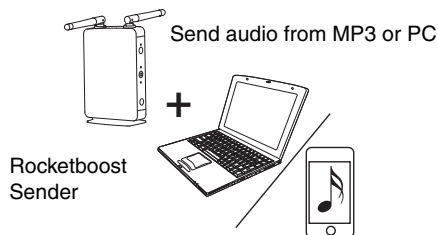

ABX-N300 with WLC-TR1

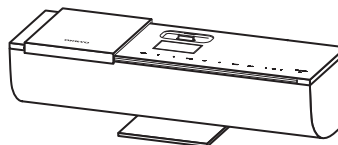

+

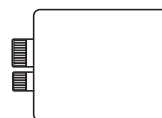

Rocketboost Wireless Card (WLC-TR1, sold separately)

Rocketboost Setup

Initial Rocketboost Setup

Insert the WLC-TR1 into the Rocketboost Module Slot on the back of the ABX-N300.

Note:

The ABX-N300 must be in standby mode when you attach the Rocketboost Wireless Card (WLC-TR1, sold separately). If the ABX-N300 is powered-on, press the [⏻] button to put it in standby mode.

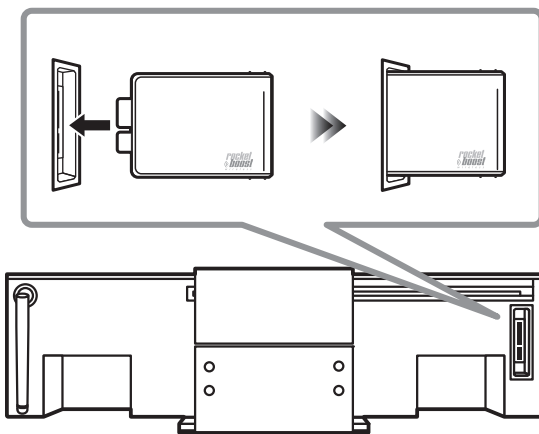

Pairing

Rocketboost products form an audio network. Every Rocketboost network must contain one hub device, which helps devices join the network. To add the ABX-N300 to your Rocketboost network, you need to pair it with your hub device.

1 Insert the Rocketboost Wireless Card (WLC-TR1, sold separately) to the ABX-N300.

Take care that the connector is oriented correctly, and insert it all the way.

2 Power-on the ABX-N300, and set the input to “Rocketboost.”

Use the ABX-N300’s [INPUT] button or the remote controller’s INPUT [◀/▶] buttons to select “Rocketboost.”

3 Refer to the owner’s manual for your hub device for the relevant pairing information, then pair the ABX-N300 with the hub device.

4 Hold down the [⏻] button on the ABX-N300 until the Status indicator of the Rocketboost Wireless Card (WLC-TR1, sold separately) is lit.

While pairing is occurring, the display will indicate “Pairing” and the Status indicator will blink.

Reception will begin when the Status indicator has changed from blinking to steadily lit, and pairing has been completed.

When pairing is complete, the ABX-N300 is now part of your Rocketboost wireless network and it can receive audio from other Rocketboost sender devices. The Rocketboost network can include a total of nine devices (any combination of sender and receiver devices). The maximum number of wireless audio stream being sent over the network at the same time is five.

5 Turn on the audio source connected to the Rocketboost wireless sender.

Make sure the volume of the audio source is turned up and not muted, otherwise no audio will be sent over the Rocketboost network. You can also adjust the volume level at the ABX-N300.

Tips:

If you have multiple audio sources in your Rocketboost network, press the [▶/||] button to hear the next audio source. Press the [▶/||] button again to cycle through all available audio sources.

Setting the Clock (remote controller only)

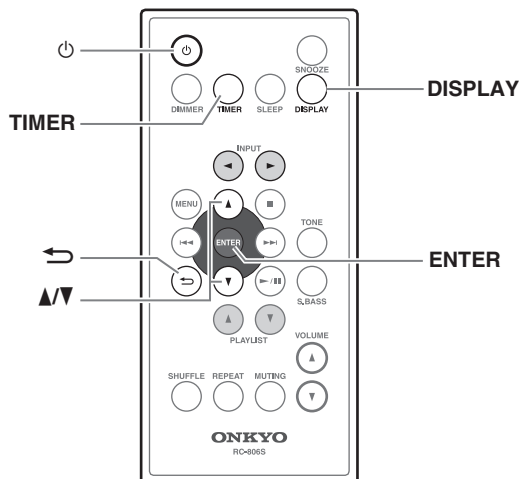

Setting the Time and Day of the Week

- 1** While the ABX-N300 is in standby mode, press the [TIMER] button.

If the ABX-N300 is powered-on, press the [⏻] button to enter standby mode.

- 2** Use the [▲]/[▼] buttons to select “Clock Setup.”

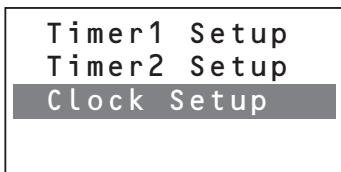

- 3** Press the [ENTER] button.

- 4** Use the [▲]/[▼] buttons to set the time, and press the [ENTER] button.

If you hold down the [▲]/[▼] buttons, the value will change continuously.

To switch between 12-hour and 24-hour display, press the [DISPLAY] button.

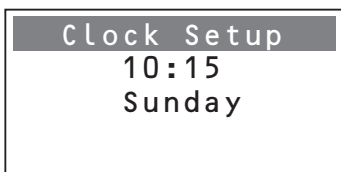

- 5** Use the [▲]/[▼] buttons to set the “day of the week.”

- 6** Press the [ENTER] button.

The setting will be completed, and then the display will return to the standby condition.

Cancelling without setting the time

Press the [TIMER] button.

Returning to the previous screen

Press the [↶] button.

Caution

If the power supply is interrupted by a power failure or by disconnecting the AC adapter, “--:--” will be displayed, and the clock will stop. If this occurs, set the clock again.

Displaying the Clock

If you press the [DISPLAY] button while in standby mode, the clock and day of the week will be shown for approximately eight seconds.

Using the Timers (remote controller only)

The ABX-N300 provides three different timers: two program timers that can automatically play your iPod/iPhone at the specified time, and a sleep timer that can put the unit in standby mode after the specified duration has elapsed.

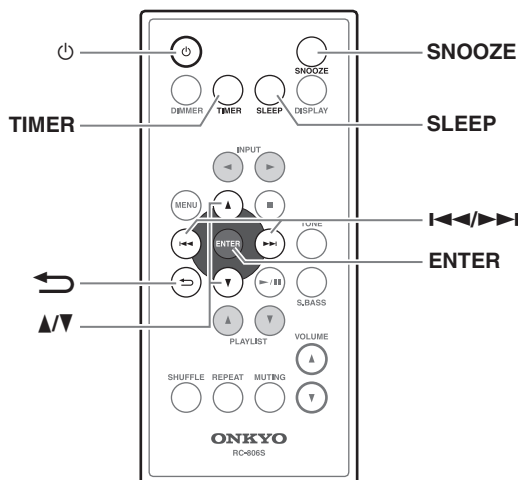

About the Timers

Selecting the timer number

You can set up to two timers.

Setting the time

You can set the timer-on time and timer-off time.

Specifying the day of the week

You can choose “Everyday” to make the timer operate each day, or choose “Every” and specify the days of the week on which the timer will operate.

Setting the playback volume

You can specify the volume for timer playback.

Setting a Timer

Caution

- If the operating time of the two timers overlaps, the timer that would have turned on later will not operate. Please leave at least one minute between the off-time of the first timer and the on-time of the second timer.
- If you’ve set the sleep timer within the time that a timer had turned the power on, the power will operate according to the sleep timer.
- Insert your iPod/iPhone into the iPod dock, and prepare it for playback.

- 1** While the ABX-N300 is in standby mode, press the [TIMER] button.

If the ABX-N300 is powered-on, press the [⏻] button to enter standby mode.

```
Timer1 Setup
Timer2 Setup
Clock Setup
```

- 2** Use the [▲]/[▼] buttons to select “Timer1 Setup” or “Timer2 Setup,” and press the [ENTER] button.

```
Timer1 Setup
Timer1 On
On 6:30
Off 7:00
```

- 3** Use the [▲]/[▼] buttons to select “Timer1 On” or “Timer2 On,” and press the [ENTER] button.

- 4** Use the [▲]/[▼] buttons to set the timer-on time, and press the [ENTER] button.

- 5** Use the [▲]/[▼] buttons to set the timer-off time and press the [ENTER] button.

- 6** Use the [▲]/[▼] buttons to select “Everyday” or “Every,” and press the [ENTER] button.

If you selected “Everyday,” proceed to step **8**.



- 7** If you selected “Every,” use the [◀◀]/[▶▶] buttons to move to the day of the week that you don’t want the timer to operate, and use the [▲]/[▼] buttons to make an underline character appear. When you’ve finished making the desired setting for each day of the week, press the [ENTER] button.

The timer will not operate on days of the week that are shown as an underline character. If you want the timer to operate on a certain day of the week, use the [▲]/[▼] buttons to change the underline character back to the weekday indication.

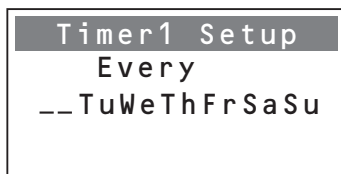

- 8** Use the [▲]/[▼] buttons to specify the playback volume, and press the [ENTER] button.

The timer indication and number will appear in the upper right of the clock display; then after a time, the ABX-N300 will switch to standby mode.

Caution

In order for the timer to operate, the ABX-N300 must be in standby mode.

Cancelling without setting the timer

Press the [TIMER] button. You’ll return to standby mode.

Returning to the previous screen

Press the [↶] button.

Checking the timer setting

Press the [TIMER] button, then select “Timer1 Setup” or “Timer2 Setup” and press the [ENTER] button repeatedly to check the settings.

Switching the Timer On (active) / Off (disabled)

- 1** Press the [TIMER] button.
- 2** Use the [▲]/[▼] buttons to select “Timer1 Setup” or “Timer2 Setup,” and press the [ENTER] button.
- 3** Use the [▲]/[▼] buttons to select “On” or “Off,” and press the [ENTER] button.
- 4** Press the [TIMER] button.
The clock will be displayed for a short time, and then the ABX-N300 will enter standby mode.

Using the Snooze Function

When the timer has initiated playback, you can temporarily stop playback by using the Snooze function; playback will resume five minutes later.

To use the snooze function

During playback that has been started by the timer, press the [SNOOZE] button.

Playback will temporarily stop, and will resume five minutes later.

Using the Sleep Timer

The sleep timer automatically puts the ABX-N300 in standby mode after the specified duration has elapsed.

Press the [SLEEP] button.

The display will indicate “Sleep 90 min.” Each time you press the [SLEEP] button, the setting will change in ten-minute steps in the range of “Sleep 90 min” - “Sleep 10 min.” When the specified duration has elapsed, the power will turn off.

Checking the remaining time

When you press the [SLEEP] button, the display will indicate the time remaining until the power will turn off. However if the remaining time is less than ten minutes, pressing the [SLEEP] button once again will cancel the Sleep timer.

Cancelling the sleep timer

Repeatedly press the [SLEEP] button until the “Sleep Off” indication appears.

Network Setup

In order to use the media server function (playing back music files saved on a computer), AirPlay, or Internet radio, the ABX-N300 must be connected to a network.

The ABX-N300 can connect to the network in either of two ways: wirelessly or by a cable. You'll need to make the settings that are appropriate for the type of network you're using.

Connect the ABX-N300 to your wireless LAN or wired LAN as described in "Connections" (page 13).

The ABX-N300's wireless LAN conforms to Wi-Fi.

Network Essentials

A network is a setup in which multiple devices are connected by a cable (or wirelessly) so that they can communicate with each other.

In a home, it is common to set up a network so that computers or game consoles can connect to the Internet, or so that data can be transferred between multiple computers.

A network of this type that is limited to a relatively small area, such as a home, is called a Local Area Network (LAN). If the ABX-N300 is connected to a network server such as a computer, it can play back music files stored on the network server (computer), or connect to the Internet to play Internet radio.

In such cases, you do not connect the ABX-N300 directly to the other computer or to the Internet.

In order to connect to a computer or to the Internet, several other pieces of equipment (network devices) are required.

The following equipment is required in order to use the ABX-N300's network functionality.

■ Router

A router is a device that sits between the ABX-N300 and a computer, or between the ABX-N300 and the Internet, and controls the flow of data.

In a network, the flow of data is referred to as "traffic." The router plays the role of a traffic controller between the various devices.

- For use with the ABX-N300, we recommend a broadband router that contains a 100Base-TX switch.
- If you want to connect via wireless LAN, you'll need to provide a wireless LAN router.
- If your router has DHCP functionality, it will be easy to make network settings.
- If you have a contract with an Internet Service Provider (ISP), use the router recommended by your ISP.

For more information about routers, please consult your dealer or your ISP.

■ Ethernet cable (CAT-5)

Ethernet cable is what is used to actually connect the devices making up the network. There are two types of Ethernet cable: straight cables and cross cables.

- The ABX-N300 uses an Ethernet straight cable that complies with CAT-5 standards. Consult your dealer for more information on Ethernet cables.
- If you're connecting via a wireless LAN, an Ethernet cable is not needed.

■ Network server (such as a computer / if using a network server)

This is a device that stores music files and delivers them to the ABX-N300 for playback.

- The requirements for use with the ABX-N300 will differ depending on the device you're using as a network server (see page 32).
- For details about media servers supported by the ABX-N300, refer to page 32.
- The conditions for optimal playback of music files on the ABX-N300 will depend on the network server (the performance of the computer) that you're using. For details on each device, refer to the owner's manual of the corresponding device.

■ Internet Access (for Internet radio)

To receive Internet radio, your Ethernet network must have Internet access. A narrowband Internet connection (e.g., 56 K modem, ISDN) will not provide satisfactory results, so a broadband connection is strongly recommended (e.g., cable modem, xDSL modem, etc). Please consult your ISP or computer dealer if you're unsure.

Notes:

- To receive Internet radio with the ABX-N300, your broadband Internet connection must be working and able to access the Web. Consult your ISP if you have any problems with your Internet connection.
- The ABX-N300 uses DHCP to configure its network settings automatically. If you want to configure these settings manually, see "Network connections (Manual)" on page 29.
- The ABX-N300 does not support PPPoE settings, so if you have a PPPoE-type Internet connection, you must use a PPPoE-compatible router.
- Depending on your ISP, you may need to specify a proxy server to use Internet radio. If your computer is configured to use a proxy server, use the same settings for the ABX-N300 (page 30).

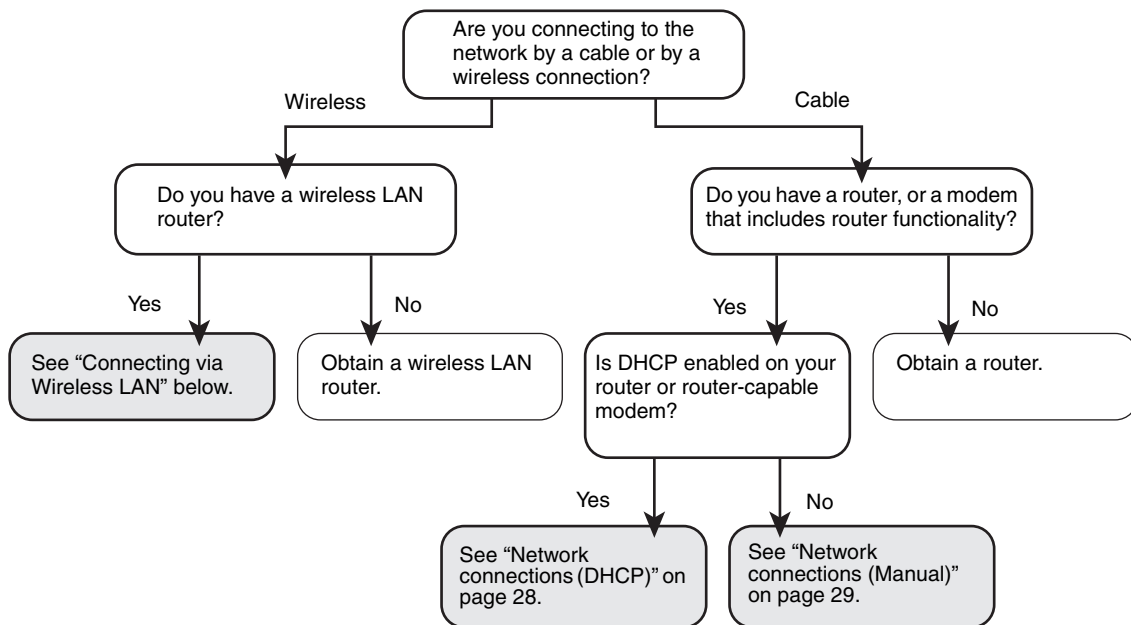

Caution

- You'll use the remote controller to perform these operations.
- Network settings are made while the ABX-N300 is in standby mode. If the ABX-N300 is powered-on, press the [⏻] button to put it in standby mode.

Connecting via Wireless LAN

Caution

- When setting up a wireless network connection, you'll need to enter the authentication method and security key. Have these settings ready before you begin.
- Unfold the Wireless LAN antenna located on the back of the ABX-N300.

1 Disconnect the AC adapter, wait at least ten seconds, and then reconnect the AC adapter.

Do not connect the Ethernet cable. If it is connected, disconnect the Ethernet cable and the AC adapter, and wait at least ten seconds before reconnecting only the AC adapter.

2 Press the [MENU] button.

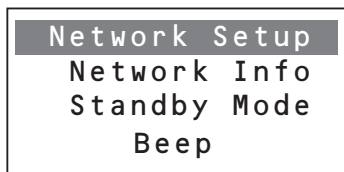

3 Use the [▲]/[▼] buttons to select "Standby Mode," and press the [ENTER] button; then use the [▲]/[▼] buttons to select "Network," and press the [ENTER] button.



4 Press the [MENU] button.

5 Use the [▲]/[▼] buttons to select "Network Setup," and press the [ENTER] button.

Wait until the "Connection" indication appears.



6 Use the [▲]/[▼] buttons to select “Wireless,” and press the [ENTER] button.

The ABX-N300 will search for wireless LAN access points, and will display the access points it finds.

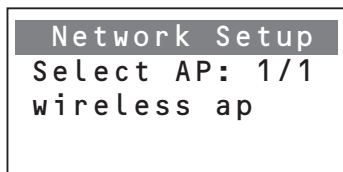

Note:

If an Ethernet cable is connected, you won't be able to select “Wireless.” If you want to connect via wireless LAN, you must disconnect the Ethernet cable.

7 Use the [▲]/[▼] buttons to select the access point to which you want to connect, and press the [ENTER] button.

8 Select the security type for the access point, and press the [ENTER] button.



For more about the security type, refer to the router settings.

9 Enter the security key.

Use the following buttons to enter characters.

[◀]/[▶] buttons: Move the cursor to left or right

[ENTER] button: Enter one character

[▲]/[▼] buttons: Switch character groups

[↶] button: Delete the character immediately before the cursor



Characters that can be entered

Alphabetical: uppercase A–Z, lowercase a–z

Numerals: 0–9

Other characters: ~ @ # \$ % & * () _ - + = / ?

BS: Delete the character immediately before the cursor

10 Move the cursor to “OK” and press the [ENTER] button.

Processing will be performed, and the system will restart. Then the network connection will be made.

If it succeeds, the display will indicate “Succeeded”; if it fails, the display will indicate “Failed.”

Tip:

If three minutes or longer have passed and the ABX-N300 is still not connected to the network or if the indication “Failed” is displayed, it may be that the security type or the security key was not entered correctly. In this case, try making the settings once again from the beginning. If you have made the settings several times and are still unable to connect, disconnect the AC adapter, wait at least ten seconds before reconnecting it, and then make the settings once again.

Connecting via Wired LAN

If you're using a broadband router that supports DHCP server functionality, the ABX-N300 will automatically make IP address settings when you connect an Ethernet cable.

If you connect the ABX-N300 to a network that does not support DHCP server functionality, you'll have to manually make settings such as the IP address.

Caution

- You'll use the remote controller to perform these operations.
- Make network settings while the ABX-N300 is in standby mode.
If the ABX-N300 is powered-on, press the [⏻] button to put it in standby mode.
- If you want to specify the network connection manually, first check details on the settings.
- Depending on your Internet service provider, it might not be possible for the connection to be made automatically. If so, please make the settings manually.

Network connections (DHCP)

1 Disconnect the AC adapter, then connect the Ethernet cable and wait at least ten seconds before reconnecting the AC adapter.

- 2** Press the [MENU] button.

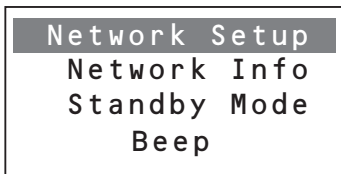

- 3** Use the [▲]/[▼] buttons to select “Standby Mode,” and press the [ENTER] button; then use the [▲]/[▼] buttons to select “Network,” and press the [ENTER] button.



- 4** Press the [MENU] button.

- 5** Use the [▲]/[▼] buttons to select “Network Setup,” and press the [ENTER] button.
Wait until the “Connection” indication appears.



- 6** Use the [▲]/[▼] buttons to select “Ethernet,” and press the [ENTER] button.

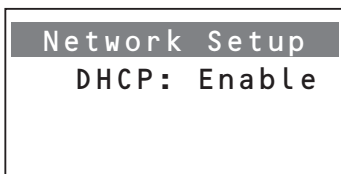

- 7** Use the [▲]/[▼] buttons to select “Enable,” and press the [ENTER] button.
Processing will be performed, and the system will restart. Then the network connection will be made. If it succeeds, the display will indicate “Succeeded”; if it fails, the display will indicate “Failed.”

Network connections (Manual)

- 1** Disconnect the AC adapter, then connect the Ethernet cable and wait at least ten seconds before reconnecting the AC adapter.

- 2** Press the [MENU] button.

- 3** Use the [▲]/[▼] buttons to select “Standby Mode,” and press the [ENTER] button; then use the [▲]/[▼] buttons to select “Network,” and press the [ENTER] button.

- 4** Press the [MENU] button.

- 5** Use the [▲]/[▼] buttons to select “Network Setup,” and press the [ENTER] button.
Wait until the “Connection” indication appears.

- 6** Use the [▲]/[▼] buttons to select “Ethernet,” and press the [ENTER] button.

- 7** Use the [▲]/[▼] buttons to select “Disable,” and press the [ENTER] button.

- 8** Specify the “IP Address,” and press the [ENTER] button.

Use the [◀◀]/[▶▶] buttons to move the cursor, and use the [▲]/[▼] buttons to select numerals. The following IP addresses can be specified.

Class A: “10.0.0.0”–“10.255.255.255”

Class B: “172.16.0.0”–“172.31.255.255”

Class C: “192.168.0.0”–“192.168.255.255”

- 9** Specify the “Subnet Mask,” and press the [ENTER] button.

Enter the subnet mask address provided by your ISP (typically 255.255.255.0).

Use the [◀◀]/[▶▶] buttons to move the cursor, and use the [▲]/[▼] buttons to select numerals.

- 10** Specify the “Gateway,” and press the [ENTER] button.

Enter the gateway address provided by your ISP.

Use the [◀◀]/[▶▶] buttons to move the cursor, and use the [▲]/[▼] buttons to select numerals.

- 11** Specify the “DNS Server (Primary DNS, Secondary DNS),” and then press the [ENTER] button.

Enter a DNS server address provided by your ISP.

Use the [◀◀]/[▶▶] buttons to move the cursor, and use the [▲]/[▼] buttons to select numerals.

12 Specify the “Proxy Enable” setting, and press the [ENTER] button.

Use the [▲]/[▼] buttons to select “No” or “Yes.” Choose “No” if you are not using a proxy server. If you are using a proxy server, choose “Yes,” and then enter the Proxy URL. Processing will be performed, and the system will restart. Then the network connection will be made. If it succeeds, the display will indicate “Succeeded”; if it fails, the display will indicate “Failed.”

Canceling without completing the settings

Press the [MENU] button.

All settings you had made up to this point will be cancelled.

Returning to the previous setting item

Press the [↶] button.

You’ll return to the previous setting item.

About Standby Mode

There are two types of standby mode: “Normal” and “Network.”

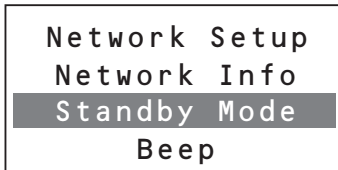

In “Normal,” the network circuitry will also power-off in standby mode, minimizing the electrical power consumption. However when the power is turned on, the ABX-N300’s power will turn on first, and then the network circuitry will be powered and started up; this means that it will take approximately 30 seconds before functions related to the network or to your iPod/iPhone will start operating.

In “Network,” the network circuitry remains powered even in standby mode; this means that functions related to the network and to your iPod/iPhone will begin operating immediately when the ABX-N300 is powered-on. However, this will increase the amount of power used while in standby mode up to approximately six watts.

If this is set to “Network,” the network standby indicator (orange) will light when the ABX-N300 is in standby mode.

Caution

“Network Setup” and “Network Info” cannot be set or viewed if “Standby Mode” is set to “Normal.” If you want to set or view these settings, you must first set “Standby Mode” to “Network.”

Later, you can set “Standby Mode” to “Normal” if desired.

Checking Network Information

Here’s how to view the IP address assigned to the ABX-N300, as well as other information.

- 1 While the ABX-N300 is in standby mode, press the remote controller’s [MENU] button.
- 2 Use the [▲]/[▼] buttons to select “Standby Mode,” and press the [ENTER] button; then use the [▲]/[▼] buttons to select “Network,” and press the [ENTER] button.



- 3 Press the [MENU] button.
- 4 Use the [▲]/[▼] buttons to select “Network Info,” and press the [ENTER] button.

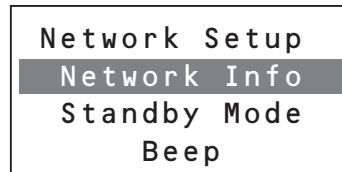

The IP Address will be displayed. When you press the [ENTER] button again, the MAC Address will be displayed.

Viewing the “WEB Setup Menu” Window

If the ABX-N300 is connected to the network, you can use a computer connected to that network to view and edit the settings.

1 While the ABX-N300 is in standby mode, press the remote controller’s [MENU] button.

2 Use the [▲]/[▼] buttons to select “Network Info,” and press the [ENTER] button.
The ABX-N300’s IP address will be displayed.

3 Start up a browser on your computer; in the URL field, enter the IP address displayed in step 2 to access it.
The “WEB Setup Menu” window will appear.

Editing the name shown in AirPlay

You can edit the ABX-N300’s name as it appears on a network such as AirPlay.

From the menu in the left side of the “WEB Setup Menu” window, choose “Profile Configuration,” edit the text in the “Digital Media Player Name” field, and press the [Apply] button.

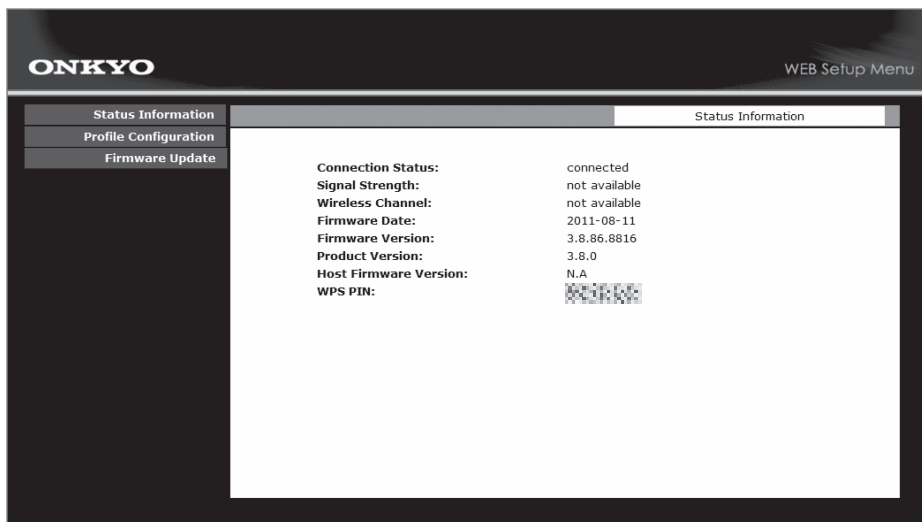

About Internet Radio and Media Servers

Internet Radio Function

Internet radio refers to radio broadcasts that are distributed via the Internet. Numerous Internet radio stations from around the world are being broadcast.

The ABX-N300 supports vTuner Internet Radio.

The ABX-N300's list of Internet radio stations uses the vTuner radio station database service.

* vTuner may become unavailable without notice.

The ABX-N300's Internet radio function can play the following audio file formats.

Format	Sampling frequency	Bit rate
MP3	32 kHz, 44.1 kHz, 48 kHz	32 kbps–320 kbps, VBR
WMA		
AAC		

Media Server Function

The ABX-N300 supports media servers; music files saved on a server or computer can be played back by the ABX-N300 via the network.

The ABX-N300 supports the following media server functionality.

- Communication protocol: UPnP-AV
- Device class: DMP

The ABX-N300's media server function can play the following audio file formats.

Format	Sampling frequency	Bit rate	Extension
MP3	32 kHz, 44.1 kHz, 48 kHz	32 kbps–320 kbps, VBR	.mp3
WMA			.wma
AAC		48 kbps–320 kbps	.m4a .aac
WAV		–	.wav

Server Requirements

The ABX-N300 can play digital music files stored on a computer or media server and supports the following technologies:

- Windows Media® Player 11
- Windows Media® Player 12

The computer or media server must be on the same network as the ABX-N300.

Note:

Depending on the media server, the ABX-N300 may not recognize it, or may not be able to play its music files.

Tip:

If the operating system of your computer is Windows® 7, Windows Media® Player 12 is already installed.

If the operating system of your computer is Windows Vista®, Windows Media® Player 11 is already installed. Windows Media® Player 11 for Windows® XP can be downloaded for free from the Microsoft website.

For more information, see the Microsoft website.

Troubleshooting

If you experience any problem while using the ABX-N300, look for a solution in this section.

If a problem occurs with the ABX-N300's operation, you may be able to solve the problem by resetting the unit.

Before you request service, please reset the ABX-N300 as described below.

1. While the ABX-N300 is in standby mode, press the remote controller's [MENU] button.

2. Use the [▲]/[▼] buttons to select "Reset," and press the [ENTER] button.

The screen will indicate "Cancel."

3. If you decide not to reset, press the [ENTER] button.

4. To reset, use the [▲]/[▼] buttons to select "Settings," and press the [ENTER] button.

All settings other than the network settings will return to their factory-set state, and the ABX-N300 will enter standby mode.

Note:

Selecting "Network" and then pressing the [ENTER] button will reset network-related functions. Perform this reset operation **ONLY** when the unit's network or iPod/iPhone does not function properly.

Power

Can't turn on the ABX-N300.

- Make sure that the AC adapter is properly plugged into the wall outlet, and that the DC IN connection has been made correctly (see page 13).
- Unplug the AC adapter from the wall outlet, wait ten seconds or more, then plug it in again.

The ABX-N300 turns off unexpectedly.

- If the sleep timer has been set and the SLEEP indication is shown on the display, the ABX-N300 will turn off automatically after a specified period (see page 25).
- When timed playback finishes, the ABX-N300 automatically switches to standby mode (see page 24).

It takes a long time from power-on until operation begins.

- It will take some time for functions related to the network or to your iPod/iPhone to begin operating.
- If you set "Standby Mode" (see page 30) to "Network," the power consumption while in standby mode will increase, but operation will begin immediately when you turn the power on.

Audio

There's no sound.

- Make sure the ABX-N300's volume is not set too low (see page 14).
- Make sure the correct input source is selected (see page 14).
- Make sure the ABX-N300 is not muted (see page 14).
- Check all connections and correct as necessary (see page 13).

The sound quality is not good.

- The sound quality can be affected by strong magnetic fields, such as that from a TV. Try moving any such devices away from the ABX-N300.
- If you have any devices that emit high-intensity radio waves near the ABX-N300, such as a cellular phone that's being used to make a call, the ABX-N300 may output noise.

Low range sounds are inaudible.

- Adjust the tone to your taste or according to the audio source by activating S.Bass (see page 15).
- Allow a space of 20 cm or more on each side of the unit (see page 11).

iPod/iPhone

There's no sound.

- Make sure that your iPod/iPhone is playing.
- Make sure your iPod/iPhone is properly seated in the ABX-N300's iPod dock. (see pages 9 and 16).
- Disconnect your iPod/iPhone from the dock, and then firmly insert it back into the dock.
- Make sure the ABX-N300 is turned on, the input source is set to iPod, and the volume is not set too low.
- If your iPod or iPhone is in a case, remove the case before inserting the iPod or iPhone (see page 9).

Can't control your iPod with the ABX-N300's remote controller.

- Make sure your iPod/iPhone is properly seated in the ABX-N300's iPod dock. Even very thin iPod/iPhone cases can prevent the iPod/iPhone from seating properly on the dock connector, so always remove any case before inserting your iPod/iPhone (see pages 9 and 16).
- Disconnect your iPod/iPhone from the dock, and then firmly insert it back into the dock.
- Depending on your iPod/iPhone model, its software version, or the content you're playing, some functions may not work as expected (see pages 9 and 16).

Troubleshooting—Continued

- To operate your iPod/iPhone using the remote controller, point the remote controller toward the ABX-N300's remote control sensor (see page 8).

Can't recharge the iPod/iPhone.

- Make sure your iPod/iPhone is properly seated in the ABX-N300's iPod dock. (see pages 9 and 16).
- Disconnect your iPod/iPhone from the dock, and then firmly insert it back into the dock.
- If your iPod or iPhone is in a case, remove the case before inserting the iPod or iPhone (see page 9).

The indication "No Dock" or "Connecting" remains even though your iPod/iPhone is connected.

- Disconnect your iPod/iPhone from the dock, and then firmly insert it back into the dock.
- Power-off the ABX-N300, or disconnect the AC adapter. Then turn on the power once again, and connect your iPod/iPhone.

Network

Can't use the network server.

- Make sure that the network server has the correct settings (see page 20).
- Make sure that the network server is running.
- Make sure that the network server is correctly connected to your home network.
- Make sure that the router's LAN port is correctly connected to the ABX-N300.
- Make sure that the correct IP address is assigned in the ABX-N300's "Network Info" (see page 30).

Sound is interrupted while playing music files from a network server.

- Make sure that the network server meets the operating requirements (see page 32).
- If you're using a computer as the network server, try closing all application software other than the server software (such as Windows Media® Player 12).
- The playback sound might be interrupted if your computer is downloading or copying a large amount of files.

Internet Radio

Can't listen to Internet radio.

- Make sure that the format being transmitted by the radio station is supported by the ABX-N300 (see page 32).
- The radio station may be off air or overly busy. Try again after a while.
- Check whether you can connect to the Internet from a different device. If not, power-off all devices connected to the network, wait for a while, and then turn them on again.

- Make sure that your router's LAN port is correctly connected to the ABX-N300.
- Make sure that the correct IP address is assigned in the ABX-N300's "Network Info" (see page 30).
- Depending on your ISP, you might need to make proxy server setting.
- Make sure you're using a router and modem that are supported by your ISP.

Playing Music Files Saved on a Network Server or Computer

Network server or computer does not display a list.

- Make sure that the network settings are correct (see page 20).
- Make sure that the router is set correctly.
- If the ABX-N300 is connected via a wireless LAN, the state of the radio signal may make it impossible for the ABX-N300 to connect to the server, or may cause the connection to be interrupted. Try connecting via a wired LAN.

Can't play back.

- Is the file you're attempting to play supported by the ABX-N300 (see page 32)?
- If the ABX-N300 is connected via a wireless LAN, the state of the radio signal may make playback impossible, or may cause the audio to be interrupted. Try connecting via a wired LAN.
- In order to play back music files from a computer, you'll need to start up Windows Media® Player 11 or 12, and make settings for it (see pages 20).

AirPlay

No Sound during AirPlay playback.

- After switching the input to something other than "AirPlay," pause iTunes or your iPod touch/iPhone/iPad and wait at least ten seconds before resuming playback.
- Click the AirPlay icon  to temporarily disable the iTunes or iPod touch/iPhone/iPad connection, and then try reconnecting and playing back (see page 17).
- Try turning the ABX-N300's power off and then on again. Alternatively, disconnect the AC adapter, and wait at least ten seconds before reconnecting it and turning the power on again.
- Try resetting the ABX-N300 (see page 33).
- Try restarting or resetting iTunes or your iPod touch/iPhone/iPad.

- When connected via a wireless LAN, radio conditions may make it impossible for the ABX-N300 to connect to the server, or the audio might be interrupted, or the image and audio might lose synchronization. Try connecting via a wired LAN.

Can't operate AirPlay.

- In some cases you won't be able to perform operations from the ABX-N300 itself or using the buttons of the remote controller. If so, perform the operations from your iPod touch/iPhone/iPad.
- If you've switched the input to something other than "AirPlay," pause your iPod touch/iPhone/iPad and wait at least ten seconds before resuming playback.
- If you turned the power off during AirPlay playback, pause your iPod touch/iPhone/iPad and wait at least ten seconds before resuming playback.
- If multiple ABX-N300 units are playing simultaneously, AirPlay might not be controlled correctly. Be careful not to let the remote control laser beam be received by multiple ABX-N300 units.

Rocketboost™ (North American models only)

Cannot connect to a Rocketboost network.

- If the joining process is failing, make sure that only one of your Rocketboost wireless devices has the Hub switch enabled.
- Make sure that you have installed the WLC-TR1 (sold separately).
- Make sure that the link is established by Rocketboost setup menu.
- The maximum number of Rocketboost devices in a Rocketboost Network at the same time is five. If you already have five devices and attempt to join another one, then joining will fail for the new device. Power down one of your devices and try again.

Remote Controller

The remote controller doesn't work properly.

- Replace the battery with a new one (see page 8).
- The ABX-N300's remote control sensor is being subjected to bright light (inverter-type fluorescent light or sunlight) (see page 8).
- The ABX-N300 may malfunction if fluorescent light bulbs in the room are wearing out and flickering. Please check the fluorescent lights.

External Components

Insufficient volume from portable audio player.

- Raise the volume on the portable audio player.
- Use a connection cable that does not contain a built-in resistor.

No sound is heard from your turntable.

- Make sure the turntable has a built-in phono equalizer. If the turntable doesn't have a phono equalizer built-in, you must provide one.
- If you're using a record player with an MC cartridge, you'll need a step-up transformer or a head amp.

Timers

The timers don't work.

- Are the clock and timer set correctly? Could there be a mistake in the day of the week, the 24-hour/12-hour time display setting, or the AM/PM setting (see pages 23 and 24)?
- The timer will not operate if the power is already on at the start time. Make sure that the ABX-N300 is in standby mode at the timer start time (see page 25).
- If the times of the two timers overlap, the timer that is set later will not operate. Set the two timers to non-overlapping times (see page 24).
- Make sure the timer is set to suitable volume setting (see page 25).
- If "Standby Mode" is set to "Normal," the system will start up when the timer-on time arrives; this means that it will be approximately 30 seconds later when sound actually begins to play.

Clock is not shown in standby mode.

- Pressing the remote control's [DISPLAY] button will make the clock appear for eight seconds (see page 23).
- It's not possible to make the clock remain displayed in standby mode.

The ABX-N300 contains a microcomputer. In very rare situations, severe interference, noise from an external source, or static electricity may cause it to malfunction or lockup. In the unlikely event that this should happen, unplug the AC adapter, wait at least ten seconds, and then plug it back in again. If this doesn't resolve the issue, reset the ABX-N300 to its factory defaults (see page 33).

Specifications

■ General

Power Supply:	AC 100 V-240 V, 50/60 Hz
Power Consumption:	38 W
Stand-by Power Consumption:	0.7 W (with "Standby Mode" set to "Normal," and no iPod/iPhone connected)
Dimensions (W × H × D):	430 × 131 × 148 mm (16-15/16 × 5-3/16 × 5-13/16 inches)
Weight:	2.6 kg (5.7 lbs.)
Analog Input:	LINE

■ Amplifier

Power Output:	2ch × 10 W (6 Ω, 1 kHz, 1% THD)
----------------------	---------------------------------

■ Speakers

Type:	Full-Range bass reflex
Unit:	6 cm (2-3/8") cone (magnetically shielded)

Specifications and features are subject to change without notice.

ONKYO

Onkyo Sound & Vision Corporation

2-1, Nisshin-cho, Neyagawa-shi, OSAKA 572-8540, JAPAN
Tel: 072-831-8023 Fax: 072-831-8163
<http://www.onkyo.com/>

Onkyo U.S.A. Corporation

18 Park Way, Upper Saddle River, N.J. 07458, U.S.A.
Tel: 800-229-1687, 201-785-2600 Fax: 201-785-2650
<http://www.us.onkyo.com/>

Onkyo Europe Electronics GmbH

Liegnitzerstrasse 6, 82194 Groebenzell, GERMANY
Tel: +49-8142-4401-0 Fax: +49-8142-4208-213
<http://www.eu.onkyo.com/>

Onkyo Europe Electronics GmbH (UK Branch)

The Coach House 81A High Street, Marlow, Buckinghamshire, SL7 1AB, UK
Tel: +44-(0)1628-473-350 Fax: +44-(0)1628-401-700

Onkyo China Limited

Unit 1033, 10/F, Star House, No 3, Salisbury Road, Tsim Sha Tsui Kowloon, Hong Kong.
Tel: 852-2429-3118 Fax: 852-2428-9039
<http://www.onkyochina.com/>

Onkyo China PRC

1301, 555 Tower, No.555 West NanJin Road, Jin an, Shanghai,
China 200041, Tel: 86-21-52131366 Fax: 86-21-52130396
<http://www.cn.onkyo.com/>

I1205-1

SN 29401122

(C) Copyright 2012 Onkyo Sound & Vision Corporation Japan. All rights reserved.



Free Manuals Download Website

<http://myh66.com>

<http://usermanuals.us>

<http://www.somanuals.com>

<http://www.4manuals.cc>

<http://www.manual-lib.com>

<http://www.404manual.com>

<http://www.luxmanual.com>

<http://aubethermostatmanual.com>

Golf course search by state

<http://golfingnear.com>

Email search by domain

<http://emailbydomain.com>

Auto manuals search

<http://auto.somanuals.com>

TV manuals search

<http://tv.somanuals.com>