

# ONKYO®

## Hard Disk Music Library

# *MB-S1*

## Instruction Manual

Thank you for purchasing the Onkyo Hard Disk Music Library.

Please read this manual thoroughly before making connections and plugging in the unit. Following the instructions in this manual will enable you to obtain optimum performance and listening enjoyment from your new Hard Disk Music Library. Please retain this manual for future reference.

## Contents

<b>Before using</b>	<b>2</b>
---------------------	----------

<b>Facilities and connections</b>	<b>7</b>
-----------------------------------	----------

<b>Setup and operation</b>	<b>26</b>
----------------------------	-----------

<b>Remote controller</b>	<b>56</b>
--------------------------	-----------

<b>Appendix</b>	<b>71</b>
-----------------	-----------

## WARNING:

TO REDUCE THE RISK OF FIRE OR ELECTRIC SHOCK, DO NOT EXPOSE THIS APPLIANCE TO RAIN OR MOISTURE.

## CAUTION:

TO REDUCE THE RISK OF ELECTRIC SHOCK, DO NOT REMOVE COVER (OR BACK). NO USER-SERVICEABLE PARTS INSIDE. REFER SERVICING TO QUALIFIED SERVICE PERSONNEL.



**WARNING**  
RISK OF ELECTRIC SHOCK  
DO NOT OPEN

**AVIS**  
RISQUE DE CHOC ELECTRIQUE  
NE PAS OUVRIR



The lightning flash with arrowhead symbol, within an equilateral triangle, is intended to alert the user to the presence of uninsulated "dangerous voltage" within the product's enclosure that may be of sufficient magnitude to constitute a risk of electric shock to persons.



The exclamation point within an equilateral triangle is intended to alert the user to the presence of important operating and maintenance (servicing) instructions in the literature accompanying the appliance.

# Important Safeguards

- 1. Read Instructions** – All the safety and operating instructions should be read before the appliance is operated.
- 2. Retain Instructions** – The safety and operating instructions should be retained for future reference.
- 3. Heed Warnings** – All warnings on the appliance and in the operating instructions should be adhered to.
- 4. Follow Instructions** – All operating and use instructions should be followed.
- 5. Cleaning** – Unplug the appliance from the wall outlet before cleaning. The appliance should be cleaned only as recommended by the manufacturer.
- 6. Attachments** – Do not use attachments not recommended by the appliance manufacturer as they may cause hazards.
- 7. Water and Moisture** – Do not use the appliance near water – for example, near a bath tub, wash bowl, kitchen sink, or laundry tub; in a wet basement; or near a swimming pool; and the like.
- 8. Accessories** – Do not place the appliance on an unstable cart, stand, tripod, bracket, or table. The appliance may fall, causing serious injury to a child or adult, and serious damage to the appliance. Use only with a cart, stand, tripod, bracket, or table recommended by the manufacturer, or sold with the appliance. Any mounting of the appliance should follow the manufacturer's instructions, and should use a mounting accessory recommended by the manufacturer.
- 9. An appliance and cart combination should be moved with care.** Quick stops, excessive force, and uneven surfaces may cause the appliance and cart combination to overturn.  

PORTABLE CART WARNING  
S3125A
- 10. Ventilation** – Slots and openings in the cabinet are provided for ventilation and to ensure reliable operation of the appliance and to protect it from overheating, and these openings must not be blocked or covered. The openings should never be blocked by placing the appliance on a bed, sofa, rug, or other similar surface. The appliance should not be placed in a builtin installation such as a bookcase or rack unless proper ventilation is provided. There should be free space of at least 5 cm (2 in.) and an opening behind the appliance.
- 11. Power Sources** – The appliance should be operated only from the type of power source indicated on the marking label. If you are not sure of the type of power supply to your home, consult your appliance dealer or local power company.
- 12. Grounding or Polarization** – The appliance may be equipped with a polarized alternating current line plug (a plug having one blade wider than the other). This plug will fit into the power outlet only one way. This is a safety feature. If you are unable to insert the plug fully into the outlet, try reversing the plug. If the plug should still fail to fit, contact your electrician to replace your obsolete outlet. Do not defeat the safety purpose of the polarized plug.
- 13. Power-Cord Protection** – Powersupply cords should be routed so that they are not likely to be walked on or pinched by items placed upon or against them, paying particular attention to cords at plugs, convenience receptacles, and the point where they exit from the appliance.
- 14. Lightning** – For added protection for the appliance during a lightning storm, or when it is left unattended and unused for long periods of time, unplug it from the wall outlet and disconnect the antenna or cable system. This will prevent damage to the appliance due to lightning and power-line surges.
- 15. Overloading** – Do not overload wall outlets, extension cords, or integral convenience receptacles as this can result in a risk of fire or electric shock.
- 16. Object and Liquid Entry** – Never push objects of any kind into the appliance through openings as they may touch dangerous voltage points or short-out parts that could result in a fire or electric shock. Never spill liquid of any kind on the appliance.
- 17. Servicing** – Do not attempt to service the appliance yourself as opening or removing covers may expose you to dangerous voltage or other hazards. Refer all servicing to qualified service personnel.
- 18. Damage Requiring Service** – Unplug the appliance from the wall outlet and refer servicing to qualified service personnel under the following conditions:
  - When the power-supply cord or plug is damaged,
  - If liquid has been spilled, or objects have fallen into the appliance,
  - If the appliance has been exposed to rain or water,
  - If the appliance does not operate normally by following the operating instructions. Adjust only those controls that are covered by the operating instructions as an improper adjustment of other controls may result in damage and will often require extensive work by a qualified technician to restore the appliance to its normal operation,
  - If the appliance has been dropped or damaged in any way, and
  - When the appliance exhibits a distinct change in performance – this indicates a need for service.
- 19. Replacement Parts** – When replacement parts are required, be sure the service technician has used replacement parts specified by the manufacturer or have the same characteristics as the original part. Unauthorized substitutions may result in fire, electric shock, or other hazards.
- 20. Safety Check** – Upon completion of any service or repairs to the appliance, ask the service technician to perform safety checks to determine that the appliance is in proper operation condition.
- 21. Wall or Ceiling Mounting** – The appliance should be mounted to a wall or ceiling only as recommended by the manufacturer.
- 22. Heat** – The appliance should be situated away from heat sources such as radiators, heat registers, stoves, or other appliances (including amplifiers) that produce heat.
- 23. The apparatus shall not be exposed to dripping or splashing and that no objects filled with liquids, such as vases shall be placed on the apparatus.**

# Precautions

## 1. Recording Copyright

Recording of copyrighted material for other than personal use is illegal without permission of the copyright holder.

## 2. Power

### WARNING

BEFORE PLUGGING IN THE UNIT FOR THE FIRST TIME, READ THE FOLLOWING SECTION CAREFULLY.

The voltage of the available power supply differs according to country or region. Be sure that the power supply voltage of the area where this unit will be used meets the required voltage (e.g., AC 230 V, 50 Hz or AC 120 V, 60 Hz) written on the rear panel.

Turning off the standby button does not shut off the power completely. So the power cord should be removed from the AC outlet when the unit is not used for a prolonged time.

## 3. Do not touch this unit with wet hands

Do not handle this unit or power cord when your hands are wet or damp. If water or any other liquid enters the case, take this unit to an authorized service center for inspection.

## 4. Location of this unit

Place this unit in a well-ventilated location.

Take special care to provide plenty of ventilation on all sides of this unit especially when it is placed in an audio rack. If ventilation is blocked, this unit may overheat and malfunction.

Do not expose this unit to direct sunlight or heating units as this unit's internal temperature may rise and shorten the life of the pickup.

Avoid damp and dusty places and places directly affected by vibrations from the speakers. In particular, avoid placing the unit on or above one of the speakers.

Be sure this unit is placed in a horizontal position. Never place it on its side or on a slanted surface as it may malfunction.

Do not place near tuners or TV sets.

If placed next to a TV or tuner, it may cause reception interference resulting in some noise in the TV or tuner output.

## 5. Care

From time to time you should wipe the front and rear panels and the cabinet with a soft cloth. For heavier dirt, dampen a soft cloth in a weak solution of mild detergent and water, wring it out dry, and wipe off the dirt. Following this, dry immediately with a clean cloth.

Do not use rough material, thinners, alcohol or other chemical solvents or cloths since these could damage the finish or remove the panel lettering.

## 6. Points to remember

If this unit is brought from a cold environment to a warm one or is in a cold room that is quickly heated, condensation may form on the pickup, preventing proper operation. In this case, remove the disc and leave the power ON for about one hour to remove the condensation.

When transporting this unit, be careful not to bump it.

### DANGER:

INVISIBLE LASER RADIATION WHEN OPEN AND INTER-LOCK FAILED OR DEFEATED. AVOID DIRECT EXPOSURE TO BEAM.

### CAUTION:

THIS PRODUCT UTILIZES A LASER. USE OF CONTROLS OR ADJUSTMENTS OR PERFORMANCE OF PROCEDURES OTHER THAN THOSE SPECIFIED HEREIN MAY RESULT IN HAZARDOUS RADIATION EXPOSURE.

### For U.S. model

The laser is covered by a housing which prevents exposure during operation or maintenance. However, this product is classified as a Laser Product by CDRH (Center for Devices and Radiological Health) which is a department of the Food and Drug Administration. According to their regulations 21 CFR section 1002.30, all

manufacturers who sell Laser Products must maintain records of written communications between the manufacturer, dealers and customers concerning radiation safety. If you have any complaints about instructions or explanations affecting the use of this product, please feel free to write to the address on the back page of this manual. When you write us, please include the model number and serial number of your unit.

In compliance with Federal Regulations, the certification, identification and the period of manufacture are indicated on the rear panel.

### FCC INFORMATION FOR USER

#### CAUTION:

The user changes or modifications not expressly approved by the party responsible for compliance could void the user's authority to operate the equipment.

#### NOTE:

This equipment has been tested and found to comply with the limits for a Class B digital device, pursuant to Part 15 of the FCC Rules. These limits are designed to provide reasonable protection against harmful interference in a residential installation. This equipment generates, uses and can radiate radio frequency energy and, if not installed and used in accordance with the instructions, may cause harmful interference to radio communications. However, there is no guarantee that interference will not occur in a particular installation. If this equipment does cause harmful interference to radio or television reception, which can be determined by turning the equipment off and on, the user is encouraged to try to correct the interference by one or more of the following measures:

- Reorient or relocate the receiving antenna.
- Increase the separation between the equipment and receiver.
- Connect the equipment into an outlet on a circuit different from that to which the receiver is connected.
- Consult the dealer or an experienced radio/TV technician for help.

### Declaration of Conformity

We, ONKYO EUROPE  
ELECTRONICS GmbH  
INDUSTRIESTRASSE 20  
82110 GERMERING,  
GERMANY



declare in own responsibility, that the ONKYO product described in this instruction manual is in compliance with the corresponding technical standards such as EN60065, EN55013, EN55020 and EN61000-3-2, -3-3.

GERMERING, GERMANY

I. MORI

ONKYO EUROPE ELECTRONICS GmbH

### Memory Preservation

This unit does not require memory preservation batteries. A built-in memory power back-up system preserves the contents of the memory during power failures and even when the unit is unplugged. The unit must be plugged-in in order to charge the back-up system.

The memory preservation period after the unit has been unplugged varies depending on climate and placement of the unit. On the average, memory contents are protected over a period of a few weeks after the last time the unit was unplugged. This period is shorter when the unit is exposed to a highly humid climate.

# Precautions

---

## For Canadian model

**NOTE:** THIS CLASS B DIGITAL APPARATUS COMPLIES WITH CANADIAN ICES-003.

For models having a power cord with a polarized plug:

**CAUTION:** TO PREVENT ELECTRIC SHOCK, MATCH WIDE BLADE OF PLUG TO WIDE SLOT, FULLY INSERT.

## Modele pour les Canadien

**REMARQUE:** CET APPAREIL NUMÉRIQUE DE LA CLASSE B EST CONFORME À LA NORME NMB-003 DU CANADA.

**Sur les modèles dont la fiche est polarisée:**

**ATTENTION:** POUR ÉVITER LES CHOCS ÉLECTRIQUES, INTRODUIRE LA LAME LA PLUS LARGE DE LA FICHE DANS LA BORNE CORRESPONDANTE DE LA PRISE ET POUSSER JUSQU'AU FOND.

## For European model

This unit contains a semiconductor laser system and is classified as a "CLASS 1 LASER PRODUCT". So, to use this model properly, read this Instruction Manual carefully. In case of any trouble, please contact the store where you purchased the unit. To prevent being exposed to the laser beam, do not try to open the enclosure.



This label on the left hand panel states that:

1. This unit is a CLASS 1 LASER PRODUCT and employs a laser inside the cabinet.
2. To prevent the laser from being exposed, do not remove the cover. Refer servicing to qualified personnel.

## For British model

Replacement and mounting of an AC plug on the power supply cord of this unit should be performed only by qualified service personnel.

### IMPORTANT

The wires in the mains lead are coloured in accordance with the following code:

- Blue : Neutral
- Brown : Live

As the colours of the wires in the mains lead of this apparatus may not correspond with the coloured markings identifying the terminals in your plug, proceed as follows:

The wire which is coloured blue must be connected to the terminal which is marked with the letter N or coloured black.

The wire which is coloured brown must be connected to the terminal which is marked with the letter L or coloured red.

### IMPORTANT

A 5 ampere fuse is fitted in this plug. Should the fuse need to be replaced, please ensure that the replacement fuse has a rating of 5 amperes and that it is approved by ASTA or BSI to BS1362. Check for the ASTA mark or the BSI mark on the body of the fuse.

IF THE FITTED MOULDED PLUG IS UNSUITABLE FOR THE SOCKET OUTLET IN YOUR HOME, THEN THE FUSE SHOULD BE REMOVED AND THE PLUG CUT OFF AND DISPOSED OF SAFELY. THERE IS A DANGER OF SEVERE ELECTRICAL SHOCK IF THE CUT OFF PLUG IS INSERTED INTO ANY 13 ampere SOCKET.

If in any doubt, please consult a qualified electrician.

# Contents

<b>Before using</b>		<b>Setup and operation</b>	
<b>Important Safeguards</b> .....	<b>2</b>	<b>Setup menus</b> .....	<b>26</b>
<b>Precautions</b> .....	<b>3</b>	Navigating through the Setup menu .....	27
<b>Contents</b> .....	<b>4</b>	<b>Hardware Setup</b> .....	<b>28</b>
<b>Features</b> .....	<b>6</b>	<b>0. Hardware Setup menu</b> .....	<b>28</b>
<b>Supplied accessories</b> .....	<b>6</b>	0-1. Speaker Impedance sub-menu .....	28
<b>Before using this unit</b> .....	<b>7</b>	0-2. IR IN Setup sub-menu .....	28
Setting the Voltage selector (Worldwide models only) ...	7	0-3. AM Frequency Step sub-menu .....	28
Installing the remote controller batteries .....	7	<b>Speaker Setup</b> .....	<b>29</b>
Using the remote controller .....	7	<b>1. Speaker Setup menu</b> .....	<b>29</b>
<b>Facilities and connections</b>		1-1. Speaker Config sub-menu .....	29
<b>Front panel facilities</b> .....	<b>8</b>	1-2. Speaker Distance sub-menu .....	30
<b>Remote controller</b> .....	<b>10</b>	1-3. Level Calibration sub-menu .....	31
<b>Rear panel facilities</b> .....	<b>12</b>	1-4. Bass Peak Level (Bass Peak Level Manager*)	
<b>Connections</b> .....	<b>15</b>	sub-menu .....	32
Connecting your audio components .....	15	<b>Input Setup</b> .....	<b>33</b>
Connecting your video components .....	16	<b>2. Input Setup menu</b> .....	<b>33</b>
<b>Connecting speakers</b> .....	<b>19</b>	2-1. Digital Setup sub-menu .....	33
Ideal speaker configuration .....	19	2-2. Multichannel Setup sub-menu .....	34
Minimum speaker configuration for		2-3. Video Setup sub-menu .....	35
surround sound playback .....	19	2-4. Character Input sub-menu .....	36
Speaker placement .....	19	2-5. Intelli Volume sub-menu .....	36
Connecting speakers .....	20	2-6. Listening Mode Preset sub-menu .....	37
Connecting the speaker cable .....	20	<b>Audio Adjust</b> .....	<b>40</b>
Connecting a subwoofer .....	20	<b>3. Audio Adjust Setup menu</b> .....	<b>40</b>
<b>Connecting the remote zone (Zone 2)</b>		<b>Preference</b> .....	<b>44</b>
<b>speakers</b> .....	<b>21</b>	<b>4. Preference menu</b> .....	<b>44</b>
When using the ZONE 2 OUT terminals .....	21	4-1. Volume Setup sub-menu .....	44
<b>Operating components not reached by the</b>		4-2. Headphones Level Setup sub-menu .....	45
<b>remote controller signals (IR IN/OUT)</b> .....	<b>22</b>	4-3. OSD Setup sub-menu .....	45
If the remote controller signal does not reach		4-4. OSD Position sub-menu .....	45
the TX-DS797 remote sensor .....	22	<b>Listening to Radio Broadcasts</b> .....	<b>46</b>
If the remote controller signal does not reach		Tuning into a radio station .....	46
other components .....	22	Listening to a stereo radio station (FM mode) .....	46
<b>Connecting the power</b> .....	<b>23</b>	Presetting a radio station .....	47
<b>Connecting antennas</b> .....	<b>24</b>	Selecting a preset radio station .....	47
Assembling the AM loop antenna .....	24	Erasing a preset radio station .....	47
Connecting the AM antenna cable .....	24	<b>Listening to RDS broadcasts</b>	
Connecting the included antennas .....	24	<b>(European models only)</b> .....	<b>48</b>
Connecting an FM outdoor antenna .....	25	Listening to RDS broadcasts .....	48
Connecting an AM outdoor antenna .....	25	PTY program types in Europe .....	48
Directional linkage .....	25	Displaying Radio Text (RT) .....	49
Connecting the antenna cable to the 75/300 Ω antenna adapter		Performing a PTY scan .....	49
(For all models other than European models) .....	25	Performing a TP scan .....	49

# Main Features

---

## ■ Encoding the music files on an audio CD in MP3 format<sup>(\*1)</sup> and decoding the MP3 music files

- You can record tracks on an audio CD in MP3 format. The tracks are compressed approximately 1/10 in data size when using the standard 128kbps bitrate<sup>(\*2)</sup>.
- Available encoding bitrates are no compression (PCM), 96kbps, 128kbps, and 192kbps.
- You can display and edit the ID3 tag<sup>(\*3)</sup> information including song title, album title and artist name.
- You can record from the built-in CD player, digital input and analog input. In addition, you can record (transfer) the tracks stored on PC through USB interface.
- Sorting feature using the file information including ID3 tags is available for various playback modes.
- You can mark any tracks you like as your favorites and play only the favorite tracks.

## ■ Playing audio CDs and CD-Rs

- You can play CD-Rs containing audio data in MP3 format as well as ordinary audio CDs.
- You can copy the MP3 files recorded on a CD-R to the internal hard disk drive (HDD) 10 times faster than when recording tracks from an audio CD (when using the QUICK REC feature).

## ■ Longer hours recording with the internal hard disk drive (HDD)

- FDB (Fluid Dynamic Bearing) motor employed in the HDD section has the lowest vibration characteristics suited for audio device with motor. This enables stability in playback.
- You can record and play MP3 music files many hours using the HDD. More than 350 hours of music can be recorded onto the 20GB HDD when using standard 128kbps bitrate.
- Timer recording feature allows you to record long hour programs away from the MB-S1.

## ■ Transferring music files from PC to the MB-S1

- The MP3 files stored on PC can be transferred to the MB-S1 through USB interface using the Carry Tunes (attached file transfer software).

### \*1 MP3

An audio compression format that is part of MPEG1 image compression technology.

### \*2 bitrate

The maximum amount of data that can be processed by a system per second.

Bit is the minimum unit for showing 0 and 1 in digital data.

kbps is the abbreviation of kilo bit per second. The larger the bitrate is used, the greater the encoded file size is.

### \*3 ID3 tag

The area for storing character information on MP3 file.

You can add up to 128 bytes of character information such as album title and artist name. Each information will be limited to 30 characters long. The information entered in the ID3 tag area can be displayed and edited on the player which supports ID3 tag.

# Supplied accessories

Check that the following accessories are supplied with the MB-S1.

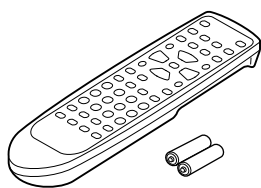

Remote controller × 1  
Batteries (AA, R6 or UM-3) × 2

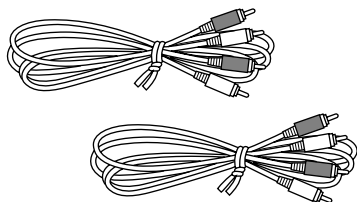

Audio connection cables × 2



R I cable × 1

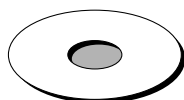

CD-ROM × 1

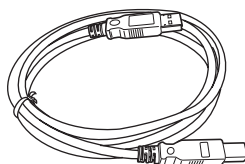

USB cable × 1

Instruction manual × 1  
Warranty card × 1

## Before using this unit

### Installing the remote controller batteries

1. Remove the battery compartment cover by pressing and sliding the cover.
2. Insert two AA (R6 or UM-3) batteries into the battery compartment. Carefully follow the polarity diagram (positive (+) and negative (-) symbols) inside the battery compartment.
3. After batteries are installed and seated correctly, replace the compartment cover.

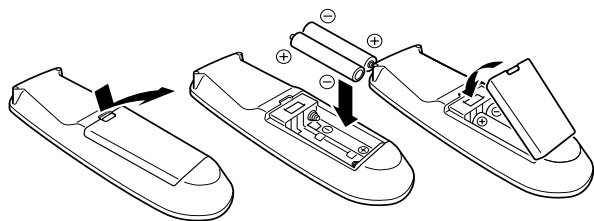

#### Notes:

- Do not mix new batteries with old batteries or different kinds of batteries.
- To avoid corrosion, remove the batteries if the remote controller is not to be used for a long time.
- Remove dead batteries immediately to avoid damage from corrosion. If the remote controller does not operate smoothly, replace both the batteries at the same time.
- The life of the batteries supplied is about six months but this will vary depending on usage.

### Using the remote controller

Point the remote controller toward the remote control sensor. The STANDBY indicator lights up when the unit receives a signal from the remote controller.

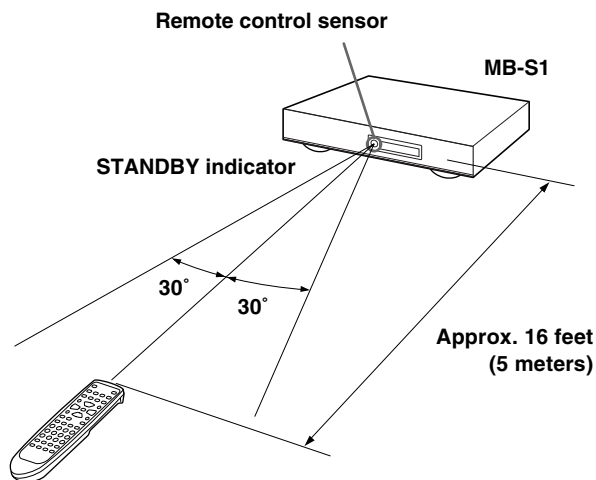

#### Notes:

- Place the unit away from strong light such as direct sunlight or inverted fluorescent light which can prevent proper operation of the remote controller.
- Using another remote controller of the same type in the same room or using the unit near equipment which uses infrared rays may cause operational interference.
- Do not put objects on the remote controller. Its buttons may be pressed by mistake and drain the batteries.
- Make sure the audio rack doors do not have colored glass. Placing the unit behind such doors may prevent proper remote controller operation.
- If there is any obstacle between the remote controller and the remote control sensor, the remote controller will not operate.

# Parts names and functions

## Front panel

The numbers within the brackets are the pages where the part or function is introduced.

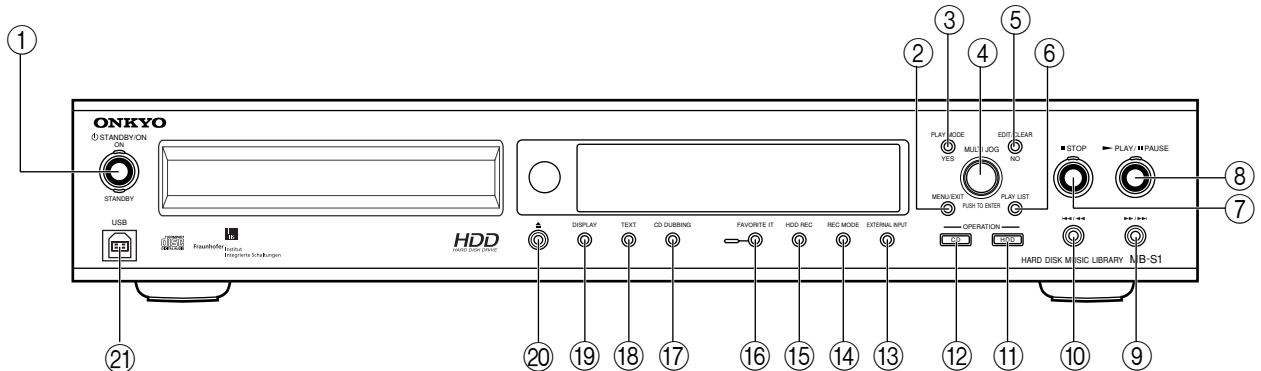

**① STANDBY/ON button [xx]**

Turns on the MB-S1 or lets it enter the standby state.

**② MENU/EXIT button [xx]**

Switches the menu mode. Press this button while selecting any menu item exits the menu.

**③ PLAY MODE/YES button [xx]**

Switches play mode combined with use of the jog dial.

**④ MULTI JOG dial**

Usually, used for selecting the group number (folder). While setting any mode, used for selecting the parameters for a mode. Also, press this dial to confirm the entry.

**⑤ EDIT/CLEAR/NO button [xx]**

Press this button to enter the state for setting modes or parameters. When you are asked to select Yes or No, this button works as NO selection. While editing ID3 tag information, this button works as CLEAR button for canceling the entry.

**⑥ PLAY LIST button [xx]**

Switches the play lists combined with use of the jog dial. You can store up to 100 play lists on memory of the MB-S1.

**⑦ ■ STOP button [xx]**

Stops the playback of CD or HDD.

**⑧ ► PLAY/■ PAUSE button [xx]**

Starts playing or recording tracks on CD or HDD. Press this button while playing or recording, the MB-S1 pauses. Press it again resumes playing or recording.

**⑨ ►► / ►►► button [xx]**

Press to locate the beginning of the next track. Hold down to fast forward.

**⑩ ◀◀ / ◀◀◀ button [xx]**

Press to locate the beginning of the current or previous track. Hold down to rewind.

**⑪ HDD button [xx]**

Activates the HDD section.

**⑫ CD button [xx]**

Activates the CD player section.

**⑬ EXTERNAL INPUT [xx]**

Selects the external input source. The input sources switches in the order of DIGITAL-1 (optical), DIGITAL-2 (coaxial), and ANALOG.

**⑭ REC MODE button [xx]**

Switches recording mode. The recording modes switch in the order of PCM, MP3 96Kbps, MP3 128Kbps, and MP3 192Kbps.

**⑮ HDD REC button [xx]**

Puts the MB-S1 in recording standby state. Press it again to select a group which the recorded tracks will belong to.

**⑯ FAVORITE IT button [xx]**

Marks the currently selected or played track as your favorite. Pressing the button again unmarks the track.

**⑰ CD DUBBING button [xx]**

Copies whole CD onto the MB-S1's HDD with ease.

**⑱ TEXT button [xx]**

Enters the mode for entering and editing characters.

**⑲ DISPLAY button [xx]**

Switches the information displayed in the display area (TITLE, ALBUM, ARTIST, GENRE, DATE, GROUP). Displays the letter you entered while editing information.

**⑳ ▲ (open/close) button [xx]**

Opens and closes the CD tray.

**㉑ USB port [xx]**

Connects the PC. You can transfer MP3 audio files from a PC to the MB-S1's HDD using the Carry Tunes PC software.

The MB-S1 supports the hot plug capability, allowing you to connect or disconnect without turning the PC off.



## Parts names and functions

### Front panel display

The numbers within the brackets are the pages where the part or function is introduced.

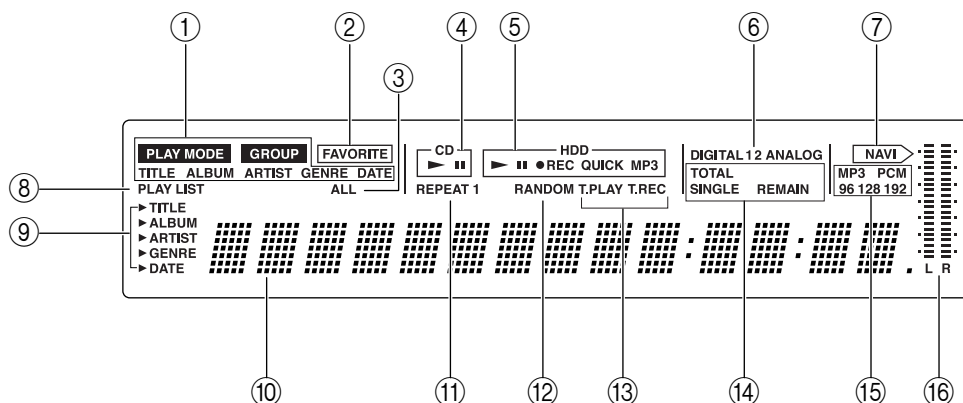

#### ① PLAY MODE indicators [xx]

The indicator showing current play mode lights.

#### ② FAVORITE indicator [xx]

Lights while your favorite tracks are played.

#### ③ ALL indicator [xx]

Lights when the all tracks are played regardless of the play mode.

#### ④ CD mode indicator [xx]

Lights when you are playing CD.

#### ⑤ HDD mode indicator [xx]

Lights when you are playing tracks recorded on the hard disk drive. "QUICK" lights when the quick recording (copying tracks) mode is operating. "MP3" lights when the tracks are recorded in MP3 format.

#### ⑥ DIGITAL 1 2, ANALOG indicators [xx]

Lights when the DIGITAL 1 (optical), DIGITAL 2 (coaxial), or ANALOG (analog) is selected for input source.

#### ⑦ NAVI indicator [xx]

Lights when the display shows the current position of the track played.

#### ⑧ PLAY LIST indicator [xx]

Lights when the tracks registered with the play list are played.

#### ⑨ ▶TITLE, ▶ALBUM, ▶ARTIST, ▶GENRE, and ▶DATE indicators [xx]

Shows the display mode for the versatile area.

#### ⑩ Multi function display

#### ⑪ REPEAT/REPEAT 1 indicator [xx]

Lights when the tracks are played repeatedly. "REPEAT 1" lights when the single track is played repeatedly.

#### ⑫ RANDOM indicator [xx]

Lights when the tracks on the hard disk drive are played in random order.

#### ⑬ T.PLAY and T.REC indicators [xx]

Lights when the timer recording or playing operation is reserved.

#### ⑭ TOTAL, SINGLE, and REMAIN indicators [xx]

Lights when the playing time information is shown in the versatile area.

#### ⑮ MP3, PCM, 96, 128, and 192 indicators [xx]

Shows the encode mode for the current track. When you play the MP3 track, "MP3" indicator lights with "96", "128", or "192" indicator according to the track's bitrate. When any other bitrate is used for the MP3 track, only "MP3" indicator lights.

#### ⑯ Level indicator [xx]

Shows the audio level for the current track or the position currently playing.

# Parts names and functions

## Remote controller

The numbers within the brackets are the pages where the part or function is introduced.

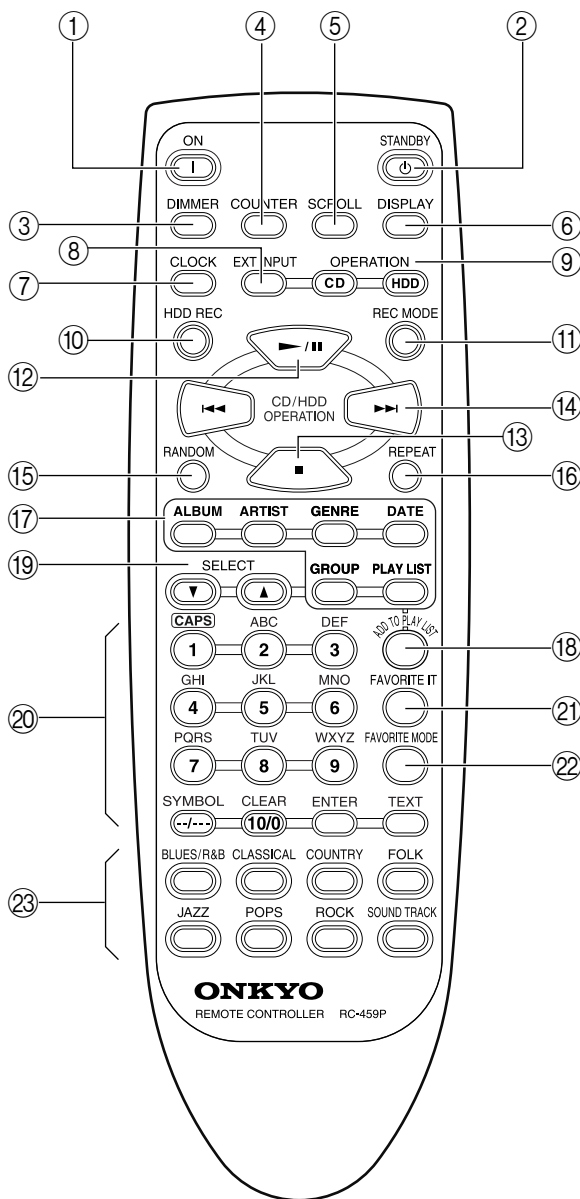

**1 ON button [xx]**  
Press to turn the MB-S1 on and off.

**2 STANDBY button [xx]**  
Press to turn the MB-S1 into the standby state.

**3 DIMMER button [xx]**  
Press to change the brightness of the display.

**4 COUNTER button [xx]**  
Press to change the displayed information for playing time.

**5 SCROLL button [xx]**  
Press to scroll the display.

**6 DISPLAY button [xx]**  
Press to change the display mode.

**7 CLOCK button [xx]**  
Press to display the current day of the week and time.

**8 EXT INPUT button [xx]**  
Press to select the input source.  
With each press of the button, the input source switches in the order of DIGITAL 1, DIGITAL 2, and ANALOG.

**9 OPERATION buttons [xx]**  
**CD:** Turns the operation mode into the CD mode.  
**HDD:** Turns the operation mode into the HDD mode.

**10 HDD REC button [xx]**  
Press to enter the recording standby state. Then press again to select the target recording group.

**11 REC MODE button [xx]**  
Press to select the recording mode.  
With each press of the button, the recording mode switches in the order of PCM, MP3 96Kbps, MP3 128Kbps, and MP3 192Kbps.

**12 ► / || (play/pause) button [xx]**  
Press to start playing or recording. Pressing this button while playing or recording, the MB-S1 pauses. Press the button again to resume playing or recording.

**13 ■ (stop) button [xx]**  
Press to stop playing or recording.

**14 ◀▶/▶▶ button [xx]**  
While playing, press to jump to beginning of the current track and the next track respectively. While stopped, press to select the track you want to play.

**15 RANDOM button [xx]**  
When you want to play tracks in random order, press this button to set the random play. The "RANDOM ON" lights in the display area.

**16 REPEAT button [xx]**  
When you want to play a track or tracks repeatedly, use this button to select the repeat playback mode.

**17 PLAY MODE button [xx]**  
Press to switch the playback mode.  
**ALBUM:** Displays the album information.  
**ARTISTS:** Displays the artist information.  
**GENRE:** Displays the genre information.  
**DATE:** Displays the date information.  
**GROUP:** Displays the group information.  
**PLAYLIST:** Displays the play list information.

## Parts names and functions

The numbers within the brackets are the pages where the part or function is introduced.

### ⑱ ADD TO PLAY LIST button [xx]

Press to add the current track to the play list.

### ⑲ SELECT button [xx]

Select the track using ▼ / ▲ buttons.

### ⑳ Alphabetic letters/Symbols/Numeric (1 to 10) buttons [xx]

**Numeric:** Press to select the track you want to play.

**Alphabetic letters/SYMBOL/Numeric:** Press to enter the name of the disk, artist or track.

**CLEAR:** Press to cancel the letter.

**ENTER:** Press to enter and confirm the letter while editing the disc, artist, or track names.

**TEXT:** Press to enable editing the disc, artists, or track names.

### ㉑ FAVORITE IT button [xx]

Press to mark the current track as your favorite. Press again to unmark the track.

### ㉒ FAVORITE MODE button [xx]

Press to turn the favorite mode on and off. In the favorite mode, only the tracks marked as your favorite are played.

### ㉓ Genre buttons [xx]

Press to select the genre for playing the tracks registered with respective genres.

## Rear panel

The numbers within the brackets are the pages where the part or function is introduced.

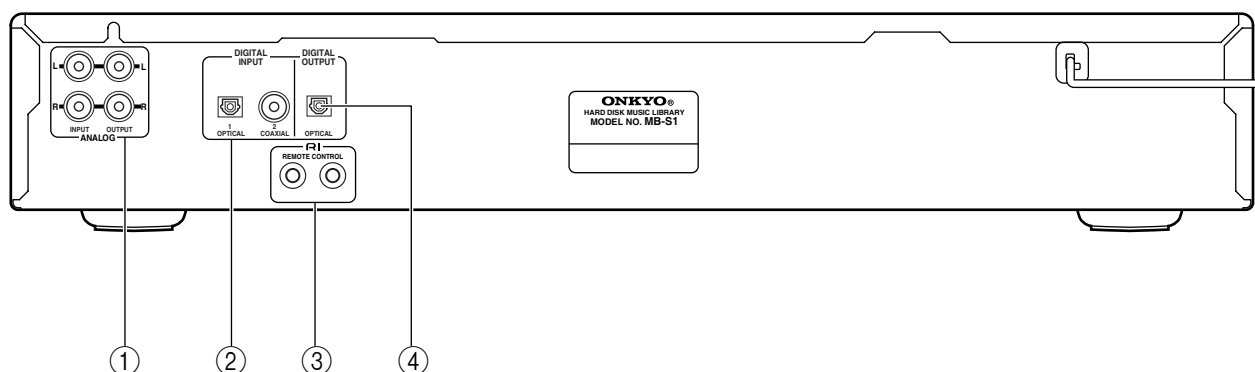

### ① Analog input/output terminals (ANALOG) [xx]

Connect the analog devices such as tuner or cassette deck, and the analog output from the digital devices such as CD player and others.

### ② Digital input terminals (DIGITAL INPUT) [xx]

Connect the digital output from the digital devices such as CD player, DVD player, MD player and others. Optical (OPTICAL) and coaxial (COAXIAL) terminals are available.

### ③ RI connection terminals (RI REMOTE CONTROL) [xx]

Connect the Onkyo products equipped with the RI connection terminals.

### ④ Digital output terminal (DIGITAL OUTPUT) [xx]

Connects the digital output from the MB-S1 to the digital input terminals on the digital recording devices such as MD recorder, CD recorder and DAT deck.

Under the SCMS and SDMI Water Mark\* copyright protection system, the output signal is limited to the AUDIO-CD signal from the CD-ROM played or the audio signal of MP3 data recorded on CD-ROM.

#### Note

The audio signal recorded on the MB-S1's hard disk drive is not output digitally.

\* SCMS and SDMI are a copy guard system for protecting copyright. See page 17 for details.

# Connecting the MB-S1

Here is an explanation of how to connect the main components to the MB-S1 in the standard manner. There are many ways that any one component can be connected, and it is up to you to decide which method best fits your situation. The directions given here are only one option and should only be thought of as such. It is best to fully understand the nature of each connector and terminal as well as each of your components and their features to ascertain which method of connection is best.

- Be sure to always refer to the instructions that came with the component that you are connecting.
- Do not plug in the power cord until all connections have been made.
- For input jacks, red connectors (marked R) are used for the right channel, and white connectors (marked L) are used for the left channel.
- Do not bind audio/video connection cables with power cords and speaker cables. Doing so may adversely affect the picture and sound quality.
- When using the digital inputs, make sure to also connect the analog connections whenever possible.

- Insert all plugs and connectors securely. Improper connections can result in noise, poor performance, or damage to the equipment.

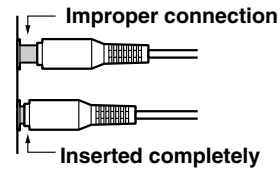

- When using one of the optical input jacks, remove the protective cap and keep it safely. When the jack is not used, replace the protective cap.
- When using an optical input jack, always use an optical fiber cable.

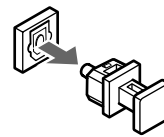

### Optical digital input terminal

An optical digital input terminal is equipped with a protection cap. When connecting, remove this cap. When not using, put the cap back on the terminal.

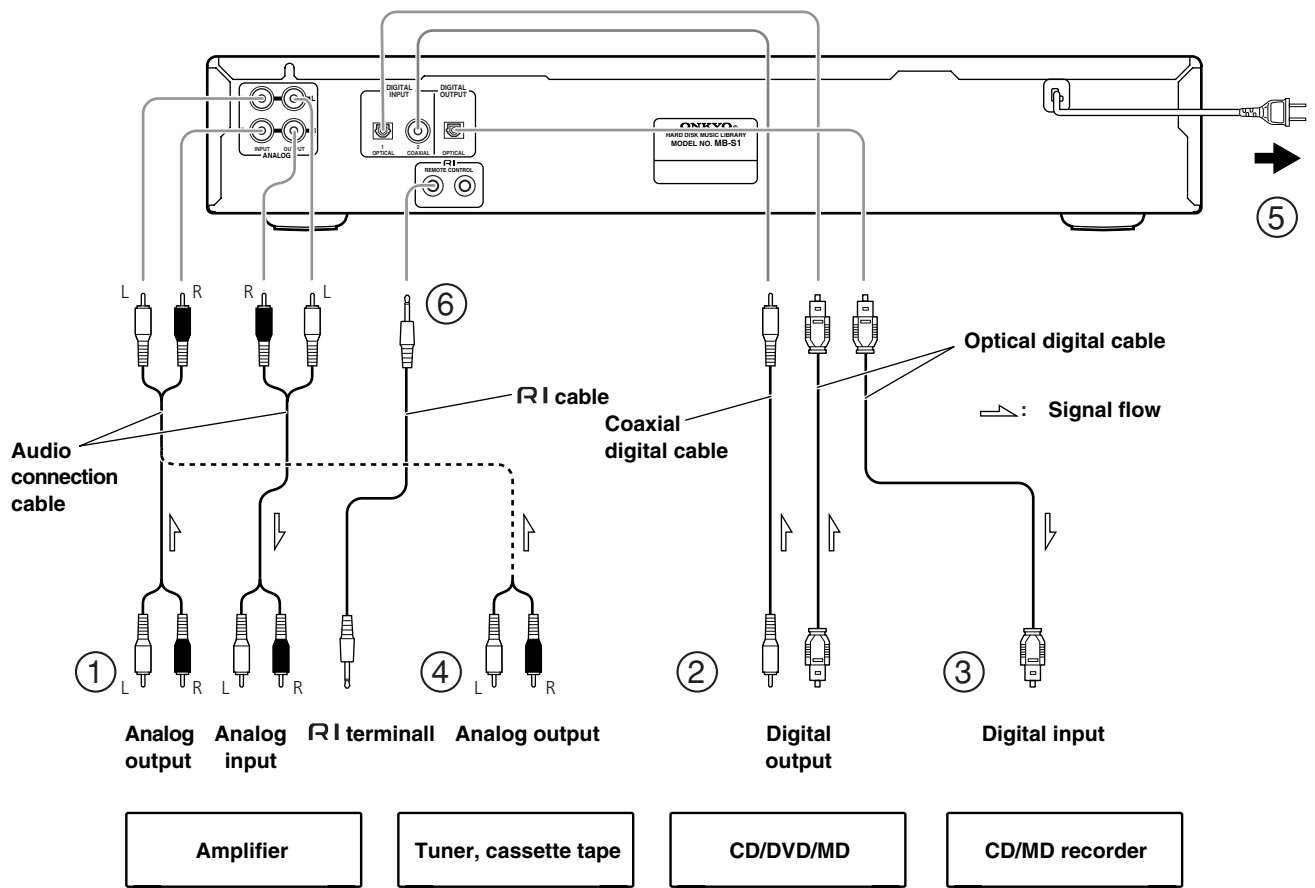

# Connecting the MB-S1

## Connecting to other components

Here is detailed explanation of how to connect the main components to the MB-S1. When connecting, refer to the diagram on page 14.

### 1. Connecting to an amplifier

Connect the analog terminals on the MB-S1 to the CD, TAPE, or MD terminal on the amplifier.

#### Notice:

When you connect the MB-S1 to the Onkyo TX-L5, use the HD terminal on the rear panel of the TX-L5

### 2. Connecting an external CD or DVD player

When connecting a CD player, DVD player, CS tuner, or DAT deck equipped with digital output terminals (OPTICAL/COAXIAL), you can record the input source digitally using the MB-S1.

Connect the digital output terminals on a CD player, DVD player or others to the DIGITAL INPUT (OPTICAL/COAXIAL) terminals using audio digital cables. Use the optical digital cable for OPTICAL terminal and the coaxial digital cable for COAXIAL terminal.

When connecting devices, be sure to use the optical digital cable commercially available.

### 3. Connecting a digital audio recorder such as MD recorder or CD recorder

When connecting a CD recorder, MD recorder or DAT deck equipped with digital input terminals (OPTICAL), you can perform digital recording on the external digital audio recorder.

Connect the DIGITAL OUTPUT terminal (OPTCAL) on the MB-S1 to the digital audio recorder such as CD recorder or MD recorder. Use an optical digital audio cable.

When connecting devices, be sure to use an optical digital cable commercially available.

#### Notes

- When you copy the audio source digitally, certain restrictions will be applied. (page 14)
- Do not bundle the audio cables together with power cords or speaker cables. Doing so may cause deterioration of the audio signal.
- When you place the MB-S1 near a TV, the picture on the TV may become poor and the output sound from the MB-S1 may be distorted. In this case, place the unit away from the TV.
- When you connect the digital audio output on a DVD player to the DIGITAL INPUT terminals on the MB-S1, set the output type to PCM on the DVD player. However, the PCM output setting is not available on some DVD players. In this case, the audio signal will not be output even if the DVD player and the MB-S1 are connected.

### 4. Connecting an analog audio device such as AM/FM tuner or cassette tape deck

When connecting the audio output from an analog audio device such as AM/FM tuner, cassette tape deck, or video deck to the MB-S1, you can record the audio signal onto the HDD.

Connect the analog output terminals on the analog audio device to the ANALOG INPUT terminal on the MB-S1.

#### Notes:

- Insert the plugs and connectors securely. Remember that improper connection can result in noise, or malfunctions.
- Do not bundle the audio cables together with power cords or speaker cables. Doing so may cause deterioration of the audio signal.
- When you place the MB-S1 near a TV, the picture on the TV may become poor and the output sound from the MB-S1 may be distorted. In this case, place the unit away from the TV.

### 5. Connecting the power cord

Plug the power cord into a wall outlet.

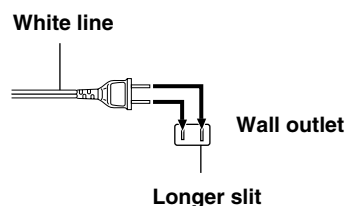

#### Note:

#### For better sound quality

The power cable of the MB-S1 has polarity. Insert the plug matching the side with white line to the longer slit on the wall outlet.

After connecting the power cable, the MB-S1 enters the standby state.

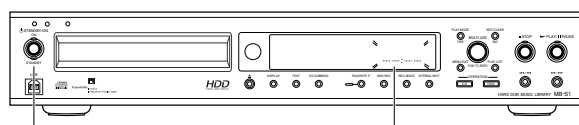

“STANDBY”  
indication lights.

The date indication  
blinks.

### 6. Connecting the Onkyo products equipped with RI terminals

With Onkyo components that are equipped with a RI terminal, use the supplied RI cable to connect the RI terminal to the RI terminal of the MB-S1.

The RI terminals are only effective if they are used in conjunction with an Onkyo amplifier with a RI connector. Do not connect to a component other than an Onkyo component with a RI connector. Doing so may damage the MB-S1.

The functions of the left and right RI terminals are the same. Connect to either one.

Connecting the RI cable only does not make the system operational. You must also connect the audio cables as well.

# Notes on CD and the internal hard disk drive

## Notes on discs

### ■ Notes on playing discs

Use the discs compatible with IEC standards such as the CD with the logo (right) printed on it. You can also use the CD-ROM containing MP3 audio data.



Do not play CD-ROMs intended for computer use or non-audio compact discs. Doing so may cause high-pitched noises or other unpredictable results that may damage speakers, amplifiers, and other connected components.

Never use heart-shaped, octagonal, or other special shaped discs as they may damage the internal mechanisms of the MB-S1.



### ■ Handling discs

Be careful not to touch the data side of the disc (the side that does not have printing on it). Always hold discs by the edges or by using the hole in the middle.

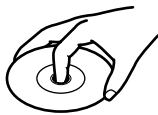

Never place labels or stickers on the data side or label side of the discs. Also, do not write on the discs or allow them to become scratched.

### ■ Cautions when using rented compact discs

Do not use discs that have cellophane tape attached to them or rental compact discs that have rental labels attached. If the tape is sticking out or peeling off, the disc may not be able to be ejected and the MB-S1 may become damaged.

### ■ Cleaning

Dirt and contaminants on discs can obstruct the pickup of the signals and lead to deterioration the sound. When dirty, clean the data side with a soft dry cloth, wiping from the inside of the disc toward the outside.

If the dirt is excessive, soak the cloth in water, wring it out, and then wipe the disc surface clean. Next, using a soft dry cloth, wipe the moisture from the disc surface. Do not use conventional record cleaners or antistatic agents. Also, never use benzene, thinners, or other volatile agents as they may damage the disc surface.



### ■ Cautions for disc storage

Do not store discs in locations exposed to direct sunlight, near heat emitting devices, and other locations of excessive heat, or locations of extremely low temperatures. Also, always store discs properly in their protective cases.

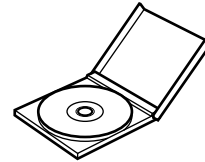

### Note on the internal hard disc drive

■ Do not shake or carry around the MB-S1 while playing the tracks recorded on the hard disc drive. Doing so may damage the internal hard disc drive.

### Condensation

When moving the MB-S1 from a cold location to a hot location, when quickly heating a cold location with a furnace, or other similar situation, condensation may occur. This may not only cause improper operation of the device, but may also damage the discs and components. If condensation has occurred, turn on the MB-S1 and leave it running for 1 to 2 hours. If you will not use the MB-S1, then eject any disc inside.

# Rules for recording digital input

The digital source connected to the MB-S1 is protected by copy guard systems.

These limitations are intended for protecting the copyright and restricting the behavior which violates the copyright.

## SCMS (Guide to the serial copy management system)

This system is designed for permitting only one generation of digital-to-digital copying (the recording of the original digital signals as they are) between digital audio devices.

- The digital signals recorded on MD, DAT, CD-R, or CD-RW from the digital input terminals on the MB-S1 cannot be recorded on any other media digitally. Here are the examples when performing digital recording in MD recorder.

1. When the digital audio data from the MB-S1 is recorded as analog input source on a MD using MD recorder, the digital signal on the MD can be recorded digitally onto another MD.

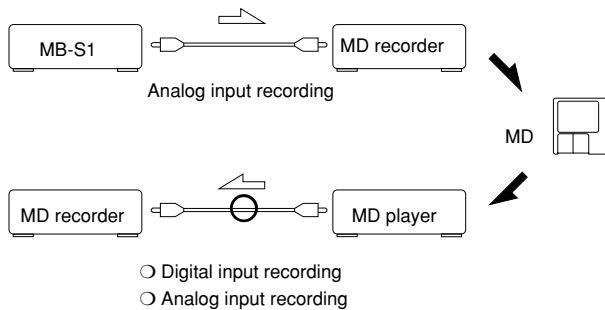

2. When the digital audio data from the MB-S1 is recorded as digital input source on a MD using MD recorder, the digital signal on the MD cannot be recorded digitally onto another MD. If you want to record the digital signal on the MD, perform analog input recording.

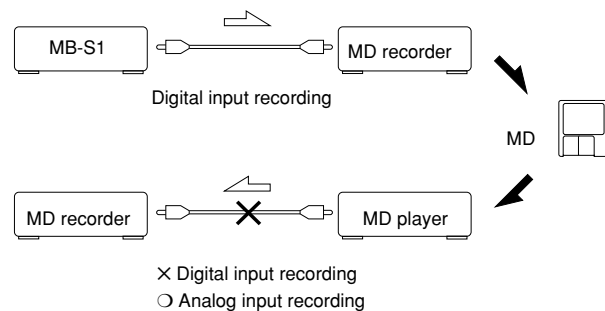

### Note:

For media or music performance including radio program, CD, record, music tape, and original music cassette, music elements of lyrics and melodies are equally protected by the copyright law. Therefore, to sell, transfer, distribute, and lease those music media above, and use them as BGM in public space such as stores are prohibited.

- The digital audio source recorded on a media such as CD, MD or DAT can be connected directly to the digital input terminals on the MB-S1.

However, if the input digital signal to the MB-S1 is digitally recorded from the digital source, you can not record this digital input signal. Also, you can not monitor this digital input signal as a digital input source.

1. The digital audio signal on CD-R/RW recorded digitally from the CD can not be copied to the MB-S1's HDD. When you record such digital signals, connect the signals to the analog input terminals.

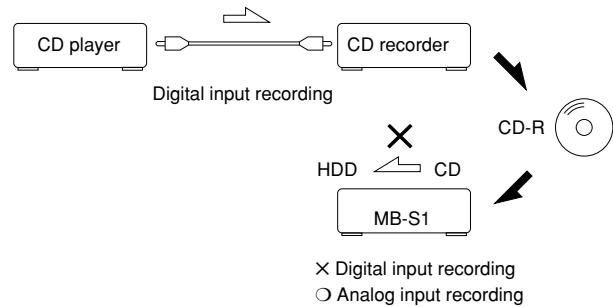

2. When the digital audio signal on CD was recorded from MD as analog input source, you can record the audio signal on CD digitally from digital input terminals on the MB-S1.

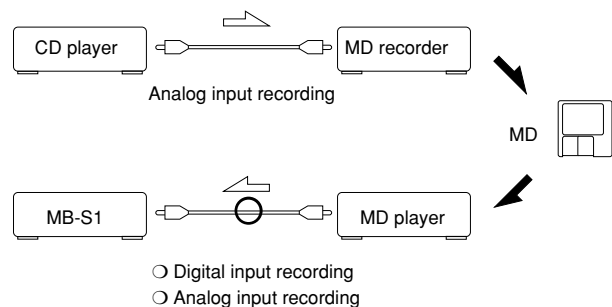

## SDMI (Secure Digital Music Initiative) WM

The MB-S1 supports the data with the Water Mark which conforms to the SDMI standards.

This water mark is designed for copy control, and some discs contains the water mark can not be duplicated.

SDMI is a project for establishing formats which allows secure music distribution and sales over Internet. The project is co-founded by RIAA and five companies from U.S. music industry.

The materials you recorded using the MB-S1 are for private use only. Under the copyright law, you can not use recorded materials without permission from the copyright holder.

# Understanding the basic operations before using the MB-S1

The MB-S1 allows you to play audio CDs or CD-R discs containing MP3 music files just like ordinary CD players. In addition, the MB-S1 can store the music data on its hard disk drive (HDD), allowing you to enjoy the various playback functions such as long-hour playback or play list playback.

## ■ Managing the music information on the MB-S1

The MB-S1 manages the music information in groups and tracks.

The number of group and track is shown on the display when the "GROUP" indicator lights.

When using the MB-S1 for playing CDs, only the number of group and track is displayed and you can select the tracks according to the group or the track number. When using or playing the tracks recorded on the MB-S1's HDD, the various music information is available, including the name of album and artist, genre, date, and favorite marking, as well as the number of group and track. Registering additional track information enables you to sort the track, play only the favorite tracks, display the tracks information and select the track according to the track information.

## ■ Typical uses for the MB-S1

### 1. Playing an audio CD with the CD player section.

For more information, see "Understanding playing features for the CD player section" on this page and "Listening to an audio CD or CD-ROM" on pages 19 and 20.

### 2. Playing a CD-R containing MP3 music files with the CD player section.

For more information, see "Understanding playing features for the CD player section" on this page and "Listening to an audio CD or CD-ROM" on pages 19 and 20.

### 3. Recording tracks from the CD player section onto the internal HDD and playing them.

For more information, see "Understanding playing features for the internal HDD section" on this page, and "Recording" and "Listening to tracks recorded on the HDD" on pages 21-26.

### 4. Recording tracks from the external component such as MD player to the HDD and playing them.

For more information, see "Understanding playing features for the internal HDD section" on this page, "Connecting the MB-S1" on page 16, and "Recording" and "Listening to tracks recorded on the HDD" on pages 21-26.

### 5. Transferring MP3 files from the PC to the MB-S1 and playing them.

For more information, see "Understanding playing features for the internal HDD section" on this page, "Listening to tracks recorded on the HDD" on pages 25 and 26, and "Overview of the supplied Carry Tunes software" on page 45.

### 6. Playing tracks on the HDD using a play list.

For more information, see "Understanding playing features for the internal HDD section" on this page, "Understanding the play list" on the next page, "Listening to tracks recorded on the HDD" on pages 25 and 26, and creating and using a play list on pages 31-37.

## ■ Understanding playing features for the CD player section

The CD player section of the MB-S1 allows you to play audio CDs and CD-R discs containing music files encoded in PCM or MP3 format.

You can select and play the track by the group or the track number. Use the MULTI JOG dial to select a group and the ◀◀/▶▶ buttons to select a track number.

#### • When playing an audio CD

One CD = One group/

The total tracks on the CD = The number of tracks

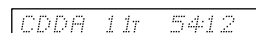

The number of tracks

#### • When playing a CD-R containing MP3 files

The number of folders on the CD-R = The group number/

The number of files in each folder = The number of tracks



The number of groups      The number of tracks

\* Sorting track order, random playback, and MP3 file tag information is not available for the CD player section. If you want to use these features, the tracks on CD or CD-R are required to be recorded onto the internal HDD.

## ■ Understanding playing features for the internal HDD section

In the HDD section of the MB-S1, you can record the input source from the CD player section and the external component such as MD player, and transfer the tracks from PC to the MB-S1 and play them.

\* For the tracks not containing the album title, artist name, genre, date or favorite marking, you cannot use the sort feature with the ALBUM, ARTIST, GENRE or DATE button and the favorite track playback feature. In this case, the tracks will be sorted and played by group and the track number.

\* When you create or edit the play list, you select the tracks by group and track number. For more information on play list, see "Understanding Play List."



# Understanding the basic operations before using the MB-S1

## ■ Understanding the play list

You can create a play list compiled by choosing your favorite tracks from those on the HDD. You can also name the play list and easily switch the play list when playing.

The track information registered in the play list is just a reference to the actual track information stored on the HDD. Therefore, editing or deleting a play list will not change or delete the track information stored on the HDD. If the track in a play list contains additional information such as album title and others, the additional information will be displayed when selecting or playing tracks.

For more information on creating and using a play list, see pages 31-37.

\* You can create up to 100 play lists.

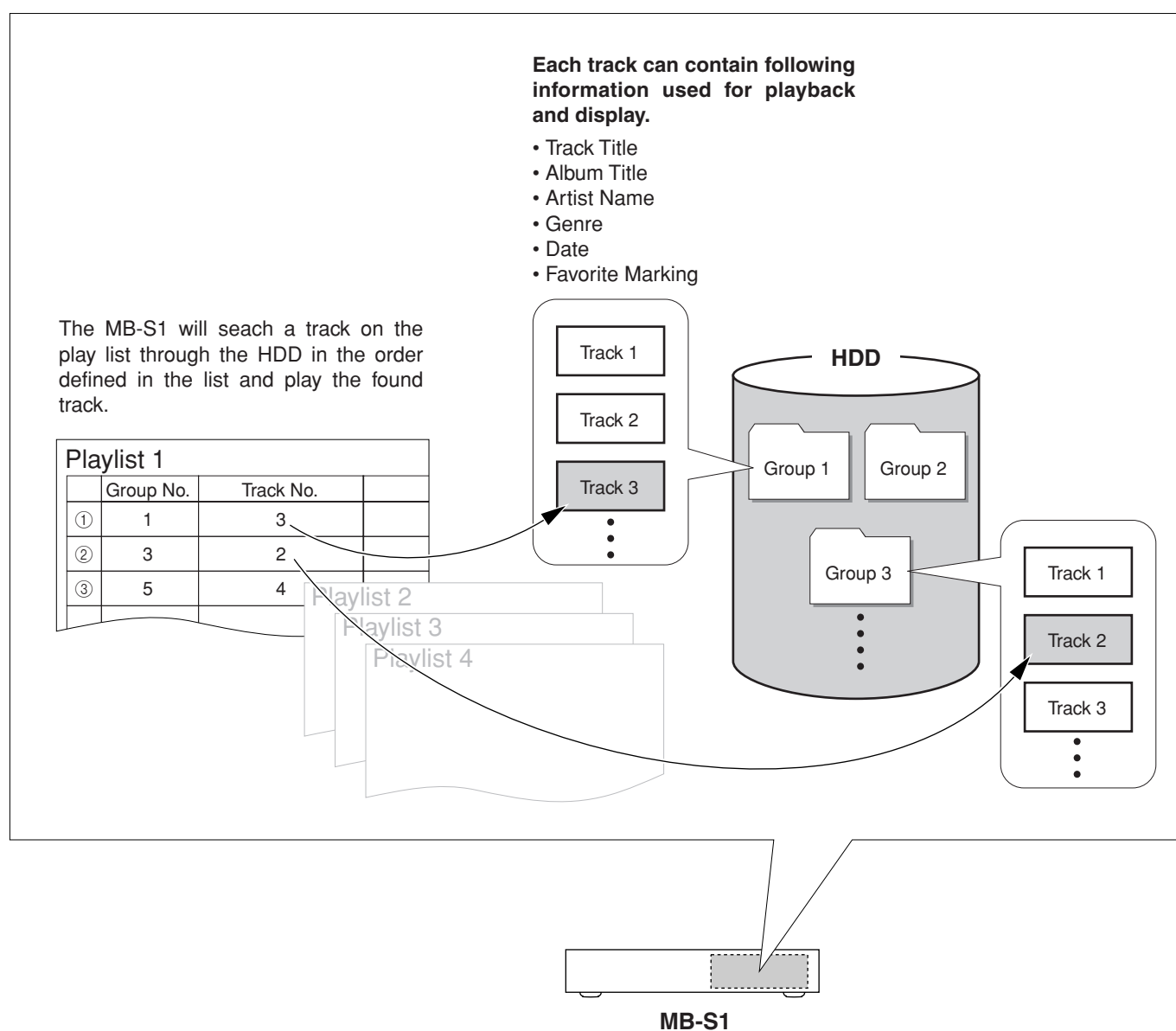

# Understanding the basic operations before using the MB-S1

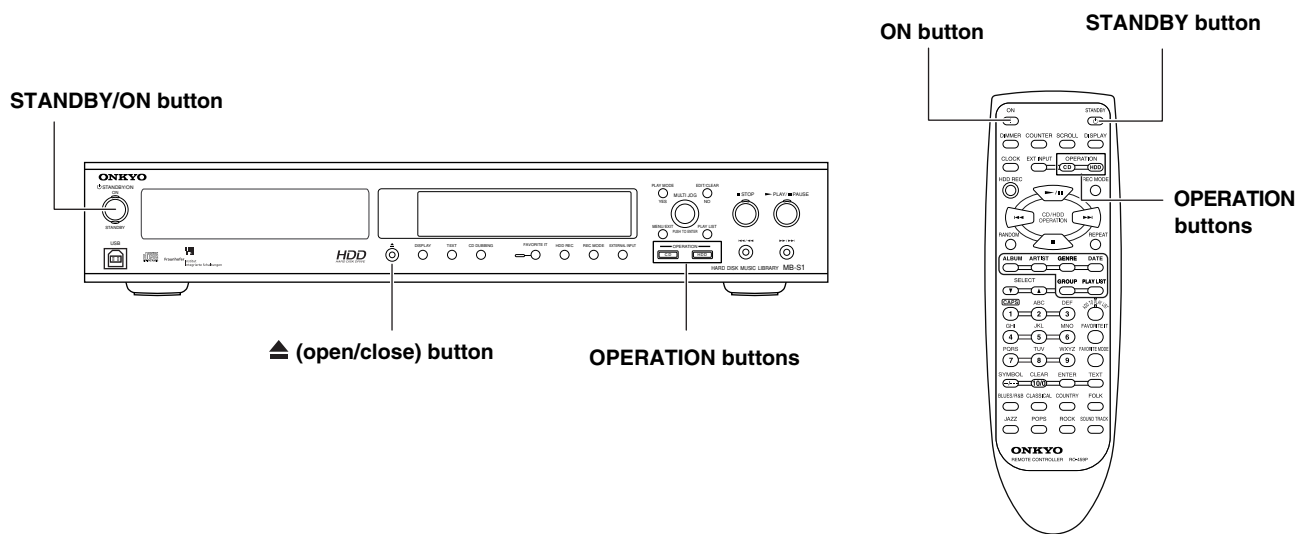

## Turning on the power

Press the STANDBY/ON button on the MB-S1 to turn on the power. Pressing it again causes the MB-S1 to enter the standby state. When using the remote controller, pressing the ON button turns on the power and pressing the STANDBY button causes the MB-S1 to enter the standby state.

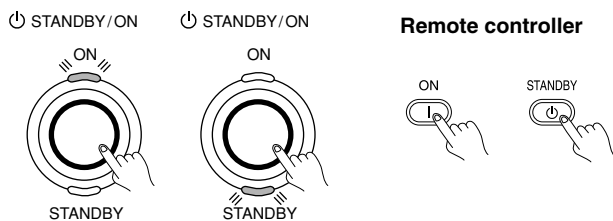

**Standby state:** The state that the current time is displayed in the display area. If you have not set the current time, "-- : --" is displayed (see the next page).

**Power-on state:** The state that the STANDBY/ON button on the MB-S1 or the ON button on the remote controller is pressed during the standby state. In the power-on state, you can operate the MB-S1. After pressing the button, "HDD MUSIC LIBRARY" indication scrolls in the display area. Then, the number of groups and the total recorded time for tracks on the HDD is displayed, and the same mode indicators lights as when the MB-S1 turned on last time. When the CD mode is active, "Reading Media" is displayed in the display area and loading CD starts. After the CD loading process has finished, the number of groups and tracks, and the total recorded time for the CD.

When the HDD section is activated, the same group indication lights as when the MB-S1 turned on last time.

## Switching the CD player and HDD

The MB-S1 can play the tracks on an audio CD or a CD-ROM containing music files as well as the tracks recorded on the hard disk drive (HDD). To switch the playing source, use the OPERATION buttons.

Pressing the CD button activates the CD player, and the MB-S1 enters the CD mode. The CD, ■ STOP, and ► PLAY/■ PAUSE indicators light in orange. In the CD mode, you can play audio CDs and CD-ROM discs using the buttons on the MB-S1 or remote controller.



Pressing the HDD button activates the HDD section, and the MB-S1 enters the HDD mode. The HDD, ■ STOP, and ► PLAY/■ PAUSE indicators light in green. In the HDD mode, you can play the music files recorded on the internal HDD.

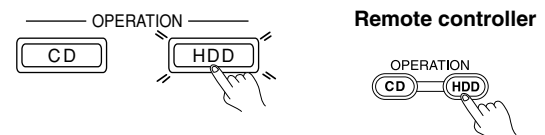

## Opening the CD tray



Press ▲ (open/close) button on the MB-S1 to open the CD tray.

### Note:

For few seconds immediately after the power is turned on, pressing any button will do nothing. Remember to operate the MB-S1 after the loaded information is displayed.

# Setting date and time

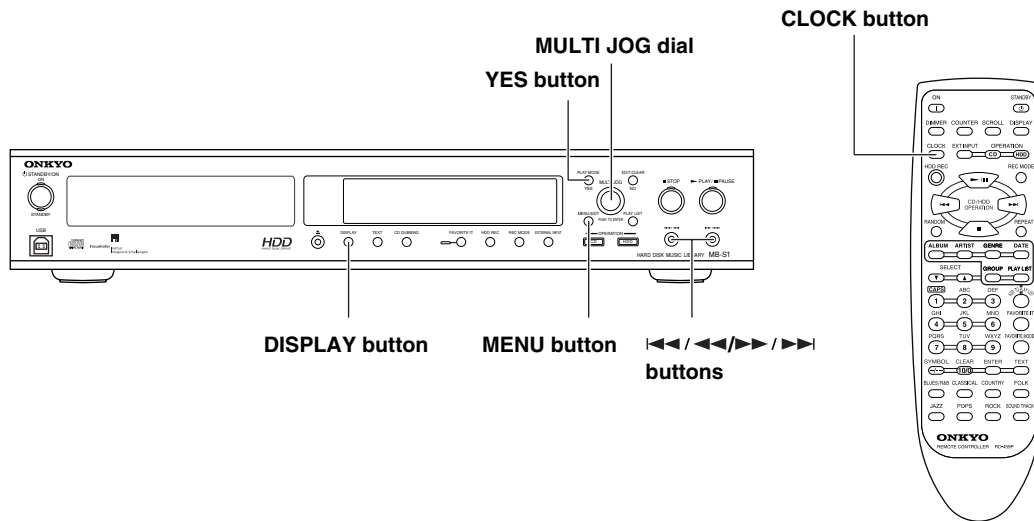

## Setting date and time

### 1. Call the menu mode.

MENU/EXIT



Pressing the MENU/EXIT button displays the menu items in the display area.

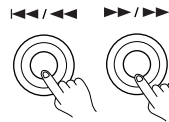

Set the month, day, hour and minute using the same procedure above. The day of the week will be automatically set.

You can highlight any item (year, month, day, hour, and minute) to set them using the navigation buttons.

### 2. Select the clock setting menu.

MULTI JOG



PUSH TO ENTER

Rotate the MULTI JOG dial to select the clock setting menu ("Clock Setting?").

The menu items are displayed in the following order: Clock Setting?, Timer Setting?, REC LEVEL?.

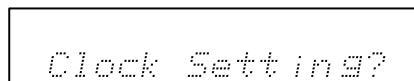

### 3. Confirm the setting.

PLAY MODE



Press the YES button to confirm the setting. The second is displayed and the clock starts.

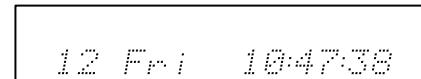

### 4. Restore the normal indication.

Press the MENU/EXIT button or ■ STOP button.

### Displaying the date and time (Remote controller only).

Press the CLOCK button on the remote controller. With each press of the CLOCK button, the displayed information changes as follows.

### 3. Set the date and time.

MULTI JOG



PUSH TO ENTER

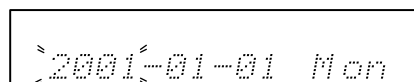

Rotate the MULTI JOG dial to select the year.

MULTI JOG

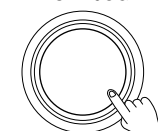

PUSH TO ENTER

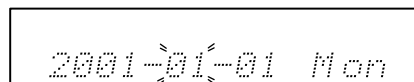

Press the MULTI JOG dial to enter the year. The highlight moves to the month.

Remote controller

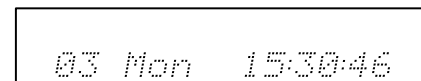
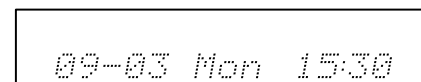
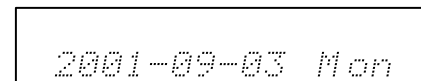

Press the ■ STOP button to restore the normal indication.

# Listening to an audio CD or CD-ROM

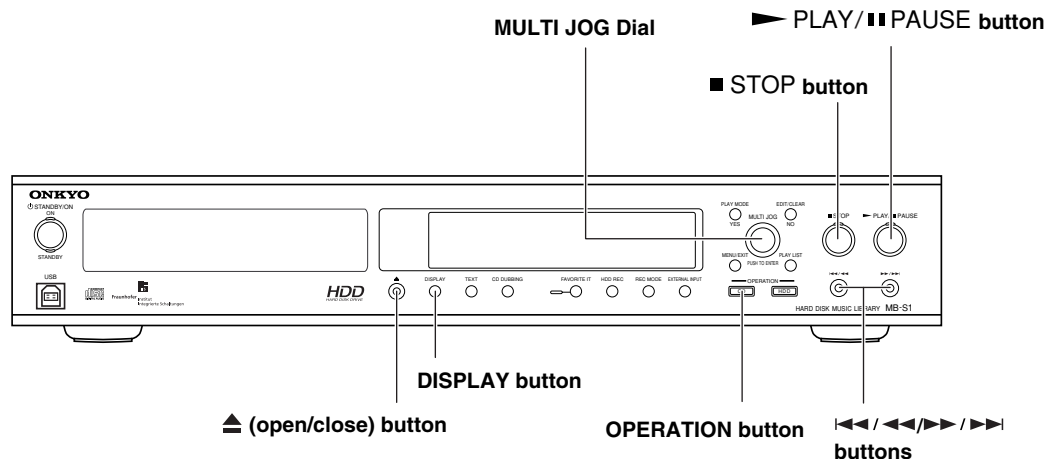

## Listening to an audio CD or CD-ROM

### 1. Set a disc.



Press **(open/close) button** to open the CD tray. Place the disc on the tray with the label facing upward.

If you set the single-sized CD, place it on the inner well.

Press **(open/close) button** to close the tray.

### 2 Activate the CD player section.

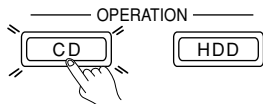

Press the CD button.

### 3. Start playing.

#### ▶ PLAY/PAUSE



Press the **▶ PLAY/PAUSE** button. **CD** lights in the display area and playback starts.

When playback finishes, the CD player automatically stops.

Pressing the **▶ PLAY/PAUSE** button while playing pauses the playback and **CD** lights. Pressing it again resumes playback from the position where the playback paused.

## Stopping playback

#### ■ STOP

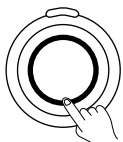

Press **■ STOP** button. Pressing the **▶ PLAY/PAUSE** button starts playback from the beginning of the track which was played when the **■ STOP** button was pressed. Pressing the **■ STOP** button twice, the first track information is displayed and the playback stops.

## Selecting the track

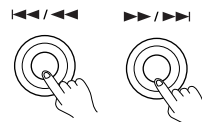

While playing or pausing, pressing the **◀◀/▶▶** button locates the beginning of the current track, and pressing it twice locates the beginning of the previous track. Then each press of the **◀◀/▶▶** button locates the beginning of another previous track.

Each press of the **▶▶/▶▶** button carries you to the beginning of the next track.

## Rewinding and fast forwarding

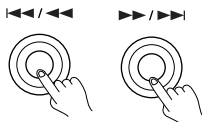

During playback, hold down the **◀◀/▶▶** or **▶▶/▶▶** button to rewind or fast forward the current track. At first, rewind and fast forward is eight times faster than normal speed playback, and then will be sixteen times faster.

Press the **▶ PLAY/PAUSE** button where you want to start playback again. When rewinding, the MB-S1 locates the beginning of the track where you pressed the **▶ PLAY/PAUSE** button and starts playback. When fast forwarding, the MB-S1 locates the beginning of the next track where you pressed the **▶ PLAY/PAUSE** button and starts playback.

## Playing tracks repeatedly (remote controller only)

Pressing the REPEAT button on the remote controller displays the current setting of the repeat playback. Each press of the REPEAT button switches the repeat playback mode in the following order: REPEAT ALL, REPEAT 1, REPEAT OFF.

#### Remote controller



**REPEAT ALL:** Plays all the tracks on a CD repeatedly. When you select this mode, "REPEAT ALL" indicator lights.

**REPEAT 1:** Plays the current track repeatedly. When you select this mode, "REPEAT 1" indicator lights.

**REPEAT OFF:** Turns off the repeat playback mode.

# Listening to an audio CD or CD-ROM

## Switching the display information

Each press of the COUNTER button on the remote controller switches the information displayed in the display area.

### During stopped

Playing time for the first track on the CD

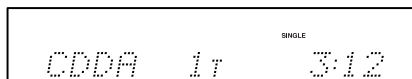

### During paused, or playing

The elapsed time for the currently played track

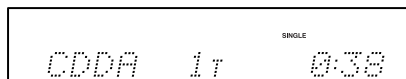

The total track number and the total playing time for the CD

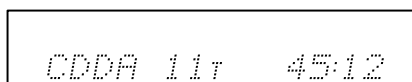

The remaining time for the currently played track

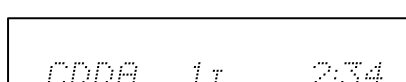

### When the disc title is longer than the display area

When you play the CD which contains text data, press the SCROLL button on the remote controller to display the whole title sequentially.

## Using the remote controller

**Switches to the clock display.**

**Selects the track you want to listen.**

While playing or paused, press the ◀◀ button once to locate the beginning of the current track. Press this button twice to locate the beginning of the previous track and additional press of the button locates the beginning of another previous track. While playing or paused, press the ▶▶ button to locate the beginning of the next track. Then, each press of this button locates the beginning of another next track.

**Selects a group when listening to a CD.**

**Plays a track by directly entering the track number.**

Pressing the **10/0** button selects the digit you are entering.

The **10/0** button enters 10 or 0.

Example:

Track Number	The button to be pressed
8	<b>8</b>
10	<b>10/0</b>
34	<b>10/0</b> , <b>3</b> , <b>4</b>

**Changes the brightness of the display area.\***

**Switches the displayed information in the display area.**

**Scrolls to display the whole disc title longer than the display area.**

**Activates the CD player section.**

**Starts playing or pauses a track.** Press the ▶ **PLAY/|| PAUSE** button to start playing a track. While playing, press the ▶ **PLAY/|| PAUSE** button to pause playback.

**Stops playback.**

**Plays tracks repeatedly (see page 19).**

\* Changing the brightness of the display area

Each press of the DIMMER button changes the brightness of the display area in the following order from the above:

The display area is slightly dimmed. → The display area is dimmed. → The display area is dimmed and indicators other than the ON indicator on the front panel are turned off. → The display area is turned on and all indicators light.

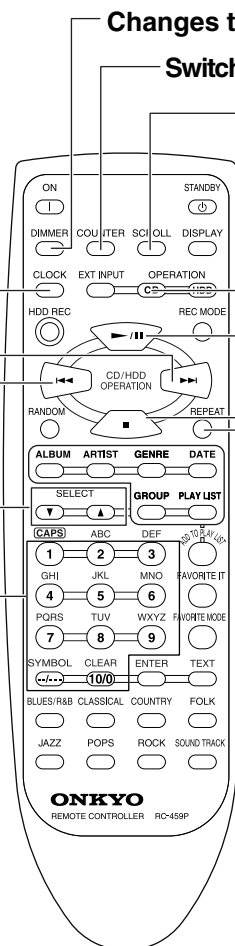

# Recording

## Notice:

Available recording modes and speeds depend on the data or format for recording source. For more information, see table on page 24.

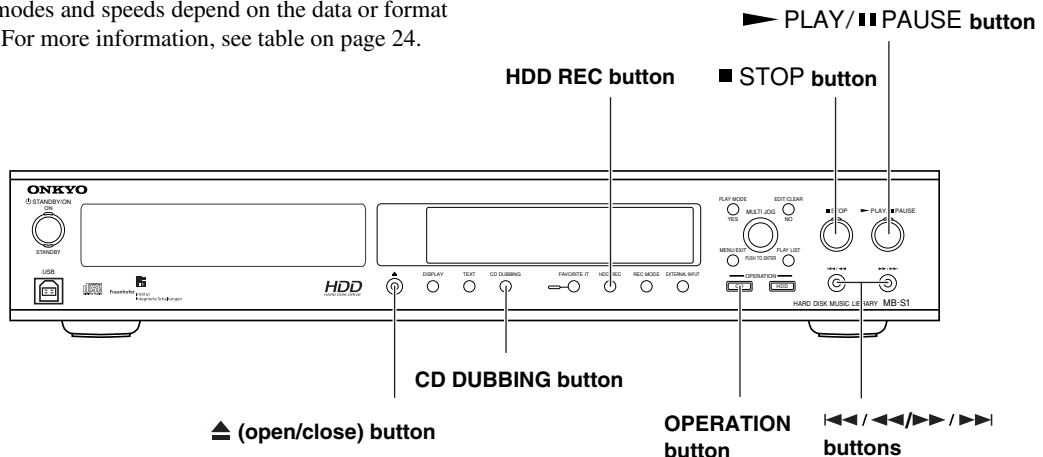

### Recording an audio CD or CD-ROM synchronously

#### 1. Set the CD on the CD tray.



For setting the CD, see page 19.

#### 2. Activate the CD player.

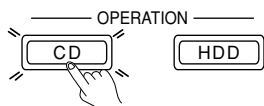

Press the CD button.

#### 3. Select a recording mode.

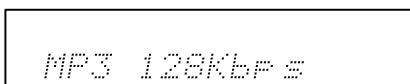

Press the REC MODE button to select the desired recording mode. The recording mode switches to the next one with each press of the button.

**PCM:** Records the signal on CD without compression. You will get better sound quality than MP3 formats, but the size of music files is larger, occupying more space on the HDD.

**MP3 96Kbps:** The size of music files will be 3/4 of those recorded in 128Kbps, and you can store more files on the HDD.

**MP3 128Kbps:** The size of music files will be 1/10 of those recorded in PCM mode.

**MP3 192Kbps:** The size of music files will be 1.5 times larger than those recorded in 128Kbps. You can store fewer files on the HDD, but will get better sound quality than 96Kbps and 128Kbps.

#### 4. Put the MB-S1 into the recording standby state.



Press the HDD REC button. The MB-S1 enters the CD synchronous recording standby state. The display area will change to

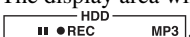

#### 5. Select a target group for recording.



Press the HDD REC button again to select a target group for recording. You can select **CURRENT** or **NEW** for the target group.

**CURRENT:** The new recording will be added to the end of the existing group containing recorded tracks.

**NEW:** The new recording will be recorded as a first track for a new group.



#### 6. Start recording.

▶ PLAY/|| PAUSE

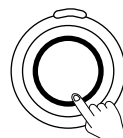

Press the ▶ PLAY/|| PAUSE button to start recording.

After recording until the end of the CD, the MB-S1 stops automatically.

Recording using the remote controller

### Using the remote controller

Do the following steps in numeric order.

#### 1. Activate the CD player.

#### 3. Put the MB-S1 into the recording standby state.

#### 4. Select a target group for recording.

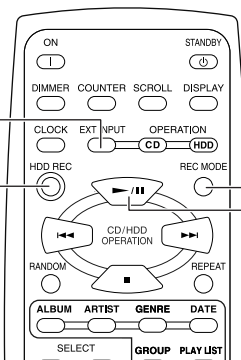

#### 2. Select a recording mode.

#### 5. Start recording

# Recording

## Dubbing all tracks on a CD (CD dubbing)

### 1. Set the CD on the CD tray.



For setting the CD, see page 19.

### 2. Stop the CD or HDD.

■ STOP

Press the ■ STOP button

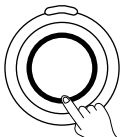

### 3. Select a recording mode

(see step 3 on the previous page).

REC MODE



MP3 128Kb/s

Press the REC MODE button to select the desired recording mode. The recording mode switches to the next one with each press of the button.

### 4. Start the CD dubbing.

CD DUBBING



Press the CD DUBBING button to start the CD dubbing. The group to which the recorded tracks will be added is automatically created to the HDD.

CD-Dubbing 3g

## Dubbing a track on a CD.

### 1. Set the CD on the CD tray.



For setting the CD, see page 19.

### 2. Activate the CD player.



Press the CD button.

### 3. Select a recording mode

(see step 3 on the previous page).

REC MODE



MP3 128Kb/s

Press the REC MODE button to select the desired recording mode. The recording mode switches to the next one with each press of the button.

### 4. Select a track you want to record.

◀◀/▶▶ ▶▶/▶▶

Press the ◀◀/▶▶ or ▶▶/▶▶ button to select a track you want to record.

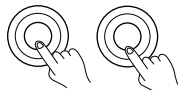

### 5. Put the MB-S1 into the recording standby state.

HDD REC



Press the HDD REC button. The MB-S1 enters the CD synchronous recording standby state. The display area will change to

■ ■ ● REC MP3

### 6. Select a target group for recording.

HDD REC



Press the HDD REC button again to select a target group for recording. You can select CURRENT or NEW for the target group.

**CURRENT:** The new recording will be added to the end of the existing group containing recorded tracks.

**NEW:** The new recording will be recorded as a first track for a new group.

### 7. Start dubbing a track on a CD.

CD DUBBING



1Tr-Dubbing 3g

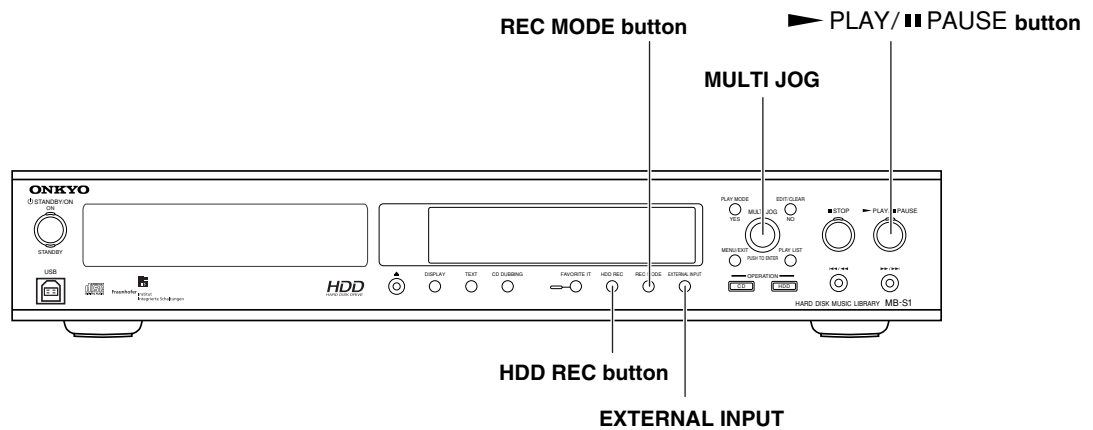

## Recording audio signals from external devices

### 1. Confirm the connections between the MB-S1 and an external device to the HDD.

For details, see “Connecting the MB-S1” on pages 11 and 12.

### 2. Select an input source.

EXTERNAL INPUT



Press the EXTERNAL INPUT button repeatedly

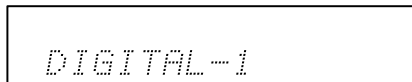

**DIGITAL-1:** When connected to the DIGITAL INPUT1 (OPTICAL) terminals

**DIGITAL-2:** When connected to the DIGITAL INPUT2 (COAXIAL) terminals

**ANALOG:** When connected to the ANALOG input terminals

### 3. Select a recording mode (see the step 3 on page 24).

REC MODE

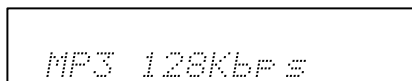

Press the REC MODE button to select the desired recording mode. The recording mode switches to the next one with each press of the button.

For more information, see table on page 27.

### 4. Put the MB-S1 into the recording standby state.

HDD REC



Press the HDD REC button. The MB-S1 enters the CD synchronous recording standby state. The display area will change to

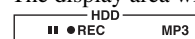

### 5. Select a target group for recording.

HDD REC



Press the HDD REC button again to select a target group for recording. You can select **CURRENT** or **NEW** for the target group.

**CURRENT:** The new recording will be added to the end of the existing group containing recorded tracks.

**NEW:** The new recording will be recorded as a first track for a new group.

### 6. Start recording.

▶ PLAY/PAUSE

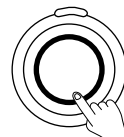

Press the ▶ PLAY/PAUSE button and start playback on the external device simultaneously.

#### Notice:

#### About maximum recording time

The maximum recording time is 18 hours per group. The recording will be separated automatically into a track every one hour.

The recording time will be displayed up to 99 hours 59 minutes 59 seconds. When the recording lasts longer than the maximum time above, the indication will be “-- : -- : --”.



# Recording

## Using the remote controller

Do the following steps in numeric order.

1. Select an input source.

3. Put the MB-S1 into the recording standby state.

4. Select a target group for recording.

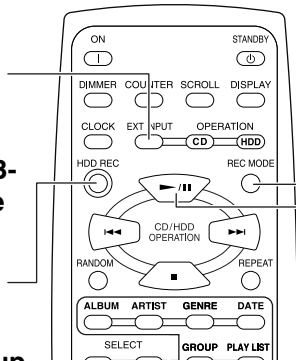

2. Select a recording mode.

5. Start recording.

### Input source and recording format

The available recording formats and speeds depend on the external device and input source as follows:

#### When recording from the CD player section of the MB-S1

Input Source	Encoding Format	Bitrate	Recording Speed	Level Adjustment
Audio CD	PCM	—	Quick Rec *2 (approximately 5X speed)	—
CD duplicated on PC *1	MP 3	96/128/192Kbps	Normal speed	Available
MP3 CD *1 (a CD-ROM containing MP3 encoded tracks)	MP 3	Same as the source track	Quick Rec *2 (approximately 20X speed)	—

\*1 Duplicated CDs and CD-ROMs containing MP3 files are limited to private use only. Duplicated CD-ROMs and CD-RWs created with an audio CD-R recorder can not be recorded on the MB-S1 under SCMS restriction.

\*2 When using Quick Rec feature, the sound is not output.

#### When recording from external audio devices

Input Source	Encoding Format	Bitrate	Recording Speed	Level Adjustment
DIGITAL-1	PCM	—	Normal speed	Available
DIGITAL-2	MP 3	96/128/192 Kbps	Normal speed	
ANALOG				

## Adjusting the recording level (Analog input only)

1. Call the menu mode.

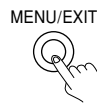

Press the MENU/EXIT button. A menu item appears in the display area.

2. Select the menu for adjusting recording level.

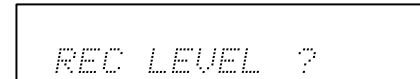
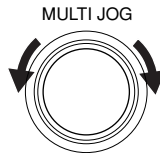

Turn the MULTI JOG dial to select "REC Level ?" and press the MULTI JOG dial to confirm. "Norm" or "Low" blinks slowly.

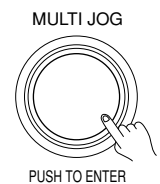

3. Select the adjusting level range.

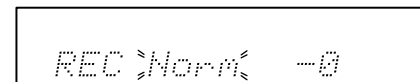
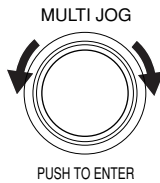

Turn the MULTI JOG dial to select the level range from "Norm" or "Low."

**Norm:** Select when you record the analog input source from the digital audio devices such as CD, DVD, or MD.

**Low:** Select when you record the analog input source with higher output level such as analog records.

After selecting the level range, press the jog dial to confirm it.

4. Adjust the recording level.

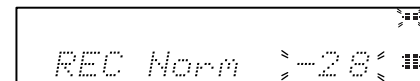
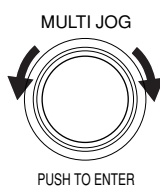

Turn the MULTI JOG dial to adjust the recording level. The recommended optimum level is the one at which the red segments for level meter lights sometimes.

5. Confirm the level setting.



Press the MULTI JOG dial to confirm the recording level setting.

# Listening to tracks recorded on the HDD

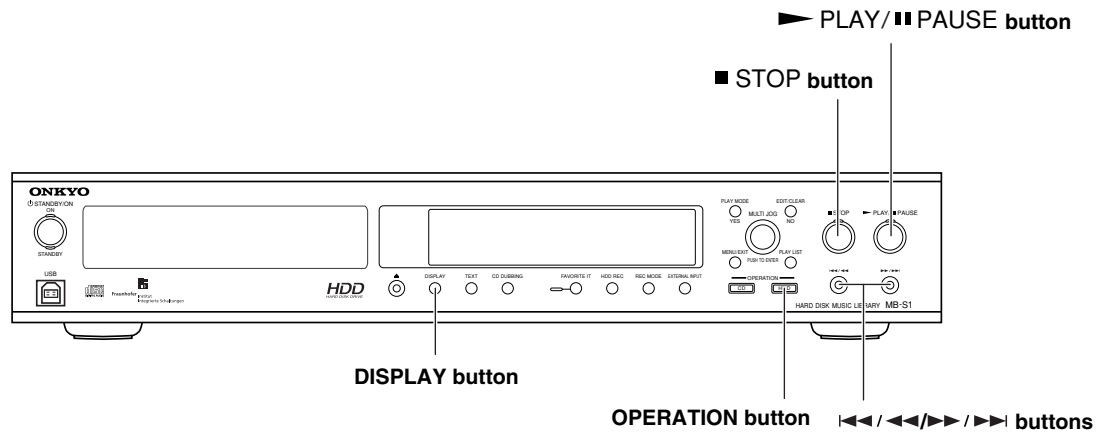

## Listening to tracks recorded on the HDD

### 1. Activate the HDD section.

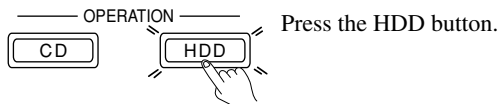

### 2. Start playback.

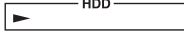
▶ PLAY/■ PAUSE Press the ▶ PLAY/■ PAUSE button to start playing from the first track in the first group.  lights in the display area.

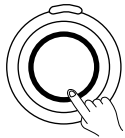

After playing the last track in the last group, the MB-S1 automatically stops.

During playback, press the ▶ PLAY/■ PAUSE button to cause the MB-S1 to pause.  lights in the display area. Press it again to resume playback from the position where you pressed the ▶ PLAY/■ PAUSE button.

## Stopping the playback.

■ STOP

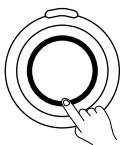

Press the ■ STOP button. During stopped, pressing the ▶ PLAY/■ PAUSE button resumes playback from the beginning of the track at which you pressed the ■ STOP button. Pressing the ■ STOP button twice locates the first track of the current group, then the MB-S1 stops.

## Selecting a track you want to listen to.

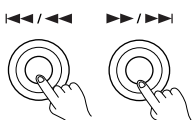

During playing or paused, pressing the ◀◀/▶▶ button once locates the beginning of the current track. Pressing the ◀◀/▶▶ button twice locates the beginning of the previous track and another press of the button locates the beginning of another previous track.

Each time you press the ▶▶/▶▶▶ button, the playback of the next track starts.

## Rewinding and fast forwarding

◀◀/▶▶ During playback, hold down the ◀◀/▶▶ or ▶▶/▶▶▶ button for 0.5 second or longer to rewind or fast forward the current track. At first, rewind and fast forward is eight times faster than normal speed playback, and then will be sixteen times faster.

Press the ▶ PLAY/■ PAUSE button where you want to resume playback in normal speed. In rewinding, when the MB-S1 comes to the beginning of the track where you pressed the ▶ PLAY/■ PAUSE button, the playback of the track starts. In fast forwarding, when the MB-S1 comes to the beginning of the next track, the playback of the next track starts.

## Playing tracks in a group in random order

Remote controller only



Pressing the RANDOM button on the remote controller displays the current setting for random playback. Each press of the RANDOM button switches the setting between "RANDOM ON" and "RANDOM OFF."

**RANDOM ON:** Plays the tracks in the current group in random order. When you select RANDOM ON, the "RANDOM" indicator lights.

**RANDOM OFF:** Disables the random playback function.

## Playing tracks repeatedly

Remote controller only



Pressing the REPEAT button on the remote controller displays the current setting of the repeat playback. Each press of the REPEAT button switches the repeat playback mode in the following order: REPEAT ALL, REPEAT 1, REPEAT OFF.

**REPEAT ALL:** Plays all tracks in the current group repeatedly. When you select this mode, "REPEAT ALL" indicator lights.

**REPEAT 1:** Plays the current track repeatedly. When you select this mode, "REPEAT 1" indicator lights.

**REPEAT OFF:** Turns off the repeat playback mode.

# Listening to tracks recorded on the HDD

## Switching the display information

Each press of the COUNTER button on the remote controller switches the information displayed in the display area. While the text information is displayed using the DISPLAY button, the information below will not be displayed.

### During stopped

Playing time for the first track in the current group

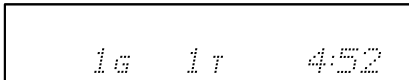

The total track number and the total playing time for the current group

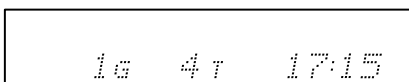

### During paused or playing

The elapsed time for the currently played track

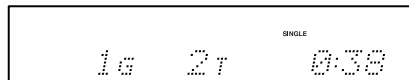

The remaining time for the currently played track

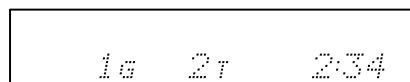

### When the disc title is longer than the display area

Press the SCROLL button on the remote controller to display the whole title sequentially.

## Using the remote controller

### Switches to the clock display.

### Selects the track you want to listen to.

While playing or paused, press the **◀◀** button once to locate the beginning of the current track. Press this button twice to locate the beginning of the previous track and additional press of the button locates the beginning of another previous track. While playing or paused, press the **▶▶** button to locate the beginning of the next track. Then, each press of this button locates the beginning of another next track.

### Plays tracks in random order.

### Selects a group.

### Plays a track by directly entering the track number.

Pressing the **⓪** button selects the digit you are entering.

The **10/0** button enters 10 or 0.

Example:

Track Number	The button to be pressed
8	<b>8</b>
10	<b>10/0</b>
34	<b>⓪</b> , <b>3</b> , <b>4</b>

### Changes the brightness of the display area\*.

### Switches the displayed information in the display area.

### Scrolls the whole disc title longer than the display area.

### Activates the HDD section.

### Starts playing or pauses.

Press the **▶/||** button to start playing a track. While playing, press the **▶/||** button to pause.

### Stops playback.

### Plays tracks repeatedly. (see page 30)

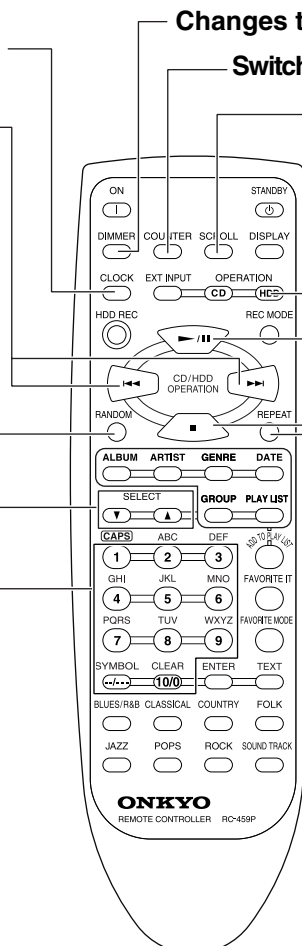

\* Changing the brightness of the display area

Each press of the DIMMER button changes the brightness of the display area in the following order from the above:

The display area is slightly dimmed. → The display area is dimmed. → The display area is dimmed and indicators other than the ON indicator on the front panel are turned off. → The display area is turned on and all indicators light.

# Naming tracks recorded on the HDD

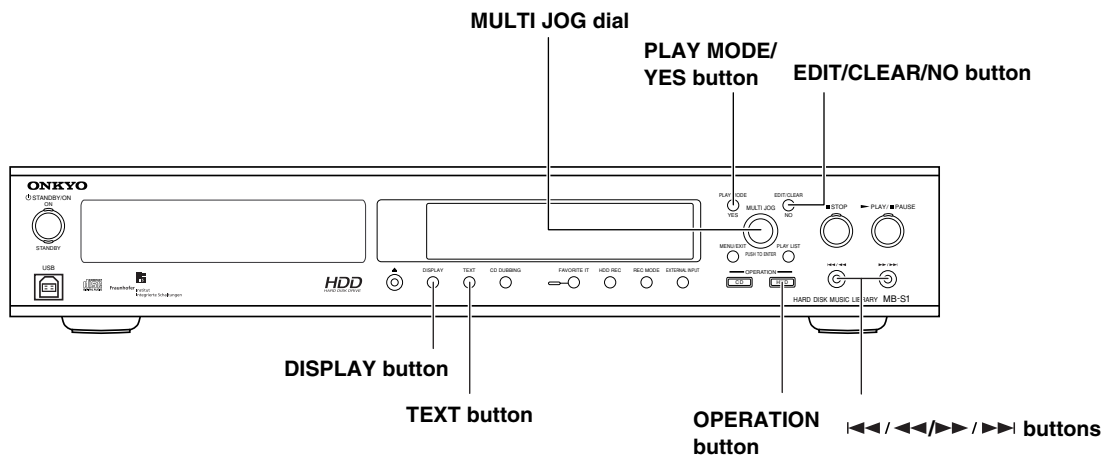

## Entering the name of a track

For the tracks recorded on the HDD, you can enter the track information such as track title, album title and genre. Entered information can be used when creating and editing a play list.

### 1. Activate the HDD section.

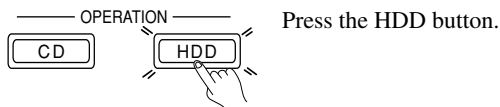

### 2. Select the track to which you want to enter the information.

For selecting a track, see page xx.

### 3. Call the character-editing mode.

Press the TEXT button. The menu item showing editing mode is displayed.

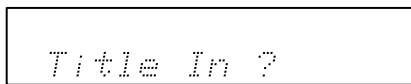

### 4. Select the editing mode you want to perform.

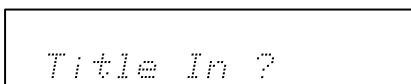
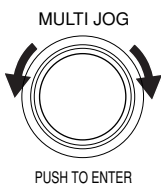

Turn the jog dial to select the editing mode. The editing mode showing in the display changes in the following order: Album In?, Artist In?, Genre In?, Date In?, Title In?.

Press the MULTI JOG dial to confirm the editing mode you select.

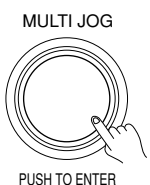

### 5. Enter the characters.

When the editing mode is Title In?, Album In? And Artist In?, see “Entering characters” below.

When the editing mode is Genre In?, see “Selecting a genre” on the next page.

### 6. Confirm the entry and exit the editing mode.



Press the YES button or the TEXT button to confirm the entry.

The “Complete!” indication is displayed in the display area.

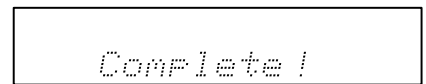
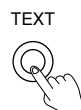

## Entering characters

When the editing mode is Title In?, Album In? and Artist In?, you can enter the character information using the following procedures.

### 1. Selecting a character you want to enter

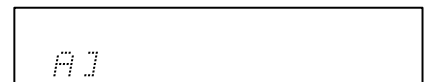
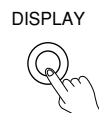

Press the DISPLAY button repeatedly to change the type of character to be entered.

Display	Type of character to be entered
A]	Upper-case letter of alphabet (A-Z)
a]	Lower-case letter of alphabet (a-z)
1]	Numbers (0-9)/Symbols
↑]	Same letter or symbol as you entered before

# Naming tracks recorded on the HDD

## 2. Selecting a letter you want to enter

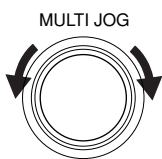

MULTI JOG

PUSH TO ENTER

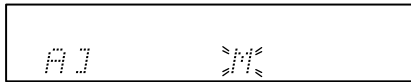

Turning the MULTI JOG dial displays each letter for the current character type.

Pressing the MULTI JOG dial confirms the letter and you can enter the next digit.



MULTI JOG

PUSH TO ENTER

## 3. Moving to a digit

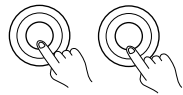

Pressing the ◀◀/▶▶ button focuses the previous letter. Pressing the ▶▶/▶▶ button focuses the next letter.

## 4. Deleting a letter

EDIT/CLEAR



NO

Press the EDIT/CLEAR button to delete the current letter.

## Selecting a genre

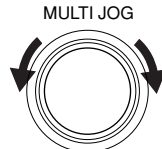

MULTI JOG

PUSH TO ENTER

When the editing mode is Genre In?, you can select a genre name by turning the MULTI JOG dial. The 24 genres shown below are available for your selection.

Press the MULTI JOG dial to confirm the selection.

(Undefined), Alternative, Blues/R&B, Books & Spoken, Children's Music, Classical, Country, Dance, Data, Easy Listening, Electronic, Folk, Hip Hop/Rap, Holiday, House, Industrial, Jazz, New Age, Pop, Religious, Rock, Soundtrack, Trance, World, Other

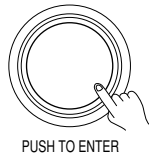

MULTI JOG

PUSH TO ENTER

## Using the remote controller

Do the following steps in numeric order.

### 2. Select a track of which you want to edit information.

Press the SELECT ▲/▼ button to select a group, and press the ◀◀/▶▶ button to select a track.

### 4. Select the mode.

\* When you select "Genre In?", instead of step 6 and 7, press the SELECT ▲/▼ button to select a genre and press the ENTER button to confirm it.

### 7. Enter a letter.

**1**: Select a number-entering mode using the DISPLAY button to enter "1." In any other mode, pressing the "1" button enters nothing.

**2**~**9**: When you select a number-entering mode using the DISPLAY button, you can enter any number. When you select a lower-case mode or an upper-case mode, you can enter any alphabetical letter written above the button.

**SYMBOL**  
**10/0**: Press this button to enter a symbol regardless of the mode selected with the DISPLAY button.

**CLEAR**  
**10/0**: You can enter "0" with this button after selecting a number entering mode using the DISPLAY button. In any other modes, this button works as a delete button.

**ENTER**  
**10/0**: Press this button to confirm the letter.

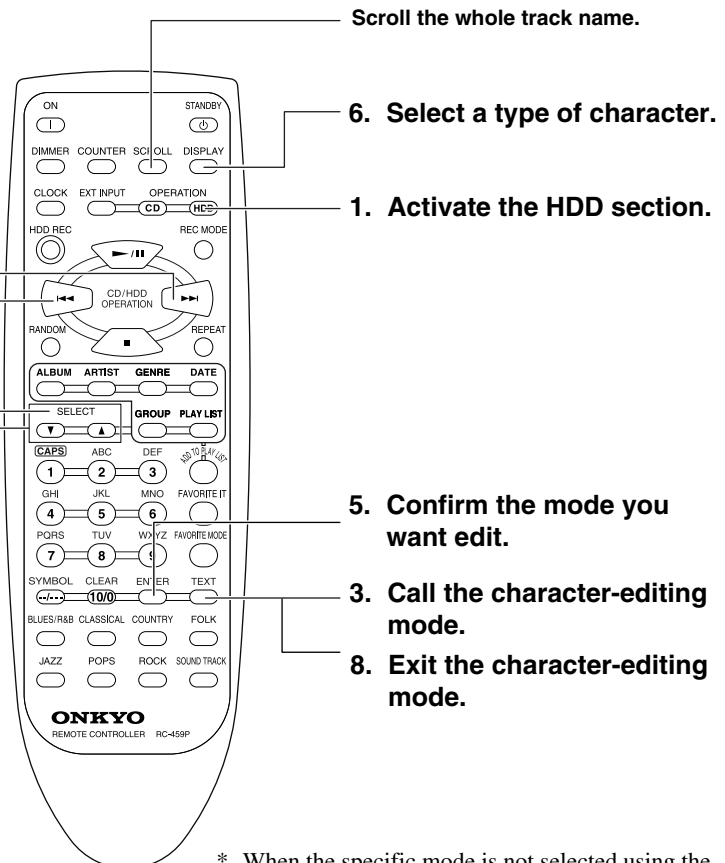

Scroll the whole track name.

6. Select a type of character.

1. Activate the HDD section.

5. Confirm the mode you want edit.

3. Call the character-editing mode.

8. Exit the character-editing mode.

\* When the specific mode is not selected using the DISPLAY button, each press of a letter or number button switches letters to be entered as below.

Example in case of **2** button: A, B, C, a, b, c, 2

# Erasing tracks recorded on the HDD

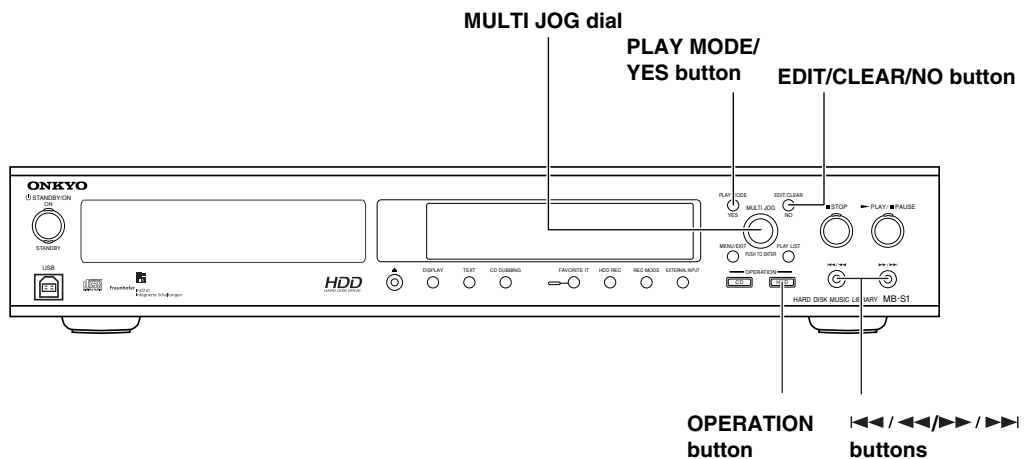

## Erasing a track

### 1. Activate the HDD section.

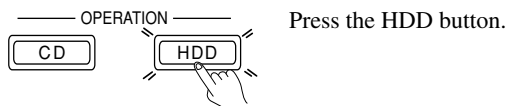

### 2. Select a track you want to erase.

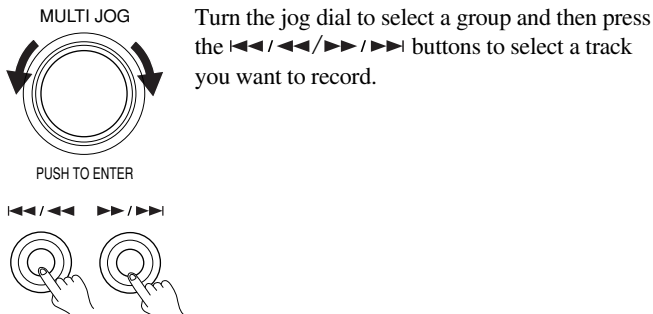

### 3. Call the edit/clear mode.

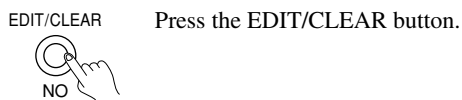

### 4. Select the one-track erase mode.

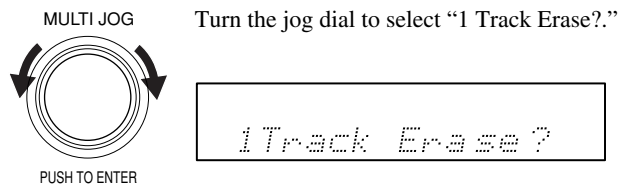

### 5. Press the jog dial.

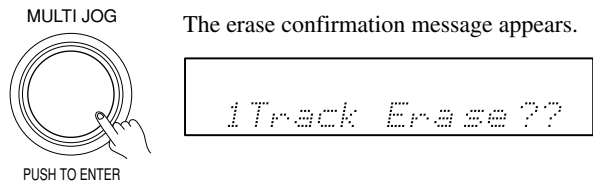

### 6. Confirm the erase operation.

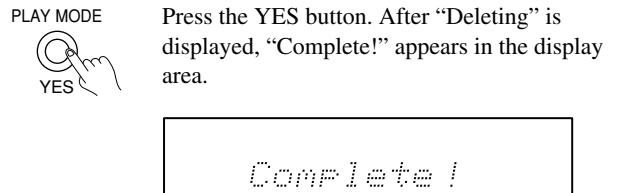

#### Notice:

To cancel the erase operation before confirming, press the MENU/EXIT or ■ STOP button.

# Erasing tracks recorded on the HDD

---

## Erasing an entire group

### 1. Activate the HDD section.



### 2. Select a group you want to record.

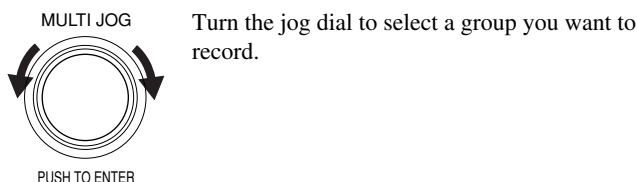

### 3. Call the edit/clear mode.

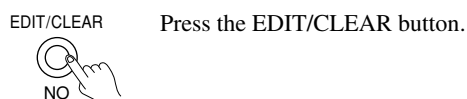

### 4. Select the group erase mode.

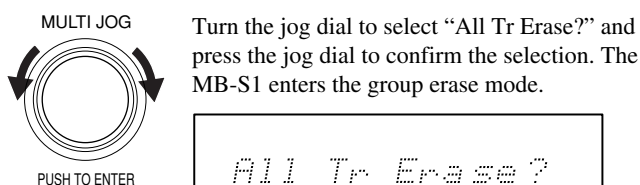

### 5. Press the jog dial.

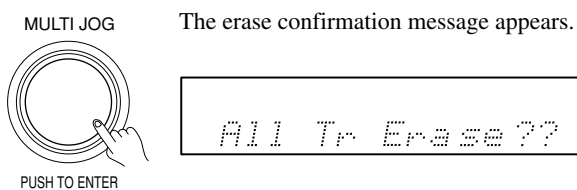

### 6. Confirm the erase operation.

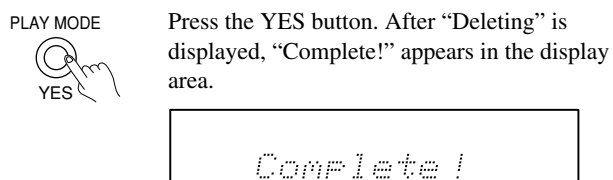

# Creating a play list

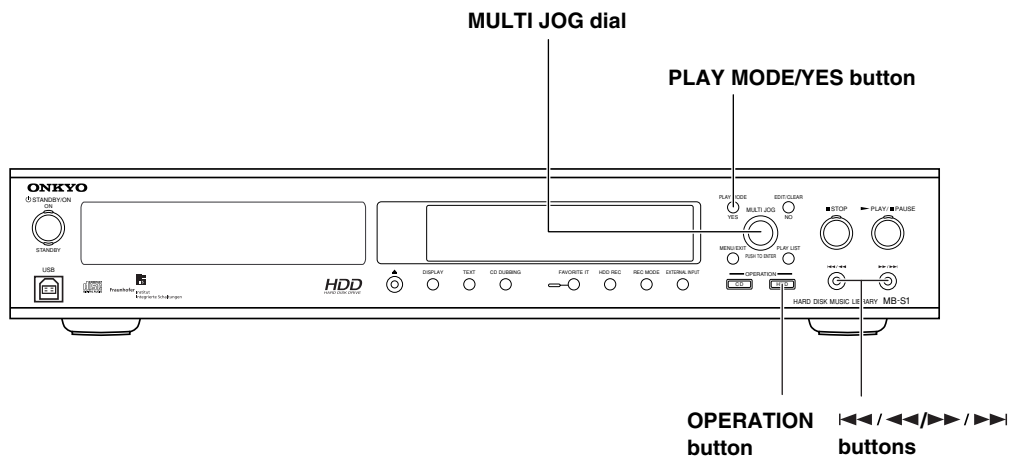

## Creating a play list

You can create a play list which includes your favorite tracks. You can choose tracks for a play list from the audio CD tracks or music files recorded on the HDD.

You can create up to 100 play lists and add up to 100 tracks with per play list.

### 1. Activate the HDD section.

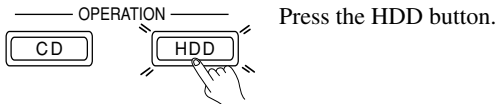

### 2. Select a track you want to add to a play list.

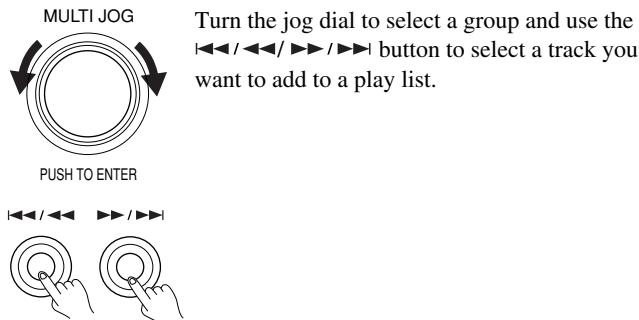

### 3. Activate the play list creation mode.

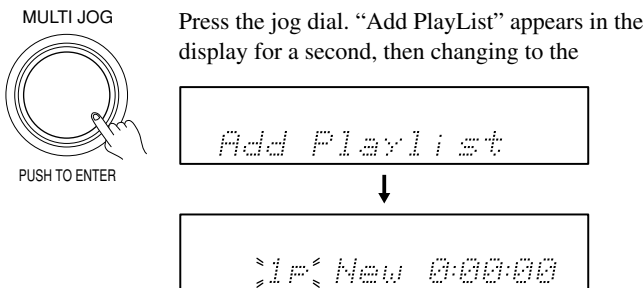

indication for play list number selection. When you create a play list first time, "1p" blinks. After second time, the play list number you selected last time blinks.

### 4. Select a play list.

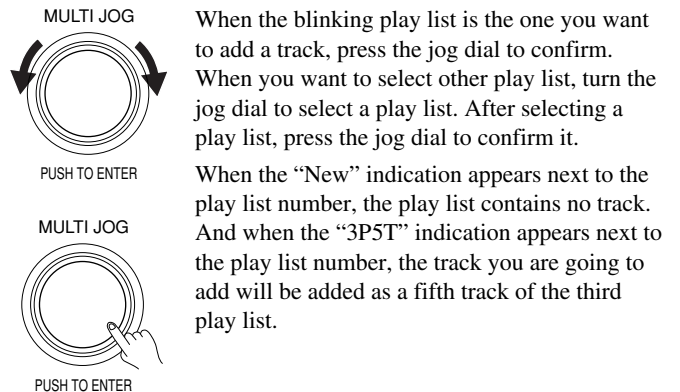

### 5. Select a position where you want to add a track.

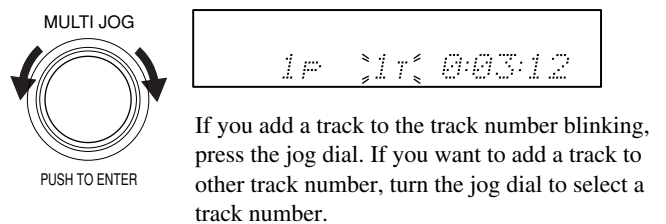

### 6. Confirm your selection.

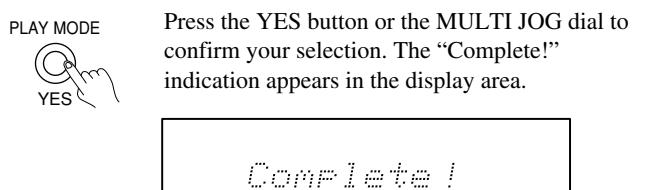



# Creating a play list

## ■ Understanding the indication on play lists

### When creating a play list

When you create a play list first time, "1P-New" appears.

"1P" means the first play list and "New" means that the play list contains no track.

After second play list, the indication will be like "2P-New".

"2P" means the second play list and "New" means that the play list contains no track.

\* If you delete a play list, the play list number is reserved until other new play list is created. The renumbering for play list number is not performed. When you create a play list next time, the reserved play list number appears as a new play list number.

For example, if you have play lists No.1 through No.10 and delete the play list No.3, when you create a play list next time, "3P-New" appears.

### When adding tracks to a play list

When you add a track to an existing play list, for example, the first play list containing 5 tracks, the indication will be "1P-6T".

"1P" means the first play list and "6T" means the position you are going to add a track to. If you want to change the order of playing tracks, change the track number.

\* If you delete a track in a play list, the track number for the next track of the deleted track is receded, and then the rest of the tracks in the play list are renumbered accordingly. For example, when you register 10 tracks (No.1 through No.10) in the first play list and you delete the track No.3, the track No.4 is receded to No.3 and the rest of the tracks in the play list is renumbered accordingly, resulting in 9 tracks in the play list.

## Using the remote controller

Do the following steps in numeric order.

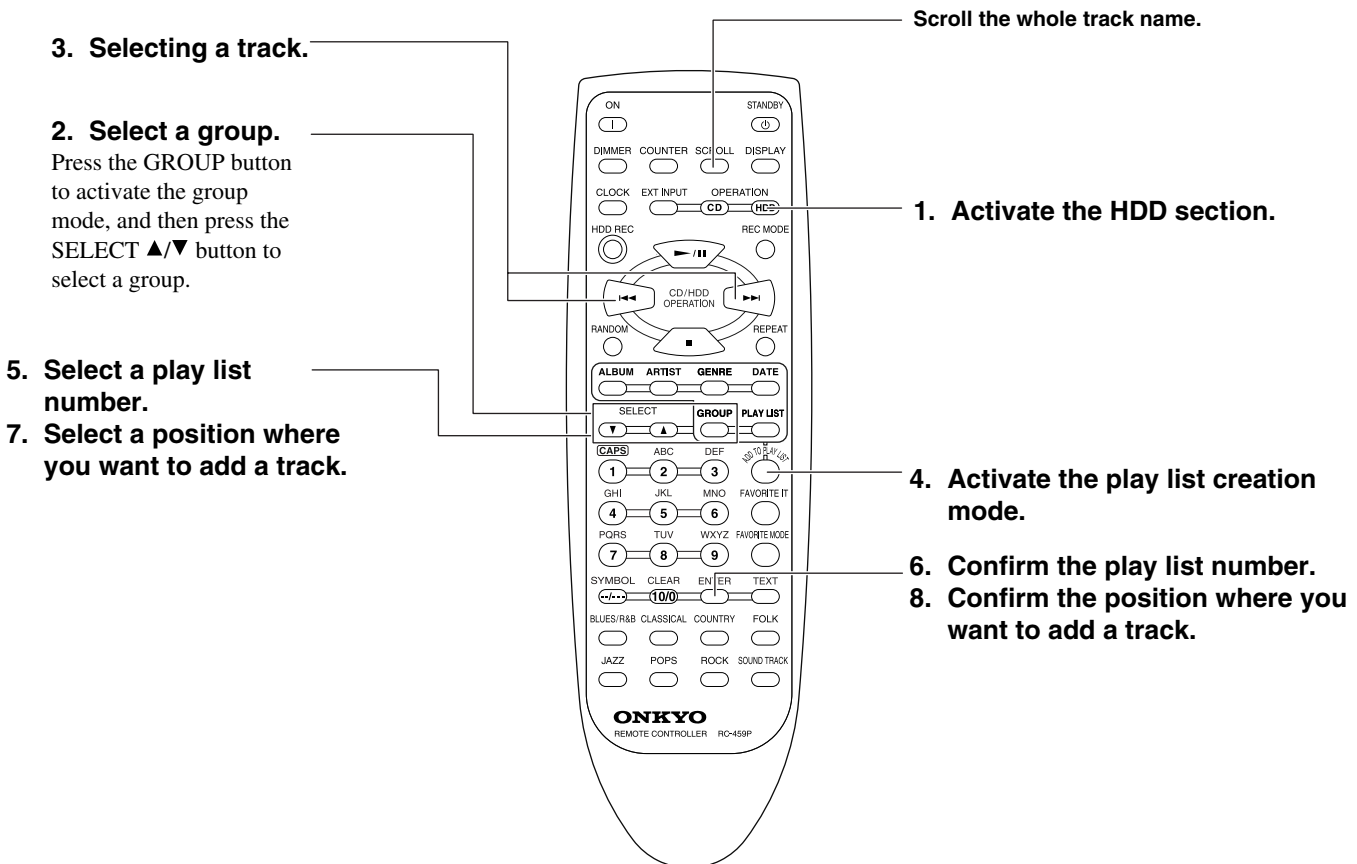

# Listening to tracks using a play list

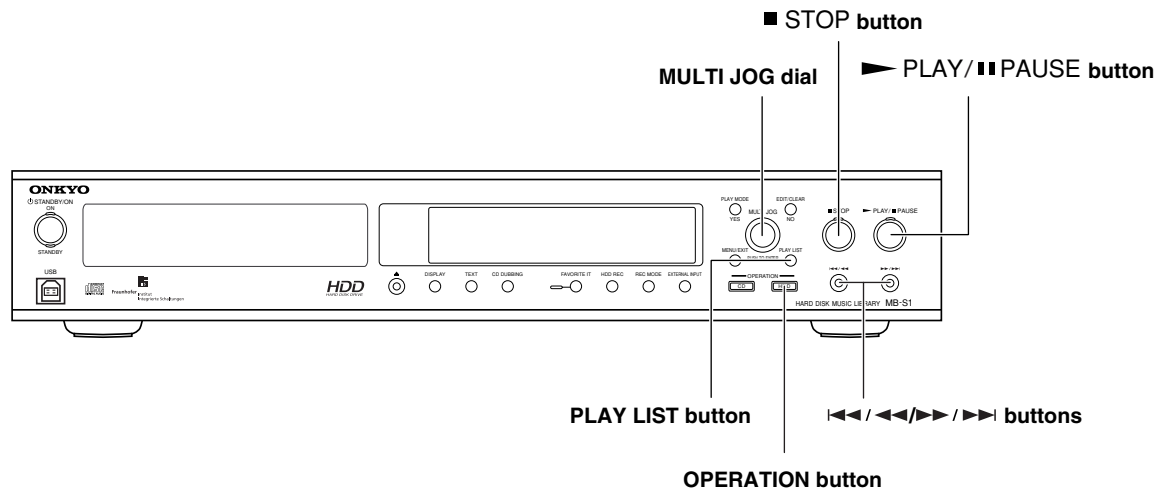

## Listening to tracks using a play list

### 1. Activate the HDD section.



### 2. Activate the play list mode.

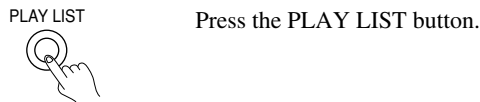

### 3. Select a play list.

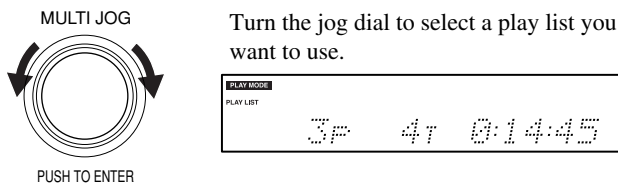

### 4. Start playing.



## Stopping the playback.

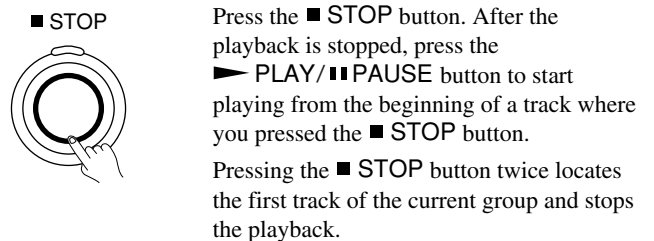

## Selecting a track you want to listen to.

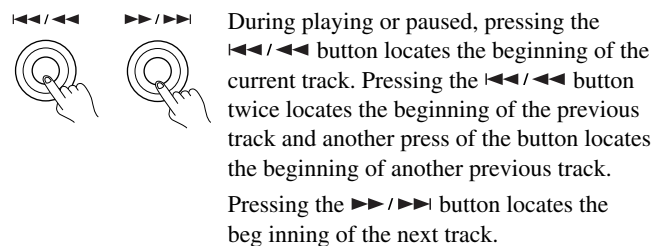

## Rewinding and fast forwarding

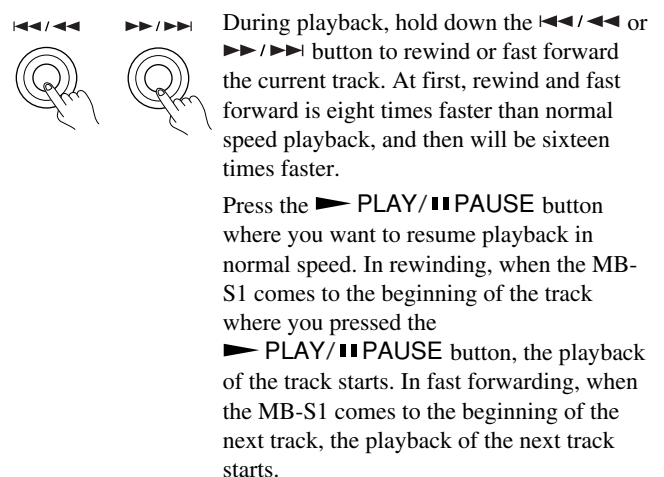

# Listening to tracks using a play list

## Playing tracks in a play list in random order

### Remote controller only



Pressing the RANDOM button on the remote controller displays the current setting for random playback. Each press of the RANDOM button switches the setting between "RANDOM ON" and "RANDOM OFF."

**RANDOM ON:** Plays the tracks in the current play list in random order. When you select RANDOM ON, the "RANDOM" indicator lights.

**RANDOM OFF:** Disable the random playback function.

## Playing tracks in a play list repeatedly

### Remote controller only



Pressing the REPEAT button on the remote controller displays the current setting of the repeat playback. Each press of the REPEAT button switches the repeat playback mode in the following order: REPEAT ALL, REPEAT 1, REPEAT OFF.

**REPEAT ALL:** Plays all tracks in the current play list. When you select this mode, "REPEAT ALL" indicator lights.

**REPEAT 1:** Plays the current track repeatedly. When you select this mode, "REPEAT 1" indicator lights.

**REPEAT OFF:** Turns off the repeat playback mode.

## Using the remote controller

Do the following steps in numeric order.

Selects a track you want to listen to.

Listening to tracks in the current play list in random order.

3. Select a play list.

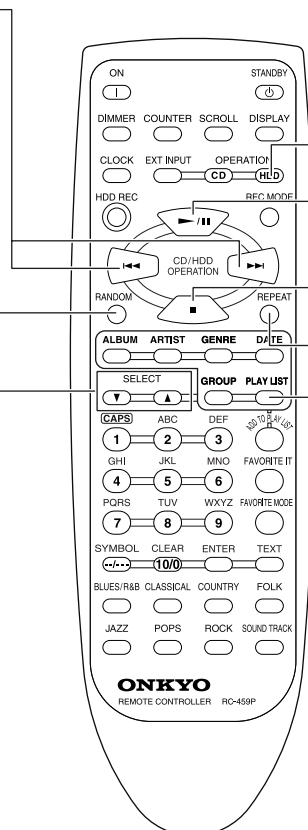

1. Activate the HDD section.

4. Start playback.

Stop the playback.

Listening to tracks in the current play list repeatedly.

2. Activate the play list mode.

# Editing the play lists

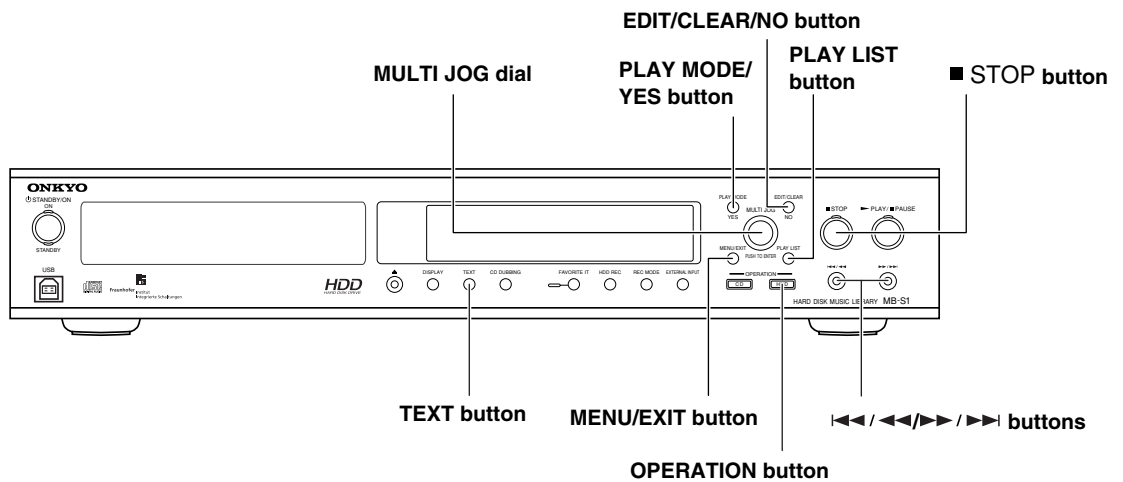

## Naming a play list

### 1. Activate the play list mode.

PLAY LIST Press the PLAY LIST button.

### 2. Select a play list.

MULTI JOG Turn the jog dial to select the number of a play list you want to name.

PUSH TO ENTER

### 3. Activate the character-editing menu.

TEXT Press the TEXT button. The "P.List Name" appears in the display area. Then, press the jog dial to activate the play list naming mode.

MULTI JOG

PUSH TO ENTER

### 4. Enter the play list name.

For entering character, see "Entering characters" on page 27.  
If you want to cancel naming, press the MENU/EXIT button.

### 5. Confirm the entry.

PLAY MODE

Press the YES button to confirm the name.  
The "Complete!" indication is displayed in the display area.

## Using the remote controller

Do the following steps in unnumeric order.

1. Activate the play list mode.
2. Select a play list.
3. Activate the character-editing menu.
4. Activate the play list naming mode.
5. Confirm the name and exit.
6. Enter the play list name. (see page 27)
7. Confirm the name and exit.

# Editing the play lists

## Moving a track within a play list

### 1. Activate the play list mode.

PLAY LIST

Press the PLAY LIST button.



### 2. Select a play list.

MULTI JOG

Turn the jog dial to select a play list number for which you want to move a track position.



PUSH TO ENTER

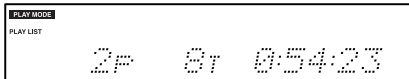

### 3. Select a track you want to move.

◀◀/▶▶ ▶▶/▶▶

Press the ◀◀/▶▶/▶▶/▶▶ button to select a track you want to delete.

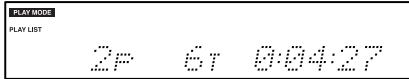
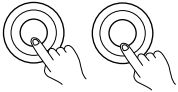

### 4. Select the track-moving mode.

EDIT/CLEAR

Press the EDIT/CLEAR button and turn the jog dial to select "TrNo.Change?."



NO

MULTI JOG



PUSH TO ENTER

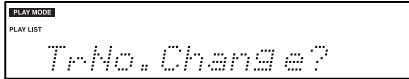

### 5. Activate the track-moving mode.

PLAY MODE

Press the YES button to activate the track-moving mode.



YES

### 6. Select a position you want to move a track to.

MULTI JOG

Turn the jog dial to select a track position you want to move a track to.



PUSH TO ENTER

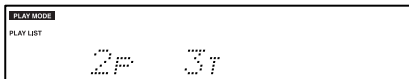

### 7. Confirm the position.

PLAY MODE

Press the YES button to confirm the new track position. The "Complete!" appears in the display area.



YES

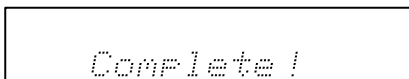

## Deleting a track in a play list

### 1. Activate the play list mode.

PLAY LIST

Press the PLAY LIST button.



### 2. Select a play list.

MULTI JOG

Turn the jog dial to select a play list number in which a track you want to delete is contained.

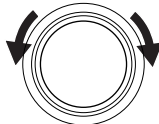

PUSH TO ENTER

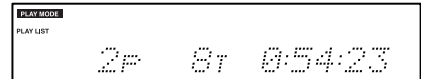

### 3. Select a track you want to delete.

◀◀/▶▶ ▶▶/▶▶

Press the ◀◀/▶▶/▶▶/▶▶ button to select a track you want to delete.

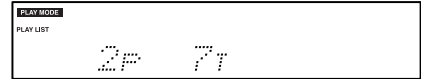

### 4. Select the one-track deleting mode.

EDIT/CLEAR

Press the EDIT/CLEAR button and turn the jog dial to select "1 Track Except?."



NO

MULTI JOG

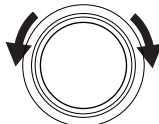

PUSH TO ENTER

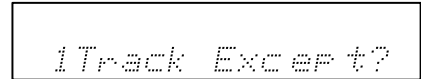

### 5. Confirm the delete operation.

PLAY MODE

Press the YES button to confirm the delete operation. The "Complete!" appears in the display area.



YES

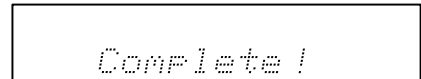

# Editing the play lists

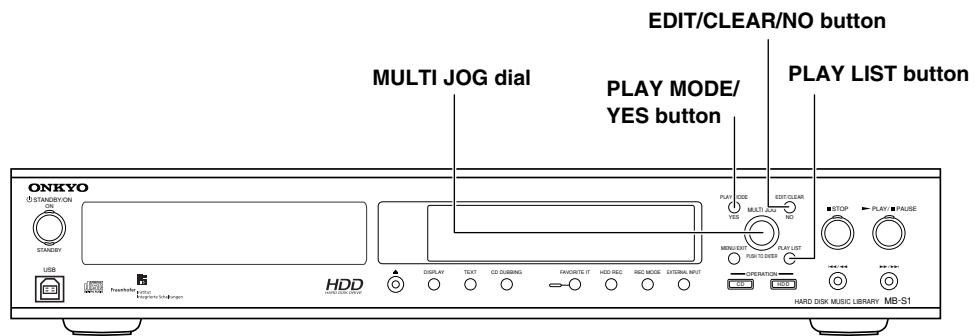

## Deleting a play list

### 1. Activate the play list mode.

PLAY LIST Press the PLAY LIST button.



### 2. Select a play list you want to delete.

MULTI JOG Turn the jog dial to select a play list number you want to delete.

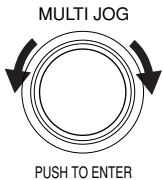

PUSH TO ENTER

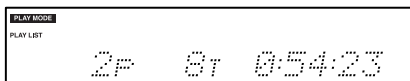

### 3. Activate the play-list deleting mode.

EDIT/CLEAR Press the EDIT/CLEAR button and turn the jog dial to select "P.List ERASE?".



NO

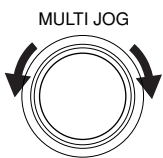

PUSH TO ENTER

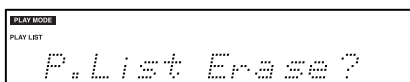

### 4. Confirm the delete operation.

PLAY MODE Press the YES button to confirm the delete operation. The "Complete!" appears in the display area.



YES

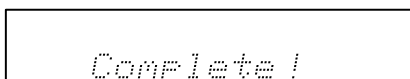

# Using various playback features

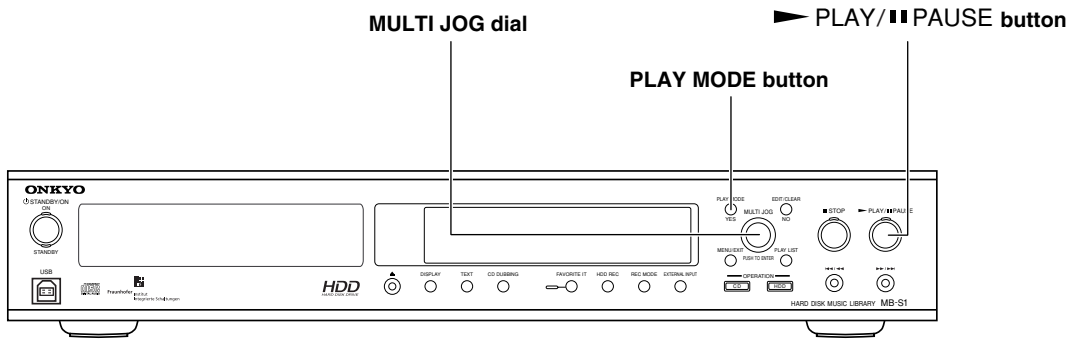

## Playing track in sorted order

You can use the information registered in track on the HDD to sort the playback order.

For example, you can sort and play tracks in the way as follows:

- In the order which groups and tracks recorded on the HDD (without sorting)
- In alphabetical order of the track titles
- In alphabetical order of the album titles
- In alphabetical order of the artist name
- In alphabetical order of the genre
- In chronological order of the date

### 1. Activate the play mode.

PLAY MODE

Press the PLAY MODE button.



### 2. Select a play mode.

MULTI JOG

Turn the jog dial to select a play mode. While turning, the play mode changes in the following order: Group?, Title?, Album?, Artist?, Genre?, and Date?.



PUSH TO ENTER

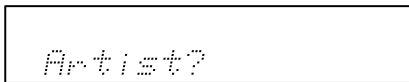

### 3. Confirm the selection.

MULTI JOG

Press the jog dial to confirm the play mode selection. The "Sorting" appears and then the first track of the sorted order is displayed.

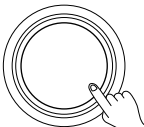

PUSH TO ENTER

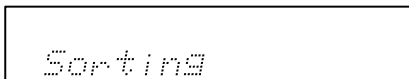

### 4. Start playback.

▶ PLAY/PAUSE

Press the ▶ PLAY/PAUSE button to start playback.



## Using the remote controller

Do the following steps in numeric order.

### 2. Starts playback.

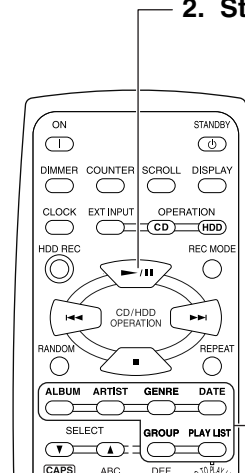

1. Press a play mode button you want to execute.

# Using various playback features

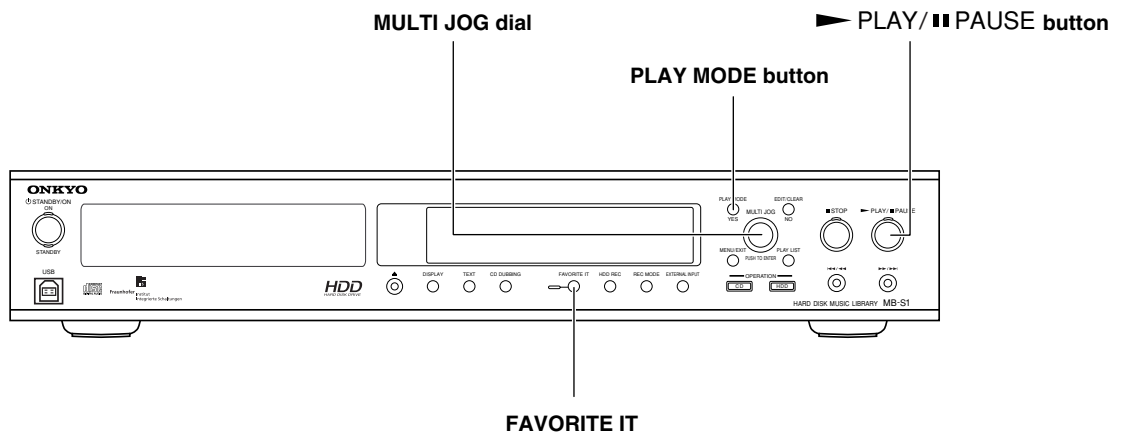

## Marking a track as your favorite (FAVORITE IT function)

When you have your favorite tracks, you can mark them as you favorite to register with the track information. When you enable the favorite mode, you can play the tracks marked as your favorite only. You can use the favorite mode playback combining with the sorted track playback function on the last page.

### 1. Mark a track as your favorite.

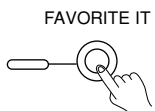

While your favorite track appears in the display area, press the FAVORITE IT button to mark the track as your favorite. The "Favorite On" appears for 2 seconds and the FAVORITE indicator lights in green. You can mark a track as your favorite while the track is being played. Press the FAVORITE IT button again to unmark the track.

## Playing your favorite tracks only

### 1. Activate the play mode.



Press the PLAY MODE button twice.

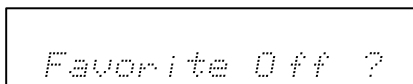

The current setting appears.

### 2. Activate the favorite mode.

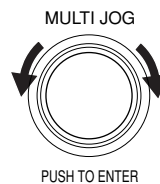

Turn the jog dial to select "Favorite On?".

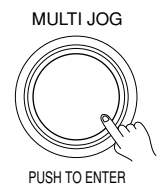
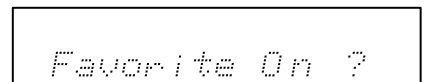

### 3. Confirm the selection.

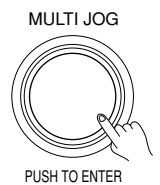

Press the jog dial. The "Sorting" appears in the display area and tracks marked as your favorite are selected.

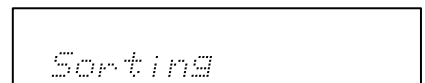

### 4. Start playback.



Press the ▶ PLAY/PAUSE button to start playback.

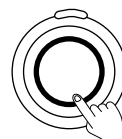

### ■ Disabling the favorite mode

In the step 2 above, select "Favorite Off" and press the jog dial.



## Using various playback features

---

### About combination of play modes

#### ■ When you combine the sorted tracks mode and the favorite mode

Plays only favorite tracks from sorted tracks in sorted order.

#### ■ When you select a play list and enable the favorite mode

Plays only favorite tracks from tracks in the play list.

#### ■ When you use the random and repeat playback feature

Plays tracks in random order and repeatedly.

## Using the remote controller

---

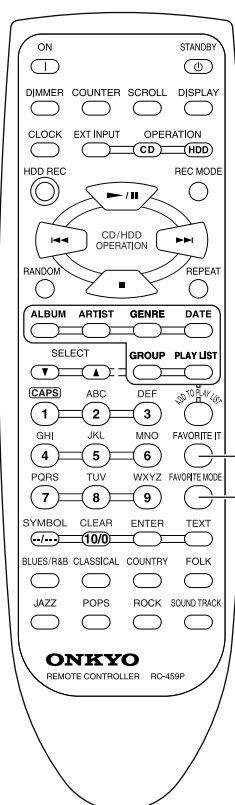

1. Mark a track as your favorite.
2. Activate the favorite mode.

# Using timer functions

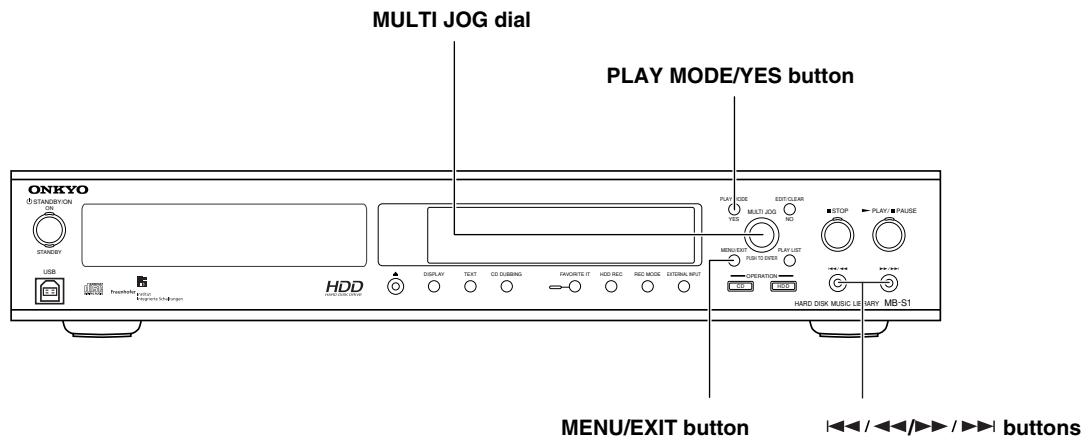

## Setting a timer

### 1. Call the menu mode



Press the MENU button. The menu appears in the display area.

### 2. Select the timer setting menu.

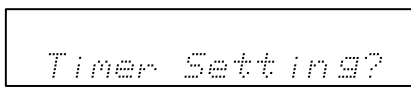
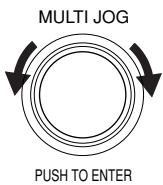

Turn the jog dial to select "Timer Setting?" and press it to confirm the selection.

If "Clock Adjust" appears, set the clock. For setting the clock, see page 18.

### 3. Select a timer setting number.

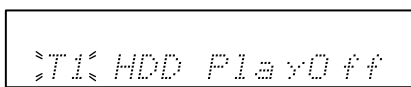
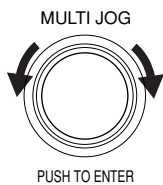

You can set up to four timer settings (T1-T4).

Turn the jog dial to select a timer setting number and press it to confirm the selection.

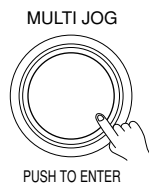

### 4. Set the timer function.

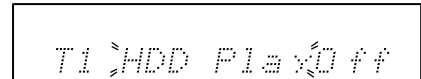
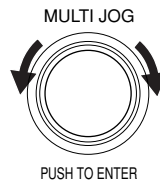

Turn the jog dial to select the timer function for the timer setting.

After selecting the timer function, press the jog dial to confirm the timer function.

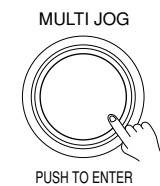

#### Timer Function

**HDD Play:** Plays tracks on the HDD.

**D-1 REC:** Records the audio signal from DIGITAL INPUT 1 input terminals.

**D-2 REC:** Records the audio signal from DIGITAL INPUT 2 input terminals.

**ANA REC:** Records the audio signal from ANALOG input terminals.

### 5. Set the timer on or off.

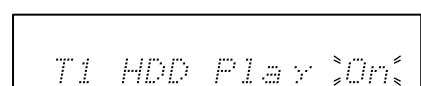
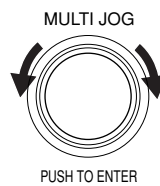

Turn the jog dial to select "On" or "Off" and press it to confirm the selection.

When you set the timer to "Off", the time setting mode finishes.

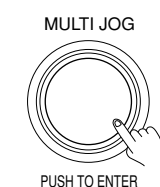

# Using timer functions

## 6. Set the start time and end time for the timer setting.

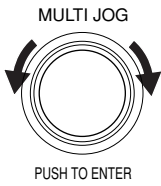

- Turn the jog dial to select hour for the start time. Press the jog dial to confirm the hour and the highlight moves to the minute.
- After setting the start time for the timer setting, the time one hour passed from the start time appears as the end time.
- Use the ◀◀/◀◀/▶▶/▶▶ button move the highlight forward or back.
- The maximum time from the start time to the end time is 23 hours 59 minutes 59 seconds.

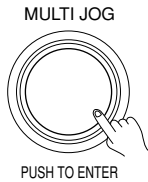

## 7. Confirm the start time and the end time.



Press the YES button to confirm the time. Then the display changes to the indication of setting the day of the week. At first, current day of the week blinks.

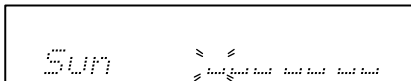

## 8. Set the day of the week.

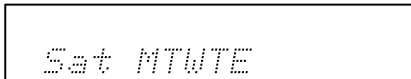
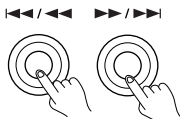

Use the ◀◀/◀◀/▶▶/▶▶ button to select the day of the week for activating the timer setting and press the jog dial.

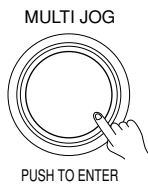

## 9. Confirm the day of the week.



Press the YES button to confirm the day of the week.

### In step 4 above:

When you select "HDD PLAY," go to step 10, "Select a play list."

When you select "D-1 REC," "D-2 REC," or "ANA REC," go to the step 11, "Select a target group for recording."

## 10. Select a play list.

(Only when you select "HDD PLAY" for timer function in step 4)

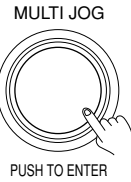
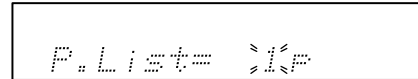
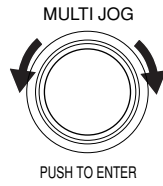

Turn the jog dial to select a play list and press it to confirm the selection.

If you have not created any play list, "Current" appears and the last group which was played before the timer activated will be played when the start time comes.

After pressing the jog dial, the timer setting finishes and is enabled.

## 11. Select a target group for recording.

(Only when you select "D-1 REC," "D-2 REC," or "ANA REC.")

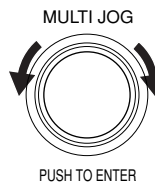

Turn the jog dial to select a target group for recording and press it to confirm the selection. You can choose from "Current," "New," or "Fix."

**Current:** Set a target group to the group the last time the recording or playback was performed.

**New:** Create a new target group.

**Fix:** Select a target group from the existing groups. Turn the jog dial to select a target group for recording and press it to confirm the selection.



### Notes:

- When you record longer hours, the recording will be separated automatically into a track every one hour.
- If an operation is performed such as playing, recording and others when the start time for the timer setting comes, the timer function may not operate normally.
- The timer function will activate whether the MB-S1 is turned on or in the standby state.
- You can set up to 4 timer settings. However, when a timer setting already executed has not completed yet and the start time for another timer setting comes, the latter timer setting will be ignored.

# Specifications

---

<b>CD-ROM Dreive Unit</b>	ATA Packet Interface (specified in SFF-8020). (E-IDE) Industry Standard 5.25" Half Height Form Factor.
<b>Hard Disk Drive Unit</b>	AT Attachment 5 (ATA-5) Industry Standard 5.25" Half Height Form Factor. 20GB (MB-S1), 40GB (HDR-1)
<b>D/A Converter</b>	Single bit (Crystal CS4341, 24bit/96kHz)
<b>A/D Converter</b>	Single bit (Crystal CS53L32A, 24bit/96kHz)
<b>Connections</b>	1 Analog Output (stereo)(MB-S1) / 2 Analog Output (stereo)(HDR-1) 1 Analog Input (stereo) 2 Digital Input (optical)/(coaxial) 1 Digital Output (optical) (with Audio CD Playback only) 1 USB (Type B) 1 RS-232C (Dsub-9pin) (HDR-1 only)
<b>Frequency Response</b>	5Hz - 20 kHz
<b>Playback Harmonic distortion</b>	0.007% (at 1kHz, 0dB)
<b>Playback Dynamic range</b>	90 dB
<b>Playback Signal to noise ratio</b>	90 dB
<b>Recording Harmonic distortion</b>	LPCM: 0.007% (at 1kHz, 0dB), MP3: 0.018% (at 1kHz, 0dB)
<b>Recording Dynamec range</b>	90dB
<b>Recording Signal to Noise ratio</b>	90dB
<b>Channel Separation</b>	90dB (playback)
<b>Wow and Flutter</b>	Below threshold of measurability
<b>Output Level</b>	2.0 volts r.m.s.
<b>Power Supply Rating &amp; Power Consumption</b>	AC120V, 60Hz, 27W (AC120-240V, 50/60Hz, 24W)
<b>Dimension (W.H.D.)</b>	W435 mm x H81 mm x D348 mm
<b>Weight</b>	5.0kg

# *Carry Tunes*



# Overview of the supplied Carry Tunes software

The supplied Carry Tunes software is designed for transferring MP3 music files. Though MP3 music files have been able to play only on PC, Carry Tunes allows you to enjoy the music files easily and in high quality on the MB-S1.

## ■ Plays MP3 music files

You can play MP3 music files with easy operation.

## ■ MP3 track information edit feature

You can add and edit the track information such as track title and album title.

## ■ MP3 music file transfer feature

Using Carry Tunes, you can transfer MP3 music files from PC to the HDD on the MB-S1 through USB interface, allowing playback in high quality on the MB-S1. You can easily select MP3 music files to transfer, using check box or the CHECK ALL button.

\* The music files you can play or transfer to the MB-S1 using Carry Tunes are MP3 format files only.

## ■ Other features

Track list sort feature (You can sort the tracks easily by clicking the information item title.)

Track data calculation feature (The total playing time and the total size for selected files can be displayed.)

File transfer progression display feature (You can easily find the file transfer status in progression bar display. The progress display in files or in sizes is available.)

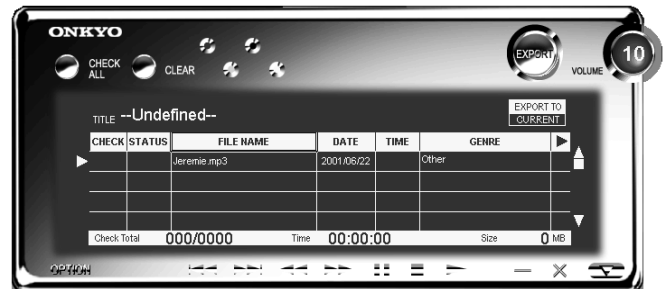

**Use this software following the procedures below.**

### 1. Connect a PC to the MB-S1 properly.

See page 50.

### 2. Prepare the connected PC.

See pages 50 and 51.

### 3. Install Carry Tunes, music file transfer software, to the PC.

See pages 52 and 53.

### 4. Play music files, edit track information, or transfer music files as necessary.

See pages 54 and 55.

#### Tip:

The supplied CD-ROM contains necessary software and sample music files used in this manual.

#### What is a device driver?

A device driver is software installed to PC to make the peripheral devices available to the PC. Also called "driver."

#### What is a device?

A device means every PC peripheral.

# System Requirements

---

To transfer music files connecting to the MB-S1, following configurations are required.

- **CPU:** Intel Pentium II 233MHz or higher (recommended Intel Pentium III 450MHz or higher)
- **HDD space:** 60MB or more
- **RAM:** 64MB or more (recommended 128MB or more)
- USB connector
- CD-ROM drive (or equivalent)
- Windows 98SE/Me/2000
- Intel USB host controller (recommended)

If the PC satisfies the requirements above, the MB-S1 may not operate properly depending on the specification dedicated to the PC or the environment in which the MB-S1 is used.

# Setting the PC

When connecting the MB-S1 to PC first time, you need to install the device driver.

## Installing the device driver

### 1. Turn on the PC.

Make sure the operating system starts and runs.

### 2. Connect the MB-S1 to the PC using a USB cable.

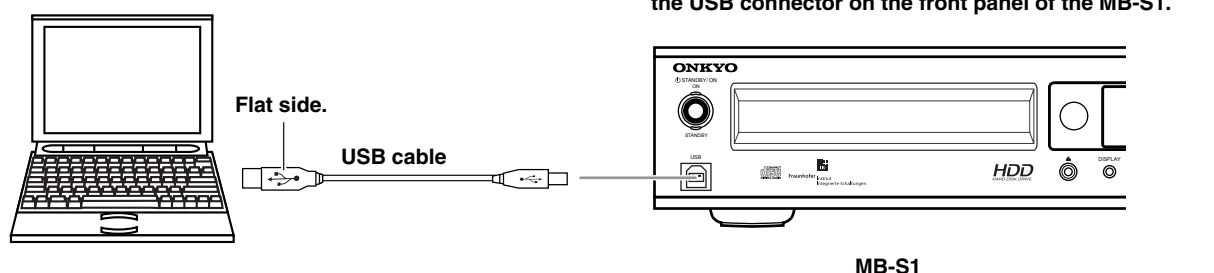

“Add New Hardware Wizard” appears in the PC's display.



### 3. Turn on the MB-S1.

### 4. Insert the supplied CD-ROM to the PC's CD-ROM drive.

### 5. Follow the instructions on the display to install the device driver.

- The device drivers are loaded in the following order: “MB-S1/HDR-1 Driver” and “MB-S1/HDR-1 Export Driver.”
- When the MB-S1 is successfully recognized on the PC, “UE205DRV Device” appears.

### 6. When the device drivers are successfully recognized on the PC, the install process finishes.

#### Notes

- In usual, the device drivers are automatically installed using the steps 1 and 2 in “Installing the device driver.”  
If “All New Hardware Wizard” screen does not appear, without disconnecting the USB cable, do the following.
  - ① Right-click My Computer and select Properties.
  - ② Click the Device Manager tab.
  - ③ Click Update.“All New Hardware Wizard” screen appears. Then follow the instructions on the display to install the device driver.
- When you connect the USB cable to another USB connector on the same PC, certain version of Windows 98 may require re-installing the device driver. In this case, click Cancel button and connect the USB cable to the one you connected when installing the device driver. Or re-install the device driver again following the instructions on the display.



## Setting the PC

### Confirming the installation of the device driver

1. Click Start, point to Settings, and double-click Control Panel.
2. Double-click the System icon.
3. Click Hardware. (Windows 2000 only)
4. Click the Device Manager tab.

When using Windows 98SE/Me

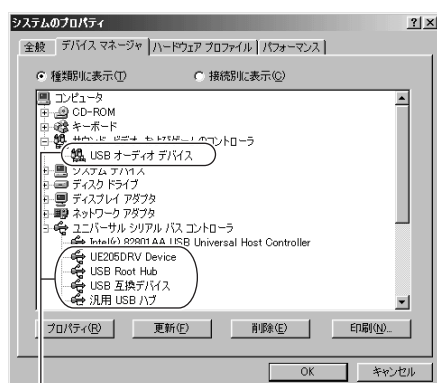

Confirm these device drivers are installed.

### 5. Confirm the installed device drivers are displayed in the dialog box.

- Find “USB Audio Device” under the “\*\*\*”
- Find “USB Root Hub”, “\*USB Compatible Device\*,” “\*\*\*,” and “UE205DRV Device.”

#### Notes

- When “Unknown device” appears under “Universal Serial Bus Controller”, unplug the USB cable and plug it again for the MB-S1 to be recognized.
- In Windows Me, green “?” mark may appear next to “USB Compatible Device” and “\*\*\*” in the Device Manager tab, but this will not effect the operation and function of the MB-S1.
- It may take about 15 seconds to recognize the UE-205 when you connect the USB cable or the PC starts up. During this recognition process, do not start any application and do not perform any operations on the PC. And do not unplug the USB cable while any applications runs on the PC.

# Installing the Carry Tunes

## Install Procedure

### 1. Insert the supplied CD-ROM into the CD-ROM drive on the PC.

The setup menu automatically appears. If the setup menu does not appear automatically, double-click the "CtStart.exe" file.

### 2. Click Install.

Carry Tunes setup screen appears.



### 3. Click Next.

The license agreement screen appears.



### 4. Click Yes.

Selecting the Destination Folder screen appears.

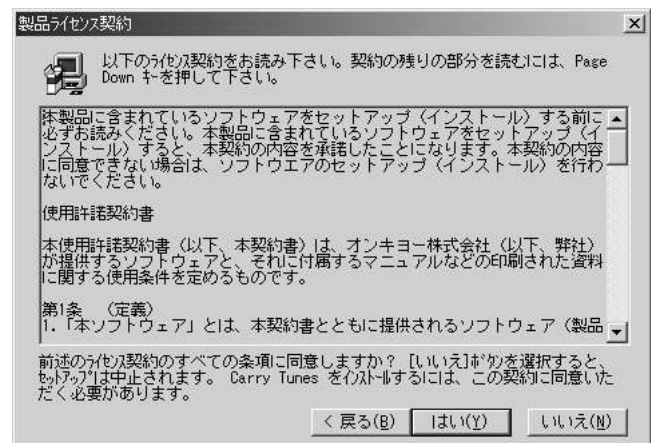

### 5. Click Next.

Selecting the Program Folder screen appears.

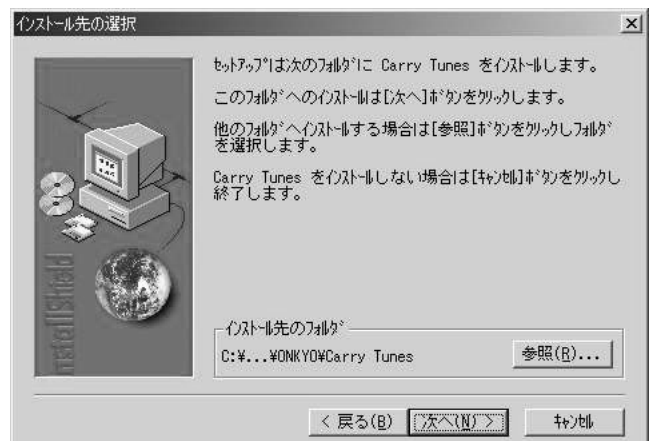

# Installing the Carry Tunes

## 6. Click Next.

Setup completion screen appears.



## 7. Click Finish.

The installation procedures for Carry Tunes complete.

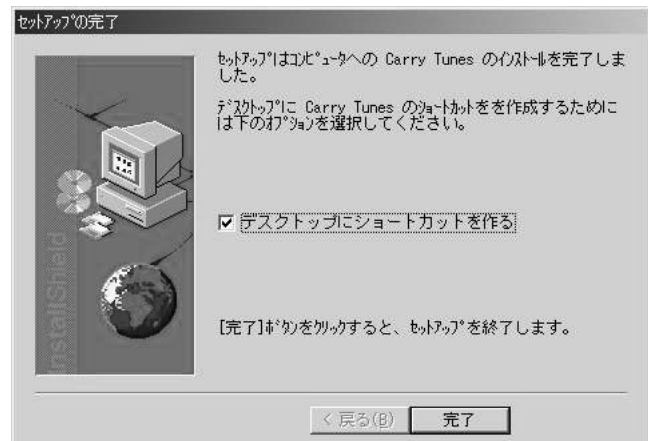

# Playing MP3 files using Carry Tunes

## Registering MP3 files with Carry Tunes

### 1. Start Carry Tunes.

Click Start, point to "Programs," point to Carry Tunes, and click Carry Tunes.

### 2. Drag the MP3 files you want to register and drop them onto Carry Tunes.

The supplied CD-ROM contains sample MP3 files. To use the sample MP3 files, insert the CD-ROM into the CD-ROM drive on the PC. Click Open Sample music folder in the Carry Tunes Installation CD dialog box to open the folder containing the sample MP3 files.

\* If the Carry Tunes Installation CD dialog box does not appear automatically, double-click the "CtStart.exe" file.

### 3. The MP3 files you dropped are displayed in the Carry Tunes screen.

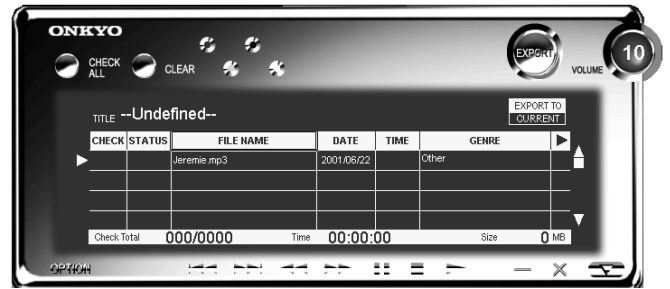

Open a music file.

## Main operations

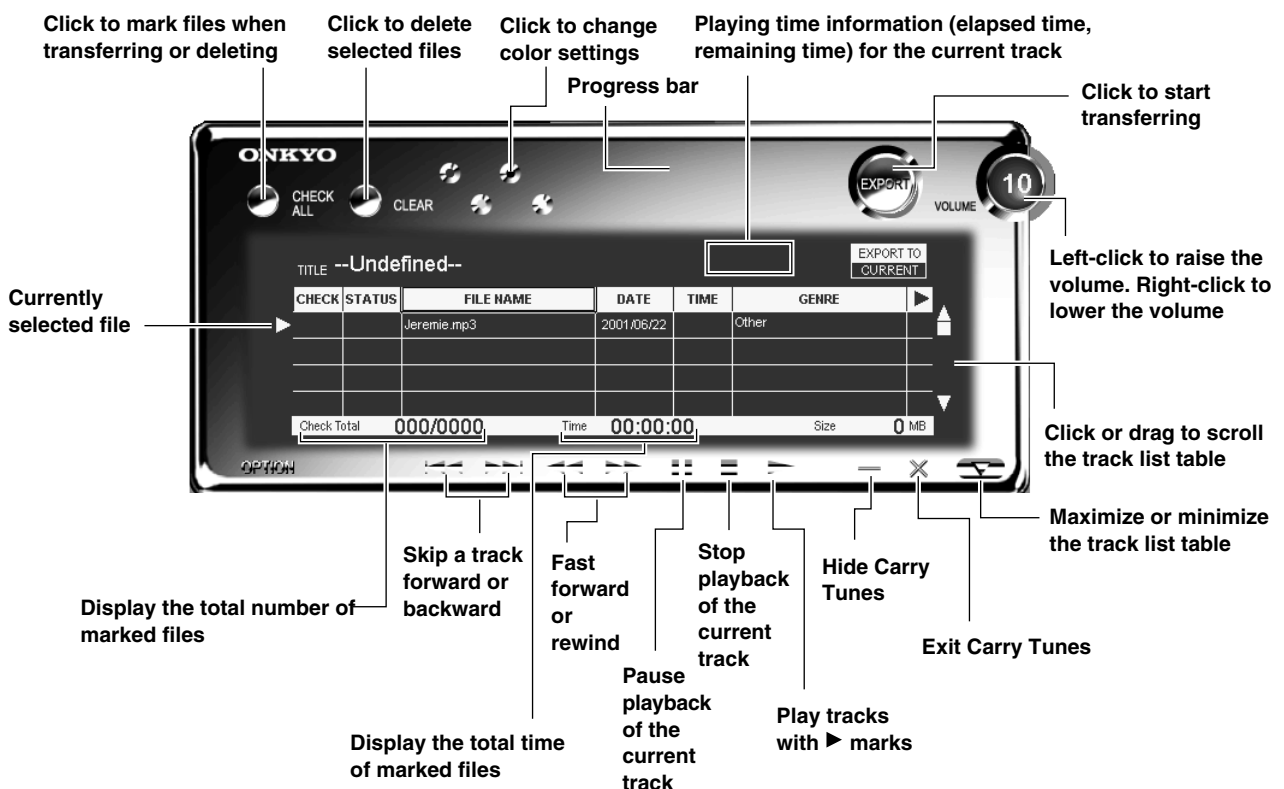

# Transferring MP3 files to the MB-S1

## Connecting the MB-S1 to PC

### 1. Make sure the MB-S1 is connected to the PC properly.

When the connection is properly made, the display in the MB-S1 shows as below.

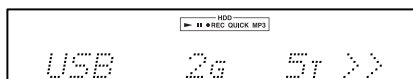

### 2. Make sure the PC is properly configured.

The MB-S1 can be connected to the PC running on Windows 98SE/Me/2000.

You can use the dedicated Carry Tunes music file transfer software to transfer the MP3 music files on PC to the HDD on the MB-S1.

Connect the USB connector on the front panel of the MB-S1 to the USB connector on the PC and configure the PC as necessary (page 50).

## Transferring MP3 music files to the MB-S1

### 1. Select MP3 files you want to transfer.

Click CHECK column on the track list to select or de-select a track.

To select all tracks on the track list, click the CHECK ALL button. Click the CLEAR button to de-select all tracks.

### 2. Select the target group for transferring MP3 files.

Click the EXPORT TO. "CURRENT" and "NEW" are displayed alternately.

When you select "CURRENT", selected MP3 files are transferred to the group currently selected on the MB-S1.

When you select "NEW," a target group is newly created on the MB-S1 and selected MP3 files are transferred to the newly created group.

Also confirm the display area on the MB-S1 for target group.

### 3. Press the EXPORT button to start transferring.

The progress bar indicates the progression of file transfer.

On the MB-S1, the target group and track position in the group to which a current file is being transferred to.

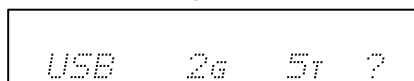

### 4. Transfer completes.

The indication showing file transfer completion appears on the Carry Tunes.

When you delete the transferred files from the PC, click OK. When you do not delete the transferred files on the PC, click "Cancel".

Also on the MB-S1, the indication showing file transfer completion appears.

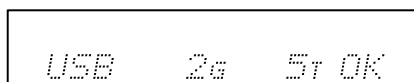

### 5. When you listen to the transferred MP3 files using the MB-S1, remove the USB cable from the MB-S1.

### 3. Start transferring

#### 1. Mark a file to be transferred

#### 2. Select a target group for transferring

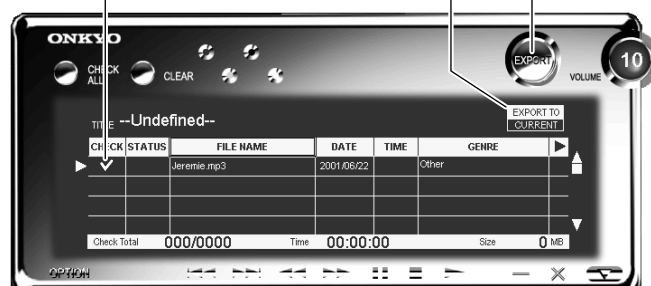

### Progress Bar

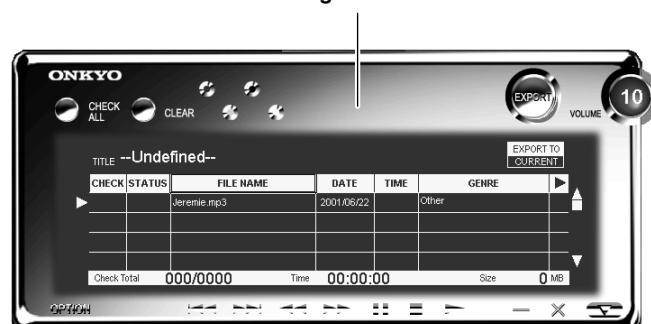

# 故障？と思ったら

まず下の表で点検してみてください。接続した他機に原因がある場合もあります。他機の取扱説明書も参照しながらあわせてご確認ください。

表や他機の取扱説明書で点検しても正常に動作しないときは、電源コードをコンセントから抜き、お買い上げ店、またはオンラインサービスステーションまでご連絡ください。その際に「お名前」「おところ」「電話番号」「製品名MB-S1」と「故障または異常の内容」をできるだけ詳しくお知らせください。

	症 状	原 因	処 置	参照ページ
電 源				
ス ピ ー カ ー				

# 故障?と思ったら

	症 状	原 因	処 置	参照ページ
FM/AM リンク				
音 調と 現象				
リモ コン				

## 故障？と思ったら

	症 状	原 因	処 置	参照ページ
その他				

## エラーメッセージ一覧

メッセージ	意味

※本機に接続した機器の取扱説明書もご覧ください。

※サラウンドモードなどの設定をすべて初期（工場出荷時の設定内容）化したいときは、電源を入れた状態でPRESET MEMORYボタンを押したままSTANDBY/ONボタンを押してください。表示部にCLEARが表示され、スタンバイ状態になります。

※本機はマイクロコンピューターを搭載して高度な機能を実現していますが、このマイクロコンピューターが高性能かつ繊細なため、ごくまれに外部からの雑音や妨害電波、静電気などをひろって誤動作する場合があります。このようなときは、電源コードを壁のコンセントから一度抜き、5秒以上たってからつなぎなおしてください。

製品の故障により正常に録音・録画できなかったことによって生じた損害（CDレンタル料等）については保証対象にはなりませんので大事な録音・録画をするときには、あらかじめ正しく録音・録画できることを確認の上、録音・録画を行ってください。



# オンキヨーご相談窓口・修理窓口のご案内

オンキヨー製品についてのご購入相談はお近くの販売店へ、修理については、お買い求めの販売店へご依頼ください。万が一お困りの場合には、下記の窓口へご相談くださるようお願いいたします。

お 客 様 ご相談窓口	■ <b>カスタマーセンター</b> 受付 9:30~17:30 (土日祝、弊社休日除く)
	■ <b>カタログのご請求、製品についてのご相談</b>
	*e-mail: ホームシアター/オーディオ製品 → customer@onkyo.co.jp マルチメディア製品 → mmcadmin@onkyo.co.jp
	*TEL.: ナビダイヤル0570-01-8111 (全国どこからでも市内料金で通話いただけます) または072-831-8111 (携帯電話、PHSから)へどうぞ。
	*FAX.: 072-831-8124 *〒572-8540 大阪府寝屋川市日新町2-1

オンキヨー製品情報、ユーザー登録ホームページへ → <http://www.onkyo.co.jp>

快適なオーディオライフをお手伝い。ネットショップへ → <http://www.e-onkyo.com>

**修理窓口** 修理のご依頼は、取扱説明書の「故障かな?と思ったときは」または「故障?と思ったときは」の項目をご確認のうえ、ご依頼ください。転居されたり、贈物でいただいたものの故障で、お困りの場合は、下記へご相談ください。

パソコン用スピーカー以外のマルチメディア製品は、

マルチメディアサポートセンター	TEL.072-831-7305 FAX.072-831-8124 〒572-8540 大阪府寝屋川市日新町2-1
-----------------	--

ホームシアター/オーディオ製品とパソコン用スピーカーは、

北海道地区	
札幌サービスステーション	TEL 011-747-6612 FAX 011-747-6619 〒001-0028 札幌市北区北28条西5-1-28 トーシン北28条ビル
青森・岩手・宮城・秋田・山形・福島地区	
仙台サービスステーション	TEL 022-297-0571 FAX 022-257-7330 〒984-0051 仙台市若林区新寺4-9-5 第二丸昌ビル1F
茨城・栃木地区	
宇都宮サービスステーション	TEL 028-634-4307 FAX 028-634-4308 〒320-0831 栃木県宇都宮市新町2-7-7
群馬・埼玉・新潟地区	
大宮サービスステーション	TEL 048-651-8612 FAX 048-651-9137 〒330-0034 埼玉県大宮市土呂町2-29-2 高安ビル1F
千葉・東京(23区)地区	
東京サービスセンター	TEL 03-3861-8121 FAX 03-3861-8124 〒111-0054 東京都台東区鳥越1-2-3 ハマスエビル
東京(23区を除く)・山梨・長野地区	
八王子サービスステーション	TEL 0426-32-8030 FAX 0426-32-8040 〒192-0914 東京都八王子市片倉町358番地
神奈川地区	
横浜サービスステーション	TEL 045-322-9342 FAX 045-312-6603 〒220-0072 横浜市西区浅間町1-13 共益ビル5F
岐阜・静岡・愛知・三重地区	
名古屋サービスステーション	TEL 052-772-1229 FAX 052-772-1331 〒465-0013 名古屋市名東区社口1丁目1001番
富山・石川・福井・滋賀・京都・大阪・兵庫・奈良・和歌山地区	
大阪サービスセンター	TEL 06-6576-7620 FAX 06-6576-7604 〒552-0013 大阪市港区福崎2丁目1番地49号
鳥取・島根・岡山・広島・山口(下関を除く)地区	
広島サービスステーション	TEL 082-262-3315 FAX 082-262-6571 〒732-0057 広島市東区二葉の里2-8-28
徳島・香川・愛媛・高知地区	
高松サービスステーション	TEL 087-868-5662 FAX 087-868-5672 〒760-0079 高松市松縄町44-8 西原ビル1F
山口(下関)・福岡・佐賀・長崎・熊本・大分・宮崎・鹿児島・沖縄地区	
福岡サービスステーション	TEL 092-418-1357 FAX 092-418-1358 〒812-0006 福岡市博多区上牟田3-8-19 みなみビル202

2001年01月現在 お客様相談窓口・修理窓口の名称、所在地、電話番号は変更になる場合がございますのでご了承ください。

F

## **ONKYO CORPORATION**

Sales & Product Planning Div. : 2-1, Nisshin-cho, Neyagawa-shi, OSAKA 572-8540, JAPAN  
Tel: 072-831-8111 Fax: 072-833-5222

### **ONKYO U.S.A. CORPORATION**

18 Park Way, Upper Saddle River, N.J. 07458, U.S.A.  
Tel: 201-785-2600 Fax: 201-785-2650 <http://www.onkyousa.com>

### **ONKYO EUROPE ELECTRONICS GmbH**

Industriestrasse 20, 82110 Germering, GERMANY  
Tel: 089-849-320 Fax: 089-849-3265 E-mail: [info@onkyo.de](mailto:info@onkyo.de)

### **ONKYO CHINA LIMITED**

Units 2102-2107, Metroplaza Tower I, 223 Hing Fong Road, Kwai Chung,  
N.T., HONG KONG Tel: 852-2429-3118 Fax: 852-2428-9039



# Errata

Page	Incorrect	Correct																				
9	<p>⑮ <b>Level indicator</b></p> <p>“Shows the audio level for the current track or the position currently playing.”</p>	<p>“Shows the audio level for the current track or the position currently playing. When in the group mode, the left level meter shows the position of the current group to the all groups while the right level meter shows the position of the current track to the group.”</p>																				
13	<p><b>[Connecting to other components]</b></p> <p>..... When connecting, refer to the diagram on page 15.”</p>	<p>..... When connecting, refer to the diagram on page 12.”</p>																				
19	<p><b>In step 2 of [Setting date and time]</b></p> <p>“The menu items are displayed in the following order: Clock Setting?, Timer Setting?, Rec Level?.”</p>	<p>“The menu items are displayed in the following order: Clock Setting?, Timer Setting?, AnaRecSetting?.”</p>																				
20 26 34	<p><b>[Reversing and fast forwarding]</b></p> <p><b>Replace all of the descriptions on pages 20, 26, and 34 to the sentences on the right.</b></p>	<p>“During playback, hold down the ◀◀/◀◀ or ▶▶/▶▶ button for 0.5 seconds or longer to reverse or fast forward the current track. At first, reverse and fast forward is eight times faster than normal speed playback, and then will be 16, 32, and 64 times faster. When the reverse or fast-forward comes to your desired position, release the ◀◀/◀◀ or ▶▶/▶▶ button to resume normal playback.</p> <p>The sound is not output while reversing or fast forwarding. While reversing, when the HDR-1/MB-S1 comes to the beginning of the track, the playback of that track starts in normal speed. While fast forwarding, when the HDR-1/MB-S1 comes to the beginning of the next track, the playback of the next track starts in normal speed.”</p>																				
23	<p><b>Add Tip</b></p>	<p><b>Tip:</b></p> <p>If you want to stop the CD synchronous recording or the CD dubbing during operation, press the ■ (Stop) button.</p>																				
24	<p><b>Add a description to [Notice]</b></p>	<p>While waiting an input signal, “Signal Wait” appears.</p>																				
25	<p><b>When recording from external audio devices</b></p> <table border="1" style="width: 100%; border-collapse: collapse;"> <thead> <tr> <th style="text-align: center;">Operation Input source</th> <th style="text-align: center;">Recording mode (RECMODE)</th> <th style="text-align: center;">QUICK indication</th> <th style="text-align: center;">Recording level</th> </tr> </thead> <tbody> <tr> <td style="text-align: center;">DIGITAL-1 DIGITAL-2 ANALOG</td> <td style="text-align: center;">PCM</td> <td style="text-align: center;">Normal</td> <td style="text-align: center;">—</td> </tr> <tr> <td></td> <td style="text-align: center;">MP3 96/128/ 192 kbps</td> <td style="text-align: center;">Normal</td> <td style="text-align: center;">Available (Analog only)</td> </tr> </tbody> </table>	Operation Input source	Recording mode (RECMODE)	QUICK indication	Recording level	DIGITAL-1 DIGITAL-2 ANALOG	PCM	Normal	—		MP3 96/128/ 192 kbps	Normal	Available (Analog only)	<table border="1" style="width: 100%; border-collapse: collapse;"> <thead> <tr> <th style="text-align: center;">Operation Input source</th> <th style="text-align: center;">Recording mode (RECMODE)</th> <th style="text-align: center;">QUICK indication</th> <th style="text-align: center;">Recording level</th> </tr> </thead> <tbody> <tr> <td style="text-align: center;">DIGITAL-1 DIGITAL-2 ANALOG</td> <td style="text-align: center;">PCM MP3 96/128/ 192 kbps</td> <td style="text-align: center;">Normal</td> <td style="text-align: center;">—  Available (Analog only)</td> </tr> </tbody> </table>	Operation Input source	Recording mode (RECMODE)	QUICK indication	Recording level	DIGITAL-1 DIGITAL-2 ANALOG	PCM MP3 96/128/ 192 kbps	Normal	—  Available (Analog only)
Operation Input source	Recording mode (RECMODE)	QUICK indication	Recording level																			
DIGITAL-1 DIGITAL-2 ANALOG	PCM	Normal	—																			
	MP3 96/128/ 192 kbps	Normal	Available (Analog only)																			
Operation Input source	Recording mode (RECMODE)	QUICK indication	Recording level																			
DIGITAL-1 DIGITAL-2 ANALOG	PCM MP3 96/128/ 192 kbps	Normal	—  Available (Analog only)																			
26	<p><b>In step 2 of [Listening to tracks recorded on the HDD]</b></p> <p>“Press the PLAY/PAUSE button to start playing from the first track in the first group. <span style="border: 1px solid black; padding: 0 5px;">▶<sup>HDD</sup></span> lights in the display area.”</p>	<p>“Press the PLAY/PAUSE button to start playing from the group and track you selected last time. <span style="border: 1px solid black; padding: 0 5px;">▶<sup>HDD</sup></span> lights in the display area. If you want to change the group, turn the jog dial to select a group you want to play.”</p>																				
28	<p><b>[Entering the name of a track]</b></p> <p>“For the tracks recorded on the HDD, you can enter the track information such as track title, album title and genre.”</p>	<p>“For the tracks recorded on the HDD, you can enter the track information such as track title, album title and genre. Stop playback before you enter track information.”</p>																				
28	<p><b>Add Tip to [Entering characters]</b></p>	<p><b>Tip:</b></p> <p>If you want to insert space, enter the ▶ sign.</p>																				

**Notice:**

The HDR-1/MB-S1 does not support 2-byte character code. When you play CDs or music files on the HDD which contain some 2-byte character, the track information will not be displayed properly.

**Notes on Carry Tunes:**

- Some of MP3 files such as RIFF WAV format file is not supported.
- When the tag information contained in MP3 file is broken or invalid, Carry Tunes may not operate properly.

# Indemnification notices on the HDD and the music data stored on the HDD

---

The HDR-1/MB-S1 employs the advanced high performance HDD to enable the long hour recording of any audio sources and the convenient and comfortable playback functions that have never been achieved in conventional audio devices. In spite of superior functions of the HDR-1/MB-S1, the following notices on the HDD should be reminded when using the HDR-1/MB-S1.

## 1. HDD failure

The HDD used to record music is composed of very delicate components. Onkyo pays the greatest care for the quality of the product, but in the event of the HDD failure, whatever the cause of the failure may be, the HDD component cannot be overhauled and will be replaced with the new HDD component in repair operation. Therefore, Onkyo shall have no liability for any music and data recorded on the HDD, including restoring data.

## 2. HDD life

In general, HDDs have life limit in usual usage, caused from wear or breakage of component, and other factors. The longevity of the HDD may last several years depending on the condition of usage. In this case, Onkyo will provide a service for replacing the HDD, but shall have no liability for any music and data recorded on the HDD, including restoring data.

## 3. Loss of music and other data recorded on the HDD

If all of or any part of music and data recorded on the HDD is lost due to a failure or malfunction of the HDR-1/MB-S1, or an operation mistake when using the HDR-1/MB-S1, Onkyo shall have no liability for loss of any music and data recorded on the HDD, including restoring data.

### Notice:

For the purpose of copyright protection, the HDR-1/MB-S1 does not allow you to perform digital copying of the music data recorded on the HDD to other media or devices.

In case of loss of music data on the HDD due to a failure or malfunction of the HDD, re-recording the music to the HDD will be required. To prepare against the loss of music data, do the following.

- Make sure to keep the original source of music data such as CDs, records, cassette tapes and others.
- When the original source of music data was temporary source like radio programs, be sure to duplicate the music data onto other recording media.

# WARRANTY DEPARTMENT

ONKYO USA CORPORATION  
18PARK WAY  
UPPER SADDLE RIVER, NJ 07458 USA



# ONKYO®

Tape here

POST OFFICE  
WILL NOT  
DELIVER  
WITHOUT  
PROPER POSTAGE

## 7 Days Customer Service

In order to better assist you with your purchase, Onkyo is extending its customer service hours to a seven-day schedule. For questions, assistance, or comments Please call or e-mail us at the following:

**Phone: 1-800-229-1687**

**E-mail: [Onkyo@onkyousa.com](mailto:Onkyo@onkyousa.com)**

For information concerning product features and hookups, please include your name and daytime phone number along with the model number you are inquiring about for a response from a product specialist.

### Hours of Operation:

Mon – Fri 9:00am – 5pm (Eastern Standard Time) Soon to be extended  
Sat – Sun 10:00am – 4pm (Eastern Standard Time) Soon to be extended

### OBTAINING WARRANTY SERVICE:

To obtain warranty service, take or ship your Onkyo product to an Onkyo authorized service station, together with a note describing your complaint and your copy of the dated purchase receipt. If you choose to ship your Onkyo product to an Onkyo authorized service station, all shipping arrangement must be made by you and all shipping charges and insurance must be fully prepaid. Any Onkyo product shipped in its entirety must be shipped in its original carton. Onkyo will pay all return shipping charges for Onkyo products that have been serviced under this warranty.

### LIMITATIONS:

Onkyo makes this warranty subject to the following limitations:

1. This Warranty is valid only within the territory of the United States of America. To be covered by this warranty the Onkyo product concerned must have been originally purchase and the person seeking warranty service must reside in one of the states of the United States of America or in the District of Colombia.
2. ONKYO SHALL HAVE NO LIABILITY WHATSOEVER FOR INCIDENTAL OR CONSEQUENTIAL DAMAGES. THE RESPONSIBILITY OF ONKYO UNDER THIS WARRANTY SHALL BE LIMITED TO THE REPAIR OF DEFECTIVE ONKYO PRODUCTS BY ONKYO OR ITS AUTHORIZED SERVICE STATIONS.
3. This warranty is valid only with respect to repairs effected by Onkyo or an Onkyo authorized service station.
4. ALL WARRANTIES OTHER THAN THE EXPRESS WARRANTY HEREIN CONTAINED INCLUDING BUT NOT LIMITED TO ANY IMPLIED WARRANTY OF MERCHANTABILITY OR FITNESS FOR A PARTICULAR PURPOSE ARE LIMITED IN DURATION TO THE APPLICABLE WARRANTY PERIOD SET FORTH ABOVE.

Some states do not allow limitations on how long an implied warranty lasts and some states do not allow the exclusion or limitation of incidental or consequential damages, so the above limitations or exclusion may not apply to you. This warranty gives you specific legal rights and you may also have other rights that vary from state to state.

Model \_\_\_\_\_

Serial No. \_\_\_\_\_

Customer's Name \_\_\_\_\_

Dealer's Name \_\_\_\_\_

Date of Purchase \_\_\_\_\_

### ONKYO USA CORPORATION

18 Park Way  
Upper Saddle River, NJ 07458 USA

Phone: 201-785-2600  
Fax : 201-785-2650  
<http://www.onkyousa.com>

# ONKYO Product REGISTRATION CARD

**Thank you** for purchasing our product. In order to protect your investment and to ensure that you receive information on new products, future updates or new releases, please register your product. You have two ways to do it.

## - Quick and Easy -

Please visit our web site for your on-line registration at

<http://www.onkyousa.com>

Or please fill out this registration card and return it to us. Please remember to keep your receipt of your purchase for warranty and the other part of this card for future reference.

First Name \_\_\_\_\_ Middle Initial \_\_\_\_\_ Last Name \_\_\_\_\_

Address \_\_\_\_\_ Apt/Suite \_\_\_\_\_

City \_\_\_\_\_ State \_\_\_\_\_ Zip \_\_\_\_\_

E-mail Address \_\_\_\_\_ Phone Number \_\_\_\_\_

Age:  18 - 24  25 - 31  32 - 40  41 - 60  61 +  Male  Female

Name and location of the Dealer you purchased the product from? \_\_\_\_\_

Date of Purchase \_\_\_\_\_ Model \_\_\_\_\_ Serial Number \_\_\_\_\_

Would you like to receive a product catalog every new model year?

Yes  No

How did you learn about Onkyo Products?

Advertisement  Review  Salesman  Friend  Other

Do you own other Onkyo Products? \_\_\_\_\_ If yes, what is the model number

Yes  No

What other brands of stereo products or multi media products have you owned before? \_\_\_\_\_

What factors influenced your purchase decision?

Features  Sound  Quality  Design  Price  Recommendation

What other Audio/Video/multi media Equipment are you looking to purchase in the future? \_\_\_\_\_

When do you plan to purchase your next audio or multi media product?

3 Months  6 Months  9 Months  12 Months  24 Months

Other Comments/Suggestions about this product \_\_\_\_\_

## ONKYO USA CORPORATION

18 Park Way  
Upper Saddle River, NJ 07458 USA  
Phone: 201-785-2600  
Fax : 201-785-2650  
<http://www.onkyousa.com>

## Onkyo Limited Warranty

**PLEASE RETAIN YOUR ORIGINAL BILL OF SALE. YOU WILL NEED TO PRESENT IT SHOULD YOU REQUIRE SERVICE UNDER THIS WARRANTY.**

Onkyo USA Corporation ( hereinafter referred to as Onkyo ) hereby warrants all Onkyo products sold by Onkyo or Onkyo authorized dealers in accordance with the following terms and conditions:

### WARRANTY PERIOD:

Receivers & Amplifiers  
Tuners, Equalizers & Processors  
Home Theater Speakers 2 years Parts & labor

Cassette Decks  
Mini Disc  
CD, DVD Players  
Virtual Dolby  
Mini systems 1 year Parts & labor

### TERMS OF WARRANTY:

From the date of original purchase and for the respective periods specified above, Integra agrees to repair at its sole expense, all Integra products, which are defective in material and/or workmanship.

### EXCLUSIONS:

This Warranty does not apply with respect to the following:

1. Defects or damage caused by accident, fire, flood, lightning or other acts of nature.
2. Defects or damage caused by abuse, misuse, negligence or failure to observe the instructions contained in the manual furnished at the time of original purchase.
3. Damage caused during shipment or handling.
4. Products that have had their serial numbers altered or removed.
5. Products purchased in 'AS IS' condition.
6. Products that have been altered or repaired by anyone other than Onkyo or an Onkyo authorized service station in a manner that has affected their performance, stability or reliability.
7. Accessories attached to or to be used with Onkyo products, such as antennas, cables, etc.
8. Packing materials, batteries, antennas & cosmetic items.
9. Parts which have prescribed useful lives dependent upon the degree of their use, such as styli, cassette heads, idler wheels, etc.
10. Installation & removal of Onkyo products.
11. Maintenance, cleaning or periodic check-ups.
12. Adjustments or alteration required for compatibility with conditions pertaining to foreign countries.
13. This equipment is intended for consumers' use and is not designed for continuous or commercial use. In the event that this equipment is used commercially or continuously, the warranty period is limited to 90 days.

## Free Manuals Download Website

<http://myh66.com>

<http://usermanuals.us>

<http://www.somanuals.com>

<http://www.4manuals.cc>

<http://www.manual-lib.com>

<http://www.404manual.com>

<http://www.luxmanual.com>

<http://aubethermostatmanual.com>

Golf course search by state

<http://golfingnear.com>

Email search by domain

<http://emailbydomain.com>

Auto manuals search

<http://auto.somanuals.com>

TV manuals search

<http://tv.somanuals.com>