

ONKYO®

DVD Player

DV-SP501

Instruction Manual

Thank you for purchasing the Onkyo DV-SP501 DVD Player. Read this manual carefully before using your new DVD Player. A good understanding of its features and operation will allow you to achieve optimum performance and enjoyment.

Keep this manual for future reference.

Contents

Important Safety Instructions	2
Introduction	7
Connecting the DV-SP501	18
Getting Started	24
Playing discs	29
Viewing JPEG discs	40
Audio Settings menu	42
Video Adjust menu	43
Initial Settings menu	44
Additional information	50
Using the RC-524DV Remote controller with TVs from Other Manufacturers (North American model only).....	54
Troubleshooting	57



WARNING:

TO REDUCE THE RISK OF FIRE OR ELECTRIC SHOCK, DO NOT EXPOSE THIS APPARATUS TO RAIN OR MOISTURE.

CAUTION:

TO REDUCE THE RISK OF ELECTRIC SHOCK, DO NOT REMOVE COVER (OR BACK). NO USER-SERVICEABLE PARTS INSIDE. REFER SERVICING TO QUALIFIED SERVICE PERSONNEL.



WARNING
RISK OF ELECTRIC SHOCK
DO NOT OPEN

AVIS
RISQUE DE CHOC ELECTRIQUE
NE PAS OUVRIR



The lightning flash with arrowhead symbol, within an equilateral triangle, is intended to alert the user to the presence of uninsulated "dangerous voltage" within the product's enclosure that may be of sufficient magnitude to constitute a risk of electric shock to persons.



The exclamation point within an equilateral triangle is intended to alert the user to the presence of important operating and maintenance (servicing) instructions in the literature accompanying the appliance.

Important Safety Instructions

1. Read these instructions.
2. Keep these instructions.
3. Heed all warnings.
4. Follow all instructions.
5. Do not use this apparatus near water.
6. Clean only with dry cloth.
7. Do not block any ventilation openings. Install in accordance with the manufacturer's instructions.
8. Do not install near any heat sources such as radiators, heat registers, stoves, or other apparatus (including amplifiers) that produce heat.
9. Do not defeat the safety purpose of the polarized or grounding-type plug. A polarized plug has two blades with one wider than the other. A grounding type plug has two blades and a third grounding prong. The wide blade or the third prong are provided for your safety. If the provided plug does not fit into your outlet, consult an electrician for replacement of the obsolete outlet.
10. Protect the power cord from being walked on or pinched particularly at plugs, convenience receptacles, and the point where they exit from the apparatus.
11. Only use attachments/accessories specified by the manufacturer.
12. Use only with the cart, stand, tripod, bracket, or table specified by the manufacturer, or sold with the apparatus. When a cart is used, use caution when moving the cart/apparatus combination to avoid injury from tip-over.

PORTABLE CART WARNING
S3125A
13. Unplug this apparatus during lightning storms or when unused for long periods of time.
14. Refer all servicing to qualified service personnel. Servicing is required when the apparatus has been damaged in any way, such as power-supply cord or plug is damaged, liquid has been spilled or objects have fallen into the apparatus, the apparatus has been exposed to rain or moisture, does not operate normally, or has been dropped.
15. Damage Requiring Service
Unplug the apparatus from the wall outlet and refer servicing to qualified service personnel under the following conditions:
 - A. When the power-supply cord or plug is damaged,
 - B. If liquid has been spilled, or objects have fallen into the apparatus,
 - C. If the apparatus has been exposed to rain or water,
 - D. If the apparatus does not operate normally by following the operating instructions. Adjust only those controls that are covered by the operating instructions as an improper adjustment of other controls may result in damage and will often require extensive work by a qualified technician to restore the apparatus to its normal operation,
 - E. If the apparatus has been dropped or damaged in any way, and
 - F. When the apparatus exhibits a distinct change in performance this indicates a need for service.
16. Object and Liquid Entry
Never push objects of any kind into the apparatus through openings as they may touch dangerous voltage points or short-out parts that could result in a fire or electric shock.
The apparatus shall not be exposed to dripping or splashing and no objects filled with liquids, such as vases shall be placed on the apparatus.
Don't put candles or other burning objects on top of this unit.
17. Batteries
Always consider the environmental issues and follow local regulations when disposing of batteries.
18. If you install the apparatus in a built-in installation, such as a bookcase or rack, ensure that there is adequate ventilation.
Leave 20 cm (8") of free space at the top and sides and 10 cm (4") at the rear. The rear edge of the shelf or board above the apparatus shall be set 10 cm (4") away from the rear panel or wall, creating a flue-like gap for warm air to escape.

Precautions

This unit contains a semiconductor laser system and is classified as a "CLASS 1 LASER PRODUCT". So, to use this model properly, read this Instruction Manual carefully. In case of any trouble, please contact the store where you purchased the unit.

To prevent being exposed to the laser beam, do not try to open the enclosure.

DANGER:

VISIBLE AND INVISIBLE LASER RADIATION WHEN OPEN AND INTERLOCK FAILED OR DEFEATED. DO NOT STARE INTO BEAM.

CAUTION:

THIS PRODUCT UTILIZES A LASER. USE OF CONTROLS OR ADJUSTMENTS OR PERFORMANCE OF PROCEDURES OTHER THAN THOSE SPECIFIED HEREIN MAY RESULT IN HAZARDOUS RADIATION EXPOSURE.

The label on the right is applied on the rear panel except for USA and Canadian models.



1. This unit is a CLASS 1 LASER PRODUCT and employs a laser inside the cabinet.
2. To prevent the laser from being exposed, do not remove the cover. Refer servicing to qualified personnel.

For U.S. model

The laser is covered by a housing which prevents exposure during operation or maintenance. However, this product is classified as a Laser Product by CDRH (Center for Devices and Radiological Health) which is a department of the Food and Drug Administration.

According to their regulations 21 CFR section 1002.30, all manufacturers who sell Laser Products must maintain records of written communications between the manufacturer, dealers and customers concerning radiation safety. If you have any complaints about instructions or explanations affecting the use of this product, please feel free to write to the address on the back page of this manual. When you write us, please include the model number and serial number of your unit.

In compliance with Federal Regulations, the certification, identification and the period of manufacture are indicated on the rear panel.

FCC INFORMATION FOR USER

CAUTION:

The user changes or modifications not expressly approved by the party responsible for compliance could void the user's authority to operate the equipment.

NOTE:

This equipment has been tested and found to comply with the limits for a Class B digital device, pursuant to Part 15 of the FCC Rules.

These limits are designed to provide reasonable protection against harmful interference in a residential installation. This equipment generates, uses and can radiate radio frequency energy and, if not installed and used in accordance with the instructions, may cause harmful interference to radio communications. However, there is no guarantee that interference will not occur in a particular installation.

If this equipment does cause harmful interference to radio or television reception, which can be determined by turning the equipment off and on, the user is encouraged to try to correct the interference by one or more of the following measures:

- Reorient or relocate the receiving antenna.
- Increase the separation between the equipment and receiver.
- Connect the equipment into an outlet on a circuit different from that to which the receiver is connected.
- Consult the dealer or an experienced radio/TV technician for help.

For Canadian model

NOTE: This class B digital apparatus complies with Canadian ICES-003.

For models having a power cord with a polarized plug:

CAUTION: TO PREVENT ELECTRIC SHOCK, MATCH WIDE BLADE OF PLUG TO WIDE SLOT, FULLY INSERT.

Modèle pour les Canadien

REMARQUE: Cet appareil numérique de la classe B est conforme à la norme NMB-003 du Canada.

Sur les modèles dont la fiche est polarisée:

ATTENTION: POUR ÉVITER LES CHOCS ÉLECTRIQUES, INTRODUIRE LA LAME LA PLUS LARGE DE LA FICHE DANS LA BORNE CORRESPONDANTE DE LA PRISE ET POUSSER JUSQU'AU FOND.

For British models

Replacement and mounting of an AC plug on the power supply cord of this unit should be performed only by qualified service personnel.

IMPORTANT

The wires in the mains lead are coloured in accordance with the following code:

Blue: Neutral
Brown: Live

As the colours of the wires in the mains lead of this apparatus may not correspond with the coloured markings identifying the terminals in your plug, proceed as follows:

The wire which is coloured blue must be connected to the terminal which is marked with the letter N or coloured black.

The wire which is coloured brown must be connected to the terminal which is marked with the letter L or coloured red.

IMPORTANT

A 5 ampere fuse is fitted in this plug. Should the fuse need to be replaced, please ensure that the replacement fuse has a rating of 5 amperes and that it is approved by ASTA or BSI to BS1362. Check for the ASTA mark or the BSI mark on the body of the fuse.

IF THE FITTED MOULDED PLUG IS UNSUITABLE FOR THE SOCKET OUTLET IN YOUR HOME THEN THE FUSE SHOULD BE REMOVED AND THE PLUG CUT OFF AND DISPOSED OF SAFELY. THERE IS A DANGER OF SEVERE ELECTRICAL SHOCK IF THE CUT OFF PLUG IS INSERTED INTO ANY 13 AMPERE SOCKET.

If in any doubt, consult a qualified electrician.

For European Models

Declaration of Conformity	
We, ONKYO EUROPE ELECTRONICS GmbH LIEGNITZERSTRASSE 6, 82194 GROEBENZELL, GERMANY	
declare in own responsibility, that the ONKYO product described in this instruction manual is in compliance with the corresponding technical standards such as EN60065, EN55013, EN55020 and EN61000-3-2, -3-3.	
GROEBENZELL, GERMANY	 I. MORI
ONKYO EUROPE ELECTRONICS GmbH	

1. Region Numbers

The DVD standard uses region numbers to control how discs can be played around the world, the world being divided into six regions. This unit will only play DVD discs that match its region number, which can be found on its rear panel (e.g., ).

2. About this Manual

This manual explains how to use all of this unit's functions. Although the DVD standard offers many special features, not all discs use them all, so depending on the disc being played, this unit may not respond to certain functions. See the disc's sleeve notes for supported features.

When you attempt to use a DVD feature that is not available, this logo may appear onscreen, indicating that the feature is not supported by the current disc or this unit. 

3. Recording Copyright

Unless it's for personal use only, recording copyrighted material is illegal without the permission of the copyright holder.

4. Power

WARNING

BEFORE PLUGGING IN THE UNIT FOR THE FIRST TIME, READ THE FOLLOWING SECTION CAREFULLY.

AC outlet voltages vary from country to country. Make sure that the voltage in your area meets the voltage requirements printed on this unit's rear panel (e.g., AC 120 V, 60 Hz).

5. Never Touch this Unit with Wet Hands

Never handle this unit or its power cord while your hands are wet or damp. If water or any other liquid gets inside this unit, have it checked by your Onkyo dealer.

6. Installing this Unit

- Install this unit in a well-ventilated location. Ensure that there's adequate ventilation all around this unit, especially if it's installed in an audio rack. If the ventilation is inadequate, the unit may overheat, leading to malfunction.
- Do not expose this unit to direct sunlight or heat sources, because its internal temperature may rise, shortening the life of the optical pickup.
- Avoid damp and dusty places, and places subject to vibrations from loudspeakers. Never put the unit on top of, or directly above a loudspeaker.
- Install this unit horizontally. Never use it on its side or on a sloping surface, because it may cause a malfunction.
- If you install this unit near a TV, radio, or VCR, the picture and sound quality may be affected. If this occurs, move this unit away from the TV, radio, or VCR.

7. Care

Occasionally, you should dust this unit all over with a soft cloth. For stubborn stains, use a soft cloth dampened with a weak solution of mild detergent and water. Dry the unit immediately afterwards with a clean cloth. Do not use abrasive cloths, thinners, alcohol, or other chemical solvents, because they may damage the finish or remove the panel lettering.

8. Handling Notes

- If you need to transport this unit, use the original packaging to pack it how it was when you originally bought it.
- Do not use volatile liquids, such as insect sprays, near this unit. Do not leave rubber or plastic items on this unit for a long time, because they may leave marks on the case.
- This unit's top and rear panels may get warm after prolonged use. This is normal.
- When you've finished using this unit, remove all discs and turn off the power.
- If you do not use this unit for a long time, it may not work properly the next time you turn it on, so be sure to use it occasionally.

9. To Obtain a Clear Picture

This unit is a high-tech, precision device. If the lens on the optical pickup, or the disc drive mechanism becomes dirty or worn, the picture quality may be affected. To maintain the best picture quality, we recommend regular inspection and maintenance (cleaning or worn part replacement) every 1,000 hours of use depending on the operating environment. Contact your Onkyo dealer for details.

10. Moisture Condensation

Moisture condensation may damage this unit.

Read the following carefully:

When you take a glass containing a cold drink outside on a summer's day, drops of water, called condensation, form on the outside of the glass. Similarly, moisture may condense on the lens of the optical pickup, one of the most important parts inside this unit.

- Moisture condensation can occur in the following situations:
 - The unit is moved from a cold place to a warm place.
 - A heater is turned on, or cold air from an air conditioner is hitting the unit.
 - In the summer, when this unit is moved from an air conditioned room to a hot and humid place.
 - The unit is used in a humid place.
- Do not use this unit when there's the possibility of moisture condensation occurring. Doing so may damage your discs and certain parts inside this unit. If condensation does occur, remove all discs and leave this unit turned on for two to three hours. By this time, the unit will have warmed up and any condensation will have evaporated. To reduce the risk of condensation, keep this unit connected to a wall outlet.

Table of Contents

Basic Operation

Overview

Important Safety Instructions.....	2
Precautions	3
Introduction.....	7
Supplied Accessories	7
DV-SP501 Features	7
Disc Notes	8
Before Using the DV-SP501.....	11
Installing the Batteries	11
Using the Remote Controller	11
Front & Rear Panels.....	12
Front Panel.....	12
Display.....	13
Rear Panel (Other than European model)	14
Rear Panel (European model).....	15
Remote Controller	16

Connections

Connecting the DV-SP501	18
Before Making Any Connections	18
AV Cables & Connectors.....	18
Basic Setup	19
Connecting Your TV	20
Connecting to an AV Receiver	21
Connecting RI -compatible Components	22
Connecting the Power/Turning on the DV-SP501	23

Getting Started and Setting up

Getting Started	24
Using the on-screen displays	24
Setting up with the Setup Navigator	24

Basic Playback

Playing discs.....	26
Basic playback controls	27
Resume and Last Memory	27
DVD-Video disc menus	28
Video CD PBC menus	28

Advanced Operation

Playback Techniques

Playing discs	29
Using the Disc Navigator to browse the contents of a disc	29
Scanning discs	30
Playing in slow motion	30
Frame advance/frame reverse	31
Looping a section of a disc.....	31
Using repeat play.....	32
Using random play.....	33

Creating a program list.....	34
Editing a program list	35
Other functions available from the program menu	36
Searching a disc	36
Switching subtitles	37
Switching DVD audio language	37
Switching VR format DVD-RW audio channel	37
Switching audio channel when playing a Video CD	37
Zooming the screen	38
Switching camera angles	38
Displaying disc information	39
Viewing JPEG discs.....	40
Viewing JPEG discs.....	40
Using the JPEG Disc Navigator and Photo Browser.....	40
Using the Photo Browser	41
Zooming the screen	41

Detailed Settings

Audio Settings menu.....	42
Audio DRC	42
Video Adjust menu.....	43
Video Adjust.....	43
Initial Settings menu	44
Using the Initial Settings menu	44
Digital Audio Out settings.....	44
Video Output settings.....	45
Language settings.....	46
Display settings.....	47
Options.....	48
PhotoViewer.....	49

Miscellaneous information

Additional information	50
Screen sizes and disc formats	50
Resetting the player	50
Setting the TV system.....	50
Titles, chapters and tracks	51
DVD-Video regions	51
Selecting languages using the language code list	51
Country code list	52
Language code list.....	53
Using the RC-524DV Remote controller with TVs from Other Manufacturers (North American model only)	54
Glossary.....	56
Troubleshooting	57
Specifications.....	60

Introduction

Supplied Accessories

Make sure you have the following accessories:

North American models:
RC-524DV

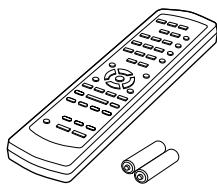

Other models:
RC-523DV

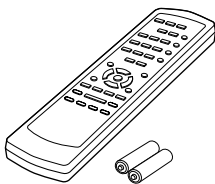

Remote controller & 2 batteries (AA)

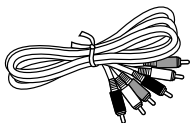

AV cable (RCA/phono) (59-1/16" / 1.5 m)



S-Video cable (59-1/16" / 1.5 m)



RI cable (31-7/16" / 0.8 m)

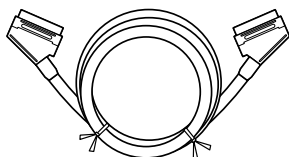

**SCART cable (European models only)
(59-1/16" / 1.5 m)**

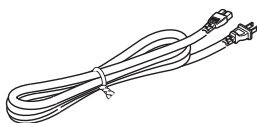

Power cord (78-3/4" / 2 m)

Shape may vary depending on the area which it was purchased.

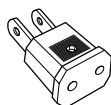

Power-plug adapter

Only supplied in certain countries. Use this adapter if your AC outlet does not match with the plug on the DV-SP501's power cord. (Adapter varies from country to country.)

DV-SP501 Features

Highlights

- Dolby ^{*1} Digital and DTS ^{*2}
- DVD-Video / Video CD / Audio CD playback
- CD-R, CD-RW (Video CD, audio CD, MP3/WMA ^{*3}/JPEG)
- DVD-R (DVD-Video)
- DVD-RW (DVD-Video, VR format)
- Vector Linear Shaping Circuitry

Video

- Advanced 54 MHz/10-bit video D/A converter
- Component video output
- S-Video and composite video outputs
- Frame-by-frame playback
- Slow motion playback
- Fast forward and reverse
- Repeat playback
- Random playback
- Supports 4:3 and 16:9 aspect ratio TVs
- Multiple camera angle support
- Parental Lock function
- Screen Saver function

Audio

- Direct digital path for signal purity
- 192 kHz/24-bit D/A converter
- Optical / Coaxial digital output

Others

- Dynamic Range Control setting
- Adjustable display brightness
- Full-function remote controller
- Use the remote controller to control your TV (North American models only)

The letter displayed at the end of the product name found in catalogs and on package represents the color of the DV-SP501 DVD player. Though the color varies, the specifications and operations are the same.

*1. Manufactured under license from Dolby Laboratories. "Dolby" and the double-D symbol are trademarks of Dolby Laboratories.

*2. "DTS" and "DTS Digital Out" are trademarks of Digital Theater Systems, Inc.







*3. Windows Media, and the Windows logo are trademarks, or registered trademarks of Microsoft Corporation in the United States and/or other countries.



Disc Notes

Supported Discs

The DV-SP501 supports the following discs.

Disc	Logo	Format or file type
DVD-Video		See page 51 for region information.
DVD-R		DVD-Video
DVD-RW		DVD-Video, VR format
Video CD		Including PBC
Audio CD		PCM and DTS
CD-R		Video CD, audio CD, MP3, WMA, JPEG
CD-RW		Video CD, audio CD, MP3, WMA, JPEG
JPEG CD		JPEG

- Some audio CDs feature copy protection that doesn't conform to the official CD standard. Since these are nonstandard discs, they may not play properly in the DV-SP501.
- The DV-SP501 supports CD-R and CD-RW discs recorded in Video CD format, audio CD format, or ISO 9660 Level 1 or 2 format with MP3, WMA, and JPEG files. It also supports DVD-R and DVD-RW discs recorded in DVD-Video format. However, some CD-R, CD-RW, DVD-R, and DVD-RW discs may not work properly for any of the following reasons: incomplete disc finalization, disc burner characteristics, disc characteristics, the disc is damaged or dirty. See the manual supplied with your disc burner for more information. Condensation or dirt on the optical pickup lens can also affect playback.
- The DV-SP501 supports 8 cm and 12 cm discs.
- The DV-SP501 does not support disc types not listed.

- Don't use discs with an unusual shape, such as those shown below, because you may damage the DV-SP501.



- Don't use discs that have residue from adhesive tape, rental discs with peeling labels, or discs with custom-made labels or stickers. Doing so may damage the DV-SP501 and you may not be able to remove the disc properly.

Discs Made on Personal Computers

Discs made on personal computers, including those of a compatible format, may not work properly in the DV-SP501 because of incorrect settings in the disc burning software. Check the manuals supplied with your disc burning software for additional compatibility information.

About WMA

WMA is short for Windows Media Audio and refers to an audio compression technology developed by Microsoft Corporation. WMA data can be encoded by using Windows Media Player version 8 or later or Windows Media Player for Windows XP. Windows Media and the Windows logo are trademarks or registered trademarks of Microsoft Corporation in the United States and/or other countries.

MP3/WMA Compatibility

- This unit will play CD-R, and CD-RW discs containing files saved in the MPEG-1 Audio Layer 3 (MP3) or Windows Media Audio (WMA) format with a sampling rate of 32*, 44.1 or 48 kHz. Incompatible files will not play and the message “Can’t play this format” will be displayed (“NO PLAY” in the front panel display).
* This unit will not play 32 kHz WMA files encoded at 20 kbps.
- Fixed bit-rate MP3 files are recommended. Variable bit-rate (VBR) MP3 files are playable, but playing times may not be shown correctly.
- This player is compatible with WMA data encoded using Windows Media Player version 8 (or less) or Windows Media Player for Windows XP.
- This player is not compatible with lossless-encoding or variable bit-rate (VBR) WMA files.
- WMA files encoded with DRM (Digital Rights Management) copy protection will not play and the message “Can’t play this format” will be displayed (“NO PLAY” in the front panel display).
- WMA/MP3 discs must be ISO 9660 Level 1 or 2 compliant. CD physical format: Mode1, Mode2 XA Form1. Romeo and Joliet file systems are both compatible with this player.
- Use CD-R or CD-RW media for recording your files. The disc must be finalized (i.e. the session must be closed) in order to play in this unit. This player is not compatible with multi-session discs. Only the first session of a multi-session disc will be recognized.
- This player only plays tracks that are named with the file extension .mp3, .MP3, .wma, or .WMA.
- When naming MP3 and WMA files, add the corresponding file name extension (.mp3 or .wma). Files are played according to the file extension. To prevent noise and malfunctions, do not use these extensions for other kinds of files.
- This player can recognize up to 999 files (WMA/MP3/JPEG) and up to 499 folders. If a disc exceeds these limits, only files and folders up to these limits will be playable. Files and folders are read/displayed in alphabetical order. Note that if the file structure is very complex, you may not be able to read/play all files on the disc.
- Folder and track names (excluding the file extension) are displayed.
- There are many different recording bit rates available to encode MP3 files. This unit was designed to be compatible with all of them. Audio encoded at 128 Kbps should sound close to standard audio CD quality. This player will play lower bit-rate files, but please note that the sound quality becomes noticeably worse at lower bit-rates.

JPEG Compatibility

- Baseline JPEG and EXIF 2.1* still image files up to 8 mega-pixels are supported (maximum vertical and horizontal resolution is 5120 pixels).
(*File format used by digital still cameras)
- JPEG discs must be ISO 9660 Level 1 or 2 compliant. CD physical format: Mode1, Mode2 XA Form1. Romeo and Joliet file systems are both compatible with this player.
- This player only displays files that are named with the file extension .jpg or .JPG.

Copyright

It is forbidden by law to copy, broadcast, show, broadcast on cable, play in public, or rent copyrighted material without permission.

DVD-Video discs are copy-protected, and any recordings made from these discs will be distorted.

This product incorporates copyright protection technology that is protected by method claims of certain U.S. patents and other intellectual property rights owned by Macrovision Corporation and other rights owners. Use of this copyright-protection technology must be authorized by Macrovision Corporation, and is intended for home and other limited viewing uses only, unless otherwise authorized by Macrovision Corporation. Reverse engineering or disassembly is prohibited.

Introduction—Continued

Handling Discs

- Never touch the underside of a disc. Always hold discs by the edge, as shown.

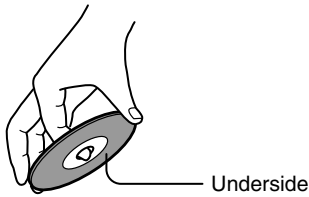

- Never attach adhesive tape or sticky labels to discs.



Cleaning Discs

- For best results, keep your discs clean. Fingerprints and dust can affect the sound and picture quality and should be removed as follows. Using a clean soft cloth, wipe from the center outwards, as shown. Never wipe in a circular direction.



- To remove stubborn dust or dirt, wipe the disc with a damp soft cloth, and then dry it with a dry cloth.
- Never use solvent-based cleaning fluids, such as thinner or benzine, commercially available cleaners, or antistatic sprays intended for vinyl records, because they may damage the disc.

Storing Discs

- Don't store discs in places subject to direct sunlight, or near heat sources.
- Don't store discs in places subject to moisture or dust, such as in a bathroom or near a humidifier.
- Always store discs in their cases and vertically. Stacking, or putting objects on unprotected discs may cause warping, scratches, or other damage.

Before Using the DV-SP501

Installing the Batteries

- 1 Open the battery compartment, as shown.

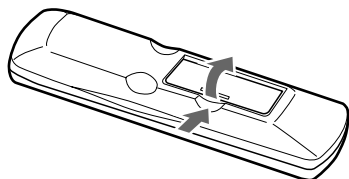

- 2 Insert the two supplied batteries (AA) in accordance with the polarity diagram inside the battery compartment.

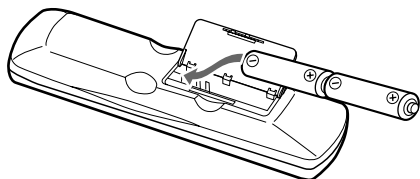

- 3 Close the battery compartment.

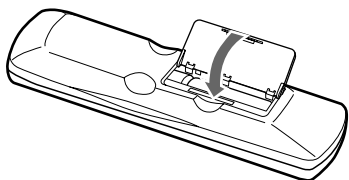

Notes:

- The supplied batteries should last for about six months, although this will vary with usage.
- If the remote controller doesn't work reliably, try replacing both batteries.
- Don't mix new and old batteries, or different types of batteries.
- If you intend not to use the remote controller for a long time, remove the batteries to prevent possible leakage and corrosion.
- Flat batteries should be removed as soon as possible to prevent possible leakage and corrosion.

Using the Remote Controller

To use the remote controller, point it at the DV-SP501's remote control sensor, as shown below.

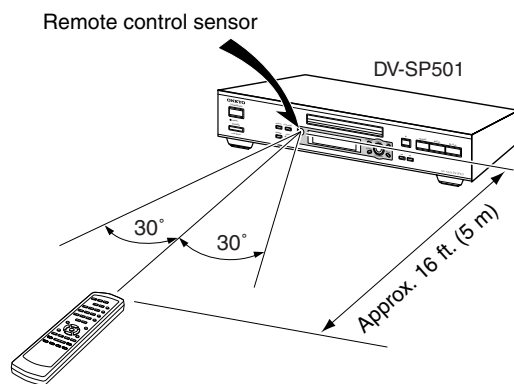

Notes:

- The remote controller may not work reliably if the DV-SP501 is subjected to bright light, such as direct sunlight or inverter-type fluorescent lights. Keep this in mind when installing the DV-SP501.
- If another remote controller of the same type is used in the same room, or the DV-SP501 is installed close to equipment that uses infrared rays, the remote controller may not work reliably.
- Don't put anything, such as a book, on the remote controller, because the buttons may be pressed inadvertently, thereby draining the batteries.
- The remote controller may not work reliably if the DV-SP501 is installed in a rack behind colored glass doors. Keep this in mind when installing the DV-SP501.
- The remote controller will not work if there's an obstacle between it and the DV-SP501's remote control sensor.

Front & Rear Panels

For detailed information, refer to the pages in brackets.

Front Panel

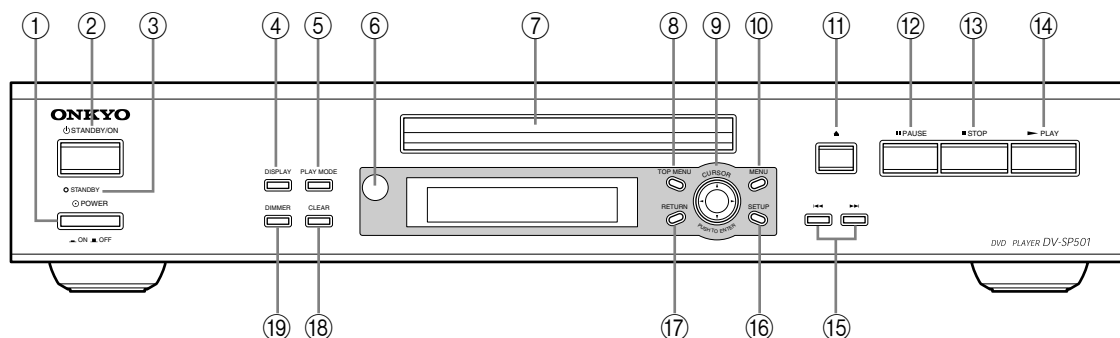

- ① **POWER switch [23]**

This is the main power switch. When set to OFF, the DV-SP501 is completely shutdown. When set to ON, the DV-SP501 can be set to On or Standby. Don't turn on the power until you've completed, and double checked all connections (pages 18–22).
- ② **STANDBY/ON button [23, 26]**

This button is used to set the DV-SP501 to On or Standby. For models with a POWER switch, this button has no effect unless the POWER switch is set to ON.
- ③ **STANDBY indicator [23]**

This indicator lights up when the DV-SP501 is in Standby.
- ④ **DISPLAY button [39]**

This button is used to display information about the current disc, title, chapter, or track, including the elapsed time, remaining time, total time, and so on. Press it repeatedly to display more information.
- ⑤ **PLAY MODE button [31–36]**

This button is used to open and close the Play Mode menu.
- ⑥ **Remote control sensor [11]**

This sensor receives control signals from the remote controller.
- ⑦ **Disc tray [26]**

Discs are loaded here.
- ⑧ **TOP MENU button [28]**

This button is used to display the top menu of a DVD-Video disc.
- ⑨ **Cursor ◀/▶/▲/▼ & ENTER buttons [24]**

The four cursor buttons located around the central [ENTER] button are used to navigate DVD-Video menus and the onscreen setup menus. The central [ENTER] button is used to start playback of the selected title, chapter, or track and to confirm settings.
- ⑩ **MENU button [28]**

This button is used to display a menu on a DVD-Video disc or to open the Disc Navigator when using a Video CD, audio CD, WMA/MP3/JPEG disc, or VR format DVD-RW disc.
- ⑪ **Open/Close ▲ button [26]**

This button is used to open and close the disc tray.
- ⑫ **PAUSE ■■ button [27]**

This button is used to pause playback.
- ⑬ **STOP ■ button [27]**

This button is used to stop playback.
- ⑭ **PLAY ► button [26, 27]**

This button is used to start playback.
- ⑮ **Previous/Next ◀◀/▶▶ buttons [27]**

The Previous button is used to select the previous chapter or track. During playback it selects the beginning of the current chapter or track. The Next button is used to select the next chapter or track.
- ⑯ **SETUP button [24]**

This button is used to open and close the onscreen setup menus.
- ⑰ **RETURN button [24, 28]**

This button is used to return to the main menu without saving your changes.
- ⑱ **CLEAR button [35]**

This button is used to cancel various functions.
- ⑲ **DIMMER button**

This button is used to adjust the display brightness.

Display

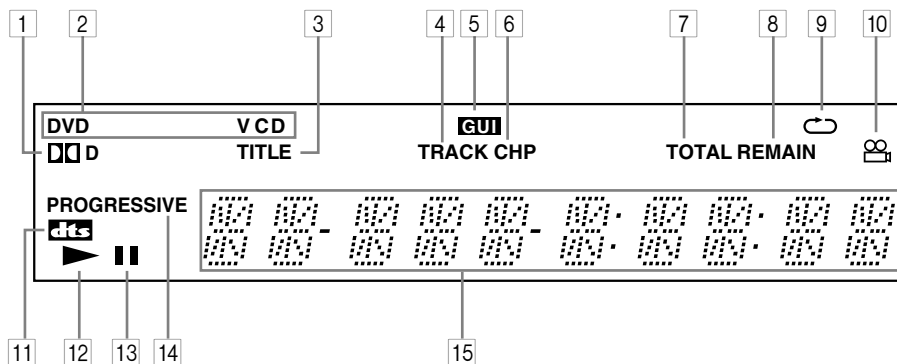

- 1 **D D indicator**
This indicator appears when playing Dolby Digital material.
- 2 **Disc type indicators**
These indicators show the type of disc loaded.
- 3 **TITLE indicator**
While stopped, the total number of titles on the current DVD-Video disc is displayed here. During playback, the number of the current title is displayed.
- 4 **TRACK indicator**
This indicator appears while track numbers are being displayed. While stopped, the total number of tracks on the current Video CD, audio CD, or MP3/WMA disc are displayed. During playback, the number of the current track is displayed.
- 5 **GUI (Graphical User Interface) indicator**
This indicator appears when the onscreen setup menu is open.
- 6 **CHP indicator**
This indicator appears while the number of the current chapter is being displayed.
- 7 **TOTAL indicator**
This indicator appears while the total time is being displayed.
- 8 **REMAIN indicator**
This indicator appears while the remaining time is being displayed.
- 9 **Repeat ↺ indicator**
This indicator appears when A–B playback or repeat playback is used.
- 10 **Camera angle 📷 indicator**
This indicator appears if the DVD-Video disc being played features multiple camera angles.
- 11 **DTS indicator**
This indicator appears when playing DTS material.
- 12 **Play ▶ indicator**
This indicator is shown during playback.
- 13 **Pause ⏸ indicator**
This indicator appears when playback is paused.
- 14 **PROGRESSIVE indicator (not European models)**
This indicator appears when the Progressive Scanning function is on.
- 15 **Message & time area**
Time information, such as total time, remaining time, and so on, is displayed here in hours, minutes, and seconds. Other messages are also displayed.

Rear Panel (Other than European model)

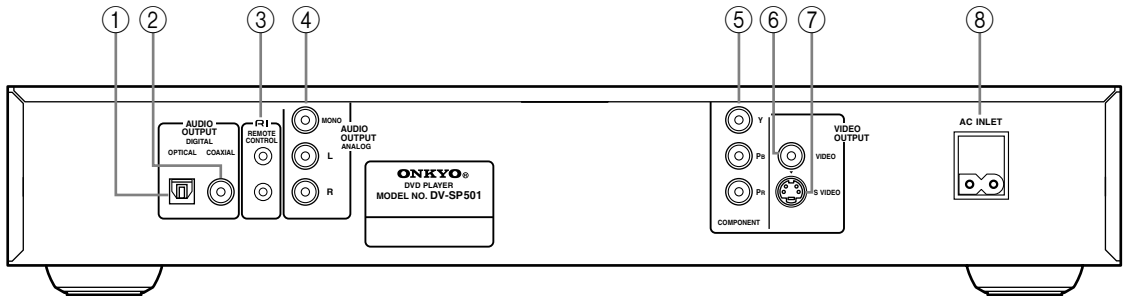

- ① **OPTICAL DIGITAL AUDIO OUTPUT [21]**
This optical digital audio output can be connected to an optical digital audio input on a hi-fi amp, AV receiver, or surround sound decoder (Dolby Digital, DTS).
- ② **COAXIAL DIGITAL AUDIO OUTPUT [21]**
This coaxial digital audio output can be connected to a coaxial digital audio input on a hi-fi amp, AV receiver, or surround sound decoder (Dolby Digital, DTS).
- ③ **RI jack [22]**
These **RI** (Remote Interactive) connectors can be connected to the **RI** connectors on your other Onkyo AV components for interactive control. For remote control operation, you must make an analog RCA/phono connection between your DV-SP501 and the other AV component, even if they are connected digitally.
- ④ **ANALOG AUDIO OUTPUT [19]**
These RCA/phono connectors can be connected to analog audio inputs on your TV, hi-fi amp, or AV receiver.
- ⑤ **COMPONENT VIDEO OUTPUT [20]**
These RCA/phono connectors can be used to connect a TV, projector or AV receiver with component video inputs.
- ⑥ **VIDEO OUTPUT [19]**
This RCA/phono connector can be used to connect a TV, projector or AV receiver with a composite video input.
- ⑦ **S VIDEO OUTPUT [20]**
This connector can be used to connect a TV, projector or AV receiver with an S-Video input.
- ⑧ **AC INLET [23]**
The supplied power cord is connected here. The other of the power cord should be connected to a suitable wall outlet.

Rear Panel (European model)

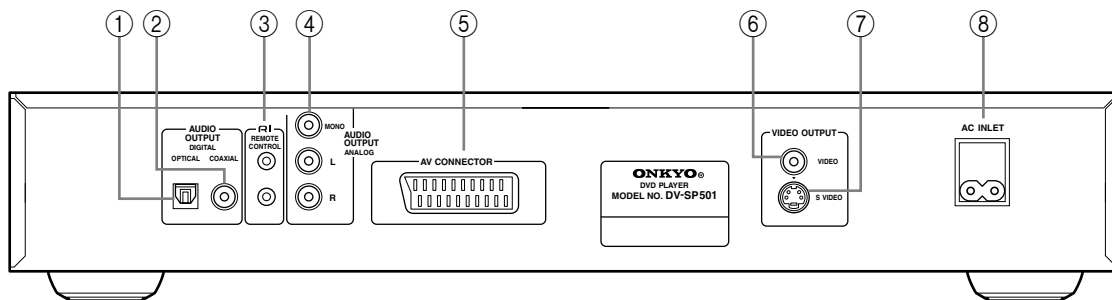

- ① **OPTICAL DIGITAL AUDIO OUTPUT [21]**
This optical digital audio output can be connected to an optical digital audio input on a hi-fi amp, AV receiver, or surround sound decoder (Dolby Digital, DTS).
- ② **COAXIAL DIGITAL AUDIO OUTPUT [21]**
This coaxial digital audio output can be connected to a coaxial digital audio input on a hi-fi amp, AV receiver, or surround sound decoder (Dolby Digital, DTS).
- ③ **RI jack [22]**
These **RI** (Remote Interactive) connectors can be connected to the **RI** connectors on your other Onkyo AV components for interactive control.
- ④ **ANALOG AUDIO OUTPUT [19]**
These RCA/phono connectors can be connected to analog audio inputs on your TV, hi-fi amp, or AV receiver.
- ⑤ **AV CONNECTOR [20]**
This SCART output can be connected to a TV or projector with a SCART input by using the supplied SCART cable. This SCART connector outputs 2-channel stereo audio, composite video, S-Video, and RGB video.
- ⑥ **VIDEO OUTPUT [19]**
This RCA/phono connector can be used to connect a TV or projector with a composite video input.
- ⑦ **S VIDEO OUTPUT [20]**
This connector can be used to connect a TV or projector with an S-Video input.
- ⑧ **AC INLET [23]**
The supplied power cord is connected here. The other of the power cord should be connected to a suitable wall outlet.

Remote Controller

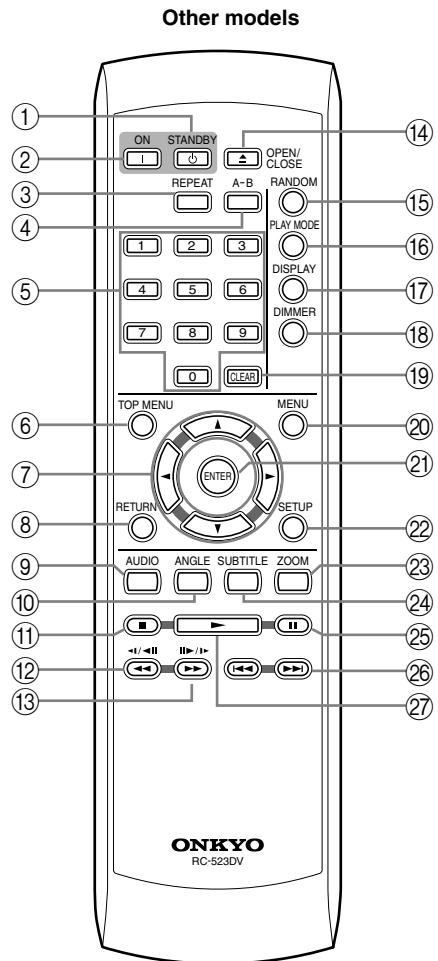
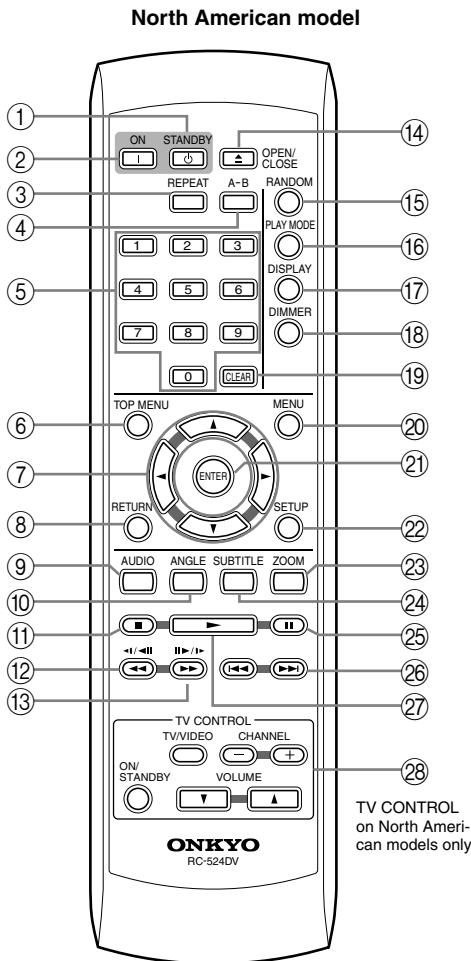

- ① **STANDBY button [23]**
This button is used to set the DV-SP501 to Standby.
- ② **ON button [23]**
This button is used to turn on the DV-SP501. Don't turn on the DV-SP501 until you've completed, and double checked all connections (pages 18–22).
- ③ **REPEAT button [32]**
This button is used to set the repeat playback functions.
- ④ **A-B button [31]**
This button is used to set the A–B Repeat Playback function.
- ⑤ **Number buttons [36]**
These buttons are used to enter title, chapter, and track numbers and to enter times for locating specific points in time.

- ⑥ **TOP MENU button [28]**
This button is used to display the top menu on a DVD-Video disc.
- ⑦ **Cursor ◀▶/▲/▼ buttons [24]**
These buttons are used to navigate onscreen menus.
- ⑧ **RETURN button [24, 28]**
This button is used to return to the main menu without saving your changes.
- ⑨ **AUDIO button [37]**
This button is used to select foreign language soundtracks and audio formats (e.g., Dolby Digital or DTS) on DVD-Video discs. For Video CDs you can select left-channel, right-channel, or stereo.
- ⑩ **ANGLE button [38]**
This button is used to select camera angles on DVD-Video discs.

- ⑪ **Stop ■ button [27]**
This button is used to stop playback.
- ⑫ **Fast Reverse ◀◀ / (◀◀/◀◀) button [27, 30, 31]**
This button is used for fast reverse, reverse slow motion, and reverse frame-by-frame playback.
- ⑬ **Fast Forward ▶▶ / (▶▶/▶▶) button [27, 30, 31]**
This button is used for fast forward, slow motion, and frame-by-frame playback.
- ⑭ **OPEN/CLOSE ▲ button [26]**
This button is used to open and close the disc tray.
- ⑮ **RANDOM button [33]**
This button is used with the Random Playback function.
- ⑯ **PLAY MODE button [31]**
This button is used to open and close the Play Mode menu.
- ⑰ **DISPLAY button [39]**
This button is used to display information about the current disc, title, chapter, or track, including the elapsed time, remaining time, total time, and so on. Press it repeatedly to display more information.
- ⑱ **DIMMER button**
This button is used to adjust the display brightness.
- ⑲ **CLEAR [35]**
This button is used to cancel various functions.
- ⑳ **MENU button [28]**
This button is used to display the menu on a DVD-Video disc or to open the Disc Navigator when using a Video CD, audio CD, WMA/MP3/JPEG disc, or VR format DVD-RW disc.
- ㉑ **ENTER button [24]**
This button is used to start playback of the selected title, chapter, or track, and to confirm settings.
- ㉒ **SETUP button [24]**
This button is used to open and close the onscreen setup menus.
- ㉓ **ZOOM button [38]**
This button is used with the Zoom function.
- ㉔ **SUBTITLE button [37]**
This button is used to select subtitles on DVD-Video discs.
- ㉕ **Pause ■■ button [27]**
This button is used to pause playback.
- ㉖ **Previous/Next |◀◀/▶▶| buttons [27]**
The Previous button is used to select the previous chapter or track. During playback it selects the beginning of the current chapter or track.
The Next button is used to select the next chapter or track.
- ㉗ **Play ▶ button [27]**
This button is used to start playback.
- ㉘ **TV CONTROL buttons (North American models only) [54]**
 - TV/VIDEO button**
Used to select TV or VCR on your TV.
 - CHANNEL -/+ buttons**
Used to select channels on your TV.
 - ON/STANDBY button**
Used to set your TV to On or Standby.
 - VOLUME ▼/▲ buttons**
Used to adjust your's TV's volume.

Connecting the DV-SP501

Before Making Any Connections

- Read the manuals supplied with your AV components.
- Don't connect the power cord until you've completed all audio and video connections.

Optical Digital Inputs

The DV-SP501's optical digital connectors have a shutter-type cover that opens when an optical plug is inserted, and closes when it's removed. Push the plug in all the way.

RCA/phono AV Connection Color Coding

RCA/phono AV connections are usually color coded: red, white, and yellow. Use red plugs to connect right-channel audio inputs and outputs (typically labeled "R"). Use white plugs to connect left-channel audio inputs and outputs (typically labeled "L"). And use yellow plugs to connect composite video inputs and outputs.

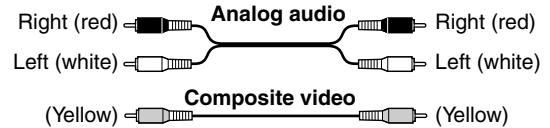

- Push each plug in all the way to make a good connection (loose connections can cause noise or malfunctions).
- To prevent interference, keep audio and video cables away from power cords and speaker cables.

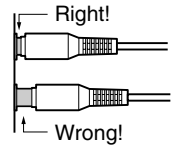

AV Cables & Connectors

Video			
Component video			Component video separates the luminance (Y) and color difference signals (PR, PB), providing the best picture quality. Some TV manufacturers label their component video inputs differently.
S-Video			S-Video provides better picture quality than composite video.
Composite video			Composite video can be found on virtually all TVs, VCRs, and video equipment.
Scart (European models only)			SCART connections carry audio and video (composite, S-Video, RGB) all in one cable.
Audio			
Optical digital			Optical digital audio connections provide better audio quality than analog connections.
Coaxial digital			Coaxial digital audio connections provide better audio quality than analog connections.
Analog			RCA/phono analog audio connectors can be found on virtually all AV components.

Basic Setup

The setup described here is a basic setup that allows you to play discs using just the cables supplied with the player. In this setup, stereo audio is played through the speakers in your TV.

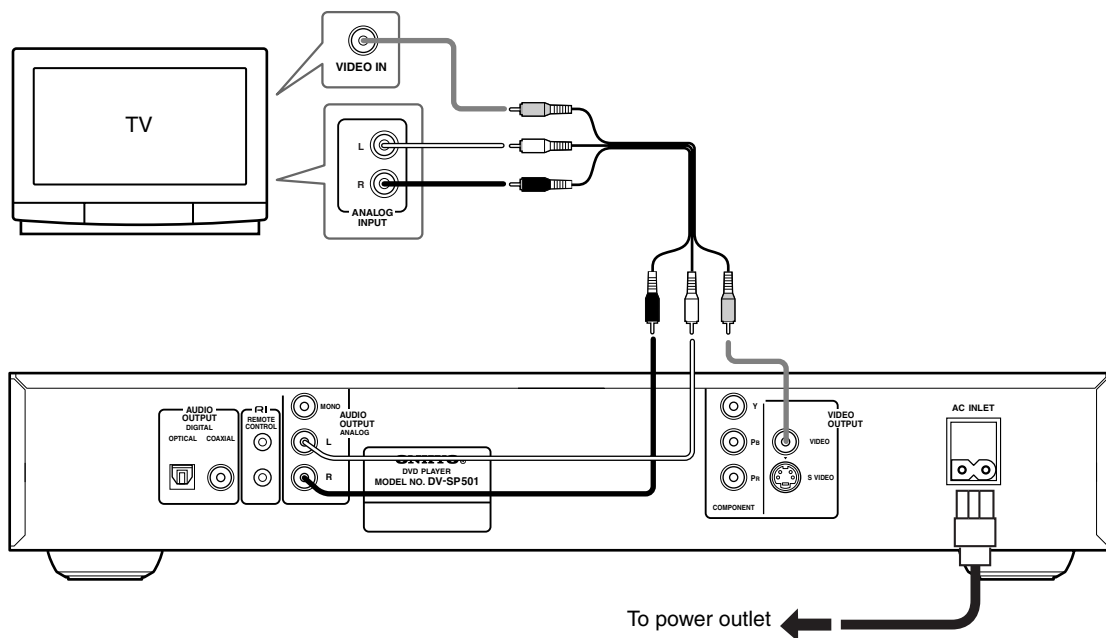

- This player is equipped with copy protection technology. Do not connect this player to your TV via a VCR using AV cables, as the picture from this player will not appear properly on your TV. (This player may also not be compatible with some combination TV/VCRs for the same reason; refer to the manufacturer for more information.)
- If your TV only has a mono audio input, connect it to the DV-SP501's MONO ANALOG AUDIO OUTPUT.

Other than European model

- When connecting to your TV as shown above, do not set the "Component Out" setting (page 45) to "Progressive." (Other than European models.)

1. Connect the VIDEO OUTPUT and AUDIO OUTPUT ANALOG L/R jacks to a set of A/V inputs on your TV.

Use the supplied audio/video cable, connecting the red and white plugs to the audio outputs and the yellow plug to the video output. Make sure you match up the left and right audio outputs with their corresponding inputs for correct stereo sound.

See the following page if you want to use a component or S-Video cable for the video connection.

2. Connect the supplied AC power cord to the AC INLET, then plug into a power outlet.

Notes:

- Before unplugging the player from the power outlet, make sure you first switch it into standby using either the front panel STANDBY/ON button, or the remote controller, and wait for the "GOOD BYE" message to disappear from the player's display.
- For the above reasons, do not plug this player into a switched power supply found on some amplifiers and AV receivers.

Other than North American model and European models

- When TV System is set to "AUTO" or "NTSC", and playing an NTSC disc only: When "Component Out" (page 45) is set to "Progressive", there is no video output from the "VIDEO OUTPUT" (composite) and "S VIDEO" jacks. If you want to display video on more than one monitor simultaneously, make sure that it is set to Interlace. Switch the player to standby then, using the front panel controls, press STANDBY/ON while pressing **◀◀** to switch the player back to "Interlace."

North American model

- When "Component Out" (page 45) is set to "Progressive", there is no video output from the "VIDEO OUTPUT" (composite) and "S VIDEO" jacks. If you want to display video on more than one monitor simultaneously, make sure that it is set to Interlace. Switch the player to standby then, using the front panel controls, press STANDBY/ON while pressing **◀◀** to switch the player back to "Interlace."

Connecting Your TV

- Connect the DVD Player to the TV directly. If you connect the DVD Player to a VCR, TV/VCR combination, or video selector, the playback picture may be distorted as DVD videos are copy protected.

Using S-Video

If your TV (or other equipment) has an S-Video input, you can use this instead of the standard (composite) output for a better quality picture.

- Use an S-Video cable (supplied) to connect the S-VIDEO OUTPUT to an S-Video input on your TV (or monitor or AV receiver).

Line up the small triangle above the jack with the same mark on the plug before plugging in.

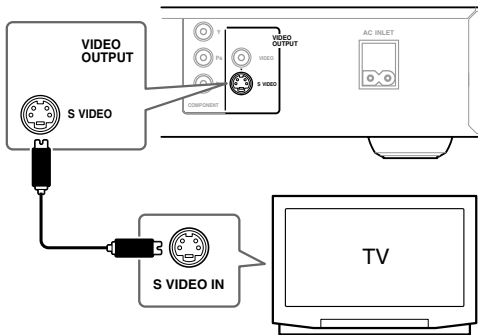

Using Component Video (not European models)

You can use the component video output instead of the standard video out jack to connect this player to your TV (or other equipment).

This should give you the best quality picture from the three types of video output available.

- Use a component video cable (not supplied) to connect the COMPONENT VIDEO OUTPUT jacks to a component video input on your TV, monitor or AV receiver.

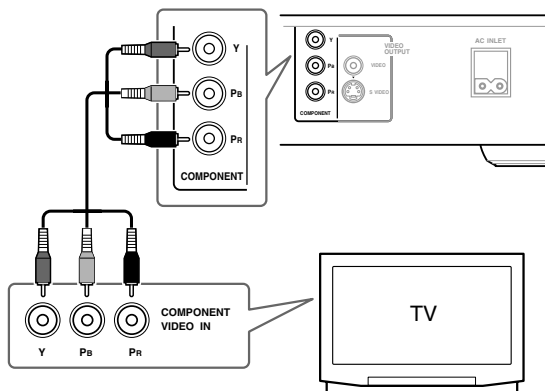

Note:

- To set up the player for use with a progressive scan TV, see “Component Out (Other than European models)” on page 45.

Using SCART (European models only)

If your TV has a SCART-type AV input, you can use a SCART cable to connect this player to your TV. This type of connection carries both the sound and the picture, so there's no need to connect up the AUDIO OUTPUT L/R and VIDEO OUTPUT jacks.

- Use a SCART cable (supplied) to connect the AV CONNECTOR (RGB) - TV/AV Receiver to an AV input on your TV.

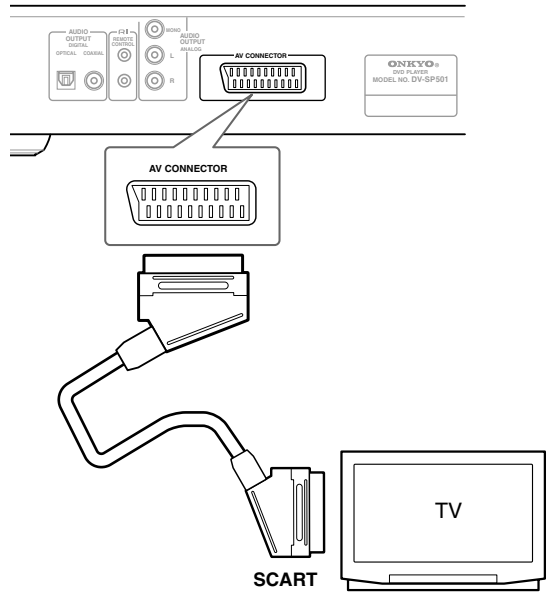

This connector can output composite video, S-Video, or RGB video. The default setting is composite, which should work with all TVs. Consult the manual that came with your TV to see if you can use one of the higher quality settings. See page 46 for how to change the video output.

Connecting to an AV Receiver

Although you can reproduce the DVD Player's sound from the TV speakers with the connections on page 19, connecting with an amplifier provides you high quality dynamic sounds.

To reproduce Dolby Digital surround and DTS surround sound, you need to connect to an amplifier with a Dolby Digital and DTS decoder respectively.

Before connecting

- When you connect the DVD Player to the amplifier, be sure to turn off the power and unplug both units from the mains before making any connections. Otherwise, the speakers may be damaged.
- Connect the plugs securely.

To enjoy surround sound you need to connect this player to an AV receiver using a digital output. This player has both coaxial and optical digital jacks; use whichever is convenient.

In addition to a digital connection, we recommend also connecting using the stereo analog connection.

To record the audio from a CD-R disc etc. to a cassette or CDR recorder that's connected to the AV receiver, and when your AV receiver has Zone2, you must connect the DV-SP501's analog audio outputs to the AV receiver.

You'll probably also want to connect a video output to your AV receiver. You can use any of the video outputs available on this player (the illustration shows a standard (composite) connection).

1. **Connect one of DIGITAL AUDIO OUTPUT jacks on this player to a digital input on your AV receiver.**

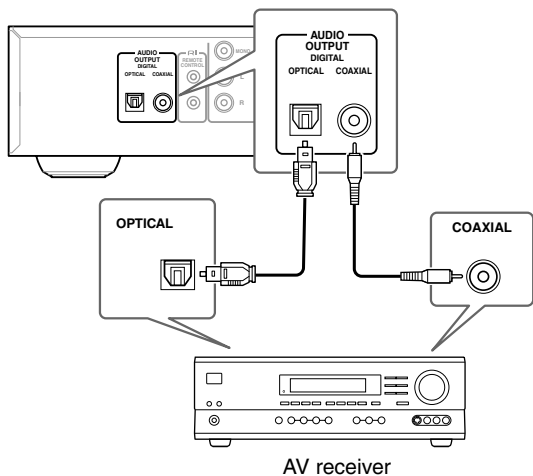

This enables you to listen to surround sound.

For an optical connection, use an optical cable (not supplied) to connect the "OPTICAL DIGITAL AUDIO OUTPUT" jack to an optical input on your AV receiver.

For a coaxial connection, use a coaxial cable (similar to the supplied video cable) to connect the "COAXIAL DIGITAL AUDIO OUTPUT" jack to a coaxial input on your AV receiver.

2. **Connect the analog AUDIO OUTPUT L/R and VIDEO OUTPUT jacks on this player to a set of analog audio and video inputs on your AV receiver.**

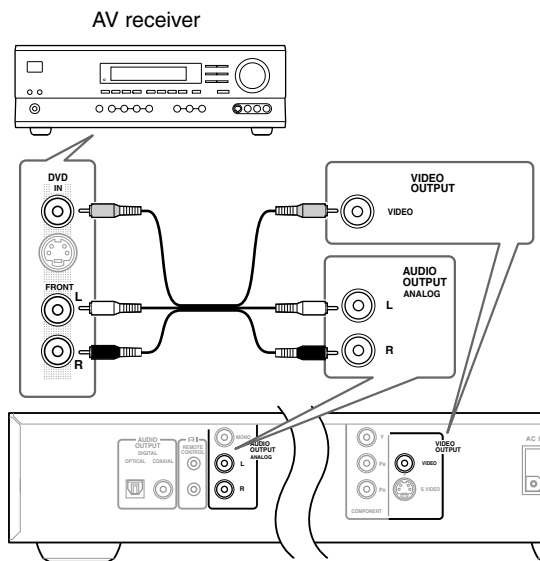

The diagram shows standard video connections, but you can alternatively use the S-Video or component video connections if they're available.

3. **Connect the AV receiver's video output to a video input on your TV.**

Tip:

- You usually have to connect the same kind of video cable between your DVD player and AV receiver, and between your AV receiver and TV.

Connecting RI-compatible Components

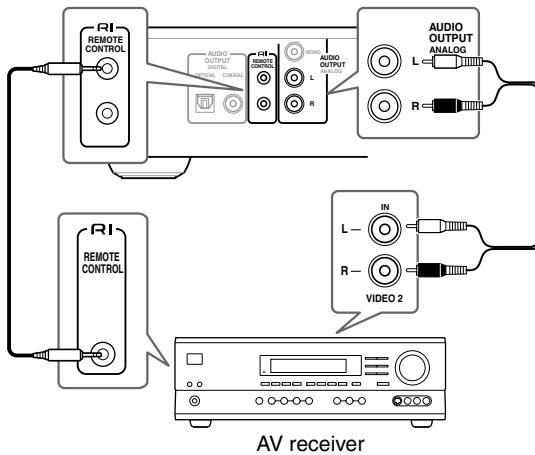

AV receiver

- The remote controller supplied with Onkyo AV receiver or amplifiers can be used to control the DV-SP501.
- The function of the upper and lower **RI** connectors are the same. Connect to either one.
- Connecting an **RI** cable only does not make the system operational. You must also connect the audio cables as well.
- For remote control operation, you must make an analog RCA/phono connection between your DV-SP501 and the other AV component, even if they are connected digitally.

Connecting the Power/Turning on the DV-SP501

Before connecting

- The DV-SP501 is shipped with the POWER switch in the on position (ON). When the power cord is plugged in for the first time, the DV-SP501 will automatically enter the standby state and the STANDBY indicator will light (same condition after step 2 below).
- Make sure that all the connections on pages 18 – 22 are complete (the connection to a TV is required).

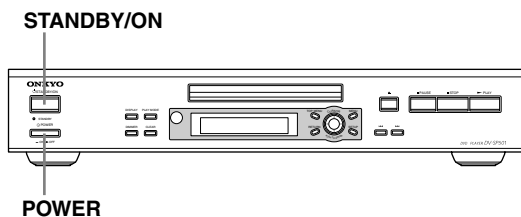

1

Plug the supplied power cord into the AC INLET and then into the power outlet on the wall.

- Do not use a power cord other than the one supplied with the DV-SP501. The power cord supplied is designed for use with the DV-SP501 and should not be used with any other device.
- Never have the power cord disconnected from the DV-SP501 while the other end is plugged into the wall outlet. Doing so may cause an electric shock. Always connect by plugging into the wall outlet last and disconnect by unplugging from the wall outlet first.

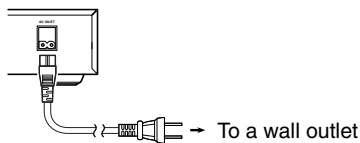

2

Press POWER to switch on the main power.

The DVD Player enters standby mode. The STANDBY indicator lights up.

- The buttons on the remote controller do not operate if the POWER switch is set to OFF.
- To switch off the main power, press POWER again.

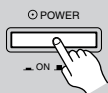

3



Press STANDBY/ON on the DVD Player or ON on the remote controller.

The DVD Player turns on and the STANDBY indicator turns off.

- To put the DVD Player in the standby mode, press STANDBY/ON on the DVD Player, or STANDBY on the remote controller. Be sure to set the volume to minimum before putting the DVD Player in the standby mode for the next use to avoid sudden loud sound reproduction.
- While the STANDBY indicator lights up, the DVD Player can receive signals from the remote controller. However, if you press POWER on the DVD Player to switch off the main power, the remote controller cannot be used to turn on the DVD Player.
- Setting the STANDBY button to standby does not shut off the power completely.

Note:

- This player features a screen saver and an auto power off function. If the player is stopped and no button is pressed for five minutes, the screen saver starts. If the disc tray is closed but no disc is playing and no control is pressed for 30 minutes, the player automatically goes into standby.

Getting Started

Using the on-screen displays

For ease of use, this player makes extensive use of graphical on-screen displays (OSDs).

Make sure that you select the input on the TV (by using the TV remote) to view the on-screen displays.

You should get used to the way these work as you'll need to use them when setting up the player, using some of the playback features, such as program play, and when making more advanced settings for audio and video.

All the screens are navigated in basically the same way, using the cursor buttons (◀/▶/▲/▼) to change the highlighted item and pressing ENTER to select it.

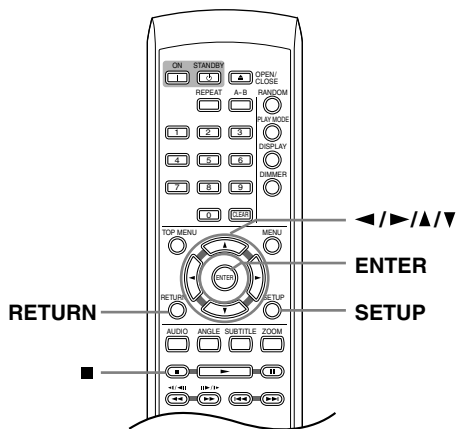

Note:

Throughout this manual, "Select" means use the cursor buttons to highlight an item on-screen, then press ENTER.

Button	What it does
	Display/exit the on-screen display.
	Changes the highlighted menu item.
	Selects the highlighted menu item (both ENTER buttons work in exactly the same way).
	Returns to the main menu without saving changes.

Setting up with the Setup Navigator

Using the Setup Navigator you can make a number of other initial settings for this player. We recommend using the Setup Navigator, especially if you connected this player to an AV receiver for playing surround sound. To answer some of the questions about digital audio formats you may need to look at the instructions that came with your AV receiver.

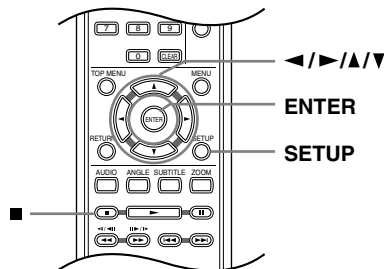

- 1** If a disc is playing, press ■ (stop).
- 2** Turn on your TV and make sure that you select the input on the TV (by using the TV remote) to view the setup navigator.
- 3** Press **SETUP**.
The on-screen display (OSD) appears.
- 4** Select "Setup Navigator."
- 5** Select a DVD language.

Some DVD discs feature on-screen menus, soundtracks and subtitles in several languages. Set your preferred language here.

The available languages vary between models.

- North American and European models: English, French, Spanish, German, Italian, Other Language.
- Australian, Asian and South American models: English, French, Spanish, Chinese (traditional), Other Language.
- Chinese model: English, Chinese (simplified), Other Language.
- Note that the language you choose here may not be available on all discs.
- If you want to select a language other than those listed, select “Other Language.” See “Selecting languages using the language code list” on page 51 for detailed information.

6

Did you connect this player to an amplifier or AV receiver?

Select “Connected” or “Not Connected.”

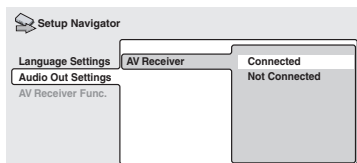

- If you selected “Not Connected” here, that completes setup using the Setup Navigator. Press ENTER to exit.

7

Did you connect this player to an AV receiver using a digital output?

Select “Connected” or “Not Connected.”

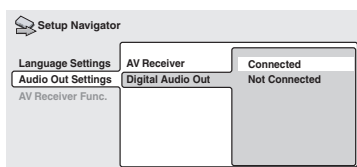

- If you selected “Not Connected” here, that completes setup using the Setup Navigator. Press ENTER to exit.

8

Is your AV receiver Dolby Digital compatible?

Select “Compatible,” “Not Compatible” or “Don’t Know.”

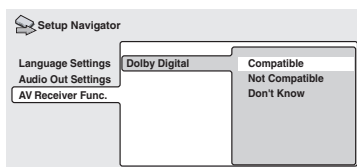

9

Is your AV receiver DTS compatible?

Select “Compatible,” “Not Compatible” or “Don’t Know.”

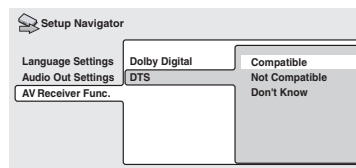

Notes:

- If you set the player to DTS on a non-DTS compatible disc, you will have no sound outputting because the disc is not have a DTS soundtrack.
- When a DVD disc is loaded into the DVD player, the disc would default to Dolby digital format. For DTS playback you would need to select DTS in the table of contents of the movie. Usually in “Language” or in “Audio Setup”.

10

Is your AV receiver MPEG compatible?

Select “Compatible,” “Not Compatible” or “Don’t Know.”

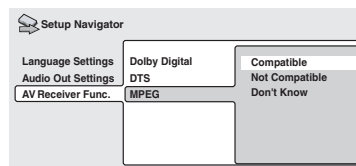

11

Is your AV receiver compatible with 96 kHz Linear PCM audio?

Select “Compatible,” “Not Compatible” or “Don’t Know.”

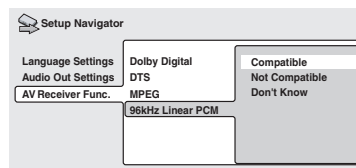

12

Press ENTER to complete the setup, or press SETUP to quit the Setup Navigator without making any changes.

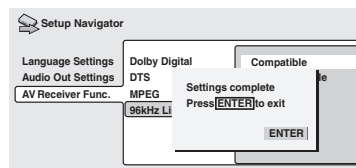

Congratulations, setup is complete!

Playing discs

The basic playback controls for playing DVD, CD, Video CD and WMA/MP3/JEPG discs are covered here.

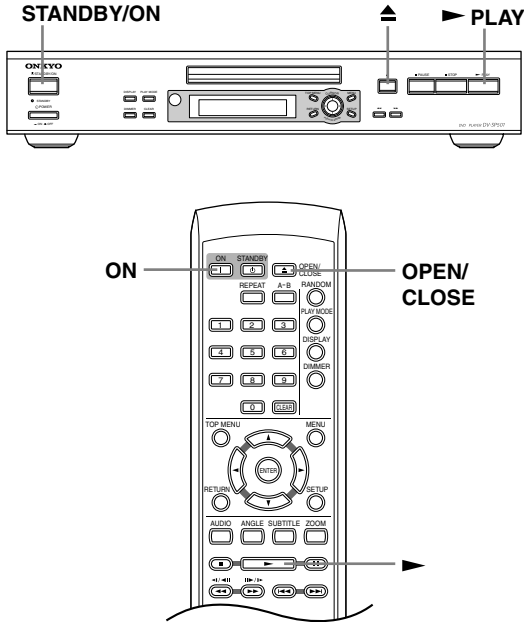

1

If the player isn't already on, press DVD player's STANDBY/ON or the remote controller's ON to switch it on.

If you're playing a DVD or Video CD, also turn on your TV and make sure that it is set to the correct video input.

STANDBY/ON



Remote controller



2

Press ▲ OPEN/CLOSE to open the disc tray.



Remote controller



3

Load a disc.

Load a disc with the label side facing up, using the disc tray guide to align the disc (if you're loading a double-sided DVD disc, load it with the side you want to play face down).

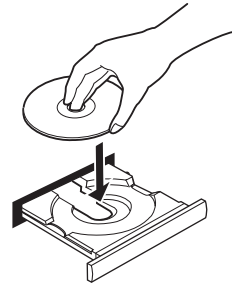

4

Press ► (play) to start playback.

If you're playing a DVD or Video CD, a menu may appear. See "DVD-Video disc menus" on page 28 and "Video CD PBC menus" on page 28 for more on how to navigate these.

If you're playing an WMA/MP3 disc, it may take a few seconds before playback starts, depending on the complexity of the file structure on the disc.

If you loaded a CD/CD-R/RW containing JPEGs, a slideshow will start. See "Viewing JPEG discs" on page 40 for more on playing these discs.

- See also "PhotoViewer" on page 49 if the disc contains both WMA/MP3 audio files and JPEG picture files (by default, you will not be able to play the WMA/MP3 files).

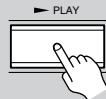

Remote controller

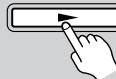

Basic playback controls

The table below shows the basic controls on the remote controller for playing discs.

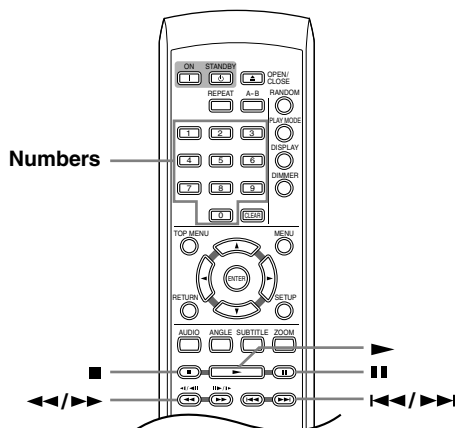

Button	What it does
▶	Starts playback. DVD and Video CD: If the display shows RESUME or LAST MEM playback starts from the resume or last memory point (see also “Resume and Last Memory” right column.)
	Pauses a disc that’s playing, or restarts a paused disc.
■	Stops playback. DVD and Video CD: Display shows RESUME. Press ■ (stop) again to cancel the resume function (see also “Resume and Last Memory” right column).
◀◀	Press to start fast reverse scanning. Press ▶ (play) to resume normal playback.
▶▶	Press to start fast forward scanning. Press ▶ (play) to resume normal playback.
◀◀◀	Skips to the start of the current track or chapter, then to previous tracks/chapters. While the Resume function is active, pressing this button starts playback from the beginning of the title (DVD) or the first track (VCD).
▶▶▶	Skips to the next track or chapter.
Numbers	Use to enter a title, chapter, or track number. Press ENTER to select (or wait a few seconds). <ul style="list-style-type: none"> • If the disc is stopped, playback starts from the selected title (for DVD) or track number (for CD/Video CD/WMA/MP3). • If the disc is playing, playback jumps to the start of the selected chapter or track.

Front panel controls

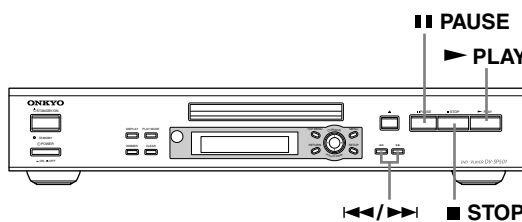

The ▶ PLAY, ■ STOP, and || PAUSE buttons on the front panel work in exactly the same way as their remote control equivalents. The combined ◀◀/▶▶ buttons on the front panel work slightly differently from the remote buttons. Press and hold for fast scan; press for track/ chapter skip.

See Front panel on page 12 for the location and description of all the front panel controls for your model.

Notes:

- You may find with some DVD discs that some playback controls don’t work in certain parts of the disc. This is not a malfunction.
- Track skip and number buttons for track selection do not work with unfinalized CD-R/RW discs.

Resume and Last Memory

When you stop playback of a DVD or Video CD disc, “RESUME” is shown in the display indicating that you can resume playback again from that point.

If the disc tray is not opened, the next time you start playback the display shows “RESUME” and playback resumes from the resume point.

For DVD discs only: If you take the disc out of the player, the play position is stored in memory. When you load the disc next time, the display shows “LAST MEM” and you can resume playback (this works for up to five discs).

If you want to clear the resume/last memory point, press ■ (stop) while “RESUME” or “LAST MEM” is displayed.

Notes:

- When a Video CD is loaded, the Resume point is lost if the player is switched off or the disc tray opened.
- For the Last Memory function to work, you must press ■ (stop) to stop playback before opening the disc tray.
- The Last Memory function doesn’t work with VR format DVD-RW discs.

DVD-Video disc menus

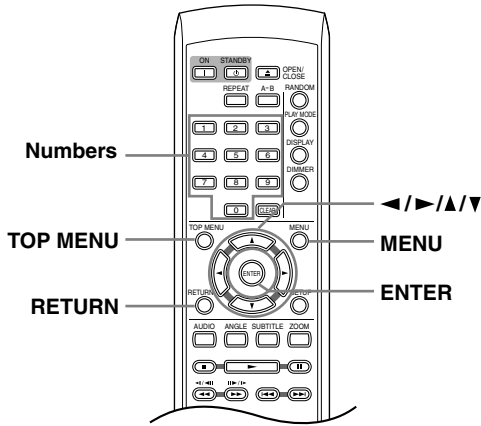

Many DVD-Video discs contain menus from which you can select what you want to watch. They may give access to additional features, such as subtitle and audio language selection, or special features such as slideshows. See the disc packaging for details. Sometimes DVD-Video menus are displayed automatically when you start playback; others only appear when you press MENU or TOP MENU.

Button	What it does
TOP MENU	Displays the "top menu" of a DVD disc—this varies with the disc.
MENU	Displays a DVD disc menu—this varies with the disc and may be the same as the "top menu."
◀▶/▲▼	Moves the cursor around the screen.
ENTER	Selects the current menu option.
RETURN	Returns to the previously displayed menu screen.
Numbers	Highlights a numbered menu option (some discs only). Press ENTER to select.

Video CD PBC menus

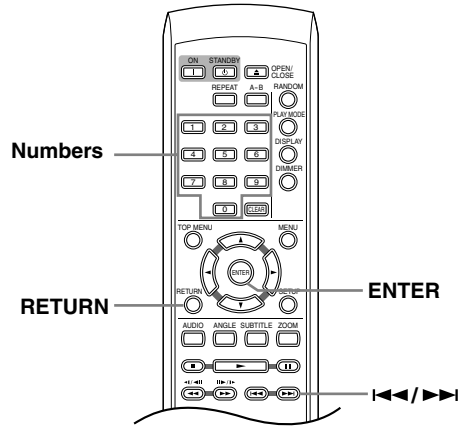

Some Video CDs have menus from which you can choose what you want to watch. These are called PBC (Playback control) menus. You can play a PBC Video CD without having to navigate the PBC menu by starting playback using a number button to select a track, rather than the ▶ (play) button.

Button	What it does
RETURN	Displays the PBC menu.
Numbers	Use to enter a numbered menu option. Press ENTER to select.
◀◀	Displays the previous menu page (if there is one).
▶▶	Displays the next menu page (if there is one).

Playing discs

Introduction

Most of the features described in this chapter make use of on-screen displays. For an explanation of how to navigate these, see “Using the on-screen displays” on page 24.

Many of the functions covered in this chapter apply to DVD discs, Video CDs, CDs and WMA/MP3/JPEG discs, although the exact operation of some varies slightly with the kind of disc loaded.

Some DVD discs restrict the use of some functions (random or repeat, for example). This is not a malfunction. When playing Video CDs, some of the functions are not available during PBC playback. If you want to use them, start the disc playing using a number button to select a track.

Using the Disc Navigator to browse the contents of a disc

Use the Disc Navigator to browse through the contents of a disc to find the part you want to play. You can use the Disc Navigator when a disc is playing or stopped.

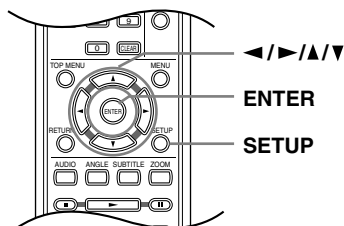

1

SETUP



Press **SETUP** and select “Disc Navigator” from the on-screen display.

Alternatively, if a VR format DVD-RW, CD, Video CD or WMA/MP3/JPEG disc is loaded, you can press **MENU**, which takes you straight to the Disc Navigator screen.

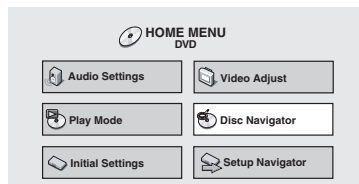

2

Select what you want to play.

Depending on the type of disc you have loaded, the Disc Navigator looks slightly different.

The screen for DVD discs shows the titles on the left and the chapters on the right. Select a title, or a chapter within a title.

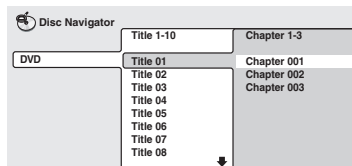

For a VR (Video Recording) mode DVD-RW disc select between the “Playlist” and “Original” areas of the disc, or a title. Press **▶** (cursor right) to preview the title.

- It’s not possible to switch between “Original” and “Playlist” during playback.
- Not all VR format DVD-RW discs have a Playlist.

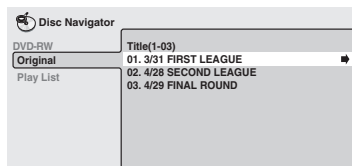

The screen for CDs and Video CDs shows a list of tracks.

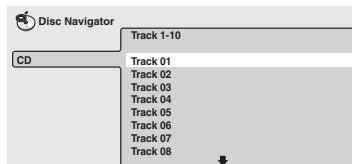

The screen for an WMA/MP3 disc shows the folder names on the left and the track names on the right (note that if there are more than 16 folders or names that contain accented or non-roman characters, tracks and folders may show up with generic names “-F_033”, “T_035”, etc.). Select a folder, or a track within a folder.

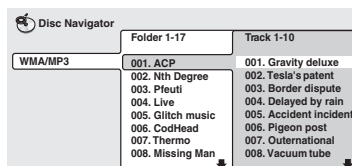

Playback starts after you press **ENTER**.

Tips:

- The Disc Navigator is not available unless there is a disc loaded.
- It’s not possible to use the Disc Navigator when playing a Video CD in PBC mode, or an unfinalized CD-R/RW disc.
- Another way to find a particular place on a disc is to use one of the search modes. See “Searching a disc” on page 36.

Scanning discs

You can fast-scan discs forward or backward at various different speeds.

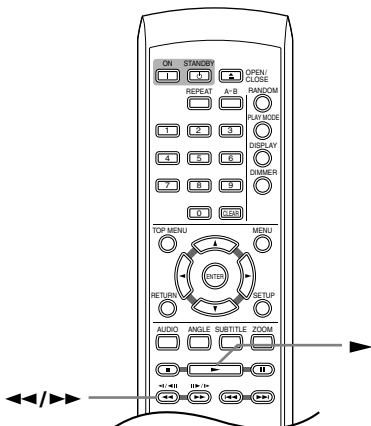

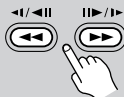
1	 <p>During playback, press ◀◀ or ▶▶ to start scanning.</p>
2	<p>Press repeatedly to increase the scanning speed.</p> <ul style="list-style-type: none"> • WMA/MP3 tracks can only be scanned at one speed. • The scanning speed is shown onscreen (i.e., Scan1 ▶▶).
3	<p>To resume normal playback, press ▶ (play).</p> <ul style="list-style-type: none"> • Sound can be heard while scanning audio CDs and MP3 discs. • There is no sound while scanning DVDs, Video CDs and WMA discs, and no subtitles while scanning DVDs. • When scanning a Video CD or WMA/MP3 track, playback automatically resumes at the end or beginning of the track. • Depending on the disc, normal playback may automatically resume when a new chapter is reached on a DVD disc.

Playing in slow motion

You can play DVDs and Video CDs at four different forward slow motion speeds. DVD-Video discs can also be played at two reverse speeds. (With Video CDs and VR format DVD-RWs, you can only use forward slow motion playback.)

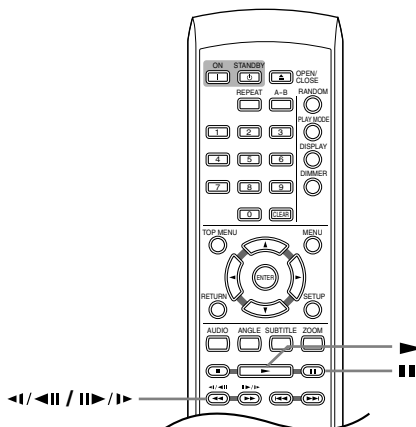

1	 <p>During playback, press (pause).</p>
2	<p>Press and hold ◀◀/◀ or /▶▶ or until slow motion playback starts.</p> <ul style="list-style-type: none"> • The slow motion speed is shown onscreen. • There is no sound during slow motion playback.
3	<p>Press repeatedly to change the slow motion speed.</p> <ul style="list-style-type: none"> • The slow motion speed is displayed onscreen.
4	<p>To resume normal playback, press ▶ (play).</p> <p>Notes:</p> <ul style="list-style-type: none"> • The picture quality during slow motion playback is not as good as during normal playback. • Depending on the disc, normal playback may automatically resume when a new chapter is reached.

Frame advance/frame reverse

You can advance or back up a DVD disc frame-by-frame. With Video CDs and VR format DVD-RWs, you can only use frame advance.

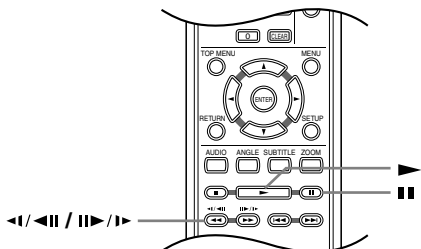

1 During playback, press **||** (pause).



2 Press **◀/◀||** or **||▶/▶** to reverse or advance a frame at a time.

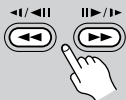

3 To resume normal playback, press **▶** (play).

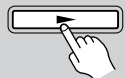

Tips:

- The picture quality when using frame reverse is not as good as frame advance.
- Depending on the disc, normal playback may automatically resume when a new chapter is reached.
- When changing direction with a DVD disc, the picture may “move” in an unexpected way. This is not a malfunction.

Looping a section of a disc

The A-B Repeat function allows you to specify two points (A and B) within a track (CD and Video CD) or title (DVD) that form a loop which is played over and over.

Note:

- You can't use A-B Repeat with WMA/MP3 discs, Video CDs in PBC 1mode, or unfinalized CD-R/RW discs.

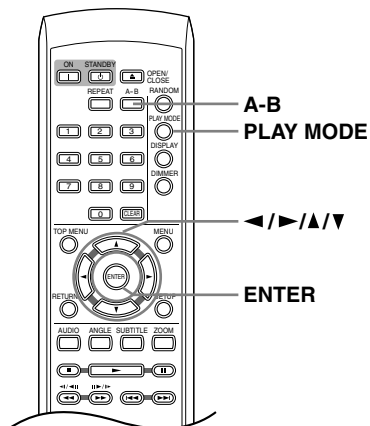

1 During playback, press **PLAY MODE** and select “A-B Repeat” from the list of functions on the left.

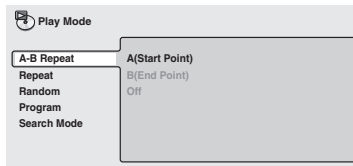

2 Press **ENTER** on “A (Start Point)” to set the loop start point.

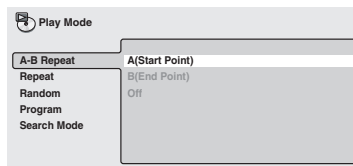

3 Press ENTER on “B (End Point)” to set the loop end point.

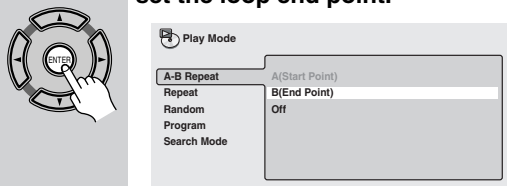

After pressing ENTER, playback jumps back to the start point and plays the loop.

- The minimum loop time is 2 seconds.

4 To resume normal playback, select “Off” from the menu.

Using the A-B button

With the A-B button you can quickly set the A-B Repeat function. Simply press the A-B button to set the A point. “A” appears on the display. Press the A-B button again to set the B point. “B” appears on the display and A-B repeat playback starts. To cancel A-B repeat playback, press the CLEAR button.

Using repeat play

There are various repeat play options, depending on the kind of disc loaded. It’s also possible to use repeat play together with program play to repeat the tracks/chapters in the program list (see “Creating a program list” on page 34).

Note:

- You can’t use Repeat play with Video CDs in PBC mode, or unfinalized CD-R/RW discs.

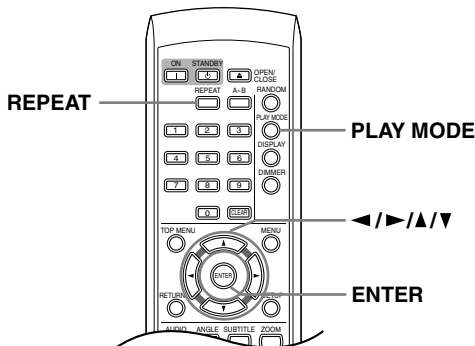

1 During playback, press PLAY MODE and select “Repeat” from the list of functions on the left.

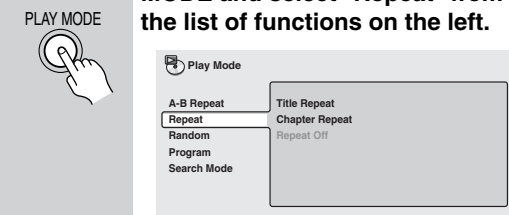

2 Select a repeat play option.

If program play is active, select “Program Repeat” to repeat the program list, or “Repeat Off” to cancel.

For DVD discs, select “Title Repeat” or “Chapter Repeat” (or “Repeat Off”).

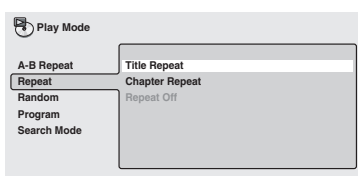

For CDs and Video CDs, select “Disc Repeat” or “Track Repeat” (or “Repeat Off”).

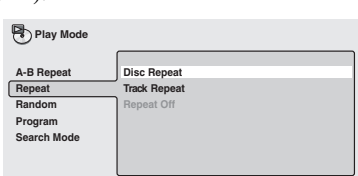

For WMA/MP3 discs, select “Disc Repeat”, “Folder Repeat” or “Track Repeat” (or “Repeat Off”).

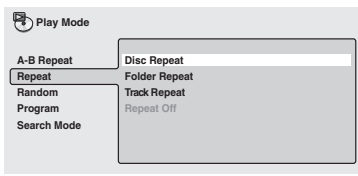

Using the REPEAT Button

With the REPEAT button you can quickly set the Repeat Playback function. Press REPEAT repeatedly to select one of the repeat options. Repeat playback starts when the current title, chapter, or track has finished playing. To cancel repeat playback, press CLEAR.

Notes:

- You can’t use repeat and random play at the same time.
- If you switch camera angle during repeat play, repeat play is canceled.

Using random play

Use the random play function to play titles or chapters (DVD-Video) or tracks (CD, Video CD and WMA/MP3 discs) in a random order.

You can set the random play option when a disc is playing or stopped.

- You can't use random play with VR format DVD-RW discs, Video CDs playing in PBC mode, or while a DVD disc menu is being displayed.

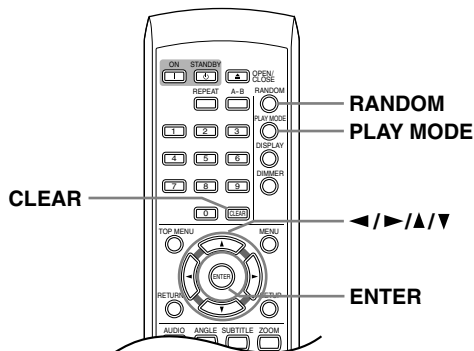

For WMA/MP3 discs, select “Random All” (all folders) or “Random Track” (current folder only), (or “Random Off”).

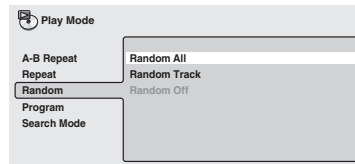

Using the RANDOM Button

With the RANDOM function you can quickly set the Random Playback function. Press RANDOM repeatedly to select one of the random options. Press ENTER, the random playback starts.

To cancel random playback, press CLEAR.

Tips:

- To stop the disc and cancel random playback, press ■ (stop).
- To cancel random playback without stopping playback, press CLEAR. The disc will play to the end, then stop.
- During random play, the ◀◀ and ▶▶ buttons function a little differently to normal: ◀◀ returns to the beginning of the current track/chapter. You can't go back further than this. ▶▶ selects another track/chapter at random from those remaining.
- You can't use random play together with program or repeat play.

1

PLAY MODE



Press **PLAY MODE** and select “Random” from the list of functions on the left.

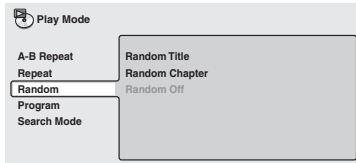

2

Select a random play option.

For DVD discs, select “Random Title” or “Random Chapter,” (or “Random Off”).

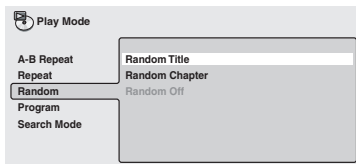

For CDs and Video CDs, select “On” or “Off” to switch random play on or off.

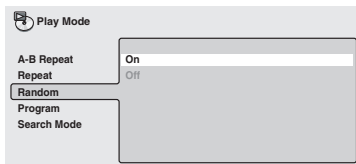

Creating a program list

This feature lets you program the play order of titles/chapters/folders/tracks on a disc.

- You can't use Program play with VR format DVD-RW discs, Video CDs playing in PBC mode, or while a DVD disc menu is being displayed.

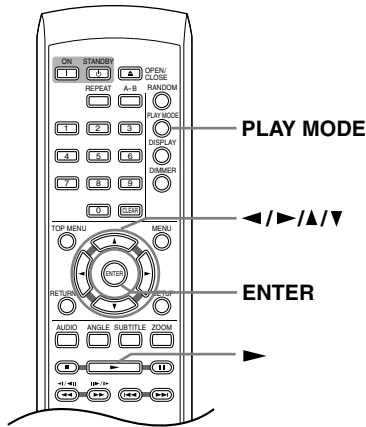

1 Press **PLAY MODE** and select **“Program”** from the list of functions on the left.

PLAY MODE

Play Mode

A-B Repeat	Create/Edit
Repeat	Playback Start
Random	Playback Stop
Program	Program Delete
Search Mode	Program Memory ▶ Off

2 Select **“Create/Edit”** from the list of program options.

Play Mode

A-B Repeat	Create/Edit
Repeat	Playback Start
Random	Playback Stop
Program	Program Delete
Search Mode	Program Memory ▶ Off

The Program edit screen that appears depends on the kind of disc loaded. On the left side is the program list, then to the right is a list of titles (if a DVD disc is loaded), tracks (for CDs and Video CDs), or folder names (for WMA/MP3 discs). On the far right is a list of chapters (for DVD) or track names (for WMA/MP3).

3 Select a title, chapter, folder or track for the current step in the program list.

For a DVD disc, you can add a whole title, or a chapter within a title to the program list.

- To add a title, select the title.

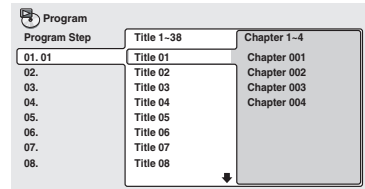

- To add a chapter, first highlight the title, then press **▶** (cursor right) and select a chapter from the list.

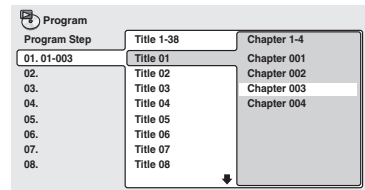

For a CD or Video CD, select a track to add to the program list.

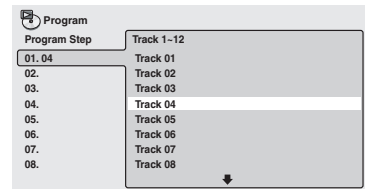

For an WMA/MP3 disc, you can add a whole folder, or a track within a folder to the program list.

- To add a folder, select the folder.

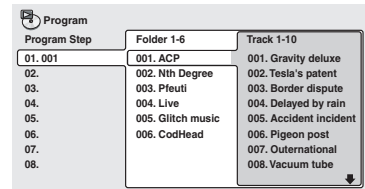

- To add a track, first find the folder, then press **▶** (cursor right) and select a track name from the list.

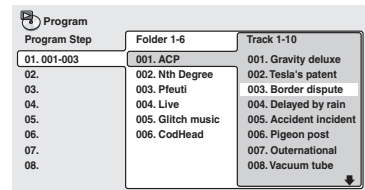

After pressing **ENTER** to select the title/chapter/folder/track, the program step number automatically moves down one.

4 Repeat step 3 to build up a program list.

A program list can contain up to 24 titles/chapters/folders/tracks.

5 To play the program list, press ► (play).

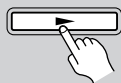

Program play remains active until you turn off program play (see below), erase the program list (see below), eject the disc or switch off the player.

Tips:

- To save your program list and exit the program edit screen without starting playback, press PLAY MODE or SETUP. (Don't press RETURN—your program list won't be saved.)
- During program play, press ►► to skip to the next program step; press ◀◀ to go back to the previous program step.
- Press CLEAR during playback to switch off program play. Press while stopped to erase the program list.

Editing a program list

After creating a program list, you can add, delete and change steps.

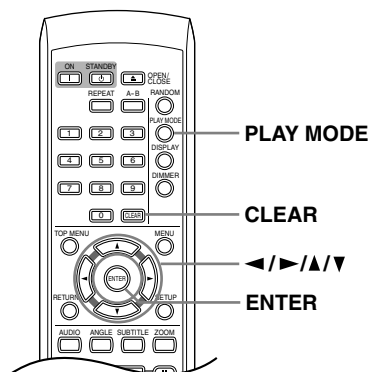

1 Press PLAY MODE and select "Program" from the list of functions on the left.

PLAY MODE



2 Select "Create/Edit" from the list of program options.

3 To clear a step, highlight the step number and press CLEAR.



4 To insert a step in the middle of the program list, highlight the step where you want the new step to appear, then select a title/chapter/folder/track to add.

After pressing ENTER, the new step is inserted into the list.

5 To add a step to the end of the program list, highlight the next free step then select a title/chapter/folder/track to add.

Tips:

- To save your program list and exit the program edit screen without starting playback, press PLAY MODE or SETUP.
- If you want to exit the program edit screen without saving the changes you made, press RETURN.

Other functions available from the program menu

As well as creating and editing a program list, you can start program play, cancel program play, erase the program list, and memorize a program list from the Play Mode menu.

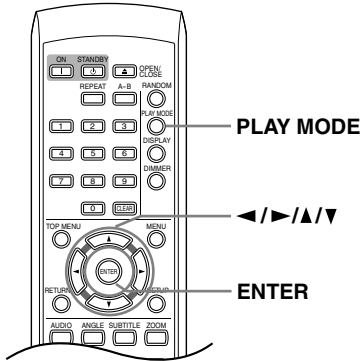

Searching a disc

You can search DVD discs by title or chapter number, or by time. CDs can be searched by track number, and Video CDs by track number or time. WMA/MP3 discs can be searched by folder or track number.

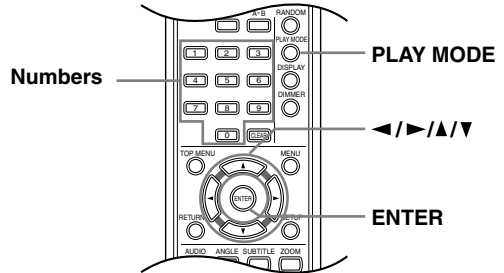

1 Press **PLAY MODE** and select **“Program”** from the list of functions on the left.

2 Select a program play function.

- **Create/Edit**—See above
- **Playback Start**—Starts playback of a saved program list
- **Playback Stop**—Turns off program play, but does not erase the program list
- **Program Delete**—Erases the program list and turns off program play
- **Program Memory (DVD only)**—Select “On” to save the program list for the disc loaded. (Select “Off” to cancel the program memory for the disc loaded)

Notes:

- Program lists are saved for the DVD disc loaded. When you load a disc with a saved program list, program play is automatically turned on.
- You can save program lists for up to 24 discs. After that, the oldest one is replaced with the new one saved.

1 Press **PLAY MODE** and select **“Search Mode”** from the list of functions on the left.

The search options that appear depend on the kind of disc loaded. The screen below shows the DVD search options.

2 Select a search mode.

3 Use the number buttons to enter a title, chapter, folder or track number, or a time.

- For a time search, enter the number of minutes and seconds into the currently playing title (DVD) or track (Video CD) you want playback to resume from. For example, press 4, 5, 0, 0 to have playback start from 45 minutes into the disc. For 1 hour, 20 minutes and 30 seconds, press 8, 0, 3, 0.

4 Press **ENTER** to start playback.

Playing discs—Continued

Notes:

- The disc must be playing in order to use time search.
- Search functions are not available with Video CDs in PBC mode, or unfinalized CD-R/RW discs.

Switching subtitles

Some DVD discs have subtitles in one or more languages; the disc box will usually tell you which subtitle languages are available.

You can switch subtitle language during playback.

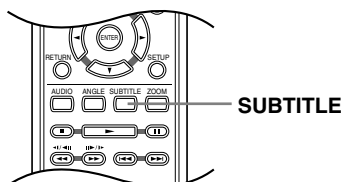

SUBTITLE



Press SUBTITLE repeatedly to select a subtitle option.

Current / Total
Subtitle 1/2 English

Notes:

- Some discs only allow you to change subtitle language from the disc menu. Press TOP MENU to access.
- To set subtitle preferences, see “Subtitle Language” on page 46.

Switching DVD audio language

When playing a DVD disc recorded with dialog in two or more languages, you can switch audio language during playback.

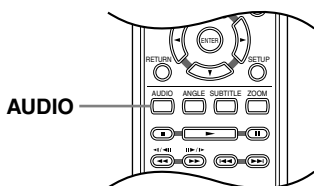

AUDIO



Press AUDIO repeatedly to select an audio language option.

Current / Total
Audio 1/2 French Dolby Digital 3/2.1CH

Notes:

- Some discs only allow you to change audio language from the disc menu. Press TOP MENU to access.
- To set audio language preferences, see “Audio Language” on page 46.

Switching VR format DVD-RW audio channel

When playing a VR format DVD-RW disc recorded with dual-mono audio, you can switch between the main, sub, and mixed channels during playback.

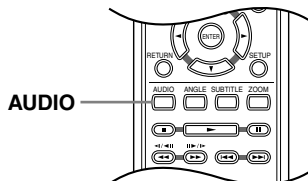

AUDIO



Press AUDIO repeatedly to select an audio channel option.

Audio 1L Dolby Digital 1+1CH

Switching audio channel when playing a Video CD

When playing a Video CD, you can switch between stereo, just the left channel or just the right channel.

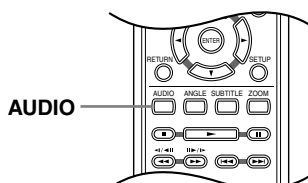

AUDIO



Press AUDIO repeatedly to select an audio channel option.

Audio Stereo

Zooming the screen

Using the zoom feature you can magnify a part of the screen by a factor of 2 or 4, while watching a DVD or Video CD.

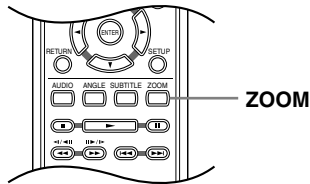

1



During playback, use the ZOOM button to select the zoom factor.

- Normal
- 2x
- 4x

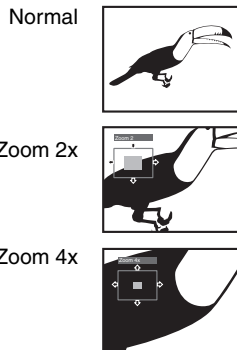

- Since DVD and Video CD have a fixed resolution, picture quality will deteriorate, especially at 4x zoom. This is not a malfunction.

2

Use the cursor buttons to change the zoomed area.

You can change the zoom factor and the zoomed area freely during playback.

- If the navigation square at the top of the screen disappears, press ZOOM again to display it.

Notes:

- We do not recommend using DVD disc menus when the screen is zoomed as menu options will not be highlighted.
- If you are displaying subtitles, these will disappear when the screen is zoomed. They will reappear when you return the screen to normal.

Switching camera angles

Some DVD discs feature scenes shot from two or more angles—check the disc box for details.

When a multi-angle scene is playing, a  icon appears on screen to let you know that other angles are available (this can be switched off if you prefer—see “Angle Indicator” on page 47).

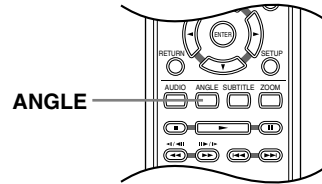

During playback (or when paused), press ANGLE to switch angle.

Displaying disc information

Various track, chapter and title information, as well as the video transmission rate for DVD discs, can be displayed on-screen while a disc is playing.

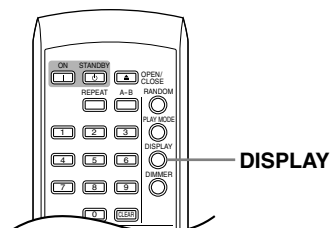

Note:

- You can see disc information (number of titles/chapters, tracks, folders and so on) from the Disc Navigator screen. See “Using the Disc Navigator to browse the contents of a disc” on page 29.

DISPLAY



To show/switch the information displayed, press DISPLAY.

When a disc is playing, the information appears at the top of the screen. Keep pressing DISPLAY to change the displayed information.

- DVD displays

Play		DVD			
	Current / Total	Elapsed	Remain	Total	
Title	11/38	2.05	4.57	7.02	
1. French			1. English		1
Audio	Dolby Digital 3/2.1CH		Subtitle		Angle

Play		DVD			
	Current / Total	Elapsed	Remain	Total	
Chapter	11/38	2.05	4.57	7.02	
Tr. Rate	8.6Mbps				

- VR format DVD-RW displays

Play		DVD-RW		Original	
	Current / Total	Elapsed	Remain	Total	
Title	1/32	0.08	30.22	30.30	
1			--		
Audio	Dolby Digital	2/0CH	Subtitle		

Play		DVD-RW		Original	
	Current / Total	Elapsed	Remain	Total	
Chapter	1/1				
Tr. Rate	4.3Mbps				

- CD and Video CD displays

Play		CD			
	Current / Total	Elapsed	Remain	Total	
Track	2/16	1.07	4.40	5.47	

Play		CD		
	Elapsed	Remain	Total	
Disc	28.00	30.20	58.20	

- WMA/MP3 disc displays

Play		MP3			
	Current / Total	Elapsed	Remain	Total	
Track	1/17	0.18	12.42	13.00	
Track Name	Outernational				

Play		MP3	
	Current / Total	Elapsed	Remain
Folder	2/7		
Folder Name	ACP		

- JPEG disc displays

Play		JPEG	
	Current / Total	Elapsed	Remain
File	1/40		
File Name	FL000001		

Play		JPEG	
	Current / Total	Elapsed	Remain
Folder	1/40		
Folder Name	Holiday		

Viewing JPEG discs

Viewing JPEG discs

After loading a CD/CD-R/RW containing JPEG pictures, press ► to start a slideshow from the first folder/picture on the disc. The player displays the pictures in each folder in alphabetical order.

Pictures are automatically adjusted so that they fill as much of the screen as possible (if the aspect ratio of the picture is different to your TV screen you may notice black bars at the sides, or at the top and bottom of the screen).

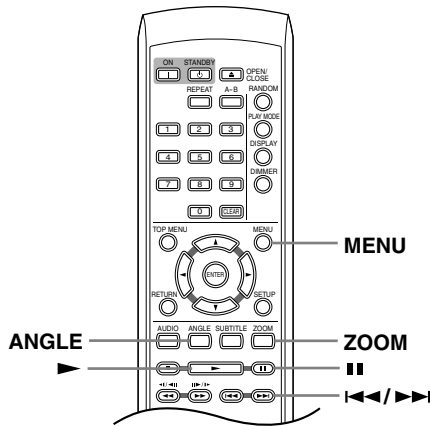

While the slideshow is running:

Button	What it does
⏸	Pauses the slideshow; press again to restart.
⏮	Displays the previous picture.
⏭	Displays the next picture.
ANGLE	Pauses the slideshow and rotates the currently displayed picture 90° clockwise. Press ► (play) to restart slideshow).
ZOOM	Pauses the slideshow and zooms the screen (see below). Press ► (play) to restart slideshow).
MENU	Displays the Disc Navigator screen (see below).

Notes:

- The ⏸, ANGLE and ZOOM buttons do not work while the display shows "LOADING."
- The time it takes for the player to load a file increases with large file sizes.
- Up to 999 files are viewable on a disc. If there are more files than this on a disc, only the first 999 files are viewable.

Using the JPEG Disc Navigator and Photo Browser

Use the JPEG Disc Navigator to find a particular folder or picture by filename; use the Photo Browser to find a picture within a folder by thumbnail image.

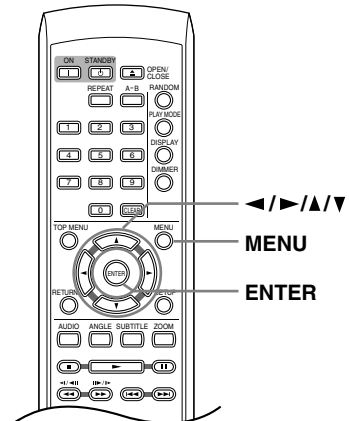

1



Press MENU to display the Disc Navigator screen.

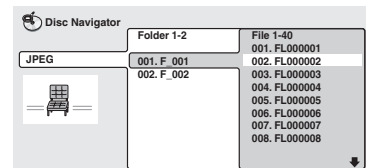

The left column shows the folders on the disc, the right column shows the files in a folder.

2



Use the cursor buttons (◀/▶/▲/▼) to navigate.

When a file is highlighted, a thumbnail image is displayed.

- When a folder is highlighted you can press ENTER to open the Photo Browser screen for that folder. See below for more on using the Photo Browser.

3



To resume the slideshow from the highlighted file, press ENTER.

Using the Photo Browser

The Photo Browser displays nine thumbnail images at a time from the current folder.

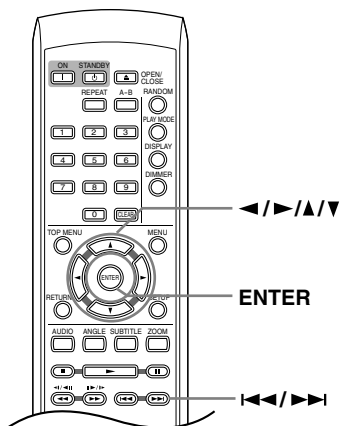

1



From the Disc Navigator screen, highlight a folder to display then press ENTER.

The Photo Browser screen opens with the first nine pictures displayed as thumbnails.

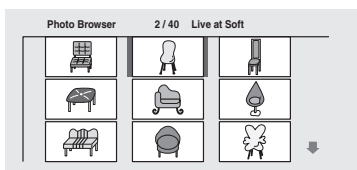

2



Use the cursor buttons (◀/▶/▲/▼) to highlight a thumbnail picture.

- Use the track skip buttons (⏮ and ⏭) to see the previous / next page of thumbnails. Keep the button pressed if you want to skip several pages; release when you reach the page you want.
- To return to the Disc Navigator screen, press RETURN.

3



Press ENTER to display the selected thumbnail full size on screen.

The slideshow resumes from the selected picture.

Zooming the screen

Using the zoom feature you can magnify a part of the screen by a factor of 2 or 4, while viewing pictures from a JPEG disc.

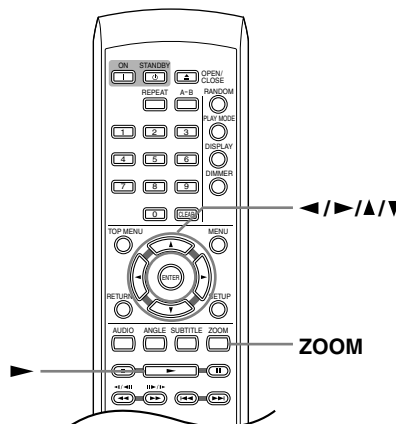

1



During slideshow playback, use the ZOOM button to select the zoom factor.

- Normal
- 2x
- 4x

Normal

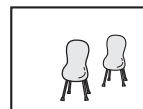

Zoom 2x

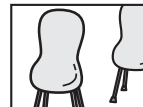

Zoom 4x



- The slideshow is paused when the screen is zoomed.
- Since JPEG pictures have a fixed resolution, picture quality may deteriorate, especially at 4x zoom. This is not a malfunction.

2

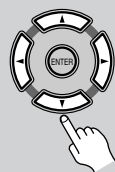

Use the cursor buttons (◀/▶/▲/▼) to change the zoomed area.

You can change the zoom factor and the zoomed area freely.

- When you change the zoom area, this becomes the new “default” zoom area for the disc loaded.

3

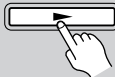

To resume the slideshow, press ► (play).

Audio Settings menu

Audio DRC

■ Default setting: Off

When watching Dolby Digital DVDs at low volume, it's easy to lose the quieter sounds completely—including some of the dialog.

Switching Audio DRC (Dynamic Range Control) to On can help by bringing up the quieter sounds, while controlling loud peaks.

How much of a difference you hear depends on the material you're listening to. If the material doesn't have wide variations in volume, you may not notice much change.

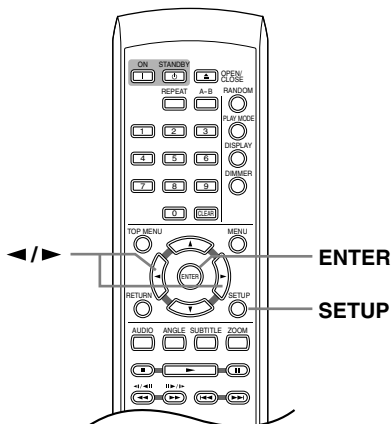

Notes:

- Audio DRC is only effective with Dolby Digital audio sources.
- Audio DRC is only effective through the digital output when “Digital Out” (see page 44) is set to “On”, and “Dolby Digital Out” (see page 44) is set to “Dolby Digital > PCM”.
- The effect of Audio DRC depends on your speakers and AV receiver settings.

- 

1 Press **SETUP** and select “Audio Settings” from the on-screen display.

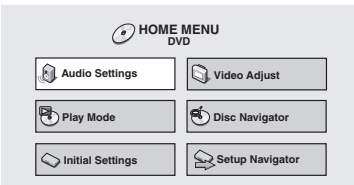

HOME MENU DVD

Audio Settings	Video Adjust
Play Mode	Disc Navigator
Initial Settings	Setup Navigator
- 

2 Highlight **Audio DRC**, then use the ◀/▶ (cursor left/right) buttons to change to “On” or “Off”, as required.



Audio Settings

Audio DRC ◀ Off ▶
- 

3 Press **ENTER** to make the setting and exit the Audio Settings screen.

Video Adjust menu

Video Adjust

■ Default setting: Standard

From the Video Adjust screen you can select the standard video presentation or define presets of your own.

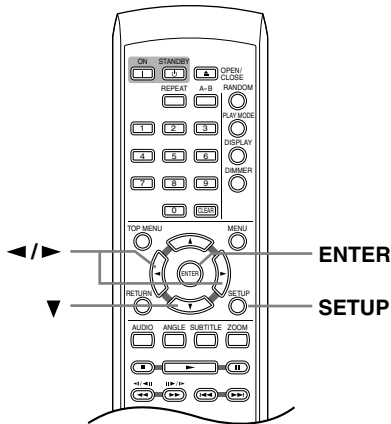

1

SETUP



Press **SETUP** and select “Video Adjust” from the on-screen display.

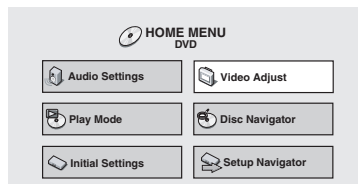

2



Use the **◀/▶** (cursor left/right) buttons to select a preset.



- With the Standard option, the default settings are used. If you choose this option, go to step 5.
- With the Memory 1-2 options, you can store and recall your own settings. If you select this option, go to step 3.

3



Press **▼** (cursor down) to select “Detailed Settings” then press **ENTER**.

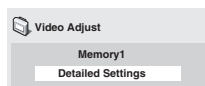

4

Adjust the picture quality settings.

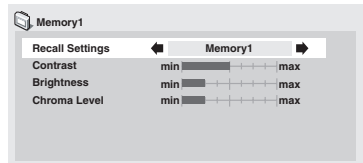

- Use the **▲/▼** (cursor up/down) buttons to select a setting.
 - Use the **◀/▶** (cursor left/right) buttons to adjust the current setting.
 - Press **DISPLAY** to switch between full and single view.
 - You can change the preset number from the “Recall Settings” menu item.
- You can adjust any or all of the following picture quality settings:

- **Contrast**—Adjusts the contrast between light and dark.
- **Brightness**—Adjusts the overall brightness.
- **Chroma Level**—Adjusts how saturated colors appear.

5



Press **ENTER** to save the preset and exit the Video Adjust screen.

Initial Settings menu

Using the Initial Settings menu

The Initial Settings menu gives you complete control in setting up your DVD player, including audio, and video output settings, audience limitation settings, among others.

If an option is grayed out it means that it cannot be changed at the current time. This is usually because a disc is playing. Stop the disc, then change the setting.

1

SETUP



While playback is stopped, press **SETUP** and select “Initial Settings” from the on-screen display.

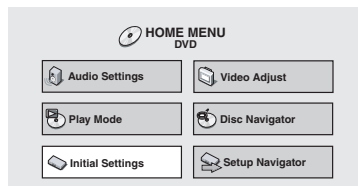

2

Select the setup category from the list on the left, then select an item from the menu list to the right.

3

Make the setting you want.

Note:

- The language options shown in the onscreen display illustrations on the following pages may not correspond to those available in your country or region.

Digital Audio Out settings

Digital Out

You only need to make this setting if you connected this player to an AV receiver (or other component) using one of the digital outputs.

■ Default setting: On

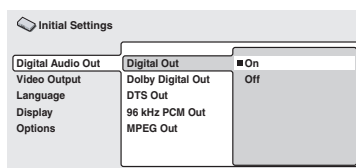

If at any time you need to switch off the digital audio output, set this to “Off”, otherwise leave it “On”.

Note that you can't switch on/off the optical and coaxial outputs individually.

Dolby Digital Out

You only need to make this setting if you connected this player to an AV receiver (or other component) using one of the digital outputs.

■ Default setting: Dolby Digital

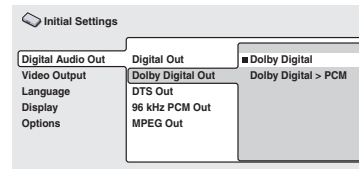

If your AV receiver (or other connected component) is Dolby Digital compatible, set to “Dolby Digital”, otherwise set to “Dolby Digital > PCM”.

DTS Out

You only need to make this setting if you connected this player to an AV receiver (or other component) using one of the digital outputs.

■ Default setting: DTS

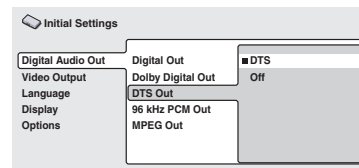

If your AV receiver (or other connected component) has a built-in DTS decoder, set this to “DTS”, otherwise set to “Off”. Check the manual that came with the other component if you're unsure whether it is DTS compatible.

Note:

- If you set to DTS with a non-DTS compatible amplifier, noise will be output when you play a DTS disc.

96kHz PCM Out

You only need to make this setting if you connected this player to an AV receiver (or other component) using one of the digital outputs.

■ Default setting: 96 kHz > 48kHz

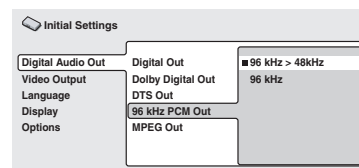

If your AV receiver (or other connected component) is compatible with high sampling rates (96 kHz), set this to “96 kHz,” otherwise set it to “96 kHz > 48 kHz” (96 kHz audio is converted to a more compatible 48 kHz). Check the manual that came with the other component if you're unsure whether it is 96 kHz compatible.

Initial Settings menu—Continued

MPEG Out

You only need to make this setting if you connected this player to an AV receiver (or other component) using one of the digital outputs.

■ Default setting: MPEG > PCM

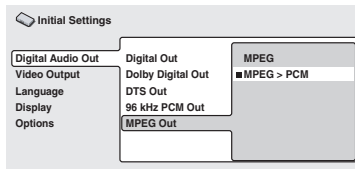

If your AV receiver (or other connected component) is compatible with MPEG audio, set this to “MPEG”, otherwise set it to “MPEG > PCM” (MPEG audio is converted to more compatible PCM audio). Check the manual that came with the other component if you’re unsure whether it is MPEG audio compatible.

Video Output settings

TV Screen

■ Default setting: 4:3 (Letter Box)

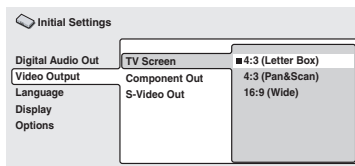

If you have a widescreen TV, select the “16:9 (Wide)” setting—widescreen DVD software is then shown using the full screen area. When playing software recorded in conventional (4:3) format, the settings on your TV will determine how the material is presented—see the manual that came with your TV for details on what options are available.

If you have a conventional TV, select either “4:3 (Letter Box)” or “4:3 (Pan & Scan)”. In Letter Box mode, widescreen software is shown with black bars at the top and bottom of the screen. Pan & Scan chops the sides off widescreen material to make it fit the 4:3 screen (so even though the image looks larger on the screen, you’re actually seeing less of the picture). See also “Screen sizes and disc formats” on page 50. Pan & Scan only works with DVD-Video discs that support Pan & Scan.

Component Out (Other than European models)

You only need to make this setting if you connected this player to a progressive scan compatible TV using the component video outputs.

■ Default setting: Interlace

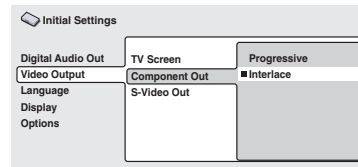

If you have a progressive-scan compatible TV, set this to “Progressive” for flicker-free video output. If your TV is not compatible with progressive-scan video, set to Interlace.

Check the operating instructions that came with your TV if you’re unsure about its compatibility.

- When setting to “Progressive”, you have to press ENTER once more to confirm. See also below for important information on progressive scan video.

About progressive scan video

Compared to interlace video, progressive scan video effectively doubles the scanning rate of the picture, resulting in a very stable, flicker-free image. Progressive scan video is available only from the component video output.

Notes:

- Other than U.S. & Canadian models and when TV system is set to “AUTO” or “NTSC” only: When Component Out (see above) is set to “Progressive”, there is no video output from the VIDEO OUT (composite) and S (S-video) jacks. If you want to display video on more than one monitor simultaneously, make sure that it is set to “Interlace.” See also “Setting the TV system” on page 50.
- If you connect a TV that is not compatible with a progressive scan signal and switch the player to progressive, you will not be able to see any picture at all. In this case, switch everything off and reconnect using the supplied video cable (see “Basic Setup” on page 19), then switch back to Interlace. Switch the player to standby then, using the front panel controls, press STANDBY/ON while pressing **◀◀** to switch the player back to “Interlace.”
- Other than U.S. & Canadian models and when TV system is set to “AUTO” or “NTSC” only: When set to “Progressive”, PAL and NTSC discs are both output as progressive NTSC video. When TV System is set to “PAL” only: Progressive cannot be selected. See page 50.

Compatibility of this unit with progressive-scan TVs.

This player is compatible with progressive video Macro Vision System Copy Guard.

CONSUMERS SHOULD NOTE THAT NOT ALL HIGH DEFINITION TELEVISION SETS ARE FULLY COMPATIBLE WITH THIS PRODUCT AND MAY CAUSE ARTIFACTS TO BE DISPLAYED IN THE PICTURE. IN CASE OF 525 PROGRESSIVE SCAN PICTURE PROBLEMS, IT IS RECOMMENDED THAT THE USER SWITCH THE CONNECTION TO THE “STANDARD DEFINITION” OUTPUT. IF THERE ARE QUESTIONS REGARDING OUR TV SET COMPATIBILITY WITH THIS MODEL 525p DVD PLAYER, PLEASE CONTACT OUR CUSTOMER SERVICE CENTER.

AV Connector Out (European models only)

You only need to make this setting if you connected this player to your TV using the AV SCART-type connector.

■ Default setting: Video

Notes:

- If you make a setting here that is incompatible with your TV, the TV may not display any picture at all. If this happens either switch everything off and reconnect to the TV using either the supplied audio/video cable, or an S-Video cable (see page 18 and page 20 for more on this).
- SCART cables come in various configurations. Make sure you use the correct one for your TV/monitor.

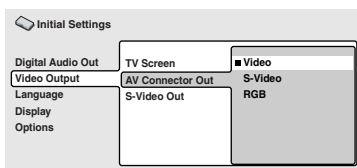

- **Video**—Standard video, compatible with all TVs.
- **S-Video**—Higher quality, but check your TV for compatibility.
- **RGB**—Best quality, but check your TV for compatibility.

S-Video Out

You only need to make this setting if you connected this player to your TV using an Svideo cable.

■ Default setting: S2

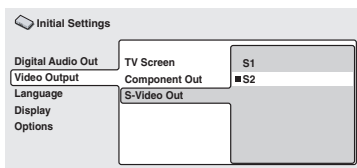

If you find that the picture is stretched or distorted on the default “S2” setting, try changing it to “S1”.

Language settings

Audio Language

■ Default setting: English

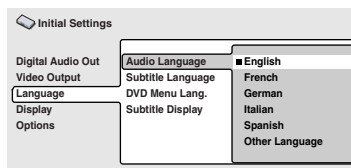

This setting is your preferred audio language for DVD discs. If the language you specify here is recorded on a disc, the player automatically plays the disc in that language.

The DVD format recognizes 136 different languages. Select “Other Language” if you want to specify a language other than those listed. See also “Selecting languages using the language code list” on page 51.

The available languages vary between models.

- North American and European models: English, French, Spanish, German, Italian, Other Language.
- Australian, Asian and South American models: English, French, Spanish, Chinese (traditional), Other Language.
- Chinese model: English, Chinese (simplified), Other Language.

Tips:

- You can switch between the languages recorded on a DVD disc during playback using the AUDIO button. (This does not affect this setting.) See “Switching DVD audio language” on page 37.
- Some DVD discs set the audio language automatically when loaded, overriding the “Audio Language” setting.
- Discs with two or more audio languages usually allow you to select the audio language from the disc menu. Press MENU to access the disc menu.

Subtitle Language

■ Default setting: English

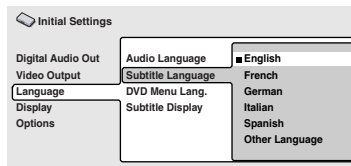

This setting is your preferred subtitle language for DVD discs. If the language you specify here is recorded on a disc, the player automatically plays the disc with those subtitles.

The DVD format recognizes 136 different languages. Select “Other Language” if you want to specify a language other than those listed. See also “Selecting languages using the language code list” on page 51.

Initial Settings menu—Continued

The available languages vary between models.

- North American and European models: English, French, Spanish, German, Italian, Other Language.
- Australian, Asian and South American models: English, French, Spanish, Chinese (traditional), Other Language.
- Chinese model: English, Chinese (simplified), Other Language.

Tips:

- You can change or switch off the subtitles on a DVD disc during playback using the SUBTITLE button. (This does not affect this setting.) See “Switching subtitles” on page 37.
- Some DVD discs set the subtitle language automatically when loaded, overriding the “Subtitle Language” setting.
- Discs with two or more subtitle languages usually allow you to select the subtitle language from the disc menu. Press MENU to access the disc menu.

DVD Menu Language

■ Default setting: w/Subtitle Lang.

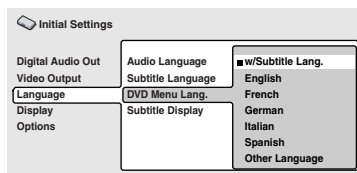

Some multilingual discs have disc menus in several languages. This setting specifies in which language the disc menus should appear. Leave on the default setting for menus to appear in the same language as your “Subtitle Language”—see above.

The DVD format recognizes 136 different languages. Select “Other Language” if you want to specify a language other than those listed. See also “Selecting languages using the language code list” on page 51.

The available languages vary between models.

- North American and European models: English, French, Spanish, German, Italian, Other Language.
- Australian, Asian and South American models: English, French, Spanish, Chinese (traditional), Other Language.
- Chinese model: English, Chinese (simplified), Other Language.

Subtitle Display

■ Default setting: On

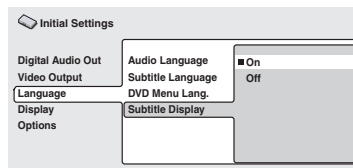

When set to “On”, the player displays subtitles according to the “Subtitle Language” setting. Set to “Off” to switch subtitles off altogether.

Display settings

OSD Language

■ Default setting: English

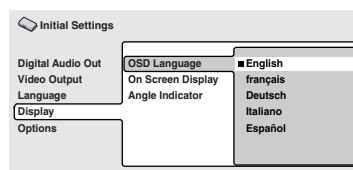

This sets the language of this player’s onscreen displays. The available languages vary between models.

- North American and European models: English, Français, Español, Deutsch, Italiano.
- Australian, Asian and South American models: English, Français, Español, 漢語.
- Chinese model: English, 汉语.

On Screen Display

■ Default setting: On

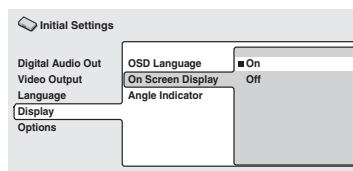

This sets whether operation displays are shown on-screen (“Play”, “Resume”, “Scan” and so on.)

Angle Indicator

■ Default setting: On

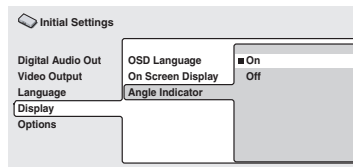

If you prefer not to see the camera icon onscreen during multi-angle scenes on DVD discs, change this setting to “Off”.

Options

Parental Lock

- **Default level:** Off
- **Default password:** none
- **Default Country code:** us (2119)

Some DVD-Video discs feature a Parental Lock level. If your player is set to a lower level than the disc, the disc won't play. This gives you some control about what your children watch on your DVD player.

Some discs also support the Country code feature. The player does not play certain scenes on these discs, depending on the Country code you set.

Before you can set the Parental Lock level or the Country code you must register a password.

As the password owner, you can change the Parental Lock level or Country code whenever you like. You can also change the password.

Notes:

- Not all discs that you may consider inappropriate for your children use the Parental Lock feature. These discs will always play without requiring the password first.
- If you forget your password, you'll need to reset the player to its factory settings (see "Resetting the player" on page 50), then register a new password.

Registering a new password

You must register a password before you can change the Parental Lock level or enter a Country code.

1 Select "Password".

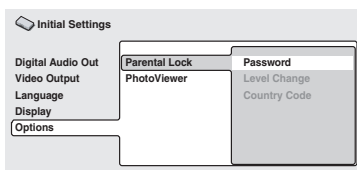

2 Use the number buttons to enter a 4-digit password.

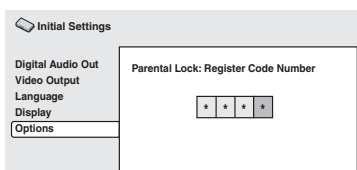

The numbers you enter show up as asterisks (*) on-screen.

- ### 3 Press ENTER to register the password and return to the Options menu screen.
- If you forget your password, you can reset the player then register a new one. See "Resetting the player" on page 50 for how to reset the player.

Changing your password

To change your password, confirm your existing password then enter a new one.

1 Select "Password Change".

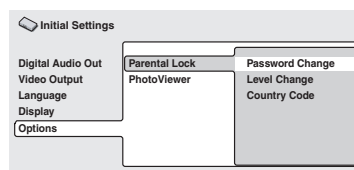

- ### 2 Use the number buttons to enter your existing password, then press ENTER.
- The numbers appear as asterisks as you enter them.

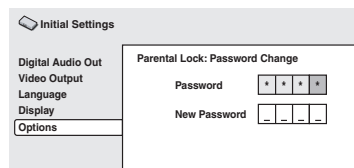

3 Enter a new password.

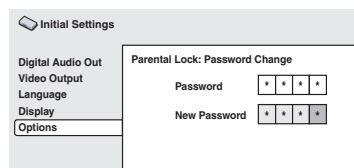

- ### 4 Press ENTER to register the new password and return to the Options menu screen.

Setting/changing the Parental Lock level

1 Select “Level Change”.

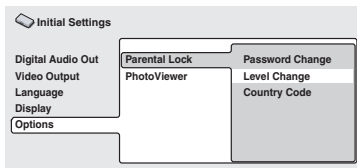

2 Use number buttons to enter your password, then press ENTER.

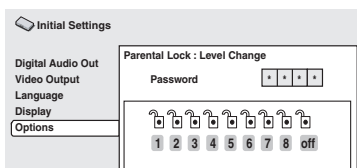

3 Select a new level.

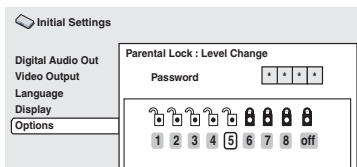

Press ◀ (cursor left) repeatedly to lock more levels (more discs will require the password); press ▶ (cursor right) to unlock levels. You can't lock level 1.

To cancel the Parental Lock function, select “Off.”

4 Press ENTER to set the new level and return to the Options menu screen.

Setting/changing the Country code

You may also want to refer to the “Country code list” on page 52.

1 Select “Country Code”.

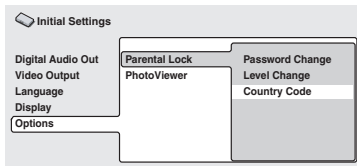

2 Use number buttons to enter your password, then press ENTER.

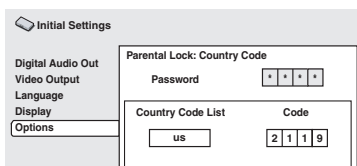

3 Select a Country code.

There are two ways you can do this.

- Select by code letter: Use ▼/▲ (cursor up/down) to change the Country code.

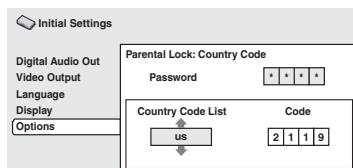

- Select by code number: Press ▶ (cursor right) then use the number buttons to enter the 4-digit Country code (you can find the “Country code list” on page 52.)

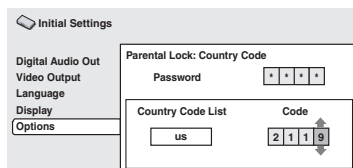

4 Press ENTER to set the new Country code and return to the Options menu screen.

Note:

- Changing the Country code does not take effect until the next disc is loaded (or the current disc is reloaded).

PhotoViewer

■ Default setting: On

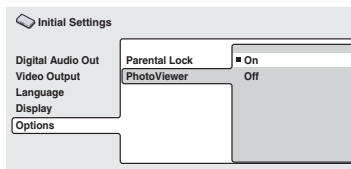

This setting is important if you load a disc that contains both WMA/MP3 audio files and JPEG picture files.

The default “On” setting allows you to view only the JPEG files on this kind of disc. Set to “Off” to be able to play the WMA/MP3 audio files.

Note:

- Changing the PhotoViewer setting does not take effect until the next disc is loaded (or the current disc is reloaded).

Additional information

Screen sizes and disc formats

DVD-Video discs come in several different screen aspect ratios, ranging from TV programs, which are generally 4:3, to Cinema-Scope widescreen movies, with an aspect ratio of up to about 7:3.

Televisions, too, come in different aspect ratios; “standard” 4:3 and widescreen 16:9.

Widescreen TV users

If you have a widescreen TV, the TV Screen setting (page 45) of this player should be set to “16:9 (Wide)”. When you watch discs recorded in 4:3 format, you can use the TV controls to select how the picture is presented. Your TV may offer various zoom and stretch options; see the instructions that came with your TV for details.

Please note that some movie aspect ratios are wider than 16:9, so even though you have a widescreen TV, these discs will still play in a “letter box” style with black bars at the top and bottom of the screen.

Standard TV users

If you have a standard TV, the “TV Screen” setting (page 45) of this player should be set to “4:3 (Letter Box)” or “4:3 (Pan&Scan)”, depending on which you prefer.

Set to “4:3 (Letter Box)”, widescreen discs are shown with black bars top and bottom.



Set to “4:3 (Pan&Scan)”, widescreen discs are shown with the left and right sides cropped.

Although the picture looks larger, you don’t actually see the whole picture.



Please note that many widescreen discs override the player’s settings so that the disc is shown in letter box format regardless of the setting.

Note:

- Using the “16:9 (Wide)” setting with a standard 4:3 TV, or either of the “4:3” settings with a widescreen TV, will result in a distorted picture.

Resetting the player

Use this procedure to reset all the player’s settings to the factory default.

1

Switch the player into standby.

2

Using the front panel buttons, hold down the  STOP button and press **STANDBY/ON** to switch the player back on.



Setting the TV system

(Not North American model)

The default setting of this player is “AUTO”, and unless you notice that the picture is distorted when playing some discs, you should leave it set to “AUTO”. If you experience picture distortion with some discs, set the TV system to match your country or region’s system. Doing this, however, may restrict the kinds of disc you can watch. The table below shows what kinds of disc are compatible with each setting (“AUTO”, “PAL” and “NTSC”).

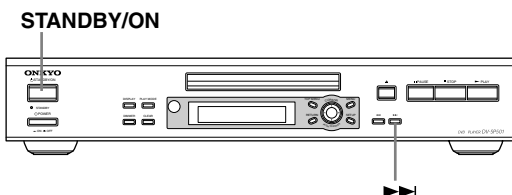

1

If the player is on, press **STANDBY/ON** to switch it to standby.

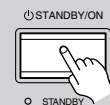

2

Using the front panel controls, hold down  then press **STANDBY/ON** to switch the TV system.

The TV system changes as follows:

→ AUTO → NTSC → PAL



Note:

- You have to switch the player into standby (press **STANDBY/ON**) before each change.

Disc		Player setting		
Type	Format	NTSC	PAL	AUTO
DVD	NTSC	NTSC	MOD.PAL	NTSC
Video CD	NTSC	NTSC	MOD.PAL	NTSC
	PAL	NTSC	PAL	PAL
CD/no disc	—	NTSC	PAL	NTSC or PAL

Titles, chapters and tracks

DVD discs are generally divided into one or more titles. Titles may be further subdivided into chapters.

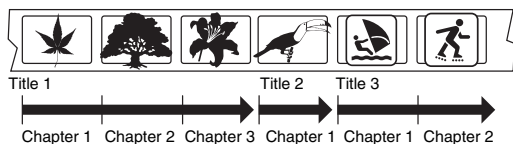

CDs and Video CDs are divided into tracks.

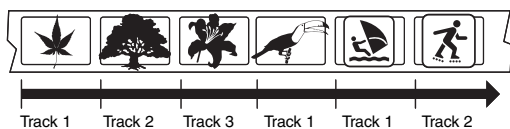

CD-ROMs contain folders and files. MP3 and WMA files are referred to as tracks. Folders may contain further folders.

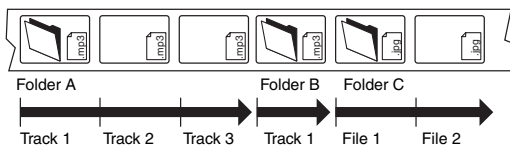

DVD-Video regions

All DVD-Video discs carry a region mark on the case somewhere that indicates which region(s) of the world the disc is compatible with. Your DVD player also has a region mark, which you can find on the rear panel. Discs from incompatible regions will not play in this player. Discs marked “ALL” will play in any player.

The diagram below shows the various DVD regions of the world.

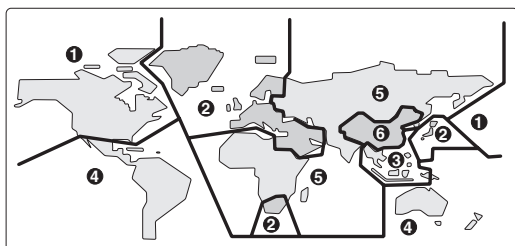

Selecting languages using the language code list

Some of the language options (such as “DVD Language” in the Setup Navigator) allow you to set your preferred language from any of the 136 languages listed in the language code list on page 53.

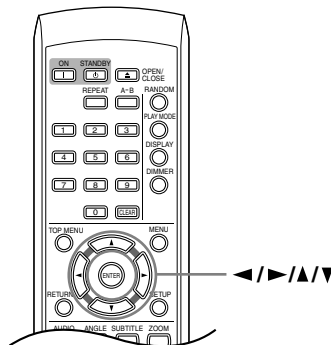

1

Select “Other Language”.

2



Use the ◀/▶ (cursor left/right) buttons to select either a code letter or a code number.

3



Use the ▼/▲ (cursor up/down) buttons to select a code letter or a code number.

See “Language code list” on page 53 for a complete list of languages and codes.

Country code list

Country	Country code	Country code letter
Argentina	0118	ar
Australia	0121	au
Austria	0120	at
Belgium	0205	be
Brazil	0218	br
Canada	0301	ca
Chile	0312	cl
China	0314	cn
Denmark	0411	dk
Finland	0609	fi
France	0618	fr
Germany	0405	de
Hong Kong	0811	hk
India	0914	in
Indonesia	0904	id
Italy	0920	it
Japan	1016	jp
Korea, Republic of	1118	kr
Malaysia	1325	my
Mexico	1324	mx
Netherlands	1412	nl
New Zealand	1426	nz
Norway	1415	no
Pakistan	1611	pk
Philippines	1608	ph
Portugal	1620	pt
Russian Federation	1821	ru
Singapore	1907	sg
Spain	0519	es
Sweden	1905	se
Switzerland	0308	ch
Taiwan	2023	tw
Thailand	2008	th
United Kingdom	0702	gb
USA	2119	us

Language code list

Language	Language code letter	Language code
Japanese	ja	1001
English	en	0514
French	fr	0618
German	de	0405
Italian	it	0920
Spanish	es	0519
Chinese	zh	2608
Dutch	nl	1412
Portuguese	pt	1620
Swedish	sv	1922
Russian	ru	1821
Korean	ko	1115
Greek	el	0512
Afar	aa	0101
Abkhazian	ab	0102
Afrikaans	af	0106
Amharic	am	0113
Arabic	ar	0118
Assamese	as	0119
Aymara	ay	0125
Azerbaijani	az	0126
Bashkir	ba	0201
Byelorussian	be	0205
Bulgarian	bg	0207
Bihari	bh	0208
Bislama	bi	0209
Bengali	bn	0214
Tibetan	bo	0215
Breton	br	0218
Catalan	ca	0301
Corsican	co	0315
Czech	cs	0319
Welsh	cy	0325
Danish	da	0401
Bhutani	dz	0426
Esperanto	eo	0515
Estonian	et	0520
Basque	eu	0521
Persian	fa	0601
Finnish	fi	0609
Fiji	fj	0610
Faroese	fo	0615
Frisian	fy	0625
Irish	ga	0701
Scots-Gaelic	gd	0704
Galician	gl	0712
Guarani	gn	0714
Gujarati	gu	0721
Hausa	ha	0801
Hindi	hi	0809

Language	Language code letter	Language code
Croatian	hr	0818
Hungarian	hu	0821
Armenian	hy	0825
Interlingua	ia	0901
Interlingue	ie	0905
Inupiak	ik	0911
Indonesian	in	0914
Icelandic	is	0919
Hebrew	iw	0923
Yiddish	ji	1009
Javanese	jw	1023
Georgian	ka	1101
Kazakh	kk	1111
Greenlandic	kl	1112
Cambodian	km	1113
Kannada	kn	1114
Kashmiri	ks	1119
Kurdish	ku	1121
Kirghiz	ky	1125
Latin	la	1201
Lingala	ln	1214
Laothian	lo	1215
Lithuanian	lt	1220
Latvian	lv	1222
Malagasy	mg	1307
Maori	mi	1309
Macedonian	mk	1311
Malayalam	ml	1312
Mongolian	mn	1314
Moldavian	mo	1315
Marathi	mr	1318
Malay	ms	1319
Maltese	mt	1320
Burmese	my	1325
Nauru	na	1401
Nepali	ne	1405
Norwegian	no	1415
Occitan	oc	1503
Oromo	om	1513
Oriya	or	1518
Panjabi	pa	1601
Polish	pl	1612
Pashto,Push to	ps	1619
Quechua	qu	1721
Rhaeto-Romance	rm	1813
Kirundi	rn	1814
Romanian	ro	1815
Kinyarwanda	rw	1823
Sanskrit	sa	1901

Language	Language code letter	Language code
Sindhi	sd	1904
Sangho	sg	1907
Serbo-Croatian	sh	1908
Sinhalese	si	1909
Slovak	sk	1911
Slovenian	sl	1912
Samoan	sm	1913
Shona	sn	1914
Somali	so	1915
Albanian	sq	1917
Serbian	sr	1918
Siswati	ss	1919
Sesotho	st	1920
Sundanese	su	1921
Swahili	sw	1923
Tamil	ta	2001
Telugu	te	2005
Tajik	tg	2007
Thai	th	2008
Tigrinya	ti	2009
Turkmen	tk	2011
Tagalog	tl	2012
Setswana	tn	2014
Tonga	to	2015
Turkish	tr	2018
Tsonga	ts	2019
Tatar	tt	2020
Twi	tw	2023
Ukrainian	uk	2111
Urdu	ur	2118
Uzbek	uz	2126
Vietnamese	vi	2209
Volapük	vo	2215
Wolof	wo	2315
Xhosa	xh	2408
Yoruba	yo	2515
Zulu	zu	2621

Using the RC-524DV Remote controller with TVs from Other Manufacturers (North American model only)

Learning a pre-programming code

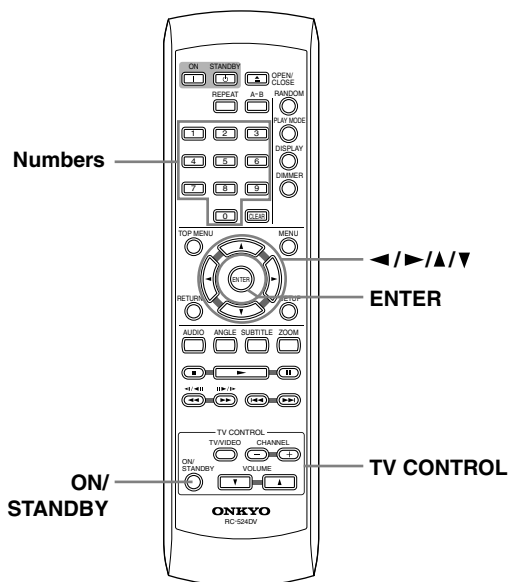

You can make RC-524DV remote controller to operate a TV from other brand than Onkyo by storing the pre-programming code of the brand in the RC-524DV.

- 1** Find the 3-digit number for the brand name of the component that you want to operate in the table on page 55.
- 2** Turn on the TV that you want to operate.
- 3** While holding down the ON/STANDBY on the RC-524DV that you want to program, press ENTER, and then release both buttons. (Make sure you press ON/STANDBY before ENTER.)
- 4** Within 10 seconds, enter the 3-digit code number.

- 5** Press some operation buttons for the component that you want to operate to check if the system operates properly.

If the system operates properly, the code is correct. If the component does not operate properly, return to step 2.

Notes:

- With some brand's components, some buttons may not work correctly.
- If more than one code is given in the table, try the code one by one until you reach the code for your component (i.e. if the first code does not work, then try the next).
- The code can be retained by changing the batteries within 1 minute. If the code is lost, store the pre-programming code again.

Controlling a TV

- 1** Press ON/STANDBY to turn on the device.
- 2** Press the desired operation button.
 - + : Changes the TV channel upward.
 - : Changes the TV channel downward.
 - ▲ : Increases the TV volume.
 - ▼ : Decrease the TV volume.
 - TV/VIDEO: Switches the TV/VCR inputs.

Using the RC-524DV Remote controller with TVs from Other Manufacturers (North American model only)—*Continued*

Pre-programming Code List

Brand	Code
AIWA	100, 101
AKAI	102, 103, 104
AUDIO SONIC	105
BELL&HOWELL	106
BLAUPUNKT	107
BRIONVEGA	108, 109
CENTURION	110
COLTINA	111, 112, 113
CORONAD	114
CROWN	115, 116
DAEWOO	117, 118, 119, 120, 121
DUAL	122
EMERSON	123, 124, 125, 126, 127
FENNER	128, 129
FERGUSON	130, 131
FISHER	132
FUNAI	133, 134, 135
FUJITSU GENERAL	136, 137, 138
GE • PANA	139, 140
GE • RCA	141
GOLD STAR	142, 143
GOODMANS	144
GRUNDIG	145, 146
HITACHI	147, 148, 149, 150
HYPER	151
INNO-HIT	152
IRRADIO	103
JVC	153, 154, 155, 156, 157
KENDO	158
KTV	159, 160
LUXOR	161
MAGNAVOX	162, 163
MARANTZ	164
MARK	165
MATSUI	166, 167, 168, 169
MITSUBISHI	170, 171, 172, 173
MIVAR	174, 175
NEC	176, 177
NOKIA	178, 179, 180, 181
NOKIA OCEANIC	181
NORDMENDE	182, 183
OKANO	152
ORION	184, 185, 186
PANASONIC	187, 188, 189, 190
PHILIPS	162, 191, 152
PIONEER	192, 193
PROSCAN	194
QUASAR	195
RADIOSHARK	196
RCA	141, 197, 198, 110, 199, 200

Brand	Code
SABA	201, 182, 183
SAMSUNG	202, 203, 204, 205, 206, 207, 208
SANYO	209, 210, 211, 212
SCHNEIDER	103
SEARS	213
SELECO	214, 215
SHARP	216, 217
SONY	218, 219, 220, 221, 222, 223
SYMPHONIC	224, 225
TELEFUNKEN	201, 226, 227
THOMSON	228
TOSHIBA	213, 229
UNIVERSUM	230
ZENITH	231, 232

Glossary

Analog audio

An electrical signal that directly represents sound. Compare this to digital audio which can be an electrical signal, but is an indirect representation of sound. See also “Digital audio”.

Aspect ratio

The width of a TV screen relative to its height. Conventional TVs are 4:3 (in other words, the screen is almost square); widescreen models are 16:9 (the screen is almost twice as wide as it is high).

Digital audio

An indirect representation of sound by numbers. During recording, the sound is measured at discrete intervals (44,100 times a second for CD audio) by an analog-to-digital converter, generating a stream of numbers.

On playback, a digital-to-analog converter generates an analog signal based on these numbers. See also “Sampling frequency” and “Analog audio”.

Dolby Digital

Using a maximum of 5.1 channels of audio,  this high quality surround system is used in many of the finer movie theaters around the world.

The on-screen display shows which channels are active, for example showing 3/2.1. The 3 being the two front channels and the center channel; the 2 being the surround channels, and the .1 being the LFE channel.

DRM

DRM (digital rights management) is a type of server software developed to enable secure distribution of paid content over the web, recently incorporated by WMA (Windows Media Audio).

DTS

DTS stands for Digital Theater Systems. DTS is  a surround system different from Dolby Digital that has become a popular surround sound format for movies.

Dynamic range

The difference between the quietest and loudest sounds possible in an audio signal (without distorting or getting lost in noise).

Dolby Digital and DTS soundtracks are capable of a very wide dynamic range, delivering dramatic cinema-like effects.

EXIF (Exchangeable Image File)

A file format developed by Fuji Photo Film for digital still cameras. Digital cameras from various manufacturers use this compressed file format which carries date, time and thumbnail information, as well as the picture data.

File extension

A tag added to the end of a filename to indicate the type of file. For example, “.mp3” indicates an MP3 file.

ISO 9660 format

International standard for the volume and file structure of CD-ROM discs.

JPEG

A file format used for still images, such as photographs and illustrations. JPEG files are identified by the file extension “.jpg” or “.JPG”. Most digital cameras use this format.

MP3

MP3 (MPEG1 audio layer 3) is a compressed audio file format. Files are recognized by their file extension “.mp3” or “.MP3”.

MPEG audio

An audio format used on Video CDs and some DVD discs. This unit can convert MPEG audio to PCM format for wider compatibility with digital recorders and AV amplifiers. See also “PCM (Pulse Code Modulation)”.

MPEG video

The video format used for Video CDs and DVDs. Video CD uses the older MPEG-1 standard, while DVD uses the newer and much better quality MPEG-2 standard.

PBC (PlayBack Control) (Video CD only)

A system of navigating a Video CD through on-screen menus recorded onto the disc. Especially good for discs that you would normally not watch from beginning to end all at once—karaoke discs, for example.

PCM (Pulse Code Modulation)

The most common system of encoding digital audio, found on CDs and DAT. Excellent quality, but requires a lot of data compared to formats such as Dolby Digital and MPEG audio. For compatibility with digital audio recorders (CD, MD and DAT) and AV amplifiers with digital inputs, this unit can convert Dolby Digital, DTS and MPEG audio to PCM. See also “Digital audio”.

Regions (DVD-Video only)

These associate discs and players with particular areas of the world. This unit will only play discs that have compatible region codes. You can find the region code of your unit by looking on the rear panel. Some discs are compatible with more than one region (or all regions).

Sampling frequency

The rate at which sound is measured to be turned into digital audio data. The higher the rate, the better the sound quality, but the more digital information is generated. Standard CD audio has a sampling frequency of 44.1kHz, which means 44,100 samples (measurements) per second. See also “Digital audio”.

WMA

WMA is short for Windows Media Audio and refers to an audio compression technology developed by Microsoft Corporation. WMA data can be encoded by using Windows Media Player version 8 or Windows Media Player for Windows XP.

Troubleshooting

If you have any trouble using your DV-SP501, check the following table for possible causes and remedies. If you still can't resolve the issue yourself, please contact your Onkyo dealer.

	Symptoms	Causes	Remedies
DVD Player	Can't turn on the DV-SP501?	The power cord is not connected.	Connect the power cord to a suitable wall outlet (page 23).
		The [POWER] switch is set to OFF.	Set the [POWER] switch to ON (page 23).
		External interference is affecting the DV-SP501's digital circuitry.	Turn off the DV-SP501, wait five seconds, then try turning it on again. If that fails, disconnect the power cord from the wall outlet, wait five seconds, reconnect it, then try turning it on again.
	The disc tray won't close properly?	The disc is not centered in the disc tray.	Place the disc in the center of the disc tray (page 26).
		The disc is dirty.	Remove the disc and clean it (page 10).
	Can't start playback?	No disc is loaded.	Load a disc (page 26).
		The disc cannot be played because it's incompatible.	Use only compatible discs (page 8).
		The disc is upside down.	Load the disc the correct way up (page 26).
		The disc is not centered in the disc tray.	Place the disc in the center of the disc tray (page 26).
		The disc is dirty.	Remove the disc and clean it (page 10).
		The disc uses parental lock and the Parental Lock function is on.	Turn off the Parental Lock function (page 48).
		The DVD-Video disc is intended for use in another region.	If the region number on the disc does not match the region number on the DV-SP501, the disc can't be played (page 51).
	The picture distorts occasionally?	The disc is dirty.	Remove the disc and clean it (page 10).
		You're using the Fast Forward or Fast Reverse function.	A little picture distortion may occur when using these functions. This is normal.
	Picture instability or noise?	The DV-SP501 is connected to your TV via a VCR or other video equipment and a copy-protection system is affecting the picture.	Connect the DV-SP501 directly to your TV (page 19).
No picture?	The wrong input source is selected on your TV.	On your TV, select the input to which the DV-SP501 is connected.	
	The video cable is not connected properly.	Check the video cable and correct as necessary (page 19).	
Settings are not saved?	If there's a power failure, or the power cord is disconnected inadvertently, any settings are lost.	Before you disconnect the power cord, set the DV-SP501 to Standby by pressing the [STANDBY/ON] button, and wait until "GOOD BYE" has disappeared from the display.	
Brightness is unstable or the picture is noisy?	The DV-SP501 is connected to your TV via a VCR or other video equipment and a copy-protection system is affecting the picture.	Connect the DV-SP501 directly to your TV (page 19).	
	Your TV doesn't support progressive scanning.	Reset the DV-SP501 to its initial settings (page 45).	
Chapters or tracks don't play in the correct order?	You are using repeat playback, program playback, or random playback.	Select normal playback (pages 32–35).	

Troubleshooting—Continued

DVD Player	Buttons on the DV-SP501 and remote controller don't work?	Power supply voltage fluctuations and other anomalies, such as static electricity, can interfere with normal operation.	Turn off the DV-SP501, wait five seconds, then turn it on again. If that doesn't resolve the issue, disconnect the power cord from the wall outlet, wait five seconds, reconnect it, then try again.
	No sound?	The 96 kHz PCM Out setting is set to "96 kHz."	Change the 96 kHz PCM Out setting to "96 kHz > 48 kHz," or use analog connections (page 44).
		The Digital Out setting is set to "Off."	Change the Digital Out setting to "On" (page 44).
		The wrong input source is selected on your TV, hi-fi amp, or AV receiver.	On your TV, hi-fi amp, or AV receiver, select the input to which the DV-SP501 is connected.
		The audio cable is not connected properly.	Check the audio cable and correct as necessary (page 21).
		The TV, hi-fi amp, or AV receiver connected to the DV-SP501's audio outputs is either not on or its volume is turned down.	Turn on the TV, hi-fi amp, or AV receiver and set its volume as appropriate.
		A DV-SP501 Digital Audio Out setting is set incorrectly.	Check the Digital Audio Out settings and correct as necessary (page 44).
		Playback is paused.	Resume playback (page 27).
	The DVD-Video disc or CD uses the DTS audio format and you are using the analog outputs.	DTS audio is only output by the digital outputs. To play DTS material you need to connect one of the DV-SP501's digital outputs to a digital input on a hi-fi amp or AV receiver that has a DTS decoder built-in (page 21).	
	The picture appears stretched or the wrong shape?	The TV Screen setting is wrong.	Set the TV Screen setting to match the aspect ratio of your TV (page 45).
		Your TV is connected with an S-Video cable.	If you've used an S-Video cable to connect your TV, in some cases the picture may appear stretched. In this case, try changing the S-Video Out setting to "S1" (page 46).
	Audio CD playback skips or jumps or is noisy?	The loaded audio CD uses copy control.	Copy-controlled CDs are special discs that don't conform to the audio CD standard and, therefore, may not work properly with the DV-SP501.
	An audio CD is loaded but the DV-SP501 displays "NO DISC"?		
	The first track doesn't play?		
	Locating a specific point takes longer than usual?		
	Playback starts in the middle of a track?		
Some sections of a track are skipped?			
Playback stops in the middle of a track?			
The DV-SP501 displays the wrong messages?			
Some MP3 files don't play?	MP3 files without a ".mp3" or ".MP3" filename extension are not recognized.	Use the correct filename extension (page 9).	
	The MP3 disc contains over 499 folders and 999 files.	The DV-SP501 recognizes only the first 499 folders and 999 files. Folders in excess of this aren't recognized and cannot be played (page 9).	
	The MP3 disc is a multisession disc.	The DV-SP501 doesn't fully support multisession discs. Only files in the first session can be played (page 9).	

Troubleshooting—Continued

DVD Player	Can't play MP3/WMA/JPEG discs?	The disc is not ISO 9660 Level 1 or 2 format.	Correct format should be used when recording is ISO 9660 and closed session (page 9).
		The disc has not been finalized.	Finalize the disc (page 9).
	Can't select MP3 files?	MP3 files without a ".mp3" or ".MP3" filename extension are not recognized.	Use the correct filename extension (page 9).
	Can't play WMA files?	WMA files without a ".wma" or ".WMA" filename extension are not recognized.	Use the correct filename extension (page 9).
		The WMA file's copyright option is on.	Don't use the copyright option (page 9).
	Can't view JPEG files?	JPEG files without a ".jpg" or ".JPG" filename extension are not recognized.	Use the correct filename extension (page 9).
Only Baseline JPEG files are supported. Progressive JPEG files are not.		Use Baseline JPEG files (page 9).	
Remote Controller	Buttons on the DV-SP501 work OK but those on the remote controller don't?	There are no batteries in the remote controller.	Install new batteries (page 11).
		The batteries are flat.	Replace with new batteries (page 11).
		The batteries are installed incorrectly.	Check the batteries and correct as necessary (page 11).
		You're not pointing the remote controller at the DV-SP501's remote sensor.	Point the remote controller at the DV-SP501's remote sensor (page 11).
		You're too far away from the DV-SP501.	Use the remote controller closer to the DV-SP501 (page 11). The remote controller has a range of approximately 16 ft. (5 meters).
		A strong light source is interfering with the DV-SP501's remote sensor.	Make sure that the DV-SP501 is not subjected to direct sunshine or inverter-type fluorescent lights. Relocate if necessary.
		If the DV-SP501 is installed in a cabinet with colored glass doors, the remote controller may not work reliably when the doors are closed.	Open the doors, or use a cabinet without colored glass.

The DV-SP501 contains a microcomputer for signal processing and control functions. In very rare situations, severe interference, noise from an external source, or static electricity may cause it to lockup. In the unlikely even that this should happen, unplug the power cord from the wall outlet, wait at least five seconds, and then plug it back in again.

Specifications

Video system		North American model: Standard NTSC, Other models: PAL/AUTO
Region code		North American model: 1, European model: 2, Australian and South American models: 4, Asian model: 3, Chinese model: 6
Laser		Semiconductor laser, wavelength 650 nm (DVD), 780 nm (CD)
Frequency response	DVD linear audio	4 Hz–20 kHz @ 48 kHz sampling rate 4 Hz–44 kHz @ 96 kHz sampling rate
	CD audio	4 Hz–20 kHz
Signal-to-noise ratio (digital audio)		106 dB
Audio dynamic range (digital audio)		96 dB
Harmonic distortion (digital audio)		0.008%
Wow and flutter		Below measurable level ($\pm 0.001\%$ (W. PEAK) or less)
Operating conditions	Temperature	5° to 35° C (41° F to 95° F)
	Installation	Install horizontally
Video outputs	COMPONENT VIDEO (Other than European models)	Y: 1.0 V (p-p), 75 Ω , negative sync, RCA/phono x1 Pb/Pb: 0.7 V (p-p), 75 Ω
	AV CONNECTOR (European model only)	0.7 V (p-p), 75 Ω , Scart x1
	S VIDEO (S-Video)	Y: 1.0 V (p-p), 75 Ω , negative sync, 4-pin mini DIN x1 C: 0.286 V (p-p), 75 Ω
	VIDEO (composite video)	1.0 V (p-p), 75 Ω , negative sync, RCA/phono x1
Audio outputs	OPTICAL	-22.5 dBm, optical connector x1
	COAXIAL	0.5 V (p-p), 75 Ω , RCA/phono x1
	ANALOG	2.0 V rms, 470 Ω , RCA/phono x1
General	Power supply	North American model: 120 V AC, 60 Hz Other models: 100–240 V AC, 50/60 Hz
	Power consumption	15 W
	Power consumption in Standby mode	North American model: 1.6 W Other models: 2.5 W
	Weight	3.3 kg (7.3 lbs.)
	Dimensions (W x H x D)	435 X 81 X 307 mm (17-1/8" X 3-3/16" X 12-1/16")

Specifications and features subject to change without notice.

ONKYO CORPORATION

Sales & Product Planning Div. : 2-1, Nisshin-cho, Neyagawa-shi, OSAKA 572-8540, JAPAN
Tel: 072-831-8111 Fax: 072-831-8124

ONKYO U.S.A. CORPORATION

18 Park Way, Upper Saddle River, N.J. 07458, U.S.A.
Tel: 201-785-2600 Fax: 201-785-2650 <http://www.onkyousa.com>

ONKYO EUROPE ELECTRONICS GmbH

Liegnitzerstrasse 6, 82194 Groebenzell, GERMANY
Tel: +49-8142-4401-0 Fax: +49-8142-4401-555 <http://www.onkyo.net>

ONKYO CHINA LIMITED

Units 2102-2107, Metroplaza Tower I, 223 Hing Fong Road, Kwai Chung,
N.T., HONG KONG Tel: 852-2429-3118 Fax: 852-2428-9039



Free Manuals Download Website

<http://myh66.com>

<http://usermanuals.us>

<http://www.somanuals.com>

<http://www.4manuals.cc>

<http://www.manual-lib.com>

<http://www.404manual.com>

<http://www.luxmanual.com>

<http://aubethermostatmanual.com>

Golf course search by state

<http://golfingnear.com>

Email search by domain

<http://emailbydomain.com>

Auto manuals search

<http://auto.somanuals.com>

TV manuals search

<http://tv.somanuals.com>