

ONKYO®

AV Receiver

TX-NR5008

TX-NR3008

Instruction Manual

Thank you for purchasing an Onkyo AV Receiver. Please read this manual thoroughly before making connections and plugging in the unit. Following the instructions in this manual will enable you to obtain optimum performance and listening enjoyment from your new AV Receiver. Please retain this manual for future reference.

Contents

Introduction2

Connections.....13

Turning On & Basic Operations27

Advanced Operations46

Controlling iPod & Other
Components.....86

Others99



WARNING:

TO REDUCE THE RISK OF FIRE OR ELECTRIC SHOCK, DO NOT EXPOSE THIS APPARATUS TO RAIN OR MOISTURE.

CAUTION:

TO REDUCE THE RISK OF ELECTRIC SHOCK, DO NOT REMOVE COVER (OR BACK). NO USER-SERVICEABLE PARTS INSIDE. REFER SERVICING TO QUALIFIED SERVICE PERSONNEL.



WARNING
RISK OF ELECTRIC SHOCK
DO NOT OPEN

AVIS
RISQUE DE CHOC ELECTRIQUE
NE PAS OUVRIR



The lightning flash with arrowhead symbol, within an equilateral triangle, is intended to alert the user to the presence of uninsulated "dangerous voltage" within the product's enclosure that may be of sufficient magnitude to constitute a risk of electric shock to persons.



The exclamation point within an equilateral triangle is intended to alert the user to the presence of important operating and maintenance (servicing) instructions in the literature accompanying the appliance.

Important Safety Instructions

1. Read these instructions.
2. Keep these instructions.
3. Heed all warnings.
4. Follow all instructions.
5. Do not use this apparatus near water.
6. Clean only with dry cloth.
7. Do not block any ventilation openings. Install in accordance with the manufacturer's instructions.
8. Do not install near any heat sources such as radiators, heat registers, stoves, or other apparatus (including amplifiers) that produce heat.
9. Do not defeat the safety purpose of the polarized or grounding-type plug. A polarized plug has two blades with one wider than the other. A grounding type plug has two blades and a third grounding prong. The wide blade or the third prong are provided for your safety. If the provided plug does not fit into your outlet, consult an electrician for replacement of the obsolete outlet.
10. Protect the power cord from being walked on or pinched particularly at plugs, convenience receptacles, and the point where they exit from the apparatus.
11. Only use attachments/accessories specified by the manufacturer.
12. Use only with the cart, stand, tripod, bracket, or table specified by the manufacturer, or sold with the apparatus. When a cart is used, use caution when moving the cart/apparatus combination to avoid injury from tip-over.

PORTABLE CART WARNING
S3125A
13. Unplug this apparatus during lightning storms or when unused for long periods of time.
14. Refer all servicing to qualified service personnel. Servicing is required when the apparatus has been damaged in any way, such as power-supply cord or plug is damaged, liquid has been spilled or objects have fallen into the apparatus, the apparatus has been exposed to rain or moisture, does not operate normally, or has been dropped.
15. Damage Requiring Service
Unplug the apparatus from the wall outlet and refer servicing to qualified service personnel under the following conditions:
 - A. When the power-supply cord or plug is damaged,
 - B. If liquid has been spilled, or objects have fallen into the apparatus,
 - C. If the apparatus has been exposed to rain or water,
 - D. If the apparatus does not operate normally by following the operating instructions. Adjust only those controls that are covered by the operating instructions as an improper adjustment of other controls may result in damage and will often require extensive work by a qualified technician to restore the apparatus to its normal operation,
 - E. If the apparatus has been dropped or damaged in any way, and
 - F. When the apparatus exhibits a distinct change in performance this indicates a need for service.
16. Object and Liquid Entry
Never push objects of any kind into the apparatus through openings as they may touch dangerous voltage points or short-out parts that could result in a fire or electric shock.
The apparatus shall not be exposed to dripping or splashing and no objects filled with liquids, such as vases shall be placed on the apparatus.
Don't put candles or other burning objects on top of this unit.
17. Batteries
Always consider the environmental issues and follow local regulations when disposing of batteries.
18. If you install the apparatus in a built-in installation, such as a bookcase or rack, ensure that there is adequate ventilation.
Leave 20 cm (8") of free space at the top and sides and 10 cm (4") at the rear. The rear edge of the shelf or board above the apparatus shall be set 10 cm (4") away from the rear panel or wall, creating a flue-like gap for warm air to escape.

Precautions

1. **Recording Copyright**—Unless it's for personal use only, recording copyrighted material is illegal without the permission of the copyright holder.
2. **AC Fuse**—The AC fuse inside the unit is not user-serviceable. If you cannot turn on the unit, contact your Onkyo dealer.
3. **Care**—Occasionally you should dust the unit all over with a soft cloth. For stubborn stains, use a soft cloth dampened with a weak solution of mild detergent and water. Dry the unit immediately afterwards with a clean cloth. Don't use abrasive cloths, thinners, alcohol, or other chemical solvents, because they may damage the finish or remove the panel lettering.

4. Power

WARNING

BEFORE PLUGGING IN THE UNIT FOR THE FIRST TIME, READ THE FOLLOWING SECTION CAREFULLY.

AC outlet voltages vary from country to country. Make sure that the voltage in your area meets the voltage requirements printed on the unit's rear panel (e.g., AC 230 V, 50 Hz or AC 120 V, 60 Hz).

The power cord plug is used to disconnect this unit from the AC power source. Make sure that the plug is readily operable (easily accessible) at all times.

Pressing **ON/STANDBY** to select Standby mode does not fully shutdown the unit. If you do not intend to use the unit for an extended period, remove the power cord from the AC outlet.

5. Preventing Hearing Loss

Caution

Excessive sound pressure from earphones and headphones can cause hearing loss.

6. Batteries and Heat Exposure

Warning

Batteries (battery pack or batteries installed) shall not be exposed to excessive heat as sunshine, fire or the like.

7. **Never Touch this Unit with Wet Hands**—Never handle this unit or its power cord while your hands are wet or damp. If water or any other liquid gets inside this unit, have it checked by your Onkyo dealer.

8. Handling Notes

- If you need to transport this unit, use the original packaging to pack it how it was when you originally bought it.
- Do not leave rubber or plastic items on this unit for a long time, because they may leave marks on the case.
- This unit's top and rear panels may get warm after prolonged use. This is normal.
- If you do not use this unit for a long time, it may not work properly the next time you turn it on, so be sure to use it occasionally.

For U.S. models

FCC Information for User

CAUTION:

The user changes or modifications not expressly approved by the party responsible for compliance could void the user's authority to operate the equipment.

NOTE:

This equipment has been tested and found to comply with the limits for a Class B digital device, pursuant to Part 15 of the FCC Rules. These limits are designed to provide reasonable protection against harmful interference in a residential installation.

This equipment generates, uses and can radiate radio frequency energy and, if not installed and used in accordance with the instructions, may cause harmful interference to radio communications. However, there is no guarantee that interference will not occur in a particular installation. If this equipment does cause harmful interference to radio or television reception, which can be determined by turning the equipment off and on, the user is encouraged to try to correct the interference by one or more of the following measures:

- Reorient or relocate the receiving antenna.
- Increase the separation between the equipment and receiver.
- Connect the equipment into an outlet on a circuit different from that to which the receiver is connected.
- Consult the dealer or an experienced radio/TV technician for help.

For Canadian Models

NOTE: THIS CLASS B DIGITAL APPARATUS COMPLIES WITH CANADIAN ICES-003.

For models having a power cord with a polarized plug:

CAUTION: TO PREVENT ELECTRIC SHOCK, MATCH WIDE BLADE OF PLUG TO WIDE SLOT, FULLY INSERT.

Modèle pour les Canadien

REMARQUE: CET APPAREIL NUMÉRIQUE DE LA CLASSE B EST CONFORME À LA NORME NMB-003 DU CANADA.

Sur les modèles dont la fiche est polarisée:

ATTENTION: POUR ÉVITER LES CHOCS ÉLECTRIQUES, INTRODUIRE LA LAME LA PLUS LARGE DE LA FICHE DANS LA BORNE CORRESPONDANTE DE LA PRISE ET POUSSER JUSQU'AU FOND.

For British models

Replacement and mounting of an AC plug on the power supply cord of this unit should be performed only by qualified service personnel.

IMPORTANT

The wires in the mains lead are coloured in accordance with the following code:

Blue: Neutral

Brown: Live

As the colours of the wires in the mains lead of this apparatus may not correspond with the coloured markings identifying the terminals in your plug, proceed as follows:

The wire which is coloured blue must be connected to the terminal which is marked with the letter N or coloured black.

The wire which is coloured brown must be connected to the terminal which is marked with the letter L or coloured red.

IMPORTANT

The plug is fitted with an appropriate fuse. If the fuse needs to be replaced, the replacement fuse must be approved by ASTA or BSI to BS1362 and have the same ampere rating as that indicated on the plug. Check for the ASTA mark or the BSI mark on the body of the fuse.

If the power cord's plug is not suitable for your socket outlets, cut it off and fit a suitable plug. Fit a suitable fuse in the plug.

For European Models

Declaration of Conformity

We, ONKYO EUROPE
ELECTRONICS GmbH
LIEGNITZERSTRASSE 6,
82194 GROEBENZELL,
GERMANY



declare in own responsibility, that the ONKYO product described in this instruction manual is in compliance with the corresponding technical standards such as EN60065, EN55013, EN55020 and EN61000-3-2, -3-3.

GROEBENZELL, GERMANY

K. MIYAGI

ONKYO EUROPE ELECTRONICS GmbH

Supplied Accessories

Make sure you have the following accessories:

Indoor FM antenna (→ 24)

AM loop antenna (→ 24)

Power cord (→ 24)

Speaker cable labels (→ 14)

Speaker setup microphone (→ 33)

Remote controller and two batteries (AA/R6)

(Note for China: The battery for the remote controller is not supplied for this unit.)

- * In catalogs and on packaging, the letter at the end of the product name indicates the color. Specifications and operations are the same regardless of color.

Using the Remote Controller

Installing the Batteries

Note

- If the remote controller doesn't work reliably, try replacing the batteries.
- Don't mix new and old batteries or different types of batteries.
- If you intend not to use the remote controller for a long time, remove the batteries to prevent damage from leakage or corrosion.
- Remove expired batteries as soon as possible to prevent damage from leakage or corrosion.

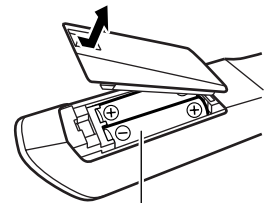

Batteries (AA/R6)

Aiming the Remote Controller

To use the remote controller, point it at the AV receiver's remote control sensor, as shown below.

Transmission

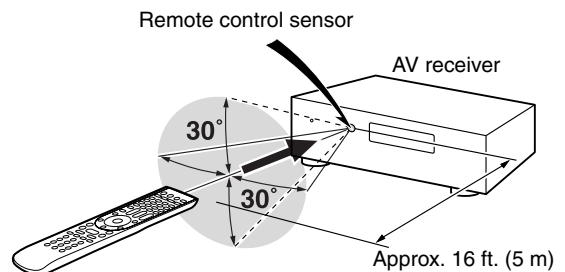

Received

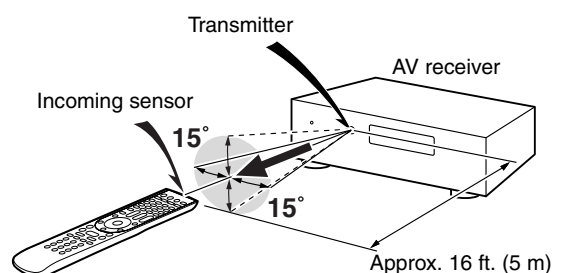

Contents

Introduction

Important Safety Instructions	2
Precautions	3
Supplied Accessories	4
Using the Remote Controller	4
Features	6
Front & Rear Panels	8
Front Panel.....	8
Display.....	9
Rear Panel	10
Remote Controller	11
Controlling the AV Receiver	11
About Home Theater	12
Enjoying Home Theater.....	12

Connections

Connecting the AV Receiver	13
Connecting Your Speakers	13
About AV Connections	20
Connecting Your Components with HDMI.....	21
Connecting Your Components	22
Connecting Onkyo RI Components	23
Connecting Antenna.....	24
Connecting the Power Cord	24
Which Connections Should I Use?	25

Turning On & Basic Operations

Turning On/Off the AV Receiver	27
Turning On	27
Turning Off	27
Basic Operations	28
Selecting the Language Used for the Onscreen Setup Menus	28
Playing the Connected Component.....	28
Displaying Source Information	28
Setting the Display Brightness	28
Muting the AV Receiver.....	29
Using the Sleep Timer.....	29
Selecting Speaker Layout	29
Using the Home Menu.....	30
Changing the Input Display	31
Using Headphones.....	31
Using ACTIVITIES to Start Easy Macros	31
Audyssey MultEQ® XT32 Room Correction and Speaker Setup	32
Listening to the Radio	35
Using the Tuner.....	35
Presetting FM/AM Stations.....	36
Using RDS (excluding North American models)	36
Recording	38
Using the Listening Modes	39
Selecting Listening Modes	39
About Listening Modes.....	40

Advanced Operations

Advanced Setup	46
On-screen Setup Menus.....	46
Common Procedures in Setup Menu	46
Input/Output Assign	47
Speaker Setup	50
Audio Adjust	54
Source Setup.....	57
Listening Mode Preset.....	62
Miscellaneous	63
Hardware Setup.....	64
Lock Setup.....	66
Using the Audio Settings	66
NET/USB	70
About NET	70
Connecting the AV Receiver	70
Listening to Internet Radio.....	71
Playing Music Files on a Server	72
Remote Playback from Media Server/Personal Computer	75
Network Settings	76
About USB	78
Multi Zone	80
Connecting Zone 2	80
Connecting Zone 3	81
Setting the Powered Zone 2/3	82
Setting the Multi Zone.....	83
Using Zone 2/3	83
Using the Remote Controller in Zone 2/3 and Multiroom Control Kits	85
Controlling iPod & Other Components	
Controlling iPod	86
Connecting the iPod Directly to the USB Port	86
Connecting an Onkyo Dock.....	87
Using the Onkyo Dock.....	88
Controlling Your iPod.....	89
Controlling Other Components	91
Preprogrammed Remote Control Codes	91
Looking up for Remote Control Code	91
Entering Remote Control Codes.....	93
Remote Control Codes for Onkyo Components Connected via RI	93
Resetting REMOTE MODE Buttons	94
Resetting the Remote Controller	94
Controlling Other Components	94
Activities Setup	96
Learning Commands	97
Using Normal Macros	98
Others	
Troubleshooting	99
Specifications (TX-NR5008)	105
Specifications (TX-NR3008)	107
About HDMI	109
Using an RIHD-compatible TV, Player, or Recorder ...	110
Firmware Update	112
Updating the Firmware via Network	112
Updating the Firmware via USB	113
Video Resolution Chart	115

To reset the AV receiver to its factory defaults, turn it on and, while holding down VCR/DVR, press ON/STANDBY (→ 99).

Features

Amplifier

(TX-NR5008)

- 145 Watts/Channel @ 8 ohms (FTC)
- 220 Watts/Channel @ 6 ohms (IEC)
- 280 Watts/Channel @ 6 ohms (JEITA)

(TX-NR3008)

- 140 Watts/Channel @ 8 ohms (FTC)
- 200 Watts/Channel @ 6 ohms (IEC)
- 250 Watts/Channel @ 6 ohms (JEITA)
- WRAT–Wide Range Amplifier Technology (5 Hz to 100 kHz bandwidth)
- Linear Optimum Gain Volume Circuitry
- 3-Step Inverted Darlington Circuitry
- **(TX-NR5008)** Massive Toroidal Transformer
- **(TX-NR3008)** Massive Transformer

Processing

- THX Ultra2 Plus*¹ Certified
- HQV-Reon-VX Video Processing with 1080p Video Upscaling of All Video Sources via HDMI
- HDMI (Ver.1.4a with Audio Return Channel, 3D), Deep Color, x.v.Color*², Lip Sync, DTS*³-HD Master Audio, DTS-HD High Resolution Audio, Dolby TrueHD*⁴, Dolby Digital Plus, DSD and Multi-CH PCM
- Dolby Pro Logic IIz*⁴ – New Surround Format (front-high)
- Audyssey DSX™*⁵ for New Surround Channels (front-wide/front-high)
- 4 DSP Modes for Gaming; Rock/Sports/Action/RPG
- Non-Scaling Configuration
- A-Form Listening Mode Memory
- Direct Mode
- Pure Audio Mode
- Music Optimizer*⁶ for Compressed Digital Music files
- **(TX-NR5008)** High-Performance Burr-Brown 192 kHz/32-Bit DACs
- **(TX-NR3008)** Burr-Brown 192 kHz/24-Bit DACs
- Powerful and Highly Accurate 32-bit Processing DSP
- Jitter Cleaning Circuit Technology
- Neural Surround Decoding*⁷
- DSD Direct for Super Audio CD

Connections

- 8 HDMI*⁸ Inputs (1 on front panel) and 2 Outputs
- Onkyo **RIHD** for System Control
- **(TX-NR5008)** 7 Digital Inputs (4 Optical/3 Coaxial)
- **(TX-NR3008)** 6 Digital Inputs (3 Optical/3 Coaxial)
- Component Video Switching (3 Inputs/1 Output)
- Universal Port for the Optional Dock for iPod*⁹/HD Radio™*¹⁰ tuner module (**North American models**)/DAB+ tuner module (**European and Asian models**)
- 2 Independent Subwoofer Pre Outs
- Banana Plug-Compatible Speaker Posts*¹¹
- Powered Zone 2/3
- Internet Radio* Connectivity (SIRIUS Internet Radio*¹²/vTuner/Last.fm/Pandora/Rhapsody*¹³/Slacker/Mediafly/Napster)
* Services available may vary depending on the region.
- Network Capability for Streaming Audio Files
- Bi-Amping and BTL Capability
- **(TX-NR5008)** 2 USB Inputs for Memory Devices and iPod®/iPhone® models (Front: 1 (Enables Display of Album Artwork)/Rear: 1)
- **(TX-NR3008)** Front-Panel USB Input for Memory Devices and iPod®/iPhone® models (Enables Display of Album Artwork)
- Analog RGB Video Input (D-sub 15) for PC

Miscellaneous

- **(North American models)** 40 SIRIUS*¹²/FM/AM Presets
- **(Excluding North American models)** 40 FM/AM Presets
- Dolby Volume*⁴
- Audyssey MultEQ® XT32*⁵ to Correct Room Acoustic Problems
- Audyssey Dynamic EQ®*⁵ for Loudness Correction
- Audyssey Dynamic Volume®*⁵ to Maintain Optimal Listening Level and Dynamic Range
- Crossover Adjustment (40/50/60/70/80/90/100/120/150/200 Hz)
- A/V Sync Control Function (up to 250 ms)
- Auto Power-down Function
- Bi-Directional Preprogrammed (with onscreen display setup) RI-Compatible Learning Remote with 4 Activities and Mode-Key LEDs
- ISF (Imaging Science Foundation) Video Calibration
- VLSC*¹⁴ (Vector Linear Shaping Circuitry) for All Channels



*1 THX and the THX logo are trademarks of THX Ltd. which may be registered in some jurisdictions. All rights reserved.

*2 “x.v.Color” is a trademark of Sony Corporation.



*3 Manufactured under license under U.S. Patent #'s: 5,451,942; 5,956,674; 5,974,380; 5,978,762; 6,226,616; 6,487,535; 7,212,872; 7,333,929; 7,392,195; 7,272,567 & other U.S. and worldwide patents issued & pending. DTS and the Symbol are registered trademarks, & DTS-HD, DTS-HD Master Audio, and the DTS logos are trademarks of DTS, Inc. Product includes software.

© DTS, Inc. All Rights Reserved.



*4 Manufactured under license from Dolby Laboratories. “Dolby”, “Pro Logic”, “Surround EX” and the double-D symbol are trademarks of Dolby Laboratories.



*5 Manufactured under license from Audyssey Laboratories™. U.S. and foreign patents pending. Audyssey MultEQ® XT32, Audyssey DSX™, Audyssey Dynamic Volume® and Audyssey Dynamic EQ® are registered trademarks and trademarks of Audyssey Laboratories.

*6 Music Optimizer™ is a trademark of Onkyo Corporation.



*7 Manufactured under license from DTS Licensing Limited. DTS and the Symbol are registered trademarks, & DTS Neural Surround and the DTS logos are trademark of DTS, Inc. Product includes software. © DTS, Inc. All Rights Reserved.



*8 “HDMI, the HDMI Logo, and High-Definition Multimedia Interface are trademarks or registered trademarks of HDMI Licensing LLC in the United States and other countries.”



*9 iPhone, iPod, iPod classic, iPod nano, iPod shuffle, and iPod touch are trademarks of Apple Inc., registered in the U.S. and other countries.

“Made for iPod” and “Made for iPhone” mean that an electronic accessory has been designed to connect specifically to iPod or iPhone, respectively, and has been certified by the developer to meet Apple performance standards. Apple is not responsible for the operation of this device or its compliance with safety and regulatory standards.



*10 HD Radio™ and the HD Radio Ready logo are proprietary trademarks of iBiquity Digital Corporation. To receive HD Radio broadcasts, you must install an Onkyo UP-HT1 HD Radio tuner module (sold separately).

*11 In Europe, using banana plugs to connect speakers to an audio amplifier is prohibited.



*12 SIRIUS, XM and all related marks and logos are trademarks of Sirius XM Radio Inc. and its subsidiaries. All rights reserved. Service not available in Alaska and Hawaii.

*13 Rhapsody and the Rhapsody logo are registered trademarks of RealNetworks, Inc.



*14 VLSC™ is a trademark of Onkyo Corporation.

THX Ultra2 Plus

Before any home theater component can be THX Ultra2 Plus certified, it must pass a rigorous series of quality and performance tests. Only then can a product feature the THX Ultra2 Plus logo, which is your guarantee that the Home Theater products you purchase will give you superb performance for many years to come. THX Ultra2 Plus requirements define hundreds of parameters, including power amplifier performance, and pre-amplifier performance and operation for both digital and analog domains. THX Ultra2 Plus receivers also feature proprietary THX technologies (e.g., THX Mode) which accurately translate movie soundtracks for home theater playback.

- * “Xantech” is a registered trademark of Xantech Corporation.
- * “Niles” is a registered trademark of Niles Audio Corporation.
- * “DLNA®, the DLNA Logo and DLNA CERTIFIED™ are trademarks, service marks, or certification marks of the Digital Living Network Alliance.”
- * Re-Equalization and the “Re-EQ” logo are trademarks of THX Ltd.
- * This item incorporates copy protection technology that is protected by U.S. patents and other intellectual property rights of Rovi Corporation. Reverse engineering and disassembly are prohibited.
- * Windows and the Windows logo are trademarks of the Microsoft group of companies.

Front & Rear Panels

Front Panel

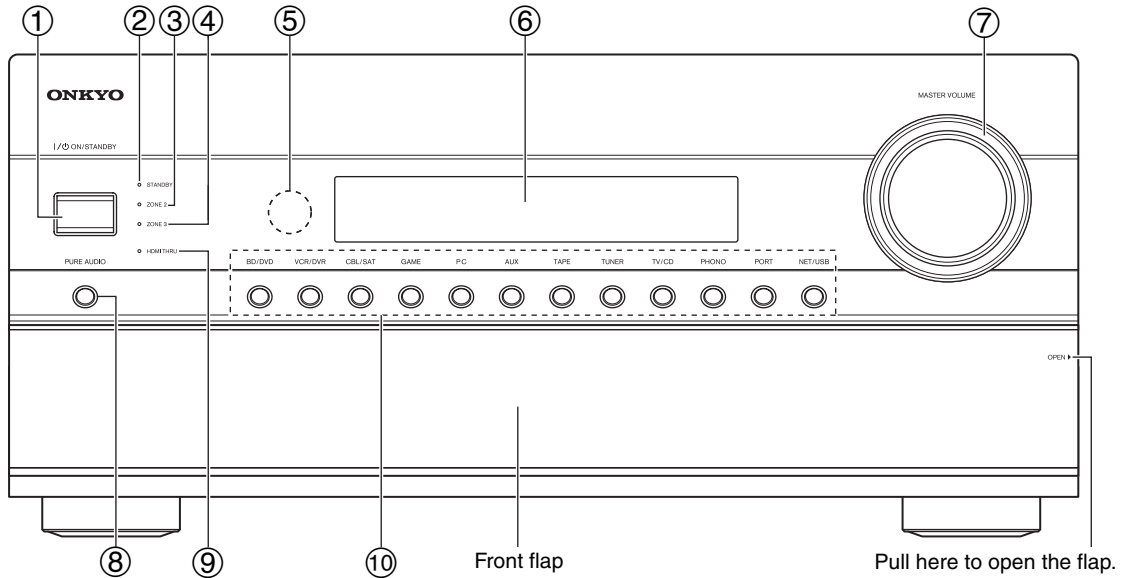

The actual front panel has various logos printed on it. They are not shown here for clarity.
The page numbers in parentheses show where you can find the main explanation for each item.

- | | |
|--|---|
| ① ON/STANDBY button (→ 27) | ⑦ MASTER VOLUME control and indicator (→ 28) |
| ② STANDBY indicator (→ 27) | ⑧ PURE AUDIO button (→ 39) |
| ③ ZONE 2 indicator (→ 83) | ⑨ HDMI THRU indicator (→ 65) |
| ④ ZONE 3 indicator (→ 83) | ⑩ Input selector buttons (BD/DVD, VCR/DVR, CBL/SAT, GAME, PC, AUX, TAPE, TUNER, TV/CD, PHONO, PORT and NET/USB) (→ 28) |
| ⑤ Remote control sensor/transmitter (→ 4) | |
| ⑥ Display (→ 9) | |

(North American models)

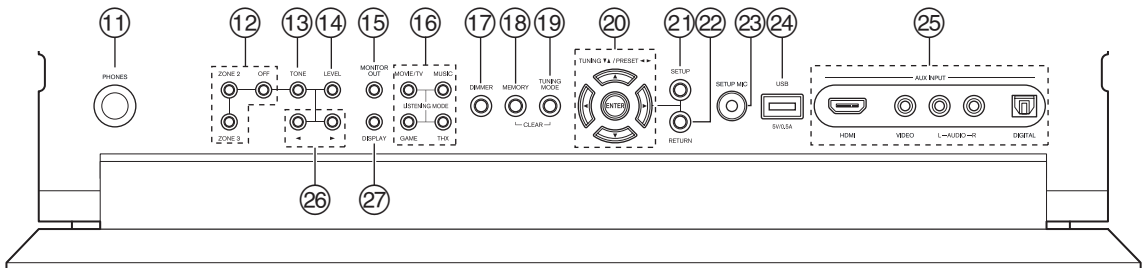

(European and Asian models)

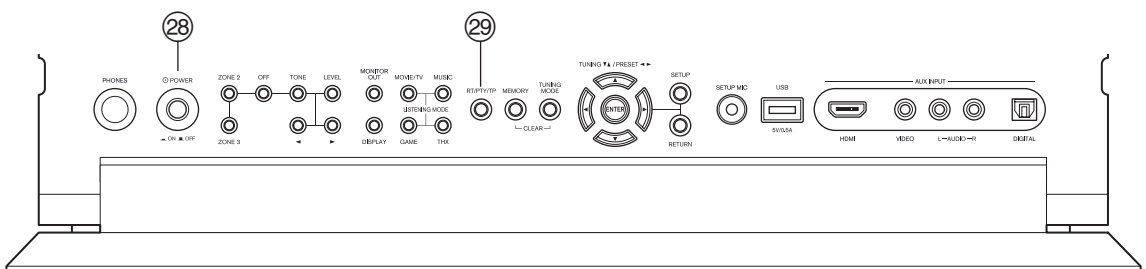

The page numbers in parentheses show where you can find the main explanation for each item.

- ① PHONES jack (→ 31)
- ② ZONE 2, ZONE 3 and OFF buttons (→ 83)
- ③ TONE button (→ 66, 84)
- ④ LEVEL button (→ 84)
- ⑤ MONITOR OUT button (→ 47)
- ⑥ LISTENING MODE buttons (MOVIE/TV, MUSIC, GAME and THX) (→ 39)
- ⑦ DIMMER button (North American models) (→ 28)
- ⑧ MEMORY button (→ 36)
- ⑨ TUNING MODE button (→ 35)
- ⑩ TUNING, PRESET (→ 35 to 36), arrow and ENTER buttons
- ⑪ SETUP button (→ 46)
- ⑫ RETURN button
- ⑬ SETUP MIC jack (→ 33)
- ⑭ USB port (→ 78, 86)
- ⑮ AUX INPUT jacks (HDMI, VIDEO, AUDIO L/R and DIGITAL) (→ 21, 22)
- ⑯ Up ► and Down ◀ buttons (→ 66, 84)
- ⑰ DISPLAY button (→ 28)
- ⑱ POWER switch (European and Asian models) (→ 27)
- ⑲ RT/PTY/TP button (European and Asian models) (→ 36)

Display

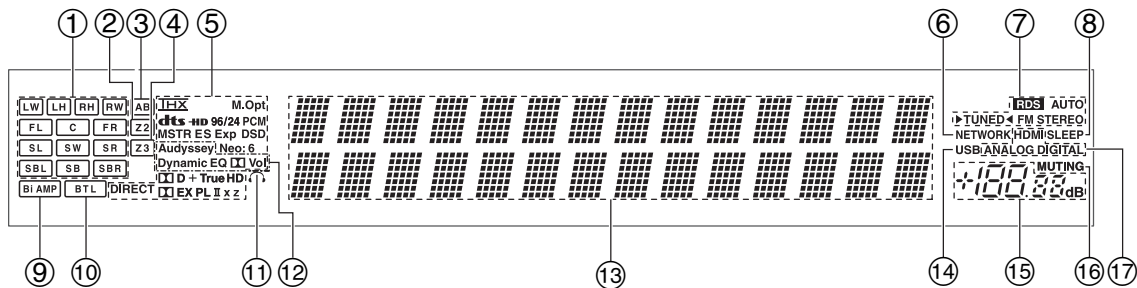

For detailed information, see the pages in parentheses.

- ① Speaker/channel indicators
- ② Z2 (Powered Zone 2) indicator (→ 83)
- ③ A and B speaker indicator (→ 13)
- ④ Z3 (Powered Zone 3) indicator (→ 83)
- ⑤ Listening mode and format indicators (→ 39, 67)
- ⑥ NETWORK indicator (→ 71, 72, 76)
- ⑦ Tuning indicators
 - RDS indicator (excluding North American models) (→ 36)
 - AUTO indicator (→ 35)
 - TUNED indicator (→ 35)
 - FM STEREO indicator (→ 35)
- ⑧ SLEEP indicator (→ 29)
- ⑨ Bi AMP indicator (→ 17, 18)
- ⑩ BTL indicator (→ 18, 19)
- ⑪ Headphone indicator (→ 31)
- ⑫ Audyssey indicator (→ 32, 53)
 - Dynamic EQ indicator (→ 57)
 - ◻ (Dolby) Vol indicator (→ 55)
 - Dynamic Vol indicator (→ 58)
- ⑬ Message area
- ⑭ USB indicator (→ 78, 86)
- ⑮ Volume level (→ 28)
- ⑯ MUTING indicator (→ 29)
- ⑰ Audio input indicators

Rear Panel

Illustration is based on TX-NR5008.

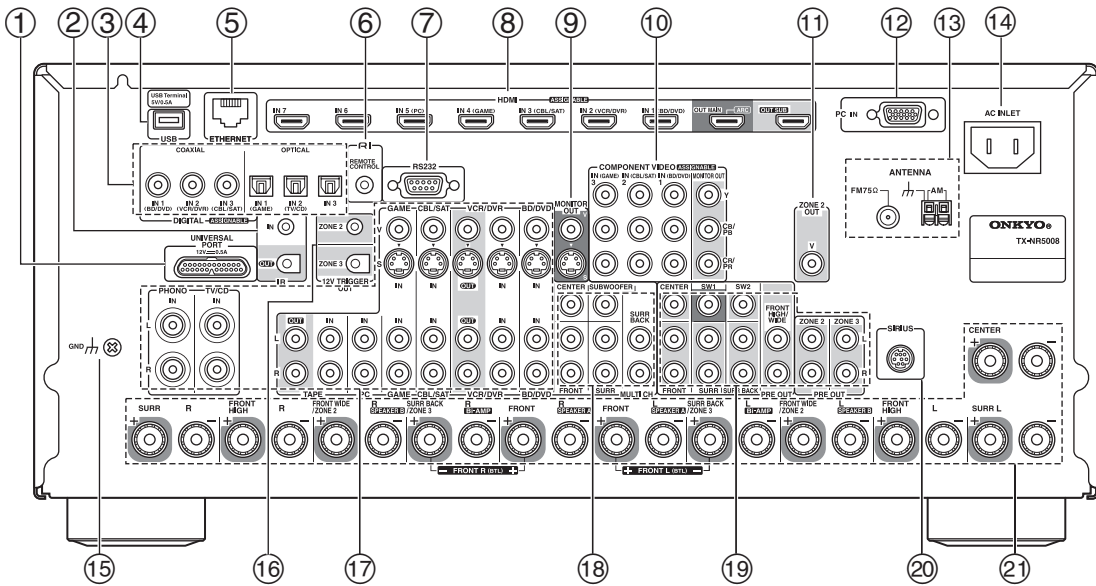

- ① **UNIVERSAL PORT** jack
- ② **IR IN** and **OUT** jacks
- ③ **DIGITAL IN** COAXIAL and **OPTICAL** jacks
- ④ **USB** port (TX-NR5008)
- ⑤ **ETHERNET** port
- ⑥ **RI REMOTE CONTROL** jack
- ⑦ **RS232** terminal
Terminal for control.
- ⑧ **HDMI IN** and **HDMI output** (**HDMI OUT MAIN** and **HDMI OUT SUB**) jacks
- ⑨ **MONITOR OUT V** and **S** jacks
- ⑩ **COMPONENT VIDEO IN** and **MONITOR OUT** jacks
- ⑪ **ZONE 2 OUT V** jack
- ⑫ **PC IN** port
- ⑬ **FM ANTENNA** jack and **AM ANTENNA** terminal
- ⑭ **AC INLET**
- ⑮ **GND** screw
- ⑯ **ZONE 2 and ZONE 3 12V TRIGGER OUT** jacks
- ⑰ **Composite video, S-Video** and **analog audio jacks** (**BD/DVD IN**, **VCR/DVR IN** and **OUT**, **CBL/SAT IN**, **GAME IN**, **PC IN**, **TAPE IN** and **OUT**, **TV/CD IN** and **PHONO IN**)
- ⑱ **MULTI CH** input jacks (**FRONT L/R**, **CENTER**, **SURR L/R**, **SURR BACK L/R** and **SUBWOOFER**)
- ⑲ **PRE OUT** jacks (**FRONT L/R**, **CENTER**, **SURR L/R**, **SURR BACK L/R**, **FRONT HIGH/WIDE L/R**, **SW1**, **SW2**, **ZONE 2 L/R** and **ZONE 3 L/R**)
- ⑳ **SIRIUS** antenna jack (North American models)
- ㉑ **Speaker Terminals** (**FRONT L/R**, **CENTER**, **SURR L/R**, **SURR BACK/ZONE 3 L/R**, **FRONT HIGH L/R** and **FRONT WIDE/ZONE 2 L/R**)

See "Connecting the AV Receiver" for connection information (→ 13 to 26).

Remote Controller

Controlling the AV Receiver

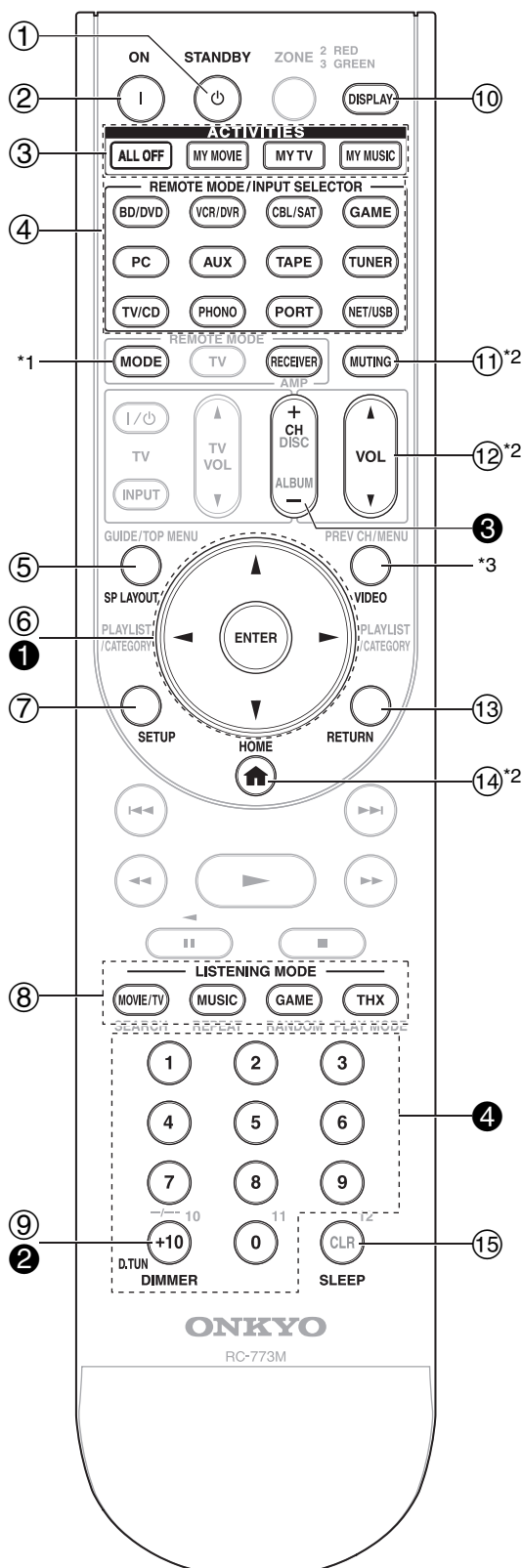

To control the AV receiver, press **RECEIVER** to select Receiver mode.

You can also use the remote controller to control Onkyo Blu-ray Disc/DVD player, CD player and other components.

See “Entering Remote Control Codes” for more details (→ 93).

For detailed information, see the pages in parentheses.

- ① **STANDBY** button (→ 27)
- ② **ON** button (→ 27)
- ③ **ACTIVITIES** buttons (**ALL OFF**, **MY MOVIE**, **MY TV** and **MY MUSIC**) (→ 31, 98)
- ④ **REMOTE MODE/INPUT SELECTOR** buttons (**BD/DVD**, **VCR/DVR**, **CBL/SAT**, **GAME**, **PC**, **AUX**, **TAPE**, **TUNER**, **TV/CD**, **PHONO**, **PORT** and **NET/USB**) (→ 28)
- ⑤ **SP LAYOUT** button (→ 29)
- ⑥ **Arrow** ▲/▼/◀/▶ and **ENTER** buttons
- ⑦ **SETUP** button (→ 46)
- ⑧ **LISTENING MODE** buttons (**MOVIE/TV**, **MUSIC**, **GAME** and **THX**) (→ 39)
- ⑨ **DIMMER** button (→ 28)
- ⑩ **DISPLAY** button (→ 28)
- ⑪ **MUTING** button (→ 29)
- ⑫ **VOL** ▲/▼ button (→ 28)
- ⑬ **RETURN** button
- ⑭ **HOME** button (→ 30)
- ⑮ **SLEEP** button (→ 29)

■ Controlling the tuner

To control the AV receiver’s tuner, press **TUNER** (or **RECEIVER**).

You can select AM or FM by pressing **TUNER** repeatedly.

- ① **Arrow** ▲/▼ buttons (→ 35)
- ② **D.TUN** button (**TUNER** remote mode only) (→ 35)
- ③ **CH +/-** button (→ 36)
- ④ **Number** buttons (→ 35)

*1 When you want to change the remote controller mode without changing the current input source, press **MODE** and within about 8 seconds, press **REMOTE MODE**. Then, with the AV receiver’s remote controller, you can control the component corresponding to the button you pressed.

*2 These buttons can be used when not in receiver mode, and when a **REMOTE MODE** other than receiver mode is selected. (Pressing **HOME** switches to Receiver mode.)

*3 **VIDEO** functions as a short cut of **Video** section of Home menu (→ 30).

About Home Theater

Enjoying Home Theater

Thanks to the AV receiver's superb capabilities, you can enjoy surround sound with a real sense of movement in your own home—just like being in a movie theater or concert hall. With Blu-ray Discs or DVDs, you can enjoy DTS and Dolby Digital. With analog or digital TV, you can enjoy Dolby Pro Logic IIx, DTS Neo:6, or Onkyo's original DSP listening modes.

You can also enjoy THX Surround EX (THX-certified THX speaker system recommended).

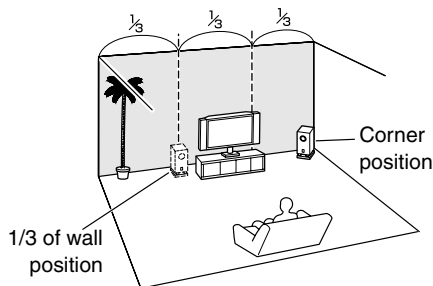
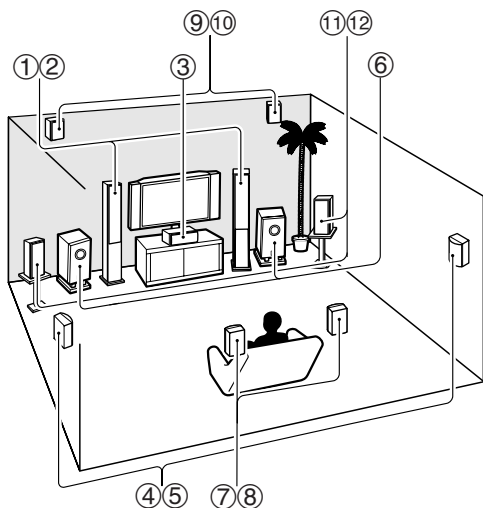

Tip

- To find the best position for your subwoofer, while playing a movie or some music with good bass, experiment by placing your subwoofer at various positions within the room, and choose the one that provides the most satisfying results.

① ② **Front speakers (Left and Right)**

These output the overall sound. Their role in a home theater is to provide a solid anchor for the sound image. They should be positioned facing the listener at about ear level, and equidistant from the TV. Angle them inward so as to create a triangle, with the listener at the apex.

③ **Center speaker**

This speaker enhances the front speakers, making sound movements distinct and providing a full sound image. In movies it's used mainly for dialog. Position it close to your TV facing forward at about ear level, or at the same height as the front speakers.

④ ⑤ **Surround speakers (Left and Right)**

These speakers are used for precise sound positioning and to add realistic ambience. Position them at the sides of the listener, or slightly behind, about 2 to 3 feet (60 to 100 cm) above ear level. Ideally they should be equidistant from the listener.

⑥ **Subwoofer(s)**

The subwoofer handles the bass sounds of the LFE (Low-Frequency Effects) channel. The volume and quality of the bass output from your subwoofer will depend on its position, the shape of your listening room, and your listening position. In general, a good bass sound can be obtained by installing the subwoofer in a front corner, or at one-third the width of the wall, as shown.

⑦ ⑧ **Surround back speakers (Left and Right)**

These speakers are necessary to enjoy Dolby Digital EX, DTS-ES Matrix, DTS-ES Discrete, THX Surround EX, etc. They enhance the realism of surround sound and improve sound localization behind the listener. Position them behind the listener about 2 to 3 feet (60 to 100 cm) above ear level.

⑨ ⑩ **Front high speakers (Left and Right)**

These speakers are necessary to enjoy Dolby Pro Logic IIz Height, and Audyssey DSX™. They significantly enhance the spatial experience. Position them at least 3.3 feet (100 cm) above the front speakers (preferably as high as possible) and at an angle slightly wider than the front speakers.

⑪ ⑫ **Front wide speakers (Left and Right)**

These speakers are necessary to enjoy Audyssey DSX. They significantly enhance the spatial experience. Position them well outside of the front speakers. See also <http://www.audyssey.com/technology/dsx.html> about optimum speaker placement for Audyssey DSX.

Connecting the AV Receiver

Connecting Your Speakers

About Speakers A and Speakers B

Installing Speakers A and Speakers B allows you to enjoy up to 7.2-channel surround-sound playback from each speaker configuration. Each configuration has its own pair of stereo front speakers and can use the same subwoofer, center, surround, and surround back speakers, as required. You could, for example, use Speakers A when watching a DVD movie with 7.2-channels surround sound and use Speakers B for serious music listening with a pair of stereo speakers (2-channels).

The speakers are configured by using the “Speaker Setup” (→ 50).

Front speakers A and front speakers B can be wired normally, bi-amped, or bridged, but A and B cannot be bi-amped or bridged at the same time. For example, if front speakers A are bridged, front speakers B can only be wired normally. Similarly, if front speakers B are bi-amped, front speakers A can only be wired normally. When bridging or bi-amping is used, the AV receiver can drive up to 5.2 speakers in the main room (→ 16 to 19).

The Speakers A and Speakers B configurations are selected by using **SP LAYOUT** on the remote controller. Only one configuration can be selected at a time.

The versatility offered by the Speakers A and Speakers B configurations means you can configure the AV receiver to suit your exact requirements and application. Two typical applications are shown below.

■ Speakers A: 7.2-channel playback Speakers B: Stereo playback

In this example, Speakers A provides 7.2-channel surround sound for enjoying DVD movies, while Speakers B is used for serious music listening with a pair of top-quality stereo speakers.

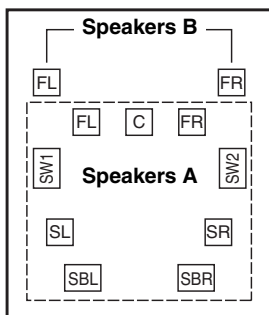

2-1. Speaker Settings	
Speaker Impedance	6ohms
Speakers Type(Front A)	Normal
Speakers Type(Front B)	Normal →
Powered Zone 2	Not Act
Powered Zone 3	Not Act
Front High + Front Wide	No

2-2. Speaker Configuration	
Subwoofer	Use → Speakers A
Front	Use
Center	Use
Surround	Use
Surround Back	Use

2-2. Speaker Configuration	
Subwoofer	Not Use → Speakers B
Front	Use
Center	Not Use
Surround	Not Use
Surround Back	Not Use

■ Speakers A: 5.2-channel playback Speakers B: 2.1-channel playback with bridged front speakers

In this example, Speakers A provides 5.2-channel surround sound for enjoying DVD movies, while Speakers B is bridged for use with a pair of high-power stereo speakers, the subwoofer is used with Speakers A and Speakers B.

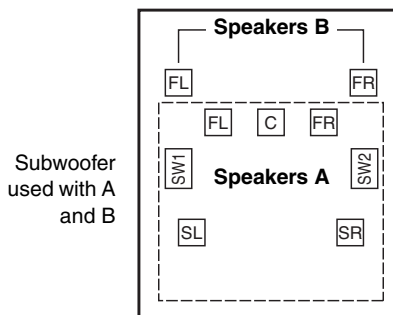

Subwoofer used with A and B

2-1. Speaker Settings	
Speaker Impedance	8ohms
Speakers Type(Front A)	Normal
Speakers Type(Front B)	BTL ←
Powered Zone 2	Not Act
Powered Zone 3	Not Act
Front High + Front Wide	No

2-2. Speaker Configuration	
Subwoofer	Use → Speakers A
Front	Use
Center	Use
Surround	Use
Surround Back	Not Use

2-2. Speaker Configuration	
Subwoofer	Use → Speakers B
Front	Use
Center	Not Use
Surround	Not Use
Surround Back	Not Use

Note

- You cannot set speaker impedance individually for Speakers A and Speakers B. In addition, when BTL is connected, it is fixed to 8 ohms.

Speaker Configuration

The following table indicates the channels you should use depending on the number of speakers that you have. For 9.2-channel surround-sound playback, you need 9 speakers and 2 powered subwoofers.

Number of speakers	2	3	4	5	6	7	7	7	8	8	9	9	9	10	11
Front speakers	✓	✓	✓	✓	✓	✓	✓	✓	✓	✓	✓	✓	✓	✓	✓
Center speaker		✓		✓	✓	✓	✓	✓	✓	✓	✓	✓	✓	✓	✓
Surround speakers			✓	✓	✓	✓	✓	✓	✓	✓	✓	✓	✓	✓	✓
Surround back speaker*1						✓			✓	✓				✓	
Surround back speakers							✓				✓	✓			✓
Front high speakers							✓		✓		✓		✓	✓	✓
Front wide speakers								✓	✓		✓	✓	✓	✓	✓

*1 If you're using only one surround back speaker, connect it to the **SURR BACK/ZONE 3 L** terminal.

No matter how many speakers you use, 2 powered subwoofers are recommended for a really powerful and solid bass.

To get the best from your surround sound system, you need to set the speaker settings. You can do this automatically (→ 32) or manually (→ 50).

Attaching the Speaker Cable Labels

The AV receiver's positive (+) speaker terminals are all red (the negative (-) speaker terminals are all black).

Speaker	Color
Front left, Front high left, Front wide left, Zone 2 left	White
Front right, Front high right, Front wide right, Zone 2 right	Red
Center	Green
Surround left	Blue
Surround right	Gray
Surround back left, Zone 3 left	Brown
Surround back right, Zone 3 right	Tan

The supplied speaker cable labels are also color-coded and you should attach them to the positive (+) side of each speaker cable in accordance with the table above. Then all you need to do is to match the color of each label to the corresponding speaker terminal.

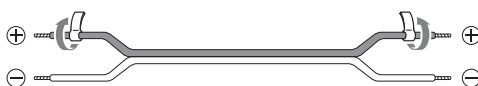

Speaker Connection Precautions

Read the following before connecting your speakers:

- You can connect speakers with an impedance of between 4 and 16 ohms. If the impedance of any of the connected speakers is 4 ohms or more, but less than 6 ohms, be sure to set the minimum speaker impedance to "4ohms" (→ 51). If you use speakers with a lower impedance, and use the amplifier at high volume levels for a long period of time, the built-in protection circuit may be activated.
- Disconnect the power cord from the wall outlet before making any connections.
- Read the instructions supplied with your speakers.
- Pay close attention to speaker wiring polarity. In other words, connect positive (+) terminals only to positive (+) terminals, and negative (-) terminals only to negative (-) terminals. If you get them the wrong way around, the sound will be out of phase and will sound unnatural.
- Unnecessarily long, or very thin speaker cables may affect the sound quality and should be avoided.
- If you use 4 or 5 speakers, connect each of the two surround speakers to the **SURR L/R** terminals. Do not connect them to the **SURR BACK/ZONE 3 L/R**, **FRONT WIDE/ZONE 2 L/R**, or **FRONT HIGH L/R** terminals.
- Be careful not to short the positive and negative wires. Doing so may damage the AV receiver.
- Make sure the metal core of the wire does not have contact with the AV receiver's rear panel. Doing so may damage the AV receiver.

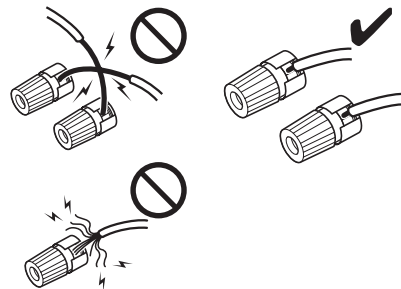

- Don't connect more than one cable to each speaker terminal. Doing so may damage the AV receiver.
- Don't connect one speaker to several terminals.

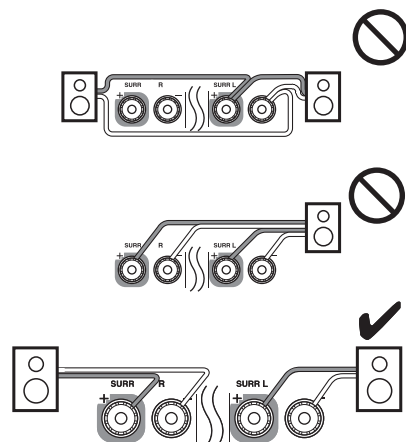

Connecting the Speaker Cables

Screw-type speaker terminals

Strip 1/2" to 5/8" (12 to 15 mm) of insulation from the ends of the speaker cables, and twist the bare wires tightly, as shown.

1/2" to 5/8" (12 to 15 mm)

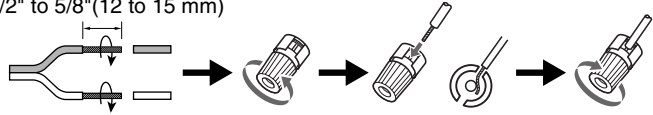

Using Banana Plugs (North American models)

- If you are using banana plugs, tighten the speaker terminal before inserting the banana plug.
- Do not insert the speaker code directly into the center hole of the speaker terminal.

■ 9.2-channel Playback with Speakers A

The following illustration shows which speaker should be connected to each pair of terminals. If you're using only one surround back speaker, connect it to the **SURR BACK/ZONE 3 L** terminal.

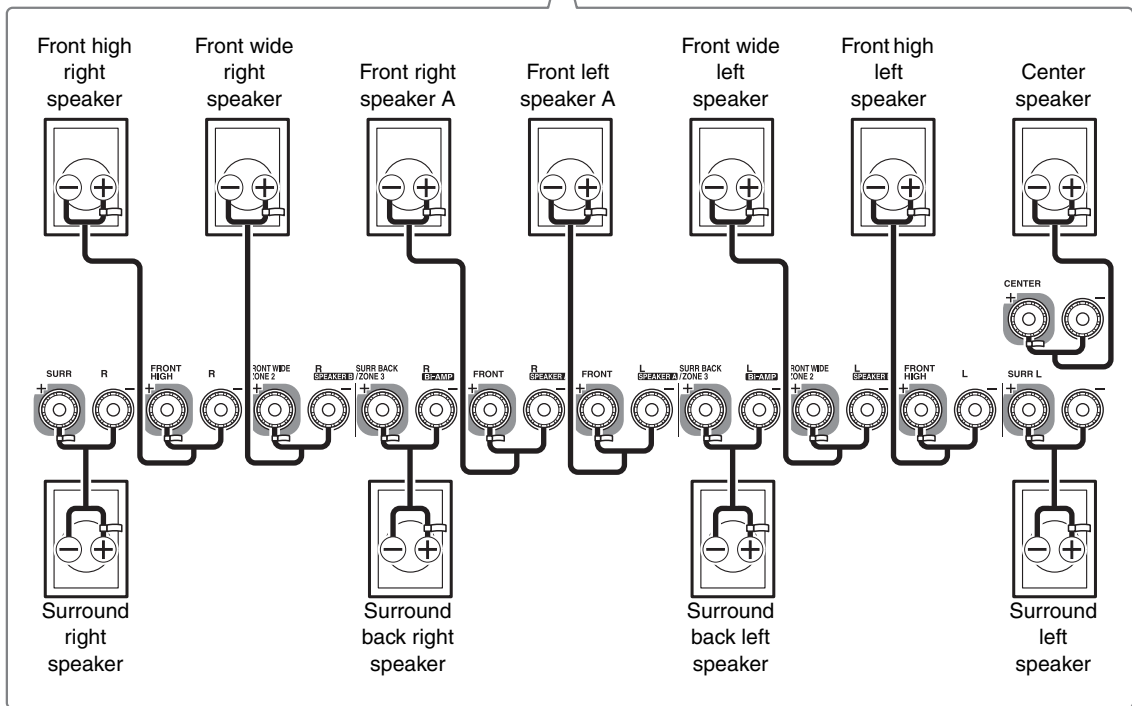
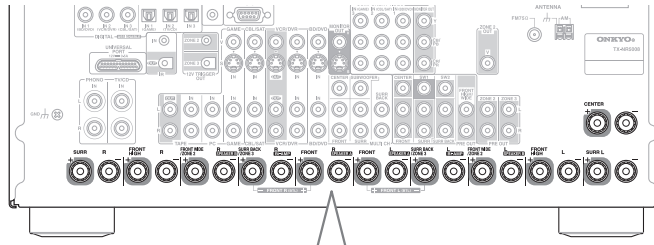

Note

- In order to use the front high and front wide speakers simultaneously, you need to make a connection different from the one illustrated above. For details, refer to the connection diagram shown in "Speaker Settings" of the on-screen setup menu (displayed on a TV connected with HDMI).

■ 7.2-channel Playback with Speakers A or Speakers B

The following illustration shows which speaker should be connected to each pair of terminals for up to 7.2-channel playback with Speakers A or Speakers B. If you're using only one surround back speaker, connect it to the **SURR BACK/ZONE 3 L** terminal.

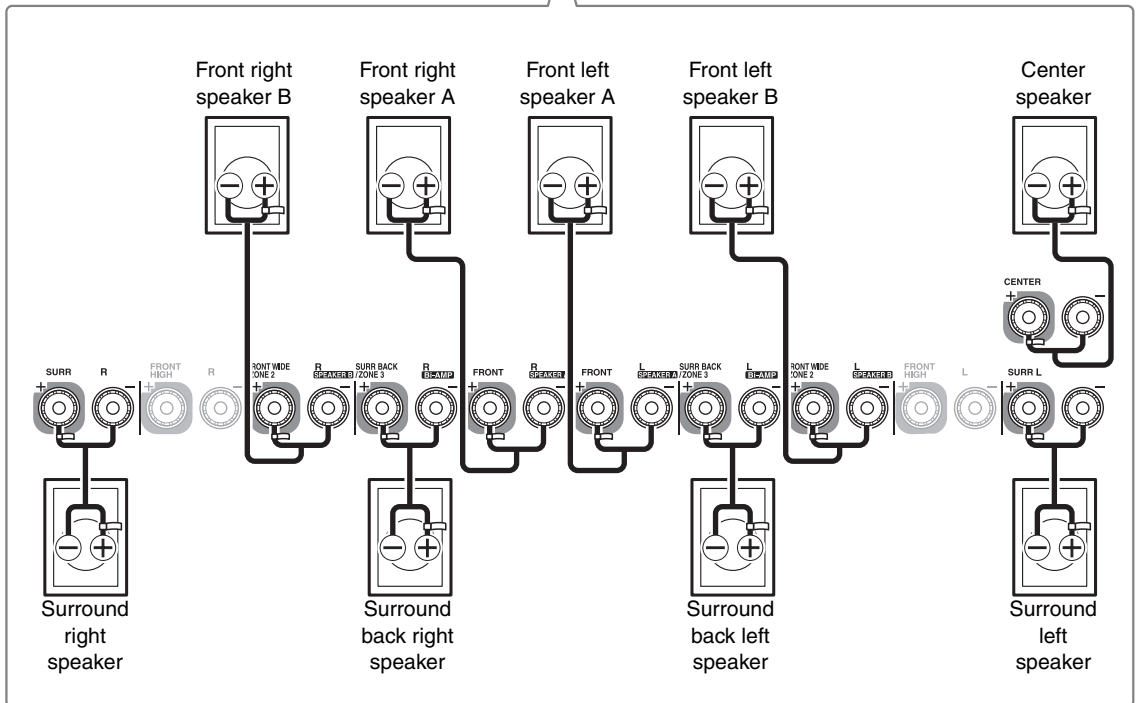
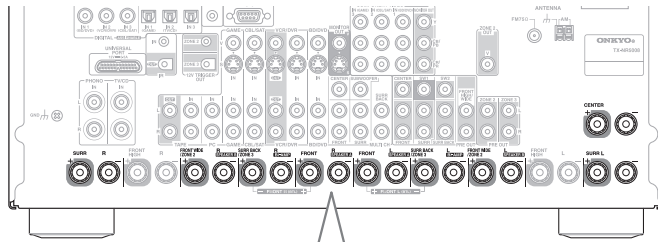

Note

- When Speakers A is selected as the main front speakers, connect the front left speaker to **FRONT L**, front right speaker to **FRONT R**. When Speakers B is selected as the main front speakers, connect the front left speaker to **FRONT WIDE/ZONE 2 L**, front right speaker to **FRONT WIDE/ZONE 2 R**.
- The speakers are configured by using the “Speaker Setup” (→ 50).
- You can choose which of the speakers you want to use with the Speakers A or Speakers B configuration (→ 52).
- When you use the Speakers B configuration, front high speakers cannot be used.

Using Dipole Speakers

You can use dipole speakers for the surround and surround back speakers. Dipole speakers output the same sound in two directions.

Dipole speakers typically have an arrow printed on them to indicate how they should be positioned. The surround dipole speakers should be positioned so that their arrows point toward the TV/screen, while the surround back dipole speakers should be positioned so that their arrows point toward each other, as shown.

- ①② Front speakers
- ③ Center speaker
- ④⑤ Surround speakers
- ⑥ Subwoofer(s)
- ⑦⑧ Surround back speakers
- ⑨⑩ Front high speakers
- ⑪⑫ Front wide speakers

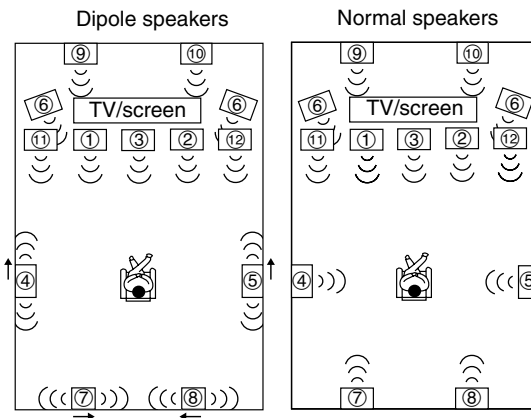

Connecting the Powered Subwoofers

Using a suitable cable, connect the AV receiver's **SW1, SW2 PRE OUT** to an input on your powered subwoofer, as shown. If your subwoofer is unpowered and you're using an external amplifier, connect the **SW1, SW2 PRE OUT** to an input on the amp.

You can connect the powered subwoofer with each jacks respectively. Level and distance can be set individually for each output. If you use one subwoofer, connect it to **SW1 PRE OUT**.

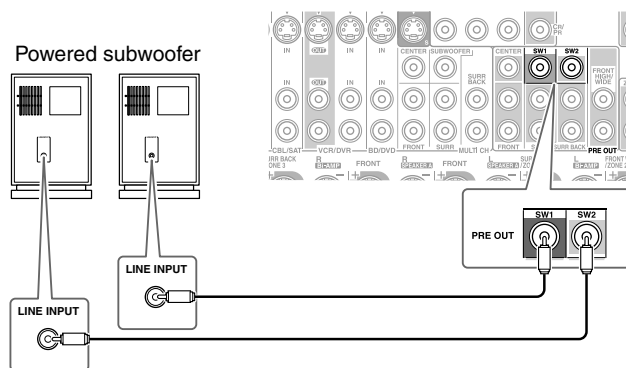

Bi-amping the Front Speakers A

The **FRONT L/R** and **SURR BACK/ZONE 3 L/R** terminal posts can be used with front speakers and surround back speakers respectively, or bi-amped to provide separate tweeter and woofer feeds for a pair of front speakers A that support bi-amping, providing improved bass and treble performance.

- When bi-amping is used, surround back speakers cannot be used.
- For bi-amping, the **FRONT L/R** terminal posts connect to the front speakers' woofer terminals. And the **SURR BACK/ZONE 3 L/R** terminal posts connect to the front speakers' tweeter terminals.
- Once you've completed the bi-amping connections shown below and turned on the AV receiver, you must set the "**Speakers Type(Front A)**" setting to "**Bi-Amp**" to enable biamping (→ 51).
- When front speakers A are biamped, front speakers B must be wired normally or not used.

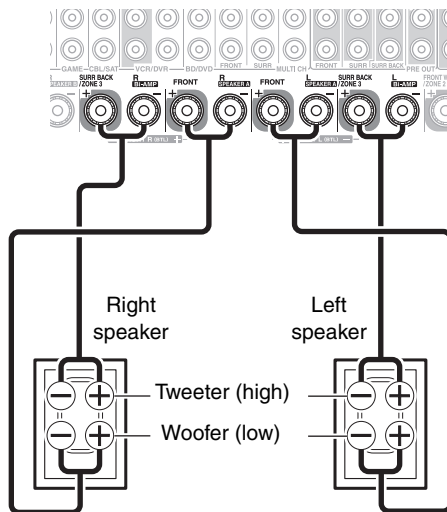

Important:

- When making the bi-amping connections, be sure to remove the jumper bars that link the speakers' tweeter (high) and woofer (low) terminals.
- Bi-amping can be used only with speakers that support bi-amping. Refer to your speaker manual.

Bridging the Front Speakers A

The **FRONT L/R** and **SURR BACK/ZONE 3 L/R** terminal posts can be used with front speakers and surround back speakers respectively, or bridged together to provide almost double the output power for the front speakers A.

- When bridging is used, surround back speakers cannot be used.
- For bridging, the positive (+) **FRONT L/R** and **SURR BACK/ZONE 3 L/R** terminal posts are used, but the negative (-) **FRONT L/R** and **SURR BACK/ZONE 3 L/R** terminals are not.
- Once you've completed the bridging connections shown below and turned on the AV receiver, you must set the "**Speakers Type(Front A)**" setting to "**BTL**" to enable bridging (→ 51).
- When front speakers A are bridged, front speakers B must be wired normally or not used.

Note

- Use only front speakers with an impedance of 8 ohms or higher for bridging. Failure to do so may seriously damage the AV receiver.
- When using bridging, make sure that your front speakers can handle the additional power.

Bi-amping the Front Speakers B

The **FRONT WIDE/ZONE 2 L/R** and **SURR BACK/ZONE 3 L/R** terminal posts can be used with front wide speakers and surround back speakers respectively, or bi-amped to provide separate tweeter and woofer feeds for a pair of front speakers B that support bi-amping, providing improved bass and treble performance.

- When bi-amping is used, surround back speakers cannot be used.
- For bi-amping, the **FRONT WIDE/ZONE 2 L/R** terminal posts connect to the front speakers' woofer terminals. And the **SURR BACK/ZONE 3 L/R** terminal posts connect to the front speakers' tweeter terminals.
- Once you've completed the bi-amping connections shown below and turned on the AV receiver, you must set the "**Speakers Type(Front B)**" setting to "**Bi-Amp**" to enable biamping (→ 51).
- When front speakers B are biamped, front speakers A must be wired normally.

Important:

- When making the bi-amping connections, be sure to remove the jumper bars that link the speaker's tweeter (high) and woofer (low) terminals.
- Bi-amping can only be used with speakers that support bi-amping. Refer to your speaker manual.

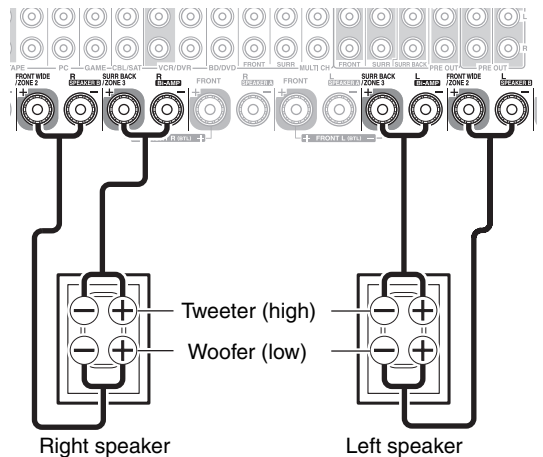
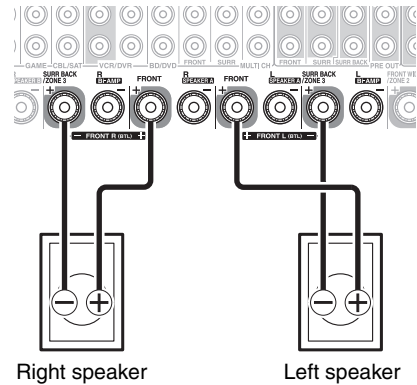

Bridging the Front Speakers B

The **FRONT WIDE/ZONE 2 L/R** and **SURR BACK/ZONE 3 L/R** terminal posts can be used with front wide speakers and surround back speakers respectively, or bridged together to provide almost double the output power for the front speakers B.

- When bridging is used, surround back speakers cannot be used.
- For bridging, the positive (+) **FRONT WIDE/ZONE 2 L/R** and **SURR BACK/ZONE 3 L/R** terminal posts are used, but the negative (–) **FRONT WIDE/ZONE 2 L/R** and **SURR BACK/ZONE 3 L/R** terminals are not.
- Once you've completed the bridging connections shown below and turned on the AV receiver, you must set the “**Speakers Type(Front B)**” setting to “**BTL**” to enable bridging (→ 51).
- When front speakers B are bridged, front speakers A must be wired normally.

Note

- Use only front speakers with an impedance of 8 ohms or higher for bridging. Failure to do so may seriously damage the AV receiver.
- When using bridging, make sure that your front speakers can handle the additional power.

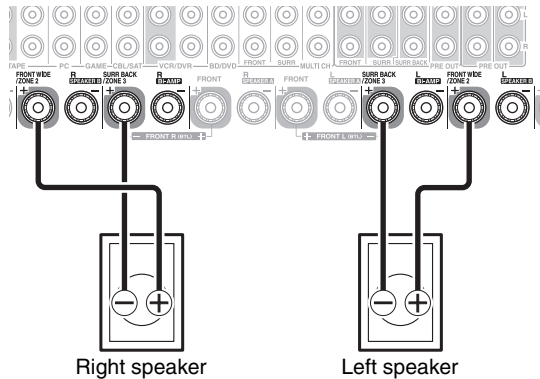

Connecting a Power Amplifier

If you want to use a more powerful power amplifier and use the AV receiver as a preamp, connect it to the **PRE OUT** jacks, and connect all speakers to the power amplifier.

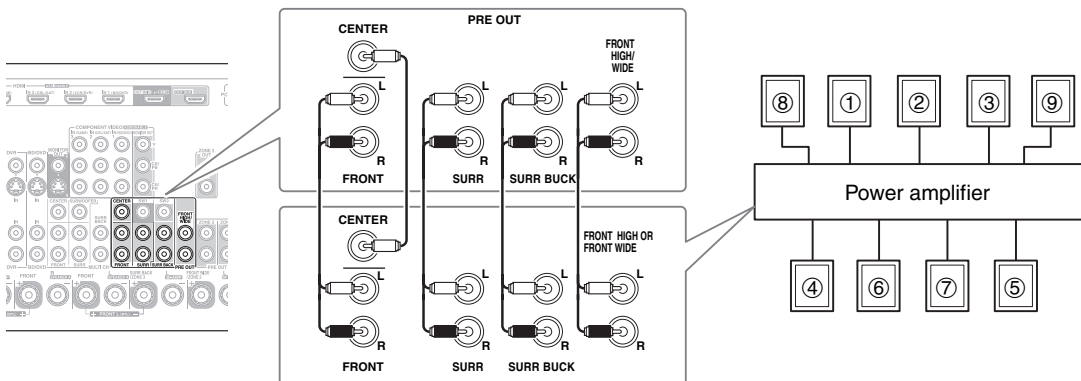

Note

- Specify “**None**” for the channel that you don't want to output (→ 52).

- ① Front left speaker
- ② Center speaker
- ③ Front right speaker
- ④ Surround left speaker
- ⑤ Surround right speaker
- ⑥ Surround back left speaker
- ⑦ Surround back right speaker
- ⑧ Front high/Front wide left speaker
- ⑨ Front high/Front wide right speaker

Connected image with AV components

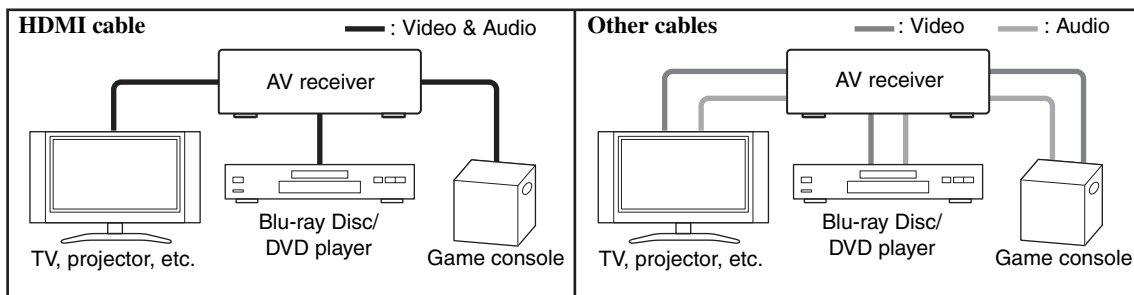

- Before making any AV connections, read the manuals supplied with your AV components.
- Don't connect the power cord until you've completed and double-checked all AV connections.
- Push plugs in all the way to make good connections (loose connections can cause noise or malfunctions).
- To prevent interference, keep audio and video cables away from power cords and speaker cables.

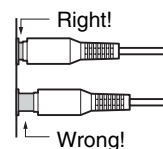

AV Cables and Jacks

Signal	Cable	Jack	Description
Video and Audio	HDMI	HDMI	HDMI connections can carry digital video and audio.
Video	Component video	 Y Green PB/CB Blue PR/CR Red	Component video separates the luminance (Y) and color difference signals (PB/CB, PR/CR), providing the best picture quality (some TV manufacturers label their component video sockets slightly differently).
	Analog RGB		This is a conventional analog interface to connect a PC and a display device (also called D-Sub or D-subminiature).
	S-Video	S	S-Video separates the luminance and color signals and provides better picture quality than composite video.
	Composite video	V Yellow	Composite video is commonly used on TVs, VCRs, and other video equipment.
Audio	Optical digital audio	OPTICAL	Optical digital connections allow you to enjoy digital sound such as PCM*, Dolby Digital or DTS. The audio quality is the same as coaxial.
	Coaxial digital audio	COAXIAL Orange	Coaxial digital connections allow you to enjoy digital sound such as PCM*, Dolby Digital or DTS. The audio quality is the same as optical.
	Analog audio (RCA)	 L White R Red	Analog audio connections (RCA) carry analog audio.
	Multichannel analog audio (RCA)	 CENTER (SUBWOOFER) SUPER BACK FRONT SUPER FRONT MULTI CH	This cable carries multichannel analog audio and is typically used to connect DVD players with a 7.1-channel analog audio output. Several standard analog audio cables can be used instead of a multichannel cable.

* Available sampling rate for PCM input signal is 32/44.1/48/88.2/96 kHz. Even 176.4/192 kHz is effective in case of the HDMI connection.

Note

- The AV receiver does not support SCART plugs.
- The AV receiver's optical digital jacks have shutter-type covers that open when an optical plug is inserted and close when it's removed. Push plugs in all the way.

Caution

- To prevent shutter damage, hold the optical plug straight when inserting and removing.

Connecting Your Components with HDMI

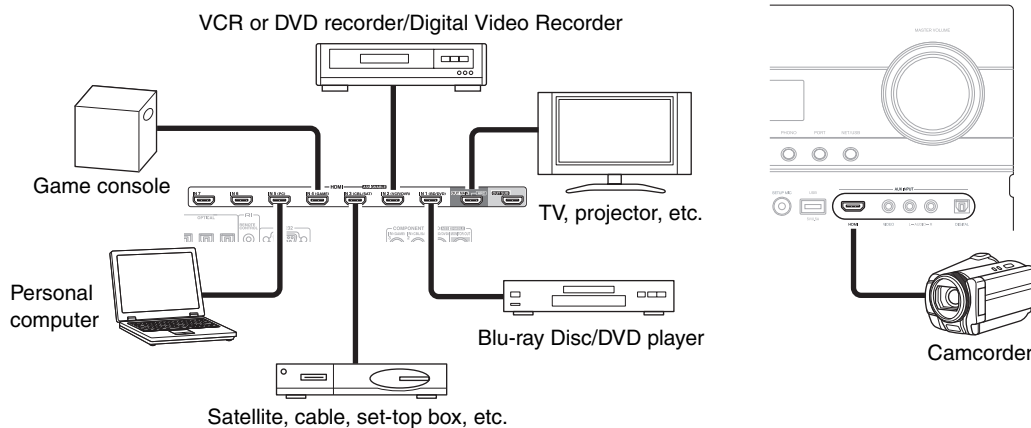

Connect your components to the appropriate jacks. The default input assignments are shown below.

✓: Assignment can be changed (→ 48 to 49).

Jack	Signal	Components	Assignable	
Input	HDMI IN 1	Audio/Video	Blu-ray Disc/DVD player	✓
	HDMI IN 2		VCR or DVD recorder/Digital Video Recorder	✓
	HDMI IN 3		Satellite, cable, set-top box, etc.	✓
	HDMI IN 4		Game console	✓
	HDMI IN 5		Personal computer	✓
	HDMI IN 6		Other components	✓
	HDMI IN 7		Other components	✓
	AUX INPUT HDMI		Camcorder	
Output	HDMI OUT MAIN		TV	
	HDMI OUT SUB		Projector, etc.	

Refer to “About HDMI” (→ 109) and “Using an RIHD-compatible TV, Player, or Recorder” (→ 110).

■ Audio return channel (ARC) function

Audio return channel (ARC) function enables an HDMI capable TV to send the audio stream to the **HDMI OUT MAIN** of the AV receiver. To use this function, you must select the **TV/CD** input selector.

- To use ARC function, you must select the **TV/CD** input selector, your TV must support ARC function and “**HDMI Control(RIHD)**” is set to “**On**” (→ 65).

Tip

- To listen to audio received by the **HDMI IN** jacks through your TV’s speakers:
 - Set the “**TV Control**” setting to “**On**” (→ 65) for an **RIHD**-compatible TV.
 - Set the “**Audio TV Out**” setting to “**On**” (→ 64) when the TV is not compatible with **RIHD** or the “**TV Control**” setting to “**Off**”.
 - Set your Blu-ray Disc/DVD player’s HDMI audio output setting to PCM.
 - To listen to TV audio through the AV receiver, see “Connecting Your Components” (→ 22).

Note

- When listening to an HDMI component through the AV receiver, set the HDMI component so that its video can be seen on the TV screen (on the TV, select the input of the HDMI component connected to the AV receiver). If the TV power is off or the TV is set to another input source, this may result in no sound from the AV receiver or the sound may be cut off.
- When the “**Audio TV Out**” setting is set to “**On**” (→ 64) to hear from your TV’s speakers, by controlling the AV receiver’s volume, the sound will be output from the AV receiver’s speakers, too. When the “**TV Control**” setting is set to “**On**” (→ 65) to hear from speakers of **RIHD**-compatible TV, by controlling the AV receiver’s volume, the AV receiver’s speakers will produce sound while the TV’s speakers are muted. To stop the AV receiver’s speakers producing sound, change the settings, change your TV’s settings, or turn down the AV receiver’s volume.

Connecting Your Components

Front

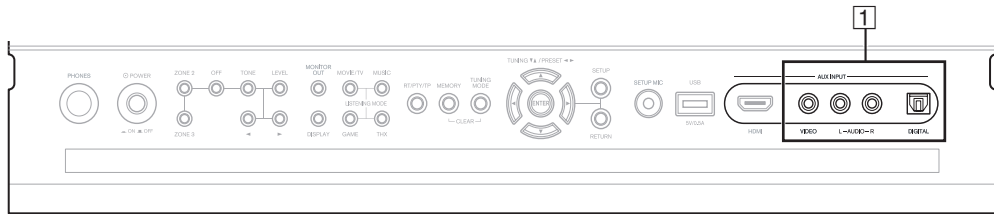

Rear

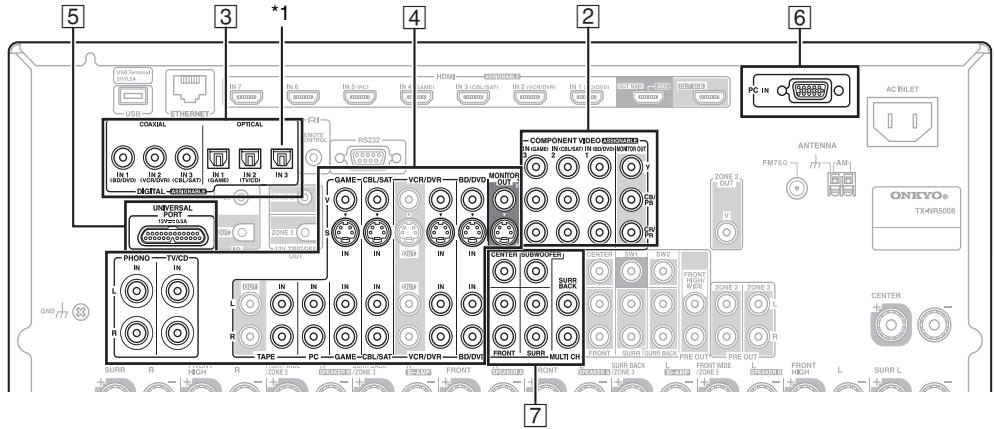

Connect your components to the appropriate jacks. The default input assignments are shown below.

✓: Assignment can be changed (→ 49, 50).

No.	Jack	Signal	Components	Assignable
1	AUX INPUT	VIDEO	Composite video	Camcorder, etc
		AUDIO L/R	Analog audio	
		DIGITAL	Digital audio	
2	COMPONENT VIDEO	IN 1 (BD/DVD)	Component video	Blu-ray Disc/DVD player ✓
		IN 2 (CBL/SAT)		Satellite, cable, set-top box, etc. ✓
		IN 3 (GAME)		Game console ✓
		MONITOR OUT		TV, projector, etc.
3	COAXIAL	IN 1 (BD/DVD)	Digital audio	Blu-ray Disc/DVD player ✓
		IN 2 (VCR/DVR)		VCR or DVD recorder/digital video recorder ✓
		IN 3 (CBL/SAT)		Satellite, cable, set-top box, etc. ✓
	OPTICAL	IN 1 (GAME)		Game console ✓
		IN 2 (TV/CD)		TV, CD player ✓
		IN 3*1		Other components ✓
4	MONITOR OUT	Composite video and S-Video	TV, projector, etc.	
	BD/DVD IN	Analog audio, composite video and S-Video	Blu-ray Disc/DVD player	
	VCR/DVR IN		VCR or DVD recorder/digital video recorder	
	CBL/SAT IN		Satellite, cable, set-top box, etc.	
	GAME IN		Game console	
	PC IN	Analog audio	Personal computer	
	TAPE IN		Cassette tape deck, MD, CD-R	
	TV/CD IN		TV, CD player, Turntable*2	
PHONO IN		Turntable*2		
5	UNIVERSAL PORT	Analog audio/video	Universal port optional dock (UP-A1 etc.)	
6	PC IN*3	Analog RGB	Personal computer	
7	Multichannel input*4	Analog audio	DVD player, DVD-Audio or Super Audio CD-capable player, or an MPEG decoder	✓

Note

*1 TX-NR5008

*2 Connect a turntable (MM) that has built-in a phono preamp to **TV/CD IN** or connect it to **PHONO IN** with the phono preamp turned off. If your turntable (MM) doesn't have a phono preamp, connect to **PHONO IN**. If your turntable has a moving coil (MC) type cartridge, you'll need a commercially available MC head amp or MC transformer to connect to **PHONO IN**. See your turntable's manual for details.

If your turntable has a ground wire, connect it to the AV receiver's **GND** screw. With some turntables, connecting the ground wire may produce an audible hum. If this happens, disconnect it.

*3 When you connect your personal computer to **PC IN** and select **PC** input selector, video of the personal computer is output from HDMI output. However, because the AV receiver selects the video input in the order of HDMI > component > analog RGB, if you have assigned **HDMI IN** to the **PC** input selector, the AV receiver will output signals from **HDMI IN** in priority to **PC IN**.

*4 Before using the multichannel input, you must assign it to an input selector. See "Analog Audio Input" (→ 50). To select the multichannel input, see "Audio Selector" (→ 68). To adjust the subwoofer sensitivity for the multichannel input, see "Subwoofer Input Sensitivity" (→ 50).

• The AV receiver can output audio and video signals from the **AUX INPUT** jacks to the **VCR/DVR OUT** jacks.

• With connection [4], you can listen and record audio from the external components while you are in Zone 2/3. You can listen and record audio from the external components in the main room; you can listen to the audio in Zone 2/3 as well.

• With connection [3], you can enjoy Dolby Digital and DTS. (To record or listen in Zone 2/3 as well, use [3] and [4].)

How to record the video

With the connections described above, you cannot record the video through the AV receiver. To make a connection for video recording (→ 38).

Connecting Onkyo RI Components

Step 1:

Make sure that each Onkyo component is connected with an analog audio cable (connection [4] in the hookup examples) (→ 22).

Step 2:

Make the **RI** connection (see illustration below).

Step 3:

If you're using an RI Dock, or cassette tape deck, change the Input Display (→ 31).

With **RI** (Remote Interactive), you can use the following special functions:

Auto Power On

When you start playback on a component connected via **RI** while the AV receiver is on Standby, the AV receiver will automatically turn on and select that component as the input source.

Direct Change

When playback is started on a component connected via **RI**, the AV receiver automatically selects that component as the input source.

Remote Control

You can use the AV receiver's remote controller to control your other **RI**-capable Onkyo components, pointing the remote controller at the AV receiver's remote control sensor instead of the component. You must enter the appropriate remote control code first (→ 93).

Note

- Use only **RI** cables for **RI** connections. **RI** cables are supplied with Onkyo players (DVD, CD, etc.).
- Some components have two **RI** jacks. You can connect either one to the AV receiver. The other jack is for connecting additional **RI**-capable components.
- Connect only Onkyo components to **RI** jacks. Connecting other manufacturer's components may cause a malfunction.
- Some components may not support all **RI** functions. Refer to the manuals supplied with your other Onkyo components.
- While Zone 2 or Zone 3 is on, the Auto Power On and Direct Change **RI** functions do not work.
- Do not use **RI** connections if you use HDMI Control (RIHD) (→ 65).

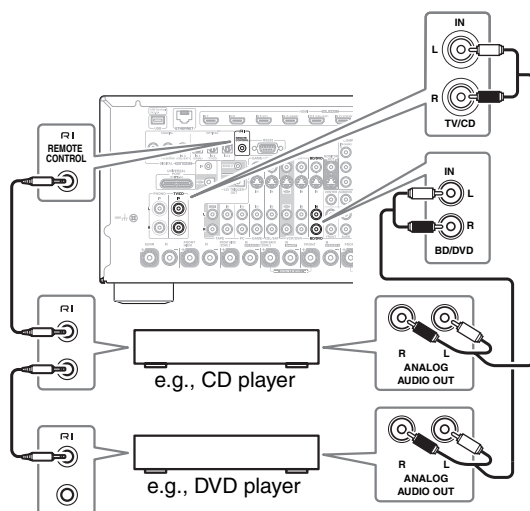

Connecting Antenna

This section explains how to connect the supplied indoor FM antenna and AM loop antenna.

The AV receiver won't pick up any radio signals without any antenna connected, so you must connect the antenna to use the tuner.

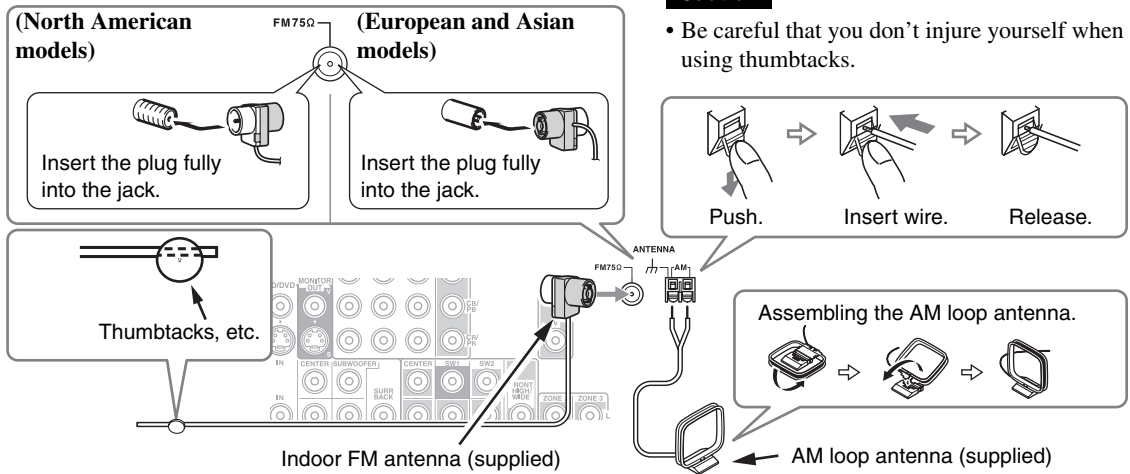

Note

- Once your AV receiver is ready for use, you'll need to tune into a radio station and position the antenna to achieve the best possible reception.
- Keep the AM loop antenna as far away as possible from your AV receiver, TV, speaker cables, and power cords.

Tip

- If you cannot achieve good reception with the supplied indoor FM antenna, try a commercially available outdoor FM antenna instead.
- If you cannot achieve good reception with the supplied indoor AM loop antenna, try using it with a commercially available outdoor AM antenna.

Connecting the Power Cord

Note

- **Before connecting the power cord, connect all of your speakers and AV components.**
- Turning on the AV receiver may cause a momentary power surge that might interfere with other electrical equipment on the same circuit. If this is a problem, plug the AV receiver into a different branch circuit.
- Do not use a power cord other than the one supplied with the AV receiver. The supplied power cord is designed exclusively for use with the AV receiver and should not be used with any other equipment.
- Never disconnect the power cord from the AV receiver while the other end is still plugged into a wall outlet. Doing so may cause an electric shock. Always disconnect the power cord from the wall outlet first, and then the AV receiver.

Step 1:

Connect the supplied power cord to the AV receiver's **AC INLET**.

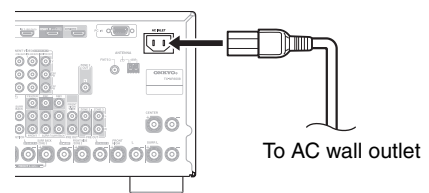

Step 2:

Plug the power cord into an AC wall outlet.

Which Connections Should I Use?

The AV receiver supports several connection formats for compatibility with a wide range of AV equipment. The format you choose will depend on the formats supported by your components. Use the following sections as a guide.

Video Connection Formats

Video component can be connected by using any one of the following video connection formats: composite video, S-Video, PC IN (Analog RGB), component video or HDMI, the latter offering the best picture quality.

The AV receiver can upconvert and downconvert between video formats, depending on the “**Monitor Out**” setting (→ 47), which generally determines whether video signals are upconverted for the component video output or the HDMI output.

For optimal video performance, THX recommends that video signals pass through the system without upconversion (e.g., component video input through to component video output).

To by-pass video upconversion in the AV receiver, simultaneously press the VCR/DVR and RETURN on the AV receiver. While continuing to hold down the VCR/DVR, press RETURN to toggle until “Skip” appears on the display. Release both buttons.

To use the video upconversion in the AV receiver, repeat the above process until “Use” appears on the display and release the buttons.

■ “Monitor Out” setting set to “HDMI Main” or “HDMI Sub”

Video input signals flow through the AV receiver as shown, with composite video, S-Video, PC IN (Analog RGB) and component video sources all being upconverted for the HDMI output. **Use these settings if you connect the AV receiver’s HDMI OUT MAIN or HDMI OUT SUB, respectively, to your TV.**

The composite video, S-Video and component video outputs pass through their respective input signals as they are.

Note

- If not connected to the same output you have selected in the “**Monitor Out**” setting, the “**Monitor Out**” setting will be automatically switched to “**Analog**” (→ 26). In this case, the setting of the output resolution will be that for HDMI output (→ 47). Moreover, it will be switched to “**1080i**” when “**1080p**” or “**1080p/24**” is selected, and to “**Through**” when “**Auto**” is selected.

■ “Monitor Out” setting set to “Both”, “Both(Main)” or “Both(Sub)”

Video input signals flow through the AV receiver as shown, with composite video, S-Video, PC IN (Analog RGB) and component video sources all being upconverted for both HDMI outputs. **Use these settings if you connect the AV receiver’s HDMI OUT MAIN and HDMI OUT SUB to your TVs.**

The composite video, S-Video and component video outputs pass through their respective input signals as they are.

- ▶ **Both:** Video signals are output from both HDMI outputs at the resolution supported by both TVs. You cannot select “**Resolution**” setting.
- ▶ **Both(Main):** Video signals are output from both HDMI outputs but **HDMI OUT MAIN** will become a priority; depending on the resolution, video signals may not be output from **HDMI OUT SUB**.
- ▶ **Both(Sub):** Video signals are output from both HDMI outputs but **HDMI OUT SUB** will become a priority; depending on the resolution, video signals may not be output from **HDMI OUT MAIN**.

Note

- The “**Monitor Out**” setting will be automatically switched to “**Analog**” (→ 47) if not connected to both outputs when “**Both**” is selected or if not connected to a priority output when “**Both(Main)**” or “**Both(Sub)**” is selected.

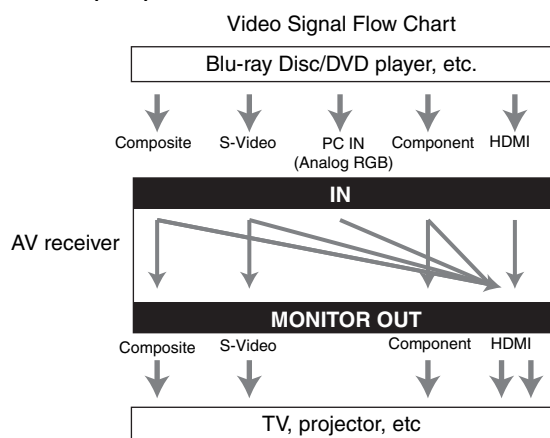
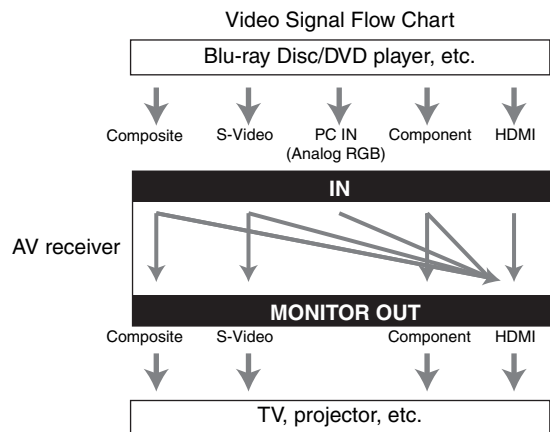

■ “Monitor Out” setting set to “Analog”

Video input signals flow through the AV receiver as shown, with composite video, S-Video and PC IN (Analog RGB) sources being upconverted for the component video output. **Use this setting if you connect the AV receiver’s COMPONENT VIDEO MONITOR OUT to your TV.**

Composite video is upconverted to S-Video and S-Video is downconverted to composite video. Note that these conversions only apply to the **MONITOR OUT V** and **S** outputs, not the **VCR/DVR OUT V** and **S** outputs.

The composite video, S-Video and component video outputs pass through their respective input signals as they are. This signal flow also applies when the “**Resolution**” setting is set to “**Through**” (→ 48).

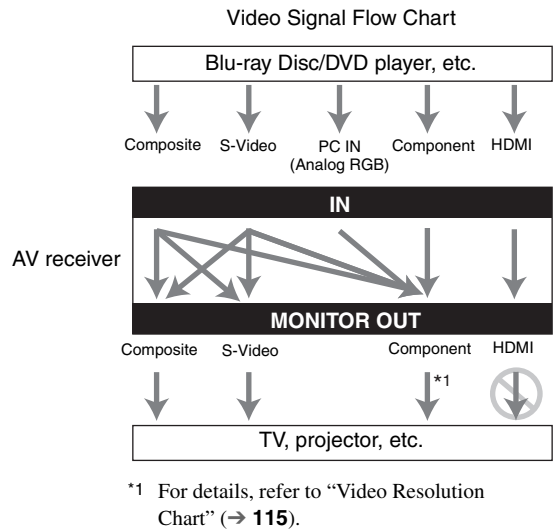

Video Signal Flow and the Resolution Setting

When the “**Monitor Out**” setting is set to “**Analog**” (→ 47), if the “**Resolution**” setting is set to anything other than “**Through**” (→ 48), the video signal flow will be as shown here, with composite video, PC IN (Analog RGB) and S-Video sources being upconverted for the component video output.

The composite video, S-Video and component video outputs pass through their respective analog input signals as they are. HDMI input signals are not output.

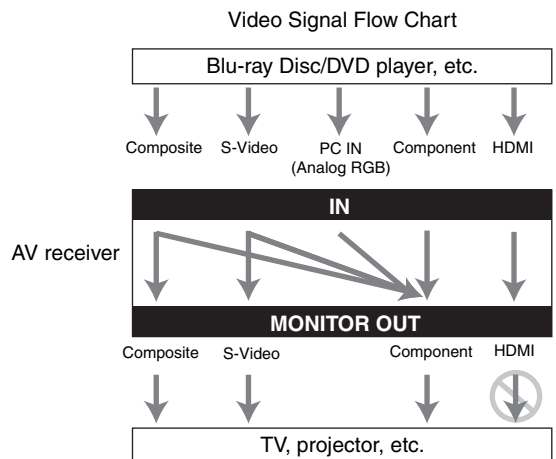

Audio Connection Formats

Audio component can be connected by using any of the following audio connection formats: analog, analog multi-channel, optical, coaxial, or HDMI.

When choosing a connection format, bear in mind that the AV receiver does not convert digital input signals for analog line outputs and vice versa. For example, audio signals connected to an optical or coaxial digital input are not output by the analog **VCR/DVR OUT**.

If signals are present at more than one input, the inputs will be selected automatically in the following order of priority: HDMI, digital, analog.

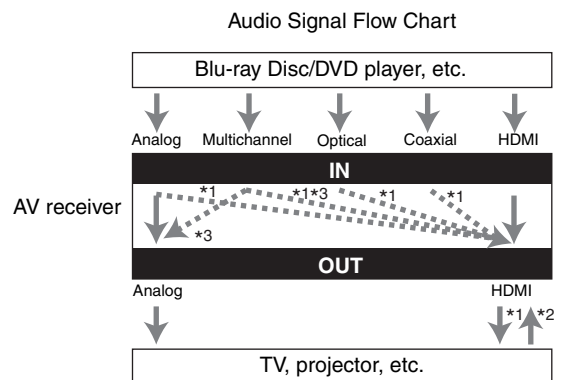

*1 Depends on the “**Audio TV Out**” setting (→ 64).

*2 This setting is available, when “**Audio Return Channel**” setting is set to “**Auto**” (→ 65), you must select the **TV/CD** input selector and your TV must support ARC function.

*3 Only the front L/R channels are output.

Turning On/Off the AV Receiver

(North American models)

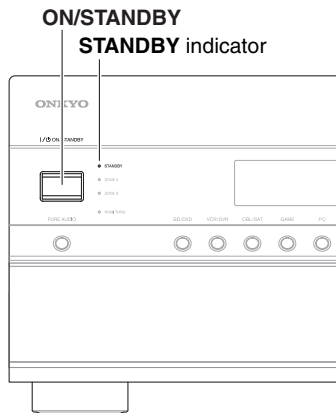

(European and Asian models)

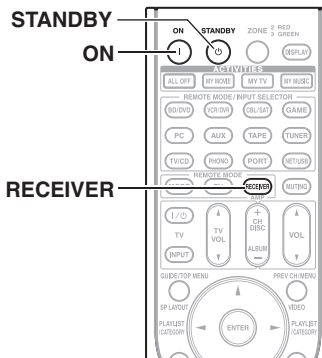
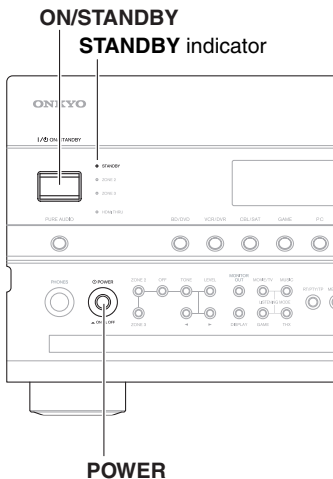

Turning On

1 (European and Asian models)

Set **POWER** to the **ON** position (⬆) on the front panel.

The AV receiver enters Standby mode, and the **STANDBY** indicator comes on.

2 Press **ON/STANDBY** on the front panel.

or

Press **RECEIVER** followed by **ON** on the remote controller.

The AV receiver comes on, the display lights, and the **STANDBY** indicator goes off.

Pressing the remote controller's **ON** again will turn on any components connected via **RI**.

Turning Off

Press **ON/STANDBY** on the front panel.

or

Press **RECEIVER** followed by **STANDBY** on the remote controller.

The AV receiver will enter Standby mode. To prevent any loud surprises when you turn on the AV receiver, always turn down the volume before you turn it off.

(European and Asian models)

To completely shut down the AV receiver, set **POWER** to the **OFF** position (⬆).

Basic Operations

This manual describes the procedure using the remote controller unless otherwise specified.

Selecting the Language Used for the Onscreen Setup Menus

You can determine the language used for the onscreen setup menus. See “Language” in the “OSD Setup” (→ 63).

Playing the Connected Component

■ Operating on the AV receiver

1 Use the input selector buttons to select the input source.

2 Start playback on the source component.

See also:

- “Controlling Other Components” (→ 91)
- “Controlling iPod” (→ 86)
- “Listening to the Radio” (→ 35)

3 To adjust the volume, use the **MASTER VOLUME** control.

4 Select a listening mode and enjoy!

See also:

- “Using the Listening Modes” (→ 39)
- “Audyssey” (→ 57)

■ Operating with the remote controller

1 Press **RECEIVER** followed by **INPUT SELECTOR**.

2 Start playback on the source component.

See also:

- “Controlling Other Components” (→ 91)
- “Controlling iPod” (→ 86)
- “Listening to the Radio” (→ 35)

3 To adjust the volume, use **VOL ▲/▼**.

4 Select a listening mode and enjoy!

See also:

- “Using the Listening Modes” (→ 39)
- “Audyssey” (→ 57)

Displaying Source Information

You can display various information about the current input source as follows. (Components connected to the **UNIVERSAL PORT** jack are excluded.)

Press **RECEIVER** followed by **DISPLAY** repeatedly to cycle through the available information.

Tip

- Alternatively, you can use the AV receiver’s **DISPLAY**.

The following information can typically be displayed.

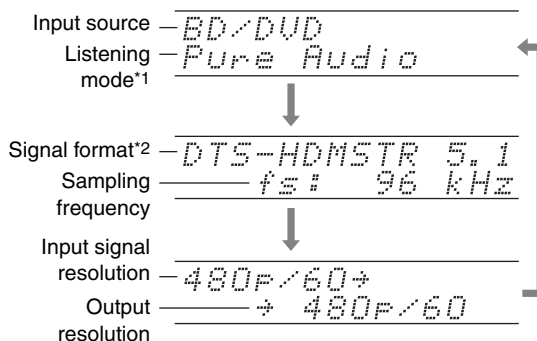

*1 The input source is displayed with the default name even when you have entered a custom name in “Name Edit” (→ 59).

*2 If the input signal is analog, no format information is displayed. If the input signal is PCM, the sampling frequency is displayed. If the input signal is digital but not PCM, the signal format and the number of channels is displayed. For some digital input signals, including multichannel PCM, the signal format, number of channels, and sampling frequency is displayed.

Information is displayed for about three seconds, then the previously displayed information reappears.

Setting the Display Brightness

You can adjust the brightness of the AV receiver’s display.

Press **RECEIVER** followed by **DIMMER** repeatedly to select:

- Normal + **MASTER VOLUME** indicator lights.
- Normal + **MASTER VOLUME** indicator goes off.
- Dim + **MASTER VOLUME** indicator goes off.
- Dimmer + **MASTER VOLUME** indicator goes off.

Tip

- (North American models) Alternatively, you can use the AV receiver’s **DIMMER**.

Muting the AV Receiver

You can temporarily mute the output of the AV receiver.

Press **RECEIVER** followed by **MUTING**.

The output is muted and the **MUTING** indicator flashes on the display.

Tip

- To unmute, press **MUTING** again or adjust the volume.
- The Mute function is cancelled when the AV receiver is set to Standby.

Using the Sleep Timer

With the sleep timer, you can set the AV receiver to turn off automatically after a specified period.

Press **RECEIVER** followed by **SLEEP** repeatedly to select the required sleep time.

The sleep time can be set from 90 to 10 minutes in 10 minute steps.

The **SLEEP** indicator lights on the display when the sleep timer has been set. The specified sleep time appears on the display for about 5 seconds, then the previous display reappears.

Tip

- If you need to cancel the sleep timer, press **SLEEP** repeatedly until the **SLEEP** indicator goes off.
- To check the time remaining until the AV receiver sleeps, press **SLEEP**. Note that if you press **SLEEP** while the sleep time is being displayed, you'll shorten the sleep time by 10 minutes.

Selecting Speaker Layout

You can prioritize which speakers you want to use.

Press **RECEIVER** followed by **SP LAYOUT** repeatedly.

■ 9.2 ch playback

▶ Speaker Layout:SB/FH:

The sounds from surround back and front high speakers are output by priority.

▶ Speaker Layout:SB/FW:

The sounds from surround back and front wide speakers are output by priority.

▶ Speaker Layout:FH/FW:

The sounds from front high and front wide speakers are output by priority.

■ 7.2 ch playback

▶ Speaker Layout:SB:

The sound from surround back speakers is output by priority.

▶ Speaker Layout:FH:

The sound from front high speakers is output by priority.

▶ Speaker Layout:FW:

The sound from front wide speakers is output by priority.

Note

- Playback conditions may be limited depending on the settings in "Speaker Settings" (→ 50) and "Speaker Configuration" (→ 51).
- When the listening mode that doesn't support front high, front wide and surround back speakers is used, the setting cannot be selected.

■ Speakers A or Speakers B Configuration

When "Speakers Type(Front B)" setting is set to other than "Not Use", you can choose which of the speakers you want to use with the Speakers A or Speakers B configuration. Speakers A or B can be switched regardless of listening modes.

Note

- When you use Speakers B configuration, you cannot use front high and front wide speakers.
- When you use Speakers B configuration, listening modes that require front high or front wide speakers such as Dolby Pro Logic IIz Height or Audyssey DSX™ are unavailable.
- While you are using Speakers B, you cannot use Audyssey MultEQ® XT32 Room Correction and Speaker Setup, Audyssey Dynamic EQ® and Audyssey Dynamic Volume®.

The Home menu provides you quick access to frequently used menus without having to go through the long standard menu. This menu enables you to change settings and view the current information.

1 Press RECEIVER followed by HOME.

The following information will be superimposed on the TV screen.

(The language is English only.)

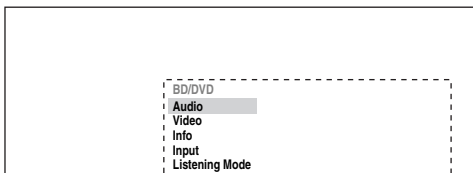

2 Use ▲/▼/◀/▶ to make the desired selection.

■ Audio

▶ Performs audio settings. For details, refer to “Using the Audio Settings” (→ 66).

■ Video^{*1}

▶ You can change the following settings: “Wide Mode”, “Picture Mode”, “Brightness”, “Contrast”, “Hue” and “Saturation”.

The remote controller’s VIDEO acts as a shortcut for this menu.

See also:

- “Picture Adjust” (→ 60)

■ Info^{*2*3}

▶ You can view the information of the following items: “Audio”, “Video” and “Tuner”.

■ Input^{*3*4}

▶ You can select the input source while viewing the information as follows: the name of input selectors, input assignments, and radio information, and ARC function setting.

Press ENTER to display the current input source, followed by ▲/▼ to select the desired input source. Pressing ENTER again switches to the selected input source.

■ Listening Mode

▶ You can select the listening modes that are grouped in the following categories: “Movie/TV”, “Music”, “Game” and “THX”.

Use ▲/▼ to select the category and ◀/▶ to select the listening mode. Press ENTER to switch to the selected listening mode.

Note

- *1 Only when you have selected “Custom” in the “Picture Mode” (→ 60), pressing ENTER allows you to adjust the following items via the Home menu: “Brightness”, “Contrast”, “Hue” and “Saturation”. Press RETURN to return to the original Home menu.
- *2 Depending on the input source and listening mode, not all channels shown here output the sound.
- *3 When you have entered a custom name in “Name Edit” (→ 59), the input source is displayed with that name. But even if not, the component name may be displayed if the AV receiver receives it via HDMI connection (→ 21).
- *4 For the PORT input selector, the name of Universal Port Option Dock will be displayed.

Changing the Input Display

When you connect an **RI**-capable Onkyo component, you must configure the input display so that **RI** can work properly.

This setting can be done only from the front panel.

- 1 Press **TAPE**, **GAME** or **VCR/DVR** so that “**TAPE**”, “**GAME**” or “**VCR/DVR**” appears on the display.

TAPE

GAME

VCR/DVR

- 2 Press and hold down **TAPE**, **GAME** or **VCR/DVR** (about 3 seconds) to change the input display. Repeat this step to select “**MD**”, “**CDR**” or “**DOCK**”.

For the **TAPE** input selector, the input display changes in this order:

TAPE → MD → CDR
 ↑ ↓
 DOCK ←

For the **GAME** input selector, the setting changes in this order:

GAME ↔ DOCK

For the **VCR/DVR** input selector, the setting changes in this order:

VCR/DVR ↔ DOCK

Note

- **DOCK** can be selected for the **TAPE**, **GAME** or **VCR/DVR** input selector, but not at the same time.
- Enter the appropriate remote control code before using the remote controller for the first time (→ 91).

Using Headphones

Connect a pair of stereo headphones with a standard plug (1/4 inch or 6.3 mm) to the **PHONES** jack.

Note

- Always turn down the volume before connecting your headphones.
- While the headphones plug is inserted in the **PHONES** jack, the Headphone indicator, speaker/channel indicator **FL** and **FR** lights. (The Powered Zone 2/3 speakers are not turned off.)
- When you connect a pair of headphones, the listening mode is set to Stereo, unless it's already set to Stereo, Mono, Direct, or Pure Audio.
- Only the Stereo, Direct, Pure Audio, and Mono listening modes can be used with headphones.

Using ACTIVITIES to Start Easy Macros

You can use **ACTIVITIES** to execute a number of remote control operations with a single button.

This button has the following two modes.

- ▶ Easy Macro mode:

You can turn on and off the AV receiver, playback components and TV.

- ▶ Normal Macro mode:

You can assign desired operations (→ 96, 98).

Note

- If you set any one of the **ACTIVITIES** to Normal Macro mode, all the **ACTIVITIES** will be set to Normal Macro mode.
- To use **ACTIVITIES**, first assign the remote control codes of the AV components you are using (→ 93).

Starting Components Using ACTIVITIES

Press **MY MOVIE**, **MY TV**, or **MY MUSIC**.

At purchase, **ACTIVITIES** are set to Easy Macro mode as the default setting.

The default actions are described below.

MY MOVIE:

1. The TV turns on.
2. The playback component assigned to **BD/DVD** of **REMOTE MODE** turns on.
3. The AV receiver turns on.
4. The input selector of the AV receiver is set to **BD/DVD**.
5. Playback begins on the playback component assigned to **BD/DVD**.^{*1}

MY TV:

1. The TV turns on.
2. The playback component assigned to **CBL/SAT** of **REMOTE MODE** turns on.
3. The AV receiver turns on.
4. The input selector of the AV receiver is set to **CBL/SAT**.

MY MUSIC:

1. The playback component assigned to **TV/CD** of **REMOTE MODE** turns on.
2. The AV receiver turns on.
3. The input selector of the AV receiver is set to **TV/CD**.
4. Playback begins on playback component assigned to **TV/CD**.^{*1}

Note

- After pressing one of the **ACTIVITIES**, you cannot use other **ACTIVITIES** until the assigned actions have been completed.
- If you wish to use another of the **ACTIVITIES** after starting, press **ALL OFF** and then press the desired **ACTIVITIES**.

^{*1} Depending on the start-up time of the playback component, the AV receiver may not be able to activate the playback command. In this case, press ► on the remote controller.

Turning Off the Components

Press ALL OFF.

The playback component assigned to the last-pressed **ACTIVITIES**, the AV receiver, and the TV turn off.*2

*2 When the last-pressed **ACTIVITIES** is **MY MUSIC**, the TV will not turn off.

Changing the Playback Components Assigned to ACTIVITIES

You can change the playback components assigned to the **ACTIVITIES** of Easy Macro mode using the following procedure.

While holding down **REMOTE MODE** for the relevant playback component, press and hold down **ACTIVITIES** to which you wish to assign this component for about 3 seconds.

ACTIVITIES will flash twice, indicating that the change is complete.

Examples:

If you wished to use **MY MOVIE** to start the playback component assigned to **VCR/DVR** of **REMOTE MODE**, you would press and hold down **MY MOVIE** for about 3 seconds while pressing down **VCR/DVR** of **REMOTE MODE**.

Tip

- This procedure can also be performed via onscreen menu (→ 96).

Restoring Default

- 1 While holding down **HOME**, press and hold down **ALL OFF** until **ALL OFF** lights (about 3 seconds).
- 2 Release **HOME** and **ALL OFF** and press **ALL OFF** again.
ALL OFF flashes twice.

Audyssey MultEQ® XT32 Room Correction and Speaker Setup

With the supplied calibrated microphone, Audyssey MultEQ XT32 automatically determines the number of speakers connected, their size for purposes of bass management, optimum crossover frequencies to the subwoofer (if present), and distances from the primary listening position.

Audyssey MultEQ XT32 then removes the distortion caused by room acoustics by capturing room acoustical problems over the listening area in both the frequency and time domain. The result is clear, well-balanced sound for everyone. Enabling Audyssey MultEQ XT32 allows you to also use Audyssey Dynamic EQ®, which maintains the proper octave-to-octave balance at any volume level (→ 57).

Before using this function, connect and position all of your speakers.

If “**Dynamic EQ**” is set to “**On**” (→ 57), the “**Equalizer**” setting will be set to “**Audyssey**” (→ 53). On the other hand, if it is set to “**Off**”, the “**Dynamic Volume**” setting will be set to “**Off**” (→ 58).

It takes about 30 minutes to complete Audyssey MultEQ XT32 Room Correction and Speaker Setup for 8 positions. Total measurement time varies depending on the number of speakers.

Note

- If any of your speakers is 4 ohms, change “**Speaker Impedance**” setting (→ 51) before running Audyssey MultEQ XT32 Room Correction and Speaker Setup.

Using Audyssey MultEQ XT32

Using Audyssey MultEQ XT32 to create a listening environment in your home theater that all listeners will enjoy, Audyssey MultEQ XT32 takes measurements at up to 8 positions within the listening area. Position the microphone at ear height of a seated listener with the microphone tip pointed directly at the ceiling using a tripod. Do not hold the microphone in your hand during measurements as this will produce inaccurate results.

■ First measurement position

Also referred to as the Main Listening Position this refers to the most central position where one would normally sit within the listening environment.

MultEQ XT32 uses the measurements from this position to calculate speaker distance, level, polarity, and the optimum crossover value for the subwoofer.

■ Second–Eighth measurement positions

These are the other listening positions (i.e., the places where the other listeners will sit). You can measure up to 8 positions.

The following examples show some typical home theater seating arrangements. Choose the one that best matches yours, and position the microphone accordingly when prompted.

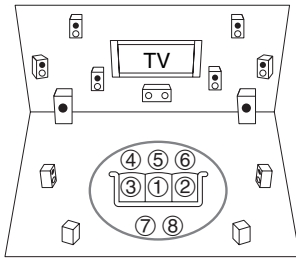

○ : Listening area ① to ⑧: Listening position

Note

- Make the room as quiet as possible. Background noise and Radio Frequency Interference (RFI) can disrupt the room measurements. Close windows, televisions, radios, air conditioners, fluorescent lights, home appliances, light dimmers, or other devices. Turn off the cell phone (even if it is not in use) or place it away from all audio electronics.
- The microphone picks up test tones which played through each speaker as Audyssey MultEQ® XT32 Room Correction and Speaker Setup run.
- Audyssey MultEQ XT32 Room Correction and speaker setup can only be used with Speakers A. When you insert the MIC with Speakers B selected, Speakers A will automatically be selected.
- Audyssey MultEQ XT32 Room Correction and speaker setup cannot be performed while a pair of headphones is connected.

1 Turn on the AV receiver and the connected TV.

On the TV, select the input to which the AV receiver is connected.

2 Set the speaker setup microphone at the Main Listening Position ①, and connect it to the SETUP MIC jack.

SETUP MIC jack

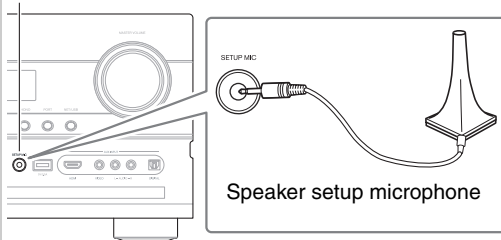

The speaker setting menu appears.

3 When you've finished making the settings, press ENTER.

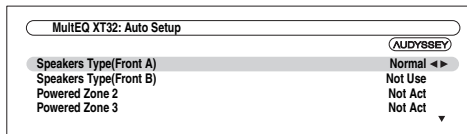

- If you change “Speakers Type(Front A)” or “Speakers Type(Front B)” setting, refer to “Speaker Settings” for more details (→ 50).
- If you change “Powered Zone 2” or “Powered Zone 3” setting, refer to “Setting the Powered Zone 2/3” for more details (→ 82).
- If you are using a subwoofer(s), select “1ch” or “2ch” in the “Subwoofer” (→ 51). If not, select “No” and skip step 4.

4 If you use a powered subwoofer(s), adjust the subwoofer volume level to 75dB.

Test tones are played through the subwoofer. Use the volume control on the subwoofer.

Caution

- When the “Subwoofer” setting is set to “1ch”, the left-hand subwoofer (SW1) alone will be measured. When the “Subwoofer” setting is set to “1ch” with two subwoofers connected, the right-hand subwoofer (SW2) will not be measured and no sound will be output.
- An error will occur if you set “Subwoofer” to “2ch” without connecting any subwoofers, or with only one subwoofer connected.

Note

- If your subwoofer does not have a volume control, disregard the level displayed and press **ENTER** to proceed to the next step.
- If you set the subwoofer’s volume control to its maximum and the displayed level is lower than 75 dB, leave the subwoofer’s volume control at its maximum and press **ENTER** to proceed to the next step.

5 Press ENTER.

Audyssey MultEQ XT32 Room Correction and Speaker Setup starts.

Test tones are played through each speaker as Audyssey MultEQ XT32 Room Correction and Speaker Setup runs. This process takes a few minutes. Please **refrain from talking** during measurements and **do not stand** between speakers and the microphone.

Do not disconnect the speaker setup microphone during Audyssey MultEQ XT32 Room Correction and Speaker Setup, unless you want to cancel the setup.

6 Place the setup microphone at the next position, and then press ENTER.

Audyssey MultEQ XT32 performs more measurements. This takes a few minutes.

7 When prompted, repeat step 6.

8 Use ▲/▼ to select an option, and then press ENTER.

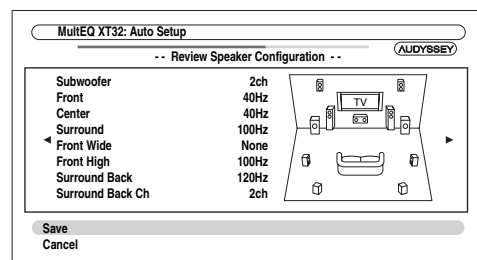

The options are:

► Save:

Save the calculated settings and exit Audyssey MultEQ XT32 Room Correction and Speaker Setup.

► Cancel:

Cancel Audyssey MultEQ XT32 Room Correction and Speaker Setup.

Note

- You can view the calculated settings for the speaker configuration, speaker distances, and speaker levels by using ◀/▶.

9 Disconnect the speaker setup microphone.

Note

- When Audyssey MultEQ® XT32 Room Correction and Speaker Setup is complete, the “Equalizer” will be set to “Audyssey” (→ 53). The Audyssey indicator will light (→ 9).
- You can cancel Audyssey MultEQ XT32 Room Correction and Speaker Setup at any point in this procedure simply by disconnecting the setup microphone.
- Do not connect or disconnect any speakers during Audyssey MultEQ XT32 Room Correction and Speaker Setup.
- If the AV receiver is muted, it will be unmuted automatically when Audyssey MultEQ XT32 Room Correction and Speaker Setup starts.
- Changes to the room after Audyssey MultEQ XT32 Room Correction and Speaker Setup requires you run Audyssey MultEQ XT32 Room Correction and Speaker Setup again, as room EQ characteristics may have changed.

Error Messages

While Audyssey MultEQ XT32 Room Correction and Speaker Setup is in progress, one of the error messages below may appear.

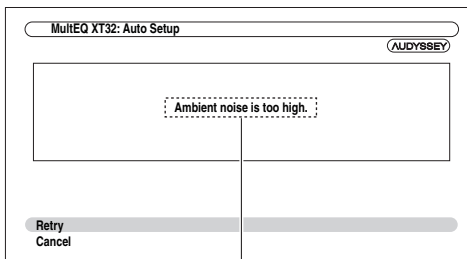

Error message

The options are:

▶ **Retry:**

Try again.

▶ **Cancel:**

Cancel Audyssey MultEQ XT32 Room Correction and Speaker Setup.

• **Ambient noise is too high.**

The background noise is too loud. Remove the source of the noise and try again.

• **Speaker Matching Error!**

The number of speakers detected was different from that of the first measurement. Check the speaker connection.

• **Writing Error!**

This message appears if saving fails. Try saving again. If this message appears after 2 or 3 attempts, contact your Onkyo dealer.

• **Speaker Detect Error**

This message appears if a speaker is not detected. “No” means that no speaker was detected.

Tip

- See “Speaker Configuration” for appropriate settings (→ 14).

Changing the Speaker Settings Manually

You can manually make changes to the settings found during Audyssey MultEQ XT32 Room Correction and Speaker Setup.

See also:

- “Speaker Configuration” (→ 51)
- “Speaker Distance” (→ 52)
- “Level Calibration” (→ 53)
- “Equalizer Settings” (→ 53)

Note

- Please note that THX recommends any THX main speakers be set to “80Hz(THX)”. If you set up your speakers using Audyssey MultEQ XT32 Room Correction and Speaker Setup, please make sure manually that any THX speakers are set to 80 Hz (THX) crossover (→ 51).
- Sometimes due to the electrical complexities of subwoofers and the interaction with the room, THX recommends setting the level and the distance of the subwoofer manually.
- Sometimes due to interaction with the room, you may notice irregular results when setting the level and/or distance of the main speakers. If this happens, THX recommends setting them manually.

Using a Powered Subwoofer

If you’re using a powered subwoofer and it outputs very low-frequency sound at a low volume level, it may not be detected by Audyssey MultEQ XT32 Room Correction and Speaker Setup.

If the “Subwoofer” appears on the “Review Speaker Configuration” screen as “No”, increase the subwoofer’s volume to the half-way point, set it to its highest crossover frequency, and then try running Audyssey MultEQ XT32 Room Correction and Speaker Setup again. Note that if the volume is set too high and the sound distorts, detection issues may occur, so use an appropriate volume level. If the subwoofer has a low-pass filter switch, set it to Off or Direct. Refer to your subwoofer’s instruction manual for details.

Listening to the Radio

This section describes the procedure using the buttons on the front panel unless otherwise specified.

Using the Tuner

With the built-in tuner you can enjoy AM and FM radio stations. You can store your favorite stations as presets for quick selection.

You can change the frequency steps (→ 64).

Listening to the Radio

Press **TUNER** to select either “AM” or “FM”.

In this example, FM has been selected.

Each time you press **TUNER**, the radio band changes between AM and FM.

Band	Frequency
FM	87.5 MHz

(Actual display depends on the country.)

Tuning into Radio Stations

Auto tuning mode

1 Press **TUNING MODE** so that the **AUTO** indicator lights on the display.

2 Press **TUNING ▲/▼**.

Searching stops when a station is found.

When tuned into a station, the **TUNED** indicator lights.

When tuned into a stereo FM station, the **FM STEREO** indicator lights on the display, as shown.

TUNED	AUTO
FM 87.5 MHz	TUNED + FM STEREO

FM STEREO

Manual tuning mode

1 Press **TUNING MODE** so that the **AUTO** indicator goes off on the display.

2 Press and hold **TUNING ▲/▼**.

The frequency stops changing when you release the button.

Press the buttons repeatedly to change the frequency one step at a time.

In manual tuning mode, FM stations will be in mono.

Tuning into weak FM stereo stations

If the signal from a stereo FM station is weak, it may be impossible to get good reception. In this case, switch to manual tuning mode and listen to the station in mono.

Tuning into stations by frequency

You can tune into AM and FM stations directly by entering the appropriate frequency.

1 On the remote controller, press **TUNER** repeatedly to select “AM” or “FM”, followed by **D.TUN**.

FM 87.5 MHz	AUTO
-------------	------

(Actual display depends on the country.)

2 Within 8 seconds, use the number buttons to enter the frequency of the radio station.

For example, to tune to 87.5 (FM), press **8, 7, 5**.

If you have entered the wrong number, you can retry after 8 seconds.

Presetting FM/AM Stations

You can store a combination of up to 40 of your favorite FM/AM radio stations as presets.

1 Tune into the FM/AM station that you want to store as a preset.

See the previous section.

2 Press MEMORY.

The preset number flashes.

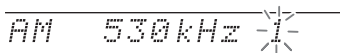

(Actual display depends on the country.)

3 While the preset number is flashing (about 8 seconds), use PRESET ◀/▶ to select a preset from 1 through 40.

4 Press MEMORY again to store the station or channel.

The station or channel is stored and the preset number stops flashing.

Repeat this procedure for all of your favorite FM/AM radio stations.

Note

- You can name your radio presets for easy identification (→ 59). Its name is displayed instead of the band and frequency.

Selecting Presets

To select a preset, use PRESET ◀/▶ on the AV receiver, or the remote controller's CH +/-.

Tip

- You can also use the remote controller's number buttons to select a preset directly.

Deleting Presets

1 Select the preset that you want to delete.

See the previous section.

2 While holding down MEMORY, press TUNING MODE.

The preset is deleted and its number disappears from the display.

Using RDS (excluding North American models)

RDS works only in areas where RDS broadcasts are available.

When tuned into an RDS station, the RDS indicator lights.

What is RDS?

RDS stands for Radio Data System and is a method of transmitting data in FM radio signals. It was developed by the European Broadcasting Union (EBU) and is available in most European countries. Many FM stations use it these days. In addition to displaying text information, RDS can also help you find radio stations by type (e.g., news, sport, rock, etc.).

The AV receiver supports four types of RDS information:

■ PS (Program Service)

When tuned to an RDS station that's broadcasting PS information, the station's name will be displayed. Pressing **DISPLAY** will display the frequency for 3 seconds.

■ RT (Radio Text)

When tuned to an RDS station that's broadcasting text information, the text will be shown on the display as described in the next section.

■ PTY (Program Type)

This allows you to search for RDS radio stations by type (→ 37).

■ TP (Traffic Program)

This allows you to search for RDS radio stations that broadcast traffic information (→ 37).

Note

- In some cases, the text characters displayed on the AV receiver may not be identical to those broadcast by the radio station. Also, unexpected characters may be displayed when unsupported characters are received. This is not a malfunction.
- If the signal from an RDS station is weak, RDS data may be displayed intermittently or not at all.

When tuned to an RDS station that's broadcasting text information, the text can be displayed.

Displaying Radio Text (RT)

Press RT/PTY/TP once.

The RT information scrolls across the display.

Note

- The message "**Waiting**" may appear while the AV receiver waits for the RT information.
- If the message "**No Text Data**" appears on the display, no RT information is available.

Finding Stations by Type (PTY)

You can search for radio stations by type.

- 1 Press RT/PTY/TP twice.**
The current program type appears on the display.
- 2 Use PRESET ◀/▶ to select the type of program you want.**
See the table shown later in this chapter.
- 3 To start the search, press ENTER.**
The AV receiver searches until it finds a station of the type you specified, at which point it stops briefly before continuing with the search.
- 4 When a station you want to listen to is found, press ENTER.**
If no stations are found, the message “Not Found” appears.

Listening to Traffic News (TP)

You can search for stations that broadcast traffic news.

- 1 Press RT/PTY/TP three times.**
If the current radio station is broadcasting TP (Traffic Program), “[TP]” will appear on the display, and traffic news will be heard as and when it’s broadcast. If “TP” without square brackets appears, this means that the station is not broadcasting TP.
- 2 To locate a station that is broadcasting TP, press ENTER.**
The AV receiver searches until it finds a station that’s broadcasting TP.
If no stations are found, the message “Not Found” appears.

■ RDS program types (PTY)

Type	Display
None	None
News reports	News
Current affairs	Affairs
Information	Info
Sport	Sport
Education	Educate
Drama	Drama
Culture	Culture
Science and technology	Science
Varied	Varied
Pop music	Pop M
Rock music	Rock M
Middle of the road music	Easy M
Light classics	Light M
Serious classics	Classics
Other music	Other M
Weather	Weather
Finance	Finance
Children’s programmes	Children
Social affairs	Social
Religion	Religion
Phone in	Phone In
Travel	Travel
Leisure	Leisure
Jazz music	Jazz
Country music	Country
National music	Nation M
Oldies music	Oldies
Folk music	Folk M
Documentary	Document
Alarm test	TEST
Alarm	Alarm!

Recording

This section explains how to record the selected input source to a component with recording capability, and how to record audio and video from different sources.

Connecting a Recording Component

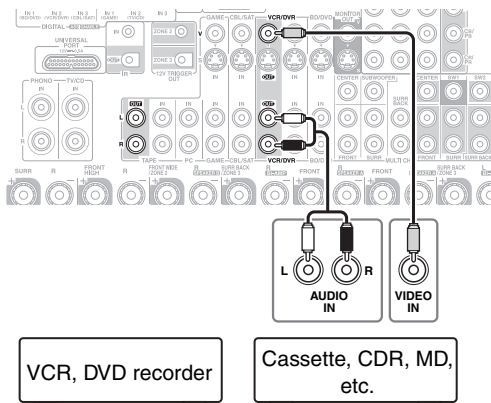

Note

- The AV receiver must be turned on for recording. Recording is not possible while it's in Standby mode.
- If you want to record directly from your TV or playback VCR to the recording VCR without going through the AV receiver, connect the TV/VCR's audio and video outputs directly to the recording VCR's audio and video inputs. See the manuals supplied with your TV and VCR for details.
- Video signals connected to composite video inputs can be recorded only via composite video outputs. If your TV/VCR is connected to a composite video input, the recording VCR must be connected to a composite video output.
- The surround sound and DSP listening modes cannot be recorded.
- Copy-protected Blu-ray Disc/DVDs cannot be recorded.
- Sources connected to a digital input cannot be recorded. Only analog inputs can be recorded.
- DTS signals will be recorded as noise, so don't attempt analog recording of DTS CDs or LDs.
- While the listening mode is set to Pure Audio, no image is provided because the power is turned off for the video circuit. If you want to make recordings, select other listening mode.

AV Recording

Audio sources can be recorded to a recorder (e.g., cassette deck, CDR, MD) connected to the **VCR/DVR OUT** or **TAPE OUT** jacks. Video sources can be recorded to a video recorder (e.g., VCR, DVD recorder) connected to the **VCR/DVR OUT** jack.

1 Use the input selector buttons to select the source that you want to record.

You can watch the source while recording. The AV receiver's **MASTER VOLUME** control has no effect on recording.

2 On your recorder, start recording.

3 On the source component, start playback.

If you select another input source during recording, that input source will be recorded.

Recording Separate AV Sources

Here you can record audio and video from completely separate sources, allowing you to overdub audio onto your video recordings. This function takes advantage of the fact that when an audio-only input source (**TV/CD, PHONO, etc.**) is selected, the video input source remains unchanged.

In the following example, audio from the CD player connected to the **TV/CD IN** and video from the camcorder connected to the **AUX INPUT VIDEO** jack are recorded by the VCR connected to the **VCR/DVR OUT** jacks.

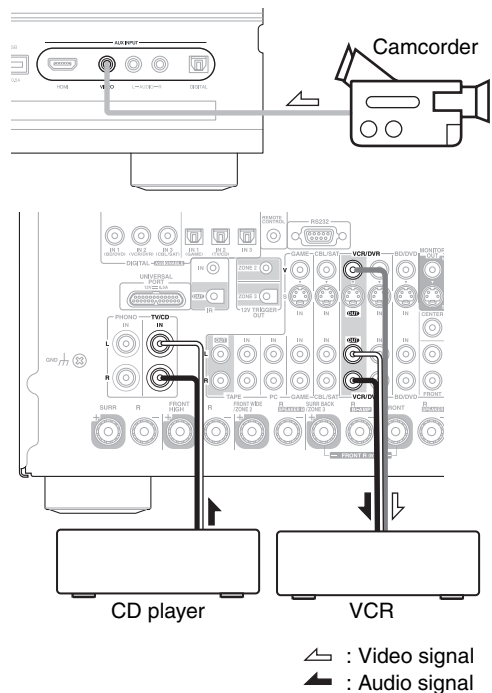

1 Prepare the camcorder and CD player for playback.

2 Prepare the VCR for recording.

3 Press **AUX** input selector.

4 Press **TV/CD** input selector.

This selects the CD player as the audio source, but leaves the camcorder as the video source.

5 Start recording on the VCR and start playback on the camcorder and CD player.

The video from the camcorder and the audio from the CD player are recorded by the VCR.

Using the Listening Modes

Selecting Listening Modes

See “About Listening Modes” for detailed information about the listening modes (→ 40).

Listening Mode Buttons

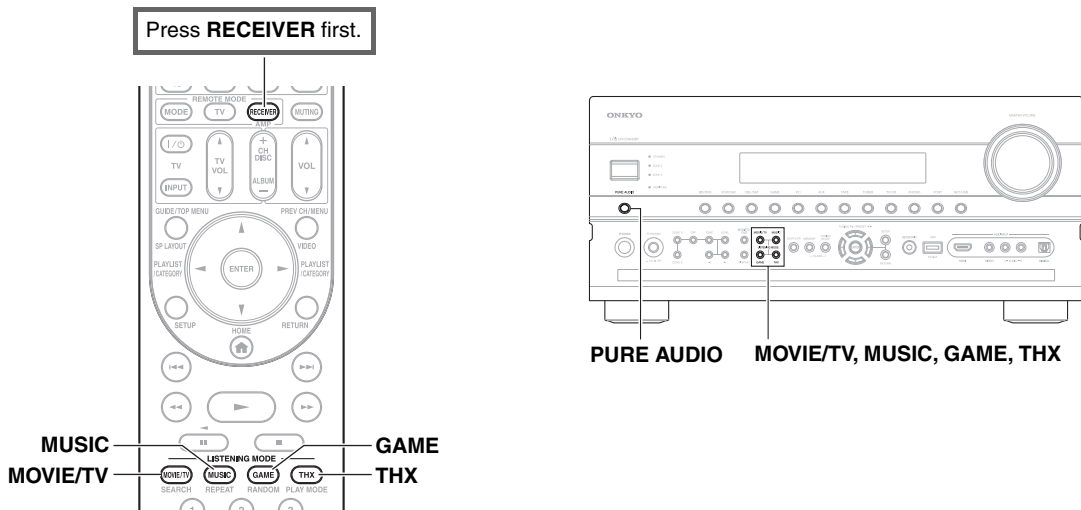

MOVIE/TV button

This button selects the listening modes intended for use with movies and TV.

MUSIC button

This button selects the listening modes intended for use with music.

GAME button

This button selects the listening modes intended for use with video games.

THX button

This button selects the THX listening modes.

PURE AUDIO button

This button selects the Pure Audio listening mode.

When this mode is selected, the AV receiver's display and video circuitry are turned off. Only video signals input through HDMI input can be output from an HDMI output(s). Pressing this button again will select the previous listening mode.

If you turn Zone 2 on during the Pure Audio listening mode, the previous listening mode will be selected.

- The Dolby Digital and DTS listening modes can only be selected if your Blu-ray Disc/DVD player is connected to the AV receiver with a digital audio connection (coaxial, optical, or HDMI).
- The listening modes you can select depend on the format of the input signal. To check the format, see “Displaying Source Information” (→ 28).
- While a pair of headphones is connected, you can select the following listening modes: Pure Audio, Mono, Direct, and Stereo.
- The listening modes cannot be used while you are listening to sound through your TV speakers coming from components connected to the AV receiver (“TV Sp On” appears on the front panel).

About Listening Modes

The AV receiver's listening modes can transform your listening room into a movie theater or concert hall, with high fidelity and stunning surround sound.

Explanatory Notes

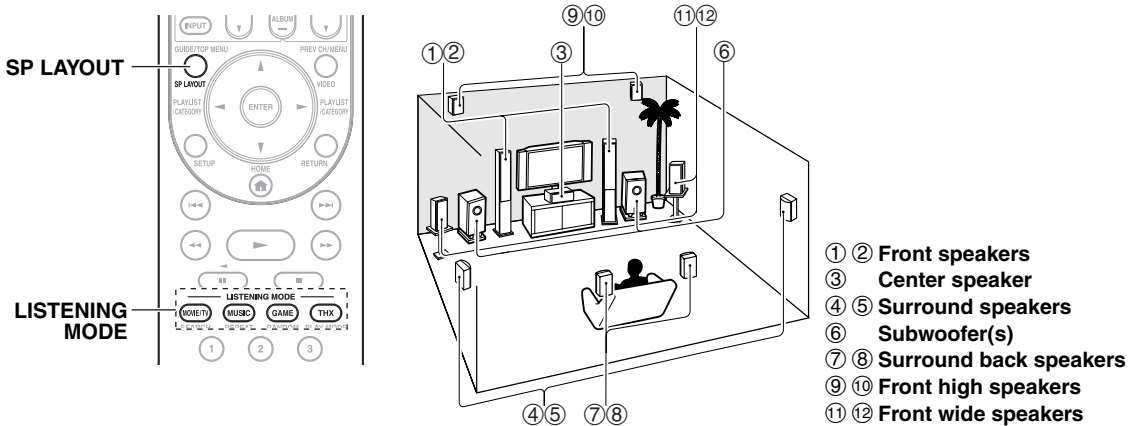

Input Source

The following audio formats are supported by the listening mode.

MONO	This is mono (monophonic) sound.
STEREO	This is stereo (stereophonic) sound. Two independent audio signal channels are reproduced through two speakers.
5.1ch	This is 5.1-channel surround sound. This surround system has five main channels of sound and a sixth subwoofer channel (called the point-one channel).
7.1ch	This is 7.1-channel surround sound. This is a further sound enhancement to 5.1 channel sound with two additional speakers that provide greater sound envelopment and more accurate positioning of sounds.
DTS-ES	This is DTS-ES surround sound. This surround system can produce a discrete or a matrix-encoded sixth channel from existing DTS 5.1 encoded material.
DJEX	This is Dolby Digital EX surround sound. This provides a center back surround channel from 5.1-channel sources.

Speaker Layout

The illustration shows which speakers are activated in each channel. See "Speaker Configuration" for the speaker setup (→ 51).

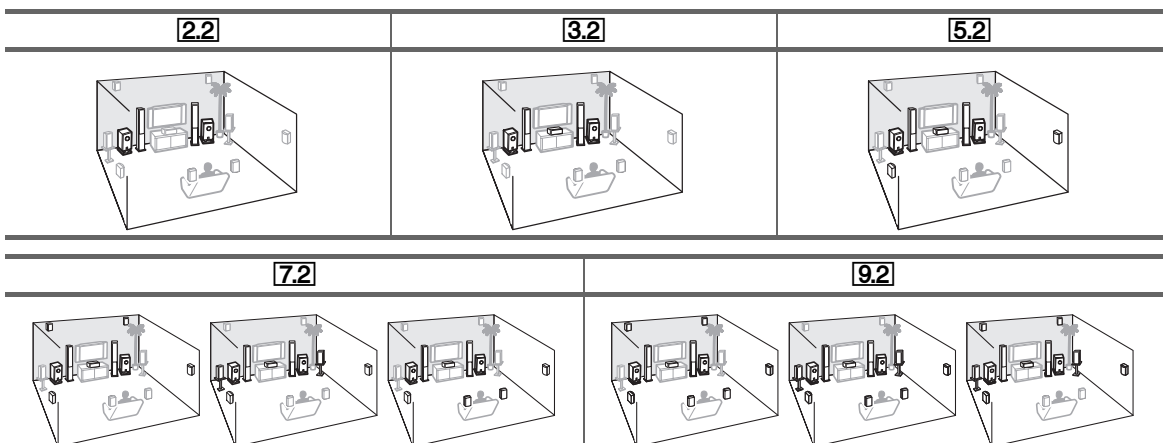

Press **RECEIVER** followed by **SP LAYOUT** repeatedly to select the speakers you want to use; front high, front wide, or surround back.

Press **RECEIVER** followed by **SP LAYOUT** repeatedly to select the combination; surround back and front high, surround back and front wide, and front high and front wide.

Listening Mode	Description	Input Source	Speaker Layout	
DTS-HD High Resolution Audio <i>DTS-HD HR</i>	(Continued from the previous page.)	5.1ch	3.2 5.2 7.2 9.2	
		7.1ch	3.2 5.2 7.2 *2 9.2 *2	
DTS-HD Master Audio <i>DTS-HD MSTR</i>		5.1ch	3.2 5.2 7.2 9.2	
		7.1ch	3.2 5.2 7.2 *2 9.2 *2	
DTS Express <i>DTS Express</i>		STEREO 5.1ch	3.2 5.2 7.2 9.2	
DSD*8 <i>DSD</i>		5.1ch	3.2 5.2 7.2 9.2	
DTS 96/24*9 <i>DTS 96/24</i>		This mode is for use with DTS 96/24 sources. This is high-resolution DTS with a 96 kHz sampling rate and 24-bit resolution, providing superior fidelity. Use it with DVDs that bear the DTS 96/24 logo.	5.1ch	3.2 5.2 7.2 9.2
DTS-ES Discrete*10 <i>ES Discrete</i>		This mode is for use with DTS-ES Discrete soundtracks, which use a discrete surround back channel for true 6.1/7.1-channel playback. The seven totally separate audio channels provide better spatial imaging and 360-degree sound localization, perfect for sounds that pan across the surround channels. Use it with DVDs that bear the DTS-ES logo, especially those with a DTS-ES Discrete soundtrack.	DTS-ES	7.2 *6 9.2 *6
DTS-ES Matrix*10 <i>ES Matrix</i>	This mode is for use with DTS-ES Matrix soundtracks, which use a matrix-encoded back-channel for 6.1/7.1-channel playback. Use it with DVDs that bear the DTS-ES logo, especially those with a DTS-ES Matrix soundtrack.	DTS-ES	7.2 *6 9.2 *6	
DTS Neo:6 <i>Neo:6</i> <i>Neo:6 Cinema</i> <i>Neo:6 Music</i>	This mode expands any 2-channel source for up to 7.1-channel playback. It uses seven full-bandwidth channels of matrix decoding for matrix-encoded material, providing a very natural and seamless surround sound experience that fully envelops the listener. <ul style="list-style-type: none"> • Neo:6 Cinema Use this mode with any stereo movie (e.g., TV, DVD, VHS). • Neo:6 Music Use this mode with any stereo music source (e.g., CD, radio, cassette, TV, VHS, DVD). 	STEREO	3.2 5.2 7.2 9.2	
	This mode uses Neo:6 to expand 5.1-channel sources for 6.1/7.1-channel playback.	5.1ch	7.2 *6 9.2 *6	
Audyssey DSX*11*14 <i>Audyssey DSX</i> <i>PLIIx Movie DSX</i> <i>PLIIx Music DSX</i> <i>PLII Movie DSX</i> <i>PLII Music DSX</i> <i>PLII Game DSX</i> <i>Neo:6 DSX</i> <i>Neo:6 Cin DSX</i> <i>Neo:6 Mus DSX</i> <i>Dolby EX DSX</i>	Audyssey DSX™ is a scalable system that adds new speakers to improve surround impression. Starting with a 5.1 system Audyssey DSX first adds Wide channels for the biggest impact on envelopment. Research in human hearing has proven that information from the Wide channels is much more critical in the presentation of a realistic soundstage than Back Surround channels found in traditional 7.1 systems. Audyssey DSX then creates a pair of Height channels to reproduce the next most important acoustical and perceptual cues. In addition to these new Wide and Height channels, Audyssey DSX applies Surround Envelopment Processing to enhance the blend between the front and surround channels. <p>The combination of Dolby Pro Logic II/IIx and Audyssey DSX modes can be used.</p> <p>The combination of Neo:6 and Audyssey DSX mode can be used.</p> <p>The combination of Neo:6 Cinema/Music and Audyssey DSX modes can be used.</p> <p>The combination of Dolby EX and Audyssey DSX modes can be used.</p>	5.1ch 7.1ch DTS-ES	7.2 9.2 *13	
		STEREO 5.1ch 7.1ch DTS-ES	7.2 9.2 *13	
		5.1ch	7.2 9.2 *13	
		STEREO	7.2 9.2 *13	
		5.1ch 7.1ch DTS-ES	7.2 9.2 *13	

Listening Mode	Description	Input Source	Speaker Layout
THX	<p>Founded by George Lucas, THX develops stringent standards that ensure movies are reproduced in movie theaters and home theaters just as the director intended. THX Modes carefully optimize the tonal and spatial characteristics of the soundtrack for reproduction in the home-theater environment. They can be used with 2-channel matrixed and multichannel sources. Surround back speaker output depends on the source material and the selected listening mode.</p> <ul style="list-style-type: none"> • THX Cinema THX Cinema mode corrects theatrical soundtracks for playback in a home theater environment. In this mode, THX Loudness Plus is configured for cinema levels and Re-EQ, Timbre Matching, and Adaptive Decorrelation are active. • THX Music THX Music mode is tailored for listening to music, which is typically mastered at significantly higher levels than movies. In this mode, THX Loudness Plus is configured for music playback and only Timbre Matching is active. • THX Games THX Games mode is meant for spatially accurate playback of game audio, which is often mixed similarly to movies but in a smaller environment. THX Loudness Plus is configured for game audio levels, with Timbre Matching active. 	5.1ch 7.1ch DTS-ES	5.2 7.2 9.2
<i>THX Cinema</i>			
<i>THX Music</i>			
<i>THX Games</i>			
<i>THX U2 Cinema</i>			
<i>THX U2 Music</i>			
<i>THX U2 Games</i>			
<i>THX Surr EX</i>			
	The combination of Dolby Pro Logic II/IIx ³ and THX Cinema/Music/Games modes can be used.	STEREO 5.1ch DDEX	5.2 7.2 9.2
	The combination of Dolby Pro Logic IIz Height ⁴ and THX Cinema/Music/Games modes can be used.	STEREO 5.1ch 7.1ch DTS-ES DDEX	7.2 9.2
	The combination of DTS Neo:6 and THX Cinema/Music/Games modes can be used.	STEREO 5.1ch 7.1ch DDEX	5.2 7.2 9.2
	<ul style="list-style-type: none"> • THX Ultra2 Cinema This mode expands 5.1-channel sources for 7.1-channel playback. It does this by analyzing the composition of the surround source, optimizing the ambient and directional sounds to produce the surround back channel output. • THX Ultra2 Music This mode is designed for use with music. It expands 5.1-channel sources for 7.1-channel playback. • THX Ultra2 Games This mode is designed for use with video games. It can expand 5.1-channel sources for 6.1/7.1-channel playback. • THX Surround EX This mode expands 5.1-channel sources for 6.1/7.1-channel playback. It's especially suited to Dolby Digital EX sources. THX Surround EX, also known as Dolby Digital Surround EX, is a joint development between Dolby Laboratories and THX Ltd. 	5.1ch 7.1ch	7.2 9.2
	The combination of Dolby Pro Logic IIz Height ⁴ and THX Ultra2 Cinema/Music/Games modes can be used.	STEREO 5.1ch 7.1ch DTS-ES DDEX	

Listening Mode	Description	Input Source	Speaker Layout
Neural Surround ⁶ <i>NRL Surround</i> <i>NRL THX Cinema</i> <i>NRL THX Music</i> <i>NRL THX Games</i>	This mode employs psychoacoustic frequency domain processing, which allows delivery of a more detailed sound stage, with superior channel separation and localization of audio elements. The Neural Surround modes can expand any 2-channel stereo source for 5.1- or 7.1-channel playback, respectively. Use them with CD, radio, cassette, TV, VHS, DVD, and other 2-channel stereo sources, including video games. Neural Surround can also be used by broadcasters to encode and transmit surround-sound content over a stereo signal, which listeners can enjoy as either surround sound or normal stereo.	STEREO	3.2 5.2 7.2 9.2
		5.1ch	7.2 9.2
	The combination of Neural Surround and THX Cinema/Music/Games modes can be used.	STEREO	3.2 5.2 7.2 9.2
		5.1ch	7.2 9.2
Neural Digital Music ⁶ <i>NRL Dig Music</i>	This is a new surround mode specifically designed to enhance the playback of compressed digital music content. It provides listeners with an expanded sound stage and clean surround experience, even with compressed audio sources such as MP3s and Internet streams.	STEREO	3.2 5.2 7.2 9.2

Onkyo-Original DSP Listening Modes

Listening Mode	Description	Input Source	Speaker Layout
Orchestra <i>Orchestra</i>	Suitable for classical or operatic music, this mode emphasizes the surround channels in order to widen the stereo image, and simulates the natural reverberation of a large hall.	MONO STEREO 5.1ch 7.1ch DTS-ES DDEX	5.2 7.2 *12 9.2 *13
Unplugged <i>Unplugged</i>	Suitable for acoustic instruments, vocals, and jazz, this mode emphasizes the front stereo image, giving the impression of being right in front of the stage.		
Studio-Mix <i>Studio-Mix</i>	Suitable for rock or pop music, listening to music in this mode creates a lively sound field with a powerful acoustic image, like being at a club or rock concert.		
TV Logic <i>TV Logic</i>	This mode adds realistic acoustics to TV shows produced in a TV studio, surround effects to the entire sound, and clarity to voices.		
Game-RPG <i>Game-RPG</i>	Use this mode when playing role playing game discs.		
Game-Action <i>Game-Action</i>	Use this mode when playing action game discs.		
Game-Rock <i>Game-Rock</i>	Use this mode when playing rock game discs.		
Game-Sports <i>Game-Sports</i>	Use this mode when playing sports game discs.		
All Ch Stereo <i>All Ch Stereo</i>	Ideal for background music, this mode fills the entire listening area with stereo sound from the front, surround, and surround back speakers.		3.2 5.2 7.2 *12 9.2 *13
Full Mono <i>Full Mono</i>	In this mode, all speakers output the same sound in mono, so the sound you hear is the same regardless of where you are within the listening room.		
T-D (Theater-Dimensional) <i>T-D</i>	With this mode you can enjoy a virtual surround sound even with only two or three speakers. This works by controlling how sounds reach the listener's left and right ears. Good results may not be possible if there's too much reverb, so we recommend that you use this mode in an environment with little or no natural reverb.		2.2 3.2 5.2 7.2 9.2

Note

- *1 If you turn Zone 2 on during the Pure Audio listening mode, the previous listening mode will be selected.
- *2 Based on the audio channels contained in the source, the corresponding speakers will output the sound.
- *3 If Powered Zone 3 is being used, Dolby Pro Logic II is used.
- *4 Surround back and front wide speakers are not supported.
- *5 Front wide speakers are not supported.
- *6 Front high and front wide speakers are not supported.
- *7 For the Blu-ray Discs, Dolby Digital is used in a 3.1/5.1-channel speaker system.
- *8 AV receiver can input the DSD signal from **HDMI IN**. Setting the output setting on the player side to PCM might obtain a better sound according to the player. In that case, set the output setting on the player side to PCM.
- *9 DTS is used depending on the configuration of the AV receiver (e.g., Audyssey Dynamic EQ® is on or Powered Zone 2 is being used).
- *10 If there are no surround back speakers or Powered Zone 2 is being used, DTS is used.
- *11 • This listening mode can be selected only when all the following conditions are satisfied:
 - a. Center speaker is connected.
 - b. Either of front high or front wide speakers is connected.
 - Output can be switched between front high or front wide speakers by pressing **SP LAYOUT** [depending on the "Speaker Configuration" setting (→ 51)].
- *12 Output can be switched between front high, front wide or surround back speakers by pressing **SP LAYOUT** [depending on the "Speaker Configuration" setting (→ 51)].
- *13 Output can be switched between the combination of surround back and front high, surround back and front wide, or front high and front wide speakers by pressing the **SP LAYOUT**.
- *14 If Speakers B is being used, Dolby Pro Logic IIz Height and Audyssey DSX™ cannot be selected.
- The listening modes cannot be selected with some source formats.

Advanced Setup

On-screen Setup Menus

This manual describes the procedure using the remote controller unless otherwise specified.

- | MENU | |
|------|----------------------------|
| ① | 1. Input/Output Assign |
| ② | 2. Speaker Setup |
| ③ | 3. Audio Adjust |
| ④ | 4. Source Setup |
| ⑤ | 5. Listening Mode Preset |
| ⑥ | 6. Miscellaneous |
| ⑦ | 7. Hardware Setup |
| ⑧ | 8. Remote Controller Setup |
| ⑨ | 9. Lock Setup |

- ① **Input/Output Assign** (→ 47) ⑥ **Miscellaneous** (→ 63)

1. Input/Output Assign	
1.	Monitor Out
2.	HDMI Input
3.	Component Video Input
4.	Digital Audio Input
5.	Analog Audio Input

6. Miscellaneous	
1.	Volume Setup
2.	OSD Setup

- ② **Speaker Setup** (→ 50)

2. Speaker Setup	
1.	Speaker Settings
2.	Speaker Configuration
3.	Speaker Distance
4.	Level Calibration
5.	Equalizer Settings
6.	THX Audio Setup

- ⑦ **Hardware Setup** (→ 64)

7. Hardware Setup	
1.	Remote ID
2.	Multi Zone
3.	Tuner
4.	HDMI
5.	Auto Power Down
6.	Network
7.	Firmware Update

- ③ **Audio Adjust** (→ 54)

3. Audio Adjust	
1.	Multiplex/Mono
2.	Dolby
3.	DTS
4.	Audyssey DSX
5.	Theater-Dimensional
6.	LFE Level
7.	Direct

- ⑧ **Remote Controller Setup** (→ 91, 96)

8. Remote Controller Setup	
1.	Remote Mode Setup
2.	Activities Setup

- ④ **Source Setup** (→ 57) ⑨ **Lock Setup** (→ 66)

4. Source Setup	
1.	Audyssey
2.	IntelliVolume
3.	A/V Sync
4.	Name Edit
5.	Picture Adjust

9. Lock Setup	
	Setup

- ⑤ **Listening Mode Preset** (→ 62)

5. Listening Mode Preset	
1.	BD/DVD
2.	VCR/DVR
3.	CBL/SAT
4.	GAME
5.	PC
6.	AUX

Common Procedures in Setup Menu

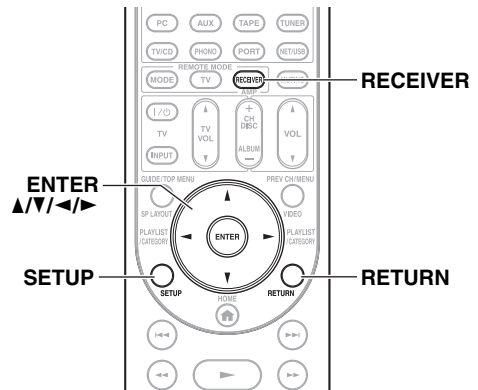

The on-screen setup menus appear on the connected TV and provide a convenient way to change the AV receiver's various settings. Settings are organized into 9 categories on the **main menu**.

Carry out the settings by using the on-screen display.

1 Press RECEIVER followed by SETUP.

The following menu appears.

MENU	
1.	Input/Output Assign
2.	Speaker Setup
3.	Audio Adjust
4.	Source Setup
5.	Listening Mode Preset
6.	Miscellaneous
7.	Hardware Setup
8.	Remote Controller Setup
9.	Lock Setup

Tip

- If the main menu doesn't appear, make sure the appropriate external input is selected on your TV.

2 Use ▲/▼ to select a menu, and then press ENTER.

3 Use ▲/▼ to select target and then press ENTER.

4 Use ▲/▼ to select option and use ◀/▶ to change the setting.

Press **SETUP** to close the menu.

Press **RETURN** to return to the previous menu.

Note

- This procedure can also be performed on the AV receiver by using **SETUP**, arrow buttons, and **ENTER**.
- During Audyssey MultEQ® XT32 Room Correction and Speaker Setup, messages, etc., that are displayed on the TV screen will appear in the Display.

Explanatory Notes

- ① — **Main Menu** **Speaker Setup**
- ② — **Subwoofer**
- ③ — **1ch:**
Audio signal is outputted from **SW1** jack only.
- 2ch:**
Audio signal is outputted from **SW1** and **SW2** jacks.
- ① Menu selection
② Setting target
③ Setting options (default setting underlined)

Input/Output Assign

Main Menu Input/Output Assign

Monitor Out

On the “**Monitor Out**” settings, you can select whether or not to have the video sources’ images output through the HDMI output, as well as whether to have the onscreen setup menu output through the HDMI output or through an analog output.

If you connect your TV to HDMI output, “**Monitor Out**” setting is automatically set so that the onscreen setup menus are displayed and composite video, S-Video, and component video sources are upconverted* and output.

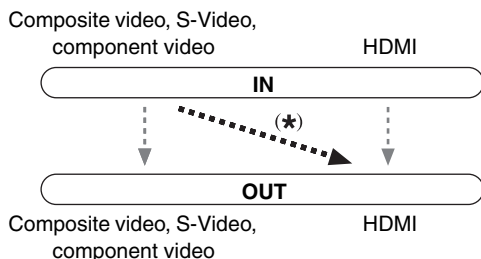

If you connect your TV to the **COMPONENT VIDEO MONITOR OUT** (not the HDMI output), “**Monitor Out**” setting is automatically set so that the onscreen setup menus are displayed and composite video and S-Video sources are upconverted* and output.

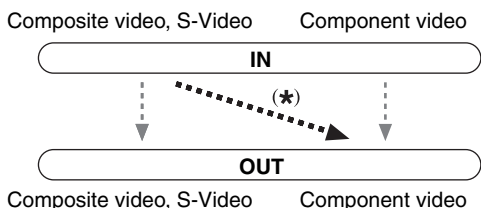

Note

- See “Video Connection Formats” (→ 25) for charts showing how the “**Monitor Out**” and “**Resolution**” settings (→ 48) affect the video signal flow through the AV receiver.

Monitor Out

▶ Analog:

Select this if your TV is connected to the **COMPONENT VIDEO MONITOR OUT**, **MONITOR OUT S**, or **MONITOR OUT V**.

▶ HDMI Main:

Select this if your TV is connected to the **HDMI OUT MAIN**.

▶ HDMI Sub:

Select this if your TV is connected to the **HDMI OUT SUB**.

▶ Both:

Select this if your TVs are connected to the **HDMI OUT MAIN** and **HDMI OUT SUB**. Video signals are output from both HDMI outputs at the resolution supported by both TVs.

▶ Both(Main):

Select this if your TVs are connected to the **HDMI OUT MAIN** and **HDMI OUT SUB**. Video signals are output from both HDMI outputs but **HDMI OUT MAIN** will become a priority; depending on the resolution, video signals may not be output from **HDMI OUT SUB**.

▶ Both(Sub):

Select this if your TVs are connected to the **HDMI OUT MAIN** and **HDMI OUT SUB**. Video signals are output from both HDMI outputs but **HDMI OUT SUB** will become a priority; depending on the resolution, video signals may not be output from **HDMI OUT MAIN**.

Note

- If not connected to the same output you have selected in the “**Monitor Out**” setting, the “**Monitor Out**” setting will be automatically switched to “**Analog**” (→ 26).
- When you select other than “**Analog**”, the onscreen setup menus are output by only the HDMI output. **If you’re not using the HDMI output and select settings by mistake and the menus disappear, press AV receiver’s MONITOR OUT to select “Analog”.**
- For Deep Color output, if the “**Monitor Out**” setting is set to “**Both(Main)**” or “**Both(Sub)**”, the number of bit may be limited due to the capability of your TV connected to a priority output.

Changing “Monitor Out” setting manually

- 1 Press **MONITOR OUT** on the front panel. The current setting is displayed.

Monitor Out
#HDMI Main

- 2 Press **MONITOR OUT** on the AV receiver repeatedly to select:

▶ **Analog**, **HDMI Main**, **HDMI Sub**, **Both**, **Both(Main)** or **Both(Sub)**

Resolution

You can specify the output resolution for the HDMI output and **COMPONENT VIDEO MONITOR OUT** and have the AV receiver upconvert the picture resolution as necessary to match the resolution supported by your TV.

▶ Through*1:

Select this to pass video through the AV receiver at the same resolution and with no conversion.

▶ Auto*2:

Select this to have the AV receiver automatically convert video at resolutions not supported by your TV.

▶ 480p (480p/576p):

Select this for 480p or 576p output and video conversion as necessary.

▶ 720p:

Select this for 720p output and video conversion as necessary.

▶ 1080i:

Select this for 1080i output and video conversion as necessary.

▶ 1080p*2:

Select this for 1080p output and video conversion as necessary.

▶ 1080p/24*2:

Select this for 1080p output at 24 frames per second and video conversion as necessary.

▶ Source:

Output will be according to the resolution level which was set in the **“Picture Adjust”** setting (→ 60).

Tip

- The **“Resolution”** setting is set respectively of main, sub, and analog.

Note

- If the **“Monitor Out”** setting is set to **“Both”**, this setting is fixed at **“Auto”**.
- Depending on the incoming video signal, video playback may not be smooth or the vertical resolution may be lowered. In this case select other than **“1080p/24”**.

*1 PC IN (Analog RGB) input signal is output at 480p (480p/576p), 720p, 1080i resolution when the **“Monitor Out”** setting is set to **“Analog”** (→ 47) and the **“Resolution”** setting is set to **“Through”**.

*2 These settings are not available when the **“Monitor Out”** setting is set to **“Analog”** (→ 47).

HDMI Input

If you connect a video component to an HDMI input, you must assign that input to an input selector. For example, if you connect your Blu-ray Disc/DVD player to **HDMI IN 2**, you must assign **“HDMI 2”** to the **“BD/DVD”** input selector.

If you’ve connected your TV to the AV receiver with an HDMI cable, composite video, S-video and component video sources can be upconverted* and output by the HDMI output*1. You can set this for each input selector by selecting the **“- - - - -”** option.

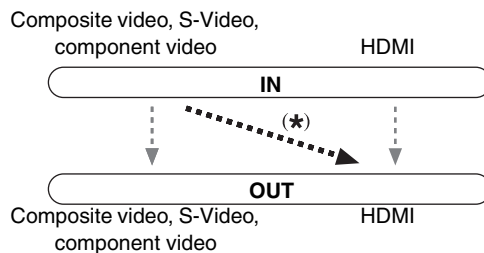

*1 This applies only when **“Monitor Out”** setting is set to other than **“Analog”** (→ 47).

Here are the default assignments.

Input selector	Default assignment
BD/DVD	HDMI 1
VCR/DVR	HDMI 2
CBL/SAT	HDMI 3
GAME	HDMI 4
PC	HDMI 5
AUX	FRONT (Fixed)
TAPE	- - - - -
TUNER	- - - - - (Fixed)
TV/CD	- - - - -
PHONO	- - - - -
PORT	- - - - -

■ BD/DVD, VCR/DVR, CBL/SAT, GAME, PC, TAPE, TV/CD, PHONO, PORT

▶ HDMI 1, HDMI 2, HDMI 3, HDMI 4, HDMI 5, HDMI 6, HDMI 7:

Select the **HDMI IN** to which the video component has been connected.

▶ - - - - -:

Output composite video, S-Video, and component video sources from the HDMI output. The video output signal from the HDMI output is the one configured in **“Component Video Input”** (→ 49).

- **“AUX”** is used only for input from the front panel.
- Each HDMI input cannot be assigned to two input selectors or more. When **HDMI 1 - HDMI 7** have already been assigned, you must set first any unused input selectors to **“- - - - -”** or you will be unable to assign **HDMI 1 - HDMI 7** to input selector.

Note

- For composite video, S-Video, and component video upconversion for the HDMI output, the “**Monitor Out**” setting must be set to other than “**Analog**” (→ 47), and the “**HDMI Input**” setting must be set to “- - - -”. See “Video Connection Formats” for more information on video signal flow and upconversion (→ 25).
- If no video component is connected to HDMI output (even if the HDMI input is assigned), the AV receiver selects the video source based on the setting of “**Component Video Input**”.
- When an **HDMI IN** is assigned to an input selector as explained here, the same **HDMI IN** will be set as a priority in the “Digital Audio Input” (→ 50). In this case, if you want to use the coaxial or optical audio input, make the selection in the “**Audio Selector**” in the Home menu (→ 68).
- “**TUNER**” selector cannot be assigned and is fixed at the “- - - -” option.
- If you connect a component (such as UP-A1 Dock that seated iPod) to **UNIVERSAL PORT** jack, you cannot assign any input to “**PORT**” selector.
- Do not assign the component connected with the HDMI input to “**TV/CD**” selector when you set “**TV Control**” setting to “**On**” (→ 65). Otherwise, appropriate CEC (Consumer Electronics Control) operation will not be guaranteed.

Component Video Input

If you connect a video component to a component video input, you must assign that input to an input selector. For example, if you connect your Blu-ray Disc/DVD player to **COMPONENT VIDEO IN 2**, you must assign “**IN 2**” to the “**BD/DVD**” input selector.

If you’ve connected your TV to the AV receiver with a component video cable, you can set the AV receiver so that composite video and S-Video sources are upconverted* and output by the **COMPONENT VIDEO MONITOR OUT**¹. You can set this for each input selector by selecting the “- - - -” option.

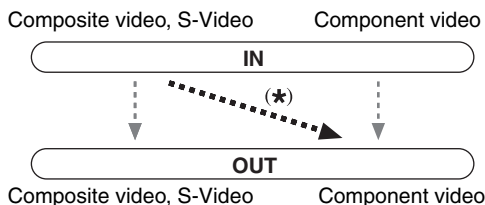

¹ This applies only when “**Monitor Out**” setting is set to “**Analog**” (→ 47).

Here are the default assignments.

Input selector	Default assignment
BD/DVD	IN 1
VCR/DVR	- - - -
CBL/SAT	IN 2
GAME	IN 3
PC	- - - -
AUX	- - - -
TAPE	- - - -
TUNER	- - - - (Fixed)
TV/CD	- - - -
PHONO	- - - -
PORT	- - - -

■ **BD/DVD, VCR/DVR, CBL/SAT, GAME, PC, AUX, TAPE, TV/CD, PHONO, PORT**

▶ **IN 1, IN 2, IN 3:**

Select a corresponding component video input that the video component has been connected.

▶ **- - - - -:**

Select if you are using HDMI output, rather than the **COMPONENT VIDEO MONITOR OUT**, for the output from composite video, S-Video, and component video sources.

Note

- For composite video and S-Video upconversion for the **COMPONENT VIDEO MONITOR OUT**, the “**Monitor Out**” setting must be set to “**Analog**” (→ 47), and the “**Component Video Input**” setting must be set to “- - - -”. See “Video Connection Formats” for more information on video signal flow and upconversion (→ 25).
- If not connected to the same output you have selected in the “**Monitor Out**” setting, the “**Monitor Out**” setting will be automatically switched to “**Analog**” (→ 47).
- “**TUNER**” selector cannot be assigned and is fixed at the “- - - -” option.
- If you connect a component (such as UP-A1 Dock that seated iPod) to the **UNIVERSAL PORT** jack, you cannot assign any input to “**PORT**” selector.

Digital Audio Input

If you connect a component to a digital audio input, you must assign that input to an input selector. For example, if you connect your CD player to the **OPTICAL IN 1**, you must assign “**OPT 1**” to the “**TV/CD**” input selector.

Here are the default assignments.

Input selector	Default assignment
BD/DVD	COAX 1
VCR/DVR	COAX 2
CBL/SAT	COAX 3
GAME	OPT 1
PC	-----
AUX	FRONT (Fixed)
TAPE	-----
TUNER	----- (Fixed)
TV/CD	OPT 2
PHONO	-----
PORT	-----

■ BD/DVD, VCR/DVR, CBL/SAT, GAME, PC, TAPE, TV/CD, PHONO, PORT

- ▶ **COAX 1, COAX 2, COAX 3, OPT 1, OPT 2, OPT 3 (TX-NR5008):**

Select a corresponding digital audio input that the component has been connected.

- ▶ **-----:**

Select if the component is connected to an analog audio input.

- “**AUX**” is used only for input from the front panel.

Note

- When an **HDMI IN** is assigned to an input selector in “**HDMI Input**” (→ 48), the same **HDMI IN** will be set as a priority in this assignment. In this case, if you want to use the coaxial or optical audio input, make the selection in the “**Audio Selector**” in the Home menu (→ 68).
- Available sampling rate for PCM signals from a digital input (optical and coaxial) is 32/44.1/48/88.2/96 kHz/16, 20, 24 bit.
- “**TUNER**” selector cannot be assigned and is fixed at the “**-----**” option.
- If you connect a component (such as UP-A1 Dock that seated iPod) to the **UNIVERSAL PORT** jack, you cannot assign any input to “**PORT**” selector.

Analog Audio Input

If you connect a component to the AV receiver’s analog multichannel input, you must assign that input to an input selector. For example, if you connect your Blu-ray Disc/DVD player to the **MULTI CH** input, you must assign it to the “**BD/DVD**” input selector.

■ Multich

- ▶ **BD/DVD, VCR/DVR, CBL/SAT, GAME, PC, AUX, TAPE, TV/CD, PHONO**

You can assign the multichannel input to the input selectors.

- ▶ **-----:**

If you don’t want to assign the multichannel input, set to “**-----**”.

Note

- To listen to the component connected to the multichannel input, make the selection in the “**Audio Selector**” in the Home menu (→ 68).

■ Subwoofer Input Sensitivity

- ▶ **0dB to 15dB** in 5 dB step.

Some DVD players output the LFE channel from their analog subwoofer output at 15 dB higher than normal. With this setting, you can change the AV receiver’s subwoofer sensitivity to match your DVD player.

Note

- This setting only affects signals connected to the AV receiver’s multichannel input **SUBWOOFER** jack.
- If you find that your subwoofer is too loud, try the 10 dB or 15 dB setting.

Speaker Setup

Main menu

Speaker Setup

Some of the settings in this section are set automatically by Audyssey MultEQ® XT32 Room Correction and Speaker Setup (→ 32). For Speakers B, you need to change the settings manually.

Here you can check the settings made by Audyssey MultEQ XT32 Room Correction and Speaker Setup, or set them manually, which is useful if you change one of the connected speakers after using Audyssey MultEQ XT32 Room Correction and Speaker Setup.

Press **RECEIVER** and use **SP LAYOUT** on the remote controller to select Speakers A or Speakers B.

Note

- These settings are disabled when:
 - a pair of headphones is connected, or
 - the “**Audio TV Out**” setting is set to “**On**” (→ 64) and an input selector other than **HDMI** is selected.

Speaker Settings

If you change these settings, you must run Audyssey MultEQ XT32 Room Correction and Speaker Setup again (→ 32).

If the impedance of any speaker is 4 ohms or more but less than 6, set the minimum speaker impedance to 4 ohms.

To use bi-amping or bridging, you must change the “**Speakers Type(Front A)**” or “**Speakers Type(Front B)**” setting (→ 51). For details on speaker wire connection, see “Connecting the AV Receiver” (→ 17 to 19).

Note

- When bridging is used, the AV receiver is able to drive up to 7.2 speakers in the main room.
- When bi-amping is used, the AV receiver is able to drive up to 7.2 speakers in the main room.
- Before you change these settings, turn down the volume.

■ Speaker Impedance

▶ 4ohms:

Select if the impedance of any speaker is 4 ohms or more but less than 6.

▶ 6ohms:

Select if the impedances of all speakers are between 6 and 16 ohms.

Note

- When bridging is used, “**Speaker Impedance**” setting is fixed at “**8ohms**”.

■ Speakers Type(Front A)

▶ Normal:

Select this if you’ve connected your front speakers A normally.

▶ Bi-Amp:

Select this if you’ve connected your front speakers A for bi-amped operation. The **Bi AMP** indicator will light (→ 9).

▶ BTL:

Select this if you’ve connected your front speakers A for bridged operation. The **BTL** indicator will light (→ 9).

Note

- “**Bi-Amp**” and “**BTL**” cannot be selected if “**Speakers Type(Front B)**” is set to “**Bi-Amp**” or “**BTL**”.
- Surround back speakers and Powered Zone 3 cannot be used if you select “**Bi-Amp**” or “**BTL**”.
- “**Speakers Type(Front A)**” is set to “**Normal**” if the “**Front High + Front Wide**” setting is set to “**Yes**”.

■ Speakers Type(Front B)

▶ Not Use:

Select this if you’re not using speakers B.

▶ Normal:

Select this if you’ve connected your front speakers B normally.

▶ Bi-Amp:

Select this if you’ve connected your front speakers B for bi-amped operation. The **Bi AMP** indicator will light (→ 9).

▶ BTL:

Select this if you’ve connected your front speakers B for bridged operation. The **BTL** indicator will light (→ 9).

Note

- “**Bi-Amp**” and “**BTL**” cannot be selected if “**Speakers Type(Front A)**” is set to “**Bi-Amp**” or “**BTL**”.
- Front high speakers, front wide speakers and Powered Zone 2 cannot be used if you select other than “**Not Use**”.
- Surround back speakers and Powered Zone 3 cannot be used if you select “**Bi-Amp**” or “**BTL**”.
- This setting cannot be used if “**Front High + Front Wide**” setting is set to “**Yes**”.

■ Powered Zone 2, Powered Zone 3

See “Setting the Powered Zone 2/3” (→ 82).

■ Front High + Front Wide

▶ Yes:

Front High + Front Wide on.

▶ No:

Front High + Front Wide off.

Listening mode that make use of “**Front High + Front Wide**” setting is as follows;

Audyssey DSX (PLII/Neo:6 + Audyssey DSX included), Orchestra, Unplugged, Studio-Mix, TV Logic, Game-RPG, Game-Action, Game-Rock, Game-Sports, All Ch Stereo, Full Mono.

Note

- When you have selected “**Yes**”,
 - the “**Surround Back**” setting is set to “**None**”.
 - the “**Front High**” or “**Front Wide**” setting is set to “**80Hz(THX)**” if set to “**None**”.
- The “**Front High + Front Wide**” setting cannot be used in either of the following cases;
 - “**Bi-Amp**” or “**BTL**” is being used.
 - Powered Zone 2/3 are being used.

Speaker Configuration

This setting is set automatically by Audyssey MultEQ® XT32 Room Correction and Speaker Setup function (→ 32). For Speakers B, you need to change the settings manually.

With these settings, you can specify which speakers are connected and a crossover frequency for each speaker. You can set the crossover frequencies, distances, and levels of the front speakers A and front speakers B independently. The other speakers (i.e., subwoofer, center, surround, and surround back) use the same crossover frequencies, distances, and levels for Speakers A and Speakers B. Specify “**Full Band**” for speakers that can output low frequency bass sounds adequately, for example, speakers with a good sized woofer. For smaller speakers, specify a crossover frequency. Sounds below the crossover frequency will be output by the subwoofer instead of the speaker. Refer to your speaker’s manuals to determine the optimum crossover frequencies.

If you set up your speakers using Audyssey MultEQ XT32 Room Correction and Speaker Setup, please make sure manually that any THX speakers are set to “**80Hz(THX)**” crossover.

■ Subwoofer

▶ 1ch:

Audio signal is outputted from **SW1** jack only.

▶ 2ch:

Audio signal is outputted from **SW1** and **SW2** jacks.

▶ No:

Select if no subwoofer is connected.

■ Front

(Setting Speakers A and Speakers B)

▶ Full Band

▶ 40Hz to 80Hz(THX) to 100Hz, 120Hz, 150Hz, 200Hz

Note

- If the “Subwoofer” setting is set to “No”, the “Front” setting is fixed at “Full Band”.

■ Center*1, Surround*1, Surround Back*2*3*4*8

▶ Full Band

▶ 40Hz to 80Hz(THX) to 100Hz, 120Hz, 150Hz, 200Hz

▶ None:

Select if no speaker is connected.

■ Front Wide*1*2*6*7, Front High*1*2*5*7

▶ Full Band

▶ 40Hz to 80Hz(THX) to 100Hz, 120Hz, 150Hz, 200Hz

▶ None:

Select if no speaker is connected.

Note

- *1 “Full Band” can be selected only when “Full Band” is selected in the “Front” setting.
- *2 If the “Surround” setting is set to “None”, this setting cannot be selected.
- *3 If the “Surround” setting is set to anything other than “Full Band”, “Full Band” cannot be selected here.
- *4 If the “Powered Zone 3” setting is set to “Act” (→ 82), or “Bi-Amp” or “BTL” is being used (→ 51), this setting cannot be selected.
- *5 If the Powered Zone 2 is being used (→ 82), this setting cannot be selected.
- *6 If the “Powered Zone 2” setting is set to “Act” (→ 82), this setting cannot be selected.
- *7 If the “Speakers Type(Front B)” setting is set to “Normal”, “Bi-Amp” or “BTL” (→ 51), this setting cannot be selected.
- *8 This setting cannot be used if the “Front High + Front Wide” setting is set to “Yes”.

■ Surround Back Ch

▶ 1ch:

Select if only one surround back speaker is connected.

▶ 2ch:

Select if two (left and right) surround back speakers are connected.

Note

- If the “Surround Back” setting is set to “None”, this setting cannot be selected.

■ LPF of LFE (Low-Pass Filter for the LFE Channel)

▶ 80Hz, 90Hz, 100Hz, 120Hz

With this setting, you can specify the cutoff frequency of the LFE channel’s low-pass filter (LPF), which can be used to filter out unwanted hum. The LPF only applies to sources that use the LFE channel.

■ Double Bass

This setting is NOT set automatically by Audyssey MultEQ® XT32 Room Correction and Speaker Setup function (→ 32).

With the Double Bass function, you can boost bass output by feeding bass sounds from the front left, right, and center channels to the subwoofer.

▶ On:

Double Bass function on.

▶ Off(THX):

Double Bass function off.

Note

- This function can be set only if the “Subwoofer” setting is set to “1ch” or “2ch”, and the “Front” setting is set to “Full Band”.
- If you’re using THX-certified speakers, select “Off(THX)”.

■ Subwoofer, Front, Center, Surround, Surround Back

(Setting Speakers A and Speakers B)

▶ Not Use:

Select if you don’t want to use each speaker with Speakers A or Speakers B.

▶ Use:

Select if you do want to use each speaker with Speakers A or Speakers B.

If you’re using Speakers B, you can choose whether or not to use the subwoofer, center, surround, and surround back speakers with the Speakers A and Speakers B configurations independently. You cannot choose whether or not to use the front speakers.

Note

- These settings can only be displayed when the “Speakers Type(Front B)” setting is set to other than “Not Use” (→ 51).
- You cannot select speakers that you set to “No” or “None”.

Speaker Distance

This setting is set automatically by Audyssey MultEQ XT32 Room Correction and Speaker Setup function (→ 32). For Speakers B, you need to change the settings manually.

Here you can specify the distance from each speaker to the listening position so that the sound from each speaker arrives at the listener’s ears as the sound designer intended.

You can set the distances for front speakers A and front speakers B independently. The other speakers (i.e., subwoofer, center, surround, and surround back) use the same distance settings for Speakers A and Speakers B.

■ Unit

▶ feet:

Distances can be set in feet. Range: “0.5ft” to “30.0ft” in 0.5 foot steps.

▶ meters:

Distances can be set in meters. Range: “0.15m” to “9.00m” in 0.15 meter steps.

(The default setting varies from country to country.)

■ Left, Front Wide Left, Front High Left, Center, Front High Right, Front Wide Right, Right, Surround Right, Surround Back Right, Surround Back Left, Surround Left, Subwoofer 1, Subwoofer 2*1

- ▶ Specify the distance from the each speaker to your listening position.

Note

- Speakers that you set to “No” or “None” in the “Speaker Configuration” cannot be selected (→ 51).
- Speakers B cannot be selected if “Speakers Type(Front B)” is set to “Not Use” (→ 51).
- *1 If the “Subwoofer” setting is set to “1ch”, this setting cannot be selected (→ 51).

Level Calibration

This setting is set automatically by Audyssey MultEQ® XT32 Room Correction and Speaker Setup function (→ 32). For Speakers B, you need to change the settings manually.

Here you can adjust the level of each speaker with the built-in test tone so that the volume of each speaker is the same at the listening position.

The other speakers (i.e., subwoofer, center, surround, and surround back) use the same level settings for Speakers A and Speakers B.

■ Left, Front Wide Left, Front High Left, Center*1, Front High Right, Front Wide Right, Right, Surround Right, Surround Back Right, Surround Back Left, Surround Left

- ▶ **-12.0dB** to **0.0dB** to **+12.0dB** in 0.5 dB step.

■ Subwoofer 1*1, Subwoofer 2*1*2

- ▶ **-15.0dB** to **0.0dB** to **+12.0dB** in 0.5 dB step.

Note

- Speakers that you set to “No” or “None” in the “Speaker Configuration” cannot be selected (→ 51).
- The speakers cannot be calibrated while the AV receiver is muted.
- The test tone is output at the standard level for THX, which is 0 dB (absolute volume setting 82). If you normally listen at volume settings below this, be careful because the test tone will be much louder.
- Speakers B cannot be selected if “Speakers Type(Front B)” is set to “Not Use”.
- The “Level Calibration” setting cannot be selected if “Audio TV Out” setting is set to “On”.
- *1 For the center speaker and subwoofer, the level settings made by using the Home menu are saved (→ 30).
- *2 If the “Subwoofer” setting is set to “1ch”, this setting cannot be selected (→ 51).

Tip

- If you're using a handheld sound level meter, adjust the level of each speaker so that it reads 75 dB SPL at the listening position, measured with C-weighting and slow reading.

Equalizer Settings

This setting is set automatically by Audyssey MultEQ XT32 Room Correction and Speaker Setup function (→ 32).

With the Equalizer settings, you can adjust the tone of speakers individually with a 7-band equalizer. The volume of each speaker can be set (→ 53).

The Equalizer settings only apply to Speakers A and cannot be adjusted while Speakers B is selected.

■ Equalizer

▶ Manual:

You can adjust the equalizer for each speaker manually. If you selected “Manual”, continue with this procedure.

1 Press **▼** to select “Channel”, and then use **◀/▶** to select a speaker.

2 Use **▲/▼** to select a frequency, and then use the **◀/▶** to adjust the level at that frequency. The volume at each frequency can be adjusted from **-6dB** to **0dB** to **+6dB** in 1 dB steps.

Note

- You can select: “63Hz”, “160Hz”, “400Hz”, “1000Hz”, “2500Hz”, “6300Hz”, or “16000Hz”. And for the subwoofer, “25Hz”, “40Hz”, “63Hz”, “100Hz”, or “160Hz”.
- While the Direct or Pure Audio listening mode is selected, the equalizer settings have no effect.

Tip

- Low frequencies (e.g., 63Hz) affect bass sounds; high frequencies (e.g., 16000Hz) affect treble sounds.

3 Use **▲** to select “Channel”, and then use **◀/▶** to select another speaker.

Repeat steps 1 and 2 for each speaker.

You cannot select speakers that you set to “No” or “None” in the “Speaker Configuration” (→ 51).

▶ Audyssey:

This is selected automatically by Audyssey MultEQ XT32 Room Correction and Speaker Setup function. The **Audyssey** indicator will light (→ 9) and “Dynamic EQ” and “Dynamic Volume” become available (→ 57).

When “Audyssey” is selected, “Dolby Volume” becomes “Off” automatically (→ 55).

▶ Off:

Tone off, response flat.

THX Audio Setup

With the “**Surr Back Speaker Spacing**” setting, you can specify the distance between your surround back speakers. This setting is used by Speakers A and Speakers B. If you’re using a THX-certified subwoofer, set the “**THX Ultra2/Select2 Subwoofer**” setting to “**Yes**”. You can then apply THX’s Boundary Gain Compensation (BGC) to compensate the perceived exaggeration of low frequencies for listeners sitting very close to a room boundary (i.e., wall).

You can also set the THX Loudness Plus. When the “**Loudness Plus**” is set to “**On**”, it is possible to enjoy even subtle nuances of audio expression at low volume. This result is only available when the THX listening mode is selected.

■ Surr Back Speaker Spacing

▶ **< 1ft (< 0.3m):**

Select this if your surround back speakers are between 0 and 1 foot (0–30 cm) apart.

▶ **1ft - 4ft (0.3m - 1.2m):**

Select this if your surround back speakers are between 1 and 4 feet (0.3–1.2 m) apart.

▶ **> 4ft (> 1.2m):**

Select this if your surround back speakers are more than 4 feet (1.2 m) apart.

Note

- Cannot be set if “**Surround Back Ch**” is set to “**1ch**” (→ 52), “**Surround Back**” is set to “**None**” (→ 52).

■ THX Ultra2/Select2 Subwoofer

▶ **No:**

Select this if you do not have a THX-certified subwoofer.

▶ **Yes:**

Select this if you have a THX-certified subwoofer.

Note

- If the “**Subwoofer**” setting is set to “**No**”, this setting cannot be selected (→ 51).

■ BGC

▶ **Off:**

Select this to turn off BGC.

▶ **On:**

Select this to turn on BGC.

Note

- This setting is only available if “**THX Ultra2/Select2 Subwoofer**” is set to “**Yes**”.

■ Loudness Plus

▶ **Off:**

Select this to turn off Loudness Plus.

▶ **On:**

Select this to turn on Loudness Plus.

■ Preserve THX Settings

▶ **Yes:**

Audyssey Dynamic EQ® /

Audyssey Dynamic Volume® / Dolby Volume will not be active in THX listening mode.

▶ **No:**

Audyssey Dynamic EQ /

Audyssey Dynamic Volume / Dolby Volume will be active in THX listening mode depending on the setting.

Note

- This setting is fixed at “**Yes**” if “**Loudness Plus**” is set to “**On**”.

THX Loudness Plus

THX Loudness Plus is a new volume control technology featured in THX Ultra2 Plus™ and THX Select2 Plus™ Certified receivers. With THX Loudness Plus, home theater audiences can now experience the rich details in a surround mix at any volume level. A consequence of turning the volume below Reference Level is that certain sound elements can be lost or perceived differently by the listener. THX Loudness Plus compensates for the tonal and spatial shifts that occur when the volume is reduced by intelligently adjusting ambient surround channel levels and frequency response. This enables users experience the true impact of soundtracks regardless of the volume setting. THX Loudness Plus is automatically applied when listening in any THX listening mode. The new THX Cinema, THX Music, and THX Games modes are tailored to apply the proper THX Loudness Plus settings for each type of content.

Audio Adjust

Main menu

Audio Adjust

With the Audio Adjust functions and settings, you can adjust the sound and listening modes as you like.

Multiplex/Mono

■ Multiplex

This setting determines which channel of a stereo multiplex source is output. Use it to select audio channels or languages with multiplex sources, multilingual TV broadcasts, and so on.

Input Channel

▶ **Main:**

The main channel is output.

▶ **Sub:**

The sub channel is output.

▶ **Main/Sub:**

Both the main and sub channels are output.

■ Mono

This setting specifies the channel to be used for playing any 2-channel digital source such as Dolby Digital, or 2-channel analog/PCM source in the Mono listening mode.

Input Channel

▶ **Left + Right:**

Both the left and right channels are output.

▶ **Left:**

Only the left channel is output.

▶ **Right:**

Only the right channel is output.

Output Speaker

▶ **Center:**

Mono audio is output by the center speaker.

▶ **Left / Right:**

Mono audio is output by the front left and right speakers.

This setting determines which speakers output mono audio when the Mono listening mode is selected.

Note

- If the “**Center**” setting is set to “**None**” (→ 52), this setting is fixed at “**Left / Right**”.

Dolby

■ **PLIIx Music (2ch Input)**

These settings apply to only 2-channel stereo sources. If you're not using any surround back speakers, these settings apply to Dolby Pro Logic II, not Dolby Pro Logic IIX.

Panorama

▶ **On:**

Panorama function on.

▶ **Off:**

Panorama function off.

With this setting, you can broaden the width of the front stereo image when using the Dolby Pro Logic IIX Music listening mode.

Dimension

▶ -3 to 0 to +3

With this setting, you can move the sound field forward or backward when using the Dolby Pro Logic IIX Music listening mode. Higher settings move the sound field backward. Lower settings move it forward.

If the stereo image feels too wide, or there's too much surround sound, move the sound field forward to improve the balance. Conversely, if the stereo image feels like it's in mono, or there's not enough surround sound, move it backward.

Center Width

▶ 0 to 3 to 7

With this setting, you can adjust the width of the sound from the center speaker when using the Dolby Pro Logic IIX Music listening mode. Normally, if you're using a center speaker, the center channel sound is output by only the center speaker. (If you're not using a center speaker, the center channel sound will be distributed to the front left and right speakers to create a phantom center). This setting controls the front left, right, and center mix, allowing you to adjust the weight of the center channel sound.

■ **PLIIZ Height Gain**

The Height Gain Control in Dolby Pro Logic IIZ enables the listener to select how much gain is applied to the front high speakers. There are three settings, “**Low**”, “**Mid**” and “**High**”, and the front high speakers are accentuated in that order. While “**Mid**” is the default listening setting, the listener may adjust the Height Gain Control to their personal preference.

▶ **Low:**

Low PLIIZ Height Gain becomes active.

▶ **Mid:**

Medium PLIIZ Height Gain becomes active.

▶ **High:**

High PLIIZ Height Gain becomes active.

Note

- If the “**Front High**” settings is set to “**None**” (→ 52), this setting cannot be selected.

■ **Dolby EX**

This setting determines how Dolby EX encoded signals are handled. This setting is unavailable if no surround back speakers are connected. This setting is effective with Dolby Digital, Dolby Digital Plus and Dolby TrueHD only.

▶ **Auto:**

If the source signal contains a Dolby EX flag, the Dolby EX or THX Surround EX listening mode is used.

▶ **Manual:**

You can select any available listening mode.

Note

- If the “**Surround Back**” setting is set to “**None**” (→ 52), this setting cannot be selected.
- If the “**Front High**” or “**Front Wide**” setting is enabled (→ 52), this setting is fixed at “**Manual**”.

■ **Dolby Volume**

▶ **Off:**

Dolby Volume off.

▶ **On:**

Dolby Volume on.

Dolby Volume automatically adjusts the difference in volume levels which can occur between different content or source components, freeing the user from having to make volume adjustments. Also, by adjusting the frequency balance according to the playback volume, it recreates the original source audio. Dolby Volume therefore provides comfortable listening, effectively controlling the volume level difference without unnatural changes in volume or sound quality to recreate the balance and nuance of the source audio.

Note

- When the “**Dolby Volume**” setting is set to effective, Audyssey Dynamic EQ and Audyssey Dynamic Volume will be set to “**Off**” and “**Equalizer**” setting will be set to “**Off**” from “**Audyssey**” or remain set to “**Manual**”.
- If you would like to use **Dolby Volume** in THX listening modes, set “**Loudness Plus**” setting to “**Off**” and set “**Preserve THX Settings**” setting to “**No**”.
- When the “**Dolby Volume**” is set to “**On**”, the Late Night function cannot be set.

■ Volume Leveler

- ▶ **Off:**
Volume Leveler off.
- ▶ **Low:**
Low Compression Mode becomes active.
- ▶ **Mid:**
Medium Compression Mode becomes active.
- ▶ **High:**
High Compression Mode becomes active. This setting affects volume the most, causing all sounds to be of equal loudness.

“Volume Leveler” maintains the perceived loudness of all content for example, from different channels or input sources.

Note

- If the “Dolby Volume” setting is set to “Off”, this setting cannot be selected.

■ Half Mode

- ▶ **Off:**
Half Mode off.
- ▶ **On:**
Half Mode on.

The Half Mode parameter turns Dolby Volume Half Mode processing ON and OFF.

In OFF mode, Dolby Volume applies a bass and treble attenuation to the audio when the system gain exceeds reference level. This enables a more perceptually flat listening experience as human ears are more sensitive to bass and treble at higher levels. Some listeners however, prefer to have more bass and treble performance at higher gain levels.

Note

- If the “Dolby Volume” setting is set to “Off”, this setting cannot be selected.
- During Half Mode ON playback, Dolby Volume does not apply a bass and treble attenuation when the system volume exceeds reference level thereby boosting perception of high and low frequencies.

DTS

■ Neo:6 Music

Center Image

- ▶ 0 to 2 to 5

The DTS Neo:6 Music listening mode creates 6-channel surround sound from 2-channel stereo sources. With this setting, you can specify by how much the front left and right channel output is attenuated in order to create the center channel.

Setting a value “0” in the middle is set to hear a sound. Sound is spread in left and right (the outside) so that the set value is made big. Please adjust by liking.

Audyssey DSX™

■ Soundstage

- ▶ -3dB to **Reference** to +3dB

With this setting, you can adjust the soundstage when using Audyssey DSX™.

Note

- If the “Center” setting is set to “None”, or both “Front High” and “Front Wide” settings are set to “None” (→ 52), this setting cannot be selected.
- “Soundstage” settings cannot be adjusted while Speakers B is selected.

Theater-Dimensional

■ Listening Angle

- ▶ **Wide:**

Select if the listening angle is greater than 30 degrees.

- ▶ **Narrow:**

Select if the listening angle is less than 30 degrees.

With this setting, you can optimize the Theater-Dimensional listening mode by specifying the angle of the front left and right speakers relative to the listening position. Ideally, the front left and right speakers should be equidistant from the listening position and at an angle close to one of the two available settings.

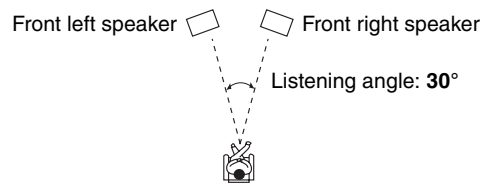

LFE Level

■ Dolby Digital*1, DTS*2, Multich PCM, Dolby TrueHD, DTS-HD Master Audio, DSD*3

- ▶ -∞dB, -20dB, -10dB, or 0dB

With these settings, you can set the level of the LFE (Low Frequency Effects) channel individually for each input sources.

If you find that low-frequency effects are too loud when using one of these sources, change the setting to -20 dB or -∞ dB.

*1 Dolby Digital and Dolby Digital Plus sources.

*2 DTS and DTS-HD High Resolution Audio sources.

*3 DSD (Super Audio CD) sources.

Direct

■ Analog

Subwoofer

▶ **Off:**

Analog audio signals (bass signals) are not output.

▶ **On:**

Analog audio signals (bass signals) are output.

This setting determines whether or not analog audio signals (bass signals) are output from front speakers when the Pure Audio or Direct listening mode is selected.

Note

- If the “Subwoofer” setting is set to “No” (→ 51), this setting cannot be selected.

■ DSD

DAC Direct

▶ **Off:**

DSD signals are processed by the DSP.

▶ **On:**

DSD signals are not processed by the DSP.

This setting determines whether or not DSD (Super Audio CD) audio signals are passed through the DSP for A/V Sync, delay, etc., processing when the Pure Audio or Direct listening mode is selected.

Note

- Once you have selected “Yes”, only DAC Direct will be available for selection. “DSD Direct” will appear on the display.

Source Setup

Items can be set individually for each input selector.

Preparation

Press the input selector buttons to select an input source.

Main menu

Source Setup

Audyssey

When Audyssey MultEQ® XT32 Room Correction and Speaker Setup is complete, the “Equalizer” (→ 53) will be set to “Audyssey” and the “Dynamic EQ” will be set to “On”.

Audyssey settings cannot be adjusted while Speakers B is selected.

■ Dynamic EQ

▶ **Off:**

Audyssey Dynamic EQ® off.

▶ **On:**

Audyssey Dynamic EQ on.

The **Dynamic EQ** indicator will light (→ 9).

With Audyssey Dynamic EQ, you can enjoy great sound even when listening at low volume levels.

Audyssey Dynamic EQ solves the problem of deteriorating sound quality as volume is decreased by taking into account human perception and room acoustics. It does so by selecting the correct frequency response and surround volume levels moment-by-moment so that the content sounds the way it was created at any volume level — not just at reference level.

■ Reference Level

Audyssey Dynamic EQ Reference Level Offset

▶ **0dB:**

It should be used when listening to movies.

▶ **5dB:**

Select this setting for content that has a very wide dynamic range, such as classical music.

▶ **10dB:**

Select this setting for jazz or other music that has a wider dynamic range. This setting should also be selected for TV content as that is usually mixed at 10 dB below film reference.

▶ **15dB:**

Select this setting for pop/rock music or other program material that is mixed at very high listening levels and has a compressed dynamic range.

Movies are mixed in rooms calibrated for film reference. To achieve the same reference level in a home theater system each speaker level must be adjusted so that -30 dBFS band-limited (500 Hz to 2000 Hz) pink noise produces 75 dB sound pressure level at the listening position. A home theater system automatically calibrated by Audyssey MultEQ XT32 will play at reference level when the master volume control is set to the 0 dB position. At that level you can hear the mix as the mixers heard it.

Audyssey Dynamic EQ is referenced to the standard film mix level. It makes adjustments to maintain the reference response and surround envelopment when the volume is turned down from 0 dB. However, film reference level is not always used in music or other non-film content. Audyssey Dynamic EQ Reference Level Offset provides three offsets from the film level reference (5 dB, 10 dB, and 15 dB) that can be selected when the mix level of the content is not within the standard.

Note

- If “Dynamic EQ” setting is set to “Off”, this setting cannot be selected.

■ Dynamic Volume

▶ **Off:**

Audyssey Dynamic Volume® off.

▶ **Light:**

Light Compression Mode becomes active.

▶ **Medium:**

Medium Compression Mode becomes active.

▶ **Heavy:**

Heavy Compression Mode becomes active. This setting affects volume the most, causing all sounds to be of equal loudness.

Note

- Even if you have selected other than “**Audyssey**” in “**Equalizer**” setting after performing Audyssey MultEQ® XT32 Room Correction and Speaker Setup, selecting “**On**” in the “**Dynamic EQ**” will change the “**Equalizer**” setting to “**Audyssey**” (→ 53).
- If you would like to use Audyssey Dynamic Volume, when using THX listening modes, set “**Loudness Plus**” setting to “**Off**” and set “**Preserve THX Settings**” setting to “**No**” (→ 54).
- When “**Dynamic Volume**” is set to effective, “**Equalizer**” is set to “**Audyssey**” (→ 53) and “**Dynamic EQ**” is set to “**On**”. When “**Dynamic EQ**” is set to “**Off**”, “**Dynamic Volume**” becomes “**Off**” automatically.
- When “**Dynamic Volume**” is set to effective, the **Dynamic Vol** indicator will light (→ 9).
- If Pure Audio or Direct listening mode is selected, these settings cannot be selected.
- “**Dynamic Volume**” and “**Dynamic EQ**” settings cannot be set if speakers B are being used.
- “**Dynamic EQ**” and “**Dynamic Volume**” settings cannot be used while a pair of headphones is connected.

Audyssey MultEQ XT32 then removes the distortion caused by room acoustics by capturing room acoustical problems over the listening area in both the frequency and time domain. The result is clear, well-balanced sound for everyone. Enabling Audyssey MultEQ XT32 allows you to also use Audyssey Dynamic EQ®, which maintains the proper octave-to-octave balance at any volume level. Before using this function, connect and position all of your speakers.

About Audyssey Dynamic EQ

Audyssey Dynamic EQ solves the problem of deteriorating sound quality as volume is decreased by taking into account human perception and room acoustics. Dynamic EQ selects the correct frequency response and surround levels moment-by-moment at any user-selected volume setting. The result is bass response, tonal balance, and surround impression that remain constant despite changes in volume. Dynamic EQ combines information from incoming source levels with actual output sound levels in the room, a prerequisite for delivering a loudness correction solution. Audyssey Dynamic EQ works in tandem with Audyssey MultEQ XT32 to provide well-balanced sound for every listener at any volume level.

About Audyssey Dynamic Volume

Audyssey Dynamic Volume solves the problem of large variations in volume level between television programs, commercials, and between the soft and loud passages of movies. Dynamic Volume looks at the preferred volume setting by the user and then monitors how the volume of program material is being perceived by listeners in real time to decide whether an adjustment is needed. Whenever necessary, Dynamic Volume makes the necessary rapid or gradual adjustments to maintain the desired playback volume level while optimizing the dynamic range. Audyssey Dynamic EQ is integrated into Dynamic Volume so that as the playback volume is adjusted automatically, the perceived bass response, tonal balance, surround impression, and dialog clarity remain the same whether watching movies, flipping between television channels, or changing from stereo to surround sound content.

IntelliVolume

IntelliVolume

▶ **-12dB** to **0dB** to **+12dB** in 1 dB steps.

With IntelliVolume, you can set the input level for each input selector individually. This is useful if one of your source components is louder or quieter than the others.

Use ◀/▶ to set the level.

If a component is noticeably louder than the others, use ◀ to reduce its input level. If it's noticeably quieter, use ▶ to increase its input level.

A/V Sync

A/V Sync

▶ **0msec** to **250msec** in 5 msec steps.

When using your DVD player's progressive scanning function, you may find that the picture and sound are out of sync. With the A/V Sync setting, you can correct this by applying a delay to the audio signal.

To view the TV picture while setting the delay, press **ENTER**.

To return to the previous screen, press **RETURN**.

If HDMI Lip Sync is enabled (⇒ **64**) and your TV or display supports HDMI Lip Sync, the displayed delay time will be the summation of the A/V Sync delay time and the HDMI Lip Sync delay time. The HDMI Lip Sync delay time is displayed underneath in parentheses.

Note

- A/V Sync is disabled when the Pure Audio listening mode is selected, or when the Direct listening mode is used with an analog input source.
- "A/V Sync" is not operable when the input selector is set to "NET/USB".

Name Edit

You can enter a custom name for each individual input selector (excluding **TUNER**) and radio preset for easy identification. When entered, the custom name will appear on the display.

The custom name is edited using the character input screen.

Name

1 Use ▲/▼/◀/▶ to select a character, and then press **ENTER**.

Repeat this step to enter up to 10 characters.

2 When you've finished, to store a name, be sure to use ▲/▼/◀/▶ to select "OK", and then press **ENTER**. Otherwise it will not be saved.

Name input area

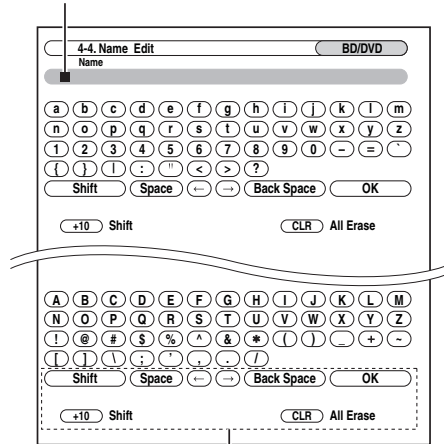

Shift*1:

Switches the displayed character.

Space:

Enters a space character.

← (Left)/ → (Right):

Selected when the cursor is moved within the Name input area.

Back Space*2:

"Back Space" moves the cursor backward one character space. In addition, "Back Space" deletes the character to the left of the cursor.

OK:

Selects when the entry is complete.

Tip

- *1 You can also be performed on the remote controller by using **+10**.
- *2 Press **CLR** on the remote controller, you can delete all characters in the input.

To correct a character:

1 Use ▲/▼/◀/▶ to select "←"(Left) or "→"(Right), and then press **ENTER**.

2 Press **ENTER** several times to select the incorrect character (The cursor moves one letter each time **ENTER** is pressed).

3 Use ▲/▼/◀/▶ to select the correct character, and then press **ENTER**.

Note

- To name a radio preset, use **TUNER** to select AM or FM, and then select the preset (⇒ **36**).
- (North American models) You cannot enter a custom name for SIRIUS radio presets.
- "Name Edit" is not operable when the input selector is set to "NET/USB".

To restore a custom name to the default, erase the custom name by entering an empty white space for each letter.

Picture Adjust

Using “**Picture Adjust**”, you can adjust the picture quality and reduce any noise appearing on the screen.

To view the TV picture while setting, press **ENTER**. To return to the previous screen, press **RETURN**.

■ Game Mode

▶ **Off:**

Game Mode off.

▶ **On:**

Game Mode on.

If video signal delay occurs during playback on a video component (i.e. game console), select the corresponding input source and set the “**Game Mode**” setting to “**On**”. The delay will decrease but in return the picture quality will become poor.

■ Wide Mode*1*5

This setting determines the aspect ratio.

▶ **4:3:**



▶ **Full:**

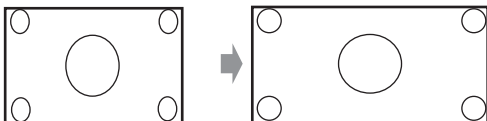

▶ **Zoom:**

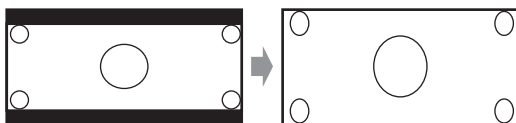

▶ **Wide Zoom:**

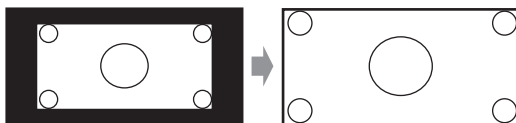

▶ **Smart Zoom:**

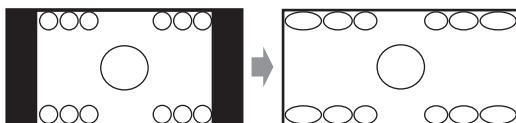

■ Picture Mode*1

▶ **Custom:**

All settings can be performed manually.

▶ **ISF Day:**

Setting when a room is bright.

▶ **ISF Night:**

Setting when a room is dark.

▶ **Cinema:**

Selected when the picture source is movie film, etc.

▶ **Game:**

Selected when the picture source is game console.

▶ **Through:**

Default values are adapted for all settings.

With “**Picture Mode**”, you can change the following settings to be suitable for the movie or game screen by one operation; “**Film Mode**”, “**Edge Enhancement**”, “**Mosquito NR**”, “**Random NR**”, “**Block NR**”, “**Resolution**”, “**Brightness**”, “**Contrast**”, “**Hue**”, “**Saturation**”, “**Gamma**”, “**Red Brightness**”, “**Red Contrast**”, “**Green Brightness**”, “**Green Contrast**”, “**Blue Brightness**”, “**Blue Contrast**”.

The receiver has been designed to incorporate setup and calibration standards established by the Imaging Science Foundation (ISF). The ISF has developed carefully crafted, industry-recognized standards for optimal video performance and has implemented a training program for technicians and installers to use these standards to obtain optimal picture quality from the receiver. Accordingly, Onkyo recommends that setup and calibration be performed by an ISF Certified installation technician.

■ Film Mode*2*4*6

▶ **Auto:**

Adjusts to the picture source, automatically selecting “**Film Mode**”.

▶ **Video:**

Selected when the picture source is video, etc.

▶ **Film:**

Selected when the picture source is movie film, etc.

DVD-Video disc content originates from either film (recorded at 24 frames per second) or video intended for TV (recorded at 30 frames per second). With the default “**Film Mode**” setting of “**Auto**”, the AV receiver automatically detects the type of content and processes it accordingly to achieve the best picture quality. If the AV receiver detects the type of content incorrectly due to characteristics of the disc, you can select “**Video**” or “**Film**” manually.

■ Edge Enhancement*2*4*7

▶ **Off:**

Edge enhancement off.

▶ **Low:**

Low edge enhancement.

▶ **Mid:**

Medium edge enhancement.

▶ **High:**

High edge enhancement.

With Edge Enhancement, you can make the picture appear sharper.

■ Mosquito NR*2*3*4*6

▶ **Off:**

Mosquito noise reduction off.

▶ **Low:**

Low mosquito noise reduction.

▶ **Mid:**

Medium mosquito noise reduction.

▶ **High:**

High mosquito noise reduction.

With Mosquito Noise Reduction, you can remove the shimmering or haziness that sometimes appears around objects in the picture. Mosquito noise can be an issue with overly compressed MPEG content.

■ Random NR*2*3*4*6

▶ **Off:**

Random noise reduction off.

▶ **Low:**

Low random noise reduction.

▶ **Mid:**

Medium random noise reduction.

▶ **High:**

High random noise reduction.

With Random Noise Reduction, you can remove indiscriminate picture noise, such as film grain.

■ Block NR*2*3*4*6

▶ **Off:**

Block noise reduction off.

▶ **On:**

Block noise reduction on.

With Block Noise Reduction, you can remove the block distortion that sometimes appears in the picture. Block noise can be an issue with overly compressed MPEG content.

■ Resolution*2*4

▶ **Through:**

Select this to pass video through the AV receiver at the same resolution and with no conversion.

▶ **Auto:**

Select this to have the AV receiver automatically convert video at resolutions not supported by your TV. When the “**Monitor Out**” is set to “**Analog**”, this setting will be changed to “**Through**”.

▶ **480p (480p/576p):**

Select this for 480p or 576p output and video conversion as necessary.

▶ **720p:**

Select this for 720p output and video conversion as necessary.

▶ **1080i:**

Select this for 1080i output and video conversion as necessary.

▶ **1080p:**

Select this for 1080p output and video conversion as necessary. When the “**Monitor Out**” is set to “**Analog**”, this setting will be changed to “**1080i**”.

▶ **1080p/24:**

Select this for 1080p output at 24 frames per second and video conversion as necessary. When the “**Monitor Out**” is set to “**Analog**”, this setting will be changed to “**1080i**”.

You can specify the output resolution for the HDMI outputs and have the AV receiver upconvert the picture resolution as necessary to match the resolution supported by your TV.

Available only when “**Source**” has been selected in the “**Resolution**” of the “**Monitor Out**” setting (→ **48**).

■ **Brightness*1*2*4**

▶ **-50 to 0 to +50**

With this setting you can adjust the picture brightness. “**-50**” is the darkest. “**+50**” is the brightest.

■ **Contrast*1*2*4**

▶ **-50 to 0 to +50**

With this setting you can adjust contrast. “**-50**” is the least. “**+50**” is the greatest.

■ **Hue*1*2*4**

▶ **-20 to 0 to +20**

With this setting you can adjust the red/green balance. “**-20**” is the strongest green. “**+20**” is the strongest red.

■ **Saturation*1*2*4**

▶ **-50 to 0 to +50**

With this setting you can adjust saturation. “**-50**” is the weakest color. “**+50**” is the strongest color.

■ **Gamma*2*4**

▶ **-3 to 0 to +3**

Adjust the balance of incoming picture R (red), G (green), and B (blue) color data signal to the output color data signal.

■ **Red Brightness*2*4**

▶ **-50 to 0 to +50**

With this setting you can adjust the picture red brightness. “**-50**” is the darkest. “**+50**” is the brightest.

■ **Red Contrast*2*4**

▶ **-50 to 0 to +50**

With this setting you can adjust red contrast. “**-50**” is the least. “**+50**” is the greatest.

■ **Green Brightness*2*4**

▶ **-50 to 0 to +50**

With this setting you can adjust the picture green brightness. “**-50**” is the darkest. “**+50**” is the brightest.

■ **Green Contrast*2*4**

▶ **-50 to 0 to +50**

With this setting you can adjust green contrast. “**-50**” is the least. “**+50**” is the greatest.

■ **Blue Brightness*2*4**

▶ **-50 to 0 to +50**

With this setting you can adjust the picture blue brightness. “**-50**” is the darkest. “**+50**” is the brightest.

■ Blue Contrast*2*4

▶ -50 to 0 to +50

With this setting you can adjust blue contrast. “-50” is the least. “+50” is the greatest.

Tip

- *1 This procedure can also be performed on the remote controller by using the Home menu (→ 30).
- *2 Press **CLR** if you want to reset to the default value.

Note

- If you are using the analog RGB input, the following settings have no effect: “**Film Mode**”, “**Edge Enhancement**”, “**Mosquito NR**”, “**Random NR**” and “**Block NR**”.
- “**Picture Adjust**” is not operable when the input selector is set to “**NET/USB**”.
- *3 These settings have no effect in the case of HD input source (720p, 1080i, 1080p, 1080p/24).
- *4 When the “**Picture Mode**” setting is set to anything other than “**Custom**”, this setting cannot be used.
- *5 Depending on the input and output resolutions, “**Smart Zoom**” may not be used.
- *6 When the “**Game Mode**” setting is set to “**On**”, this setting cannot be selected.
- *7 This setting have no effect in the case of downconversion.

Listening Mode Preset

You can assign a default listening mode to each input source that will be selected automatically when you select each input source. For example, you can set the default listening mode to be used with Dolby Digital input signals. You can select other listening modes during playback, but the mode specified here will be resumed once the AV receiver has been set to Standby.

Main menu

Listening Mode Preset

1 Use ▲/▼ to select the input source that you want to set, and then press **ENTER**.

The following menu appears.

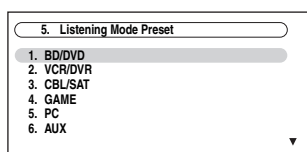

For “**TUNER**” input selector only “**Analog**” will be available. For “**NET/USB**” input source only “**Digital**” will be available.

Note

- If you connect an input component (such as UP-A1 series Dock that seated iPod) to the **UNIVERSAL PORT** jack, you can assign only listening modes for the analog sound to “**PORT**” selector.

2 Use ▲/▼ to select the signal format that you want to set, and then use ◀/▶ to select a listening mode.

Only listening modes that can be used with each input signal format can be selected (→ 40 to 45).

The “**Last Valid**” option means that the listening mode selected last will be used.

The “**Straight Decode**” option means that straight decoding listening mode (Dolby Digital, DTS, etc.) is selected.

■ Analog/PCM

With this setting, you can specify the listening mode to be used when an analog (CD, TV, LD, VHS, MD, turntable, radio, cassette, cable, satellite, etc.) or PCM digital (CD, DVD, etc.) audio signal is played.

■ Mono/Multiplex Source

With this setting, you can specify the listening mode to be used when a mono digital audio signal is played (DVD, etc.).

■ 2ch Source

With this setting, the default listening mode for 2-channel (2/0) stereo sources in a digital format, such as Dolby Digital or DTS.

■ Dolby D/Dolby D Plus/TrueHD

With this setting, you can specify the listening mode to be used when a Dolby Digital or Dolby Digital Plus format digital audio signal is played (DVD, etc.). Specifies the default listening mode for Dolby TrueHD sources, such as Blu-ray or HD DVD (input via HDMI).

■ DTS/DTS-ES/DTS-HD

With this setting, you can specify the listening mode to be used when a DTS or DTS-HD High Resolution Audio format digital audio signal is played (DVD, LD, CD, etc.). Specifies the default listening mode for DTS-HD Master Audio sources, such as Blu-ray or HD DVD (input via HDMI).

■ Other Multich Source

Specifies the default listening mode for multichannel PCM sources from **HDMI IN** such as DVD-Audio, and DSD multichannel sources such as Super Audio CD.

Volume Setup

■ Volume Display

▶ **Absolute:**

Display range is “Min”, “0.5” through “99.5”, “Max”.

▶ **Relative(THX):**

Display range is “-∞dB”, “-81.5dB” through “+18.0dB”.

With this setting, you can choose how the volume level is displayed.

The absolute value 82 is equivalent to the relative value 0 dB.

■ Muting Level

▶ **-∞dB** (fully muted), **-50dB** to **-10dB** in 10 dB steps.

This setting determines how much the output is muted when the muting function is used (→ 29).

■ Maximum Volume

▶ **Off**, **50** to **99** (Absolute display)

▶ **Off**, **-32dB** to **+17dB** (Relative display)

With this setting, you can limit the maximum volume.

To disable this setting, select “Off”.

■ Power On Volume

▶ **Last**, **Min**, **1** to **99** or **Max** (Absolute display)

▶ **Last**, **-∞dB**, **-81dB** to **+18dB** (Relative display)

With this preference, you can specify the volume setting to be used each time the AV receiver is turned on.

To use the same volume level that was used when the AV receiver was turned off, select “Last”.

The “Power On Volume” cannot be set higher than the “Maximum Volume” setting.

■ Headphone Level

▶ **-12dB** to **0dB** to **+12dB**

With this preference, you can specify the headphone volume relative to the main volume. This is useful if there’s a volume difference between your speakers and your headphones.

OSD Setup

■ On Screen Display

This preference determines whether operation details are displayed on-screen when an AV receiver function is adjusted.

▶ **On:**

Displayed.

▶ **Off:**

Not displayed.

Even when “On” is selected, operation details may not be output if the input source is connected to an **HDMI IN**.

■ TV Format (European and Asian models)

For the on-screen setup menus to display properly, you must specify the TV system used in your area.

▶ **Auto:**

Select this to automatically detect the TV system from the video input signals.

▶ **NTSC:**

Select this if the TV system in your area is NTSC.

▶ **PAL:**

Select this if the TV system in your area is PAL.

■ Language

▶ **English**, **Deutsch**, **Français**, **Español**, **Italiano**, **Nederlands**, **Svenska**, **中文**

This setting determines the language used for the on-screen setup menus.

Remote ID

Remote ID

▶ **1, 2, or 3**

When several Onkyo components are used in the same room, their remote ID codes may overlap. To differentiate the AV receiver from the other components, you can change its remote ID from “1”, to “2” or “3”.

Note

- If you do change the AV receiver’s remote ID, be sure to change the remote controller to the same ID (see below), otherwise, you won’t be able to control it with the remote controller.

Changing the Remote Controller’s ID

1 While holding down RECEIVER, press and hold down SETUP until RECEIVER lights (about 3 seconds).

2 Use the number buttons to enter ID 1, 2, or 3. RECEIVER flashes twice.

Multi Zone

See “Setting the Multi Zone” (→ 83).

Tuner

For FM/AM tuning to work properly, you must specify the FM/AM frequency step used in your area. Note that when this setting is changed, all radio presets will be deleted.

FM/AM Frequency Step (North American models)

▶ **200kHz/10kHz:**

Select if 200 kHz/10 kHz steps are used in your area.

▶ **50kHz/9kHz:**

Select if 50 kHz/9 kHz steps are used in your area.

AM Frequency Step (European and Asian models)

▶ **10kHz:**

Select if 10 kHz steps are used in your area.

▶ **9kHz:**

Select if 9 kHz steps are used in your area.

SIRIUS Settings (North American models)

See the separate Satellite Radio Guide for more information.

SAT Radio Mode

If you connect a SIRIUS Satellite Radio antenna to the AV receiver (sold separately), set this setting to “SIRIUS”.

Antenna Aiming, SIRIUS Parental Lock

These items are for use with SIRIUS Satellite Radio. It’s not available if “SAT Radio Mode” is set to “None”.

HDMI

Audio TV Out

▶ **Off:**

The audio is not output from the HDMI output.

▶ **On:**

The audio is output from the HDMI output.

This preference determines whether the incoming audio signal is output from the HDMI output. You may want to turn this preference on if your TV is connected to the HDMI output and you want to listen to the audio from a connected component through your TV’s speakers. Normally, this should be set to “Off”.

Note

- Listening mode cannot be changed when this setting is set to “On” and the input source is not HDMI.
- If “On” is selected and the audio can be output from the TV, the AV receiver will output no sound through its speakers. In this case, “TV Sp On” appears on the display.
- When “TV Control” is set to “On”, this setting is fixed to “Auto”.
- With some TVs and input signals, no sound may be output even when this setting is set to “On” (→ 65).
- When the “Audio TV Out” setting is set to “On”, or “TV Control” is set to “On” (→ 65) and you’re listening through your TV’s speakers (→ 21), if you turn up the AV receiver’s volume control, the sound will be output by the AV receiver’s front left and right speakers. To stop the AV receiver’s speakers producing sound, change the settings, change your TV’s settings, or turn down the AV receiver’s volume.
- If the “Monitor Out” setting is set to “Both(Main)” or “Both(Sub)” (→ 47) and if your TV connected to a priority output cannot output the audio, the sound will be heard from AV receiver’s speakers.

Lip Sync

▶ **Disable:**

HDMI lip sync disabled.

▶ **Enable:**

HDMI lip sync enabled.

The AV receiver can be set to automatically correct any delay between the video and the audio, based on the data from the connected monitor.

Note

- This function works only if your HDMI-compatible TV supports HDMI Lip Sync.
- You can check the amount of delay being applied by the HDMI Lip Sync function on the A/V Sync screen.
- If the “Monitor Out” setting is set to “HDMI Main”, “Both(Main)” or “Both” (→ 47), the delay will be corrected in accordance with the monitor connected to **HDMI OUT MAIN**. On the other hand, if “HDMI Sub” or “Both(Sub)” is selected, the delay will be corrected in accordance with the monitor connected to **HDMI OUT SUB**.

■ HDMI Control(RIHD)

▶ Off:

RIHD disabled.

▶ On:

RIHD enabled.

This function allows RIHD-compatible components connected via HDMI to be controlled with the AV receiver (→ 110 to 111).

Note

- When set to “On” and close the menu, the name of connected RIHD-compatible components and “RIHD On” are displayed on the AV receiver.
“Search...” → “(name)” → “RIHD On”
When the AV receiver cannot receive the name of the component, it is displayed as “Player*” or “Recorder*”, etc (“*” means the number of two or more component).
- When an RIHD-compatible component is connected to the AV receiver via the HDMI cable, the name of the connected component is displayed on the AV receiver display. For example, while you are watching TV broadcasting, if you operate a Blu-ray Disc/DVD player (being powered on) by the remote control of the AV receiver, the name of the Blu-ray Disc/DVD player is displayed on the AV receiver.
- Set to “Off” when a connected piece of equipment is not compatible or it is unclear whether the equipment is compatible or not.
- If movement is unnatural when set to “On”, change the setting to “Off”.
- Refer to the connected component’s instruction manual for details.
- The RIHD control does not support HDMI OUT SUB. Use HDMI OUT MAIN instead.
- When the source equipment is connected with the RI connection, it may malfunction if “HDMI Control(RIHD)” is set to “On”.

■ Audio Return Channel

▶ Off:

Select “Off” if you don’t want to use audio return channel (ARC) function.

▶ Auto:

The audio signal from your TV tuner can be sent to the HDMI OUT MAIN of the AV receiver.

Audio return channel (ARC) function enables an HDMI (Audio Return Channel) capable TV to send the audio stream to the HDMI OUT MAIN of the AV receiver. To use this function, you must select the TV/CD input selector and your TV must support ARC function.

Note

- The “Audio Return Channel” setting can be set only when the “HDMI Control(RIHD)” setting is set to “On”.
- This setting is set to “Auto” automatically when the “HDMI Control(RIHD)” is set to “On” first time.

■ Power Control

▶ Off:

Power Control disabled.

▶ On:

Power Control enabled.

To link the power functions of RIHD-compatible components connected via HDMI, select “On”.

This setting is set to “On” automatically when the “HDMI Control(RIHD)” is set to “On” first time.

Note

- The “Power Control” setting can be set only when the “HDMI Control(RIHD)” setting is set to “On”.
- HDMI power control only works with RIHD-compatible components that support it and may not work properly with some components due to their settings or compatibility.
- When set to “On”, power consumption will increase.
- When set to “On”, regardless of whether the AV receiver is On or in Standby, both audio and video stream from an HDMI input will be output to the TV or other components via HDMI connection (HDMI pass through function). When the HDMI pass through function activates in standby mode, HDMI THRU indicator will light.
- The power consumption during standby mode will increase during the HDMI pass through function; however if your TV supports CEC (Consumer Electronics Control), the power consumption can be saved in the following cases:
 - The TV is in standby mode.
 - You are watching a TV program.
- Refer to the connected component’s instruction manual for details.

■ TV Control

▶ Off:

TV Control disabled.

▶ On:

TV Control enabled.

Set to “On” when you want to control the AV receiver from an RIHD-compatible TV that is connected to HDMI.

Note

- Do not assign the component connected with the HDMI input to the TV/CD selector when you set “TV Control” setting to “On”. Otherwise, appropriate CEC (Consumer Electronics Control) operation is not guaranteed.
- Set to “Off” when the TV is not compatible or when it is unclear whether the TV is compatible or not.
- The “TV Control” setting can be set only when the “HDMI Control(RIHD)” (→ 65) and “Power Control” (→ 65) settings are both set to “On”.
- Refer to the connected component’s instruction manual for details.

After changing the settings of the “HDMI Control(RIHD)”, “Audio Return Channel”, “Power Control”, or “TV Control”, turn off the power to all connected pieces of equipment and then turn them on again. Refer to the user’s manuals for all connected pieces of equipment.

Auto Power Down

■ Auto Power Down

▶ Off:

Auto Power Down disabled.

▶ On:

Auto Power Down enabled.

When “**Auto Power Down**” is set to “**On**”, AV receiver will automatically perform STANDBY operation if there is no operation for 30 minutes with no audio and no video signal input.

“**Auto Power Down**” will display on the display and OSD from 30 seconds before the Auto Power Down functions. Default setting: **On (European and Asian models), Off (North American models)**

Note

- Depending on some sources, the auto power-down function may activate during playback.
- The Auto Power Down function does not work when Zone 2 or Zone 3 is on.

Network

See “Network Settings” (→ 76).

Firmware Update

See “Firmware Update” for update procedure (→ 112).

Note

- Perform the firmware update only when an announcement is posted on the Onkyo web site. See the Onkyo web site for latest information.
- It takes about 60 minutes to complete the firmware update.
- (TX-NR5008) When updating a firmware from a USB mass storage device, the AV receiver searches the device which is connected earlier during power on. If two devices have been connected at the time of power on, the AV receiver will search the device on the front panel.

■ Version

The current version of the firmware is displayed.

■ Receiver

▶ via NET:

You can update the firmware via Internet. Check the network connection before update.

▶ via USB:

You can update the firmware from a USB mass storage device.

You can update the AV receiver’s firmware. Do not shut-down the power of the AV receiver while update.

■ Universal Port

▶ via NET:

You can update the firmware via Internet. Check the network connection before update.

▶ via USB:

You can update the firmware from a USB mass storage device.

You can update the Onkyo dock’s firmware. Do not shut-down the power of the AV receiver while update.

Note

- This update shall not be performed when no dock is connected to **UNIVERSAL PORT** jack.

Lock Setup

With this preference, you can protect your settings by locking the setup menus.

Main menu

Lock Setup

■ Setup

▶ Locked:

Setup menus locked.

▶ Unlocked:

Setup menus not locked.

When the setup menus are locked, you cannot change any setting.

Using the Audio Settings

You can change various audio settings from the Home menu (→ 30).

1 Press **RECEIVER** followed by **HOME**.

2 Use **▲/▼** to select “Audio”, and then use **▲/▼/◀/▶** to make the desired selection.

Note

- These settings are disabled when the “**Audio TV Out**” setting is set to “**On**” (→ 64) and an input selector other than HDMI is selected.

Tone Control Settings

You can adjust the bass for the front, front wide, front high, center, surround, surround back and subwoofer speakers and treble for the front, front wide, front high, center, surround and surround back speakers, except when the Direct, Pure Audio or THX listening mode is selected.

■ Bass

▶ **-10dB** to **0dB** to **+10dB** in 2 dB steps.

You can boost or cut low-frequency sounds output.

■ Treble

▶ **-10dB** to **0dB** to **+10dB** in 2 dB steps.

You can boost or cut high-frequency sounds output.

Operating on the AV receiver

1 Press **TONE** on the AV receiver repeatedly to select either “Bass” or “Treble”.

2 Use **Up ▶** and **Down ◀** on the AV receiver to adjust.

Note

- This setting is not available when the multichannel analog input is selected.
- To bypass the bass and treble tone circuits, select the Direct, Pure Audio or THX listening mode.

Speaker Levels

You can adjust the volume of each speaker while listening to an input source.

These temporary adjustments are cancelled when the AV receiver is set to Standby. To save the setting you made here, go to “Level Calibration” (→ 53) before setting the AV receiver to Standby.

■ Subwoofer 1

▶ **-15.0dB** to **0.0dB** to **+12.0dB** in 1 dB steps.

■ Subwoofer 2

▶ **-15.0dB** to **0.0dB** to **+12.0dB** in 1 dB steps.

■ Center

▶ **-12.0dB** to **0.0dB** to **+12.0dB** in 1 dB steps.

Note

- You cannot use this function while the AV receiver is muted.
- Speakers that are set to “No” or “None” in the “Speaker Configuration” (→ 51) cannot be adjusted.
- This function will not work when the Pure Audio or Direct listening mode is selected to play analog audio.
- This setting cannot be used while a pair of headphones is connected.

Audyssey Settings

■ Dynamic EQ

See “Dynamic EQ” of “Source Setup” (→ 57).

■ Dynamic Volume

See “Dynamic Volume” of “Source Setup” (→ 58).

Dolby Volume

■ Dolby Volume

See “Dolby Volume” of “Audio Adjust” (→ 55).

Late Night

With the Late Night function, you can reduce the dynamic range of Dolby Digital material so that you can still hear quiet parts even when listening at low volume levels—ideal for watching movies late at night when you don’t want to disturb anyone.

■ Late Night

For **Dolby Digital** and **Dolby Digital Plus** sources, the options are:

- ▶ **Off:**
Late Night function off.
- ▶ **Low:**
Small reduction in dynamic range.
- ▶ **High:**
Large reduction in dynamic range.

For **Dolby TrueHD** sources, the options are:

- ▶ **Auto:**
The Late Night function is set to “On” or “Off” automatically.
- ▶ **Off:**
Late Night function off.
- ▶ **On:**
Late Night function on.

Note

- The effect of the Late Night function depends on the material that you are playing and the intention of the original sound designer, and with some material there will be little or no effect when you select the different options.
- The Late Night function can be used only when the input source is Dolby Digital, Dolby Digital Plus, or Dolby TrueHD.
- The Late Night function is set to “Off” when the AV receiver is set to Standby. For Dolby TrueHD sources, it will be set to “Auto”.

Music Optimizer

The Music Optimizer function enhances the sound quality of compressed music files. Use it with music files that use “lossy” compression, such as MP3.

■ Music Optimizer

- ▶ **Off:**
Music Optimizer off.
- ▶ **On:**
Music Optimizer on. The **M.Opt** indicator will light (→ 9).

Note

- The Music Optimizer function only works with PCM digital audio input signals with a sampling rate below 48 kHz and analog audio input signals. The Music Optimizer is disabled when the Direct or Pure Audio listening mode is selected.
- The setting is stored individually for each input selector.

Screen Centered Dialog

“**Screen Ctr Dialog**” is a function for moving the Center image of dialog etc. upwards through use of the front high speaker to fix the image to the display height.

■ Screen Ctr Dialog

As the value increases, the Center image moves upwards.

- ▶ **0:**
Screen Centered Dialog off.
- ▶ **1 to 5:**
Screen Centered Dialog on.

Note

- The “**Screen Ctr Dialog**” can be used when supported listening mode is selected and “**Center**” and “**Front High**” are set to effective in “Speaker Configuration” (→ 51).
- This setting cannot be used while a pair of headphones is connected.

Re-EQ

With the Re-EQ function, you can compensate a soundtrack whose high-frequency content is too harsh, making it more suitable for home theater viewing.

■ Re-EQ

- ▶ **Off:**
Re-EQ Function off.
- ▶ **On:**
Re-EQ Function on.

This function can be used with the following listening modes: Dolby Digital, Dolby Digital Plus, Dolby TrueHD, Multichannel, DTS, DTS-HD High Resolution Audio, DTS-HD Master Audio, DTS Express, DSD, Dolby EX, Dolby Pro Logic IIz Height, Dolby PLIIx Movie, Neo:6 Cinema and 5.1-channel source + Neo:6, and Neural Surround.

■ Re-EQ(THX)

- ▶ **Off:**
Re-EQ (THX) Function off.
- ▶ **On:**
Re-EQ (THX) Function on.

This function can be used with the following listening modes: THX Cinema, THX Surround EX, and THX Ultra2 Cinema.

Note

- Settings for the Re-EQ function are kept in each listening mode. However, in THX listening mode, when the AV receiver is turned off, it will return to “**On**”.
- This setting cannot be used while a pair of headphones is connected.

Audio Selector

You can set priorities of audio output when there are both digital and analog inputs.

■ Audio Selector

- ▶ **ARC:**
The audio signal from your TV tuner can be sent to the **HDMI OUT MAIN** of the AV receiver.*¹ With this selection the TV’s audio can be automatically selected as a priority among other assignments.
- ▶ **HDMI:**
This can be selected when **HDMI IN** has been assigned as an input source. If both HDMI (**HDMI IN**) and digital audio inputs (**COAXIAL IN** or **OPTICAL IN**) have been assigned, HDMI input is automatically selected as a priority.
- ▶ **COAX:**
This can be selected when **COAXIAL IN** has been assigned as an input source. If both coaxial and HDMI inputs have been assigned, coaxial input is automatically selected as a priority.
- ▶ **OPT:**
This can be selected when **OPTICAL IN** has been assigned as an input source. If both optical and HDMI inputs have been assigned, optical input is automatically selected as a priority.
- ▶ **Multich:**
The AV receiver always outputs analog signals from multichannel analog input.
- ▶ **Analog:**
The AV receiver always outputs analog signals.

Note

- The setting is stored individually for each input selector.
- This setting can be made only for the input source that is assigned as **HDMI IN**, **COAXIAL IN**, or **OPTICAL IN**.
- To select the digital audio input, see “Digital Audio Input” for more detail (→ 50).
- To select “**Multich**”, you must assign the multichannel input (→ 50).
- *¹ You can select “**ARC**” if you select the **TV/CD** input selector. But you cannot select it if you’ve selected “**Off**” in the “**Audio Return Channel**” setting (→ 65).

Setting the Incoming Digital Signal (Fixed Mode)

By pressing **ENTER** while selecting “**HDMI**”, “**COAX**”, “**OPT**” in the “**Audio Selector**”, you can specify the input signal in the Fixed Mode. Pressing **ENTER** again allows you to return to the “**Audio Selector**” setting.

Normally, the AV receiver detects the signal format automatically. However, if you experience either of the following issues when playing PCM or DTS material, you can manually set the signal format to PCM or DTS.

- If the beginnings of tracks from a PCM source are cut off, try setting the format to PCM.
- If noise is produced when fast forwarding or reversing a DTS CD, try setting the format to DTS.

■ Fixed Mode

▶ Auto:

The format is detected automatically. If no digital input signal is present, the corresponding analog input is used instead.

▶ PCM:

Only 2-channel PCM format input signals will be heard. If the input signal is not PCM, the **PCM** indicator will flash and noise may also be produced.

▶ DTS:

Only DTS (but not DTS-HD) format input signals will be heard. If the input signal is not DTS, the **DTS** indicator will flash and there will be no sound.

Note

- The setting is stored individually for each input selector.
- The setting will be reset to “**Auto**” when you change the setting in the “**Audio Selector**” (→ **68**).

About NET

The AV receiver is *network-ready*, which means you can hook it up to your home network with a standard Ethernet cable and enjoy the music files stored on your computer or media server. If your network is connected to the Internet, you can also enjoy Internet radio.

Network Requirements

■ Ethernet Network

For best results, a 100Base-TX switched Ethernet network is recommended. Although it's possible to play music on a computer that's connected to the network wirelessly, playback may be unreliable, so wired connections are recommended.

■ Ethernet Router

A router manages the network, routing data and supplying IP addresses. Your router must support the following:

- NAT (Network Address Translation). NAT allows several networked computers to access the Internet simultaneously via a single Internet connection. The AV receiver needs Internet access for Internet radio.
- DHCP (Dynamic Host Configuration Protocol). DHCP supplies IP addresses to network devices, allowing them to configure themselves automatically.
- A router with a 100Base-TX switch built-in is recommended.

Some routers have a modem built-in, and some ISPs require you to use specific routers. Please consult your ISP or computer dealer if you're unsure.

■ CAT5 Ethernet cable

Use a shielded CAT5 Ethernet cable (straight-type) to connect the AV receiver to your home network.

■ Internet Access (for Internet radio)

To receive Internet radio, your Ethernet network must have Internet access. A narrowband Internet connection (e.g., 56K modem, ISDN) will not provide satisfactory results, so a broadband connection is strongly recommended (e.g., cable modem, xDSL modem, etc). Please consult your ISP or computer dealer if you're unsure.

Note

- To receive Internet radio with the AV receiver, your broadband Internet connection must be working and able to access the Web. Consult your ISP if you have any problems with your Internet connection.
- The AV receiver uses DHCP to configure its network settings automatically. If you want to configure these settings manually, see "Network Settings" (→ 76).
- The AV receiver does not support PPPoE settings, so if you have a PPPoE-type Internet connection, you must use a PPPoE-compatible router.
- Depending on your ISP, you may need to specify a proxy server to use Internet radio. If your computer is configured to use a proxy server, use the same settings for the AV receiver (→ 76).

Connecting the AV Receiver

To connect the AV receiver to your home network, plug one end of a shielded CAT5 Ethernet cable into the AV receiver's **ETHERNET** port, and plug the other end into a LAN port on your router or switch.

The following diagram shows how you can connect the AV receiver to your home network. In this example, it's connected to a LAN port on a router, which has a 4-port 100Base-TX switch built-in.

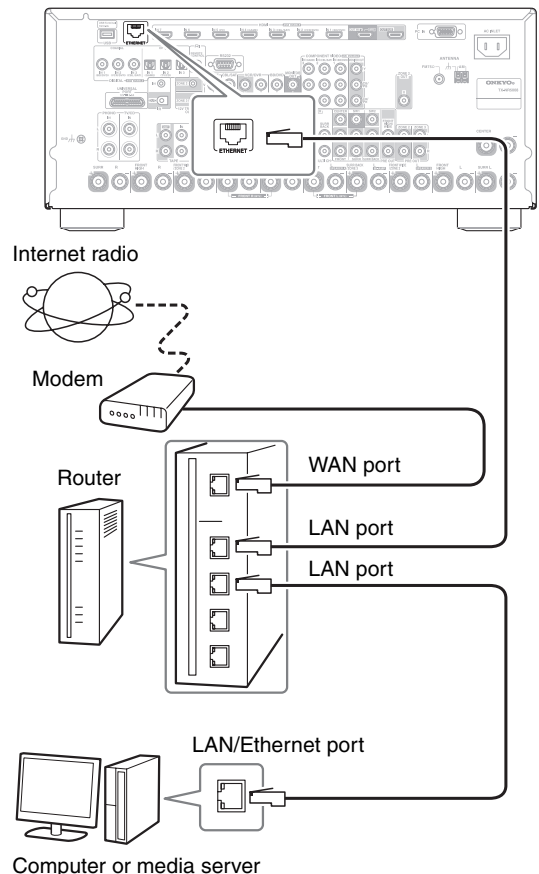

Listening to Internet Radio

To receive Internet radio, you must connect the AV receiver to a network with Internet access (→ 70). You can select Internet radio stations by connecting to the AV receiver from your computer and selecting stations in your Web browser. Preset up to 40 Internet radio stations. Internet radio URLs in the following formats are supported: PLS, M3U, and podcast (RSS). However, depending on the type of data or audio format used by the Internet radio station, you may not be able to listen to some stations.

Note

- If you're using a narrowband Internet connection (e.g., 56K modem or ISDN), depending on the station, Internet radio may not work satisfactorily. For best results, use a broadband connection (e.g., cable modem, xDSL modem, etc).

Listening to vTuner Internet Radio

This unit includes the full vTuner Internet Radio Service at no additional charge. Once you have connected your unit to the Internet you can select vTuner Internet Radio to search for and play Internet radio stations and podcasts at any time. To enhance your Internet radio experience, the <http://onkyo.vtuner.com/portal> is available to you as an easy way to browse to find stations, set up/organize your favorites, add your own stations, get help, etc. After the first time you try Internet radio/vTuner on your unit you can use the MAC Address of your unit to create a member login account (email address and password) on the <http://onkyo.vtuner.com/portal>. To verify your MAC Address, please see "Network Settings" (→ 76).

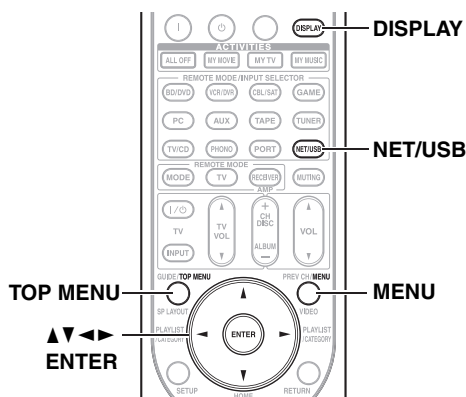

1 Press NET/USB repeatedly to select the Internet Radio screen.

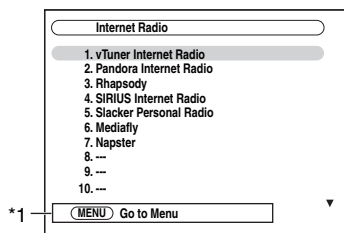

The **NETWORK** indicator lights (→ 9).

Note

- When the **NETWORK** indicator flashes, confirm that the Ethernet cable is firmly connected to the AV receiver.
- Services available may vary depending on the region. See the separate instructions for more information.

*1 MENU:

When menu operations are enabled, "MENU" appears. Press **MENU** to display the menu.

2 Use ▲/▼ to select "1. vTuner Internet Radio", and then press ENTER.

3 Use ▲/▼ to select a program, and then press ENTER.

Playback starts and the following screen appears.

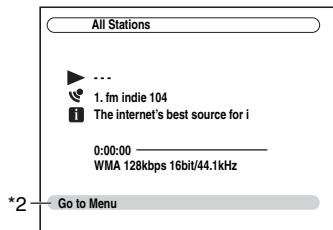

*2 Press **MENU** to allow selection from the following menu items.

▶ Stations like this:

Stations like the one currently being played back are displayed.

▶ Add this station to preset:

Add a station to the list.

Press **TOP MENU** to go to the top menu of the Internet Radio services.

Tip

- If you press **DISPLAY**, you can toggle between the playback screen and the list screen.

Listening to Other Internet Radio

To listen to other internet radio stations, insert the following step after step 1 in the "Listening to vTuner Internet Radio".

1 On your computer, start your Web browser and enter the AV receiver's IP address in the browser's Internet address (URL) field.

The browser connects to the AV receiver (WEB Setup Menu).

Note

- The AV receiver's IP address is shown on the "Network" screen (→ 76).
- If you're using DHCP, your router may not always allocate the same IP address to the AV receiver, so if you find that you can't connect to the AV receiver, recheck the AV receiver's IP address on the "Network" screen.

2 Click on the "Preset Internet Radio" tab.

3 Enter the preset name and Internet address (URL).

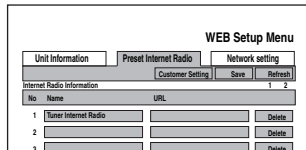

4 Click "Save" to save the Internet radio station.

Registering Presets*1

Once you've added a station to the list, simply select it on the Internet Radio screen, and then press **ENTER** to start playback.

*1 From the search results you can preset the stations and songs but cannot listen to them directly.

■ Items on the Internet Radio Top Menu

- ▶ Create new preset:
Add a favorite station or Internet Radio to the presets.
- ▶ Rename this preset:
You can rename the preset.
- ▶ Delete this preset:
This will delete the preset.

■ Station and Song Presets

You can add the currently playing song or station to the presets.

1. Press **MENU** with the station selected or while a song is playing.
2. Use **▲/▼** to select "Add this station to preset", and press **ENTER**.

Playing Music Files on a Server

This section explains how to play music files on a computer or media server through the AV receiver. See "Supported Audio File Formats" to "About DLNA" for details on supported music servers and music file formats.

For Windows Media Player 11, see "Windows Media Player 11 Setup" (→ 73).

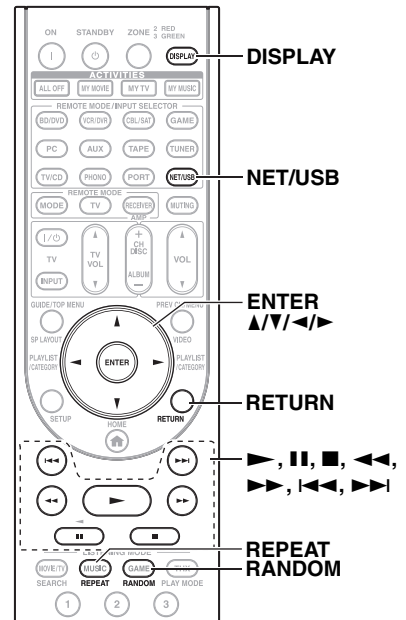

1 Start your computer or media server.

2 Press NET/USB to select the "Server" screen.

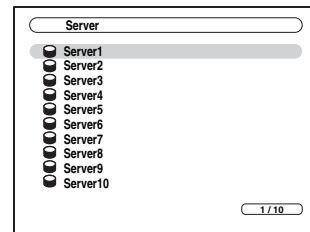

The **NETWORK** indicator lights (→ 9).

Note

- When the **NETWORK** indicator flashes, confirm the network connection.
- To update the screen, press **RETURN**.

3 Use ▲/▼ to select a server, and then press ENTER.

A list of items on the server appears.

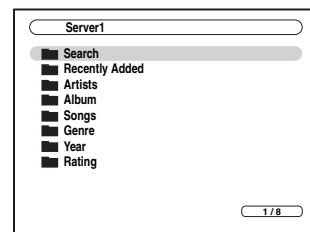

Search

You can search for music by Artist, Album, or Track.

Note

- The search function does not work with media servers which do not support this function.
- Depending on the sharing settings in the media server, the AV receiver may not be able to access the content. Refer to the instruction manual of the media server.

4 Use ▲/▼ to select an item, and then press ENTER.

A list of music files appears.

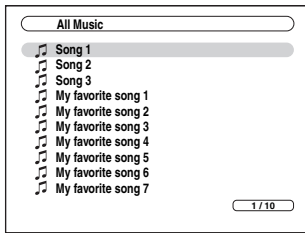

5 Use ▲/▼ to select a music file, and press ENTER or ► to start playback.

Playback starts and the following screen appears.

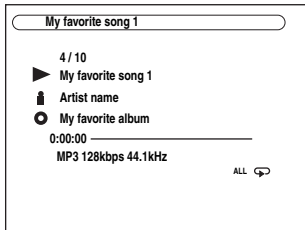

- To return to the previous menu during playback, press **RETURN**.
- To stop playback, press **■**.
- To select the next song, press **▶▶I**. To select the beginning of the current song, press **I◀◀**. To select the previous song, press **I◀◀** twice.
- To pause playback, press **II**. To fast forward the current song, press **▶▶▶**. To fast reverse the current song, press **◀◀◀**.

Tip

- If you press **DISPLAY**, you can toggle between the playback screen and the list screen.

Note

- For some sort of media server, Fast Forward/Fast Reverse/Pause operations do not work.

Random Playback

The Random function can only be set while the **PLAY** screen is displayed.

To play songs in random order, during playback (or while playback is paused or stopped), press **RANDOM**. All of the songs in the current folder will be played in random order. When all of the songs in the folder have been played once, they'll all be played again in a different random order. To cancel random playback, press **RANDOM** again.

Random playback supports up to 20000 songs per folder. If a folder contains more than this, songs over 20000 are not included in random playback.

Repeat Playback

The Repeat function can only be set while the **PLAY** screen is displayed.

To play songs repeatedly, during playback (or while playback is paused or stopped), press **REPEAT** repeatedly to select: Repeat I, Repeat Folder, Repeat All, or Off.

In Repeat I mode, the current song is played repeatedly.

In Repeat Folder mode, all of the songs in the current folder are played repeatedly.

In Repeat All mode, all of the songs on the current server are played repeatedly.

To cancel repeat playback, press **REPEAT** repeatedly to select Off.

Note

- If the message "**No Item.**" appears, this means that no information can be retrieved from the server. In this case, check your server, network, and AV receiver connections.

Windows Media Player 11 Setup

This section explains how to configure Windows Media Player 11 so that the AV receiver can play the music files stored on your computer.

1 Start Windows Media Player 11.

2 On the Library menu, select Media Sharing.

The Media Sharing dialog box appears.

3 Select the Share my media check box, and then click OK.

4 Select the AV receiver in the list, and then click Allow.

5 Click OK to close the dialog box.

This completes the Windows Media Player 11 configuration.

You can now play the music files in your Windows Media Player 11 library through the AV receiver (→ 72).

Note

- Windows Media Player 11 can be downloaded for free from the Microsoft Web site.

Supported Audio File Formats

For server playback, the AV receiver supports the following music file formats: MP3, WMA, WAV, FLAC, Ogg Vorbis, AAC and LPCM. Not all servers support all formats.

■ MP3

- MP3 files must be MPEG-1/MPEG-2 Audio Layer 3 format with a sampling rate of 8 kHz, 11.025 kHz, 12 kHz, 16 kHz, 22.05 kHz, 24 kHz, 32 kHz, 44.1 kHz, 48 kHz and a bit-rate of between 8 kbps and 320 kbps. Incompatible files cannot be played.
- Number of channels: 2
- Variable bit-rate (VBR) MP3 files are supported. (Playing times may not display correctly.)
- MP3 files must have a “.mp3” or “.MP3” filename extension.

■ WMA

WMA stands for Windows Media Audio and is an audio compression technology developed by Microsoft Corporation. Audio can be encoded in WMA format by using Windows Media® Player.

- WMA files must have the copyright option turned off.
- Sampling rates of 8 kHz, 11.025 kHz, 12 kHz, 16 kHz, 22.05 kHz, 24 kHz, 32 kHz, 44.1 kHz, 48 kHz and bitrates of between 5 kbps and 320 kbps, and WMA DRM are supported. Incompatible files cannot be played.
- Number of channels: 2
- Variable bit-rates (VBR) are supported. (Playing times may display incorrectly with VBR.)
- WMA Pro/Voice formats are not supported.
- WMA files must have a “.wma” or “.WMA” filename extension.

■ WMA Lossless

- Sampling rates of 44.1 kHz, 48 kHz, 88.2 kHz, 96 kHz and bitrates of between 5 kbps and 320 kbps are supported. Incompatible files cannot be played.
- Quantization bit: 16 bit, 24 bit
- Number of channels: 2
- Variable bit-rates (VBR) are supported. (Playing times may display incorrectly with VBR.)
- WMA files must have a “.wma” or “.WMA” filename extension.

■ WAV

WAV files contain uncompressed PCM digital audio.

- Sampling rates of 8 kHz, 11.025 kHz, 12 kHz, 16 kHz, 22.05 kHz, 24 kHz, 32 kHz, 44.1 kHz, 48 kHz, 64 kHz, 88.2 kHz, and 96 kHz are supported. Incompatible files cannot be played.
- Quantization bit: 8 bit, 16 bit, 24 bit
- Number of channels: 2
- WAV files must have a “.wav” or “.WAV” filename extension.

■ AAC

AAC stands for MPEG-2/MPEG-4 Audio.

- Sampling rates of 8 kHz, 11.025 kHz, 12 kHz, 16 kHz, 22.05 kHz, 24 kHz, 32 kHz, 44.1 kHz, 48 kHz, 64 kHz, 88.2 kHz, 96 kHz and bitrates of between 8 and 320 kbps, are supported. Incompatible files cannot be played.
- Number of channels: 2
- Variable bit-rate (VBR) files are supported. (Playing times may not display correctly.)
- AAC files must have a “.aac”, “.m4a”, “.mp4”, “.3gp”, “.3g2”, “.AAC”, “.M4A”, “.MP4”, “.3GP” or “.3G2” filename extension.

■ FLAC

FLAC is a file format for lossless audio data compression.

- Sampling rates of 8 kHz, 11.025 kHz, 12 kHz, 16 kHz, 22.05 kHz, 24 kHz, 32 kHz, 44.1 kHz, 48 kHz, 64 kHz, 88.2 kHz, and 96 kHz are supported. Incompatible files cannot be played.
- Quantization bit: 8 bit, 16 bit, 24 bit
- Number of channels: 2
- Variable bit-rates (VBR) are supported. (Playing times may display incorrectly with VBR.)
- FLAC files must have a “.flac” or “.FLAC” filename extension.

Note

- Not all servers support all formats.

■ Ogg Vorbis

- Sampling rates of 8 kHz, 11.025 kHz, 12 kHz, 16 kHz, 22.05 kHz, 24 kHz, 32 kHz, 44.1 kHz, 48 kHz and bitrates of between 48 kbps and 500 kbps are supported. Incompatible files cannot be played.
- Number of channels: 2
- Variable bit-rates (VBR) are supported. (Playing times may display incorrectly with VBR.)
- Ogg Vorbis files must have a “.ogg” or “.OGG” filename extension.

■ LPCM (Linear PCM)

- Sampling rates of 8 kHz, 11.025 kHz, 12 kHz, 16 kHz, 22.05 kHz, 24 kHz, 32 kHz, 44.1 kHz, 48 kHz, 64 kHz, 88.2 kHz, and 96 kHz are supported.
- Quantization bit: 8 bit, 16 bit, 24 bit
- Number of channels: 2

Server Requirements

The AV receiver can play digital music files stored on a computer or media server and supports the following technologies:

- Windows Media Player 11
- Windows Media Connect 2.0
- DLNA-certified media server

If the operating system of your computer is Windows Vista, Windows Media Player 11 is already installed.

Windows Media Player 11 for Windows XP can be downloaded for free from the Microsoft Web site.

- The computer or media server must be on the same network as the AV receiver.
- Each folder may contain up to 20000 music files, and folders may be nested up to 16 levels deep.

Note

- For some sort of media server, the AV receiver may not be able to recognize it, or may not be able to play stored music files.

Minimum system requirements for Windows Media Player 11 for Windows XP

Operating system

Windows XP Home Edition (SP2), Windows XP Professional (SP2), Windows XP Tablet PC Edition (SP2), Update Rollup 2 for Windows XP Media Center Edition 2005 (KB900325), October 2006 Update Rollup for Windows XP Media Center Edition (KB925766)

Processor:	233 MHz Intel Pentium II, Advanced Micro Devices (AMD), etc.
Memory:	64 MB
Hard disk:	200 MB of free space
Drive:	CD or DVD drive
Modem:	28.8 kbps
Sound card:	16-bit sound card
Monitor:	Super VGA (800 x 600)
Video card:	64 MB VRAM, DirectX 9.0b
Software:	Microsoft ActiveSync (only when using a Windows Mobile-based Pocket PC or smartphone)
Web browser:	Microsoft Internet Explorer 6 or Netscape 7.1

About DLNA

The Digital Living Network Alliance is an international, cross-industry collaboration. Members of DLNA develop a concept of wired and wireless interoperable networks where digital content such as photos, music, and videos can be shared through consumer electronics, personal computers, and mobile devices in and beyond the home. The AV receiver certifies the DLNA Interoperability Guidelines version 1.5.

Remote Playback from Media Server/ Personal Computer

Remote Playback means you can play the music files stored on the DLNA-certified device such as media server with this product by operating the controller device in the home network.

Server Requirements

- Windows Media Player 12
- DLNA-certified (the DLNA Interoperability Guidelines version 1.5) media server or controller device

Setting varies depending on the device. Refer to your device's instruction manual for details.

If the operating system of your personal computer is Windows 7, Windows Media Player 12 is already installed.

For more information, see the Microsoft Web site.

Supported Music File Formats

See "Supported Audio File Formats" (→ 74).

Note

- For remote playback, this product does not support the following music file formats: FLAC and Ogg Vorbis.

Windows Media Player 12 Setup

This section explains how to configure Windows Media Player 12 so that the product can play the music files stored on your personal computer.

- 1 Start Windows Media Player 12.**
- 2 On the "Stream" menu, select "Turn on media streaming".**
A dialog box appears.
- 3 Move your cursor and click on "Turn on media streaming".**
A list of media server appears. Wording may vary slightly depending on the network location.
- 4 Select the product in the list, and then click "Allowed".**
- 5 Click "OK" to close the dialog box.**
This completes the Windows Media Player 12 configuration.
You can now play the music files in your Windows Media Player 12 library through the product.

1 Start Windows Media Player 12.

Before remote playback, setup on Windows Media Player 12 is required.

2 On the product, press **NET/USB** to select the server screen.

A list of media server appears.

Tip

- The **NETWORK** indicator on the product's display lights up. When it flashes, confirm the network connection.

Note

- While the music files on another media server are being played, remote playback cannot be used. Stop playback on another media server.

3 On Windows Media Player 12, right-click on music file.

Right-click menu appears. For selecting another media server, select media server from "Other Libraries" menu on Windows Media Player 12.

4 Select the product from right-click menu.

"Play to" window appears and playback on the product starts. Operations during remote playback can be made from "Play to" window of Windows 7 on your personal computer. During remote playback, operations (such as Playback, Pause, Fast Forward, Fast Rewind, Previous, Next, Repeat, Random) cannot be made on the product.

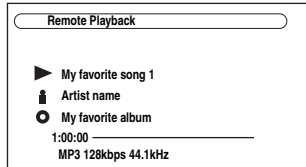

Tip

- To stop playback and return to the previous menu during remote playback, press **RETURN** on the product or remote controller. To stop playback during remote playback, press Stop [■] on the remote controller.

5 Adjusting the Volume

You can adjust the volume of your AV receiver by adjusting the volume bar in the "**Remote playback**" window. The default maximum volume for the AV receiver is 82 (0dB). If you wish to change this, enter the maximum volume value from the WEB Setup Menu in your browser. See "Listening to Other Internet Radio" for WEB Setup menu information (→ 71).

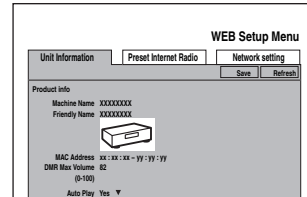

The volume value of the remote window and the volume value of the AV receiver may not always match. Adjustments you make to the volume in the AV receiver will not be reflected in the "**Remote playback**" window.

Network Settings

Note

- When modifying network settings, after modifying it is necessary to execute "Save".

This section explains how to configure the AV receiver's network settings manually.

If your router's DHCP server is enabled, you don't need to change any of these settings, as the AV receiver is set use DHCP to configure itself automatically by default (i.e., DHCP is set to Enable). If, however, your router's DHCP server is disabled, for example, you're using static IP addresses, you'll need to configure these settings yourself, in which case, a knowledge of Ethernet networking is essential.

What's DHCP?

DHCP (Dynamic Host Configuration Protocol) is used by routers, computers, the AV receiver, and other devices to automatically configure themselves on a network.

What's DNS?

The DNS (Domain Name System) translates domain names into IP addresses. For example, when you enter a domain name such as *www.onkyousa.com* in your Web browser, before accessing the site, your browser uses DNS to translate this into an IP address, in this case 63.148.251.142.

1 Press **RECEIVER** followed by **SETUP**.

The main menu appears onscreen.

Tip

- If the main menu doesn't appear, make sure the appropriate external input is selected on your TV.

2 Use ▲/▼ to select “Hardware Setup”, and then press ENTER.

The “Hardware Setup” menu appears.

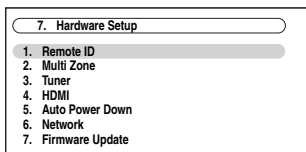

3 Use ▲/▼ to select “Network”, and then press ENTER.

The “Network” screen appears.

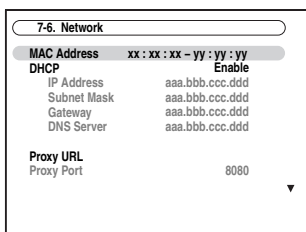

4 Use ▲/▼ to select the setting, and use ◀/▶ to set them.

To enter an IP address, select the setting, and then press ENTER. The arrow can then be used to enter numbers. Press ENTER again to set the number.

The settings are explained below.

5 When you’ve finished, press RETURN.

The save confirmation screen appears.

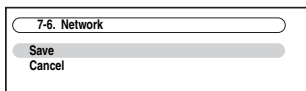

6 Use ▲/▼ to select “Save”, and then press ENTER.

When modifying network settings, after modifying it is necessary to execute “Save”.

7 When you’ve finished, press SETUP.

The setup menu closes.

Note

- This procedure can also be performed on the AV receiver by using **SETUP**, arrows, and **ENTER**.

■ Mac Address

This is the AV receiver’s MAC (Media Access Control) address. This address cannot be changed.

■ DHCP

This setting determines whether or not the AV receiver uses DHCP to automatically configure its IP Address, Subnet Mask, Gateway, and DNS Server settings.

- ▶ **Enable:**
DHCP enabled.
- ▶ **Disable:**
DHCP disabled.

If you select “Disable”, you must configure the “IP Address”, “Subnet Mask”, “Gateway”, and “DNS Server” settings yourself.

■ IP Address

If you set the “DHCP” setting to “Disable”, you must specify an IP address. Enter a static IP address provided by your ISP.

The IP address must be within the following ranges.

- ▶ Class A:
10.0.0.0 to 10.255.255.255
- ▶ Class B:
172.16.0.0 to 172.31.255.255
- ▶ Class C:
192.168.0.0 to 192.168.255.255

Most routers use Class C IP addresses.

■ Subnet Mask

If you set the “DHCP” setting to “Disable”, you must specify a subnet mask address.

Enter the subnet mask address provided by your ISP (typically: 255.255.255.0).

■ Gateway

If you set the “DHCP” setting to “Disable”, you must specify a gateway address.

Enter the gateway address provided by your ISP.

■ DNS Server

If you set the “DHCP” setting to “Disable”, you must specify a DNS server.

Enter the DNS server addresses provided by your ISP.

■ Proxy URL

To use a Web proxy, enter its URL here.

■ Proxy Port

If you’re using a Web proxy, enter a proxy port number here.

■ Control

This setting enables or disables control over the network.

- ▶ **Enable:**
Control over the network enabled.
- ▶ **Disable:**
Control over the network disabled.

Note

- When set to “Enable”, power consumption on standby mode increases.

■ Port Number

This is the network port used for control over the network.

Note

- Set the port number between from “49152” to “65535”.

About USB

USB can be used to play music files stored on USB mass storage devices (e.g., USB flash drives and MP3 players), which can be plugged into the AV receiver's **USB** port.

See “Controlling iPod” for iPod connection (→ 86).

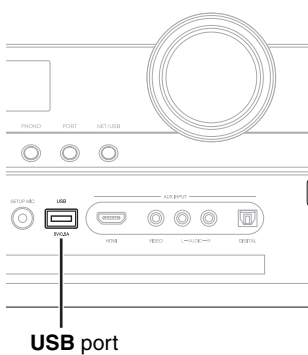

(TX-NR5008) USB port

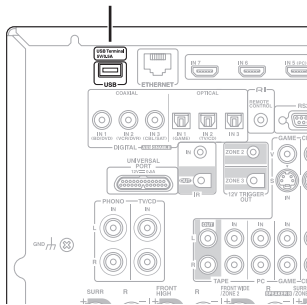

Supported Audio File Formats

For USB mass storage device playback, the AV receiver supports music file formats.

See “Supported Audio File Formats” (→ 74).

USB Mass Storage Device Requirements

- The AV receiver supports USB devices that support the USB mass storage device class.
- Playback may not be possible with some USB devices even if they conform to the USB mass storage device class.
- USB devices formatted with the FAT16 or FAT32 file system are supported.
- If the storage device has been partitioned, each section will be treated as an independent device.
- Each folder may contain up to 20000 music files and folders, and folders may be nested up to 16 levels deep.
- USB hubs and USB devices with hub functions are not supported.

Playing Music Files on a USB Device

This section explains how to play music files on a USB mass storage device.

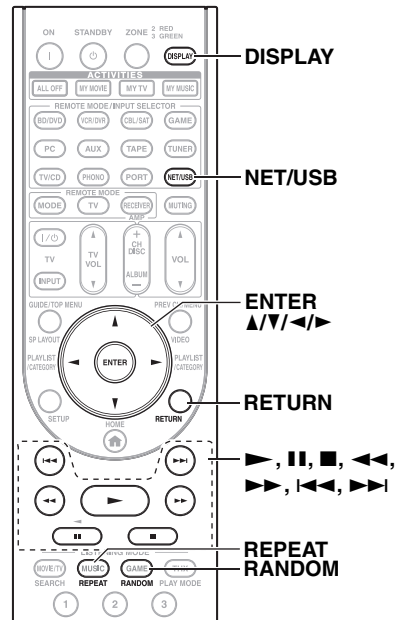

1 Plug your USB mass storage device into the AV receiver's **USB** port.

2 (TX-NR5008)
Press **NET/USB** repeatedly to select the “USB(Front)” or “USB(Rear)” screen.

(TX-NR3008)

Press **NET/USB** repeatedly to select the “USB” screen.

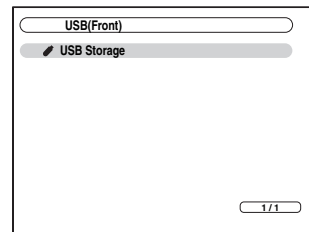

The **USB** indicator lights (→ 9) if the AV receiver is able to read the USB mass storage device. The **USB** indicator flashes if the AV receiver cannot read the USB mass storage device.

3 Use **▲/▼** to select a USB mass storage device, and then press **ENTER**.

A list of the device's contents appears.

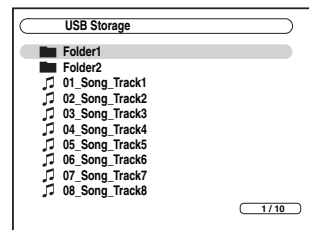

To open a folder, use **▲/▼** to select it, and then press **ENTER**.

4 Use ▲/▼ to select a music file, and press ENTER or ► to start playback.

Playback starts and the following screen appears.

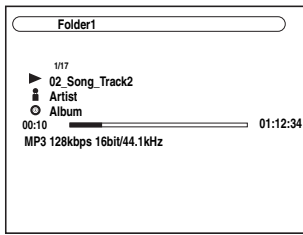

- To return to the previous menu during playback, press **RETURN**.
- To stop or pause playback, press ■ or ■■, respectively.
- To select the next song, press ►►. To select the beginning of the current song, press ◀◀◀. To select the previous song, press ◀◀◀ twice.
- To fast forward the current song, press ►►►. To fast reverse the current song, press ◀◀◀.

Tip

- If you press **DISPLAY**, you can toggle between the playback screen and the list screen.

Random Playback

The Random function can only be set while the **PLAY** screen is displayed.

To play songs in random order, while the list of songs is displayed, press **RANDOM**. All of the songs in the current folder will be played in random order. When all of the songs in the folder have been played once, they'll all be played again in a different random order. To cancel random playback, press **RANDOM** again.

Random playback supports up to 20,000 songs per folder. If a folder contains more than this, songs over 20,000 are not included in random playback.

Repeat Playback

The Repeat function can only be set while the **PLAY** screen is displayed.

To play songs repeatedly, during playback (or while playback is paused or stopped), press **REPEAT** repeatedly to select: Repeat1, Repeat Folder, Repeat All, or Off.

In Repeat1 mode, the current song is played repeatedly.

In Repeat Folder mode, all of the songs in the current folder are played repeatedly.

In Repeat All mode, all of the songs on the USB mass storage device (in the same partition) are played repeatedly.

To cancel repeat playback, press **REPEAT** repeatedly to select Off.

Note

- If you connect a USB hard disk drive to the AV receiver's **USB** port, we recommend that you use its **AC** adapter to power it.
- Do not connect the AV receiver's **USB** port to a **USB** port on your computer. Music on your computer cannot be played through the AV receiver in this way.
- The AV receiver supports USB MP3 players that support the USB Mass Storage Class standard, which allows USB storage devices to be connected to computers without the need for special drivers or software. Note that not all USB MP3 players support the USB Mass Storage Class standard. Refer your USB MP3 player's instruction manual for details.
- Protected WMA music files on an MP3 player cannot be played.
- Onkyo accepts no responsibility whatsoever for the loss or damage to data stored on a USB mass storage device when that device is used with the AV receiver. We recommend that you back up your important music files beforehand.
- MP3 players containing music files that are managed with special music software.
- Operation with all USB mass storage devices including the ability to power them is not guaranteed.
- Do not connect your USB mass storage device via a USB hub. The USB mass storage device must be connected directly to the AV receiver's **USB** port.
- If the USB mass storage device contains a lot of data, the AV receiver may take a while to read it.
- USB memory devices with security functions cannot be played.

Multi Zone

In addition to your main listening room, you can also enjoy playback in the other room, or as we call Multi Zone. And, you can select a different source for each room.

Connecting Zone 2

There are two ways you can connect Zone 2 speakers:

1. Connect them directly to the AV receiver.
2. Connect them to an amp in Zone 2.

Connecting Your Zone 2 Speakers Directly to the AV receiver

This setup allows 7.2-channel playback in your main room and 2-channel stereo playback in Zone 2, with a different source in each room. This is called Powered Zone 2, as the Zone 2 speakers are powered by the AV receiver. Note that when Powered Zone 2 is turned off, you can enjoy 9.2-channel playback in your main room.

To use this setup, you must set the “Powered Zone 2” setting to “Act” (→ 82).

Hookup

- Connect your Zone 2 speakers to the AV receiver’s **FRONT WIDE/ZONE 2 L/R** terminals.

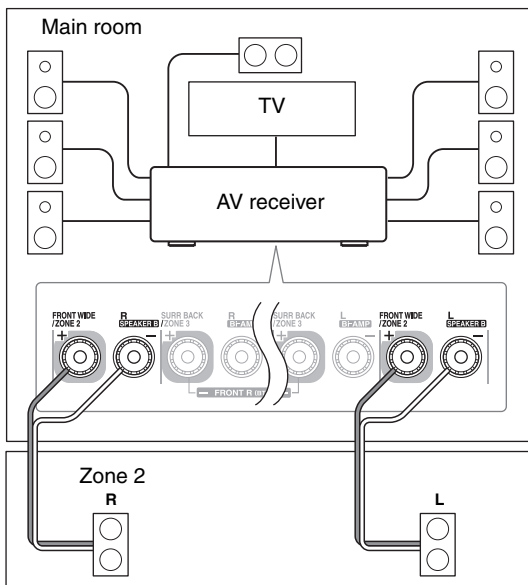

Note

- With this setup, the Zone 2 volume is controlled by the AV receiver.
- Powered Zone 2 cannot be used if “Speakers Type(Front B)” is set to “Normal”, “Bi-Amp” or “BTL” (→ 51).
- This setting cannot be used if “Front High + Front Wide” setting is set to “Yes”.

Connecting Your Zone 2 Speakers to an Amp in Zone 2

This setup allows 9.2-channel playback in your main listening room and 2-channel stereo playback in Zone 2, with a different source in each room.

Hookup

- Use an RCA audio cable to connect the AV receiver’s **ZONE 2 PRE OUT L/R** jacks to an analog audio input on your Zone 2 amp.
- Connect your Zone 2 speakers to the speaker terminals on your Zone 2 amp.

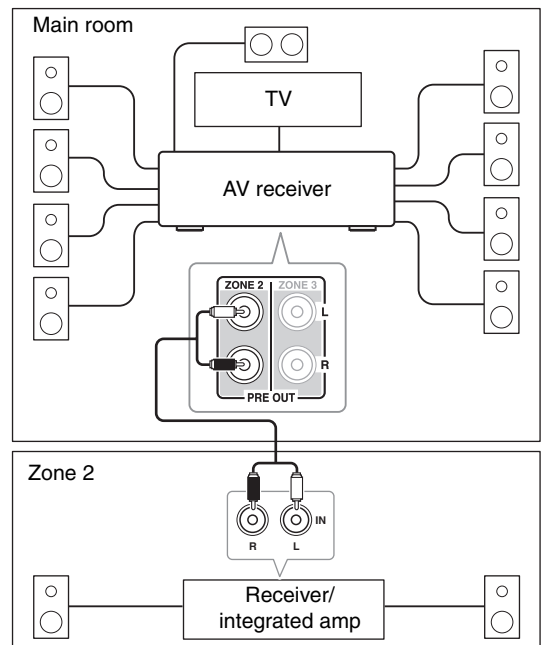

Note

- With the default settings, the Zone 2 volume must be set on the Zone 2 amp. If your Zone 2 amp has no volume control, set the “Zone 2 Out” setting to “Variable” so that you can set the Zone 2 volume on the AV receiver (→ 83).

Zone 2 Video Output

The AV receiver features a composite video output for connection to a TV in Zone 2, so you can enjoy both audio and video in that zone.

Hookup

- Use a composite video cable to connect the AV receiver's **ZONE 2 OUT V** jack to a composite video input on your Zone 2 TV.

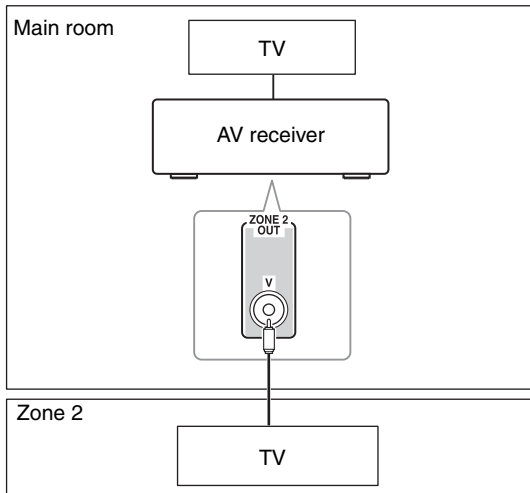

Note

- The **ZONE 2 OUT V** jack outputs video from components connected to composite video only.

Zone 2 12V Trigger

When Zone 2 is turned on, the output from the **ZONE 2 12V TRIGGER OUT** goes high (+12 volts, 150 milliamperes max). Connecting this jack to a 12-volt trigger input on a component in Zone 2 will make that component turn on or off as and when Zone 2 is turned on or off on the AV receiver.

Connecting Zone 3

There are two ways you can connect Zone 3 speakers:

- Connect them directly to the AV receiver.
- Connect them to an amp in Zone 3.

Connecting Your Zone 3 Speakers Directly to the AV receiver

This setup allows 7.2-channel playback in your main room and 2-channel stereo playback in Zone 3, with a different source in each room. This is called Powered Zone 3, as the Zone 3 speakers are powered by the AV receiver. Note that when Powered Zone 3 is turned off, you can enjoy 9.2-channel playback in your main room.

To use this setup, you must set the “Powered Zone 3” setting to “Act” (→ 82).

Hookup

- Connect your Zone 3 speakers to the AV receiver's **SURR BACK/ZONE 3 L/R** terminals.

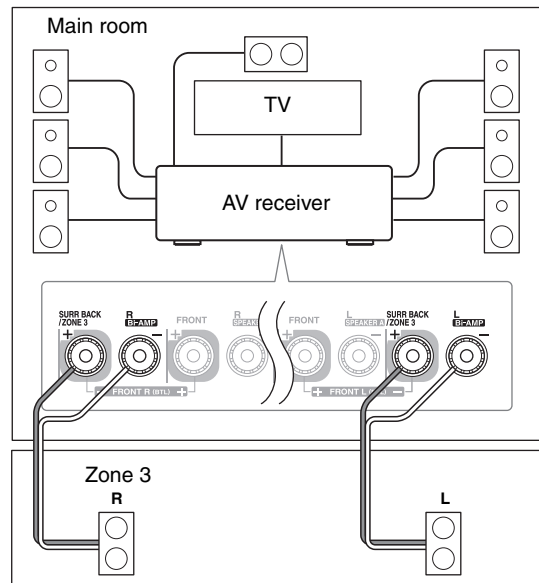

Note

- With this setup, the Zone 3 volume is controlled by the AV receiver.
- Powered Zone 3 cannot be used if “Speakers Type(Front A)” or “Speakers Type(Front B)” is set to “Bi-Amp” or “BTL” (→ 51).
- This setting cannot be used if the “Front High + Front Wide” setting is set to “Yes”.

Connecting Your Zone 3 Speakers to an Amp in Zone 3

This setup allows 9.2-channel playback in your main listening room and 2-channel stereo playback in Zone 3, with a different source in each room.

Hookup

- Use an RCA audio cable to connect the AV receiver's **ZONE 3 PRE OUT L/R** jacks to an analog audio input on your Zone 3 amp.
- Connect your Zone 3 speakers to the speaker terminals on your Zone 3 amp.

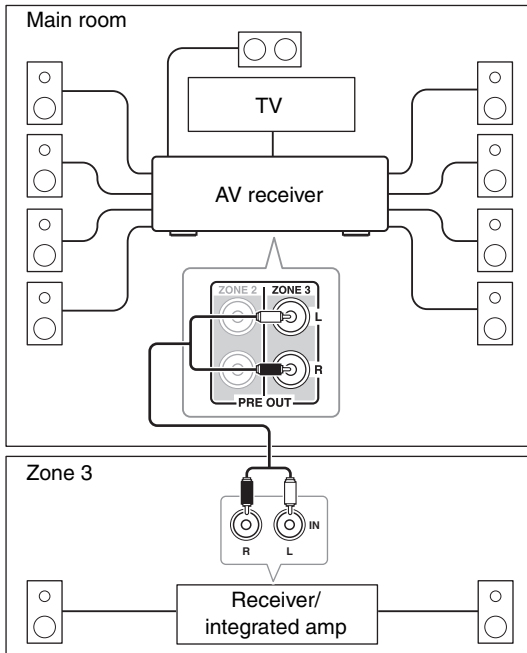

Note

- With the default settings, the Zone 3 volume must be set on the Zone 3 amp. If your Zone 3 amp has no volume control, set the “**Zone 3 Out**” setting to “**Variable**” so that you can set the Zone 3 volume on the AV receiver (→ 83).

Zone 3 12V Trigger

When Zone 3 is turned on, the output from the **ZONE 3 12V TRIGGER OUT** goes high (+12 volts, 25 milliamperes max). Connecting this jack to a 12-volt trigger input on a component in Zone 3 will make that component turn on or off as and when Zone 3 is turned on or off on the AV receiver.

Setting the Powered Zone 2/3

If you’ve connected your Zone 2/3 speakers to the AV receiver, as explained in “Connecting Your Zone 2 Speakers Directly to the AV receiver” (→ 80) or “Connecting Your Zone 3 Speakers Directly to the AV receiver” (→ 81), you must set the “**Powered Zone 2**” or “**Powered Zone 3**” setting to “**Act**” (Activated).

1 Press **RECEIVER** followed by **SETUP**.

The main menu appears onscreen.

Tip

- If the main menu doesn’t appear, make sure the appropriate external input is selected on your TV.

2 Use **▲/▼** to select “Speaker Setup”, and then press **ENTER**.

The “**Speaker Setup**” menu appears.

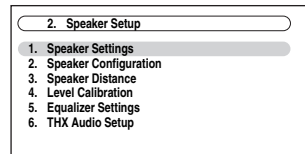

3 Use **▲/▼** to select “Speaker Settings”, and then press **ENTER**.

The “**Speaker Settings**” menu appears.

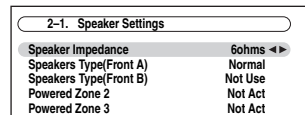

4 Use **▲/▼** to select “Powered Zone 2” or “Powered Zone 3”, and use **◀/▶** to select:

▶ **Not Act:**

FRONT WIDE/ZONE 2 L/R or **SURR BACK/ZONE 3 L/R** speaker terminals not activated (Powered Zone 2/3 disabled).

▶ **Act:**

FRONT WIDE/ZONE 2 L/R or **SURR BACK/ZONE 3 L/R** speaker terminals activated (Powered Zone 2/3 enabled).

5 Press **SETUP**.

The setup menu closes.

Note

- Powered Zone 2 cannot be used if “**Speakers Type(Front B)**” setting set to “**Normal**”, “**Bi-Amp**” or “**BTL**” (→ 51).
- Powered Zone 3 cannot be used if “**Speakers Type(Front A)**” or “**Speakers Type(Front B)**” setting set to “**Bi-Amp**” or “**BTL**” (→ 51).
- These setting cannot be used if the “**Front High + Front Wide**” setting is set to “**Yes**”.
- This procedure can also be performed on the AV receiver by using **SETUP**, arrows, and **ENTER**.

Setting the Multi Zone

1 Press RECEIVER followed by SETUP.

The main menu appears onscreen.

Tip

- If the main menu doesn't appear, make sure the appropriate external input is selected on your TV.

2 Use ▲/▼ to select “Hardware Setup”, and then press ENTER.

The “Hardware Setup” menu appears.

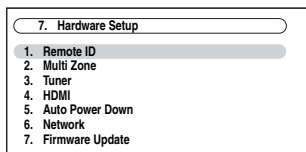

3 Use ▲/▼ to select “Multi Zone”, and then press ENTER.

The “Multi Zone” menu appears.

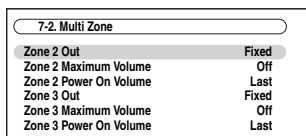

4 Use ▲/▼ to select an item, and use ◀/▶ to change it.

The items are explained below.

5 Press SETUP.

The setup menu closes.

Note

- This procedure can also be performed on the AV receiver by using **SETUP**, arrows, and **ENTER**.

■ Zone 2 Out, Zone 3 Out

▶ Fixed:

The Zone 2/3 volume must be set on the amp in that zone.

▶ Variable:

The Zone 2/3 volume can be set on the AV receiver.

If you've connected your Zone 2/3 speakers to an amp with no volume control, set the “Zone 2 Out” and “Zone 3 Out” setting, respectively, to “Variable” so that you can set the volume, balance, and tone of Zone 2/3 on the AV receiver.

■ Zone 2 Maximum Volume, Zone 3 Maximum Volume

▶ **Off**, 50 to 99 (Absolute display)

▶ **Off**, -32dB to +17dB (Relative display)

With this setting, you can limit the maximum volume for Zone 2/3.

■ Zone 2 Power On Volume, Zone 3 Power On Volume

▶ **Last**, Min, 1 to 99 or Max (Absolute display)

▶ **Last**, -∞dB, -81dB to +18dB (Relative display)

This setting determines what the volume will be for Zone 2/3 each time the AV receiver is turned on.

To use the same volume level as when the AV receiver was last turned off, select “Last”.

The “Zone 2 Power On Volume” and “Zone 3 Power On Volume” cannot be set higher than the “Zone 2 Maximum Volume” and “Zone 3 Maximum Volume” setting.

Using Zone 2/3

This section explains how to turn Zone 2/3 on and off, how to select an input source for Zone 2/3, and how to adjust the volume for Zone 2/3.

Controlling Zone 2/3 from the AV receiver

ZONE 3 indicator

ZONE 2 indicator

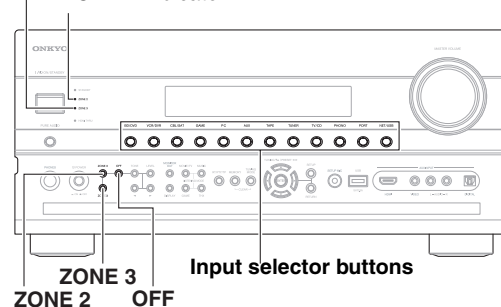

1 To turn on Zone 2/3 and select an input source, press ZONE 2 or ZONE 3 followed by an input selector button within 8 seconds.

Zone 2/3 turns on, the ZONE 2/3 indicator lights.

Tip

- ZONE 2/3 12V TRIGGER OUT goes high (+12 V).

To select AM or FM, press **TUNER** input selector and **ZONE 2** or **ZONE 3** repeatedly.

(North American models) You can also select SIR-IUS.

To select the same source as that of the main room, press **ZONE 2** or **ZONE 3** twice. “Zone 2 Selector: Source” or “Zone 3 Selector: Source” appears on the display.

2 To turn off Zone 2/3, press ZONE 2 or ZONE 3. ZONE 2 or ZONE 3 indicator flashes.

Press **OFF**.

The zone is turned off, and the ZONE 2 or ZONE 3 indicator goes off.

Note

- When Zone 2/3 is turned off, the output from the ZONE 2/3 12V TRIGGER OUT goes low (0 volts).

Controlling Zone 2/3 with the Remote Controller

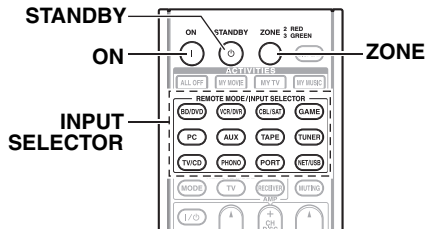

Note

- To control Zone 2/3, you must press the remote controller's **ZONE** first.
- **ZONE** turns red while Zone 2 is on, and green while Zone 3 is on.

1 Press **ZONE** repeatedly, then point the remote controller at the AV receiver and press **ON**.

Tip

- The **ZONE 2/3 12V TRIGGER OUT** goes high (+12 V).

2 To select an input source for Zone 2/3, press **ZONE** repeatedly, followed by **INPUT SELECTOR**.

To select AM or FM, press **TUNER** input selector and **ZONE** repeatedly.

(North American models) You can also select **SIRIUS**.

3 To turn off Zone 2/3, press **ZONE** repeatedly, followed by **STANDBY**.

Note

- Only analog input sources are output by the **ZONE 2/3 PRE OUT** and **FRONT WIDE/ZONE 2 L/R, SURR BACK/ZONE 3 L/R** terminals. Digital input sources are not output. If no sound is heard when an input source is selected, check if it's connected to an analog input.
- You cannot select different AM or FM radio stations for your main room and Zone 2/3. The same AM/FM radio station will be heard in each room. For example, if you have an FM station for the main room, that station will also be used in Zone 2.
- When you connect Zone 3 speakers directly to the AV receiver, listening modes that require surround back speakers such as Dolby EX, DTS-ES or THX Surround EX are unavailable.
- When the input selector of Zone 2/3 is selected, power consumption on standby mode slightly increases.
- While Zone 2/3 is on, **RI** functions will not work.

Adjusting the Volume for Zones

On the remote controller, press **ZONE** repeatedly, and then use **VOL ▲/▼**.

On the AV receiver, press **ZONE 2** or **ZONE 3** (the **ZONE 2/3** indicator and Zone 2/3 selector on the display flashes) and press **LEVEL** followed by **Up ►/Down ◀** within 8 seconds.

Muting Zones

On the remote controller, press **ZONE** repeatedly, and then press **MUTING**.

To unmute a zone, on the remote controller, press **ZONE**, and then press **MUTING** again.

Adjusting the Tone and Balance of Zones

1 On the AV receiver, press **ZONE 2** or **ZONE 3**.

2 Press the AV receiver's **TONE** repeatedly to select "Bass", "Treble" or "Balance".

3 Use **◀/▶** to adjust the bass, treble or balance.

- You can boost or cut the bass or treble from -10 dB to +10 dB in 2 dB steps.
- You can adjust the balance from 0 in the center to +10 dB to the right or +10 dB to the left in 2 dB steps.

Note

- Zones can also be unmuted by adjusting the volume.
- The Zone 2 volume, tone, and balance function have no effect on **ZONE 2 PRE OUT** when the "Zone 2 Out" setting is set to "Fixed" (→ 83) and "Powered Zone 2" setting is set to "Not Act" (→ 82).
- The Zone 3 volume, tone, and balance function have no effect on **ZONE 3 PRE OUT** when the "Zone 3 Out" setting is set to "Fixed" (→ 83) and "Powered Zone 3" setting is set to "Not Act" (→ 82).
- Even if you repeatedly press the remote controller's **ZONE** to select zones, the last zone selection will be retained once you have switched to other components by pressing other **REMOTE MODE** after pressing **ZONE**.

Using the Remote Controller in Zone 2/3 and Multiroom Control Kits

To control the AV receiver with the remote controller while you're in Zone 2 or Zone 3, you'll need a commercially available multiroom remote control kit for each zone.

- Multiroom kits are made by Niles and Xantech.

These kits can also be used when there isn't a clear line of sight to the AV receiver's remote sensor, such as when it's installed inside a cabinet.

Using a Multiroom Kit with Zone 2/3

In this setup, the IR receiver in Zone 2/3 picks up the infrared signals from the remote controller and feeds them through to the AV receiver in the main room via the connecting block.

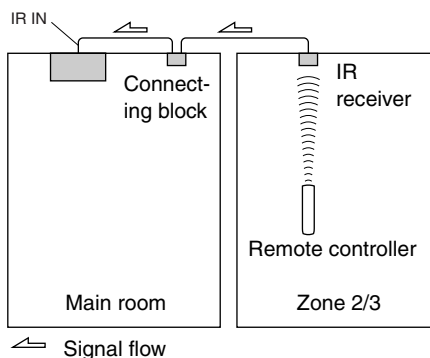

The miniplug cable from the connecting block should be connected to the AV receiver's **IR IN** jack, as shown below.

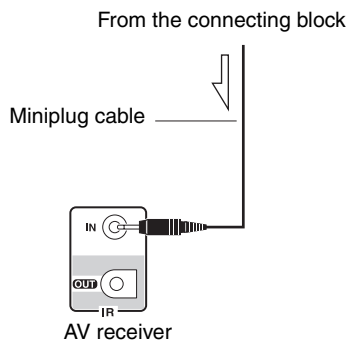

Using a Multiroom Kit with a Cabinet

In this setup, the IR receiver picks up the infrared signals from the remote controller and feeds them to the AV receiver located in the cabinet via the connecting block.

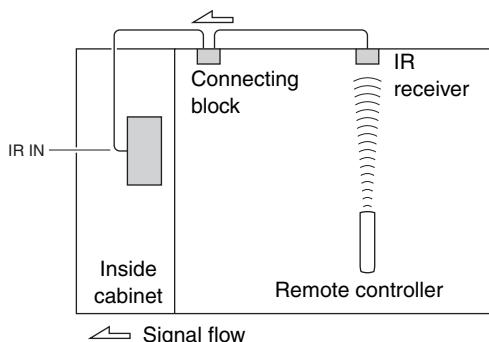

Using a Multiroom Kit with Other Components

In this setup, an IR emitter is connected to the AV receiver's **IR OUT** jack and placed in front of the other component's remote control sensor. Infrared signals received at the AV receiver's **IR IN** jack are fed through to the other component via the IR emitter. Signals picked up by the AV receiver's remote control sensor are not output.

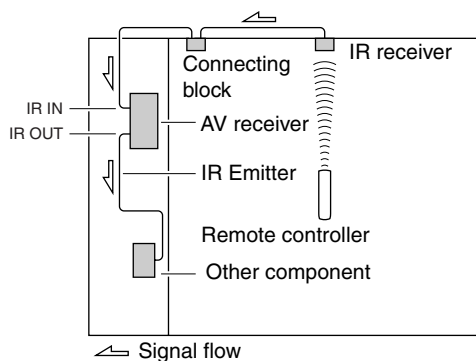

The IR emitter should be connected to the AV receiver's **IR OUT** jack, as shown below.

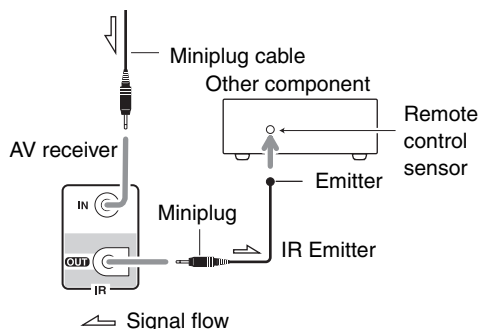

Controlling iPod

Connecting the iPod Directly to the USB Port

USB can be used to play music files stored on iPod/iPhone, which can be plugged into the AV receiver's **USB** port.

Note

- **(TX-NR5008)** Note that the rear-panel USB port does not support iPod/iPhone connection.

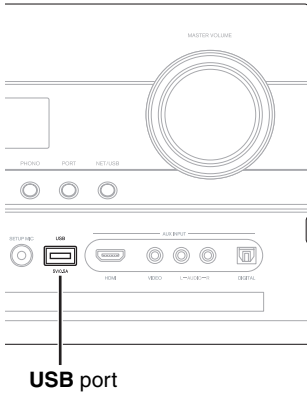

Playing Music Files on the iPod/iPhone

This section explains how to play music files on the iPod/iPhone*1.

*1 Compatible iPod models

Made for:

- iPod touch (1st and 2nd generation)
- iPod classic
- iPod (5th generation)
- iPod nano (1st, 2nd, 3rd, 4th and 5th generation)
- All iPhone models

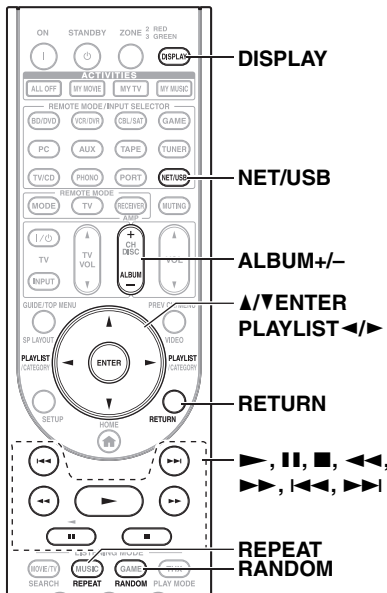

- 1 Press **NET/USB** repeatedly to select the **USB** input.

- 2 Connect the USB cable that comes with the iPod/iPhone to the **USB** port at the front of the AV receiver.

- The **USB** indicator lights (→ **9**) if the AV receiver is able to read the iPod/iPhone.
- The **USB** indicator flashes if the AV receiver cannot read the iPod/iPhone.

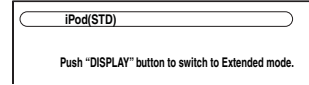

- 3 Press **DISPLAY** to switch to **Extended Mode***3. A list of your iPod model's contents appears. To open a folder, use ▲/▼ to select it, and then press **ENTER**.

Tip

- With the default settings, the iPod/iPhone can be manipulated in **Standard Mode***2.
- Pressing **DISPLAY** again switches back to **Standard Mode**.

- 4 Use ▲/▼ to select a music file, and press **ENTER** or ► to start playback.

- To return to the previous menu during playback, press **RETURN**.
- To stop or pause playback, press ■ or ||, respectively.
- To select the next song, press ►►I. To select the beginning of the current song, press I◀◀. To select the previous song, press I◀◀ twice.
- To fast forward the current song, press ►►►. To fast reverse the current song, press ◀◀◀.
- To switch the repeat mode, press **REPEAT**. To switch the random mode, press **RANDOM**.

Standard Mode control

The content information is not displayed onscreen, but can be manipulated using the iPod/iPhone or the Remote Control (**NET/USB**).

Note

- The audio of video content can be played back but no video will be displayed onscreen.

Extended Mode control

The content information is displayed (lists are displayed) on the on-screen, and you can select and manipulate the content while looking at the screen.

Top screen list:

- Playlists*4
- Artists*4
- Albums*4
- Genres*4
- Songs*4
- Composers*4
- Shuffle Songs*5
- Now Playing*6

*2 The following iPod models are not supported in Standard Mode. These iPod models can only be controlled in Extended Mode.

- iPod (5th generation)
- iPod nano (1st generation)

*3 When you disconnect the iPod/iPhone, the AV receiver stores the mode. This means that if you disconnect when in Extended Mode, the AV receiver will start in Extended Mode when you next connect the iPod/iPhone.

*4 Displays a list.

*5 Plays all tracks in random order.







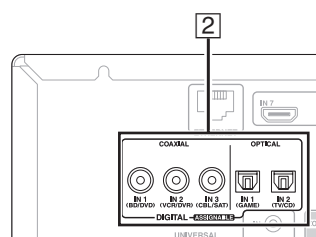
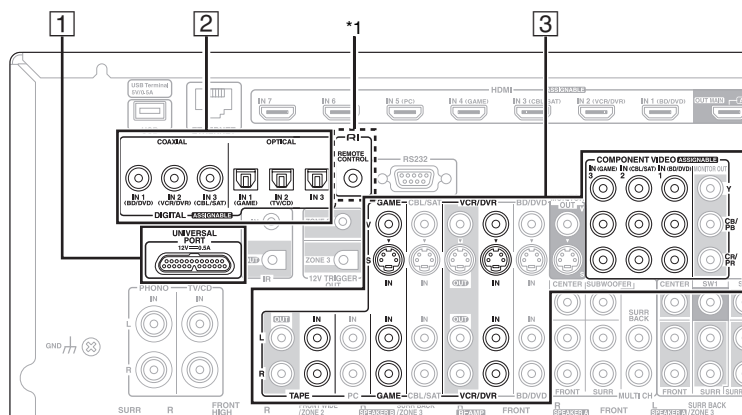

*6 Displays information about currently playing track.

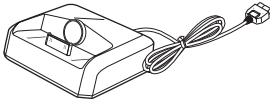
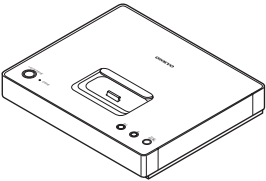
Connecting an Onkyo Dock

(TX-NR5008)

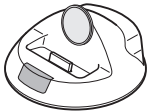
(TX-NR3008)

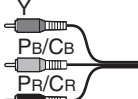

No.	Onkyo Dock	Cable	Note	Page
1	UP-A1 Dock (Universal Port Option Dock) 	—	<ul style="list-style-type: none"> • When UP-A1 Dock that seated iPod is connected, the power consumption on standby mode slightly increases. • You can control your iPod when “PORT” is selected as the input source. • See the UP-A1 Dock’s instruction manual for more information. 	88
2	ND-S1 	Optical digital audio  Coaxial digital audio  RI cable*1 	<ul style="list-style-type: none"> • See the ND-S1’s instruction manual for more information. *1 The ND-S1’s audio outputs are digital outputs. If the digital audio input on your AV receiver cannot be assigned to an input selector whose Input Display can be set to “DOCK”, do not connect the RI cable, otherwise a malfunction may occur. 	88
3	RI Dock  	Analog audio (RCA)  Component video  Composite video  RI cable*1 	<ul style="list-style-type: none"> • See the RI Dock’s instruction manual for more information. *1 To use RI (Remote Interactive), you must make an analog audio connection (RCA) between the AV receiver and the RI Dock. 	89

Models sold are different depending on the region.

Using the Onkyo Dock

Dock is sold separately.

For the latest information on the Onkyo Dock components, see the Onkyo web site at:
<http://www.onkyo.com>

Before using the Onkyo Dock components, update your iPod with the latest software, available from the Apple web site.

For supported iPod models, see the instruction manual of the Onkyo Dock.

UP-A1 Dock

With the UP-A1 Dock, you can easily play the music, photo, or movie stored on your Apple iPod through the AV receiver and enjoy great sound.

You can use the AV receiver's remote controller to operate your iPod.

Basic Operation

The AV receiver may take several seconds to startup, so you might not hear the first few seconds of the first song.

Auto Power On

If you start iPod playback while the AV receiver is on Standby, the AV receiver will automatically turn on and select your iPod as the input source.

Direct Change

If you start iPod playback while listening to another input source, the AV receiver will automatically select your iPod as the input source.

Using the AV receiver's Remote Controller

You can use the AV receiver's remote controller to control basic iPod functions (→ 89).

Operating Notes

- Functionality depends on your iPod model and generation.
- Before selecting a different input source, stop iPod playback to prevent the AV receiver from selecting the iPod input source by mistake.
- If any accessories are connected to your iPod, the AV receiver may not be able to select the input source properly.
- When connecting UP-A1 Dock to the radio tuner UP-HT1 (North American models)/UP-DT1 (European and Asian models) with AUTO selected by the tuner's Mode Selector switch, you can switch the input source between UP-A1 Dock and the tuner, by pressing **PORT** repeatedly on the front panel.
- While your iPod is in the UP-A1 Dock, its volume control has no effect. If you adjust your iPod models volume control while it's in the UP-A1 Dock, make sure it's not set too high before you reconnect your headphones.
- The Auto Power On function will not work if you set your iPod in the UP-A1 Dock while it is playing.
- When Zone 2/3 is turned on, you can't use Auto Power On and Direct Change functions.
- Do not turn off the power with the iPod still connected to this unit via the UP-A1 Dock.
- Set your iPod in the UP-A1 Dock after the AV receiver turns on.

Using Your iPod models Alarm Clock

You can use your iPod models Alarm Clock function to automatically turn on your iPod and the AV receiver at a specified time. The AV receiver's input source will automatically be set to the **PORT** selector.

Note

- To use this function, your iPod must be in the UP-A1 Dock, and the UP-A1 Dock must be connected to the AV receiver.
- This function works only in the Standard mode (→ 90).
- When you use this function, be sure to set the AV receiver's volume control to a suitable level.
- When Zone 2/3 is turned on, you can't use this function.
- You cannot use this function for sound effects on your iPod/iPhone.

Charging Your iPod models Battery

The UP-A1 Dock charges your iPod models battery while your iPod is in the UP-A1 Dock and connected to the **UNIVERSAL PORT** jack on the AV receiver. While your iPod is seated in the UP-A1 Dock, its battery will be charged when the AV receiver is set to "On" or "Standby".

Note

- When UP-A1 Dock that seated iPod is connected, the power consumption on standby mode slightly increases.

Status Messages

PORT Reading

The AV receiver is checking the connection with the dock.

PORT Not Support

The AV receiver do not support the connected dock.

PORT UP-A1

UP-A1 Dock is connected.

Note

- The AV receiver displays the message "**UP-A1**" for several seconds after recognizing the UP-A1.
- When the status message is not displayed on the AV receiver's display, check the connection to your iPod.

ND-S1

With the ND-S1 Digital Media Transport, you can easily play the music stored on your iPod through the AV receiver and enjoy great sound.

The ND-S1 processes the digital audio signal directly from your iPod for high-quality digital audio output (optical or coaxial).

Note

- You must select "iPod" using ND-S1's iPod/PC button.
- Set the AV receiver's Input Display to "**DOCK**" (→ 31).

RI Dock

With the RI Dock, you can easily play the music stored on your Apple iPod through the AV receiver and enjoy great sound, and watch iPod slideshows and videos on your TV. In addition, the onscreen display (OSD) allows you to view, navigate, and select your iPod model's contents on your TV, and with the supplied remote controller, you can control your iPod from the comfort of your sofa. You can even use the AV receiver's remote controller to operate your iPod.

Note

- Enter the appropriate remote control code before using the AV receiver's remote controller for the first time (→ **93**).
- Connect the RI Dock to the AV receiver with an **RI** cable (→ **87**).
- Set the RI Dock's RI MODE switch to "HDD" or "HDD/DOCK".
- Set the AV receiver's Input Display to "**DOCK**" (→ **31**).

■ System Function

Auto Power On

If you press the remote controller's **▶** while the AV receiver is on Standby, the AV receiver will automatically turn on, select your iPod as the input source, and your iPod will start playback.

Direct Change

If you start iPod playback while listening to another input source, the AV receiver will automatically switch to the input to which the ND-S1 and RI Dock is connected.

Using the AV receiver's Remote Controller

You can use the AV receiver's remote controller to control basic iPod functions.

Using Your iPod models Alarm Clock

If you use the Alarm Clock function on your iPod to start playback, the AV receiver will automatically turn on at the specified time and select your iPod as the input source.

System Off

When you turn off the AV receiver, the ND-S1, RI Dock and iPod turn off automatically.

Note

- Linked operations do not work with video playback or when the alarm is set to play a sound.
- If you use your iPod with any other accessories, iPod playback detection may not work.
- This function works only in the Standard mode (→ **90**).

■ Operating Notes

- Use the AV receiver's volume control to adjust the playback volume.
- While your iPod is inserted in the ND-S1 or RI Dock, its volume control has no effect. If you adjust your iPod models volume control while it's in the UP-A1 Dock, make sure it's not set too high before you reconnect your headphones.

Note

- On the 5th generation iPod and iPod nano, the click wheel is disabled during playback. For ND-S1, use iPod button to start and stop playback and the remote controller to control other iPod functions.

Controlling Your iPod

By pressing **REMOTE MODE** that's been programmed with the remote control code for your Dock, you can control your iPod in the Dock.

See "Entering Remote Control Codes" for details on entering a remote control code (→ **93**).

See the Dock's instruction manual for more information.

■ UP-A1 Dock

PORT is preprogrammed with the remote control code for controlling a Dock with Universal Port connector.

You can control your iPod when "**PORT**" is selected as the input source.

Without the RI Control

You must enter a remote control code **82990** first (→ **93**).

■ ND-S1

- Select "iPod" using ND-S1's iPod/PC button.

■ RI Dock

- Set the RI Dock's RI MODE switch to "HDD" or "HDD/DOCK".
- **ON/STANDBY** may not work with a remote control code (without **RI**). In this case, make an **RI** connection and enter a remote control code **81993** (with **RI**).

With the RI Control

In this case, make an **RI** connection and enter a remote control code **81993** (with **RI**).

- Set the AV receiver's Input Display to "**DOCK**" (→ **31**).

Press the appropriate **REMOTE MODE** first.

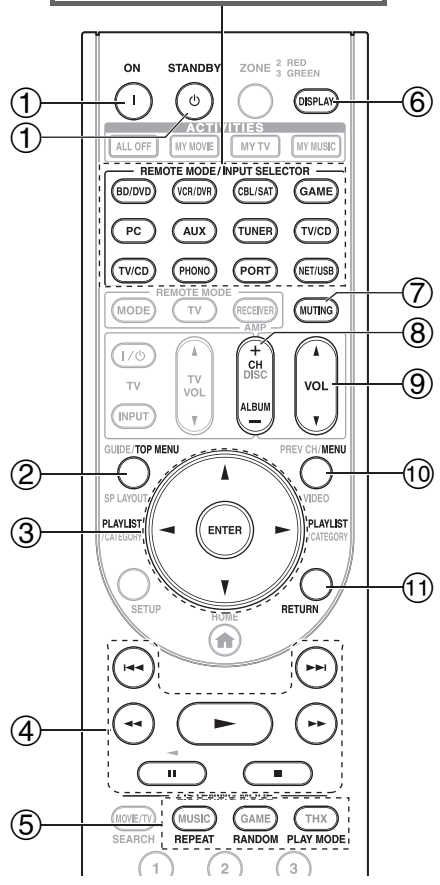

✓: Available buttons

Buttons	Onkyo Dock		
	UP-A1 Dock	ND-S1	RI Dock
① ON, STANDBY		✓	✓*1
② TOP MENU		✓*5	✓*6
③ ▲/▼/◀/▶ ENTER	✓	✓*5	✓
PLAYLIST ◀/▶	✓*3	✓	✓
④ ▶, , ■, ◀▶, ◀▶▶, ▶▶▶	✓	✓	✓
⑤ REPEAT	✓	✓	✓
RANDOM	✓	✓	✓
PLAY MODE	✓*4	✓*5	✓*4
⑥ DISPLAY*7	✓*2	✓*5	✓
⑦ MUTING	✓	✓*5	✓
⑧ ALBUM +/-	✓	✓	✓
⑨ VOL ▲/▼	✓	✓*5	✓
⑩ MENU		✓*5	✓
⑪ RETURN	✓		

- With some iPod models, generations and RI Docks, certain buttons may not work as expected.
- For detailed operation of the iPod, please refer to the instruction manual of RI Dock.
- *1 This button does not turn the Onkyo DS-A2 or DS-A2X RI Dock on or off. Your iPod may not respond the first time you press this button, in which case you should press it again.
This is because the remote controller transmits the On and Standby commands alternately, so if your iPod is already on, it will remain on when the remote controller transmits an On command.
Similarly, if your iPod is already off, it will remain off when the remote controller transmits an Off command.
- *2 Press **DISPLAY** to change the following modes:
Standard mode
Nothing is displayed on your TV and you navigate and select your contents by using your iPod models display.
Only this mode can playback the video.
Extended mode (Music)
Playlists (artists, albums, songs, and so on) are displayed on your TV, and you can navigate and select your music while looking at your TV.
Extended mode (Video)
Playlists (Movies, Music Videos, TV Shows, Video Podcasts, or Rentals) are displayed on your TV, and you can navigate and select your video while looking at your TV.
- *3 In Extended mode (see *2), **PLAYLIST** is used as the page jump button.
With the page modes, you can quickly locate your favorite songs even when your song lists, artist lists, and so on are very long.
- *4 **Resume mode**
With the Resume function, you can resume playback of the song that was playing when you removed your iPod from the RI Dock or Extended mode is selected.
- *5 Operation can be performed if you connect ND-S1 with an **RI** cable.
- *6 **TOP MENU** works as a Mode button when used with a DS-A2 RI Dock.
- *7 **DISPLAY** turns on backlight for 30 seconds.

Note

- In Extended mode (see *2), the playback will be continued even if the AV receiver is turned off.
- In Extended mode (see *2), you cannot operate your iPod directly.
- In Extended mode (see *2), it may take some time to acquire the contents.

Controlling Other Components

You can use the AV receiver's remote controller (RC-773M) to control your other AV components, including those made by other manufacturers. This section explains how to enter the remote control code (with the default underlined) for a component that you want to control: DVD, TV, CD, etc.

- Learn commands directly from another component's remote controller (→ 97).
- Program **ACTIVITIES** to perform a sequence of up to 32 remote control actions (→ 96, 98).

Preprogrammed Remote Control Codes

The following **REMOTE MODE** are preprogrammed with remote control codes for controlling the components listed. You do not need to enter a remote control code to control these components.

For details on controlling these components, see the pages indicated.

- BD/DVD** Onkyo Blu-ray Disc player (→ 94)
TAPE Onkyo cassette tape deck with **RI** (→ 95)
TV/CD Onkyo CD player (→ 94)
PORT Onkyo Universal Port Option (→ 89)

Looking up for Remote Control Code

You can look up for appropriate remote control code from on-screen setup menu.

Note

- This setting can be carried out by using on-screen setup menu only.

1 Press RECEIVER followed by SETUP.

The main menu appears onscreen.

Tip

- If the main menu doesn't appear, make sure the appropriate external input is selected on your TV.

2 Use ▲/▼ to select "Remote Controller Setup", and then press ENTER.

The "Remote Controller Setup" menu appears.

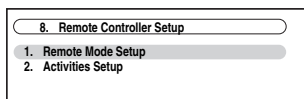

3 Use ▲/▼ to select "Remote Mode Setup", and then press ENTER.

The "Remote Mode Setup" menu appears.

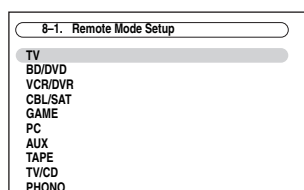

4 Use ▲/▼ to select remote mode, and then press ENTER.

The category selection menu appears.

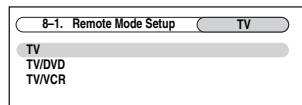

5 Use ▲/▼ to select category, and then press ENTER.

The brand name input panel appears.

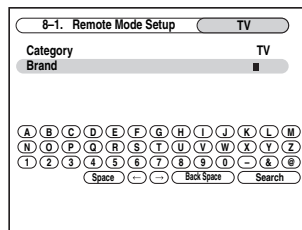

6 Use ▲/▼/◀/▶ to select a character, and then press ENTER.

Repeat this step from the 1st character to the 3rd character of the brand name.

When you have entered the 3rd character, select "Search" and press ENTER.

After searching, a list of the brand name appears.

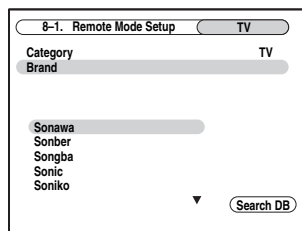

7 Use ▲/▼ to select the brand name, and press ENTER.

Go to step 8.

If you cannot find the brand name, use ▶ to select "Search DB", and then press ENTER to access the database on the network.

The AV receiver accesses and searches the database. After searching, a list of the brand name appears.

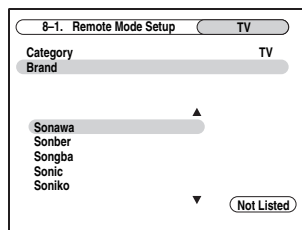

Tip

- If you cannot access the database, a message “Cannot connect to database.” will appear. Press **ENTER** to return to the previous step.
- If the brand name is not found, use **▶** to select “Not Listed”, and then press **ENTER**.

The following screen appears.

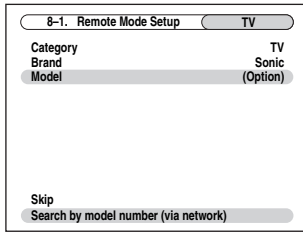

8 Use ▲/▼ to select “Search by model number (via network)”, and then press ENTER.

The model number input panel appears.

When you do NOT have a network connection or if you are not sure about the exact model, select “Skip”, and then press **ENTER**.

If you select “Skip”, you will go to step 11.

9 Enter the model in a similar manner as in the case of the brand name (step 6).

Tip

- After entering the 3rd character, press **ENTER** to start searching.
- You cannot enter a space character.

10 Use ▲/▼ to select the model, and then press ENTER.

If the model is not found, use **▶** to select “Not Listed”, and then press **ENTER**.

After searching is completed, a message for remote control code transfer will appear.

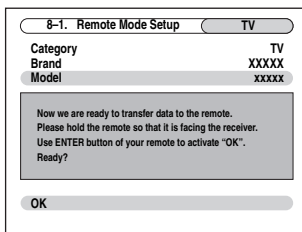

11 While pointing the remote controller at the AV receiver's remote control sensor, press ENTER.

Remote control sensor (Transmitter)

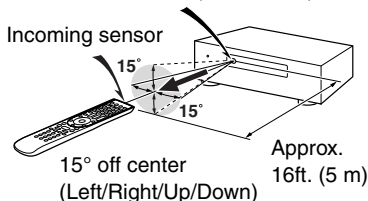

12 When you searched for the model, a message “Successful” will appear. Now the transfer is successful!

Go to step 15.

When you did NOT search for the model, the following screen appears.

Push any key (except for arrow buttons and **ENTER**) to see if the component responds.

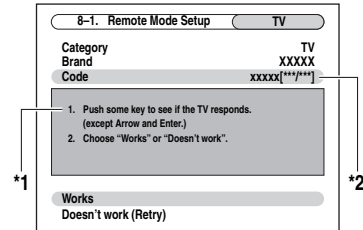

- *1 When category other than TV have been selected, the content is different.
- *2 Asterisks in [***/*] mean the order of the candidate code and the total number of the codes for the brand.

13 If you can control component, press RECEIVER, use ▲/▼ to select “Works”, and then press ENTER.

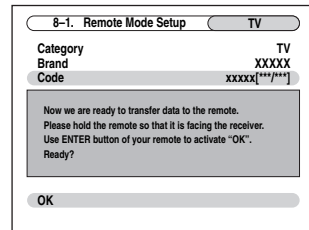

If you cannot control component, press **RECEIVER**, use ▲/▼ to select “Doesn't work (Retry)” and press **ENTER**.

The next code appears. Repeat from step 11.

14 Press ENTER to transfer the determined code.

Remote control sensor (Transmitter)

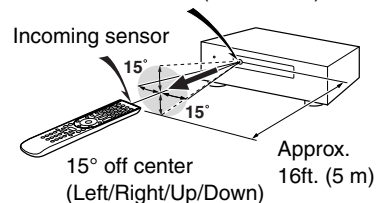

15 Press ENTER.

You'll return to the category selection menu. Press **SETUP** to end the remote mode setup.

Entering Remote Control Codes

You'll need to enter a code for each component that you want to control.

1 Look up the appropriate remote control code in the separate Remote Control Codes list.

The codes are organized by category (e.g., DVD player, TV, etc.).

2 While holding down REMOTE MODE to which you want to enter a code, press and hold down DISPLAY (about 3 seconds).

The REMOTE MODE button lights.

Note

- Remote control codes cannot be entered for **RECEIVER** and **ZONE**.
- Only TV remote control codes can be entered for **TV**.
- Except for **RECEIVER**, **TV** and **ZONE**, remote control codes from any category can be entered as **REMOTE MODE**. However, these buttons also work as input selector buttons (→ 28), so choose a **REMOTE MODE** that corresponds with the input to which you connect your component. For example, if you connect your CD player to the CD input, choose **TV/CD** when entering its remote control code.

3 Within 30 seconds, use the number buttons to enter the 5-digit remote control code.

REMOTE MODE button flashes twice.

If the remote control code is not entered successfully, REMOTE MODE button will flash once slowly.

Note

- The remote control codes provided are correct at the time of printing, but are subject to change.

Remote Control Codes for Onkyo Components Connected via RI

Onkyo components that are connected via **RI** are controlled by pointing the remote controller at the AV receiver, not the component. This allows you to control components that are out of view, in a rack, for example.

1 Make sure the Onkyo component is connected with an RI cable and an analog audio cable (RCA).

See "Connecting Onkyo **RI** Components" for details (→ 23).

2 Enter the appropriate remote control code for REMOTE MODE.

- **BD/DVD**
 - ▶ **31612**:
Onkyo DVD player with **RI**
- **TAPE**
 - ▶ **42157**:
Onkyo cassette tape deck with **RI**
- **TV/CD**
 - ▶ **71327**:
Onkyo CD player with **RI**
- **PORT**
 - ▶ **81993**:
Onkyo Dock with **RI**

See the previous section for how to enter remote control codes.

3 Press REMOTE MODE, point the remote controller at the AV receiver, and operate the component.

If you want to control an Onkyo component by pointing the remote controller directly at it, or you want to control an Onkyo component that's not connected via **RI**, use the following remote control codes:

- **BD/DVD**
 - ▶ **30627**:
Onkyo DVD player without **RI**
- **TV/CD**
 - ▶ **71817**:
Onkyo CD player without **RI**
 - ▶ **11807**:
TV with **RIHD**

If you want to control an Onkyo component by pointing the remote controller directly at it, use the following remote control codes:

- ▶ **32900**:
Onkyo Blu-ray Disc player
- ▶ **32901**:
Onkyo HD DVD player
- ▶ **70868**:
Onkyo MD recorder without **RI**
- ▶ **71323**:
Onkyo CD recorder without **RI**
- ▶ **82990**:
Onkyo Dock without **RI**

Resetting REMOTE MODE Buttons

You can reset a **REMOTE MODE** to its default remote control code.

1 While holding down **REMOTE MODE** that you want to reset, press and hold down **HOME** until **REMOTE MODE** button lights (about 3 seconds).

2 Within 30 seconds, press **REMOTE MODE** again. **REMOTE MODE** button flashes twice, indicating that the button has been reset.

Each of **REMOTE MODE** is preprogrammed with a remote control code. When a button is reset, its preprogrammed code is restored.

Note

- The learning command is also reset.

Resetting the Remote Controller

You can reset the remote controller to its default settings.

1 While holding down **RECEIVER**, press and hold down **HOME** until **RECEIVER** lights (about 3 seconds).

2 Within 30 seconds, press **RECEIVER** again. **RECEIVER** flashes twice, indicating that the remote controller has been reset.

Controlling Other Components

By pressing **REMOTE MODE** that's been programmed with the remote control code for your component, you can control your component as below.

For details on entering a remote control code for other components, see "Entering Remote Control Codes" (→ 93).

Controlling a TV

TV is preprogrammed with the remote control code for controlling a TV that supports the **RIHD***1 (limited to some models). The TV must be able to receive remote control commands via **RIHD** and be connected to the AV receiver via HDMI. If controlling your TV via **RIHD** doesn't work very well, program your TV's remote control code into **TV** and use the TV remote mode to control your TV.

Controlling a Blu-ray Disc/DVD Player, HD DVD Player or DVD Recorder

BD/DVD is preprogrammed with the remote control code for controlling a component that supports the **RIHD***1 (limited to some models). The component must be able to receive remote control commands via **RIHD** and be connected to the AV receiver via HDMI.

*1 The **RIHD** supported by the AV receiver is the CEC system control function of the HDMI standard.

Press the appropriate **REMOTE MODE** first.

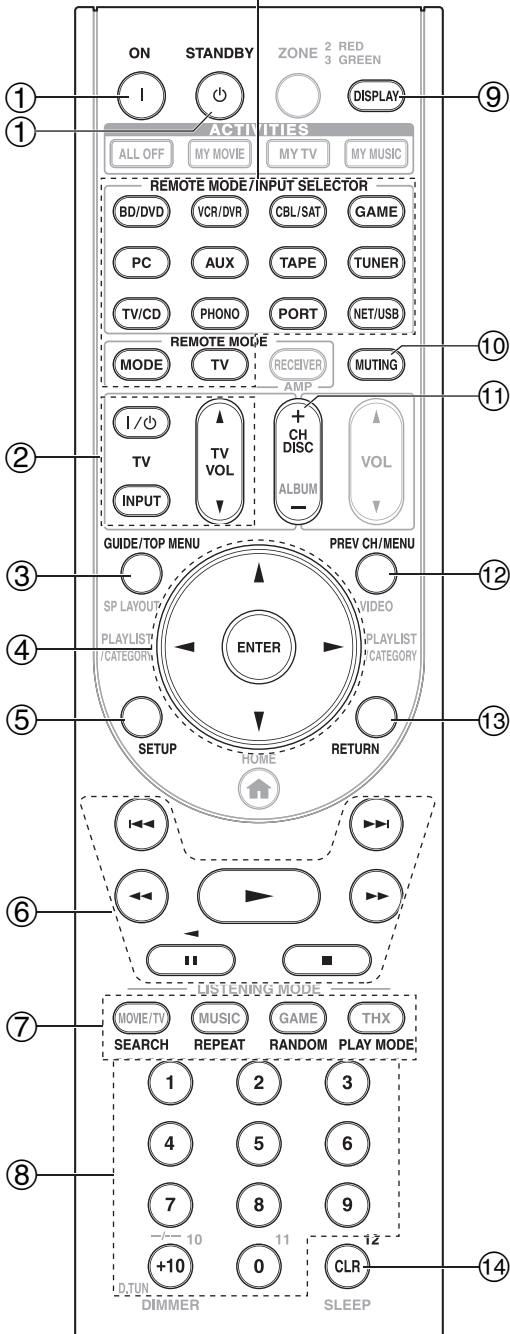

Note

- With some components, certain buttons may not work as expected, and some may not work at all.

✓: Available buttons

Buttons	TV	DVD player/DVD recorder	Blu-ray Disc player HD DVD player	VCR/PVR	Satellite receiver Cable receiver	CD player/CD recorder MD recorder	Cassette tape deck
① ON, STANDBY	✓	✓		✓	✓	✓	✓
② I/O, INPUT, TV VOL ▲/▼	✓						
③ GUIDE	✓			✓	✓		
④ TOP MENU		✓					
⑤ ▲/▼/◀/▶ ENTER	✓	✓		✓	✓	✓	
⑥ SETUP	✓	✓			✓	✓	
⑦ ►, , ■, ◀, ▶, ◀◀, ▶▶, ▶▶▶, ▶▶▶▶	✓*1	✓		✓	✓	✓	✓*3
⑧ SEARCH	✓*1*2	✓*1	✓*2	✓*2	✓*2	✓	
REPEAT	✓*1*2		✓*2	✓*2	✓*2	✓	
RANDOM	✓*1*2	✓*1	✓*2	✓*2	✓*2	✓	
PLAY MODE	✓*1*2	✓*1	✓*2	✓*2	✓*2	✓	
⑧ Number: 1 to 9, 0	✓			✓	✓	✓	
Number: +10	✓*1	✓*1		✓	✓	✓	
⑨ DISPLAY	✓	✓		✓	✓	✓	
⑩ MUTING	✓	✓		✓	✓	✓	✓
⑪ CH +/-	✓	✓		✓	✓		
DISC +/-		✓				✓	
⑫ PREV CH	✓			✓	✓		
MENU		✓					
⑬ RETURN	✓	✓		✓	✓		
⑭ CLR	✓	✓		✓	✓	✓	

*1 The **RIFD** function is not supported. The **RIFD** supported by the AV receiver is the CEC system control function of the HDMI standard.

*2 These buttons function as colored buttons or A, B, C, D buttons.

*3 **||** (Pause) functions as reverse playback.

Tip

- See the “Controlling Your iPod” about the operation of iPod (→ 89).

Activities Setup

Via onscreen menu, you can specify what actions will be taken by the Easy macro command in the Easy macro mode (→ 31).

1 Press RECEIVER followed by SETUP.

The main menu appears onscreen.

Tip

- If the main menu doesn't appear, make sure the appropriate external input is selected on your TV.

2 Use ▲/▼ to select “Remote Controller Setup”, and then press ENTER.

The “Remote Controller Setup” menu appears.

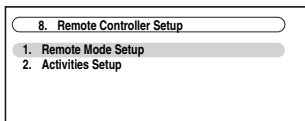

3 Use ▲/▼ to select “Activities Setup”, and then press ENTER.

The “Activities Setup” menu appears.

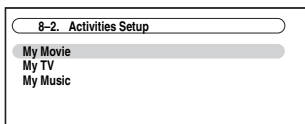

4 Use ▲/▼ to select “My Movie”, “My TV”, or “My Music”, and then press ENTER.

■ My Movie:

Actions for **MY MOVIE** is changed.

■ My TV:

Actions for **MY TV** is changed.

■ My Music:

Actions for **MY MUSIC** is changed.

5 Use ▲/▼ to select an item, and use ◀/▶ to change the settings.

The items are explained below.

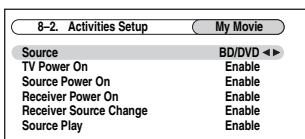

■ Source

- ▶ **BD/DVD, VCR/DVR, CBL/SAT, GAME, PC, AUX, TAPE, TUNER, TV/CD, PHONO, PORT, NET/USB**

With this setting, you can choose the input source.

■ TV Power On

▶ Enable:

TV will turn on.

▶ Disable:

TV will not turn on.

This option enables the TV to turn on when **ACTIVITIES** is pressed.

■ Source Power On

▶ Enable:

Source component will turn on.

▶ Disable:

Source component will not turn on.

This option enables the source component to turn on when **ACTIVITIES** is pressed.

■ Receiver Power On

▶ Enable:

The AV receiver will turn on.

▶ Disable:

The AV receiver will not turn on.

This option enables the AV receiver to turn on when **ACTIVITIES** is pressed.

■ Receiver Source Change

▶ Enable:

The AV receiver will change input source.

▶ Disable:

The AV receiver will not change input source.

This option enables the AV receiver input selector to change when **ACTIVITIES** is pressed.

■ Source Play

▶ Enable:

The source component will start playback.

▶ Disable:

The source component will not start playback.

This option enables the source component to start playback when **ACTIVITIES** is pressed.

Here are the default settings.

Item	Default Settings		
	My Movie	My TV	My Music
Source	BD/DVD	CBL/SAT	TV/CD
TV Power On	Enable	Enable	Disable
Source Power On	Enable	Enable	Enable
Receiver Power On	Enable	Enable	Enable
Receiver Source Change	Enable	Enable	Enable
Source Play	Enable	Disable	Enable

6 Press ENTER.

A message for transfer will appear.

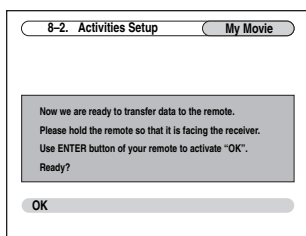

To use the remote controller, point it at the AV receiver's remote control sensor, as shown below.

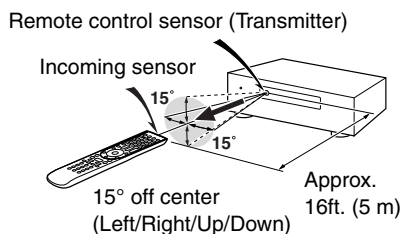

7 Press ENTER.

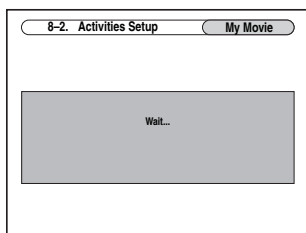

When the transfer is successful, the following screen appears.

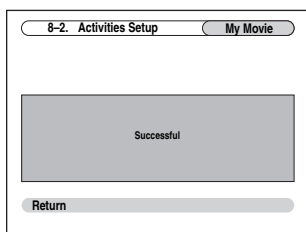

8 Press ENTER.

The "Activities Setup" menu appears onscreen.

9 Press SETUP.

The setup menu closes.

Learning Commands

The AV receiver's remote controller can learn the commands of other remote controllers. By transmitting, for example, the Play command from your CD player's remote controller, the remote controller can learn it, and then transmit the exact same command when its ► is pressed in the CD remote mode.

This is useful when you've entered the appropriate remote control code (→ 93) but some buttons don't work as expected.

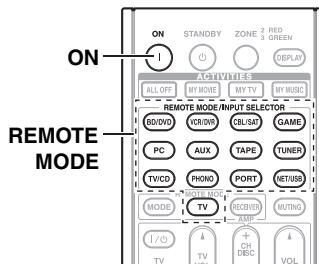

1 While holding down **REMOTE MODE** for the mode in which you want to use the command, press and hold down **ON** until **REMOTE MODE** button lights (about 3 seconds).

2 On the supplied remote controller, press the button you want to learn the new command.

Note

- The following buttons cannot learn new commands: **REMOTE MODE**, **ALL OFF**, **MY MOVIE**, **MY TV**, **MY MUSIC** and **MODE**.

3 Point the remote controllers at each other, about 2 to 6 inches (5 to 15 cm) apart, and then press and hold the button whose command you want to learn until **REMOTE MODE** button flashes.

If the command is learned successfully, **REMOTE MODE** button flashes twice.

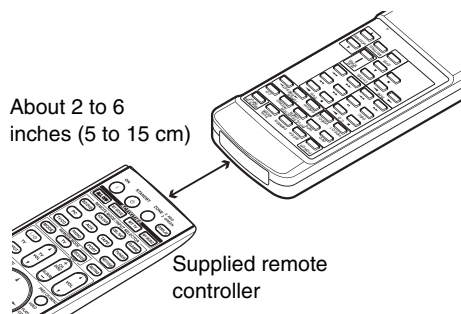

4 To learn more commands, repeat steps 2 and 3. Press any **REMOTE MODE** when you've finished. **REMOTE MODE** button flashes twice.

Note

- The remote controller can learn approximately 70 to 90 commands, although this will be less if commands that use a lot of memory are learned.
- Remote controller buttons such as Play, Stop, Pause, and so on are preprogrammed with commands for controlling Onkyo CD players, cassette decks, and DVD players. However, they can learn new commands, and you can restore the preprogrammed commands at any time by resetting the remote controller (→ 94).
- To overwrite a previously learned command, repeat this procedure.
- Depending on the remote controller that you are using, there may be some buttons that won't work as expected, or even some remotes that cannot be learned at all.
- Only commands from infrared remote controllers can be learned.
- When the remote controller's batteries expire, all learned commands will be lost and will have to be learned all over again, so don't discard your other remote controllers.

Deleting Learning Commands

1. While holding down **REMOTE MODE** for the mode in which you want to delete the command, press and hold down **TV I/O** until **REMOTE MODE** button lights (about 3 seconds).
2. Press **REMOTE MODE** or the button from which you want to delete the commands.
REMOTE MODE button flashes twice.
When you press **REMOTE MODE**, all commands learned in that remote mode will be deleted.

Using Normal Macros

You can program the remote controller's **ACTIVITIES** to perform a sequence of remote control actions.

Example:

To play a CD you typically need to perform the following actions:

1. Press **RECEIVER** to select the Receiver remote controller mode.
2. Press **ON** to turn on the AV receiver.
3. Press **TV/CD** to select the TV/CD input source.
4. Press **▶** to start playback on the CD player.

You can program **ACTIVITIES** so that all four actions are performed with just one button press.

Making Macros

Each **ACTIVITIES** can store one macro, and each macro can contain up to 32 commands.

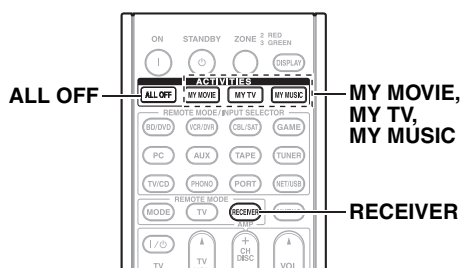

1 While holding down **RECEIVER**, press and hold down **MY MOVIE**, **MY TV**, or **MY MUSIC** until **MY MOVIE**, **MY TV**, or **MY MUSIC** lights (about 3 seconds).

2 Press the buttons whose actions you want to program into the macro in the order you want them performed.

For the CD example above, you'd press the following buttons: **ON**, **TV/CD**, **▶**.

Note

- **MODE** is invalid at macro making operation.

3 When you've finished, press **ACTIVITIES** again. **ACTIVITIES** button flashes twice.

If you enter 32 commands, the process will finish automatically.

Note

- Once you have taught a new macro commands, the original macro will no longer work. If you retrieve it, you will have to taught again.

Running Macros

Press **MY MOVIE**, **MY TV**, or **MY MUSIC**.

The commands in the macro are transmitted in the order in which they were programmed. Keep the remote controller pointed at the AV receiver until all of the commands have been transmitted.

Macros can be run at any time, regardless of the current remote controller mode.

Deleting Macros

1 While holding down **HOME**, press and hold down **ALL OFF** until **ALL OFF** lights (about 3 seconds).

2 Press **ALL OFF** again. **ALL OFF** flashes twice.

Note

- You can use Easy macro when the macro is deleted (→ 31).
- When you use Normal macro, you cannot use the easy macro command including the change of the source component.

Troubleshooting

If you have any trouble using the AV receiver, look for a solution in this section. If you can't resolve the issue yourself, contact your Onkyo dealer.

If you can't resolve the issue yourself, try resetting the AV receiver before contacting your Onkyo dealer.

To reset the AV receiver to its factory defaults, turn it on and, while holding down VCR/DVR, press ON/STANDBY. "Clear" will appear on the display and the AV receiver will enter Standby mode.



Note that resetting the AV receiver will delete your radio presets and custom settings.

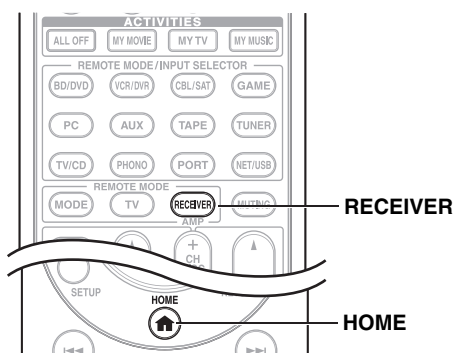

To reset the remote controller to its factory defaults, while holding down **RECEIVER**, press and hold down **HOME** until **RECEIVER** button lights (about 3 seconds). Within 30 seconds, press **RECEIVER** again.

Power

■ Can't turn on the AV receiver

Make sure that the power cord is properly plugged into the wall outlet. —

Unplug the power cord from the wall outlet, wait five seconds or more, then plug it in again. —

■ The STANDBY indicator flashes red

The protection circuit has been activated. Remove the power cord from the wall outlet immediately. Disconnect all speaker cables and input sources, and leave the AV receiver with its power cord disconnected for 1 hour. After that, reconnect the power cord and set the volume to maximum. If the AV receiver stays on, set the volume to minimum, disconnect the power cord, and reconnect your speakers and input sources. If the AV receiver turns off when you set the volume to maximum, disconnect the power cord, and contact your Onkyo dealer. —

Audio

■ There's no sound, or it's very quiet

Make sure that the digital input source is selected properly. 50

Make sure that all audio connecting plugs are pushed in all the way. 20

Make sure that the inputs and outputs of all components are connected properly. 21-23

Make sure that the polarity of the speaker cables is correct, and that the bare wires are in contact with the metal part of each speaker terminal. 14

Make sure that the input source is properly selected. 28

Make sure that the speaker cables are not shorting. 14

Check the volume. The AV receiver is designed for home theater enjoyment. It has a wide volume range, allowing precise adjustment. —

If the **MUTING** indicator is flashing on the display, press the remote controller's **MUTING** to unmute the AV receiver. 29

While a pair of headphones is connected to the **PHONES** jack, no sound is output by the speakers. 31

If there's no sound from a DVD player connected to an HDMI IN, check the DVD player's output settings, and be sure to select a supported audio format. —

Check the digital audio output setting on the connected device. On some game consoles, such as those that support DVD, the default setting is off. —

With some DVD-Video discs, you need to select an audio output format from a menu. —

If your turntable uses an MC cartridge, you must connect an MC head amp, or an MC transformer. —

Make sure that none of the connecting cables are bent, twisted, or damaged. —

Not all listening modes use all speakers. 40

Specify the speaker distances and adjust the individual speaker levels. 52

Make sure that the speaker setup microphone is not still connected. —

The input signal format is set to "PCM" or "DTS". Set it to "Auto". 69

■ Only the front speakers produce sound

When the Stereo or Mono listening mode is selected, only the front speakers and subwoofer produce sound. —

In the Mono listening mode, only the front speakers output sound if the "Output Speaker" setting is set to "Left / Right". 55

Check the Speaker Configuration. 51

■ Audio Return Channel audio can be heard via the TV/monitor speakers connected to the HDMI OUT SUB jack

Change the Audio Selector settings of the TV/CD input selector. 68

■ Only the center speaker produces sound

If you use the Dolby Pro Logic Ix Movie, Dolby Pro Logic Ix Music, or Dolby Pro Logic Ix Game listening mode with a mono source, such as an AM radio station or mono TV program, the sound is concentrated in the center speaker.

In the Mono listening mode, only the front speakers output sound if the **“Output Speaker”** setting is set to **“Center”**. **55**

Make sure the speakers are configured correctly. **51**

■ The surround speakers produce no sound

When the T-D (Theater-Dimensional), Stereo or Mono listening mode is selected, the surround speakers produce no sound.

Depending on the source and current listening mode, not much sound may be produced by the surround speakers. Try selecting another listening mode.

Make sure the speakers are configured correctly. **51**

■ The center speaker produces no sound

When the Stereo or Mono listening mode is selected, the center speaker produces no sound.

In the Mono listening mode, only the front speakers output sound if the **“Output Speaker”** setting is set to **“Left / Right”**. **55**

Make sure the speakers are configured correctly. **51**

■ The front high, front wide and surround back speakers produce no sound

Depending on the current listening mode, no sound may be produced by the front high, front wide and surround back speakers. Select another listening mode. **40**

Not much sound may be produced by the front high, front wide and surround back speakers with some sources.

Make sure the speakers are configured correctly. **51**

While Powered Zone 2 is being used, playback in the main room is reduced to 7.2-channels and the front wide and front high speakers produce no sound. **80**

While Powered Zone 3 is being used, playback in the main room is reduced to 7.2-channels and the surround back speakers produce no sound. **81**

■ The subwoofer produces no sound

When you play source material that contains no information in the LFE channel, the subwoofer produces no sound.

Make sure the speakers are configured correctly. **51**

■ The Zone 2/3 speakers produce no sound

The Zone 2/3 speakers only output sources that are connected to an analog input. Check to see if the source component is connected to an analog input.

Powered Zone 2 cannot be used if **“Speakers Type(Front B)”** is set to **“Normal”**, **“Bi-Amp”**, or **“BTL”**.

Powered Zone 3 cannot be used if **“Speakers Type(Front A)”** or **“Speakers Type(Front B)”** is set to **“Bi-Amp”** or **“BTL”**.

■ There's no sound with a certain signal format

Check the digital audio output setting on the connected device. On some game consoles, such as those that support DVD, the default setting is off.

With some DVD-Video discs, you need to select an audio output format from a menu.

Depending on the input signal, some listening modes cannot be selected. **40-45**

■ Can't select the Pure Audio listening mode

The Pure Audio listening mode cannot be selected while Zone 2/3 is on.

■ Can't get 6.2/7.2 playback

If no surround back speakers, front wide and front high speakers are connected, or the Zone 2/3 speakers are being used, 6.2/7.2 playback is not possible.

You can not always select all of the listening modes, depending on the number of the speakers connected. **40-45**

■ The speaker volume cannot be set as required (The volume cannot be set to Max(100.0))

Check to see if a maximum volume has been set. **63**

If the volume level of each individual speaker has been adjusted to high positive values, then the maximum master volume possible may be reduced. Note that the individual speaker volume levels are set automatically after Audyssey MultEQ® XT32 Room Correction and Speaker Setup function has been completed. **32, 52**

■ Noise can be heard

Using cable ties to bundle audio cables with power cords, speaker cables, and so on may degrade the audio performance, so don't do it.

An audio cable may be picking up interference. Try repositioning your cables.

■ The Late Night function doesn't work

Make sure the source material is Dolby Digital, Dolby Digital Plus, and Dolby TrueHD. **67**

■ The analog multichannel input doesn't work

Check the multichannel input connections.

Make sure that the multichannel input is assigned to the input selector. **50**

Make sure that the multichannel input is selected. **68**

Check the audio output settings on your source component.

■ About DTS signals

When DTS program material ends and the DTS bitstream stops, the AV receiver remains in DTS listening mode and the **DTS** indicator remains on. This is to prevent noise when you use the pause, fast forward, or fast reverse function on your player. If you switch your player from DTS to PCM, because the AV receiver does not switch formats immediately, you may not hear any sound, in which case you should stop your player for about three seconds, and then resume playback.

With some CD and LD players, you won't be able to playback DTS material properly even though your player is connected to a digital input on the AV receiver. This is usually because the DTS bitstream has been processed (e.g., output level, sampling rate, or frequency response changed) and the AV receiver doesn't recognize it as a genuine DTS signal. In such cases, you may hear noise.

When playing DTS program material, using the pause, fast forward, or fast reverse function on your player may produce a short audible noise. This is not a malfunction.

■ The beginning of audio received by an HDMI IN can't be heard

Since it takes longer to identify the format of an HDMI signal than it does for other digital audio signals, audio output may not start immediately.

Video

■ There's no picture

Make sure that all video connecting plugs are pushed in all the way. **20**

Make sure that each video component is properly connected. **21, 22, 87**

If your TV is connected to the HDMI output, set the "Monitor Out" setting other than "Analog", and select "- - - -" in the "HDMI Input" to watch composite video, S-Video, and component video sources. **47, 48**

If your TV is connected to the COMPONENT VIDEO MONITOR OUT, MONITOR OUT S, or MONITOR OUT V, set the "Monitor Out" setting to "Analog", and select "- - - -" in the "Component Video Input" to watch composite video and S-Video sources. **47, 49**

If the video source is connected to a component video input, you must assign that input to an input selector, and your TV must be connected to either the HDMI output or COMPONENT VIDEO MONITOR OUT. **22, 49**

If the video source is connected to a composite video input, your TV must be connected to the HDMI output or the corresponding composite video output. **22**

If the video source is connected to an HDMI input, you must assign that input to an input selector, and your TV must be connected to the HDMI output. **21, 48**

While the Pure Audio listening mode is selected, the video circuitry is turned off and only video signals input through HDMI IN can be output.

On your TV, make sure that the video input to which the AV receiver is connected is selected.

If you selected "Both(Main)" or "Both(Sub)" in the "Monitor Out" setting, no picture may appear on your TV that is connected to a secondary HDMI output (not a priority HDMI output). In this case, change the setting to "Both".

■ There's no picture from a source connected to an HDMI IN

Reliable operation with an HDMI-to-DVI adapter is not guaranteed. In addition, video signals from a PC are not guaranteed. **109**

When the "Monitor Out" setting is set to "Analog", and the "Resolution" setting is set to anything other than "Through", no video is output by the HDMI outputs. **48**

When the "Resolution" is set to any resolution not supported by the TV, no video is output by the HDMI outputs. **48**

If the message "Resolution Error" appears on the AV receiver's display, this indicates that your TV does not support the current video resolution and you need to select another resolution on your DVD player.

■ The on-screen menus don't appear

(European and Asian models) Specify the TV system used in your area in the "TV Format". **63**

On your TV, make sure that the video input to which the AV receiver is connected is selected.

If your TV is connected to the analog outputs, set the "Monitor Out" setting to "Analog". **47**

■ The picture is distorted

(European and Asian models) Specify the TV system used in your area in the "TV Format". **63**

■ The on screen display does not appear

If you select other than "Analog" in the "Monitor Out" setting, the immediate display will not appear when the input signal from the COMPONENT VIDEO IN is output to a device connected to the COMPONENT VIDEO MONITOR OUT. **47**

Depending on the input signal, the on screen display may not appear when the input signal from the HDMI IN is output to a device connected to the HDMI output. **63**

Tuner

■ Reception is noisy, FM stereo reception is noisy, or the FM STEREO indicator doesn't light

Relocate your antenna. —

Move the AV receiver away from your TV or computer. —

Listen to the station in mono. **35**

When listening to an AM station, operating the remote controller may cause noise. —

Passing cars and airplanes can cause interference. —

Concrete walls weaken radio signals. —

If nothing improves the reception, install an outdoor antenna. —

Remote Controller

■ The remote controller doesn't work

Before operating this unit, be sure to press RECEIVER. —

Make sure that the batteries are installed with the correct polarity. **4**

Install new batteries. Don't mix different types of batteries, or old and new batteries. **4**

Make sure that the remote controller is not too far away from the AV receiver, and that there's no obstruction between the remote controller and the AV receiver's remote control sensor.	4
Make sure that the AV receiver is not subjected to direct sunshine or inverter-type fluorescent lights. Relocate if necessary.	—
If the AV receiver is installed in a rack or cabinet with colored-glass doors, the remote controller may not work reliably when the doors are closed.	—
Make sure you've selected the correct remote controller mode.	11, 94
When using the remote controller to control other manufacturers' AV components, some buttons may not work as expected.	—
Make sure you've entered the correct remote control code.	93
Make sure to set the same ID on both the AV receiver and remote controller.	64

■ Can't control other components

If it's an Onkyo component, make sure that the RI cable and analog audio cable are connected properly. Connecting only an RI cable won't work.	23
Make sure you've selected the correct remote controller mode.	11, 94
If you've connected an RI -capable Onkyo MD recorder, CD recorder, RI Dock to the TAPE IN/OUT jacks, or an RI Dock to the GAME IN or VCR/DVR IN jacks, for the remote controller to work properly, you must set the input display.	31
If you cannot operate it, you will need to enter the appropriate remote control code.	91
To control another manufacturer's component, point the remote controller at that component.	93
If none of the codes work, use the Learning function to learn the commands of the other component's remote controller.	97
To control an Onkyo component that's connected via RI , point the remote controller at the AV receiver. Be sure to enter the appropriate remote control code first.	93
To control an Onkyo component that's not connected via RI , point the remote controller at the component. Be sure to enter the appropriate remote control code first.	93
The entered remote control code may not be correct. If more than one code is listed, try each one.	—

■ Can't learn commands from another remote controller

When learning commands, make sure that the transmitting ends of both remote controllers are pointing at each other.	—
Are you trying to learn from a remote controller that cannot be used for learning? Some commands cannot be learned, especially those that contain several instructions.	—

Recording

■ Can't record

On your recorder, make sure the correct input is selected.	—
--	---

To prevent signal loops and damage to the AV receiver, input signals are not fed through to outputs with the same name (VCR/DVR IN to VCR/DVR OUT).	—
---	---

When the Pure Audio listening mode is selected, recording is not possible because no video signals are output. Select another listening mode.	—
---	---

Zone 2/3

■ The Zone 2/3 speakers produce no sound

To use the Zone 2 speakers, you must set the " Pow-ered Zone 2 " setting to " Act ".	82
To use the Zone 3 speakers, you must set the " Pow-ered Zone 3 " setting to " Act ".	82

Music Server and Internet Radio

■ Can't access the server or Internet radio

Check the network connection between the AV receiver and your router or switch.	—
Make sure that your modem and router are properly connected, and make sure they are both turned on.	—
Make sure the server is up and running and compatible with the AV receiver.	75
Check the "Network Settings".	76

■ Playback stops while listening to music files on the server

Make sure your server is compatible with the AV receiver.	75
If you download or copy large files on your computer, playback may be interrupted. Try closing any unused programs, use a more powerful computer, or use a dedicated server.	—
If the server is serving large music files to several networked devices simultaneously, the network may become overloaded and playback may be interrupted. Reduce the number of playback devices on the network, upgrade your network, or use a switch instead of a hub.	—

■ Can't connect to the AV receiver from a Web browser

If you're using DHCP, your router may not always allocate the same IP address to the AV receiver, so if you find that you can't connect to a server or Internet radio station, recheck the AV receiver's IP address on " Network " screen.	77
Check the "Network Settings".	76

USB Mass Storage Device Playback

■ Can't access the music files on a USB device

Make sure the USB device is plugged in properly.	—
The AV receiver supports USB devices that support the USB mass storage device class. However, playback may not be possible with some USB devices even if they conform to the USB mass storage device class.	—
USB memory devices with security functions cannot be played.	—

■ Stand-by power consumption

In the following cases, the power consumption may reach up to a maximum of 30W: **65, 76, 88**

1. You are using the Universal Port jack.
2. “Control” is set to “Enable” in the “Network” setting.
3. “HDMI Control(RIHD)” setting is set to “On”. (Depending on the TV status, the AV receiver will enter Standby mode as usual.)

■ The sound changes when I connect my headphones

When a pair of headphones is connected, the listening mode is set to Stereo, unless it's already set to Stereo, Mono, Direct, or Pure Audio. —

■ The speaker distance cannot be set as required

In some cases, corrected values suitable for home theater use may be set automatically. —

■ The display doesn't work

The display is turned off when the Pure Audio listening mode is selected. —

■ How do I change the language of a multiplex source

Use the “Multiplex” setting on the “Audio Adjust” **54** menu to select “Main” or “Sub”.

■ The RI functions don't work

To use **RI**, you must make an **RI** connection and an analog audio connection (RCA) between the component and AV receiver, even if they are connected digitally. **23**

While Zone 2 or Zone 3 is selected, the **RI** functions don't work. —

■ The functions System On/Auto Power On and Direct Change don't work for components connected via RI

While Zone 2 or Zone 3 is selected, the **RI** functions don't work. —

■ When performing “Audyssey MultEQ® XT32 Room Correction and Speaker Setup”, the measurement fails showing the message “Ambient noise is too high.”.

This can be caused by any malfunction in your speaker unit. Check if the unit produces normal sounds. —

■ The following settings can be made for the S-Video and composite video inputs

You must use the buttons on the unit to make these settings.

1. While holding down the input selector button for the input source that you want to set, press **SETUP**.
2. Use ◀/▶ to change the setting.
3. Press the input selector button for the input source that you want to set when you've finished.

• Video Attenuation

This setting can be made for the **BD/DVD**, **VCR/DVR**, **CBL/SAT**, **GAME**, or **AUX** input.

If you have a games console connected to the composite video input, and the picture isn't very clear, you can attenuate the gain.

Video ATT:OFF: (default).

Video ATT:ON: Gain reduced by 2dB.

The AV receiver contains a microcomputer for signal processing and control functions. In very rare situations, severe interference, noise from an external source, or static electricity may cause it to lockup. In the unlikely event that this happens, unplug the power cord from the wall outlet, wait at least five seconds, and then plug it back in again.

Onkyo is not responsible for damages (such as CD rental fees) due to unsuccessful recordings caused by the unit's malfunction. Before you record important data, make sure that the material will be recorded correctly.

Before disconnecting the power cord from the wall outlet, set the AV receiver to Standby.

Important Note Regarding Video Playback

The AV receiver can upconvert component video, S-Video, and composite video sources for display on a TV connected to the HDMI output. However, if the picture quality of the source is poor, upconversion may make the picture worse or disappear altogether.

In this case, try the following:

1 If the video source is connected to a component video input, connect your TV to the **COMPONENT VIDEO MONITOR OUT**.

If the video source is connected to an S-Video input, connect your TV to a **MONITOR OUT S**.

If the video source is connected to a composite video input, connect your TV to **MONITOR OUT V**.

2 On the main menu, select “Input/Output Assign”, and then select “HDMI Input”.

Select the relevant input selector, and assign it to “- - - -” (→ 48).

3 On the main menu, select “Input/Output Assign”, and then select “Component Video Input” (→ 49):

If the video source is connected to **COMPONENT VIDEO IN 1**, select the relevant input selector, and assign it to “**IN 1**”.

If the video source is connected to **COMPONENT VIDEO IN 2**, select the relevant input selector, and assign it to “**IN 2**”.

If the video source is connected to **COMPONENT VIDEO IN 3**, select the relevant input selector, and assign it to “**IN 3**”.

If the video source is connected to an S-Video input or composite video input, select the relevant input selector, and assign it to “- - - -”.

Note

- If “**Monitor Out**” setting is set to “**Analog**”, press **VCR/DVR** and **RETURN** on the AV receiver at the same time. Select “**Skip**” in the “**VideoProcessor**” setting on the display. To reset back to the original setting, press the same button at the same time. If you select “**Use**”, the AV receiver will output video signals from the video processor.

Specifications (TX-NR5008)

Amplifier Section

Rated Output Power All channels:	(North American) 145 watts minimum continuous power per channel, 8 ohm loads, 2 channels driven from 20 Hz to 20 kHz, with a maximum total harmonic distortion of 0.05% (FTC) 175 watts minimum continuous power per channel, 8 ohm loads, 2 channels driven at 1 kHz, with a maximum total harmonic distortion of 0.7% (FTC) 185 watts minimum continuous power per channel, 6 ohm loads, 2 channels driven at 1 kHz, with a maximum total harmonic distortion of 0.1% (FTC) (Others) 9 ch × 220 W at 6 ohms, 1 kHz, 1 ch driven (IEC)
Maximum Effective Output Power	(Asian) 9 ch × 280 W at 6 ohms, 1 kHz, 1 ch driven (JEITA)
Dynamic Power	400 W (3 Ω, Front) 300 W (4 Ω, Front) 180 W (8 Ω, Front)
THD (Total Harmonic Distortion)	0.05% (Power Rated)
Damping Factor	60 (Front, 1 kHz, 8 Ω)
Input Sensitivity and Impedance	200 mV/47 kΩ (LINE) 2.5 mV/47 kΩ (PHONO MM)
Rated RCA Output Level and Impedance	1 V/470 Ω (PRE OUT)
Maximum RCA Output Level and Impedance	5.5 V/470 Ω (PRE OUT)
Phono Overload	70 mV (MM 1 kHz 0.5%)
Frequency Response	5 Hz - 100 kHz/+1 dB, -3 dB (Direct mode)
Tone Control Characteristics	±10 dB, 50 Hz (BASS) ±10 dB, 20 kHz (TREBLE)
Signal to Noise Ratio	110 dB (LINE, IHF-A) 80 dB (PHONO, IHF-A)
Speaker Impedance	4 or 6 Ω - 16 Ω

Video Section

Input Sensitivity/Output Level and Impedance	1 V _{p-p} /75 Ω (Component and S-Video Y) 0.7 V _{p-p} /75 Ω (Component P _B /C _B , P _R /C _R) 0.28 V _{p-p} /75 Ω (S-Video C) 1 V _{p-p} /75 Ω (Composite)
Component Video Frequency Response	5 Hz - 100 MHz/+0 dB, -3 dB

Tuner Section

FM Tuning Frequency Range	(North American) 87.5 MHz - 107.9 MHz (Others) 87.5 MHz - 108.0 MHz, RDS
AM Tuning Frequency Range	522/530 kHz - 1611/1710 kHz
Preset Channel	40
Digital Tuner (North American)	SIRIUS

General

Power Supply	(North American) AC 120 V, 60 Hz (Others) AC 220 - 240 V, 50/60 Hz
Power Consumption	(North American) 12.8 A (Others) 1160 W
Stand-by Power Consumption	(North American) 0.2 W (Others) 0.3 W
Dimensions (W × H × D)	435 mm × 198.5 mm × 463.5 mm 17-1/8" × 7-13/16" × 18-1/4"
Weight	25.0 kg (55.1 lbs.)
■ HDMI	
Input	IN 1, IN 2, IN 3, IN 4, IN 5, IN 6, IN 7, AUX INPUT
Output	OUT MAIN, OUT SUB
Video Resolution	1080p
Audio Format	Dolby TrueHD, DTS Master Audio, DVD-Audio, DSD
Supported	3D, Audio Return Channel, Deep Color, x.v.Color, LipSync, CEC

■ Video Inputs

Component	IN 1, IN 2, IN 3
S-Video	BD/DVD, VCR/DVR, CBL/SAT, GAME
Composite	BD/DVD, VCR/DVR, CBL/SAT, GAME, AUX
Analog RGB input	PC IN

■ Video Outputs

Component	MONITOR OUT
S-Video	MONITOR OUT, VCR/DVR OUT
Composite	MONITOR OUT, VCR/DVR OUT, ZONE2 OUT

■ Audio Inputs

Digital	Optical: 3 (Rear), 1 (Front) Coaxial: 3
Analog	BD/DVD, VCR/DVR, CBL/SAT, GAME, PC, TAPE, TV/CD, AUX, PHONO
Multichannel Inputs	7.1

■ Audio Outputs

Analog	VCR/DVR, TAPE, ZONE 2 PRE OUT, ZONE 3 PRE OUT
Analog Multichannel Pre Outputs	9
Subwoofer Pre Outputs	2
Speaker Outputs	Main (L, R, C, SL, SR, SBL/Z3L, SBR/Z3R) + Front Wide/ZONE2 (L, R) + Front High (L, R)
Phones	1 (6.3 ϕ)

■ Others

SETUP MIC	1
RS232	1
Ethernet	1
IR Input	1
IR Output	1
12 V Trigger Out	2
USB	2 (Front and Rear)
Universal Port	1
RI	1

Specifications and features are subject to change without notice.

Specifications (TX-NR3008)

Amplifier Section

Rated Output Power All channels:	(North American) 140 watts minimum continuous power per channel, 8 ohm loads, 2 channels driven from 20 Hz to 20 kHz, with a maximum total harmonic distortion of 0.05% (FTC) 160 watts minimum continuous power per channel, 8 ohm loads, 2 channels driven at 1 kHz, with a maximum total harmonic distortion of 0.7% (FTC) 170 watts minimum continuous power per channel, 6 ohm loads, 2 channels driven at 1 kHz, with a maximum total harmonic distortion of 0.1% (FTC) (Others) 9 ch × 200 W at 6 ohms, 1 kHz, 1 ch driven (IEC)
Maximum Effective Output Power	(Asian) 9 ch × 250 W at 6 ohms, 1 kHz, 1 ch driven (JEITA)
Dynamic Power	320 W (3 Ω, Front) 270 W (4 Ω, Front) 160 W (8 Ω, Front)
THD (Total Harmonic Distortion)	0.05% (Power Rated)
Damping Factor	60 (Front, 1 kHz, 8 Ω)
Input Sensitivity and Impedance	200 mV/47 kΩ (LINE) 2.5 mV/47 kΩ (PHONO MM)
Rated RCA Output Level and Impedance	1 V/470 Ω (PRE OUT)
Maximum RCA Output Level and Impedance	5.5 V/470 Ω (PRE OUT)
Phono Overload	70 mV (MM 1 kHz 0.5%)
Frequency Response	5 Hz - 100 kHz/+1 dB, -3 dB (Direct mode)
Tone Control Characteristics	±10 dB, 50 Hz (BASS) ±10 dB, 20 kHz (TREBLE)
Signal to Noise Ratio	110 dB (LINE, IHF-A) 80 dB (PHONO, IHF-A)
Speaker Impedance	4 or 6 Ω - 16 Ω

Video Section

Input Sensitivity/Output Level and Impedance	1 V _{p-p} /75 Ω (Component and S-Video Y) 0.7 V _{p-p} /75 Ω (Component P _B /C _B , P _R /C _R) 0.28 V _{p-p} /75 Ω (S-Video C) 1 V _{p-p} /75 Ω (Composite)
Component Video Frequency Response	5 Hz - 100 MHz/+0 dB, -3 dB

Tuner Section

FM Tuning Frequency Range	(North American) 87.5 MHz - 107.9 MHz (Others) 87.5 MHz - 108.0 MHz, RDS
AM Tuning Frequency Range	522/530 kHz - 1611/1710 kHz
Preset Channel	40
Digital Tuner (North American)	SIRIUS

General

Power Supply	(North American) AC 120 V, 60 Hz (Others) AC 220 - 240 V, 50/60 Hz
Power Consumption	(North American) 11.6 A (Others) 1060 W
Stand-by Power Consumption	(North American) 0.2 W (Others) 0.3 W
Dimensions (W × H × D)	435 mm × 198.5 mm × 463.5 mm 17-1/8" × 7-13/16" × 18-1/4"
Weight	25.0 kg (55.1 lbs.)
■ HDMI	
Input	IN 1, IN 2, IN 3, IN 4, IN 5, IN 6, IN 7, AUX INPUT
Output	OUT MAIN, OUT SUB
Video Resolution	1080p
Audio Format	Dolby TrueHD, DTS Master Audio, DVD-Audio, DSD
Supported	3D, Audio Return Channel, Deep Color, x.v.Color, LipSync, CEC

■ Video Inputs

Component	IN 1, IN 2, IN 3
S-Video	BD/DVD, VCR/DVR, CBL/SAT, GAME
Composite	BD/DVD, VCR/DVR, CBL/SAT, GAME, AUX
Analog RGB input	PC IN

■ Video Outputs

Component	MONITOR OUT
S-Video	MONITOR OUT, VCR/DVR OUT
Composite	MONITOR OUT, VCR/DVR OUT, ZONE2 OUT

■ Audio Inputs

Digital	Optical: 2 (Rear), 1 (Front) Coaxial: 3
Analog	BD/DVD, VCR/DVR, CBL/SAT, GAME, PC, TAPE, TV/CD, AUX, PHONO
Multichannel Inputs	7.1

■ Audio Outputs

Analog	VCR/DVR, TAPE, ZONE 2 PRE OUT, ZONE 3 PRE OUT
Analog Multichannel Pre Outputs	9
Subwoofer Pre Outputs	2
Speaker Outputs	Main (L, R, C, SL, SR, SBL/Z3L, SBR/Z3R) + Front Wide/ZONE2 (L, R) + Front High (L, R)
Phones	1 (6.3 ϕ)

■ Others

SETUP MIC	1
RS232	1
Ethernet	1
IR Input	1
IR Output	1
12 V Trigger Out	2
USB	1 (Front)
Universal Port	1
RI	1

Specifications and features are subject to change without notice.

About HDMI

Designed to meet the increased demands of digital TV, HDMI (High Definition Multimedia Interface) is a new digital interface standard for connecting TVs, projectors, Blu-ray Disc/DVD players, set-top boxes, and other video components. Until now, several separate video and audio cables have been required to connect AV components. With HDMI, a single cable can carry control signals, digital video, and up to eight channels of digital audio (2-channel PCM, multichannel digital audio, and multichannel PCM).

The HDMI video stream (i.e., video signal) is compatible with DVI (Digital Visual Interface)*1, so TVs and displays with a DVI input can be connected by using an HDMI-to-DVI adapter cable. (This may not work with some TVs and displays, resulting in no picture.)

The AV receiver uses HDCP (High-bandwidth Digital Content Protection)*2, so only HDCP-compatible components can display the picture.

The AV receiver's HDMI interface is based on the following:
Audio Return Channel, 3D, x.v.Color, Deep Color, Lip Sync, DTS-HD Master Audio, DTS-HD High Resolution Audio, Dolby TrueHD, Dolby Digital Plus, DSD and Multichannel PCM

Supported Audio Formats

- 2-channel linear PCM (32–192 kHz, 16/20/24 bit)
- Multichannel linear PCM (up to 7.1 ch, 32–192 kHz, 16/20/24 bit)
- Bitstream (DSD, Dolby Digital, Dolby Digital Plus, Dolby TrueHD, DTS, DTS-HD High Resolution Audio, DTS-HD Master Audio)

Your Blu-ray Disc/DVD player must also support HDMI output of the above audio formats.

About Copyright Protection

The AV receiver supports HDCP (High-bandwidth Digital Content Protection)*2, a copy-protection system for digital video signals. Other devices connected to the AV receiver via HDMI must also support HDCP.

*1 DVI (Digital Visual Interface): The digital display interface standard set by the DDWG*3 in 1999.

*2 HDCP (High-bandwidth Digital Content Protection): The video encryption technology developed by Intel for HDMI/DVI. It's designed to protect video content and requires a HDCP-compatible device to display the encrypted video.

*3 DDWG (Digital Display Working Group): Lead by Intel, Compaq, Fujitsu, Hewlett Packard, IBM, NEC, and Silicon Image, this open industry group's objective is to address the industry's requirements for a digital connectivity specification for high-performance PCs and digital displays.

Note

- The HDMI video stream is compatible with DVI (Digital Visual Interface), so TVs and displays with a DVI input can be connected by using an HDMI-to-DVI adapter cable. (Note that DVI connections only carry video, so you'll need to make a separate connection for audio.) However, reliable operation with such an adapter is not guaranteed. In addition, video signals from a PC are not supported.
- The HDMI audio signal (sampling rate, bit length, etc.) may be restricted by the connected source component. If the picture is poor or there's no sound from a component connected via HDMI, check its setup. Refer to the connected component's instruction manual for details.

Using an RIHD-compatible TV, Player, or Recorder

RIHD, which stands for Remote Interactive over HDMI, is the name of the system control function found on Onkyo components. The AV receiver can be used with CEC (Consumer Electronics Control), which allows system control over HDMI and is part of the HDMI standard. CEC provides interoperability between various components, however, operation with components other than **RIHD**-compatible components cannot be guaranteed.

■ About **RIHD**-compatible components

The following components are **RIHD**-compatible. (As of February 2010) See the Onkyo web site for latest information.

TV

- Panasonic VIERA Link compatible TV
- Toshiba REGZA-LINK compatible TV
- Sharp TV (See Onkyo web site for latest information on compatible models.)

Players/Recorders

- Onkyo and Integra **RIHD**-compatible players
- Panasonic VIERA Link compatible players and recorders (only when used together with Panasonic VIERA Link compatible TV)
- Toshiba REGZA-LINK compatible players and recorders (only when used together with Toshiba REGZA-LINK compatible TV)
- Sharp players and recorders (only when used together with Sharp TV)

* Models other than those mentioned above may have some interoperability if compatible with CEC which is part of the HDMI Standard, but operation cannot be guaranteed.

Note

- Do not connect the **RIHD**-compatible component more than the following number to the HDMI input terminal so that the linked operations work properly.
 - Blu-ray Disc/DVD player is up to three.
 - Blu-ray Disc recorder/DVD recorder/Digital Video Recorder is up to three.
 - Cable/Satellite Set-top box is up to four.
- Do not connect the AV receiver to the other AV receiver/AV amplifier via HDMI.
- When the **RIHD**-compatible component more than the above-mentioned is connected, the linked operations are not guaranteed.

■ Operations that can be performed with **RIHD** connection

For **RIHD**-compatible TV

The following linked operation is possible by connecting the AV receiver to an **RIHD**-compatible TV.

- The AV receiver will enter Standby mode when the power of the TV is turned to Standby.
- You can set on the menu screen of the TV to either output the audio from the speakers connected to the AV receiver, or from the speakers of the TV.
- It is possible to output the video/audio from the antenna or from the input jack of the TV from the speakers connected to the AV receiver. (A connection such as optical digital cable or similar is required above the HDMI cable.)
- Input to the AV receiver can be selected with the remote controller of the TV.
- Operations such as volume adjustment or similar for the AV receiver can be performed from the remote controller of the TV.

For **RIHD**-compatible players/recorders

The following link operation is possible by connecting the AV receiver to an **RIHD**-compatible player/recorder.

- When the playback is started on the player/recorder, input of the AV receiver will switch to the HDMI input of the player/recorder that is playing back.
- Operation of the player/recorder is possible with the remote controller supplied with the AV receiver.

* Not all functions may operate depending on the model.

■ How to connect and setup

1 Confirm the connecting and setting.

1. Connect the **HDMI OUT MAIN** jack to the HDMI input jack of the TV.

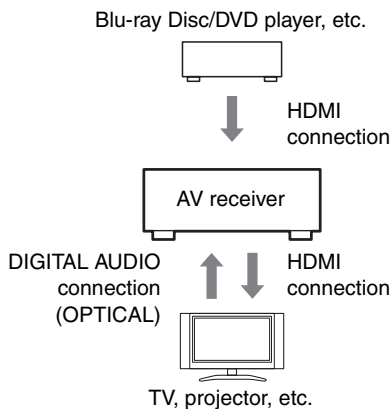

2. Connect the audio output from the TV to the **OPTICAL IN 2** jack of the AV receiver using an optical digital cable.

Note

- When you use the audio return channel (ARC) function with an HDMI (Audio Return Channel) capable TV, this connection is not required (→ 65).
3. Connect the HDMI output of the Blu-ray Disc/DVD player/recorder to the **HDMI IN 1** jack of the AV receiver.

Note

- It is necessary to assign the HDMI input when connecting the Blu-ray Disc/DVD player/recorder to other jacks (→ 48). Do not assign the components connected to the HDMI IN to the TV/CD input at this time. Appropriate CEC (Consumer Electronics Control) operation can not be guaranteed.

2 Change each item in the “HDMI” as below:

- **HDMI Control(RIHD): On**
- **Audio Return Channel (ARC): Auto**
- **Power Control: On**
- **TV Control: On**

See details of each setting (→ 65).

3 Confirm the settings.

1. Turn on the power for all connected components.
2. Turn off the power of the TV, and confirm that the power of the connected components is turned off automatically with the link operation.
3. Turn on the power of the Blu-ray Disc/DVD player/recorder.
4. Start playback of the Blu-ray Disc/DVD player/recorder, and confirm the following.
 - The power of the AV receiver is turned on automatically, and input with the Blu-ray Disc/DVD player/recorder connected is selected.
 - The power of the TV is turned on automatically, and input with the AV receiver connected is selected.
5. Following the operating instructions of the TV, select “Use the TV speakers” from the menu screen of the TV, and confirm that the audio is output from the speakers of the TV, and not from the speakers connected to the AV receiver.
6. Select “Use the speakers connected from the AV receiver” from the menu screen of the TV, and confirm that the audio is output from the speakers connected to the AV receiver, and not from the TV speakers.

Note

- Perform the above operations when you initially use the AV receiver, when the settings of each component are changed, when the main power of each component is turned off, when the power cable is disconnected from the power supply, or when there has been a power outage.

4 Operate with the remote controller.

See the list of available buttons (→ 95).

Note

- Audio from DVD-Audio or Super Audio CD may not output from the TV speakers. You will be able to output the audio from the TV speakers by setting the audio output of the DVD player to 2ch PCM. (It may not be possible depending on the player models.)
- Even if you set to output audio on the TV speakers, audio will be output from the speakers connected to the AV receiver when you adjust the volume or switch the input on the AV receiver. To output audio from the TV speakers, re-do the operations on the TV.
- Do not connect the **RI** cable when connecting to the **RI** and **RI** audio control compatible components.
- When you select anything other than the HDMI jack where the AV receiver is connected as the input on the TV, input on the AV receiver will be switched to “TV/CD”.
- The AV receiver will automatically power on in conjunction when it determines it to be necessary. Even if the AV receiver is connected to an **RIHD** compatible TV or player/recorder, it will not power on if it is not necessary. It may not power on in conjunction when the TV is set to output audio from the TV.
- Linked functions with the AV receiver may not work depending on the model. Operate the AV receiver directly in such cases.

Firmware Update

There are the following methods to update the firmware: via network and via USB storage. Please choose either one that suits your condition. Before you start, carefully read the update procedure. It will take about 60 minutes to update the firmware.

■ Update via network

You need a wired Internet connection to update the firmware.

■ Update via USB storage (→ 113)

Please prepare a USB storage device such as a USB flash memory stick. You need at least 32 MB of available space to update the firmware.

Note

- The storage media in the USB card reader may not work.
- If the storage device has been partitioned, each section will be treated as an independent device.
- If the USB mass storage device contains a lot of data, the AV receiver may take a while to read it.
- Operation with all USB mass storage devices including the ability to power them is not guaranteed.
- Onkyo accepts no responsibility whatsoever for the loss or damage to data stored on a USB mass storage device when that device is used with the AV receiver. We recommend that you back up your important music files beforehand.
- If you connect a USB hard disk drive to the USB port, we recommend that you use its AC adapter to power it.
- USB hubs and USB devices with hub functions are not supported. Do not connect your USB mass storage device via a USB hub.
- USB memory devices with security functions are not supported.
- In no event shall Onkyo be liable to you or any third party for any damages, whatsoever, arising from your use of or inability to use the firmware, including but not limited to, loss of any equipment, media or data, or other special, incidental or consequential damages, even if Onkyo has been advised of the possibility of such damages.

See the Onkyo web site for latest information.

Updating the Firmware via Network

The AV receiver allows you to update firmware using Network connection on rear panel.

* In this procedure, on-screen display may vary depending on the model.

Note

- Make sure your AV receiver and TV are turned on and Ethernet cable is connected to rear panel of the AV receiver.
- Never unplug or turn off the AV receiver during updating process.
- Never plug or unplug an HDMI cable and Ethernet cable during updating process.
- Never unplug the power cord during updating process.
- It will take about 60 minutes to update the firmware.
- The AV receiver will retain all your settings after update is finished.

Before you start

- Check “HDMI Control(RIHD)” setting (→ 65). The update may not be successful if this setting is on.
- Turn off the controller device connected via RS232C and via Ethernet network.
- Turn off Powered Zone 2 and Powered Zone 3.
- Stop playback of content from Internet Radio, iPod, USB or Servers, etc.

■ How to turn off RIHD

- 1** In the Main menu select “Hardware Setup”.
- 2** Select “HDMI”.
- 3** Set “HDMI Control(RIHD)” to “Off”.

Update procedure

- 1** Press **RECEIVER** followed by **SETUP** on the remote controller.
Main menu will be displayed on TV screen. Procedures thereafter can also be performed on the AV receiver by using its **SETUP**, arrow, and **ENTER** buttons.
- 2** Go to “Hardware Setup” menu.
- 3** Go to “Firmware Update” menu.
Note that the Firmware Update option will be grayed out about 50 seconds after AV receiver is turned on. Please wait.
- 4** Select “Via NET” and press **ENTER**.
- 5** Select “Update” and press **ENTER**.
Updating will begin.
As the updating progresses, the TV screen may disappear depending on the program updated. In this case, you can see the update progress on the front display of the AV receiver. The TV screen will reappear when you finish the update and turn on the AV receiver.
- 6** Message “Complete!” appears on the front display of the AV receiver, indicating that the update has been completed.
- 7** Using **ON/STANDBY** on the front panel, turn off and on the AV receiver.
Do not use **ON** or **STANDBY** on the remote controller.
Congratulations!! Now you have the latest firmware on your Onkyo AV receiver.

Troubleshooting

Case1:

If “No Update” is displayed on the front display of the AV receiver, the firmware has already been updated. You do not need to do anything further.

Case2:

If an error occurs, “Error!! *_** No media” is displayed on the front display of the AV receiver. (Alpha-numeric characters on the front display are denoted by asterisks.) See the following table and take appropriate action.

■ Errors during update via Network

Error Code	Description
*-10, *-20	Ethernet cable is not detected. Connect the cable properly.
*-11, *-13, *-21, *-28	Internet connection error. Check the following items: <ul style="list-style-type: none">• Make sure IP address, subnet mask, gateway address, and DNS server are configured properly.• Make sure the router is turned on.• Make sure the AV receiver and the router are connected with Ethernet cable.• Make sure the setup configuration of the router is set properly. See the instruction manual of the router.• If your network allows only one client connection and there is any other device already connected, the AV receiver cannot access the network. Consult your Internet Service Provider (ISP).• If your modem does not function as a router, you will need a router. Depending on your network, you may need to configure the proxy server if needed. See the document provided by your ISP. If you still cannot access the Internet, DNS or proxy server may be temporarily down. Contact your ISP.
Others	Retry the update procedure from the beginning. If the error persists, please contact Onkyo Support (→ 114) and provide the error code.

Case3:

If you do not have a wired connection to the network, please contact Onkyo Support (→ 114).

Case4:

If an error occurs during updating process, disconnect then reconnect the AC power cord and try again.

Case5:

If an error has occurred due to wrong selection of input sources, turn off and on the AV receiver. Then retry the update.

Updating the Firmware via USB

The AV receiver allows you to update firmware using a USB storage device.

* In this procedure, on-screen display may vary depending on the model.

Note

- Never unplug or turn off the AV receiver during updating process.
- Never plug or unplug an HDMI cable and a USB device during updating process.
- Never unplug the USB mass storage device and the power cord during updating process.
- It will take about 60 minutes to update the firmware.
- The AV receiver will retain all your settings after update is finished.

Before you start

- Check “HDMI Control(RIHD)” setting (→ 65). The update may not be successful if this setting is on.
- Turn off the controller device connected via RS232C and via Ethernet network.
- Turn off Powered Zone 2 and Powered Zone 3.
- Stop playback of content from Internet Radio, iPod, USB or Servers, etc.

■ How to turn off RIHD

- 1 In the Main menu select “Hardware Setup”.
- 2 Select “HDMI”.
- 3 Set “HDMI Control(RIHD)” to “Off”.

Update procedure

- 1 Connect a USB storage device to your PC. If there is any data in the USB storage, remove it.
- 2 Download the firmware file from the Onkyo web site. The file name is as follows:
ONKAVR0001_*****.zip
Unzip the downloaded file. The following three files are created:
ONKAVR0001_*****.of1
ONKAVR0001_*****.of2
ONKAVR0001_*****.of3
- 3 Copy the extracted files to the USB storage device. Be careful not to copy the zip file.
- 4 Remove the USB storage device from your PC and connect it to the USB port on the AV receiver.
When the AV receiver has two USB ports, you can use either one.
- 5 Make sure the AV receiver and TV are turned on.
If the AV receiver is in standby mode, press **ON/STANDBY** on the AV receiver to light up the front display.

- 6** Select the **USB** input source. “**Now Initializing**” is displayed on the front display and then the name of the USB storage device is displayed. It will take 20 to 30 seconds to recognize the USB storage device.
- 7** Press **RECEIVER** followed by **SETUP** on the remote controller. Main menu will be displayed on TV screen. Procedures thereafter can also be performed on the AV receiver by using its **SETUP**, arrow, and **ENTER** buttons.
- 8** Go to “**Hardware Setup**” menu.
- 9** Go to “**Firmware Update**” menu.
- 10** Select “**Via USB**” and press **ENTER**.
- 11** Select “**Update**” and press **ENTER**.
Updating will begin.
As the updating progresses, the TV screen may disappear depending on the program updated. In this case, you can see the update progress on the front display of the AV receiver. The TV screen will reappear when you finish the update and turn on the AV receiver.
Do not turn off the AV receiver and do not remove the USB storage device during updating process.
- 12** Message “**Complete!**” appears on the front display of the AV receiver, indicating that the update has been completed.
- 13** Using **ON/STANDBY** on the front panel, turn off the AV receiver and then remove the USB storage device.
* Do not use **ON** or **STANDBY** on the remote controller.
- 14** Press **ON/STANDBY** to turn on the AV receiver. Congratulations!! Now you have the latest firmware on your Onkyo AV receiver.

Troubleshooting

Case1:

If “**No Update**” is displayed on the front display of the AV receiver, the firmware has already been updated. You do not need to do anything further.

Case2:

If an error occurs, “**Error!! *.-** No media**” is displayed on the front display of the AV receiver. (Alpha-numeric characters on the front display are denoted by asterisks.) See the following table and take appropriate action.

■ Errors during update via USB

Error Code	Description
*-10, *-20	USB storage device is not detected. Make sure the USB flash memory or USB cable is properly connected to the USB port. If the USB storage device has its own power supply, use it to power the USB storage device.
*-14	An update file is not found in the root folder of the USB storage device, or an update file is for other model. Retry download following instructions at the support website. If the error persists, please contact Onkyo Support and provide the error code.
Others	Retry the update procedure from the beginning. If the error persists, please contact Onkyo Support and provide the error code.

Case3:

If an error occurs during the update, disconnect then reconnect the AC power cord and try again.

Case4:

If Error Code 3-51 is displayed, try the following procedure.

1. Disconnect the AC power cord then reconnect.
2. Start up this device, and select the **NET/USB** selector.
3. After the “**Now Initializing**” display has changed, perform the update again.

Case5:

If an error has occurred due to wrong selection of input sources, turn off and on the AV receiver. Then retry the update.

ONKYO CORPORATION

2-1, Nisshin-cho, Neyagawa-shi, OSAKA 572-8540, JAPAN

The Americas

ONKYO U.S.A. CORPORATION
18 Park Way, Upper Saddle River, N.J. 07458, U.S.A.
Tel: 800-229-1687, 201-785-2600
Fax: 201-785-2650
Hours: M-F 9am-8pm/Sat-Sun 10am-4pm ET
<<http://www.us.onkyo.com/>>

Europe

ONKYO EUROPE ELECTRONICS GmbH
Liegnitzerstrasse 6, 82194 Groebenzell, GERMANY
Tel: +49-8142-4401-0 Fax: +49-8142-4401-555
<<http://www.eu.onkyo.com/>>

China, Hong Kong

ONKYO CHINA LIMITED
Unit 1&12, 9/F, Ever Gain Plaza Tower 1, 88, Container Port Road, Kwai Chung, N.T., Hong Kong
Tel: 852-2429-3118 Fax: 852-2428-9039
<<http://www.onkyochina.com/>>

Asia, Oceania, Middle East, Africa

Please contact an ONKYO distributor referring to Onkyo SUPPORT site.
<http://www.intl.onkyo.com/support/local_support/index.html>

Video Resolution Chart

The following tables show how video signals at different resolutions are output by the AV receiver.

NTSC/PAL

✓: Output

Output		HDMI									
		1080p/24	1080p	1080i	720p	480p/576p	480i/576i	SXGA	XGA	SVGA	VGA
HDMI	1080p/24	✓	✓	✓	✓	✓					
	1080p	✓	✓	✓	✓	✓					
	1080i	✓	✓	✓	✓	✓					
	720p	✓	✓	✓	✓	✓					
	480p/576p	✓	✓	✓	✓	✓					
	480i/576i	✓	✓	✓	✓	✓	✓				
Component	1080p	✓	✓	✓	✓	✓					
	1080i	✓	✓	✓	✓	✓					
	720p	✓	✓	✓	✓	✓					
	480p/576p	✓	✓	✓	✓	✓					
	480i/576i	✓	✓	✓	✓	✓	✓				
S-Video Composite	480i/576i	✓	✓	✓	✓	✓	✓				
PC IN (Analog RGB)	SXGA		✓*2	✓*2	✓*2	✓*2		✓*2			
	XGA		✓*2	✓*2	✓*2	✓*2			✓*2		
	SVGA		✓*2	✓*2	✓*2	✓*2				✓*2	
	VGA		✓*2	✓*2	✓*2	✓*2					✓*2

Output		Component					S-Video Composite
		1080p	1080i	720p	480p/576p	480i/576i	480i/576i
HDMI	1080p/24						
	1080p						
	1080i						
	720p						
	480p/576p						
	480i/576i						
Component	1080p	✓*1	✓	✓	✓		
	1080i		✓	✓	✓		
	720p		✓	✓	✓		
	480p/576p		✓	✓	✓		
	480i/576i		✓	✓	✓	✓	
S-Video Composite	480i/576i		✓	✓	✓	✓	✓
PC IN (Analog RGB)	SXGA		✓*2	✓*2	✓*2		
	XGA		✓*2	✓*2	✓*2		
	SVGA		✓*2	✓*2	✓*2		
	VGA		✓*2	✓*2	✓*2		

*1 The superimposed menus cannot be displayed.

*2 The superimposed menus are displayed at only 60 Hz.

ONKYO

ONKYO SOUND & VISION CORPORATION

2-1, Nisshin-cho, Neyagawa-shi, OSAKA 572-8540, JAPAN

Tel: 072-831-8023 Fax: 072-831-8163

<http://www.onkyo.com/>

ONKYO U.S.A. CORPORATION

18 Park Way, Upper Saddle River, N.J. 07458, U.S.A.

Tel: 800-229-1687, 201-785-2600 Fax: 201-785-2650

<http://www.us.onkyo.com/>

ONKYO EUROPE ELECTRONICS GmbH

Liegnitzerstrasse 6, 82194 Groebenzell, GERMANY

Tel: +49-8142-4401-0 Fax: +49-8142-4401-555

<http://www.eu.onkyo.com/>

ONKYO EUROPE ELECTRONICS GmbH (UK BRANCH)

The Coach House 81A High Street, Marlow, Buckinghamshire, SL7 1AB, UK

Tel: +44-(0)1628-473-350 Fax: +44-(0)1628-401-700

ONKYO CHINA LIMITED

Unit 1033, 10/F, Star House, No 3, Salisbury Road, Tsim Sha Tsui Kowloon, Hong Kong.

Tel: 852-2429-3118 Fax: 852-2428-9039

<http://www.onkyochina.com/>

ONKYO CHINA PRC

1301, 555 Tower, No.555 West NanJin Road, Jin an, Shanghai,

China 200041, Tel: 86-21-52131366 Fax: 86-21-52130396

<http://www.cn.onkyo.com/>

Y1110-2

SN 29400433A

(C) Copyright 2011 ONKYO SOUND & VISION CORPORATION Japan. All rights reserved.



Download from Www.Somanuals.com. All Manuals Search And Download.

* 2 9 4 0 0 4 3 3 A *

Free Manuals Download Website

<http://myh66.com>

<http://usermanuals.us>

<http://www.somanuals.com>

<http://www.4manuals.cc>

<http://www.manual-lib.com>

<http://www.404manual.com>

<http://www.luxmanual.com>

<http://aubethermostatmanual.com>

Golf course search by state

<http://golfingnear.com>

Email search by domain

<http://emailbydomain.com>

Auto manuals search

<http://auto.somanuals.com>

TV manuals search

<http://tv.somanuals.com>