



English

Home Theater Speaker System

HTP-L50

Instruction Manual

Contents

- Important Safeguards..... 2
- Precautions 3
- Supplied Accessories..... 3
- Feature 4
- Control positions and names 4
- Speaker placement..... 5
- Connecting the speakers 6
- Adjustment procedure 7
- When using only the subwoofer
(SL-105)..... 7
- Precaution on use..... 8
- Troubleshooting guide..... 8
- Specifications 9

Thank you for purchasing the Onkyo home theater speaker system.
Please read this manual thoroughly before using it.
Following the instructions in this manual will enable you to obtain optimum performance and listening enjoyment from your new home theater speaker system.
Please retain this manual for future reference.



WARNING:

TO REDUCE THE RISK OF FIRE OR ELECTRIC SHOCK, DO NOT EXPOSE THIS APPLIANCE TO RAIN OR MOISTURE.

CAUTION:

TO REDUCE THE RISK OF ELECTRIC SHOCK, DO NOT REMOVE COVER (OR BACK). NO USER-SERVICEABLE PARTS INSIDE. REFER SERVICING TO QUALIFIED SERVICE PERSONNEL.



WARNING
RISK OF ELECTRIC SHOCK
DO NOT OPEN

AVIS
RISQUE DE CHOC ELECTRIQUE
NE PAS OUVRIR



The lightning flash with arrowhead symbol, within an equilateral triangle, is intended to alert the user to the presence of uninsulated "dangerous voltage" within the product's enclosure that may be of sufficient magnitude to constitute a risk of electric shock to persons.



The exclamation point within an equilateral triangle is intended to alert the user to the presence of important operating and maintenance (servicing) instructions in the literature accompanying the appliance.

Important Safeguards

- 1. Read Instructions** – All the safety and operating instructions should be read before the appliance is operated.
- 2. Retain Instructions** – The safety and operating instructions should be retained for future reference.
- 3. Heed Warnings** – All warnings on the appliance and in the operating instructions should be adhered to.
- 4. Follow Instructions** – All operating and use instructions should be followed.
- 5. Cleaning** – Unplug the appliance from the wall outlet before cleaning. The appliance should be cleaned only as recommended by the manufacturer.
- 6. Attachments** – Do not use attachments not recommended by the appliance manufacturer as they may cause hazards.
- 7. Water and Moisture** – Do not use the appliance near water –for example, near a bath tub, wash bowl, kitchen sink, or laundry tub; in a wet basement; or near a swimming pool; and the like.
- 8. Accessories** – Do not place the appliance on an unstable cart, stand, tripod, bracket, or table. The appliance may fall, causing serious injury to a child or adult, and serious damage to the appliance. Use only with a cart, stand, tripod, bracket, or table recommended by the manufacturer, or sold with the appliance. Any mounting of the appliance should follow the manufacturer's instructions, and should use a mounting accessory recommended by the manufacturer.
- 9. An appliance and cart combination** should be moved with care. Quick stops, excessive force, and uneven surfaces may cause the appliance and cart combination to overturn.
- 10. Ventilation** – Slots and openings in the cabinet are provided for ventilation and to ensure reliable operation of the appliance and to protect it from overheating, and these openings must not be blocked or covered. The openings should never be blocked by placing the appliance on a bed, sofa, rug, or other similar surface. The appliance should not be placed in a built-in installation such as a bookcase or rack unless proper ventilation is provided. There should be free space of at least 20 cm (8 in.) and an opening behind the appliance.
- 11. Power Sources** – The appliance should be operated only from the type of power source indicated on the marking label. If you are not sure of the type of power supply to your home, consult your appliance dealer or local power company.
- 12. Grounding or Polarization** – The appliance may be equipped with a polarized alternating current line plug (a plug having one blade wider than the other). This plug will fit into the power outlet only one way. This is a safety feature. If you are unable to insert the plug fully into the outlet, try reversing the plug. If the plug should still fail to fit, contact your electrician to replace your obsolete outlet. Do not defeat the safety purpose of the polarized plug.
- 13. Power-Cord Protection** – Power-supply cords should be routed so that they are not likely to be walked on or pinched by items placed upon or against them, paying particular attention to cords at plugs, convenience receptacles, and the point where they exit from the appliance.
- 14. Lightning** – For added protection for the appliance during a lightning storm, or when it is left unattended and unused for long periods of time, unplug it from the wall outlet and disconnect the antenna or cable system. This will prevent damage to the appliance due to lightning and power-line surges.
- 15. Overloading** – Do not overload wall outlets, extension cords, or integral convenience receptacles as this can result in a risk of fire or electric shock.
- 16. Object and Liquid Entry** – Never push objects of any kind into the appliance through openings as they may touch dangerous voltage points or short-out parts that could result in a fire or electric shock. Never spill liquid of any kind on the appliance.
- 17. Servicing** – Do not attempt to service the appliance yourself as opening or removing covers may expose you to dangerous voltage or other hazards. Refer all servicing to qualified service personnel.
- 18. Damage Requiring Service** – Unplug the appliance from the wall outlet and refer servicing to qualified service personnel under the following conditions:
 - A. When the power-supply cord or plug is damaged,
 - B. If liquid has been spilled, or objects have fallen into the appliance,
 - C. If the appliance has been exposed to rain or water,
 - D. If the appliance does not operate normally by following the operating instructions. Adjust only those controls that are covered by the operating instructions as an improper adjustment of other controls may result in damage and will often require extensive work by a qualified technician to restore the appliance to its normal operation,
 - E. If the appliance has been dropped or damaged in any way, and
 - F. When the appliance exhibits a distinct change in performance – this indicates a need for service.
- 19. Replacement Parts** – When replacement parts are required, be sure the service technician has used replacement parts specified by the manufacturer or have the same characteristics as the original part. Unauthorized substitutions may result in fire, electric shock, or other hazards.
- 20. Safety Check** – Upon completion of any service or repairs to the appliance, ask the service technician to perform safety checks to determine that the appliance is in proper operation condition.
- 21. Wall or Ceiling Mounting** – The appliance should be mounted to a wall or ceiling only as recommended by the manufacturer.
- 22. Heat** – The appliance should be situated away from heat sources such as radiators, heat registers, stoves, or other appliances (including amplifiers) that produce heat.
- 23. Liquid Hazards** – The appliance should not be exposed to dripping or splashing and no objects filled with liquids, such as vases should be placed on the appliance.

PORTABLE CART WARNING



S3125A

Precautions

1. Recording Copyright

Recording of copyrighted material for other than personal use is illegal without permission of the copyright holder.

2. AC Fuse

The fuse is located inside the chassis and is not user-serviceable. If power does not come on, contact your Onkyo authorized service station.

3. Care

From time to time you should wipe the front and rear panels and the cabinet with a soft cloth. For heavier dirt, dampen a soft cloth in a weak solution of mild detergent and water, wring it out dry, and wipe off the dirt. Following this, dry immediately with a clean cloth. Do not use rough material, thinners, alcohol or other chemical solvents or cloths since these could damage the finish or remove the panel lettering.

4. Power

WARNING

BEFORE PLUGGING IN THE UNIT FOR THE FIRST TIME, READ THE FOLLOWING SECTION CAREFULLY.

The voltage of the available power supply differs according to country or region. Be sure that the power supply voltage of the area where this unit will be used meets the required voltage (e.g., AC 230 V, 50 Hz or AC 120 V, 60 Hz) written on the rear panel.

For Canadian model

For models having a power cord with a polarized plug:

CAUTION: TO PREVENT ELECTRIC SHOCK, MATCH WIDE BLADE OF PLUG TO WIDE SLOT, FULLY INSERT.

Modèle pour les Canadien

Sur les modèles dont la fiche est polarisée:

ATTENTION: POUR ÉVITER LES CHOCS ÉLECTRIQUES, INTRODUIRE LA LAME LA PLUS LARGE DE LA FICHE DANS LA BORNE CORRESPONDANTE DE LA PRISE ET POUSSER JUSQU'AU FOND.

For European model

Declaration of Conformity

We, ONKYO EUROPE ELECTRONICS GmbH
LIEGNITZERSTRASSE 6,
82194 GROEBENZELL,
GERMANY



declare in own responsibility, that the ONKYO product described in this instruction manual is in compliance with the corresponding technical standards such as EN60065, EN55013, EN55020 and EN61000-3-2, -3-3.

GERMERING, GERMANY

I. MORI

ONKYO EUROPE ELECTRONICS GmbH

For British model

Replacement and mounting of an AC plug on the power supply cord of this unit should be performed only by qualified service personnel.

IMPORTANT

The wires in the mains lead are coloured in accordance with the following code:

Blue : Neutral

Brown : Live

As the colours of the wires in the mains lead of this apparatus may not correspond with the coloured markings identifying the terminals in your plug, proceed as follows:

The wire which is coloured blue must be connected to the terminal which is marked with the letter N or coloured black.

The wire which is coloured brown must be connected to the terminal which is marked with the letter L or coloured red.

IMPORTANT

A 5 ampere fuse is fitted in this plug. Should the fuse need to be replaced, please ensure that the replacement fuse has a rating of 5 amperes and that it is approved by ASTA or BSI to BS1362. Check for the ASTA mark or the BSI mark on the body of the fuse.

IF THE FITTED MOULDED PLUG IS UNSUITABLE FOR THE SOCKET OUTLET IN YOUR HOME THEN THE FUSE SHOULD BE REMOVED AND THE PLUG CUT OFF AND DISPOSED OF SAFELY. THERE IS A DANGER OF SEVERE ELECTRICAL SHOCK IF THE CUT OFF PLUG IS INSERTED INTO ANY 13 AMPERE SOCKET.

If in any doubt, please consult a qualified electrician.

Supplied Accessories

Make sure your box contains everything listed below. The number of accessories is indicated in brackets.

- Subwoofer (SL-105) [1]

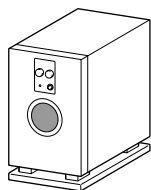

- Satellite speakers (D-L1) [5]

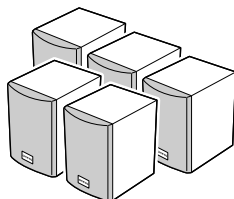

- Spacers for subwoofer [4]

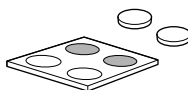

- Spacers for satellite speakers [20]

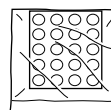

- Speaker cable for L/R front and center speakers, 3.5 m [3]



(Red) (White) (Green)

- Speaker cable for surround speakers, 8 m [2]



(Blue) (Gray)

- Pin cord [1]

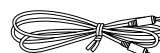

Feature

The HTP-L50 is a 5.1-channel speaker package that consists of five satellite speakers and one subwoofer with an internal amplifier.

The HTP-L50 features the SL-105 subwoofer with L/R mixing circuits and a built-in cut-off filter as the subwoofer and the D-L1 speakers with MDF (Medium Density

Fiberboard) cabinet and OMF-cone as the five satellite speakers. Simply connect the speakers to your AV amplifier or receiver for superb surround audio playback.

The speaker cables and satellite speaker terminals are color-coded to facilitate connection. Connect each cable to the matching-colored terminal.

Control positions and names

■ Subwoofer SL-105

Front panel

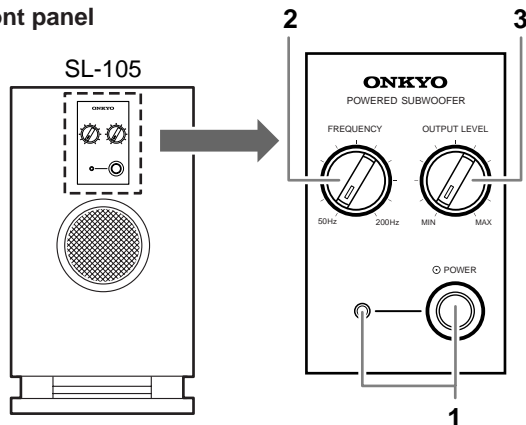

1 POWER switch and indicator

Pressing this button turns the power on (the indicator lights). Pressing the button again turns the power off (the indicator goes out).

Red: Unit is in standby mode
Green: Unit is in operation

2 FREQUENCY knob

Use this knob to select the high-frequency range at which you wish to cut off the signal to the subwoofer. You can select any frequency between 50 Hz and 200 Hz depending on the characteristics of the speaker system being used with the SL-105.

3 OUTPUT LEVEL knob

Use this knob to adjust the output level of the subwoofer.

Rear panel

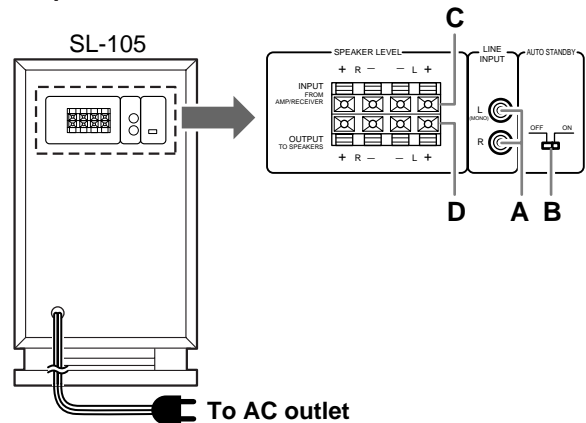

A LINE INPUT jacks

Connect these jacks to the LINE OUT jacks of the amplifier etc.

B AUTO STANDBY switch

This switch is used to turn on and off the auto standby function.

ON: This activates the auto standby function.

If a constant level signal is not received from the amplifier (or receiver) over a period of a few minutes, the SL-105 automatically enters the standby state. If a constant level signal is later received from the amplifier (or receiver), the power is automatically turned back on.

OFF: Deactivates the auto standby function.

Notes:

- The auto standby function operates on the existence or absence of a constant level input signal. If the auto standby function does not operate properly, try slightly increasing (or decreasing) the output level of the amplifier or receiver. (Note that output levels of some amplifiers and receivers cannot be adjusted. For more details regarding your components, refer to the instruction manual supplied with them.)
- If noise from peripheral components causes the incorrect operation of the auto standby function, or if outputting low volumes (i.e., during the nighttime) causes the auto standby function to activate, turn off the auto standby function.
- The auto standby function only operates while the power switch for the SL-105 is turned on.

C SPEAKER LEVEL INPUT terminals

Connect these input terminals to the speaker output terminals of your amplifier or receiver.

D SPEAKER LEVEL OUTPUT terminals

The speaker-level signal to the front speakers is output from these terminals.

Speaker placement

■ Layout of your speaker system

Satellite speakers

• Front left/right speakers and center speakers

These three speakers should be placed in front of the listener.

All three speakers should be placed at the same level.

Placement should be such so that the speakers all aim at the ears of the listener when the listener is listening to music or watching the screen. The center speakers enhance the sound effects from the two front speakers and add clarity to movements in the sound for a much richer sound image.

• Surround left/right speakers

Surround speakers should be placed to the side of the listener or behind the listener. These speakers produce sound movements in all directions, create a sound environment that reflects the background, and create the sensation of being in the middle of the action.

Subwoofer

The subwoofer can be installed anywhere in the room, but in most situations you will obtain the best results by placing the subwoofer to the side near a corner of the room. The quality and level of the bass sounds from the subwoofer will differ depending on the location where the subwoofer is placed and the layout of the room, so it is recommended to place the subwoofer in several locations and find the position that provides the best results.

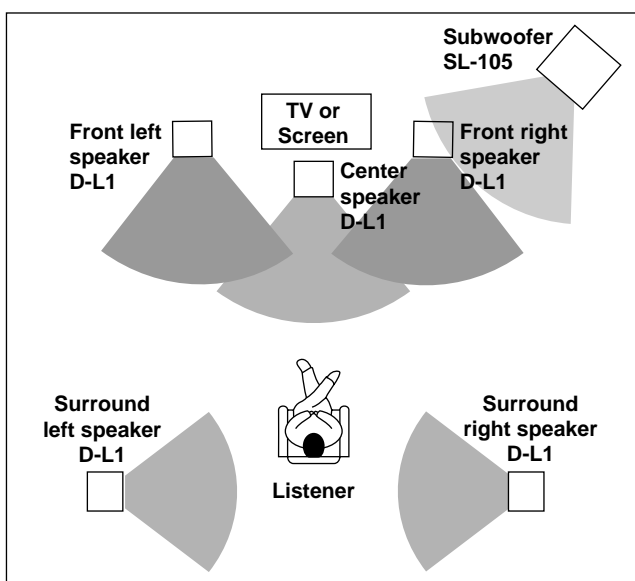

■ Satellite speaker

Installation using commercially-available stands and fixtures

The speaker bottom and rear are equipped with screw holes so that you can attach commercially-available stands or mounting fixtures for a variety of mounting options. (Two M5 screw holes, 60 mm pitch on the bottom and one M5 screw hole on the rear.)

Note:

When attaching an accessory item to a speaker, be careful of the length of the screws used. Use only screws that provide the required strength with a screw length between 7 and 12 mm.

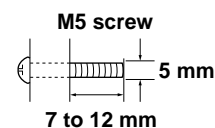

■ Using spacers

Attaching the supplied spacers is recommended for obtaining the best sound quality. Also, by attaching the provided spacers, the speakers will not slide easily for a more stable installation.

• Positioning vertically

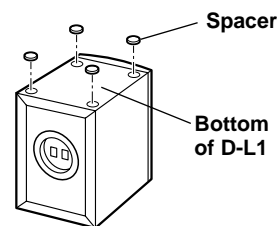

• Positioning horizontally

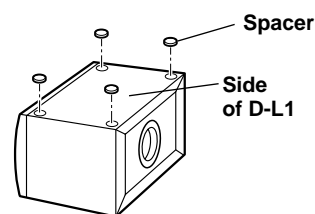

Connecting the speakers

For safety reasons, do not turn on any devices or components until you have completed all wiring procedures.

■ Connecting the satellite speakers

Note:

The nominal impedance of this speaker system is 6 Ω. Use only amplifiers capable of handling this impedance.

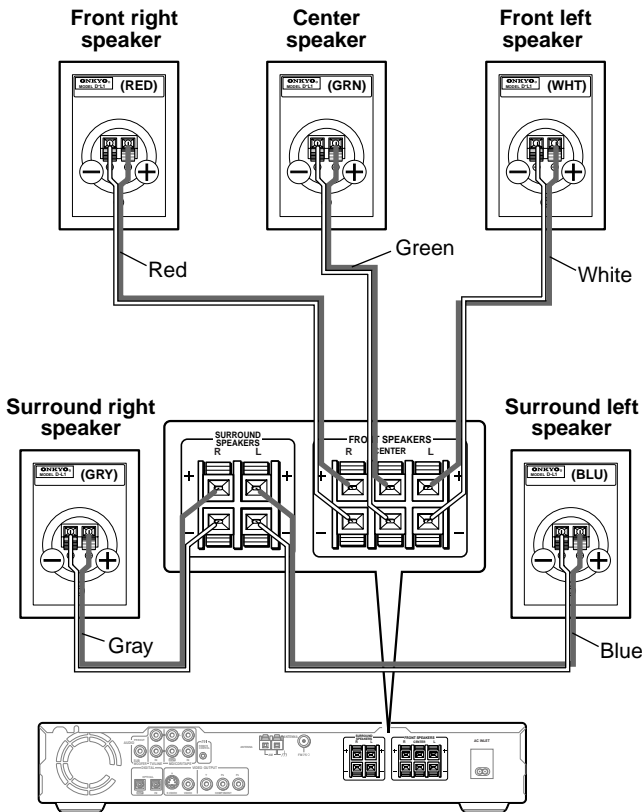

- Connect the input terminals on the rear of the satellite speakers to the speaker output terminals on the AV amplifier or receiver using the supplied speaker cables as shown in the diagram to the left.

- Each speaker cable should be connected to the speaker terminal of the same color.

The speaker's terminals are colored as follows.

- Front left speaker (+) : white
- Front right speaker (+) : red
- Center speaker (+) : green
- Surround left speaker (+) : blue
- Surround right speaker (+) : gray

Notes:

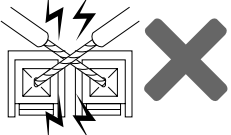
- Make sure that the positive (+) and negative (-) speaker cables do not contact each other. If they do, a short-circuit may occur, causing damage to the amplifier. 
- Be sure to connect the speaker cables with the correct polarity (+ and -) and with the proper left-right speaker orientation. If connected incorrectly, the resulting sound space with sound unnatural.
- Pull the speaker cable lightly to ensure that it is connected firmly.

■ Connecting the subwoofer

When used together with an AV amplifier or receiver with surround playback capabilities, be sure to connect its SUB WOOFER PREOUT terminal to the subwoofer SL-105 using the supplied pin-cord.

If you connect the subwoofer SL-105 using speaker cables, depending on the settings at the AV amplifier or receiver, bass signals may be cut for an unsatisfactory bass output. For more details regarding connection procedures, refer to the manuals that came with your AV amplifier or receiver.

Before connecting

Prepare the supplied speaker cables as shown below.



Strip off the end of the speaker cable insulation.

Twist together the exposed wires strands.

Connecting to the speaker terminals

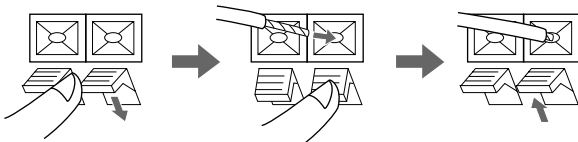

Push down the lever.

Insert the exposed wires into the hole.

Release the lever.

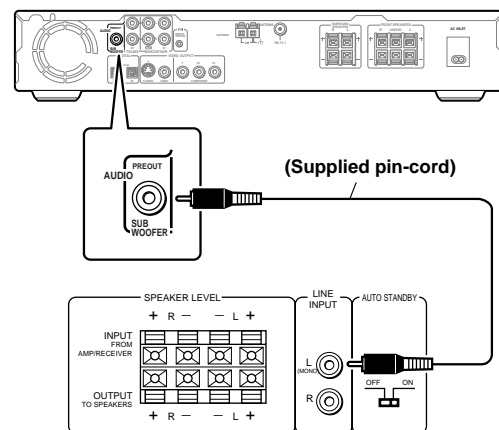

Connect the SUB WOOFER PREOUT terminal on your AV amplifier or receiver to the subwoofer rear panel using the supplied pin-cord as shown in the diagram above.

Note:

If the amplifier has a subwoofer terminal, since its output is monaural, connect it to the low level LINE INPUT L(MONO) terminal on the subwoofer SL-105.

Adjustment procedure

■ Adjusting the cut-off frequency and volume

Use the cut-off frequency (FREQUENCY) and volume (OUTPUT LEVEL) knobs on the front of the subwoofer (SL-105) and adjust the levels to the desired level in accordance with the layout of your room and the positioning of all your components. If the playback frequency range and volume of the subwoofer are not set to proper levels, distortions in the playback characteristics can result.

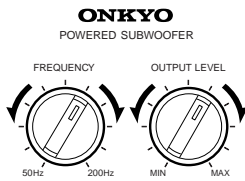

Recommended level for the HTP-L50 package system

Although it is recommended to set the cut-off frequency and output level settings as high as possible, it is difficult to notice the extremely low frequency bass sounds. This makes it possible to accidentally set the volume level too high. In order to prevent this, back the levels down just a bit to ensure the proper balance.

Note:

Make sure that the input levels do not reach excessive levels. The HTP-L50 is designed for playing back music at a normal volume, but if the input levels are set to enormous levels, it may damage the speakers. Also, always first lower the volume at the amplifier before changing the settings of any switches to prevent accidental damage.

When using only the subwoofer (SL-105)

■ Connection with a preamplifier

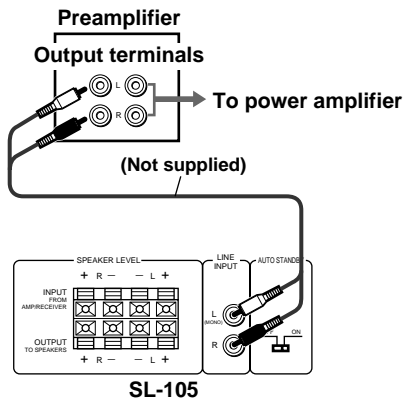

Note:

With an ordinary preamplifier having two output channels, connect both the Right and Left jacks.

■ Connection to amplifier's (receiver's) speaker terminals

1. Using speaker cables and the speaker cables that came with your speakers, connect the SL-105's SPEAKER LEVEL INPUT terminals and the amplifier's speaker terminals.
2. Connect the Right and Left speakers to the SL-105's SPEAKER LEVEL OUTPUT terminals.

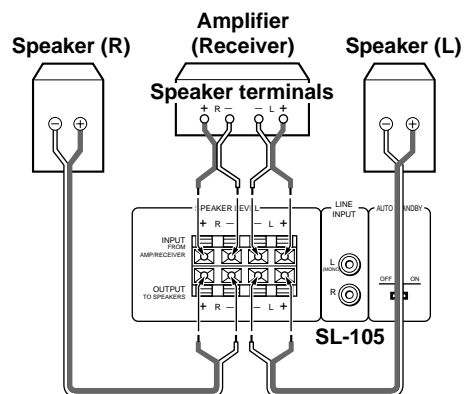

For details on how to connect the speaker cables, see the previous page.

Notes:

- When connecting the speaker cables, be sure not to mistake the (+) and (-) and the L (left) and R (right). If the speaker cables are connecting incorrectly, there will be a loss of fidelity in the bass sound ranges.
- The speakers connected to the SL-105 SPEAKER LEVEL OUTPUT terminals must have an impedance equal to or greater than the rating indicated on the amplifier connected to the SPEAKER LEVEL INPUT terminals. Otherwise, amplifier damage may occur.
- Do not use BTL (Balanced Transformer-Less) type amplifiers. Using a BTL amplifier may cause damage to both the amplifier and the subwoofer. Ordinary amplifiers are not BTL amplifiers. For details, see the amplifier's instruction manual.

Precaution on use

■ Placement

- The enclosure is made of wood and therefore sensitive to extreme temperatures and humidity. Avoid placing the unit in locations subjected to direct sunlight or in humid places such as near an air conditioner, bathroom or kitchen, as well as in locations subjected to soot or steam such as near a kitchen table and humidifier. Otherwise, damage may occur.
- Keep water or other liquids away from the unit. If water is spilled into the unit, not only the unit but also the connected amplifier (receiver) may be damaged.
- Place the unit on a level and rigid surface free from vibration.
- Slip-proof spacers are provided with the SL-105. If the SL-105 is to be placed on flooring or other similar surfaces, attach these spacers to the bottom surface at the corners. This will not only prevent scratching, but also provide a stable footing. However, note that depending on the surface, the spacers may leave markings.
- This unit is designed to be used in the upright vertical position only. Do not use it in the horizontal or tilted position.
- If the unit is used near a turntable or CD player, howling or skipping of sound may occur. To prevent this, move the unit away from the turntable or CD player or otherwise lower the unit's output level.
- This unit can handle the specified input power when it is used for ordinary music reproduction. If the following abnormal signals are fed to the unit, however, an overcurrent may flow in the internal circuits, causing burning or breakage of the wires even if the input power is below the specified rating.
 1. Special test signals produced by audio checking CD, etc.
 2. Sound produced when connecting or disconnecting audio connection cables.
(Always turn off the amplifier's power before connecting or disconnecting cables.)
 3. Howling when a microphone is used.
 4. Abnormal sound produced when bass-range signals are excessively boosted by using the amplifier's (receiver's) tone controls, a graphic equalizer, etc., or when a source whose bass range is abnormally boosted is being played. This state called "rattling" occurs when the signal is beyond the driver's reproduction capacity. Although it is not a sign of damage, decrease the speaker output level to prevent damage to the driver.

Troubleshooting guide

■ Subwoofer SL-105

Symptom	Cause	Remedy
The unit does not turn on.	<ul style="list-style-type: none"> • The power plug is not fully inserted. 	<ul style="list-style-type: none"> • Insert the power plug fully into the power outlet.
No sound output	<ul style="list-style-type: none"> • The OUTPUT LEVEL knob is set to the MIN level. • Pin-connector cable(s) are disconnected at the LINE INPUT jacks. • Speaker cables are not properly connected to the SPEAKER LEVEL INPUT terminals. • The speaker setting at the amplifier (or receiver) is set to "Subwoofer No." • The input signal is so small that the unit entered the standby state. 	<ul style="list-style-type: none"> • Set the OUTPUT LEVEL knob properly. • Connect cable(s) to the LINE INPUT jacks. • Connect the speaker cables properly. • Check the settings at the amplifier (or receiver). • Slightly increase the output level at the amplifier (or receiver). • Set the AUTO STANDBY switch to OFF.
Small sound output	<ul style="list-style-type: none"> • Speaker cables are connected to the SPEAKER LEVEL INPUT terminals with reversed phase. • Playing source does not include superbass sound. 	<ul style="list-style-type: none"> • Connect the speaker cables properly. • Play sources with superbass sound.
Hum noise	<ul style="list-style-type: none"> • Pin-connector cable is not inserted completely. • External leakage flux (induction noise by TV etc.) occurs. 	<ul style="list-style-type: none"> • Fully insert the pin-connector cable. • Separate from the noise source and connect.

■ Satellite speaker D-L1

Symptom	Cause	Remedy
No sound output	<ul style="list-style-type: none"> • Speaker cables are not properly connected. 	<ul style="list-style-type: none"> • Connect the speaker cables properly.

Specifications

■ Subwoofer SL-105

Type	Bass-reflex with built-in power amplifier
Use	For superbass-range reproduction
Frequency response	30-200 Hz (at maximum crossover frequency)
Crossover frequency	50-200 Hz (variable)
Maximum output power	60 W
Input impedance	4.7 k Ω (for speaker-level input terminals) 12 k Ω (for low-level input jacks)
Sensitivity	Speaker-Level 2 V Line 45 mV
Speaker	20-cm woofer
Power supply	AC 120 V, 60 Hz AC 220 - 230 V, 50/60 Hz AC 230 - 240 V, 50 Hz
Power consumption	70 W (AC 120 V, 60 Hz) 42 W (AC 220 - 230 V, 50/60 Hz, AC 230 - 240 V, 50 Hz)
Dimensions (W \times H \times D)	235 \times 416 \times 404 mm 9-1/4" \times 16-3/8" \times 15-7/8"
Weight	12.5 kg 27.6 lbs.
Others	AUTO STANDBY ON/OFF (with CANCELLING Switch)

■ Satellite speaker D-L1

Type	Air suspension
Frequency response	125 Hz - 25 kHz
Maximum input power	30 W
Output sound pressure level	83 dB/W/m
Impedance	6 Ω
Speaker	8-cm OMF cone
Cabinet capacity	0.6 L
Dimensions (W \times H \times D)	85 \times 120 \times 112 mm 3-3/8" \times 4-3/4" \times 4-7/16"
Weight	0.7 kg 1.5 lbs.
Others	Magnetic shielding

Specifications and appearance may subject to change for improvement without prior notice.

ONKYO CORPORATION

Sales & Product Planning Div. : 2-1, Nisshin-cho, Neyagawa-shi, OSAKA 572-8540, JAPAN
Tel: 072-831-8111 Fax: 072-833-5222 <http://www.onkyo-intl.com>

ONKYO U.S.A. CORPORATION

18 Park Way, Upper Saddle River, N.J. 07458, U.S.A.
Tel: 201-785-2600 Fax: 201-785-2650 <http://www.onkyousa.com>

ONKYO EUROPE ELECTRONICS GmbH

Liegnitzerstrasse 6, 82194 Groebenzell, GERMANY
Tel: +49-8142-4401-0 Fax: +49-8142-4401-555 <http://www.onkyo.net>

ONKYO CHINA LIMITED

Units 2102-2107, Metroplaza Tower I, 223 Hing Fong Road, Kwai Chung,
N.T., HONG KONG Tel: 852-2429-3118 Fax: 852-2428-9039 <http://www.onkyochina.com>



Free Manuals Download Website

<http://myh66.com>

<http://usermanuals.us>

<http://www.somanuals.com>

<http://www.4manuals.cc>

<http://www.manual-lib.com>

<http://www.404manual.com>

<http://www.luxmanual.com>

<http://aubethermostatmanual.com>

Golf course search by state

<http://golfingnear.com>

Email search by domain

<http://emailbydomain.com>

Auto manuals search

<http://auto.somanuals.com>

TV manuals search

<http://tv.somanuals.com>