

ONKYO®

Integrated Amplifier

A-933

Instruction Manual

Thank you for purchasing an Onkyo Integrated Amplifier. Please read this manual thoroughly before making connections and plugging in the unit.

Following the instructions in this manual will enable you to obtain optimum performance and listening enjoyment from your new Integrated Amplifier.

Please retain this manual for future reference.

Contents

Introduction 2

Connections 10

Enjoying Audio Sources..... 17

Troubleshooting 20

Specifications 22

En

WARNING:

TO REDUCE THE RISK OF FIRE OR ELECTRIC SHOCK, DO NOT EXPOSE THIS APPARATUS TO RAIN OR MOISTURE.

CAUTION:

TO REDUCE THE RISK OF ELECTRIC SHOCK, DO NOT REMOVE COVER (OR BACK). NO USER-SERVICEABLE PARTS INSIDE. REFER SERVICING TO QUALIFIED SERVICE PERSONNEL.



WARNING
RISK OF ELECTRIC SHOCK
DO NOT OPEN

AVIS
RISQUE DE CHOC ELECTRIQUE
NE PAS OUVRIR



The lightning flash with arrowhead symbol, within an equilateral triangle, is intended to alert the user to the presence of uninsulated "dangerous voltage" within the product's enclosure that may be of sufficient magnitude to constitute a risk of electric shock to persons.



The exclamation point within an equilateral triangle is intended to alert the user to the presence of important operating and maintenance (servicing) instructions in the literature accompanying the appliance.

Important Safety Instructions

1. Read these instructions.
2. Keep these instructions.
3. Heed all warnings.
4. Follow all instructions.
5. Do not use this apparatus near water.
6. Clean only with dry cloth.
7. Do not block any ventilation openings. Install in accordance with the manufacturer's instructions.
8. Do not install near any heat sources such as radiators, heat registers, stoves, or other apparatus (including amplifiers) that produce heat.
9. Do not defeat the safety purpose of the polarized or grounding-type plug. A polarized plug has two blades with one wider than the other. A grounding type plug has two blades and a third grounding prong. The wide blade or the third prong are provided for your safety. If the provided plug does not fit into your outlet, consult an electrician for replacement of the obsolete outlet.
10. Protect the power cord from being walked on or pinched particularly at plugs, convenience receptacles, and the point where they exit from the apparatus.
11. Only use attachments/accessories specified by the manufacturer.
12. Use only with the cart, stand, tripod, bracket, or table specified by the manufacturer, or sold with the apparatus. When a cart is used, use caution when moving the cart/apparatus combination to avoid injury from tip-over.  PORTABLE CART WARNING
S3125A
13. Unplug this apparatus during lightning storms or when unused for long periods of time.
14. Refer all servicing to qualified service personnel. Servicing is required when the apparatus has been damaged in any way, such as power-supply cord or plug is damaged, liquid has been spilled or objects have fallen into the apparatus, the apparatus has been exposed to rain or moisture, does not operate normally, or has been dropped.
15. Damage Requiring Service
Unplug the apparatus from the wall outlet and refer servicing to qualified service personnel under the following conditions:
 - A. When the power-supply cord or plug is damaged,
 - B. If liquid has been spilled, or objects have fallen into the apparatus,
 - C. If the apparatus has been exposed to rain or water,
 - D. If the apparatus does not operate normally by following the operating instructions. Adjust only those controls that are covered by the operating instructions as an improper adjustment of other controls may result in damage and will often require extensive work by a qualified technician to restore the apparatus to its normal operation,
 - E. If the apparatus has been dropped or damaged in any way, and
 - F. When the apparatus exhibits a distinct change in performance this indicates a need for service.
16. Object and Liquid Entry
Never push objects of any kind into the apparatus through openings as they may touch dangerous voltage points or short-out parts that could result in a fire or electric shock.
The apparatus shall not be exposed to dripping or splashing and no objects filled with liquids, such as vases shall be placed on the apparatus.
Don't put candles or other burning objects on top of this unit.
17. Batteries
Always consider the environmental issues and follow local regulations when disposing of batteries.
18. If you install the apparatus in a built-in installation, such as a bookcase or rack, ensure that there is adequate ventilation.
Leave 20 cm (8") of free space at the top and sides and 10 cm (4") at the rear. The rear edge of the shelf or board above the apparatus shall be set 10 cm (4") away from the rear panel or wall, creating a flue-like gap for warm air to escape.

Precautions

- 1. Recording Copyright**—Unless it's for personal use only, recording copyrighted material is illegal without the permission of the copyright holder.
- 2. AC Fuse**—The AC fuse inside the unit is not user-serviceable. If you cannot turn on the unit, contact your Onkyo dealer.
- 3. Care**—Occasionally you should dust the unit all over with a soft cloth. For stubborn stains, use a soft cloth dampened with a weak solution of mild detergent and water. Dry the unit immediately afterwards with a clean cloth. Don't use abrasive cloths, thinners, alcohol, or other chemical solvents, because they may damage the finish or remove the panel lettering.

4. Power
WARNING

BEFORE PLUGGING IN THE UNIT FOR THE FIRST TIME, READ THE FOLLOWING SECTION CAREFULLY.

AC outlet voltages vary from country to country. Make sure that the voltage in your area meets the voltage requirements printed on the unit's rear panel (e.g., AC 230 V, 50 Hz or AC 120 V, 60 Hz).

Some models have a voltage selector switch for compatibility with power systems around the world. Before you plug in such a model, make sure that the voltage selector is set to the correct voltage for your area.

- 5. Never Touch this Unit with Wet Hands**—Never handle this unit or its power cord while your hands are wet or damp. If water or any other liquid gets inside this unit, have it checked by your Onkyo dealer.
- 6. Handling Notes**
 - If you need to transport this unit, use the original packaging to pack it how it was when you originally bought it.
 - Do not leave rubber or plastic items on this unit for a long time, because they may leave marks on the case.
 - This unit's top and rear panels may get warm after prolonged use. This is normal.
 - If you do not use this unit for a long time, it may not work properly the next time you turn it on, so be sure to use it occasionally.

For British models

Replacement and mounting of an AC plug on the power supply cord of this unit should be performed only by qualified service personnel.

IMPORTANT

The wires in the mains lead are coloured in accordance with the following code:

- Blue: Neutral
- Brown: Live

As the colours of the wires in the mains lead of this apparatus may not correspond with the coloured markings identifying the terminals in your plug, proceed as follows:

The wire which is coloured blue must be connected to the terminal which is marked with the letter N or coloured black.

The wire which is coloured brown must be connected to the terminal which is marked with the letter L or coloured red.

IMPORTANT

The plug is fitted with an appropriate fuse. If the fuse needs to be replaced, the replacement fuse must approved by ASTA or BSI to BS1362 and have the same ampere rating as that indicated on the plug. Check for the ASTA mark or the BSI mark on the body of the fuse. If the power cord's plug is not suitable for your socket outlets, cut it off and fit a suitable plug. Fit a suitable fuse in the plug.

For European Models

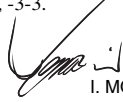
Declaration of Conformity	
We, ONKYO EUROPE ELECTRONICS GmbH LIEGNITZERSTRASSE 6, 82194 GROEBENZELL, GERMANY	
declare in own responsibility, that the ONKYO product described in this instruction manual is in compliance with the corresponding technical standards such as EN60065, EN55013, EN55020 and EN61000-3-2, -3-3.	
GROEBENZELL, GERMANY	 I. MORI
ONKYO EUROPE ELECTRONICS GmbH	

Features

- Separate design allows various component configurations**
- Stereo digital amp featuring Onkyo's unique VL (Vector Linear) Digital technology**
- Can be used as a power amplifier with a separate preamp (MAIN IN function)**
- Super Bass, Bass, and Treble tone controls**
- Selectable A/B speaker outputs**
- Included remote controller can be used with other Onkyo components**
- Phono input for connecting a turntable**

Supplied Accessories

Make sure you have the following accessories:

**Remote controller (RC-613S)
& two batteries (AA/R6)**

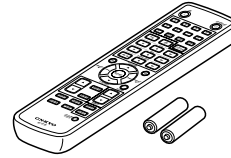

In catalogs and on packaging, the letter added to the end of the product name indicates the color of the A-933. Specifications and operation are the same regardless of color.

Table of Contents

Introduction

Important Safety Instructions	2
Precautions	3
Features	4
Supplied Accessories	4
Table of Contents	5
Front & Rear Panels	6
Front Panel	6
Rear Panel	7
Remote Controller (RC-613S)	8
Installing the Batteries	9
Using the Remote Controller	9

Connections

Connecting the A-933	10
About the System Functions	10
Connecting Your Speakers	11
Connecting a Subwoofer	12
Hookup Diagrams for Onkyo Separate Collection	13
Audio Components	14
Connecting a CD player	14
Connecting an MD Recorder	14
Connecting a Tuner	14
Connecting a Cassette Deck	14
Connecting a Turntable	15
Connecting a TV or Other Component with an Audio Output	15
Connecting a Preamp	15
Connecting Another Component's Power Cord	15
Connecting RI Components	16
Connecting the Power Cord	16

Enjoying Audio Sources

Turning on the A-933	17
Listening to Components	17
Selecting Speaker Set A or B	17
Muting the A-933 (remote controller only)	18
Using Headphones	18
Using the Tone Controls	18
Selecting Tone or Direct Mode	18
Adjusting the Super Bass	18
Adjusting the Bass	18
Adjusting the Treble	18
Using the MAIN IN Function	19
Recording	19

Others

Troubleshooting	20
Specifications	22

Front & Rear Panels

Front Panel

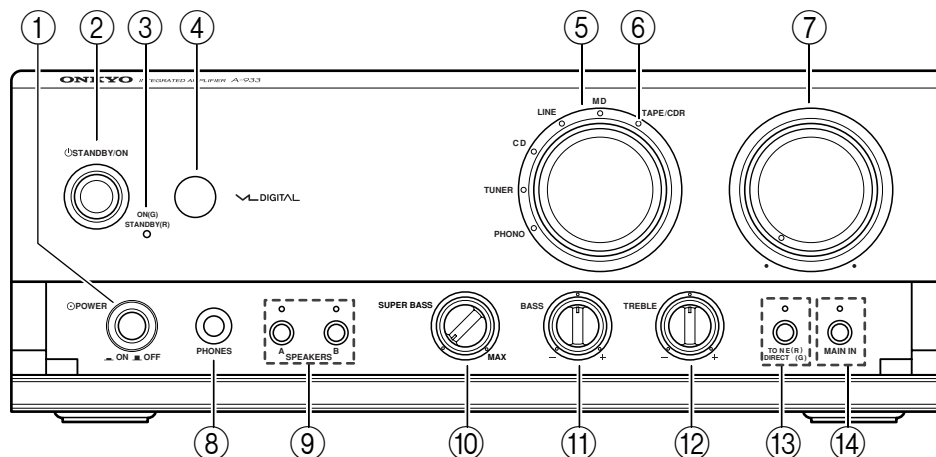

For detailed information, refer to the pages in parentheses.

- ① **POWER switch (17)**
This is the main power switch. When set to OFF, the A-933 is completely shutdown. When set to ON, the A-933 can be set to On or Standby.
- ② **STANDBY/ON button (17)**
This button is used to set the A-933 to On or Standby. For models with a [POWER] switch, this button has no effect unless the [POWER] switch is set to ON.
- ③ **STANDBY indicator (17)**
This indicator lights up when the A-933 is in Standby mode.
- ④ **Remote control sensor (9)**
This sensor receives control signals from the remote controller.
- ⑤ **Input selector (17)**
This control is used to select from the following input sources: PHONO, TUNER, CD, LINE, MD, or TAPE/CDR.
- ⑥ **Input selector indicator (17)**
These indicators show the currently selected input source.
- ⑦ **VOLUME control (18)**
This control is used to adjust the volume of the A-933.
- ⑧ **PHONES jack (18)**
This phone jack is for connecting a standard pair of stereo headphones for private listening.
- ⑨ **SPEAKERS A/B buttons & indicators (17)**
These buttons are used to select which speaker set, A or B, outputs sound. The indicators show if each speaker set is on or off.
- ⑩ **SUPER BASS control (18)**
This control is for adjusting the level of very-low bass sounds.
- ⑪ **BASS control (18)**
This control is for adjusting the level of bass sounds.
- ⑫ **TREBLE control (18)**
This control is for adjusting the level of treble sounds.
- ⑬ **TONE(R)/DIRECT(G) button & indicator (18)**
This button is used to select Tone mode or Direct mode. The indicator lights up red (R) in Tone mode; green (G) in Direct mode.
- ⑭ **MAIN IN button & indicator (19)**
When the A-933 is used as a power amplifier with a separate preamp, this button is used to set the MAIN IN function. The indicator lights up blue while the MAIN IN function is on.

Front & Rear Panels—Continued

Rear Panel

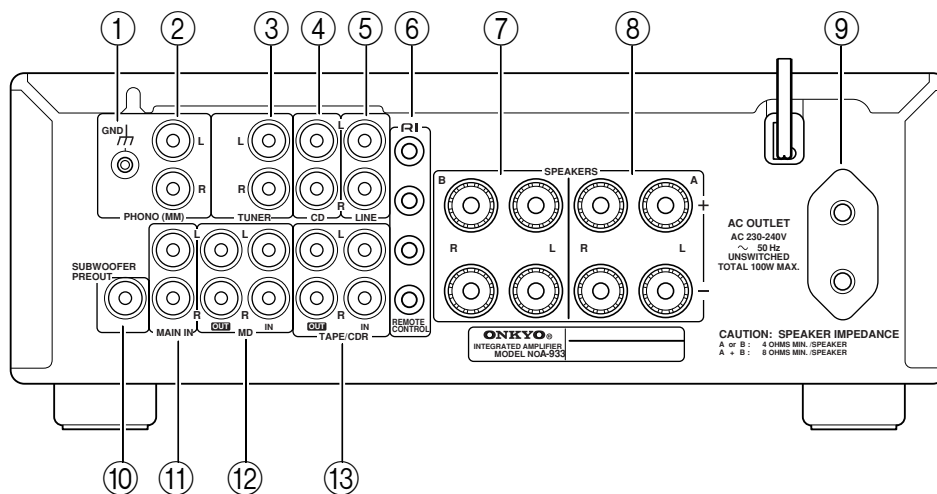

- ① **Grounding terminal**
This terminal is for connecting a turntable's ground wire.
- ② **PHONO (MM) input**
This analog audio input is for connecting a turntable with a moving-magnet cartridge.
- ③ **TUNER input**
This analog audio input is for connecting a tuner's analog audio output.
- ④ **CD input**
This analog audio input is for connecting a CD player's analog audio output.
- ⑤ **LINE input**
This analog audio input is for connecting a component's analog audio output (TV, etc).
- ⑥ **RI REMOTE CONTROL jacks**
These **RI** (Remote Interactive) jacks can be connected to the **RI** jacks on your other Onkyo audio components. The A-933's remote controller can then be used to control all of your components. To use **RI**, you must make an analog audio connection between the A-933 and each component.
- ⑦ **SPEAKERS B**
These terminal posts are for connecting speaker set B.
- ⑧ **SPEAKERS A**
These terminal posts are for connecting speaker set A.
- ⑨ **AC OUTLET**
This AC outlet can be used to supply power to another audio component. The type of outlet depends on the country in which you purchased the A-933.
- ⑩ **SUBWOOFER PREOUT**
This jack is for connecting a powered subwoofer.
- ⑪ **MAIN IN**
This analog audio input is for connecting a separate preamp when you want to use the A-933 as a power amplifier.
Caution:
Do not connect a component that does not have an output volume control, such as a CD player, because the sound will be output at maximum volume and may damage the A-933 and your speakers.
- ⑫ **MD IN/OUT**
This analog audio input and output are for connecting an MD recorder with an analog audio input and output.
- ⑬ **TAPE/CDR IN/OUT**
This analog audio input and output are for connecting a recorder (CD, cassette, etc) with an analog audio input and output.

See pages 11–16 for connection information

Remote Controller (RC-613S)

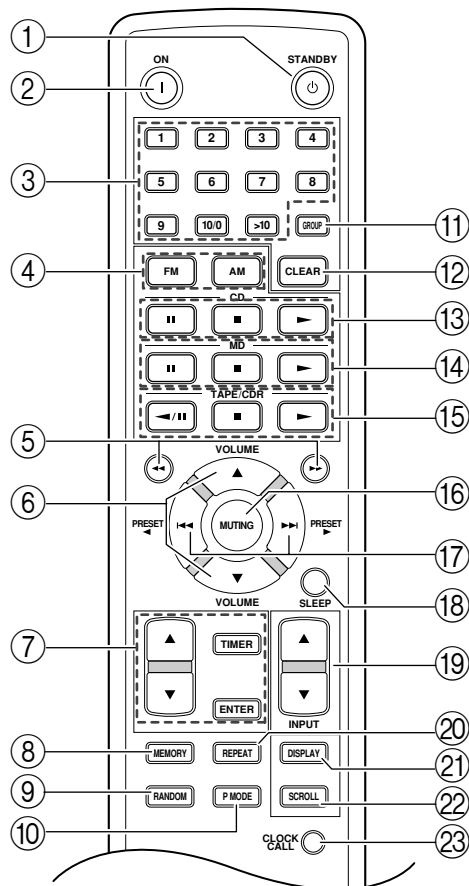

For detailed information, refer to the pages in parentheses.

① STANDBY button (17)

This button is used to set the A-933 to Standby.

② ON button (17)

This button is used to turn on the A-933.

③ Number buttons

These buttons are used to enter track numbers. To enter a single-digit number, simply press the corresponding button. The [10/0] button is used to enter either 10 or 0. The [>10] button is used when entering 2-digit numbers above 10. See the instruction manual supplied with each component for more information.

④ FM & AM buttons

These buttons are used to select AM or FM on an Onkyo Separate Collection tuner that's connected via **RI**.

⑤ Reverse & Fast Forward [◀]/[▶] buttons

These buttons are used for reverse and fast forward on an Onkyo Separate Collection CD, MD, cassette, or CDR component that's connected via **RI**. On some Onkyo tuners that're connected via **RI**, they're used to change the frequency.

⑥ VOLUME [▲]/[▼] buttons (18)

These buttons adjust the volume of the A-933.

⑦ TIMER, Up/Down [▲]/[▼] & ENTER buttons

These buttons set the clock and timer on an Onkyo Separate Collection tuner that's connected via **RI**.

⑧ MEMORY button

This button is used to set the memory playback function on an Onkyo Separate Collection CD, MD, or CDR component that's connected via **RI**. With memory playback, you can make a custom program.

⑨ RANDOM button

This button is used to set the random playback function on an Onkyo Separate Collection CD, MD, or CDR component that's connected via **RI**.

⑩ P MODE button

This button sets the playback mode on an Onkyo Separate Collection MD or CDR component that's connected via **RI**.

⑪ GROUP button

This button selects groups on an Onkyo Separate Collection MD component that's connected via **RI**.

⑫ CLEAR button

This button is used to remove the last track from the memory function program, etc., on an Onkyo Separate Collection CD, MD, cassette, or CDR component that's connected via **RI**.

⑬ CD control buttons

These buttons are used to control an Onkyo Separate Collection CD player that's connected via **RI**.

Pause [||]: Pauses playback

Stop [■]: Stops playback

Play [▶]: Starts playback

⑭ MD control buttons

These buttons are used to control an Onkyo Separate Collection MD player that's connected via **RI**.

Pause [||]: Pauses playback

Stop [■]: Stops playback

Play [▶]: Starts playback

⑮ TAPE/CDR control buttons

For double cassette decks, only Deck B can be controlled.

Reverse Play/Pause [◀/||]: Starts reverse playback on an Onkyo Separate Collection cassette deck that's connected via **RI**; pauses playback on an Onkyo Separate Collection CDR.

Stop [■]: Stops playback

Play [▶]: Starts playback

⑯ MUTING button (18)

This button is used to mute the A-933.

Remote Controller (RC-613S)—Continued

⑰ Previous & Next [◀]/[▶] (PRESET [◀] [▶]) buttons

These buttons are used to select the previous or next track on an Onkyo Separate Collection CD, MD, cassette, or CDR component that's connected via **RI**. Pressing them repeatedly selects earlier or later tracks. On an Onkyo Separate Collection tuner, they're used to select radio presets.

⑱ SLEEP button

This button is used to set the sleep function on an Onkyo Separate Collection tuner that's connected via **RI**.

⑲ INPUT [▲]/[▼] buttons (17)

These buttons are used to select from the following input sources: PHONO, TUNER, CD, LINE, MD, or TAPE/CDR.

⑳ REPEAT button

This button is used to set the repeat playback functions on an Onkyo Separate Collection CD, MD, or CDR component that's connected via **RI**.

㉑ DISPLAY button

This button is used to change the information shown on the display.

㉒ SCROLL button

This button is used to scroll text displayed on an Onkyo Separate Collection MD or CDR component that's connected via **RI**.

㉓ CLOCK CALL button

This button is used to display the time on an Onkyo Separate Collection tuner that's connected via **RI**.

Notes:

- The supplied batteries should last for about six months, although this will vary with usage.
- If the remote controller doesn't work reliably, try replacing the batteries.
- Don't mix new and old batteries or different types of batteries.
- If you intend not to use the remote controller for a long time, remove the batteries to prevent damage from leakage or corrosion.
- Expired batteries should be removed as soon as possible to prevent damage from leakage or corrosion.

Using the Remote Controller

Point the remote controller toward the remote control sensor.

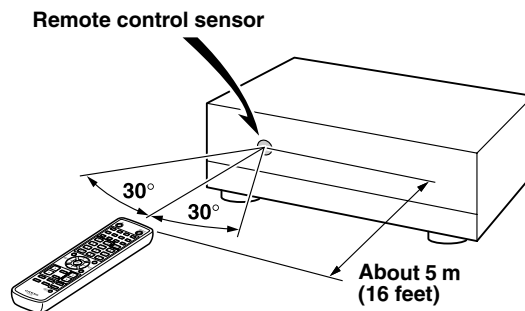

Notes:

- The remote controller may not work reliably if the A-933 is subjected to bright light, such as direct sunlight or inverter-type fluorescent lights. Keep this in mind when installing.
- If another remote controller of the same type is used in the same room, or the A-933 is installed close to equipment that uses infrared rays, the remote controller may not work reliably.
- Don't put anything, such as a book, on the remote controller, because the buttons may be pressed inadvertently, thereby draining the batteries.
- The remote controller may not work reliably if the A-933 is installed in a rack behind colored glass doors. Keep this in mind when installing.
- The remote controller will not work if there's an obstacle between it and the A-933's remote control sensor.

Installing the Batteries

Remove the battery compartment cover, as shown.

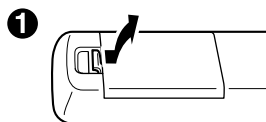

Insert the two supplied batteries (AA/R6) in accordance with the polarity markings in the battery compartment.

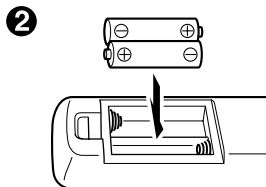

Replace the battery compartment cover.

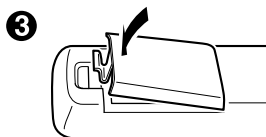

Connecting the A-933

About the System Functions

If you connect another component from the Onkyo Separate Collection to the A-933 with the appropriate **RI** and audio cables, you can use the following system functions. **RI** cables are special cables solely for use with Onkyo products. (No **RI** cables are supplied with the A-933.)

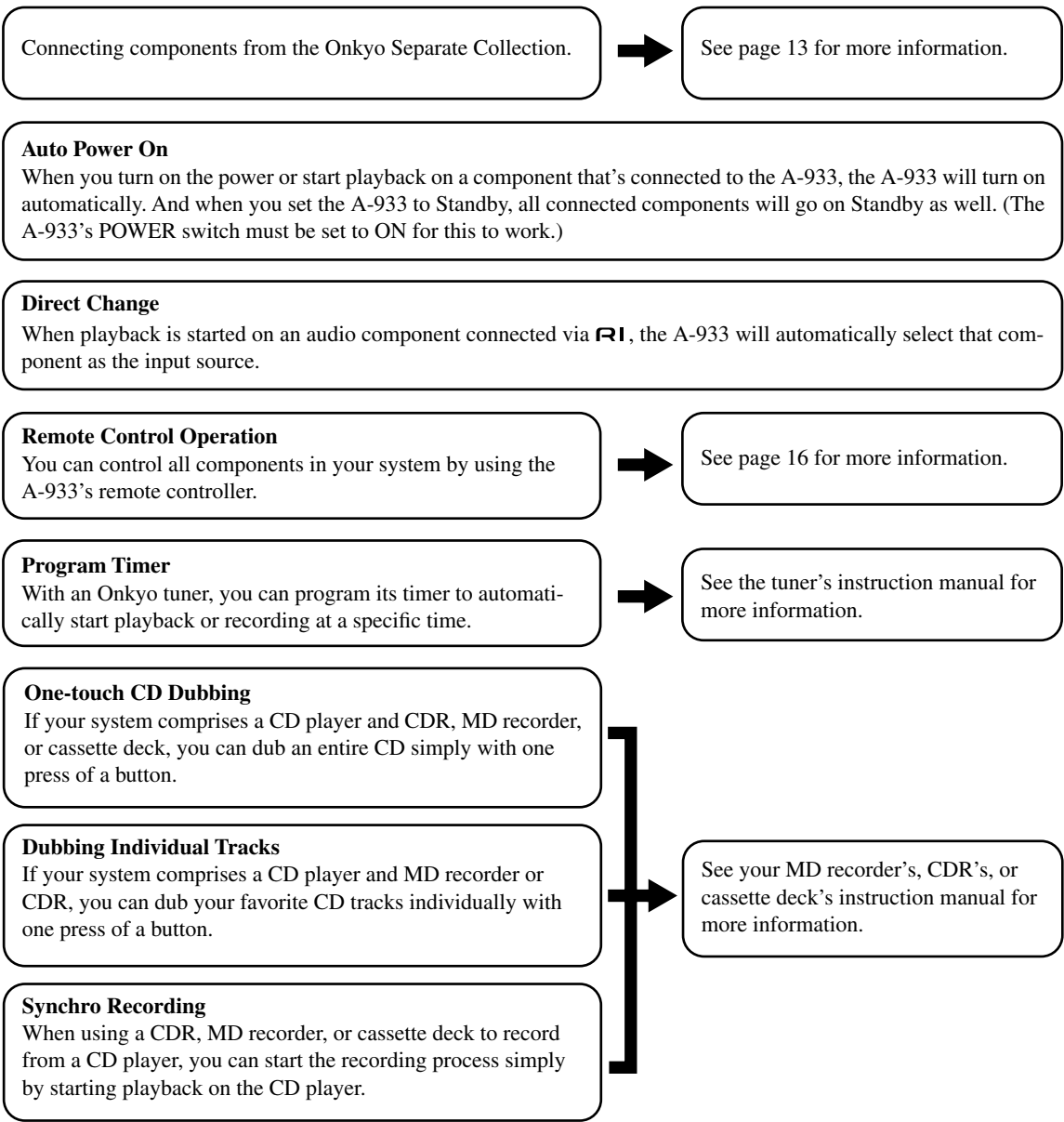

- Simply connecting an **RI** cable will not enable the system functions. You must make an analog audio connection between the A-933 and each component as well.
- See the instruction manual supplied with each component for more information about the **RI** system functions.
- When using the A-933 as a power amplifier (MAIN IN function), the **RI** system functions are unavailable.

Connecting the A-933—Continued

Before Making any Connections

- Always refer to the instructions that came with the component that you are connecting.
- Do not plug in the power cord until all connections have been properly made.
- Do not bind audio cables with power cords and speaker cables. Doing so may adversely affect the sound quality.
- To prevent interference, keep power cords and speaker cables away from the tuner's antenna.

RCA Audio Connection Color Coding

- Red connectors are used for the right channel, and white connectors are used for the left channel.

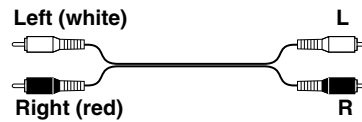

- Push each plug in all the way to make a good connection (loose connections can cause noise or malfunctions).

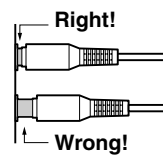

Connecting Your Speakers

Speaker Connection Precautions

You can connect one or two sets of speakers (A/B) to the A-933, and select which set outputs sound, or use both sets at the same time.

- **Connecting one set of speakers (A or B):** Only connect speakers with an impedance of 4 ohms or more but less than 16 ohms. If you use speakers with a lower impedance, and use the A-933 at high volume levels for a long period of time, the built-in protection circuit may be activated.
- **Connecting two sets of speakers (A and B):** Only connect speakers with an impedance of 8 ohms or more but less than 16 ohms. If you use speakers with a lower impedance, and use the A-933 at high volume levels for a long period of time, the built-in protection circuit may be activated.
- Disconnect the power cord from the wall outlet before making any connections.
- Read the instructions supplied with your speakers.
- Pay close attention to speaker wiring polarity. In other words, connect positive (+) terminals to only positive (+) terminals, and negative (-) terminals to only negative (-) terminals. If you get them the wrong way around, the sound will be out of phase and will sound unnatural.
- Unnecessarily long and very thin speaker cables may affect the sound quality and should be avoided.

- Be careful not to short the positive and negative wires. Doing so may damage the A-933.
- Don't connect more than one wire to each speaker terminal. Doing so may damage the A-933.
- Don't connect a speaker to more than one pair of speaker terminals.

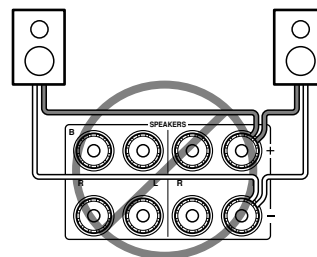
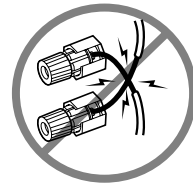

Connecting the A-933—Continued

Connecting the Speaker Cables

- 1 Strip about 15 mm of insulation from the ends of the speaker cables, and twist the bare wires tightly, as shown.**

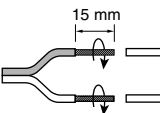

- 2 Unscrew the terminal.**

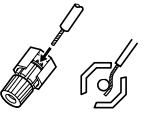
- 3 Fully insert the bare wires.**

- 4 Screw the terminal tight.**

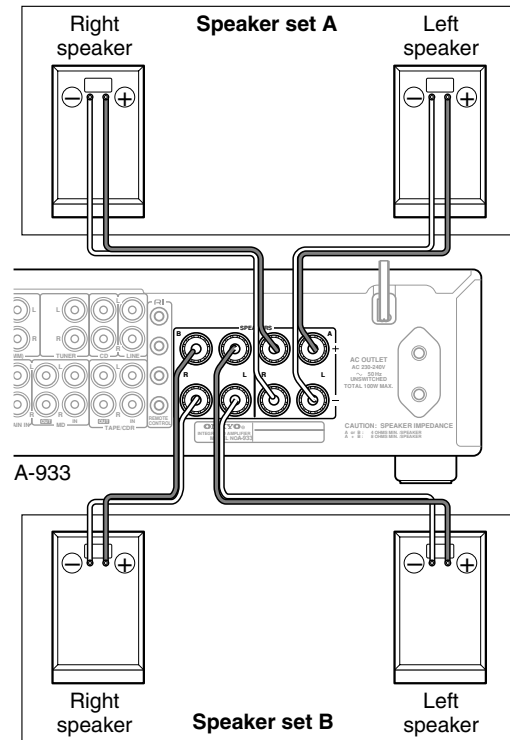

The following illustration shows which speaker should be connected to each pair of terminals.



Connecting a Subwoofer

You can connect a subwoofer with a built-in power amplifier to the A-933's SUBWOOFER PREOUT jack.

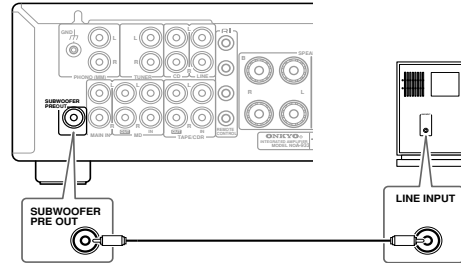

Tip: The volume and quality of the bass output from your subwoofer will depend on its position, the shape of your listening room, and your listening position. In general, a good bass sound can be obtained by installing the subwoofer in a front corner, or at one-third of the way along the wall in front of your listening position. To find the best position for your subwoofer, while playing a movie or some music with good bass, experiment by placing your subwoofer at various positions within the room, and choose the one that provides the most satisfying results.

Connecting the A-933—Continued

Hookup Diagrams for Onkyo Separate Collection

The A-933 can be used with the Onkyo Separate Collection C-733 CD Player and T-433 Tuner as shown below.

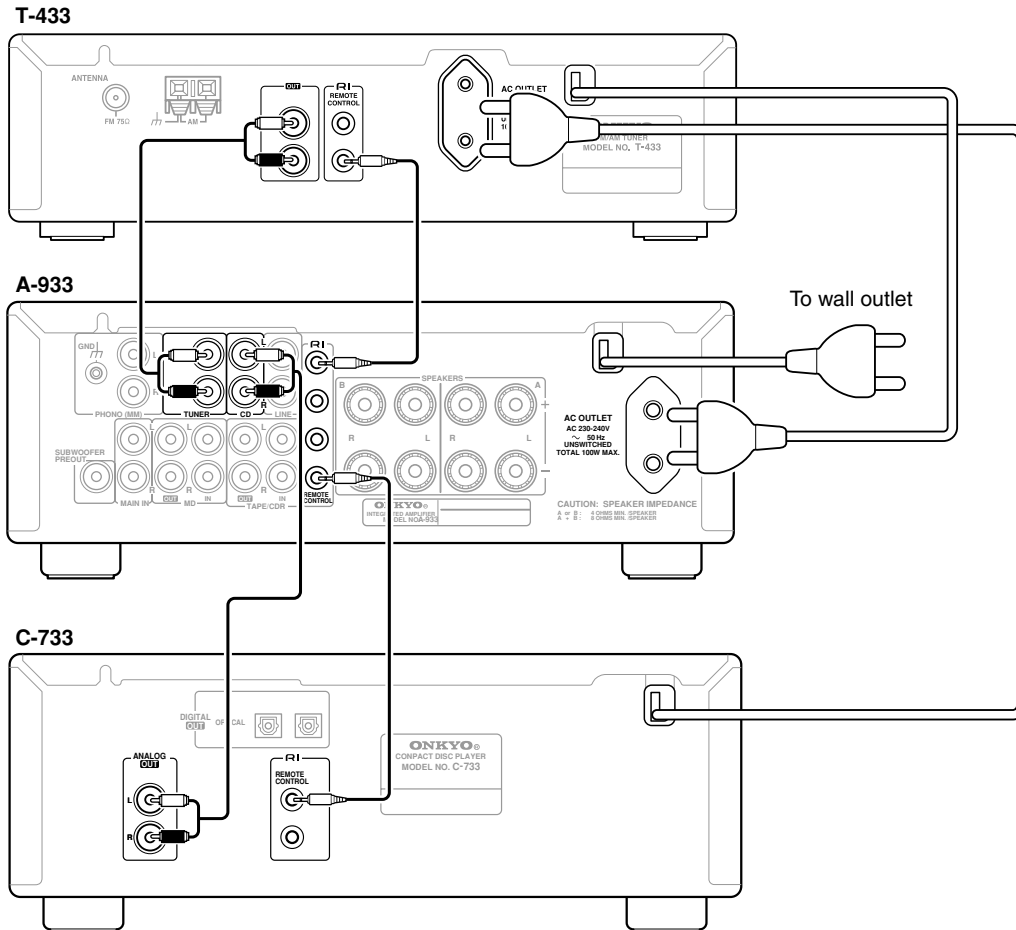

RI Connections

- No **RI** cables are included with the A-933. Use the **RI** cables supplied with your other Onkyo Separate Collection components.
- The **RI** jacks are used when the A-933 is combined with other **RI**-compatible components from the Onkyo Separate Collection.
- Some components have two or more **RI** jacks. These jacks are all the same, and you can use any of them.
- **Simply connecting an RI cable will not enable the system functions. You must make an analog audio connection between the A-933 and each component.**

Stacking Components

- The illustration below shows how Onkyo Separate Collection components can be stacked. The CD player is sensitive to heat, so don't put it on top of the amplifier.
- Connection information is provided on the following pages.

Vertical stacking

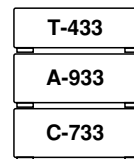

Connecting the A-933—Continued

Audio Components

Connecting a CD player

Use an analog audio cable to connect the A-933's CD L/R jacks to the analog audio output jacks on the CD player, as shown.

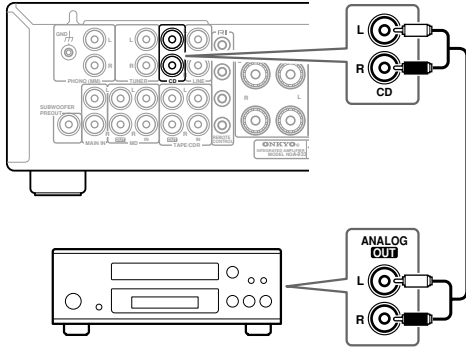

Connecting a Tuner

Use an analog audio cable to connect the A-933's TUNER L/R jacks to the analog audio output jacks on the tuner, as shown.

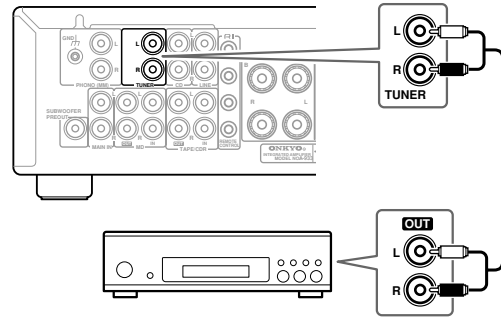

Connecting an MD Recorder

Use an analog audio cable to connect the A-933's MD IN L/R jacks to the MD recorder's analog audio output jacks, and use another analog audio cable to connect the A-933's MD OUT L/R jacks to the MD recorder's analog audio input jacks, as shown.

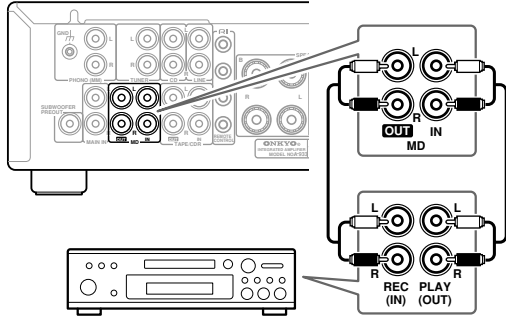

Connecting a Cassette Deck

Use an analog audio cable to connect the A-933's TAPE/CDR IN L/R jacks to the cassette deck's output jacks, and use another analog audio cable to connect the A-933's TAPE/CDR OUT L/R jacks to the cassette deck's input jacks, as shown.

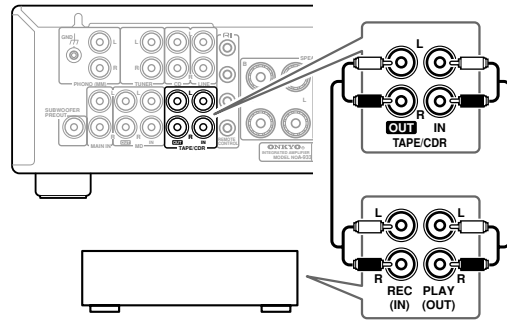

Connecting the A-933—Continued

Connecting a Turntable

The A-933's PHONO input jacks are for use with moving-magnet (MM) type cartridges. Use an analog audio cable to connect the A-933's PHONO L/R jacks to the audio output jacks on the turntable, as shown.

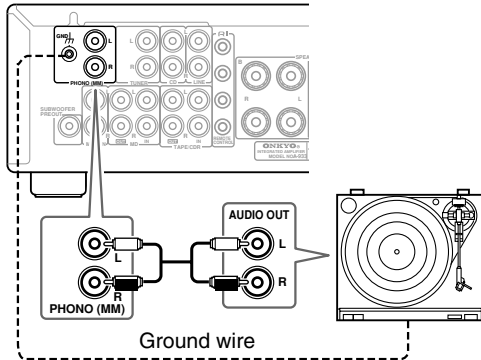

Notes:

- If the turntable has a ground wire, connect it to A-933's GND terminal. With some turntables, connecting the ground wire may cause hum, in which case it should be disconnected.
- If the turntable has a moving-coil (MC) type cartridge, you'll need a commercially available MC phono preamp. In this case, connect the turntable to the phono preamp's input, and connect the phono preamp's output to the A-933's PHONO L/R jacks.

Connecting a TV or Other Component with an Audio Output

Use an analog audio cable to connect the A-933's LINE L/R jacks to the analog audio output jacks on the TV or other component, as shown.

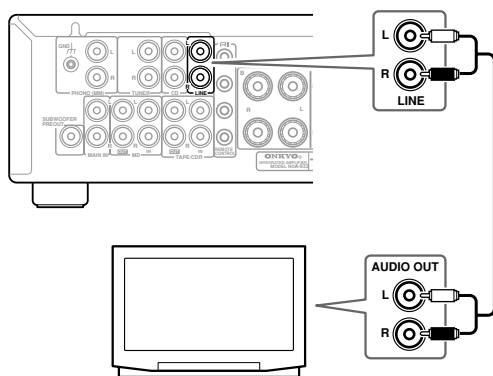

Note:

If your TV has no audio output, you can connect the A-933 to an audio output on your VCR and use its tuner.

Connecting a Preamp

The A-933 can be used as a power amplifier with a separate preamp.

In this case, use an analog audio cable to connect the A-933's MAIN IN jacks to the preamp's output jacks. Connect the speakers to the A-933, and connect the playback components to the preamp.

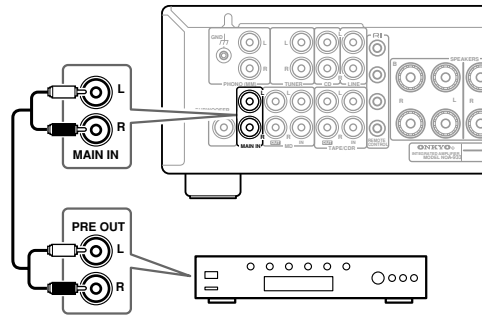

Notes:

- Do not connect a component that does not have an output volume control, because the sound will be output at maximum volume and may damage the A-933 and your speakers.
- To turn on the MAIN IN function, press the [MAIN IN] button for 3 seconds until the indicator lights up blue (page 19).
- When the A-933 is used as a power amplifier, the remote controller and the following functions are disabled: Volume control, Muting, **RI** system functions, Tone/Direct function, subwoofer output, and Recording. Some of these functions can be performed on the connected preamp.

Connecting Another Component's Power Cord

The A-933 has an AC OUTLET on its rear panel. This can be used to connect the power cord of another audio component that you intend to use with the A-933.

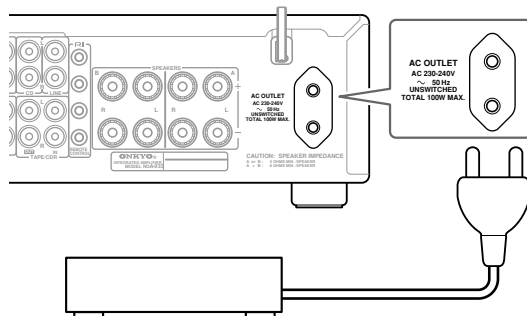

Caution:

- Make sure that the maximum power requirement of the component connected to the AC OUTLET does not exceed the capacity printed on the A-933's rear panel (100W).

Connecting the A-933—Continued

Connecting **RI** Components

With **RI** (Remote Interactive), you can control your **RI**-compatible Onkyo CD player, Tuner, and so on with the A-933's remote controller.

- To use **RI**, you must make an analog audio connection between the A-933 and each audio component.

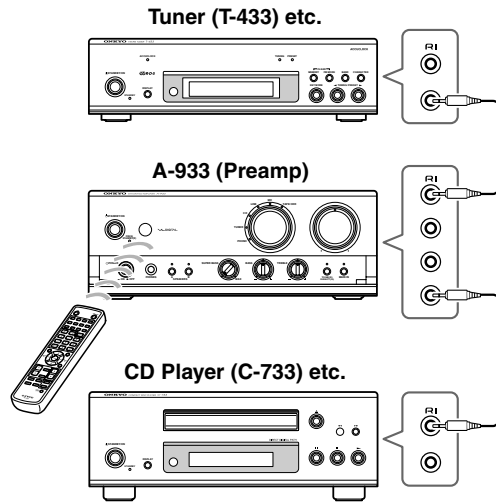

Notes:

- Push each plug in all the way to make a good connection.
- Use only dedicated **RI** cables for **RI** connections. (No **RI** cables are supplied with the A-933.)
- The A-933 has four **RI** jacks. They're all the same, so you can use any of them.
- **RI** jacks should be connected to only Onkyo components. Connecting them to another manufacturer's component may cause it to malfunction.
- Some components may not support all **RI** functions. See the manuals supplied with your other Onkyo components for more information.

Connecting the Power Cord

- Before connecting the power cord, connect all your speakers and audio components.
- Turning on the A-933 may cause a momentary power surge, which might interfere with other electrical equipment on the same circuit. If this is a problem, plug the A-933 into a different branch circuit.

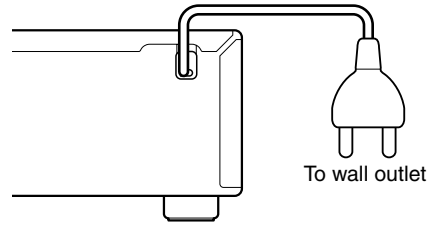

Enjoying Audio Sources

Turning On the A-933

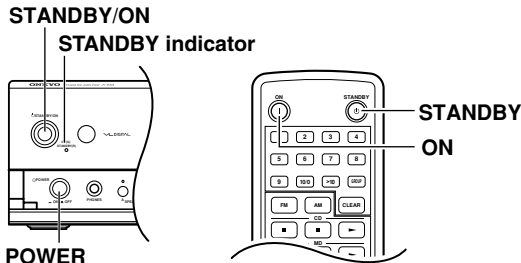

1 Press the [POWER] button. The STANDBY indicator lights up.



2 Press the [STANDBY/ON] button. Alternatively, press the remote controller's [ON] button. The A-933 turns on and the STANDBY indicator lights up green.



Note: When it's turned on, the A-933 outputs no sound for about five seconds. This allows the circuits to stabilize. To turn off the A-933, press the [STANDBY/ON] button. The A-933 will enter Standby mode.

If the A-933 is connected to other components via **RI**, press the remote controller's [ON] button once to turn on the A-933, and press it again to turn on the other components.

Turning on all system components simultaneously: You can set the A-933 so that all connected **RI** components are turned on with just one press of the remote controller's [ON] button or the A-933's [STANDBY/ON] button. To do this, turn on the A-933, and then press and hold the remote controller's [ON] button for 16 seconds until the A-933 switches to Standby mode. You will then be able to turn on the A-933 and all system components with just one press of the remote controller's [ON] button or the [STANDBY/ON] button on any system component.

Notes:

- The A-933 is shipped with the POWER switch in the ON position (▲). When the power cord is connected for the very first time, the A-933 will go on Standby, and the STANDBY indicator will light up.
- To completely shut down the A-933, set the POWER switch to the OFF position (■).

Listening to Components

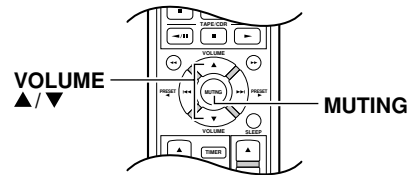
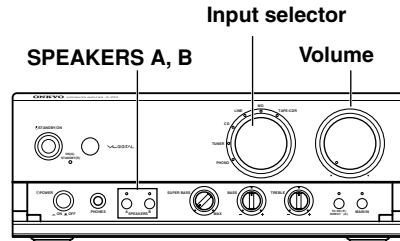

Selecting Speaker Set A or B

You can select which set of speakers outputs sound, or you can use both sets at the same time.

To output sound from the speakers connected to the SPEAKERS A terminals, press the SPEAKERS [A] button. The indicator above that button will light up. If a subwoofer is connected, that too will output sound. To output sound from the speakers connected to the SPEAKERS B terminals, press the SPEAKERS [B] button. The indicator above that button will light up. If a subwoofer is connected, that too will output sound. To output sound from all connected speakers, press the SPEAKERS [A] and SPEAKERS [B] button so that both indicators are on.

1 Turn the input selector to select the component that you want to listen to.

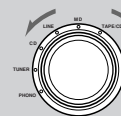

- TAPE/CDR:** Select to hear the component connected to the TAPE/CDR IN jacks.
- MD:** Select to listen to the component connected to the MD IN jacks.
- LINE:** Select to listen to the component connected to the LINE jacks.
- CD:** Select to listen to the component connected to the CD jacks.
- TUNER:** Select to listen to the component connected to the TUNER jacks.
- PHONO:** Select to listen to the turntable connected to the PHONO jacks.

Enjoying Audio Sources—Continued

2 Start playback on the selected component.

3 **A-933**
To adjust the volume, use the A-933's Volume control, or the remote controller's VOLUME [▲]/[▼] buttons.
 Turn VOLUME control clockwise to increase the volume or counterclockwise to decrease the volume.



Notes:

- Always turn down the volume before connecting your headphones.
- All connected speakers are turned off while the headphones plug is inserted in the PHONES jack.
- The headphones output no sound while the MAIN IN function is on.

Using the Tone Controls

While the MAIN IN function is on, the A-933's tone controls have no effect.

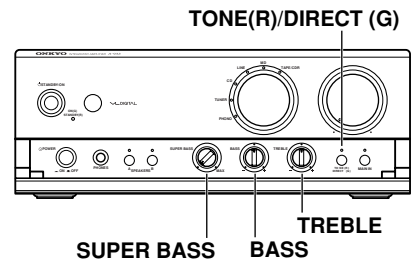

Muting the A-933 (remote controller only)

You can temporarily mute the output of the A-933.

1 Press the remote controller's [MUTING] button.
 The A-933 is muted, and the STANDBY indicator flashes green.

To unmute the A-933, press the [MUTING] button again.

Notes:

- The Mute function will be cancelled if the remote controller's VOLUME buttons are pressed or the A-933 is set to Standby.
- When using the A-933 as a power amplifier (MAIN IN function), the Muting function has no effect.

Selecting Tone or Direct Mode

The [TONE(R)/DIRECT(G)] button is used to select Tone or Direct mode. In Tone mode, the tone controls can be used to adjust the sound, and the TONE/DIRECT indicator lights up red (R).



In Direct mode, the tone controls are bypassed, so you can enjoy a pure sound. The TONE/DIRECT indicator lights up green (G).

Adjusting the Super Bass

The SUPER BASS control adjusts very-low bass sounds. Turn it up to make them louder. Normally, it should be fully turned down.



Adjusting the Bass

The BASS control adjusts bass sounds. Turn it up to make them louder. Turn it down to make them quieter. Normally, it should be set midway.

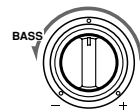

Adjusting the Treble

The TREBLE control adjusts treble sounds. Turn it up to make them louder. Turn it down to make them quieter. Normally, it should be set midway.

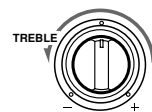

Using Headphones

You can connect a pair of stereo headphones (1/4-inch phone plug) to the A-933's PHONES jack for private listening.

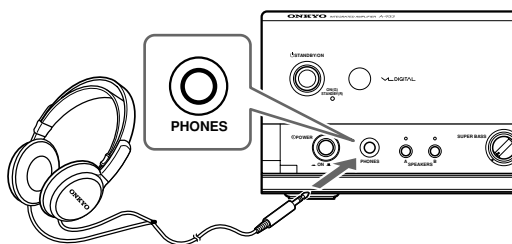

Enjoying Audio Sources—Continued

Using the MAIN IN Function

You can use the A-933 as power amplifier with a separate preamp. See page 15 for connection information.

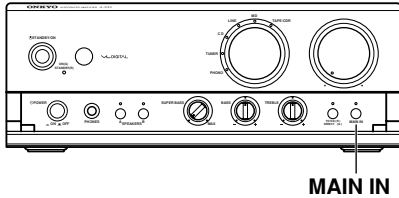

1



Press the [MAIN IN] button for 3 seconds until the MAIN IN indicator lights up.

The MAIN IN function comes on and the MAIN IN indicator lights up blue.

While the MAIN IN function is on, only audio from components connected to the preamp can be output.

To turn the MAIN IN function off, press the [MAIN IN] button for 3 seconds until the MAIN IN indicator goes off.

Notes:

- Do not connect a component that does not have an output volume control to the MAIN IN jacks and use the MAIN IN function, because the sound will be output at maximum volume and may damage the A-933 and your speakers.
- While the MAIN IN function is on, the A-933's Volume control has no effect. Before you turn off the MAIN IN function, make sure that the Volume control is not turned up high, to prevent any loud surprises.
- While the MAIN IN function is on, the remote controller and the following A-933 functions are disabled: Volume control, Muting, **RI** system functions, Tone/Direct function, subwoofer output, and Recording. Some of these functions can be performed on the connected preamp.

Recording

Unless you have the full consent of the copyright holder, copyright laws prohibit using your recordings for anything other than personal enjoyment!

Input selector

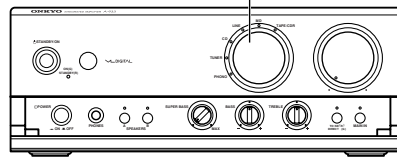

1

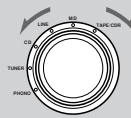

Use the input selector to select the component that you want to record from.

2

Prepare the recorder:

- Set the recorder so that it's ready for recording.
- If necessary, adjust the recording level on the recorder.
- See the recorder's manual for more information.

3

Start playback on the component selected in step 1.

Note:

If you select another input source during recording, the newly selected input source will be recorded.

Notes:

- You can record on a recorder that's connected to the MD OUT or TAPE/CDR OUT L/R jacks.
- The tone controls have no effect on the signal being recorded.
- When using the A-933 as a power amplifier (MAIN IN function), recording is not possible.
- For information on one-touch CD dubbing, individual CD track dubbing, and timed recording with Onkyo Separate Collection components, see page 10.

Troubleshooting

If you have any trouble using the A-933, look for a solution here. If you can't resolve the issue yourself, contact your Onkyo dealer.

Power

Can't turn on the A-933.

- Make sure that the power cord is properly plugged into the wall outlet.
- Unplug the power cord from the wall outlet, wait five seconds or more, then plug it in again.
- By default, pressing the A-933's [STANDBY/ON] button once does not turn on all of the system components. You need to press the remote controller's [ON] button again. Alternatively, you can set the A-933 so that all components do turn on simultaneously (page 17).

The STANDBY indicator is flashing red.

- The amp protection circuit has been activated. Remove the power cord from the wall outlet immediately and contact your Onkyo dealer.

Audio

There's no sound or it's very quiet.

- When the A-933 is used as a power amplifier (MAIN IN indicator lights up blue), the sound from components connected to the preamp are output. To output the sound from a component that's connected to the A-933, or to use the A-933 as a preamp, press the [MAIN IN] button for 3 seconds until the MAIN IN indicator goes off.
- Make sure that all audio plugs are pushed in all the way (page 11).
- Make sure that the inputs and outputs of all components are connected properly.
- Make sure that the polarity of the speaker cables is correct and that the bare wires are in contact with the metal part of each speaker terminal (page 12).
- Make sure that the correct input source is selected (page 17).
- If the STANDBY indicator is flashing green, press the remote controller's [MUTING] button to unmute the A-933 (page 18).
- Make sure that none of the cables are bent, twisted, or damaged.
- Make sure that SPEAKERS A or B are selected. When only SPEAKERS A is selected (A indicator on), speakers connected to the SPEAKERS A terminals, and a connected subwoofer will output sound. When only SPEAKERS B is selected (B indicator on), speakers connected to the SPEAKERS B terminals, and a connected subwoofer will output sound.
- To use a turntable with a moving-coil (MC) type cartridge, you need a commercially available MC phono preamp (page 15).

Noise can be heard.

- Using cable ties to bundle audio cables with power cords, speaker cables, and so on may degrade the audio performance, so don't bundle them together.
- An audio cable may be picking up interference. Try repositioning your cables.

The tone controls don't work.

- If the TONE/DIRECT indicator is green, Direct mode is selected and the tone controls have no effect. Press the [TONE/DIRECT] button to select Tone mode. The TONE/DIRECT indicator will turn red (page 18).

Remote Controller

The remote controller doesn't work.

- Make sure that the batteries are installed with the correct polarity (page 9).
- Install new batteries. Don't mix different types of batteries or old and new batteries (page 9).
- Make sure that the remote controller is not too far away from the A-933 and that there's no obstruction between the remote controller and the A-933's remote control sensor (page 9).
- Make sure that the A-933 is not subjected to direct sunshine or inverter-type florescent lights. Relocate if necessary (page 9).
- If the A-933 is installed in a rack or cabinet with colored glass doors, the remote controller may not work reliably when the doors are closed (page 9).

Can't control other components?

- If it's an Onkyo component, make sure that the **RI** cable and analog audio cable are connected properly. Connecting only an **RI** cable won't work.

Troubleshooting—Continued

Recording

Can't record.

- The component connected to the MAIN IN jacks cannot be recorded.
- When using the A-933 as a power amplifier (MAIN IN function), recording is not possible.

Others

The VOLUME control doesn't work.

- When using the A-933 as a power amplifier (MAIN IN function), the Volume control has no effect. Adjust the volume on the connected preamp instead.

The Muting function doesn't work.

- When using the A-933 as a power amplifier (MAIN IN function), the Muting function does not work. Use the muting function on the connected preamp instead.

The A-933 contains a microcomputer for signal processing and control functions. In very rare situations, severe interference, noise from an external source, or static electricity may cause it to lock up. In the unlikely event that this happens, unplug the power cord from the wall outlet, wait at least five seconds, and then plug it back in again.

Onkyo is not responsible for damages (such as CD rental fees) due to unsuccessful recordings caused by the unit's malfunction. Before you record important data, make sure that the material will be recorded correctly.

To reset the A-933 to its factory defaults, with it turned on, while holding down the [MAIN IN] button, press the [STANDBY/ON] button. The input selector indicators light up briefly, and then the A-933 enters Standby mode.

Specifications

Power output:	80 W + 80 W (8 Ω , 1 kHz, DIN)
Dynamic power:	270 W + 270 W (3 Ω , Front) 220 W + 220 W (4 Ω , Front) 110 W + 110 W (8 Ω , Front)
THD (total harmonic distortion):	0.08% (1 kHz, 1 W)
Damping factor:	25 (Front, 1 kHz, 8 Ω)
Input sensitivity and impedance:	200 mV, 50 k Ω (LINE) 2.5 mV, 50 k Ω (PHONO MM)
Output level and impedance:	200 mV, 2.2 k Ω (REC OUT)
Phono overload:	130 mV (MM, 1 kHz, 0.5%)
Frequency response:	10 Hz–60 kHz, +1 dB–3 dB (CD)
Tone control:	+8 dB, –8 dB, 100 Hz (BASS) +8 dB, –8 dB, 20 kHz (TREBLE) +10 dB, 80 Hz (SUPER BASS)
SN ratio:	100 dB (LINE, IHF-A) 70 dB (PHONO, IHF-A)
Speaker impedance:	4–16 Ω
Power supply:	AC 230-240 V, 50 Hz
Power consumption:	100 W
Stand-by power consumption:	0.9 W
Dimensions (W \times H \times D):	275 \times 103 \times 328 mm
Weight:	7.5 kg
Analog inputs:	PHONO, TUNER, CD, LINE, MD, TAPE/CDR, MAIN IN
Analog outputs:	MD, TAPE/CDR
Subwoofer pre outputs:	1
Speaker outputs:	2 (A, B)
Phones:	1

Specifications and features are subject to change without notice.

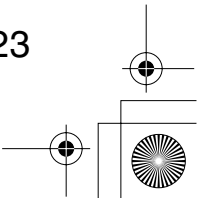
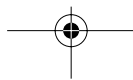
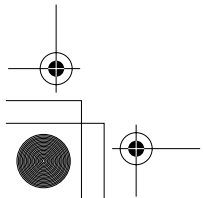
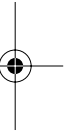
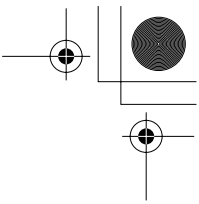
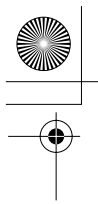

ONKYO CORPORATION

Sales & Product Planning Div. : 2-1, Nisshin-cho, Neyagawa-shi, OSAKA 572-8540, JAPAN
Tel: 072-831-8023 Fax: 072-831-8124

ONKYO U.S.A. CORPORATION

18 Park Way, Upper Saddle River, N.J. 07458, U.S.A.
Tel: 201-785-2600 Fax: 201-785-2650 <http://www.us.onkyo.com/>

ONKYO EUROPE ELECTRONICS GmbH

Liegnitzerstrasse 6, 82194 Groebenzell, GERMANY
Tel: +49-8142-4401-0 Fax: +49-8142-4401-555 <http://www.eu.onkyo.com/>

ONKYO EUROPE UK Office

Suite 1, Gregories Court, Gregories Road, Beaconsfield, Buckinghamshire, HP9 1HQ
UNITED KINGDOM Tel: +44-(0)1494-681515 Fax: +44(0)-1494-680452

ONKYO CHINA LIMITED

Units 2102-2107, Metroplaza Tower I, 223 Hing Fong Road, Kwai Chung,
N.T., HONG KONG Tel: 852-2429-3118 Fax: 852-2428-9039
<http://www.ch.onkyo.com/>



Printed in Japan
I0501-1

SN 29343979

(C) Copyright 2005 ONKYO CORPORATION Japan. All rights reserved.



Free Manuals Download Website

<http://myh66.com>

<http://usermanuals.us>

<http://www.somanuals.com>

<http://www.4manuals.cc>

<http://www.manual-lib.com>

<http://www.404manual.com>

<http://www.luxmanual.com>

<http://aubethermostatmanual.com>

Golf course search by state

<http://golfingnear.com>

Email search by domain

<http://emailbydomain.com>

Auto manuals search

<http://auto.somanuals.com>

TV manuals search

<http://tv.somanuals.com>