

AV Receiver

# DTR-7.9

Instruction Manual

**Integra**

## WARNING:

TO REDUCE THE RISK OF FIRE OR ELECTRIC SHOCK, DO NOT EXPOSE THIS APPARATUS TO RAIN OR MOISTURE.

## CAUTION:

TO REDUCE THE RISK OF ELECTRIC SHOCK, DO NOT REMOVE COVER (OR BACK). NO USER-SERVICEABLE PARTS INSIDE. REFER SERVICING TO QUALIFIED SERVICE PERSONNEL.



**WARNING**  
RISK OF ELECTRIC SHOCK  
DO NOT OPEN

**AVIS**  
RISQUE DE CHOC ELECTRIQUE  
NE PAS OUVRIR



The lightning flash with arrowhead symbol, within an equilateral triangle, is intended to alert the user to the presence of uninsulated "dangerous voltage" within the product's enclosure that may be of sufficient magnitude to constitute a risk of electric shock to persons.



The exclamation point within an equilateral triangle is intended to alert the user to the presence of important operating and maintenance (servicing) instructions in the literature accompanying the appliance.

## Important Safety Instructions

1. Read these instructions.
2. Keep these instructions.
3. Heed all warnings.
4. Follow all instructions.
5. Do not use this apparatus near water.
6. Clean only with dry cloth.
7. Do not block any ventilation openings. Install in accordance with the manufacturer's instructions.
8. Do not install near any heat sources such as radiators, heat registers, stoves, or other apparatus (including amplifiers) that produce heat.
9. Do not defeat the safety purpose of the polarized or grounding-type plug. A polarized plug has two blades with one wider than the other. A grounding type plug has two blades and a third grounding prong. The wide blade or the third prong are provided for your safety. If the provided plug does not fit into your outlet, consult an electrician for replacement of the obsolete outlet.
10. Protect the power cord from being walked on or pinched particularly at plugs, convenience receptacles, and the point where they exit from the apparatus.
11. Only use attachments/accessories specified by the manufacturer.
12. Use only with the cart, stand, tripod, bracket, or table specified by the manufacturer, or sold with the apparatus. When a cart is used, use caution when moving the cart/apparatus combination to avoid injury from tip-over.  

PORTABLE CART WARNING  
S3125A
13. Unplug this apparatus during lightning storms or when unused for long periods of time.
14. Refer all servicing to qualified service personnel. Servicing is required when the apparatus has been damaged in any way, such as power-supply cord or plug is damaged, liquid has been spilled or objects have fallen into the apparatus, the apparatus has been exposed to rain or moisture, does not operate normally, or has been dropped.
15. Damage Requiring Service  
Unplug the apparatus from the wall outlet and refer servicing to qualified service personnel under the following conditions:
  - A. When the power-supply cord or plug is damaged,
  - B. If liquid has been spilled, or objects have fallen into the apparatus,
  - C. If the apparatus has been exposed to rain or water,
  - D. If the apparatus does not operate normally by following the operating instructions. Adjust only those controls that are covered by the operating instructions as an improper adjustment of other controls may result in damage and will often require extensive work by a qualified technician to restore the apparatus to its normal operation,
  - E. If the apparatus has been dropped or damaged in any way, and
  - F. When the apparatus exhibits a distinct change in performance this indicates a need for service.
16. Object and Liquid Entry  
Never push objects of any kind into the apparatus through openings as they may touch dangerous voltage points or short-out parts that could result in a fire or electric shock.  
The apparatus shall not be exposed to dripping or splashing and no objects filled with liquids, such as vases shall be placed on the apparatus.  
Don't put candles or other burning objects on top of this unit.
17. Batteries  
Always consider the environmental issues and follow local regulations when disposing of batteries.
18. If you install the apparatus in a built-in installation, such as a bookcase or rack, ensure that there is adequate ventilation.  
Leave 20 cm (8") of free space at the top and sides and 10 cm (4") at the rear. The rear edge of the shelf or board above the apparatus shall be set 10 cm (4") away from the rear panel or wall, creating a flue-like gap for warm air to escape.

# Precautions

---

1. **Recording Copyright**—Unless it's for personal use only, recording copyrighted material is illegal without the permission of the copyright holder.
2. **AC Fuse**—The AC fuse inside the unit is not user-serviceable. If you cannot turn on the unit, contact the dealer.
3. **Care**—Occasionally you should dust the unit all over with a soft cloth. For stubborn stains, use a soft cloth dampened with a weak solution of mild detergent and water. Dry the unit immediately afterwards with a clean cloth. Don't use abrasive cloths, thinners, alcohol, or other chemical solvents, because they may damage the finish or remove the panel lettering.

## 4. Power

### WARNING

BEFORE PLUGGING IN THE UNIT FOR THE FIRST TIME, READ THE FOLLOWING SECTION CAREFULLY.

AC outlet voltages vary from country to country. Make sure that the voltage in your area meets the voltage requirements printed on the unit's rear panel (e.g., AC 230 V, 50 Hz or AC 120 V, 60 Hz).

The power cord plug is used to disconnect this unit from the AC power source. Make sure that the plug is readily operable (easily accessible) at all times.

Pressing the [On/Standby] button to select Standby mode does not fully shutdown the unit. If you do not intend to use the unit for an extended period, remove the power cord from the AC outlet.

## 5. Preventing Hearing Loss

### Caution

Excessive sound pressure from earphones and headphones can cause hearing loss.

## 6. Batteries and Heat Exposure

### Warning

Batteries (battery pack or batteries installed) shall not be exposed to excessive heat as sunshine, fire or the like.

7. **Never Touch this Unit with Wet Hands**—Never handle this unit or its power cord while your hands are wet or damp. If water or any other liquid gets inside this unit, have it checked by the dealer.

## 8. Handling Notes

- If you need to transport this unit, use the original packaging to pack it how it was when you originally bought it.
- Do not leave rubber or plastic items on this unit for a long time, because they may leave marks on the case.
- This unit's top and rear panels may get warm after prolonged use. This is normal.
- If you do not use this unit for a long time, it may not work properly the next time you turn it on, so be sure to use it occasionally.

## For U.S. models

### FCC Information for User

#### CAUTION:

The user changes or modifications not expressly approved by the party responsible for compliance could void the user's authority to operate the equipment.

#### NOTE:

This equipment has been tested and found to comply with the limits for a Class B digital device, pursuant to Part 15 of the FCC Rules. These limits are designed to provide reasonable protection against harmful interference in a residential installation.

This equipment generates, uses and can radiate radio frequency energy and, if not installed and used in accordance with the instructions, may cause harmful interference to radio communications. However, there is no guarantee that interference will not occur in a particular installation. If this equipment does cause harmful interference to radio or television reception, which can be determined by turning the equipment off and on, the user is encouraged to try to correct the interference by one or more of the following measures:

- Reorient or relocate the receiving antenna.
- Increase the separation between the equipment and receiver.
- Connect the equipment into an outlet on a circuit different from that to which the receiver is connected.
- Consult the dealer or an experienced radio/TV technician for help.

## For Canadian Models

**NOTE:** THIS CLASS B DIGITAL APPARATUS COMPLIES WITH CANADIAN ICES-003.

For models having a power cord with a polarized plug:

**CAUTION:** TO PREVENT ELECTRIC SHOCK, MATCH WIDE BLADE OF PLUG TO WIDE SLOT, FULLY INSERT.

## Modèle pour les Canadien

**REMARQUE:** CET APPAREIL NUMÉRIQUE DE LA CLASSE B EST CONFORME À LA NORME NMB-003 DU CANADA.

Sur les modèles dont la fiche est polarisée:

**ATTENTION:** POUR ÉVITER LES CHOCs ÉLECTRIQUES, INTRODUIRE LA LAME LA PLUS LARGE DE LA FICHE DANS LA BORNE CORRESPONDANTE DE LA PRISE ET POUSSER JUSQU'AU FOND.

Thank you for purchasing an Integra AV receiver.  
Please read this manual thoroughly before making connections and plugging in the unit.  
Following the instructions in this manual will enable you to obtain optimum performance and listening enjoyment from your new AV receiver.  
Please retain this manual for future reference.

## Supplied Accessories

---

Make sure you have the following accessories:

---

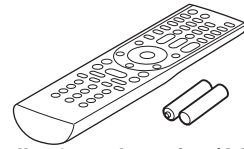

**Remote controller & two batteries (AA/R6)**

---



**Speaker setup microphone**

---



**Indoor FM antenna**

---

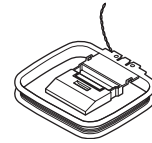

**AM loop antenna**

---

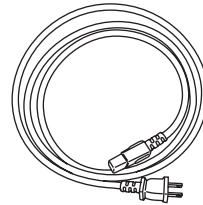

**Power cord**  
(Plug type varies from country to country.)

---

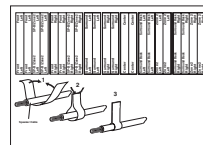

**Speaker cable labels**

---

\* In catalogs and on packaging, the letter at the end of the product name indicates the color. Specifications and operations are the same regardless of color.

# Contents

<b>Introduction</b>	
Important Safety Instructions .....	2
Precautions .....	3
Supplied Accessories .....	4
Features .....	6
Front & Rear Panels .....	7
Front Panel .....	7
Display .....	9
Rear Panel .....	10
Remote Controller .....	13
Installing the Batteries .....	13
Aiming the Remote Controller .....	13
Controlling the AV Receiver .....	14
About Home Theater .....	15
Enjoying Home Theater .....	15

<b>Connections</b>	
Connecting the AV Receiver .....	16
Connecting Your Speakers .....	16
Bi-amping the Front Speakers .....	18
Connecting Antenna .....	19
About AV Connections .....	21
Connecting Both Audio & Video .....	22
Which Connections Should I Use? .....	22
Connecting a TV or Projector .....	24
Connecting a DVD Player .....	25
Connecting a VCR or DVD Recorder for Playback .....	27
Connecting a VCR or DVD Recorder for Recording .....	28
Connecting a Satellite, Cable, Terrestrial Set-top box, or Other Video Source .....	29
Connecting a Game Console .....	30
Connecting a Camcorder or Other Device .....	31
Connecting Components with HDMI .....	32
Connecting a CD Player or Turntable .....	34
Connecting a Cassette, CDR, MiniDisc, or DAT Recorder .....	35
Connecting a Power Amplifier .....	36
Connecting an RI Dock .....	37
Connecting Integra/Onkyo <b>RI</b> Components .....	38
Connecting the Power Cord .....	38
Turning On the AV Receiver .....	39
Turning On and Standby .....	39

<b>First Time Setup</b>	
First Time Setup .....	40
Monitor Setup .....	40
Using the Onscreen Setup Menus .....	41
Video Input Setup .....	42
Digital Input Setup .....	44
Speaker Settings .....	45
TV Format Setup (not North American models) .....	46
AM Frequency Step Setup (not North American models) .....	47
Changing the Input Display .....	48
Automatic Speaker Setup (Audyssey MultEQ®) .....	49

<b>Basic Operations</b>	
Basic Operations .....	54
Selecting the Input Source .....	54
Using the Multichannel DVD Input .....	55
Adjusting the Bass & Treble .....	55
Displaying Source Information .....	55
Setting the Display Brightness .....	55
Muting the AV receiver .....	56
Using the Sleep Timer .....	56
Using Headphones .....	56

Listening to the Radio .....	57
Using the Tuner .....	57
Presetting AM/FM Stations .....	58
Listening to XM Satellite Radio® (North American Model Only) .....	59
Listening to SIRIUS Satellite Radio® (North American Models Only) .....	66
Using RDS (not North American model) .....	76
Recording .....	78

<b>Using the Listening Modes</b>	
Using the Listening Modes .....	79
Selecting Listening Modes .....	79
Listening Modes Available for Each Source Format .....	80
About the Listening Modes .....	86

<b>Advanced Setup</b>	
Advanced Setup .....	89
Onscreen Setup Menus .....	89
Speaker Setup .....	90
Audio Adjust Functions .....	98
Adjust Using the Audio Button .....	100
Assigning Listening Modes to Input Sources .....	102
Source Setup .....	103
Miscellaneous (Volume/OSD) Setup .....	106
Hardware Setup .....	108
Lock Setup .....	112
Automatic Audio Input Selection Setup .....	113
Digital Input Signal Formats .....	113

<b>Zone 2</b>	
Zone 2 .....	114
Connecting Zone 2 .....	114
Setting the Powered Zone 2 .....	116
Setting the Zone2 Out .....	117
Using Zone 2 .....	118
Using the 12V Triggers .....	120
Using the Remote Controller in Zone 2 and Multiroom Control Kits .....	121

<b>Controlling Other Components</b>	
Controlling Other Components .....	122
Preprogrammed Remote Control Codes .....	122
Entering Remote Control Codes .....	122
Remote Control Codes for Integra/Onkyo Components Connected via <b>RI</b> .....	123
Resetting Remote Mode Buttons .....	123
Resetting the Remote Controller .....	123
Controlling a TV .....	124
Controlling a DVD Player or DVD Recorder .....	125
Controlling a VCR or PVR .....	126
Controlling a Satellite Receiver or Cable Receiver .....	127
Controlling a CD Player, CD Recorder, or MD Player .....	128
Controlling an RI Dock .....	129
Controlling a Cassette Recorder .....	130
Learning Commands .....	131
Using Macros .....	132

<b>Others</b>	
Specifications .....	133
Troubleshooting .....	134
Video Resolution Chart .....	139

\* To reset the AV receiver to its factory defaults, turn it on and, while holding down the [VCR/DVR] button, press the [On/Standby] button (see page 134).

# Features

## Amplifier

- 130 Watts/Channel (2ch Driven) @ 8 ohms (FTC)
- 180 Watts/Channel @ 6 ohms (IEC)
- 180 Watts/Channel @ 6 ohms (JEITA)
- WRAT-Wide Range Amplifier Technology (5 Hz-100 kHz bandwidth)
- Linear Optimum Gain Volume Circuitry
- Push-Pull Amplifier Design with 3-Step Inverted Darlington Circuitry
- H.C.P.S. (High Current Power Supply) Massive High Power Transformer

## Processing

- THX Ultra2 Plus<sup>\*1</sup> Certified
- HDMI Video Upscaling (to 1080p Compatible) with Faroudja DCDi Cinema Enhancement
- HDMI ver.1.3a with Repeater System (Deep Color, x.v.Color, Lip Sync, DTS<sup>2</sup>-HD Master Audio, DTS-HD High Resolution Audio, Dolby TrueHD<sup>\*3</sup>, Dolby Digital Plus, SA-CD and Multi-CH PCM)
- Component Video Upconversion
- Non-Scaling Configuration
- Direct Mode
- 192 kHz/24-bit D/A Converters
- Two TI (Aureus) 32-bit DSP Processing

## Connections

- 5 HDMI<sup>\*4</sup> Inputs and 1 Output (ver. 1.3a)
- Onkyo **RIHD** for System Control
- 6 Digital Inputs (3 Optical / 3 Coaxial)/2 Output (1 Optical/1 Coaxial)
- 5 S-Video Inputs / 2 Outputs
- Component Video Switching (3 Inputs/2 Output)
- Banana Plug-Compatible Speaker Posts
- Powered Zone 2 and Zone 2 Pre Out
- IR Input/Output and 12 V Trigger
- RS232 Port for Interface Control
- Bi-Amp Connectable for FL/FR with SBL/SBR

## Miscellaneous

- SIRIUS Ready<sup>\*5</sup> / XM Ready<sup>\*6</sup> with XMHD Surround (North American models only)
- 40 SIRIUS/XM/AM/FM Presets (North American models)
- 40 AM/FM Presets (Australian model)
- Audyssey MultEQ<sup>\*7</sup> Room Correction and Speaker Calibration
- Audyssey Dynamic EQ<sup>\*7</sup> Loudness Correction
- Crossover Adjustment (40/45/50/55/60/70/80/90/100/110/120/130/150/200 Hz)
- A/V Sync Control Function (up to 250 ms)
- Music Optimizer<sup>\*8</sup> for Compressed Music
- Newly Designed GUI for System Set-up
- Compatible with RI Dock for iPod
- Aluminum Front Panel
- Preprogrammed **RI**-Compatible Remote with 2 Macros and Mode-Key LEDs

\*1. **THX**  
ULTRA2 PLUS  
THX and Ultra2 Plus are trademarks of THX Ltd. THX may be registered in some jurisdictions. All rights reserved. Surround EX is a trademark of Dolby Laboratories. Used with permission.

\*2. **dts-hd**  
Master Audio  
Manufactured under license under U.S. Patent #'s: 5,451,942; 5,956,674; 5,974,380; 5,978,762; 6,226,616; 6,487,535 & other U.S. and worldwide patents issued & pending.  
DTS is a registered trademark and the DTS logos, Symbol, DTS-HD and DTS-HD Master Audio are trademarks of DTS, Inc. ©1996-2007 DTS, Inc. All Rights Reserved.

\*3. **DOLBY**  
**TRUEHD**  
Manufactured under license from Dolby Laboratories. "Dolby", "Pro Logic" and the double-D symbol are trademarks of Dolby Laboratories.

\*4. **HDMI**  
HDMI, the HDMI logo and High Definition Multimedia Interface are trademarks or registered trademarks of HDMI Licensing, LLC.

\*5. **SIRIUS**  
READY  
©2005 SIRIUS Satellite Radio Inc. "SIRIUS", SiriusConnect, the SIRIUS dog logo, channel names and logos are trademarks of SIRIUS Satellite Radio Inc. Available only in the contiguous United States (excluding Alaska and Hawaii) and Canada.

\*6. **((XM))**  
READY  
XM Ready<sup>®</sup> is a registered trademark of XM Satellite Radio Inc. ©2005 XM Satellite Radio Inc. All rights reserved.

\*7. **AUDYSSEY**  
MULTEQ  
DYNAMIC EQ  
Manufactured under license from Audyssey Laboratories. U.S. and foreign patents pending. Audyssey MultEQ<sup>®</sup> and Dynamic EQ are trademark of Audyssey Laboratories.

\*8. Music Optimizer<sup>™</sup> is a trademark of Onkyo Corporation.

### THX Ultra2 Plus

Before any home theater component can be THX Ultra2 Plus certified, it must pass a rigorous series of quality and performance tests. Only then can a product feature the THX Ultra2 Plus logo, which is your guarantee that the Home Theater products you purchase will give you superb performance for many years to come. THX Ultra2 Plus requirements define hundreds of parameters, including power amplifier performance, and pre-amplifier performance and operation for both digital and analog domains. THX Ultra2 Plus receivers also feature proprietary THX technologies (e.g., THX Mode) which accurately translate movie soundtracks for home theater playback.

\* "Xantech" is a registered trademark of Xantech Corporation.  
\* "Niles" is a registered trademark of Niles Audio Corporation.  
\* Apple and iPod are trademarks of Apple Inc., registered in the U.S. and other countries.  
\* "x.v.Color" is a trademark of Sony Corporation.  
This product incorporates copyright protection technology that is protected by U.S. patents and other intellectual property rights. Use of this copyright protection technology must be authorized by Macrovision Corporation, and is intended for home and other limited consumer uses only unless otherwise authorized by Macrovision. Reverse engineering or disassembly is prohibited.

# Front & Rear Panels

## Front Panel

### North American model

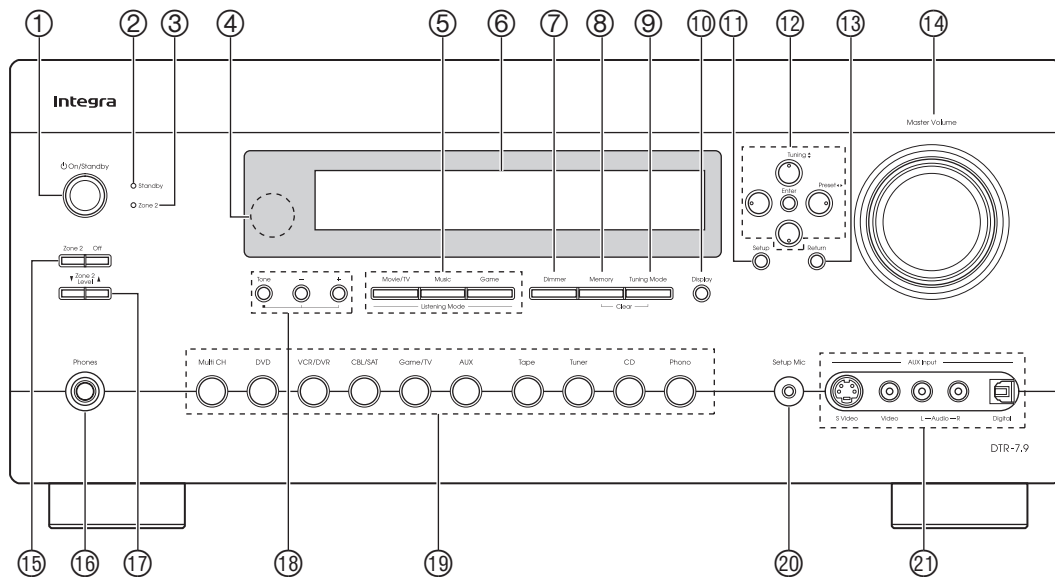

### Australian model

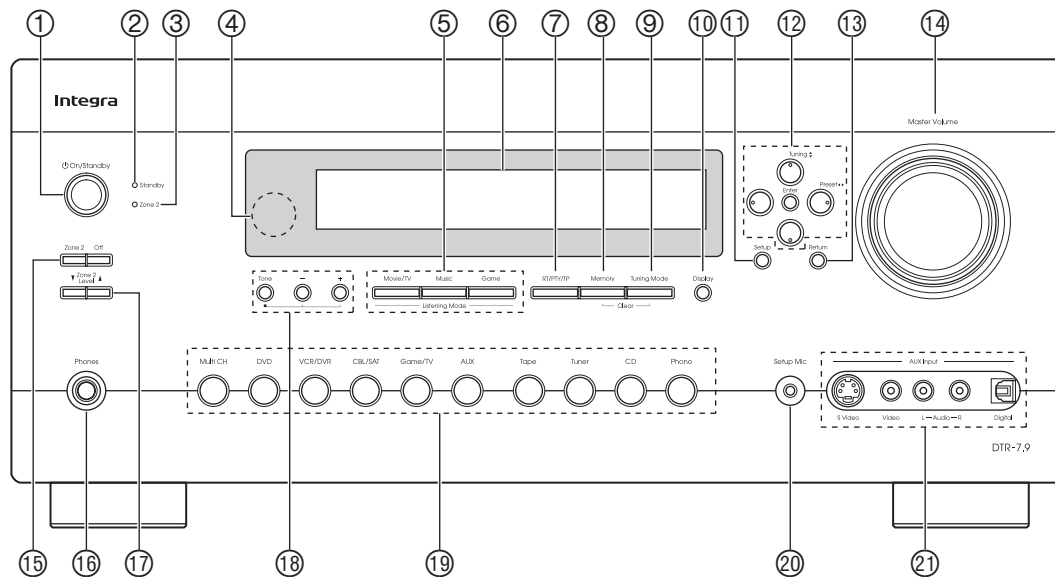

The actual front panel has various logos printed on it. They are not shown here for clarity.

The page numbers in parentheses show where you can find the main explanation for each item.

- ① **On/Standby button (39)**

This button is used to set the AV receiver to On or Standby.
- ② **Standby indicator (39)**

This indicator lights up when the AV receiver is in Standby mode, and it flashes while a signal is being received from the remote controller.
- ③ **Zone 2 indicator (118)**

This indicator lights up when Zone 2 is selected.
- ④ **Remote control sensor (13)**

This sensor receives control signals from the remote controller.
- ⑤ **Listening Mode buttons**
  - Movie/TV button (79)**

Selects the listening modes intended for use with movies and TV.
  - Music button (79)**

Selects the listening modes intended for use with music.
  - Game button (79)**

Selects the listening modes intended for use with video games.
- ⑥ **Display**

See “Display” on page 9.
- ⑦ **Dimmer or RT/PTY/TP button (55, 77)**

This button is used to adjust the display brightness. On the Australian model, this is the [RT/PTY/TP] button, and it’s for RDS (Radio Data System). See “Using RDS (not North American model)” on page 76.
- ⑧ **Memory button (58)**

This button is used when storing or deleting radio presets.
- ⑨ **Tuning Mode button (57)**

This button is used to select the Auto or Manual tuning mode.
- ⑩ **Display button (55)**

This button is used to display various information about the currently selected input source.
- ⑪ **Setup button**

This button is used to access the onscreen setup menus that appear on the connected TV.
- ⑫ **Arrow, Tuning, Preset and Enter buttons**

When the AM or FM input source is selected, the Tuning [▲]/[▼] buttons are used to tune the tuner, and the Preset [◀]/[▶] buttons are used to select radio presets (see page 58).  
When the onscreen setup menus are used, they work as arrow buttons and are used to select and set items. The [Enter] button is also used with the onscreen setup menus.
- ⑬ **Return button**

This button is used to return to the previously displayed onscreen setup menu.
- ⑭ **Master Volume control (54)**

This control is used to adjust the volume of the AV receiver to  $-\infty$  dB,  $-81.5$  dB through  $+18.0$  dB (relative display).  
The volume level can also be displayed as an absolute value. See “Volume Setup” on page 106.
- ⑮ **Zone 2 and Off buttons (118)**

The [Zone 2] button is used to select the input source for Zone 2.  
The [Off] button is used to turn off the output of Zone 2.
- ⑯ **Phones jack (56)**

This 1/4-inch phone jack is for connecting a standard pair of stereo headphones for private listening.
- ⑰ **Zone 2 Level button (119)**

Used when adjusting the volume level of Zone 2.
- ⑱ **Tone, Plus [+], and Minus [-] buttons (55, 119)**

Used to adjust the tone (bass and treble), and the volume and balance of Zone 2.
- ⑲ **Input selector buttons (54)**

These buttons are used to select from the following input sources: Multi CH, DVD, VCR/DVR, CBL/SAT, Game/TV, AUX, Tape, Tuner, CD, Phono.  
The [Multi CH] button selects the DVD analog multichannel input.
- ⑳ **Setup Mic jack (49)**

The included speaker setup microphone is connected here for automatic speaker setup.
- ㉑ **AUX Input**

This input can be used to connect a camcorder, game console, and so on. There are input jacks for optical digital audio, S-Video, composite video, and analog audio.



## Display

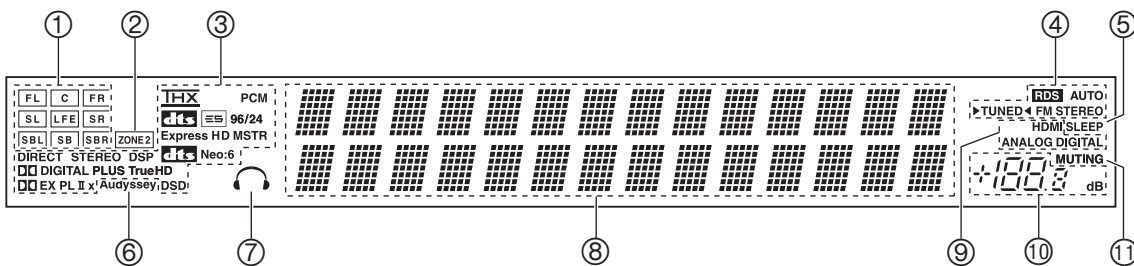

For detailed information, see the pages in parentheses.

### ① **Speaker/channel indicators (90)**

Indicate the speaker configuration and channels used by the current input source.



A box is displayed for each speaker that's set in the Speaker Configuration. No box appears for speakers that are set to "No" or "None".

The following abbreviations indicate which audio channels are included in the current input signal.

- FL:** Front left
- C:** Center
- FR:** Front right
- SL:** Surround left
- LFE:** Subwoofer (Low Frequency Effects)
- SR:** Surround right
- SBL:** Surround back left
- SB:** Surround back
- SBR:** Surround back right

### ② **ZONE 2 indicator (118)**

Lights up when Powered Zone 2 is being used.

### ③ **Listening mode and format indicators (79)**

Show the selected listening mode and audio input signal format.

### ④ **Tuning indicators (57)**

#### **RDS (not North American model) (76):**

Lights up when tuned to a radio station that supports RDS (Radio Data System).

#### **AUTO (57):**

Lights up when Auto Tuning mode is selected for AM or FM radio. Goes off when Manual Tuning mode is selected.

#### **TUNED (57):**

Lights up when tuned to a radio station.

#### **FM STEREO (57):**

Lights up when tuned to a stereo FM station.

### ⑤ **SLEEP indicator (56)**

Lights up when the Sleep function has been set.

### ⑥ **Audyssey indicator (49, 95)**

Flashes during automatic speaker setup. Lights up when the "Equalizer Settings" is set to "Audyssey".

### ⑦ **Headphone indicator (56)**

Lights up when a pair of headphones are plugged into the Phones jack.

### ⑧ **Message area**

Displays various information.

### ⑨ **Audio input indicators**

Indicate the type of audio input that's selected as the audio source: HDMI, ANALOG, or DIGITAL.

### ⑩ **Volume level (54)**

Displays the volume level.

### ⑪ **MUTING indicator (56)**

Flashes while the AV receiver is muted.

Rear Panel

North American model only

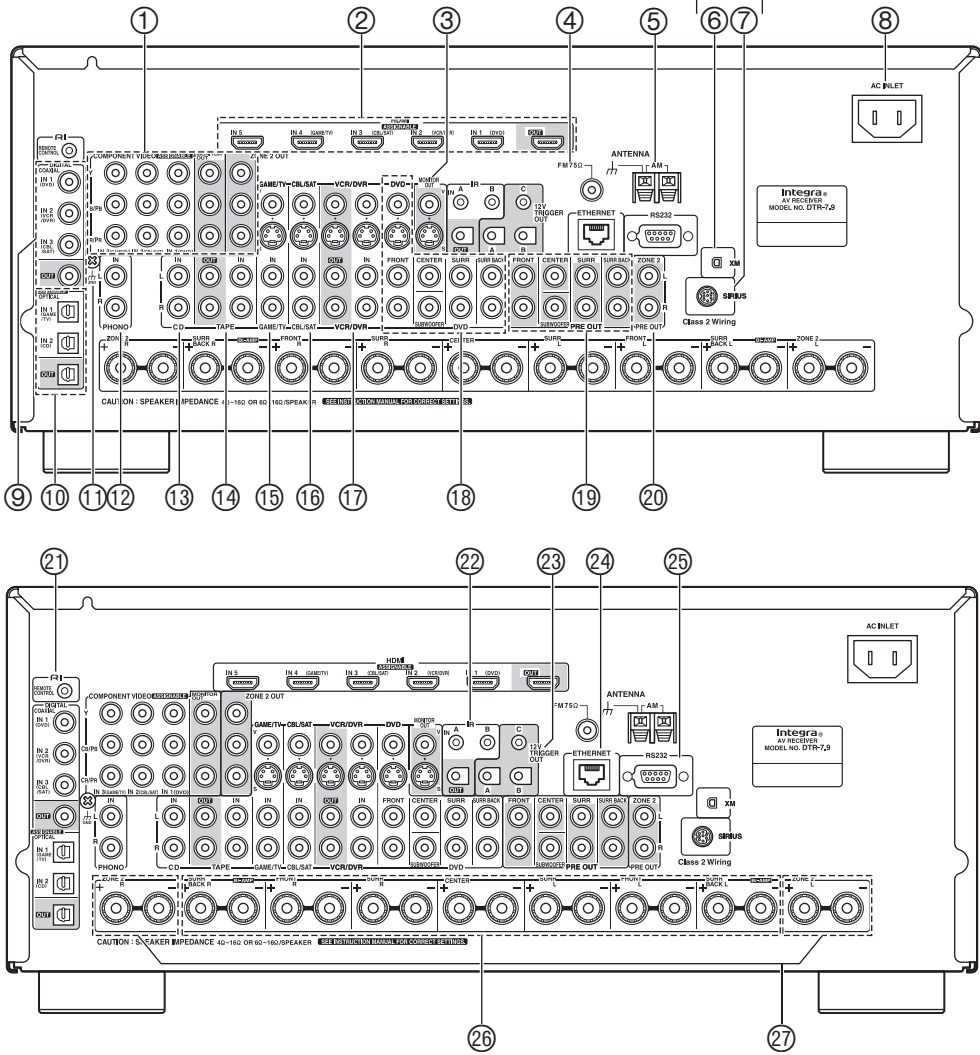

### ① **COMPONENT VIDEO IN 1, 2 and 3**

These RCA component video inputs are for connecting components with a component video output, such as a DVD player, DVD recorder, or DVR (digital video recorder). They're assignable, which means you can assign each one to an input selector to suit your setup. See "Component Video Setup" on page 43.

### **COMPONENT VIDEO MONITOR OUT**

This RCA component video output is for connecting a TV or projector with a component video input.

### **COMPONENT VIDEO ZONE 2 OUT**

This RCA component video output is for connecting a TV or projector with a component video input located in your main listening room or Zone 2.

### ② **HDMI IN 1–5 and OUT**

HDMI (High Definition Multimedia Interface) connections carry digital audio and digital video.

The HDMI inputs are for connecting components with an HDMI output, such as a DVD player, DVD recorder, or DVR (digital video recorder). They're assignable, which means you can assign each one to an input selector to suit your setup. See "HDMI Input Setup" on page 42.

The HDMI output is for connecting a TV or projector with an HDMI input.

### ③ **MONITOR OUT**

The S-Video or composite video jack should be connected to a video input on your TV or projector.

### ④ **FM ANTENNA**

This jack is for connecting an FM antenna.

### ⑤ **AM ANTENNA**

These push terminals are for connecting an AM antenna.

### ⑥ **XM antenna (North American models only)**

This jack is for connecting an XM Mini-Tuner and Home Dock, sold separately (see "Listening to XM Satellite Radio<sup>®</sup> (North American Model Only)" on page 59).

### ⑦ **SIRIUS antenna (North American models only)**

This jack is for connecting a SIRIUS Satellite Radio antenna, sold separately (see "Listening to SIRIUS Satellite Radio<sup>®</sup> (North American Models Only)" on page 66).

### ⑧ **AC INLET**

The supplied power cord is connected here. The other end of the power cord should be connected to a suitable wall outlet.

### ⑨ **DIGITAL COAXIAL IN 1, 2, and 3**

These coaxial digital audio inputs are for connecting components with coaxial digital audio outputs, such as CD and DVD players. They're assignable, which means you can assign each one to an input

selector to suit your setup. See "Digital Input Setup" on page 44.

### **DIGITAL COAXIAL OUT**

The coaxial digital audio output is for connecting a digital recorder with a coaxial digital input, such as a CD recorder.

### ⑩ **DIGITAL OPTICAL IN 1 and 2**

These optical digital audio inputs are for connecting components with optical digital audio outputs, such as CD and DVD players. They're assignable, which means you can assign each one to an input selector to suit your setup. See "Digital Input Setup" on page 44.

### **DIGITAL OPTICAL OUT**

The optical digital audio output is for connecting a digital recorder with an optical digital input, such as a CD recorder.

### ⑪ **GND screw**

This screw is for connecting a turntable's ground wire.

### ⑫ **PHONO IN**

This audio input is for connecting a turntable.

### ⑬ **CD IN**

This analog audio input is for connecting a CD player's analog audio output.

### ⑭ **TAPE IN/OUT**

This analog audio input and output are for connecting a recorder with an analog audio input and output (cassette, Mini Disc, etc.).

### ⑮ **GAME/TV IN**

Here you can connect a game console, TV, etc. Input jacks include S-Video, composite video, and analog audio.

### ⑯ **CBL/SAT IN**

Here you can connect a cable/satellite receiver, set-top box, etc. Input jacks include S-Video, composite video, and analog audio.

### ⑰ **VCR/DVR IN/OUT**

Here you can connect a VCR or DVR (digital video recorder). Input and output jacks include S-Video, composite video, and analog audio.

### ⑱ **DVD V, S, FRONT L/R**

Here you can connect a DVD player. Input jacks include S-Video, composite video, and analog audio. You can connect a DVD player's 2-channel analog audio output.

### **DVD FRONT L/R, CENTER, SUBWOOFER, SURR L/R, and SURR BACK L/R**

This analog multichannel input is for connecting a component with a 5.1/7.1-channel analog audio output, such as a DVD player, DVD-Audio or SACD-capable player, or an MPEG decoder.

19 **PRE OUT: FRONT L/R, CENTER, SUBWOOFER, SURR L/R, and SURR BACK L/R**

This 5.1/7.1 multichannel analog audio output can be connected to the analog audio input on a multichannel power amplifier for when you want to use the AV receiver solely as a preamplifier. The SUBWOOFER jack is for connecting a powered subwoofer.

See pages 15-38 for connection information.

20 **PRE OUT: ZONE 2 L/R**

This analog audio output can be connected to a line input on an integrated amplifier in Zone 2. See “Connecting Zone 2” on page 114.

21 **RI REMOTE CONTROL**

This **RI** (Remote Interactive) jack can be connected to an **RI** jack on another **RI**-capable Integra/Onkyo component. The AV receiver’s remote controller can then be used to control that component. To use **RI**, you must make an analog audio connection (RCA) between the AV receiver and the other AV component, even if they are connected digitally.

22 **IR IN A/B and OUT**

A commercially available IR receiver can be connected to the IR IN A or B jack, allowing you to control the AV receiver while you’re in Zone 2, or control it when it’s out of sight, for example, installed in a cabinet.

A commercially available IR emitter can be connected to the IR OUT jack to pass IR (infrared) remote control signals through to other components.

23 **12V TRIGGER OUT (A/B/C)**

This output can be connected to the 12-volt trigger input on a component in Zone 2. When Zone 2 is turned on on the AV receiver, a 12-volt trigger signal is output.

24 **ETHERNET**

This port is for connecting the AV receiver to home automation equipment and external controllers.

25 **RS232**

This is the RS232 port.

26 **FRONT L/R, CENTER, SURR L/R, and SURR BACK L/R speakers**

These terminal posts are for connecting the front L/R, center, surround L/R, and surround back L/R speakers.

The FRONT L/R and SURR BACK L/R terminal posts can be used with front speakers and surround back speakers respectively, or used to bi-amp the front speakers. See “Bi-amping the Front Speakers” on page 18”.

27 **ZONE 2 L/R speakers**

These terminals are for connecting speakers in Zone 2. See “Connecting Zone 2” on page 114.

# Remote Controller

## Installing the Batteries

- 1 To open the battery compartment, press the small lever and remove the cover.**

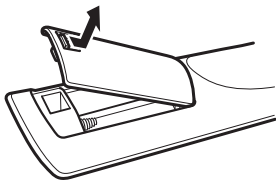

- 2 Insert the two supplied batteries (AA/R6) in accordance with the polarity diagram inside the battery compartment.**

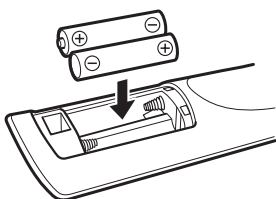

- 3 Replace the cover and push it shut.**

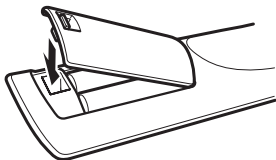

### Notes:

- If the remote controller doesn't work reliably, try replacing the batteries.
- Don't mix new and old batteries or different types of batteries.
- If you intend not to use the remote controller for a long time, remove the batteries to prevent damage from leakage or corrosion.
- Expired batteries should be removed as soon as possible to prevent damage from leakage or corrosion.

## Aiming the Remote Controller

To use the remote controller, point it at the AV receiver's remote control sensor, as shown below.

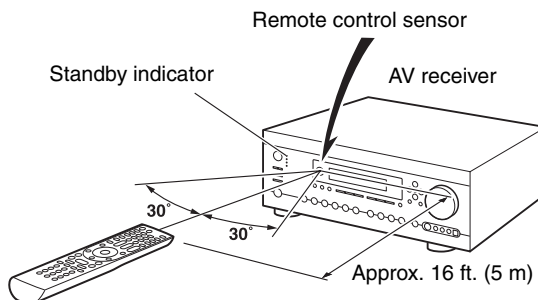

### Notes:

- The remote controller may not work reliably if the AV receiver is subjected to bright light, such as direct sunlight or inverter-type fluorescent lights. Keep this in mind when installing.
- If another remote controller of the same type is used in the same room, or the AV receiver is installed close to equipment that uses infrared rays, the remote controller may not work reliably.
- Don't put anything, such as a book, on the remote controller, because the buttons may be pressed inadvertently, thereby draining the batteries.
- The remote controller may not work reliably if the AV receiver is installed in a rack behind colored glass doors. Keep this in mind when installing.
- The remote controller will not work if there's an obstacle between it and the AV receiver's remote control sensor.
- When the remote control codes have been registered and you want to operate another component (page 122), or when you want to operate an Integra/Onkyo component without **RI** connection, point the remote controller at the other component to use it.
- When you want to operate an Integra/Onkyo component with **RI** connection or an **RIHD**-compatible component connected via HDMI (page 124), point the remote controller at the AV receiver's remote control sensor.

## Controlling the AV Receiver

To control the AV receiver, press the **[Receiver]** button to select Receiver mode.

You can also use the remote controller to control your DVD player, CD player, and other components. See page 122 for more details.

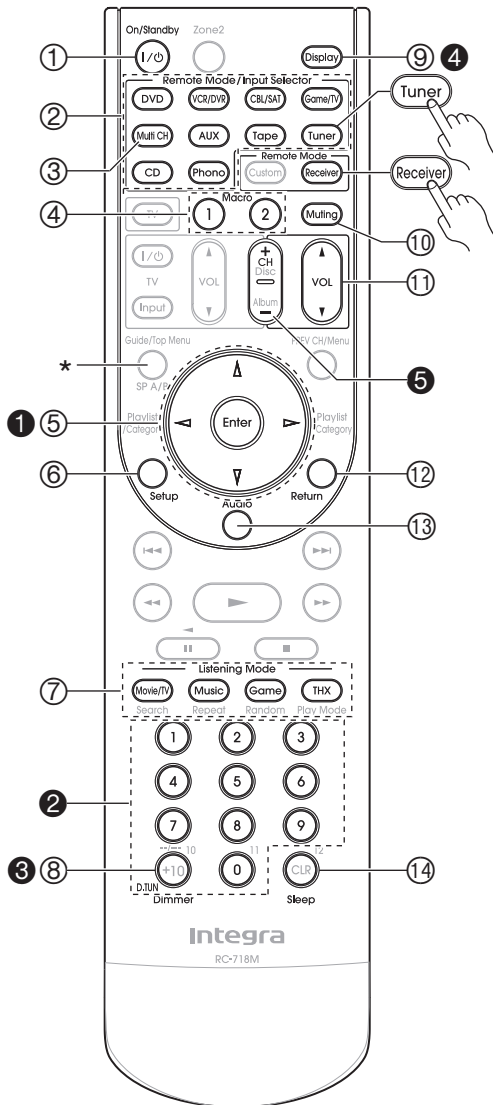

For detailed information, see the pages in parentheses.

- ① **On/Standby button (39)**  
Sets the AV receiver to On or Standby.
- ② **Remote Mode/Input Selector buttons (54, 124–130)**  
Selects the remote controller modes and the input sources.

- ③ **Multi CH button (55)**  
Selects the multichannel DVD input.
  - ④ **Macro buttons (132)**  
Used with the Macro function.
  - ⑤ **Arrow [▲]/[▼]/[◀]/[▶] and Enter buttons**  
Used to select and adjust settings.
  - ⑥ **Setup button**  
Used to change settings.
  - ⑦ **Listening Mode buttons (79)**  
Used to select the listening modes.
  - ⑧ **Dimmer button (55)**  
Adjusts the display brightness.
  - ⑨ **Display button (55)**  
Displays information about the current input source.
  - ⑩ **Muting button (56)**  
Mutes or unmutes the AV receiver.
  - ⑪ **VOL [▲]/[▼] button (54)**  
Adjusts the volume of the AV receiver regardless of the currently selected remote controller mode.
  - ⑫ **Return button**  
Returns to the previous display when changing settings.
  - ⑬ **Audio button (100)**  
Used to change audio settings.  
When the “Audio TV Out” setting is set to “On” (page 110), this button is disabled.
  - ⑭ **Sleep button (56)**  
Used with the Sleep function.
- \* SP A/B is not used in this AV receiver.

### ■ Controlling the tuner

To control the AV receiver’s tuner, press the [Tuner] (or [Receiver]) button.

You can select AM or FM by pressing the [Tuner] button repeatedly.

- ① **Arrow [▲]/[▼] buttons**  
Used to tune into radio stations.
- ② **Number buttons (57)**  
Used to select radio stations directly.
- ③ **D.TUN button (57)**  
Selects the Direct tuning mode.
- ④ **Display button (63, 73)**  
Displays information about the band, frequency, preset number, and so on.
- ⑤ **CH +/- button (58)**  
Used to select radio presets.

### Note:

An Onkyo cassette recorder connected via **RI** can also be controlled in Receiver mode (see page 130).

# About Home Theater

## Enjoying Home Theater

Thanks to the AV receiver's superb capabilities, you can enjoy surround sound with a real sense of movement in your own home—just like being in a movie theater or concert hall. With DVDs you can enjoy DTS and Dolby Digital. With analog or digital TV, you can enjoy Dolby Pro Logic IIX, DTS Neo:6, or Onkyo's original DSP listening modes. You can also enjoy THX Surround EX (THX-certified THX speaker system recommended).

### Front left and right speakers

These output the overall sound. Their role in a home theater is to provide a solid anchor for the sound image. They should be positioned facing the listener at about ear level, and equidistant from the TV. Angle them inward so as to create a triangle, with the listener at the apex.

### Center speaker

This speaker enhances the front left and right speakers, making sound movements distinct and providing a full sound image. In movies it's used mainly for dialog. Position it close to your TV facing forward at about ear level, or at the same height as the front left and right speakers.

### Subwoofer

The subwoofer handles the bass sounds of the LFE (Low-Frequency Effects) channel. The volume and quality of the bass output from your subwoofer will depend on its position, the shape of your listening room, and your listening position. In general, a good bass sound can be obtained by installing the subwoofer in a front corner, or at one-third the width of the wall, as shown.

**Tip:** To find the best position for your subwoofer, while playing a movie or some music with good bass, experiment by placing your subwoofer at various positions within the room, and choose the one that provides the most satisfying results.

### Surround back left and right speakers

These speakers are necessary to enjoy Dolby Digital EX, DTS-ES Matrix, DTS-ES Discrete, THX Surround EX, etc. They enhance the realism of surround sound and improve sound localization behind the listener. Position them behind the listener about 2–3 feet (60–100 cm) above ear level.

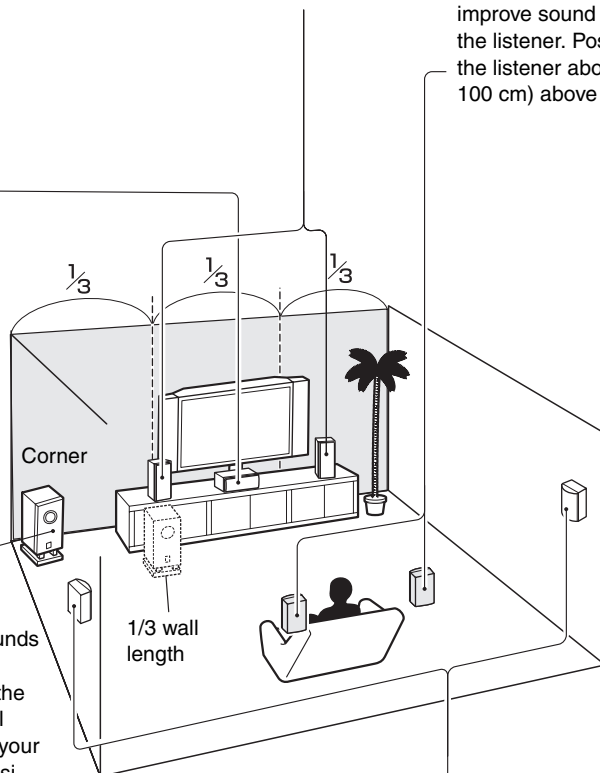

### Surround left and right speakers

These speakers are used for precise sound positioning and to add realistic ambience.

Position them at the sides of the listener, or slightly behind, about 2–3 feet (60–100 cm) above ear level. Ideally they should be equidistant from the listener.

# Connecting the AV Receiver

## Connecting Your Speakers

### Speaker Configuration

For 7.1-channel surround-sound playback, you need seven speakers and a powered subwoofer.

The following table indicates the channels you should use depending on the number of speakers that you have.

Number of speakers:	2	3	4	5	6	7
Front left	✓	✓	✓	✓	✓	✓
Front right	✓	✓	✓	✓	✓	✓
Center		✓		✓	✓	✓
Surround left			✓	✓	✓	✓
Surround right			✓	✓	✓	✓
Surround back*					✓	
Surround back left						✓
Surround back right						✓

\* If you're using only one surround back speaker, connect it to the SURR BACK L terminals.

No matter how many speakers you use, a powered subwoofer is recommended for a really powerful and solid bass.

To get the best from your surround sound system, you need to set the speaker settings. You can do this automatically (see page 49) or manually (see page 90).

### Using Dipole Speakers

You can use dipole speakers for the surround left and right and surround back left and right speakers. Dipole speakers output the same sound in two directions.

Dipole speakers typically have an arrow printed on them to indicate how they should be positioned. The surround left and right dipole speakers should be positioned so that their arrows point toward the TV/screen, while the surround back left and right dipole speakers should be positioned so that their arrows point toward each other, as shown.

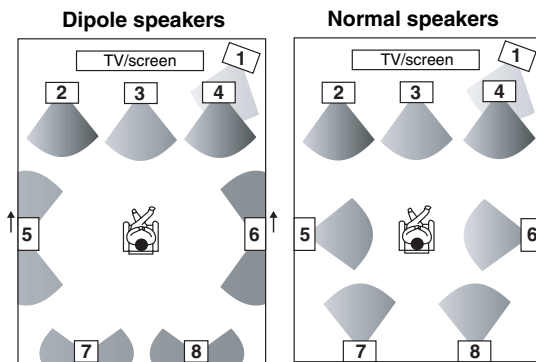

1. Subwoofer
2. Front left speaker
3. Center speaker
4. Front right speaker
5. Surround left speaker
6. Surround right speaker
7. Surround back left speaker
8. Surround back right speaker

## Connecting a Powered Subwoofer

Using a suitable cable, connect the AV receiver's PRE OUT: SUBWOOFER to an input on your powered subwoofer, as shown. If your subwoofer is unpowered and you're using an external amplifier, connect the PRE OUT: SUBWOOFER to an input on the amp.

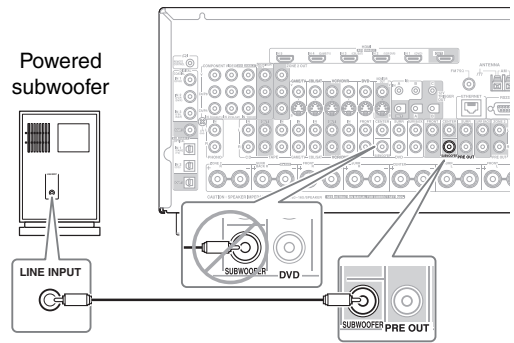

## Attaching the Speaker Labels

The AV receiver's positive (+) speaker terminals are all red (the negative (-) speaker terminals are all black).

Speaker	Color
Front left, Zone 2 left	White
Front right, Zone 2 right	Red
Center	Green
Surround left	Blue
Surround right	Gray
Surround back left	Brown
Surround back right	Tan

The supplied speaker cable labels are also color-coded and you should attach them to the positive (+) side of each speaker cable in accordance with the above table. Then all you need to do is to match the color of each label to the corresponding speaker terminal.



### For North American model

- If you are using banana plugs, tighten the speaker terminal before inserting the banana plug.
- Do not insert the speaker code directly into the center hole of the speaker terminal.



## Connecting the AV Receiver—Continued

### Speaker Connection Precautions

Read the following before connecting your speakers:

- You can connect speakers with an impedance of between 4 and 16 ohms. If the impedance of any of the connected speakers is 4 ohms or more, but less than 6 ohms, be sure to set the minimum speaker impedance to “4ohms” (see page 45). If you use speakers with a lower impedance, and use the amplifier at high volume levels for a long period of time, the built-in amp protection circuit may be activated.
- Disconnect the power cord from the wall outlet before making any connections.
- Read the instructions supplied with your speakers.
- Pay close attention to speaker wiring polarity. In other words, connect positive (+) terminals only to positive (+) terminals, and negative (–) terminals only to negative (–) terminals. If you get them the wrong way around, the sound will be out of phase and will sound unnatural.
- Unnecessarily long, or very thin speaker cables may affect the sound quality and should be avoided.

- If you use 4 or 5 speakers, connect each of the two surround speakers to the SURR L/R terminals. Do not connect them to the SURR BACK L/R terminals.
- Be careful not to short the positive and negative wires. Doing so may damage the AV receiver.
- Make sure the metal core of the wire does not have contact with the AV receiver’s rear panel. Doing so may damage the AV receiver.
- Don’t connect more than one cable to each speaker terminal. Doing so may damage the AV receiver.
- Don’t connect one speaker to several terminals.

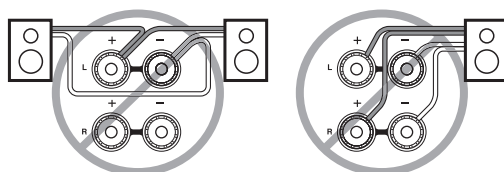
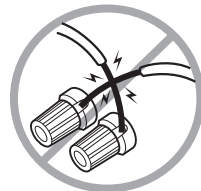

### Connecting the Speaker Cables

- 1 Strip about 5/8" (15 mm) of insulation from the ends of the speaker cables, and twist the bare wires tightly, as shown.**

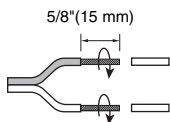

- 2 Unscrew the terminal.**



- 3 Fully insert the bare wires.**



- 4 Screw the terminal tight.**



The following illustration shows which speaker should be connected to each pair of terminals. If you’re using only one surround back speaker, connect it to the SURR BACK L terminals.

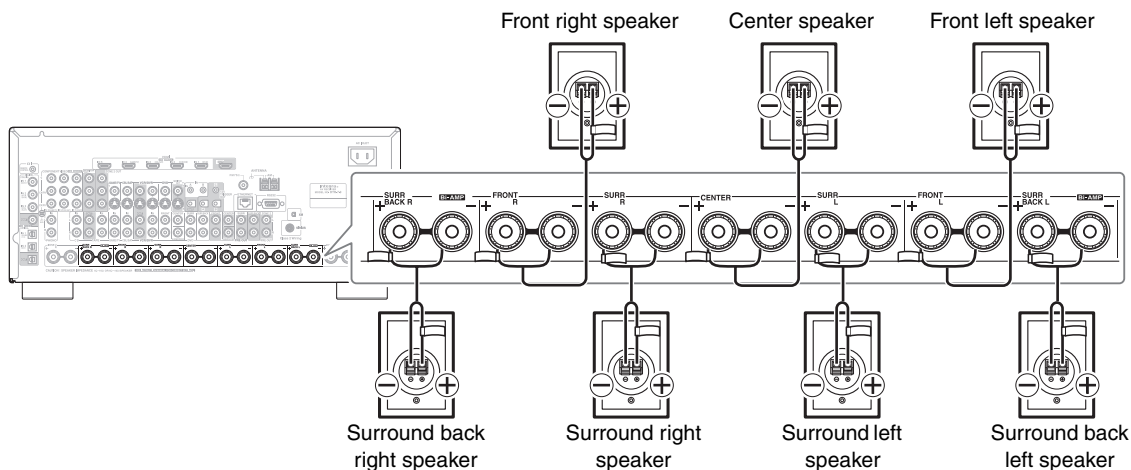

## Bi-amping the Front Speakers

The FRONT L/R and SURR BACK L/R terminal posts can be used with front speakers and surround back speakers respectively, or bi-amped to provide separate tweeter and woofer feeds for a pair of front speakers that support bi-amping, providing improved bass and treble performance.

- When bi-amping is used, the AV receiver is able to drive up to 5.1 speakers in the main room.
- For bi-amping, the FRONT L/R terminal posts connect to the front speakers' woofer terminals. And the SURR BACK L/R terminal posts connect to the front speakers' tweeter terminals.
- Once you've completed the bi-amping connections shown below and turned on the AV receiver, you must set the "Speakers Type" setting to "Bi-Amp" to enable biamping (see page 45).

### Important:

- **When making the bi-amping connections, be sure to remove the jumper bars that link the speakers' tweeter (high) and woofer (low) terminals.**
- Bi-amping can only be used with speakers that support bi-amping. Refer to your speaker manual.

## Bi-amping Speaker Hookup

- 1 Connect the AV receiver's FRONT R positive (+) terminal to the right speaker's positive (+) Woofer (low) terminal. And connect the AV receiver's FRONT R negative (-) terminal to the right speaker's negative (-) Woofer (low) terminal.
- 2 Connect the AV receiver's SURR BACK R positive (+) terminal to the right speaker's positive (+) Tweeter (high) terminal. And connect the AV receiver's SURR BACK R negative (-) terminal to the right speaker's negative (-) Tweeter (high) terminal.
- 3 Connect the AV receiver's FRONT L positive (+) terminal to the left speaker's positive (+) Woofer (low) terminal. And connect the AV receiver's FRONT L negative (-) terminal to the left speaker's negative (-) Woofer (low) terminal.
- 4 Connect the AV receiver's SURR BACK L positive (+) terminal to the left speaker's positive (+) Tweeter (high) terminal. And connect the AV receiver's SURR BACK L negative (-) terminal to the left speaker's negative (-) Tweeter (high) terminal.

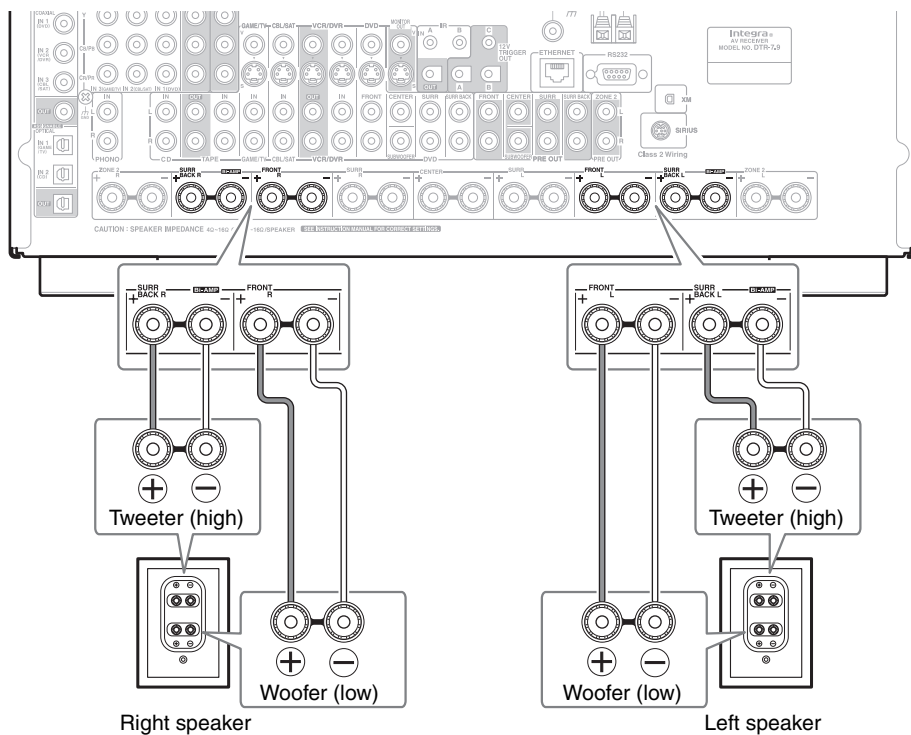

## Connecting the AV Receiver—Continued

### Connecting Antenna

This section explains how to connect the supplied indoor FM antenna and AM loop antenna, and how to connect commercially available outdoor FM and AM antennas. The AV receiver won't pick up any radio signals without any antenna connected, so you must connect the antenna to use the tuner.

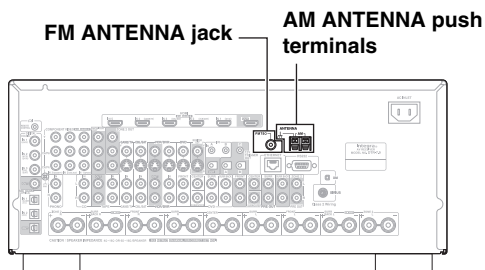

### Connecting the Indoor FM Antenna

The supplied indoor FM antenna is for indoor use only.

#### 1 Attach the FM antenna, as shown.

##### ■ North American models

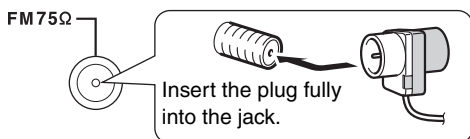

##### ■ Other models

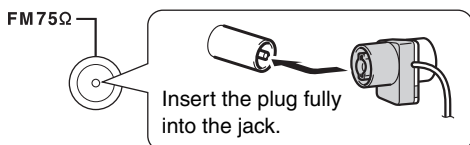

Once your AV receiver is ready for use, you'll need to tune into an FM radio station and adjust the position of the FM antenna to achieve the best possible reception.

#### 2 Use thumbtacks or something similar to fix the FM antenna into position.

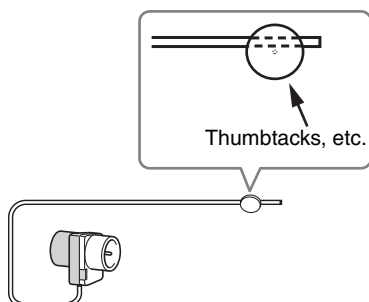

##### Caution:

Be careful that you don't injure yourself when using thumbtacks.

If you cannot achieve good reception with the supplied indoor FM antenna, try a commercially available outdoor FM antenna instead (see page 20).

### Connecting the AM Loop Antenna

The supplied indoor AM loop antenna is for indoor use only.

#### 1 Assemble the AM loop antenna, inserting the tabs into the base, as shown.

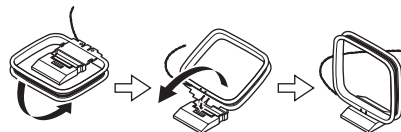

#### 2 Connect both wires of the AM loop antenna to the AM antenna push terminals, as shown.

(The antenna's wires are not polarity sensitive, so they can be connected either way around.)

Make sure that the wires are attached securely and that the push terminals are gripping the bare wires, not the insulation.

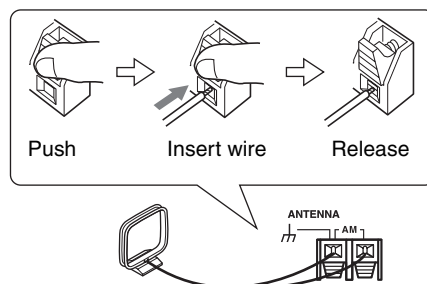

Once your AV receiver is ready for use, you'll need to tune into an AM radio station and adjust the position of the AM antenna to achieve the best possible reception.

Keep the antenna as far away as possible from your AV receiver, TV, speaker cables, and power cords.

If you cannot achieve good reception with the supplied indoor AM loop antenna, try using it with a commercially available outdoor AM antenna (see page 20).

## Connecting the AV Receiver—Continued

### Connecting an Outdoor FM Antenna

If you cannot achieve good reception with the supplied indoor FM antenna, try a commercially available outdoor FM antenna instead.

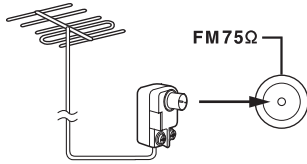

#### Notes:

- Outdoor FM antennas work best outside, but usable results can sometimes be obtained when installed in an attic or loft.
- For best results, install the outdoor FM antenna well away from tall buildings, preferably with a clear line of sight to your local FM transmitter.
- Outdoor antenna should be located away from possible noise sources, such as neon signs, busy roads, etc.
- For safety reasons, outdoor antenna should be situated well away from power lines and other high-voltage equipment.
- Outdoor antenna must be grounded in accordance with local regulations to prevent electrical shock hazards.

### ■ Using a TV/FM Antenna Splitter

It's best not to use the same antenna for both FM and TV reception, as this can cause interference problems. If circumstances demand it, use a TV/FM antenna splitter, as shown.

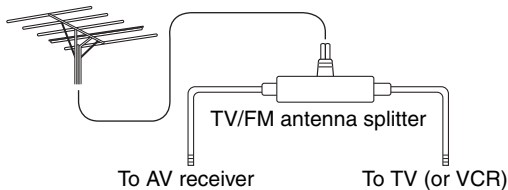

### Connecting an Outdoor AM Antenna

If good reception cannot be achieved using the supplied AM loop antenna, an outdoor AM antenna can be used in addition to the loop antenna, as shown.

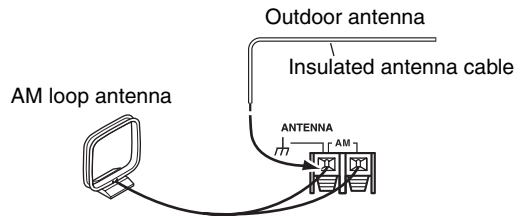

Outdoor AM antennas work best when installed outside horizontally, but good results can sometimes be obtained indoors by mounting horizontally above a window. Note that the AM loop antenna should be left connected. Outdoor antenna must be grounded in accordance with local regulations to prevent electrical shock hazards.

## Connecting the AV Receiver—Continued

### About AV Connections

- Before making any AV connections, read the manuals supplied with your other AV components.
- Don't connect the power cord until you've completed and double-checked all AV connections.

### Optical Digital Jacks







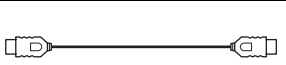

The AV receiver's optical digital jacks have shutter-type covers that open when an optical plug is inserted and close when it's removed. Push plugs in all the way.

#### Caution:





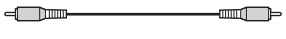

To prevent shutter damage, hold the optical plug straight when inserting and removing.

### AV Cables & Jacks

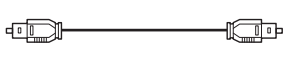
#### Video

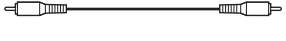
Cable	Jack	Description
		HDMI connections can carry uncompressed standard- or high-definition digital video and audio and offer the best picture and sound quality.
		Component video separates the luminance (Y) and color difference signals (PR, PB), providing the best picture quality (some TV manufacturers label their component video sockets slightly differently).
		S-Video separates the luminance and color signals and provides better picture quality than composite video.
		Composite video is commonly used on TVs, VCRs, and other video equipment.

#### Audio

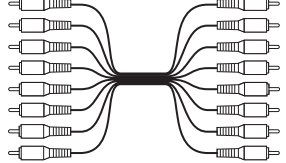
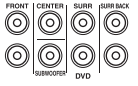
Cable	Jack	Description
		Offers the best sound quality and allows you to enjoy surround sound (e.g., Dolby Digital, DTS). The audio quality is the same as for coaxial.
		Offers the best sound quality and allows you to enjoy surround sound (e.g., Dolby Digital, DTS). The audio quality is the same as for optical.
		This cable carries analog audio. It's the most common connection format for analog audio, and can be found on virtually all AV components.
		This cable carries multichannel analog audio and it's typically used to connect DVD players with a 7.1-channel analog audio output. Several standard analog audio cables can be used instead of a multi-channel cable.

#### Note:

The AV receiver does not support SCART plugs.

### AV Connection Color Coding

RCA-type AV connections are usually color-coded: red, white, and yellow. Use red plugs to connect right-channel audio inputs and outputs (typically labeled "R"). Use white plugs to connect left-channel audio inputs and outputs (typically labeled "L"). And use yellow plugs to connect composite video inputs and outputs.



- Push plugs in all the way to make good connections (loose connections can cause noise or malfunctions).
- To prevent interference, keep audio and video cables away from power cords and speaker cables.

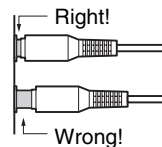

## Connecting the AV Receiver—Continued

### Connecting Both Audio & Video

By connecting both the audio and video outputs of your DVD player and other AV components to the AV receiver, you can select both the audio and video simultaneously simply by selecting the appropriate input source on the AV receiver.

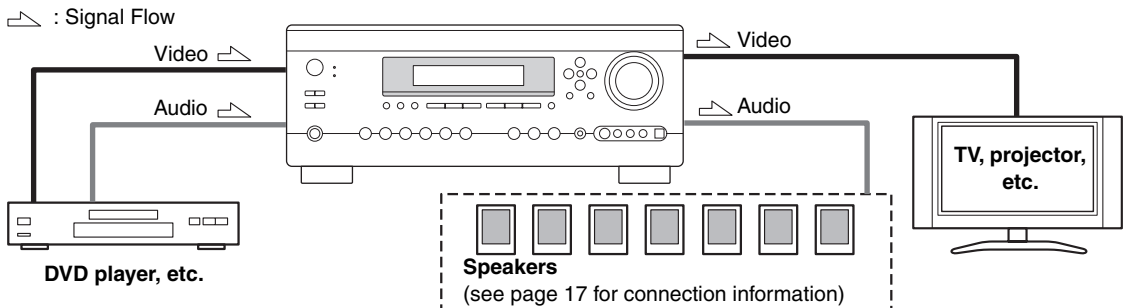

### Which Connections Should I Use?

The AV receiver supports several connection formats for compatibility with a wide range of AV equipment. The format you choose will depend on the formats supported by your other components. Use the following sections as a guide.

For video components, you must make two connections—one for audio, one for video.

#### Video Connection Formats

Video equipment can be connected to the AV receiver by using any one of the following video connection formats: composite video, S-Video, component video, or HDMI, the latter offering the best picture quality.

The AV receiver can upconvert and downconvert between video formats, depending on the "Monitor Out" setting, which generally determines whether video signals are upconverted for the component video output or the HDMI output.

**For optimal video performance, THX recommends that video signals pass through the system without upconversion (e.g., component video input through to component video output). It's also recommended that you set the "Immediate Display" preference to "Off" (see page 107), the "Picture Adjust" setting to the default (see page 105), and the "Output Resolution" setting to "Through" (see page 109).**

#### ■ "Monitor Out" Setting Set to "HDMI"

With the "Monitor Out" setting set to "HDMI" (see page 40), video input signals flow through the AV receiver as shown, with composite video, S-Video, and component video sources all being upconverted for the HDMI output. **Use this setting if you connect the AV receiver's HDMI OUT to your TV.**

The composite video, S-Video, and component video outputs pass through their respective input signals as they are.

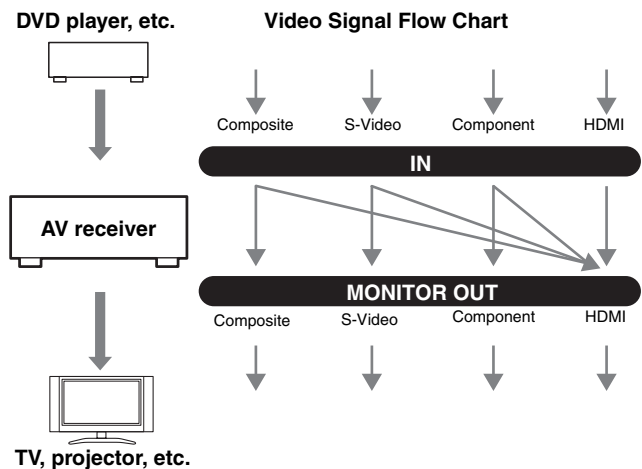

## Connecting the AV Receiver—Continued

### ■ “Monitor Out” Setting Set to “Analog”

With the “Monitor Out” setting set to “Analog” (see page 40), video input signals flow through the AV receiver as shown, with composite video and S-Video sources being upconverted for the component video output. **Use this setting if you connect the AV receiver’s COMPONENT VIDEO MONITOR OUT to your TV.**

Composite video is upconverted to S-Video and S-Video is downconverted to composite video. Note that these conversions only apply to the MONITOR OUT V and S outputs, not the VCR/DVR OUT V and S outputs.

The composite video, S-Video, and component video outputs pass through their respective input signals as they are.

This signal flow also applies when the “Output Resolution” setting is set to “Through” (see page 109).

### Video Signal Flow and the Resolution Setting

When the “Monitor Out” setting is set to “Analog” (see page 40), if the “Output Resolution” setting is set to anything other than “Through” (see page 109), the video signal flow will be as shown here, with composite video and S-Video sources being upconverted for the component video output.

The composite video, S-Video, and component video outputs pass through their respective analog input signals as they are. HDMI input signals are not output.

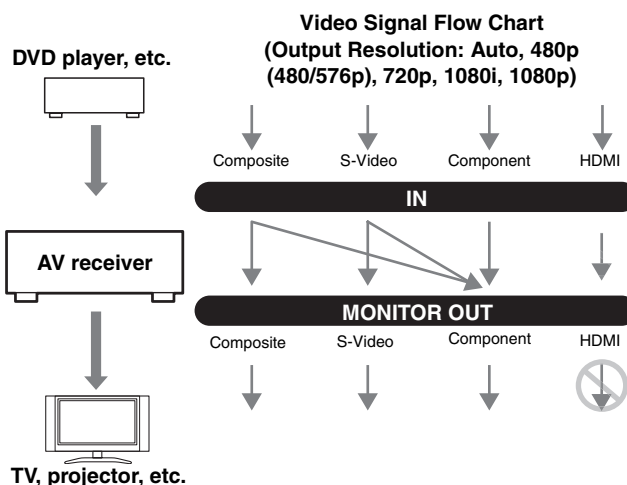
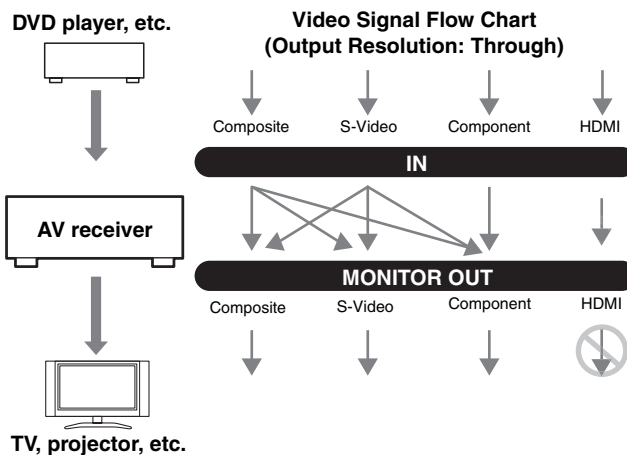

### Audio Connection Formats

Audio equipment can be connected to the AV receiver by using any of the following audio connection formats: analog, optical, coaxial, analog multichannel, or HDMI.

When choosing a connection format, bear in mind that the AV receiver does not convert digital input signals for analog line outputs and vice versa. For example, audio signals connected to an optical or coaxial digital input are not output by the analog TAPE OUT.

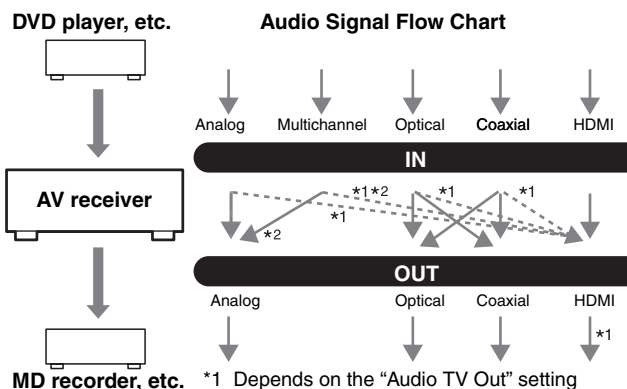

\*1 Depends on the “Audio TV Out” setting (see page 110).

\*2 Only the front L/R channels are output. (There will be no down mix.)

If signals are present at more than one input, the inputs will be selected automatically in the following order of priority: HDMI, digital, analog (including multichannel). You can specify which audio inputs the AV receiver checks for the presence of a signal in the “Automatic Audio Input Selection Setup” on page 113.

# Connecting the AV Receiver—Continued

## Connecting a TV or Projector

See “Connecting Components with HDMI” on page 32 for HDMI connection information.

**Step 1: Video Connection**  
Choose a video connection that matches your TV (**A**, **B**, or **C**), and then make the connection.

**Step 2: Audio Connection**  
Choose an audio connection that matches your TV (**a**, **b**, or **c**), and then make the connection.

- With connection **a**, you can listen to and record audio from your TV and listen in Zone 2.
- To enjoy Dolby Digital and DTS, use connection **b** or **c**. (To record or listen in Zone 2 as well, use **a** and **b**, or **a** and **c**.)

Connection	AV receiver	Signal flow	TV
<b>A</b>	COMPONENT VIDEO MONITOR OUT	⇒	Component video input
<b>B</b>	MONITOR OUT S	⇒	S-Video input
<b>C</b>	MONITOR OUT V	⇒	Composite video input
<b>a</b>	GAME/TV IN L/R	⇐	Analog audio L/R output
<b>b</b>	DIGITAL COAXIAL IN 2 (VCR/DVR)	⇐	Digital coaxial output
<b>c</b>	DIGITAL OPTICAL IN 1 (GAME/TV)	⇐	Digital optical output

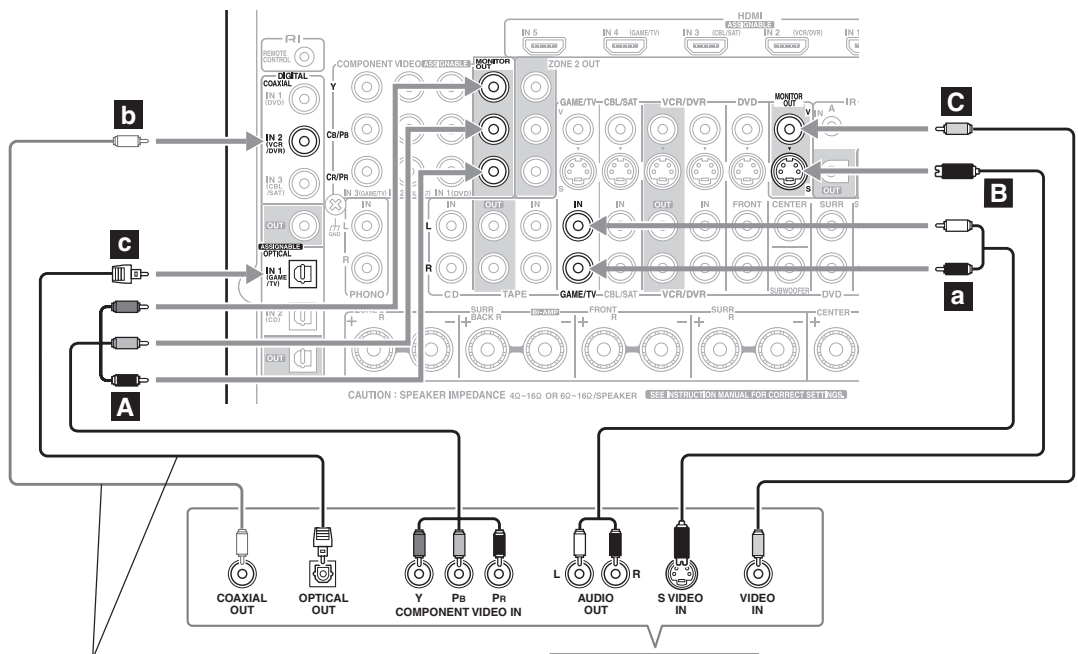

Connect one or the other  
Connection **b** must be assigned (see page 44)



If your TV has no audio outputs, connect an audio output from your VCR or cable or satellite receiver to the AV receiver and use its tuner to listen to TV programs through the AV receiver (see pages 27 and 29).



## Connecting the AV Receiver—Continued

### Connecting a DVD Player

See “Connecting Components with HDMI” on page 32 for HDMI connection information.

#### Step 1: Video Connection

Choose a video connection that matches your DVD player (**A**, **B**, or **C**), and then make the connection. If you use connection **A**, you must connect the AV receiver to your TV via the same type of connection.

#### Step 2: Audio Connection

Choose an audio connection that matches your DVD player (**a**, **b**, or **c**), and then make the connection.

- With connection **a**, you can listen to and record audio from a DVD and listen in Zone 2.
- To enjoy Dolby Digital and DTS, use connection **b** or **c**. (To record or listen in Zone 2 as well, use **a** and **b**, or **a** and **c**.)
- If your DVD player has main left and right outputs and multichannel left and right outputs, be sure to use the main left and right outputs for connection **a**.

Connection	AV receiver	Signal flow	DVD player
<b>A</b>	COMPONENT VIDEO IN 1 (DVD)	←	Component video output
<b>B</b>	DVD S	←	S-Video output
<b>C</b>	DVD V	←	Composite video output
<b>a</b>	DVD FRONT L/R	←	Analog audio L/R output
<b>b</b>	DIGITAL COAXIAL IN 1 (DVD)	←	Digital coaxial output
<b>c</b>	DIGITAL OPTICAL IN 1 (GAME/TV)	←	Digital optical output

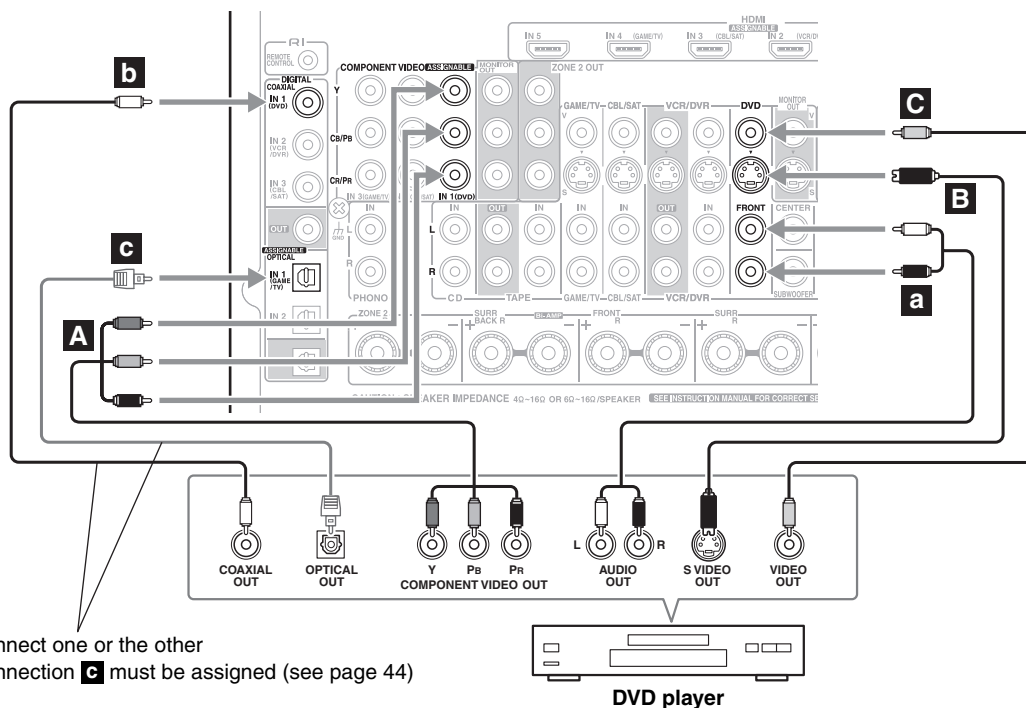

Connect one or the other  
Connection **C** must be assigned (see page 44)

To connect a DVD player or DVD-Audio/SACD-capable player with a multichannel analog audio output, see page 26.

## Connecting the AV Receiver—Continued

### Hooking Up the Multichannel DVD Input

If your DVD player supports multichannel audio formats such as DVD-Audio or SACD, and it has a multichannel analog audio output, you can connect it to the AV receiver's multichannel DVD input.

Use a multichannel analog audio cable, or several normal audio cables, to connect the AV receiver's DVD FRONT L/R, CENTER, SURR L/R, SURR BACK L/R, and SUBWOOFER jacks to the 7.1-channel analog audio output on your DVD player. If your DVD player has a 5.1-channel analog audio output, don't connect anything to the AV receiver's SURR BACK L/R jacks.

To select the multichannel input, see "Using the Multichannel DVD Input" on page 55. To adjust the subwoofer sensitivity for the multichannel input, see "Hardware Setup" on page 108.

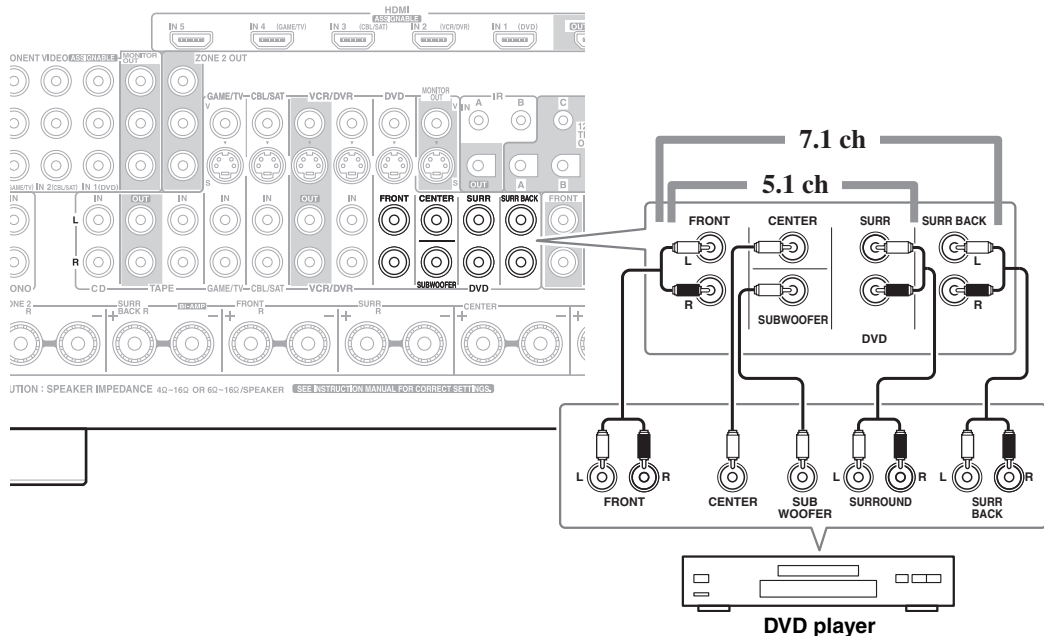

#### Note:

When a signal from multichannel DVD input is output from HDMI OUT or analog audio output, only the front L/R channels will be output. There will be no down mix.

## Connecting the AV Receiver—Continued

### Connecting a VCR or DVD Recorder for Playback



With this hookup, you can use your VCR's tuner to listen to your favorite TV programs via the AV receiver, useful if your TV has no audio outputs.

#### Step 1: Video Connection

Choose a video connection that matches your VCR or DVD recorder (**A**, **B**, or **C**), and then make the connection. If you use connection **A**, you must connect the AV receiver to your TV via the same type of connection.

#### Step 2: Audio Connection

Choose an audio connection that matches your VCR or DVD recorder (**a**, **b**, or **c**), and then make the connection.

- With connection **a**, you can listen to the VCR or DVD recorder even in Zone 2.
- To enjoy Dolby Digital and DTS, use connection **b** or **c**. (To listen in Zone 2 as well, use **a** and **b**, or **a** and **c**.)

Connection	AV receiver	Signal flow	VCR or DVD recorder
<b>A</b>	COMPONENT VIDEO IN 2 (CBL/SAT)	←	Component video output
<b>B</b>	VCR/DVR IN S	←	S-Video output
<b>C</b>	VCR/DVR IN V	←	Composite video output
<b>a</b>	VCR/DVR IN L/R	←	Analog audio L/R output
<b>b</b>	DIGITAL COAXIAL IN 2 (VCR/DVR)	←	Digital coaxial output
<b>c</b>	DIGITAL OPTICAL IN 1 (GAME/TV)	←	Digital optical output

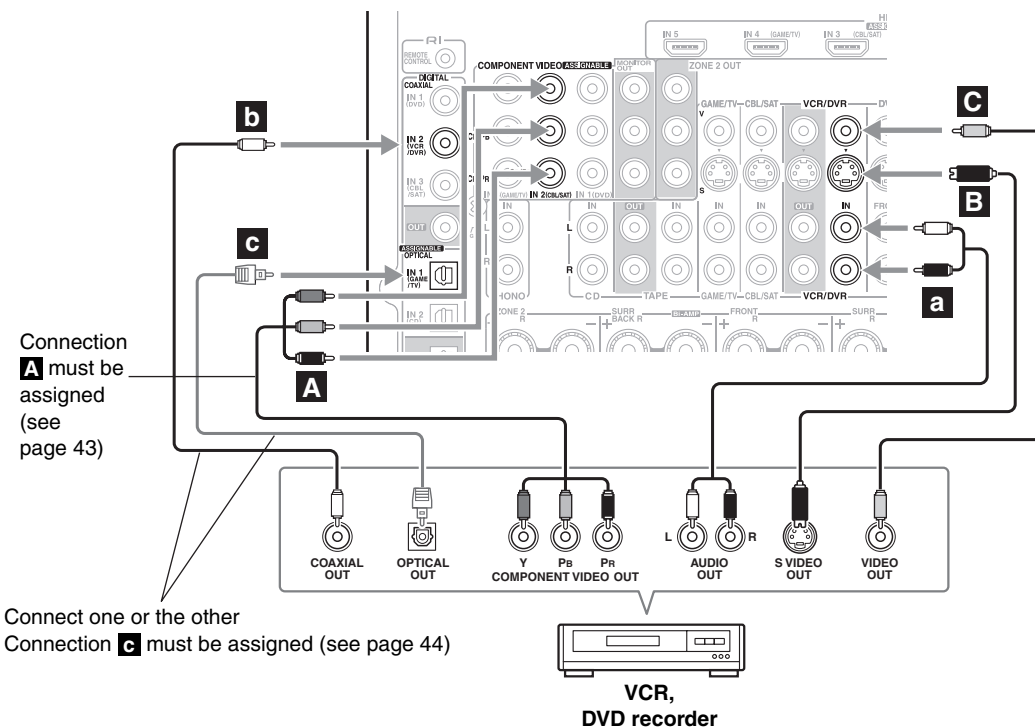

## Connecting the AV Receiver—Continued

### Connecting a VCR or DVD Recorder for Recording

#### Step 1: Video Connection

Choose a video connection that matches your VCR or DVD recorder (**A** or **B**), and then make the connection. The video source to be recorded must be connected to the AV receiver via the same type of connection.

#### Step 2: Audio Connection

Choose an audio connection that matches your VCR or DVD recorder (**a**, **b**, or **c**), and then make the connection.

Connection	AV receiver	Signal flow	VCR or DVD recorder
<b>A</b>	VCR/DVR OUT S	⇒	S-Video input
<b>B</b>	VCR/DVR OUT V	⇒	Composite video input
<b>a</b>	VCR/DVR OUT L/R	⇒	Analog audio L/R input
<b>b</b>	DIGITAL COAXIAL OUT	⇒	Digital coaxial input
<b>c</b>	DIGITAL OPTICAL OUT	⇒	Digital optical input

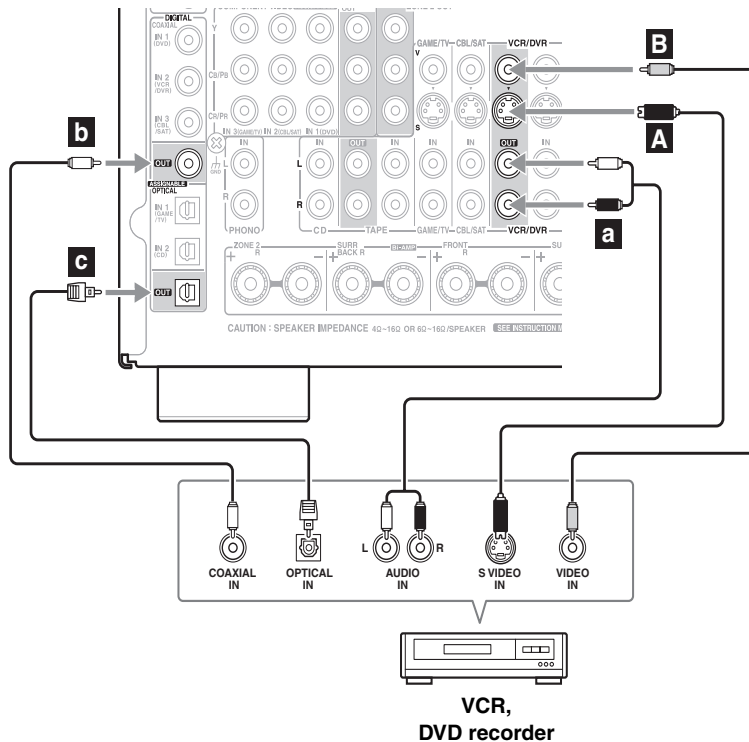

#### Notes:

- The AV receiver must be turned on for recording. Recording is not possible while it's in Standby mode.
- If you want to record directly from your TV or playback VCR to the recording VCR without going through the AV receiver, connect the TV/VCR's audio and video outputs directly to the recording VCR's audio and video inputs. See the manuals supplied with your TV and VCR for details.
- Video signals connected to composite video inputs can only be recorded via composite video outputs. If your TV/VCR is connected to a composite video input, the recording VCR must be connected to a composite video output. Similarly, video signals connected to S-Video inputs can only be recorded via S-Video outputs. If your TV/VCR is connected to an S-Video input, the recording VCR must be connected to an S-Video output.

## Connecting the AV Receiver—Continued

### Connecting a Satellite, Cable, Terrestrial Set-top box, or Other Video Source



With this hookup, you can use your satellite or cable receiver to listen to your favorite TV programs via the AV receiver, useful if your TV has no audio outputs.

#### Step 1: Video Connection

Choose a video connection that matches the video source (**A**, **B**, or **C**), and then make the connection. If you use connection **A**, you must connect the AV receiver to your TV via the same type of connection.

#### Step 2: Audio Connection

Choose an audio connection that matches the video source (**a**, **b**, or **c**), and then make the connection.

- With connection **a**, you can listen to and record audio from the video source and listen in Zone 2.
- To enjoy Dolby Digital and DTS, use connection **b** or **c**. (To listen in Zone 2 as well, use **a** and **b**, or **a** and **c**.)

Connection	AV receiver	Signal flow	Video source
<b>A</b>	COMPONENT VIDEO IN 2 (CBL/SAT)	←	Component video output
<b>B</b>	CBL/SAT IN S	←	S-Video output
<b>C</b>	CBL/SAT IN V	←	Composite video output
<b>a</b>	CBL/SAT IN L/R	←	Analog audio L/R output
<b>b</b>	DIGITAL COAXIAL IN 3 (CBL/SAT)	←	Digital coaxial output
<b>c</b>	DIGITAL OPTICAL IN 2 (CD)	←	Digital optical output

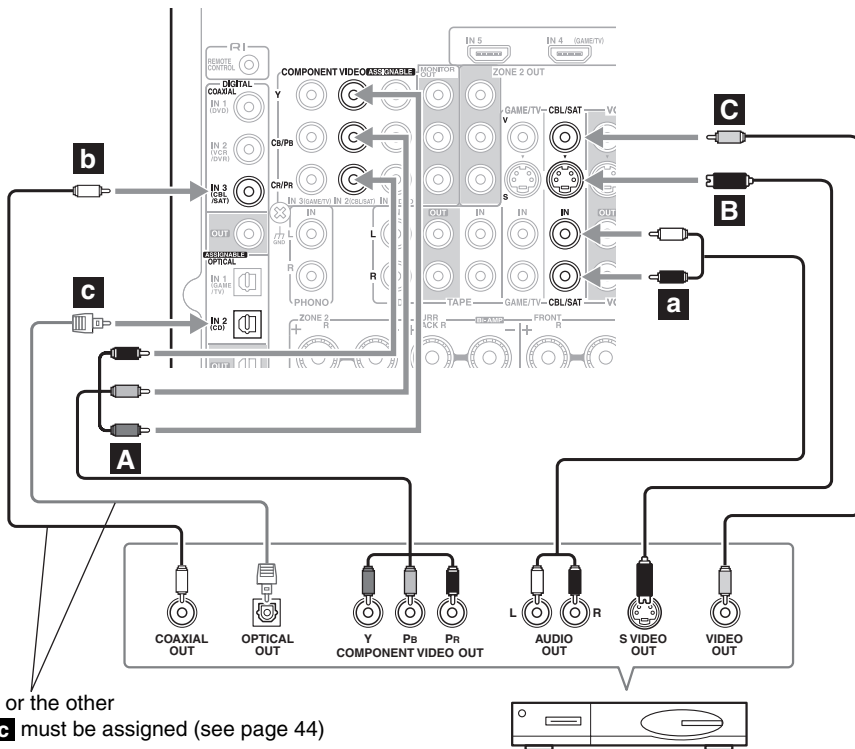

Connect one or the other  
Connection **C** must be assigned (see page 44)

Satellite, cable, set-top box, etc.

# Connecting the AV Receiver—Continued

## Connecting a Game Console

### Step 1: Video Connection

Choose a video connection that matches the game console (**A**, **B**, or **C**), and then make the connection. If you use connection **A**, you must connect the AV receiver to your TV with the same type of connection.

### Step 2: Audio Connection

Choose an audio connection that matches the game console (**a** or **b**), and then make the connection.

- With connection **a**, you can listen to and record audio from the game console or listen in Zone 2.
- To enjoy Dolby Digital and DTS, use connection **b**. (To record or listen in Zone 2 as well, use **a** and **b**.)

Connection	AV receiver	Signal flow	Game console
<b>A</b>	COMPONENT VIDEO IN 3 (GAME/TV)	←	Component video output
<b>B</b>	GAME/TV IN S	←	S-Video output
<b>C</b>	GAME/TV IN V	←	Composite video output
<b>a</b>	GAME/TV IN L/R	←	Analog audio L/R output
<b>b</b>	DIGITAL OPTICAL IN 1 (GAME/TV)	←	Digital optical output

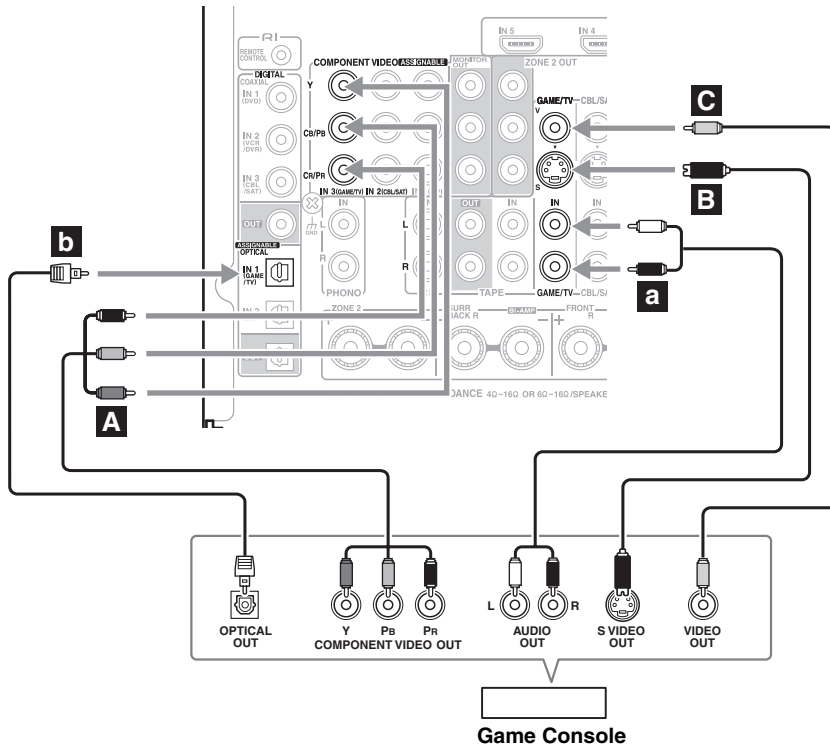

## Connecting the AV Receiver—Continued

### Connecting a Camcorder or Other Device

#### Step 1: Video Connection

Choose a video connection that matches the camcorder (**A** or **B**), and then make the connection.

#### Step 2: Audio Connection

Choose an audio connection that matches the camcorder (**a** or **b**), and then make the connection.

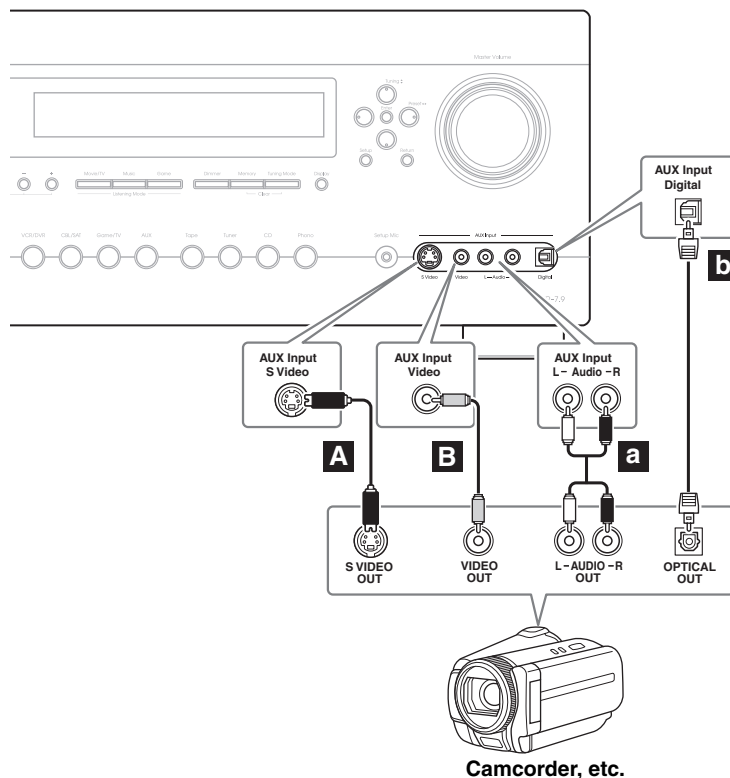

Connection	AV receiver	Signal flow	Camcorder etc.
<b>A</b>	AUX INPUT S VIDEO	←	S-Video output
<b>B</b>	AUX INPUT VIDEO	←	Composite video output
<b>a</b>	AUX INPUT L-AUDIO-R	←	Analog audio L/R output
<b>b</b>	AUX INPUT DIGITAL	←	Digital optical output

### Connecting Components with HDMI

#### About HDMI

Designed to meet the increased demands of digital TV, HDMI (High Definition Multimedia Interface) is a new digital interface standard for connecting TVs, projectors, DVD players, set-top boxes, and other video components. Until now, several separate video and audio cables have been required to connect AV components. With HDMI, a single cable can carry control signals, digital video, and up to eight channels of digital audio (2-channel PCM, multichannel digital audio, and multichannel PCM).

The HDMI video stream (i.e., video signal) is compatible with DVI (Digital Visual Interface)<sup>\*1</sup>, so TVs and displays with a DVI input can be connected by using an HDMI-to-DVI adapter cable. (This may not work with some TVs and displays, resulting in no picture.)

The AV receiver uses HDCP (High-bandwidth Digital Content Protection)<sup>\*2</sup>, so only HDCP-compatible components can display the picture.

The AV receiver's HDMI interface is based on the following standard:

Repeater System, Deep Color, Lip Sync, DTS-HD Master Audio, DTS-HD High Resolution Audio, Dolby TrueHD, Dolby Digital Plus, SA-CD, and Multichannel PCM

#### Supported Audio Formats

- 2-channel linear PCM (32–192 kHz, 16/20/24 bit)
- Multichannel linear PCM (up to 7.1 ch, 32–192 kHz, 16/20/24 bit)
- Bitstream (DSD, Dolby Digital, Dolby Digital Plus, Dolby TrueHD, DTS, DTS-HD High Resolution Audio, DTS-HD Master Audio)

Your DVD player must also support HDMI output of the above audio formats.

#### About Copyright Protection

The AV receiver supports HDCP (High-bandwidth Digital Content Protection)<sup>\*2</sup>, a copy-protection system for digital video signals. Other devices connected to the AV receiver via HDMI must also support HDCP.

Commercially available HDMI cables (supplied with some components) should be used to connect the AV receiver's HDMI OUT to the HDMI input on your TV or projector.

\*1 DVI (Digital Visual Interface): The digital display interface standard set by the DDWG<sup>\*3</sup> in 1999.

\*2 HDCP (High-bandwidth Digital Content Protection): The video encryption technology developed by Intel for HDMI/DVI. It's designed to protect video content and requires a HDCP-compatible device to display the encrypted video.

\*3 DDWG (Digital Display Working Group): Lead by Intel, Compaq, Fujitsu, Hewlett Packard, IBM, NEC, and Silicon Image, this open industry group's objective is to address the industry's requirements for a digital connectivity specification for high-performance PCs and digital displays.



## Connecting the AV Receiver—Continued

### Making HDMI Connections

#### Step 1:

Use HDMI cables to connect the AV receiver's HDMI jacks to your HDMI-compatible Blu-ray player/DVD player, TV, projector, and so on.

#### Step 2:

Assign each HDMI IN to an input selector in the HDMI Input Setup (see page 42).

#### ■ Video Signals

Digital video signals received by the HDMI IN jacks are normally output by the HDMI OUT for display on your TV. Composite video, S-Video, and component video sources can be upconverted for the HDMI output. See "Video Connection Formats" on page 22 for more information.

#### ■ Audio Signals

Digital audio signals received by the HDMI IN jacks are output by the speakers and headphones connected to the AV receiver. Normally, they are not output by the HDMI OUT, unless the "Audio TV Out" setting is set to "On" (see page 110).



To listen to audio received by the HDMI IN jacks through your TV's speakers, set the "Audio TV Out" setting to "On" (see page 110), and set your DVD player's HDMI audio output setting to PCM.

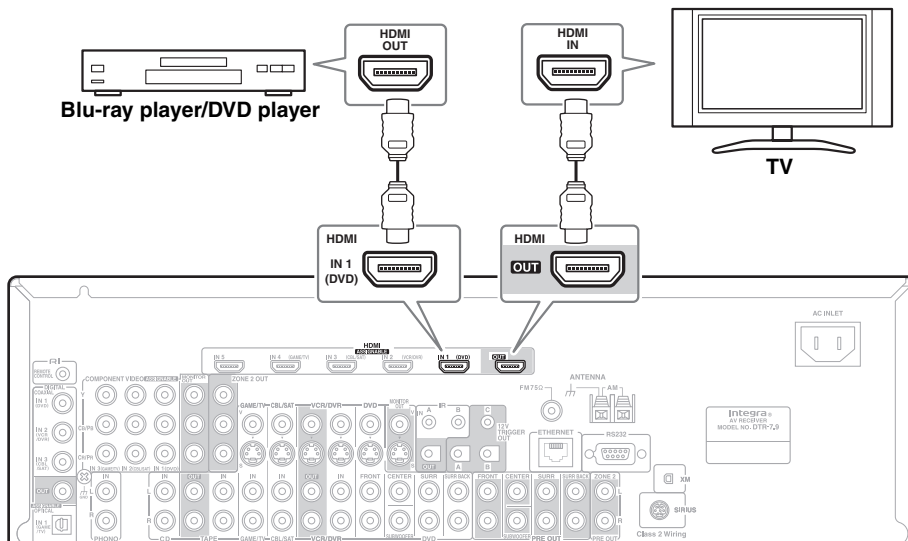

#### Notes:

- The HDMI video stream is compatible with DVI (Digital Visual Interface), so TVs and displays with a DVI input can be connected by using an HDMI-to-DVI adapter cable. (Note that DVI connections only carry video, so you'll need to make a separate connection for audio.) However, reliable operation with such an adapter is not guaranteed. In addition, video signals from a PC are not supported.
- When listening to an HDMI component through the AV receiver, set the HDMI component so that its video can be seen on the TV screen (on the TV, select the input of the HDMI component connected to the AV receiver). If the TV power is off or the TV is set to another input source, this may result in no sound from the AV receiver or the sound may be cut off.
- When the "Audio TV Out" setting is set to "On" (see page 110), or "TV Control" is set to "Enable" (see page 111) and you're listening through your TV's speakers, if you turn up the AV receiver volume control, the sound will be output by the AV receiver's speakers. To stop the AV receiver's speakers producing sound, change the settings, change your TV's settings, or turn down the AV receiver's volume.
- The HDMI audio signal (sampling rate, bit length, etc.) may be restricted by the connected source component. If the picture is poor or there's no sound from a component connected via HDMI, check its setup. Refer to the connected component's instruction manual for details.

## Connecting a CD Player or Turntable

### ■ CD Player or Turntable (MM) with Built-in Phono Preamp

#### Step 1:

Choose a connection that matches your CD player (**a**, **b**, or **c**). Use connection **a** for a turntable with a built-in phono preamp.

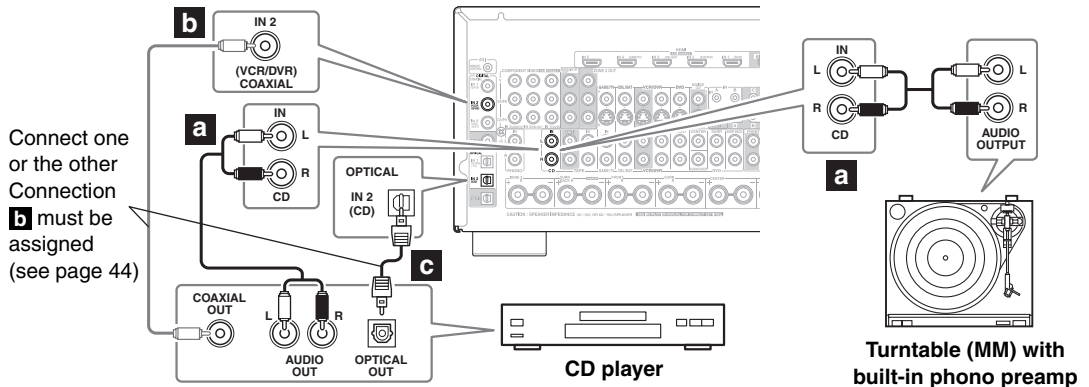

- With connection **a**, you can listen to and record audio from the CD player and listen in Zone 2.
- To connect the CD player digitally, use connection **b** or **c**. (To record or listen in Zone 2 as well, use **a** and **b**, or **a** and **c**.)

Connection	AV receiver	Signal flow	CD or turntable
<b>a</b>	CD IN L/R	←	Analog audio L/R output
<b>b</b>	DIGITAL COAXIAL IN 2 (VCR/DVR)	←	Digital coaxial output
<b>c</b>	DIGITAL OPTICAL IN 2 (CD)	←	Digital optical output

### ■ Turntable (MM) with no Phono Preamp Built-in

The AV receiver's PHONO IN is designed for use with a moving magnet (MM) type cartridge.

Use an analog audio cable to connect the AV receiver's PHONO IN L/R jacks to the audio output on your turntable.

#### Notes:

- If your turntable has a ground wire, connect it to the AV receiver's GND screw. With some turntables, connecting the ground wire may produce an audible hum. If this happens, disconnect it.
- If your turntable has a moving coil (MC) type cartridge, you'll need a commercially available MC head amp or MC transformer. Connect your turntable to the head amp or transformer, and connect that to the AV receiver's PHONO IN L/R jacks.
- You can also use a phono equalizer to connect a turntable with an MC-type cartridge. See your phono equalizer's manual for details.

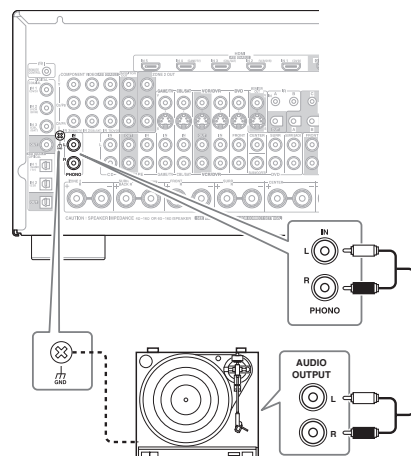

## Connecting the AV Receiver—Continued

### Connecting a Cassette, CDR, MiniDisc, or DAT Recorder

#### Step 1:

Choose a connection that matches the recorder (**a**, **b**, **c**, **d**, **e**), and then make the connection.

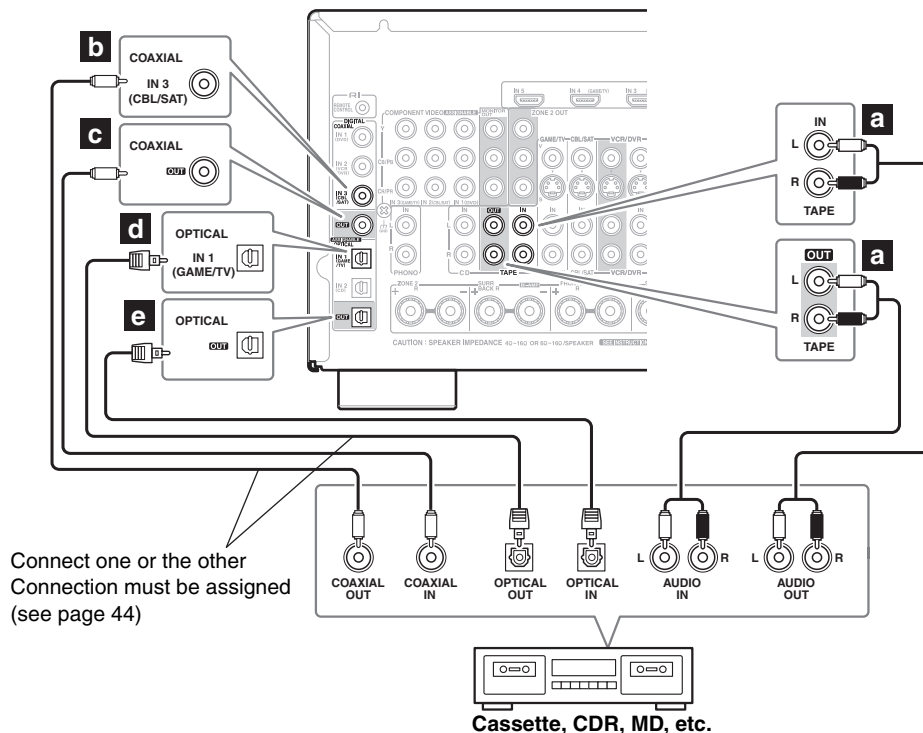

- With connection **a**, you can play and record and listen in Zone 2.
- To connect the recorder digitally for playback, use connections **a** and **b**, or **a** and **d**.
- To connect the recorder digitally for recording, use connections **c** or **d**.

Connection	AV receiver	Signal flow	Cassette, CDR, MD, or DAT recorder
<b>a</b>	TAPE IN L/R TAPE OUT L/R	← →	Analog audio L/R output Analog audio L/R input
<b>b</b>	DIGITAL COAXIAL IN 3 (CBL/SAT)	←	Digital coaxial output
<b>c</b>	DIGITAL COAXIAL OUT	→	Digital coaxial input
<b>d</b>	DIGITAL OPTICAL IN 1 (GAME/TV)	←	Digital optical output
<b>e</b>	DIGITAL OPTICAL OUT	→	Digital optical input

### Connecting a Power Amplifier

If you want to use a more powerful power amplifier and use the AV receiver as a preamp, connect it to the PRE OUT jacks, and connect all speakers and the subwoofer to the power amplifier. If you have a powered subwoofer, connect it to this AV receiver's PRE OUT: SUBWOOFER jack.

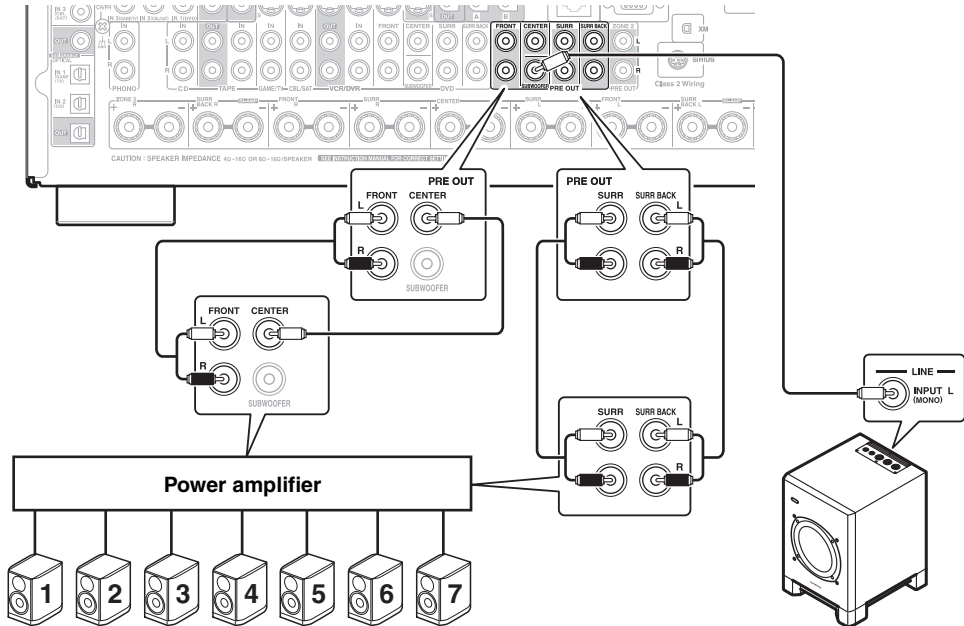

1. Front left speaker
2. Center speaker
3. Front right speaker
4. Surround left speaker
5. Surround right speaker
6. Surround back left speaker
7. Surround back right speaker

See "Connecting a Powered Subwoofer" on page 16 for more information.

### Connecting an RI Dock

Not all iPod models output video. For information about which iPod models are supported by the RI Dock, see the RI Dock's instruction manual.

#### ■ If Your iPod Supports Video:

Connect your RI Dock's analog audio output jacks to the AV receiver's GAME/TV IN L/R jacks, and connect its video output jack to the AV receiver GAME/TV IN V jack. (Onkyo DS-A2 hookup shown below.)

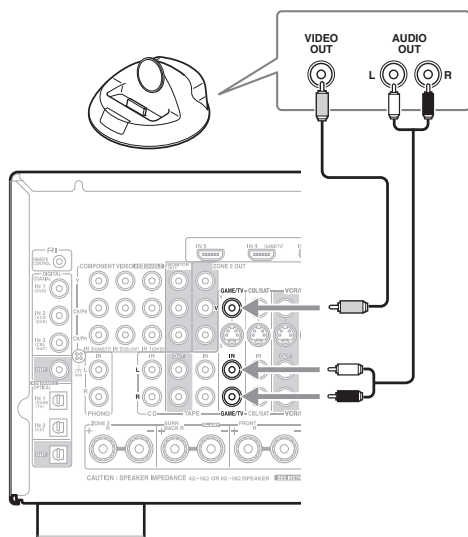

#### ■ If Your iPod Doesn't Support Video:

Connect your RI Dock's analog audio output jacks to the AV receiver's TAPE IN L/R jacks. (Onkyo DS-A2 hookup shown below.)

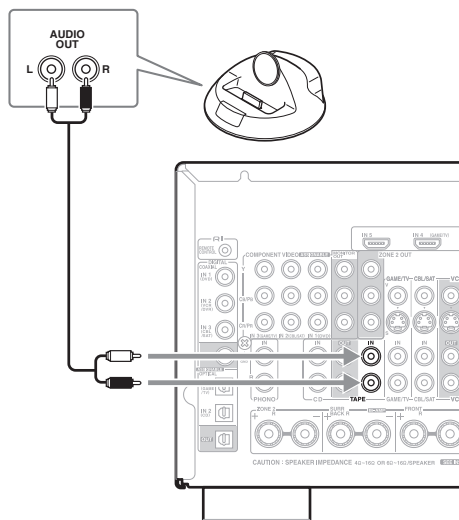

#### ■ If you have an Onkyo DS-A1 RI Dock

- Connect its video output jack to the AV receiver's GAME/TV IN S jack.

#### Notes:

- Connect the RI Dock to the AV receiver with an **RI** cable (see page 38).
- Set the RI Dock's RI MODE switch to "HDD" or "HDD/DOCK".
- Set the AV receiver's Input Display to "DOCK" (see page 48).
- By using the [Custom] button on the remote controller of the AV receiver to change the remote mode to "DOCK", you can operate your iPod in the RI Dock (see page 129).  
If you cannot operate it, you will need to enter the appropriate remote control code (see page 122).
- See the RI Dock's instruction manual for more information.

### Connecting Integra/Onkyo **RI** Components

#### Step 1:

Make sure that each Integra/Onkyo component is connected to the AV receiver with an analog audio cable (connection **a** in the hookup examples) (see pages 24 to 35).

#### Step 2:

Make the **RI** connection (see illustration below).

#### Step 3:

If you're using an MD, CDR, or RI Dock, change the Input Display (see page 48).

With **RI** (Remote Interactive), you can use the following special functions:

#### ■ Auto Power On/Standby

When you start playback on a component connected via **RI**, if the AV receiver is on Standby, it will automatically turn on and select that component as the input source. Similarly, when the AV receiver is set to Standby, all components connected via **RI** will also go on Standby.

#### ■ Direct Change

When playback is started on a component connected via **RI**, the AV receiver automatically selects that component as the input source. If your DVD player is connected to the AV receiver's DVD multichannel input, you'll need to press the [Multi CH] button repeatedly and select "Multich" to hear all channels (see page 55), as the Direct Change **RI** function selects the DVD FRONT L/R channels.

#### ■ Remote Control

You can use the AV receiver's remote controller to control your other **RI**-capable Integra/Onkyo components, pointing the remote controller at the AV receiver's remote control sensor instead of the component. You must enter the appropriate remote control code first (see page 123).

#### Notes:

- Use only **RI** cables for **RI** connections. **RI** cables are supplied with Integra/Onkyo players (DVD, CD, etc.).
- Some components have two **RI** jacks. You can connect either one to the AV receiver. The other jack is for connecting additional **RI**-capable components.
- Connect only Integra/Onkyo components to **RI** jacks. Connecting other manufacturer's components may cause a malfunction.
- Some components may not support all **RI** functions. Refer to the manuals supplied with your other Integra/Onkyo components.
- While Zone 2 is on, the Auto Power On/Standby and Direct Change **RI** functions do not work.

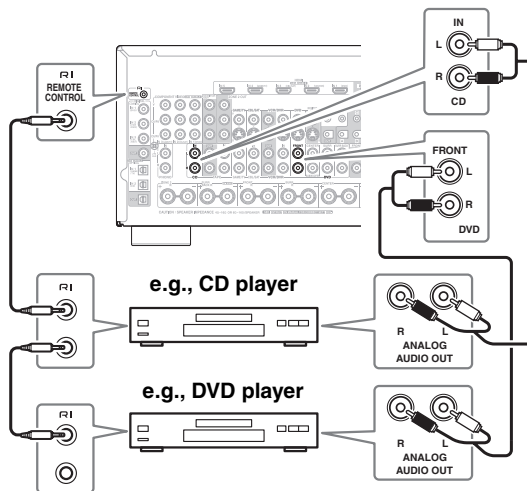

### Connecting the Power Cord

#### Notes:

- **Before connecting the power cord, connect all of your speakers and AV components.**
- Turning on the AV receiver may cause a momentary power surge that might interfere with other electrical equipment on the same circuit. If this is a problem, plug the AV receiver into a different branch circuit.
- Do not use a power cord other than the one supplied with the AV receiver. The supplied power cord is designed exclusively for use with the AV receiver and should not be used with any other equipment.
- Never disconnect the power cord from the AV receiver while the other end is still plugged into a wall outlet. Doing so may cause an electric shock. Always disconnect the power cord from the wall outlet first, and then the AV receiver.

#### Step 1:

Connect the supplied power cord to the AV receiver's AC INLET.

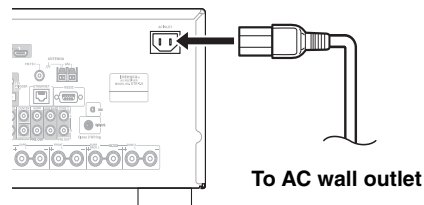

#### Step 2:

Plug the power cord into an AC wall outlet.

# Turning On the AV Receiver

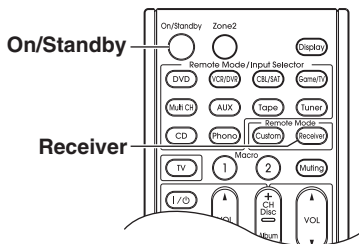
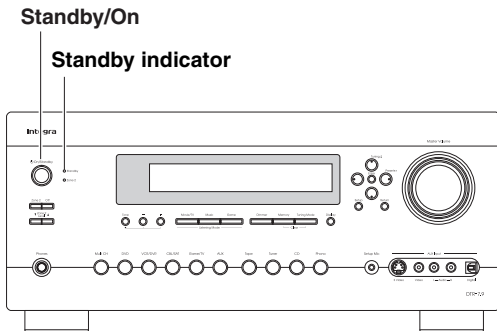

## Turning On and Standby

### AV receiver

On/Standby



or

### Remote controller

Receiver



On/Standby



**Press the [On/Standby] button.**

**Alternatively, press the remote controller's [Receiver] button, followed by the [On/Standby] button.**

The AV receiver comes on, the display lights up, and the Standby indicator goes off.

To turn the AV receiver off, press the [On/Standby] button, or press the remote controller's [On/Standby] button. The AV receiver will enter Standby mode. To prevent any loud surprises when you turn on the AV receiver, always turn down the volume before you turn it off.

## Smooth Operation in a Few Easy Steps

To ensure smooth operation, here's a few easy steps to help you configure the AV receiver before you use it for the very first time. These settings only need to be made once.

### ■ Do the automatic speaker setup—this is essential!

See "Automatic Speaker Setup (Audyssey MultEQ®)" on page 49.



### ■ Did you connect your TV to the HDMI OUT or COMPONENT VIDEO MONITOR OUT?

If you did, see "Monitor Setup" on page 40.



### ■ Have you connected a component to an HDMI input, component video input, or digital audio input?

If you have, see "HDMI Input Setup" on page 42, "Component Video Setup" on page 43, or "Digital Input Setup" on page 44 respectively.

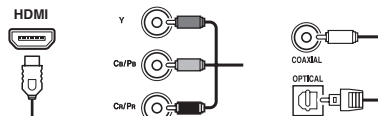

### ■ Have you connected an Onkyo MD recorder, CD recorder, or RI Dock?

If you have, see "Changing the Input Display" on page 48.

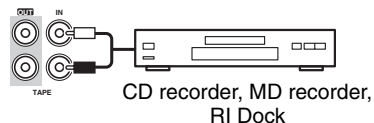

# First Time Setup

This section explains the settings that you need to make before using the AV receiver for the very first time.

## Monitor Setup

On the “Monitor Out” settings, you can select whether or not to have the video sources’ images output through the HDMI OUT, as well as whether to have the onscreen setup menu output through the HDMI OUT or through an analog output.

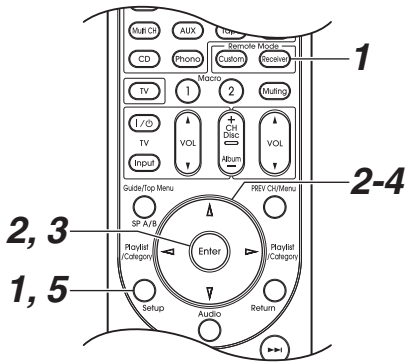

If you connect your TV to the COMPONENT VIDEO MONITOR OUT or COMPONENT VIDEO ZONE 2 OUT, set the “Monitor Out” setting to “Analog” so that the onscreen setup menus are displayed and composite video and S-Video sources are upconverted\* and output by the COMPONENT VIDEO MONITOR OUT and COMPONENT VIDEO ZONE 2 OUT.

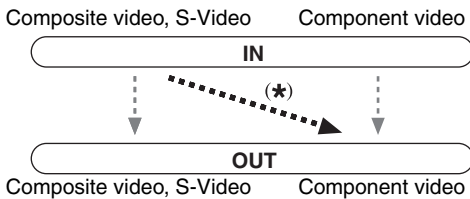

If you connect your TV to the HDMI OUT, set the “Monitor Out” setting to “HDMI” so that the onscreen setup menus are displayed and composite video, S-Video, and component video sources are upconverted\* and output by the HDMI OUT. The onscreen setup menus are displayed on the HDMI OUT only.

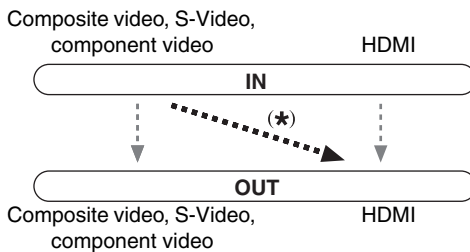

You can specify the output resolution for the HDMI OUT and COMPONENT VIDEO MONITOR OUT and have the AV receiver upconvert the picture resolution as necessary to match the resolution supported by your TV (see page 109). See page 22 for charts showing how the Monitor Out and Resolution settings affect the video signal flow through the AV receiver.

<p><b>1</b></p> <p>↓</p>	<p><b>Press the [Receiver] button followed by the [Setup] button.</b> The submenu item appears on the display.</p> <p><i>1. Input Assign</i></p>
<p><b>2</b></p> <p>↓</p>	<p><b>Use the Up and Down [▲]/[▼] buttons to select “7. Hardware Setup”, and then press [Enter].</b></p>
<p><b>3</b></p> <p>↓</p>	<p><b>Use the Up and Down [▲]/[▼] buttons to select “5. HDMI”, and then press [Enter].</b></p>
<p><b>4</b></p> <p>↓</p> <p>↓</p>	<p><b>Use the Up and Down [▲]/[▼] buttons to select “Monitor Out”, and then use the Left and Right [◀]/[▶] buttons to select:</b></p> <p><b>Analog:</b> Select this if your TV is connected to the COMPONENT VIDEO MONITOR OUT, COMPONENT VIDEO ZONE 2 OUT, S MONITOR OUT, or V MONITOR OUT.</p> <p><b>HDMI:</b> Select this if your TV is connected to the HDMI OUT.</p> <p><b>Note:</b> When “HDMI” is selected, the onscreen setup menus are output by only the HDMI OUT.</p>
<p><b>5</b></p>	<p><b>Press the [Setup] button.</b></p>

**Note:** This procedure can also be performed on the AV receiver by using its [Setup] button, arrow buttons, and [Enter] button.



## ■ Menus for First Time Setup

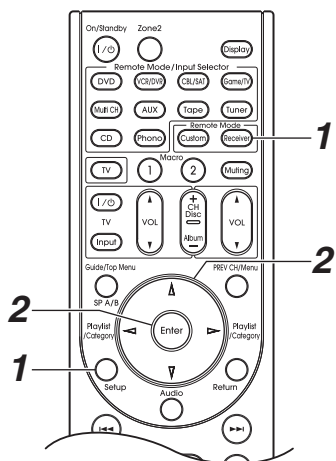

### Using the Onscreen Setup Menus

Carry out the settings for the AV receiver by using the Onscreen Setup Menu.

**1**

**Press the [Receiver] button followed by the [Setup] button.**

The main menu appears onscreen.

If the main menu doesn't appear, make sure the appropriate external input is selected on your TV.

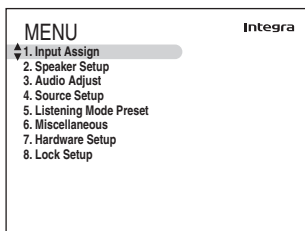

**2**

**Use the Up and Down [▲]/[▼] buttons to select submenu and then press [Enter].**

The submenu appears.

Press the [Setup] button to close the menu.

Press the [Return] button to return to the previous menu.

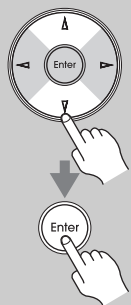

### Submenus

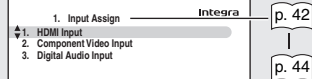

p. 42

p. 44

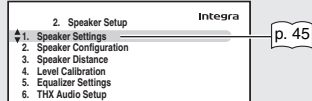

p. 45

### Main menu

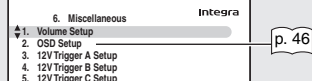
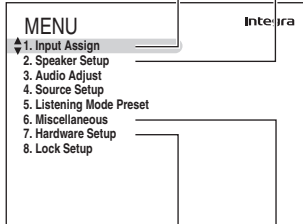

p. 46

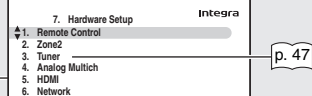

p. 47

**Video Input Setup**

**HDMI Input Setup**

If you connect a video component to HDMI IN, you must assign that input to an input selector. For example, if you connect your DVD player to HDMI IN 1, you must assign HDMI IN 1 to the DVD input selector.

If you've connected your TV to the AV receiver with an HDMI cable, you can set the AV receiver so that composite video, S-Video, and component video sources are upconverted\* and output by the HDMI OUT. You can set this for each input selector by selecting the "-----" option.

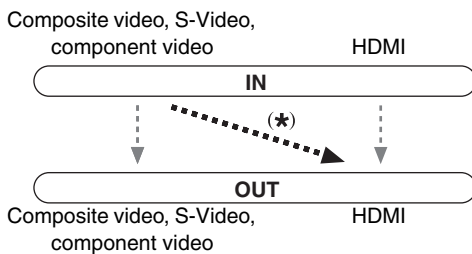

**1** Press the [Receiver] button followed by the [Setup] button. The main menu appears onscreen. If the main menu doesn't appear, make sure the appropriate external input is selected on your TV.

**2** Use the Up and Down [▲]/[▼] buttons to select "1. Input Assign", and then press [Enter]. The "Input Assign" menu appears.

Integra	
1. Input Assign	
▲ 1. HDMI Input	-----▶
2. Component Video Input	-----▶
3. Digital Audio Input	-----▶

**3** Use the Up and Down [▲]/[▼] buttons to select "1. HDMI Input", and then press [Enter]. The "HDMI Input" menu appears.

Integra	
1-1. HDMI Input	
▶ DVD	HDMI1 ◀
VCR/DVR	HDMI2
CBL/SAT	HDMI3
GAME/TV	HDMI4
AUX	-----▶
TAPE	-----▶
TUNER	-----▶
CD	-----▶
PHONO	-----▶

**4** Use the Up and Down [▲]/[▼] buttons to select an input selector, and use the Left and Right [◀]/[▶] buttons to select: **HDMI1, HDMI2, HDMI3, HDMI4, HDMI5:**

Select the HDMI IN to which the video component has been connected.

-----: Output composite video, S-Video, and component video sources from the HDMI OUT. The video output signal from the HDMI OUT is the one configured in "Component Video Setup" (see page 43).

Each HDMI IN cannot be assigned to more than one input selector. When HDMI1 - HDMI5 have already been assigned, you must set first any unused input selectors to "-----" or you will be unable to assign HDMI1 - HDMI5 to input selector.

**5** Press the [Setup] button. The setup menu closes.

- Notes:**
- For composite video, S-Video, and component video upconversion for the HDMI OUT, the "Monitor Out" setting must be set to "HDMI" (see page 40), and the HDMI Input setting must be set to "-----". See page 22 for more information on video signal flow and upconversion.
  - When an HDMI IN is assigned to an input selector as explained here, the digital audio input for that input selector is automatically set to the same HDMI IN. See "Digital Input Setup" on page 44.
  - The TUNER input selector cannot be assigned and is fixed at the "-----" option.
  - This procedure can also be performed on the AV receiver by using its [Setup] button, arrow buttons, and [Enter] button.

## Component Video Setup

If you connect to a COMPONENT VIDEO IN, you must assign it to an input selector. For example, if you connect your DVD player to COMPONENT VIDEO IN 2, you should assign it to the DVD input selector.

If you want to output composite and S-Video sources from the COMPONENT VIDEO MONITOR OUT, select “-----”, as explained below.

Input selector	Default assignment
DVD	IN1
VCR/DVR	-----
CBL/SAT	IN2
GAME/TV	IN3
AUX	-----
TAPE	-----
TUNER	----- (Fixed)
CD	-----
PHONO	-----

If you’ve connected your TV to the AV receiver with a component video cable, you can set the AV receiver so that composite video and S-Video sources are upconverted\* and output by the COMPONENT VIDEO MONITOR OUT.

You can set this for each input selector by selecting the “-----” option.

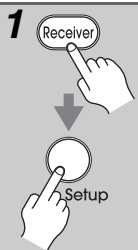
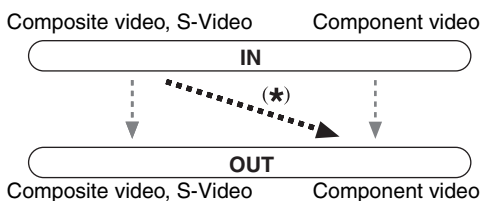

**1 Press the [Receiver] button followed by the [Setup] button.**

The main menu appears onscreen. If the main menu doesn’t appear, make sure the appropriate external input is selected on your TV.

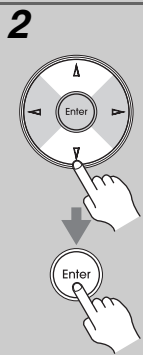

**2 Use the Up and Down [▲]/[▼] buttons to select “1. Input Assign”, and then press [Enter].**

The “Input Assign” menu appears.

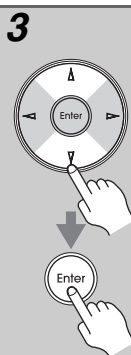
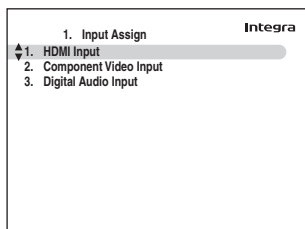

**3 Use the Up and Down [▲]/[▼] buttons to select “2. Component Video Input”, and then press [Enter].**

The “Component Video Input” menu appears.

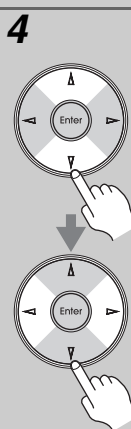
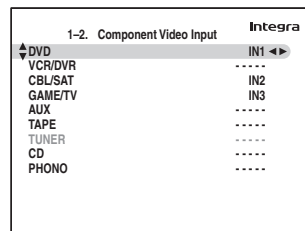

**4 Use the Up and Down [▲]/[▼] buttons to select an input selector, and then use the Left and Right [◀]/[▶] buttons to select:**

- IN1:** Select if the video component is connected to COMPONENT VIDEO IN 1.
- IN2:** Select if the video component is connected to COMPONENT VIDEO IN 2.
- IN3:** Select if the video component is connected to COMPONENT VIDEO IN 3.
- :** Output composite video and S-Video sources from the COMPONENT VIDEO MONITOR OUT.



**5 Press the [Setup] button.**

The setup menu closes.

### Notes:

- For composite video and S-Video upconversion for the COMPONENT VIDEO MONITOR OUT, the “Monitor Out” setting must be set to “Analog” (see page 40), and the “Component Video Input” setting must be set to “-----”. See page 23 for more information on video signal flow and upconversion.
- This procedure can also be performed on the AV receiver by using its [Setup] button, arrow buttons, and [Enter] button.

**Digital Input Setup**

If you connect a component to a digital input jack, you must assign that jack to an input selector. For example, if you connect your CD player to the OPTICAL IN1 jack, you should assign that jack to the CD input selector. By default, the COAXIAL IN1 jack is assigned to the DVD input selector, although this can be changed. Here are the default assignments.

Input selector	Default assignment
DVD	COAX1
VCR/DVR	COAX2
CBL/SAT	COAX3
Game/TV	OPT1
AUX	FRONT
Tape	-----
TUNER	----- (Fixed)
CD	OPT2
PHONO	-----

**1**

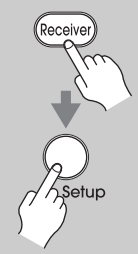

**Press the [Receiver] button followed by the [Setup] button.**  
The main menu appears onscreen. If the main menu doesn't appear, make sure the appropriate external input is selected on your TV.

**2**

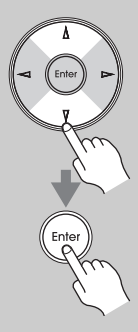

**Use the Up and Down [▲]/[▼] buttons to select "1. Input Assign", and then press [Enter].**  
The "Input Assign" menu appears.

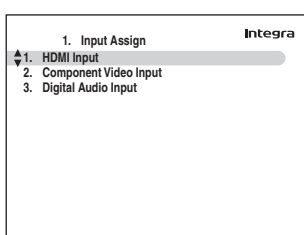

**3**

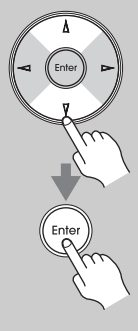

**Use the Up and Down [▲]/[▼] buttons to select "3. Digital Audio Input", and then press [Enter].**  
The "Digital Audio Input" menu appears.

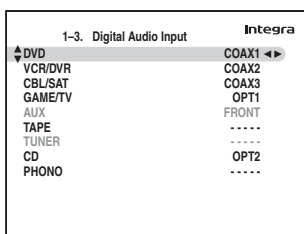

**4**

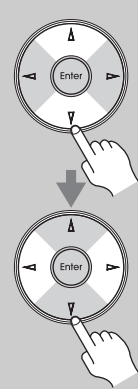

**Use the Up and Down [▲]/[▼] buttons to select an input selector, and use the Left and Right [◀]/[▶] buttons to select "COAX1", "COAX2", "COAX3", "OPT1", "OPT2", or "----- (analog)".**

- When an HDMI IN is assigned to an input selector in "HDMI Input Setup" on page 42, this input assignment is automatically set to the same HDMI IN. And in addition to the usual inputs (e.g., COAX1, COAX2, etc.), you can also select HDMI inputs. If you change the input assignment from an HDMI IN to one of the other inputs (e.g., COAX1 or COAX2), be sure to set the "Automatic Audio Input Selection Setup" on page 113 to the same input (e.g., COAX1 (Auto) or COAX2 (Auto)).
- "AUX" is used only for digital input from the front panel terminals. When HDMI IN is assigned to "AUX" in the "HDMI Input Setup" on page 42, the same HDMI IN can be selected.

**Examples:**

If you connect your DVD player to the OPTICAL IN 1 jack, set "DVD" to "OPT1".

If you want to listen to audio from the component connected to the OPTICAL IN 2 jack when the VCR/DVR input selector is selected, set "VCR/DVR" to "OPT2".

If you want to listen to audio from the component connected to the COAXIAL IN 1 jack when the CBL/SAT input selector is selected, set "CBL/SAT" to "COAX1".

For input selectors that you don't want to assign a digital input jack, set to "----- (analog)".

**5**



**Press the [Setup] button.**  
The setup menu closes.

**Note:**  
This procedure can also be performed on the AV receiver by using its [Setup] button, arrow buttons, and [Enter] button.

## Speaker Settings

If you change these settings, you must run the automatic speaker setup again (see page 49).

If the impedance of any speaker is 4 ohms or more but less than 6, set the minimum speaker impedance to 4 ohms.

If you've connected your front speakers to the FRONT L/R and SURR BACK L/R terminal posts for bi-amping, you must change the "Speakers Type" setting. For hookup information, see "Bi-amping the Front Speakers" on page 18.

### Notes:

- When bi-amping is used, the AV receiver is able to drive up to 5.1 speakers in the main room.
- Before you change these settings, turn down the volume.

**1**



**Press the [Receiver] button, followed by the [Setup] button.**  
The main menu appears onscreen. If the main menu doesn't appear, make sure the appropriate external input is selected on your TV.

**2**



**Use the Up and Down [▲]/[▼] buttons to select "2. Speaker Setup", and then press [Enter].**  
The "Speaker Setup" menu appears.

Integra

2. Speaker Setup

- 1. Speaker Settings
- 2. Speaker Configuration
- 3. Speaker Distance
- 4. Level Calibration
- 5. Equalizer Settings
- 6. THX Audio Setup

**3**

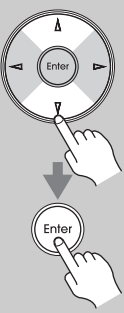

**Use the Up and Down [▲]/[▼] buttons to select "1. Speaker Settings", and then press [Enter].**  
The "Speaker Settings" menu appears.

Integra

2-1. Speaker Settings

- Speakers Type Normal ◀▶
- Speaker Impedance 6ohms

**4**



**Use the Up and Down [▲]/[▼] buttons to select "Speakers Type", and then use the Left and Right [◀]/[▶] buttons to select:**  
**Normal:** Select this if you've connected your front speakers normally.  
**Bi-Amp:** Select this if you've connected your front speakers for bi-amped operation.

**Notes:**

- Powered Zone2 cannot be used if "Speakers Type" is set to "Bi-Amp".
- The analog multichannel input cannot be used if "Speakers Type" is set to "Bi-Amp".

**5**



**Use the Up and Down [▲]/[▼] buttons to select "Speaker Impedance", and then use the Left and Right [◀]/[▶] buttons to select:**  
**4ohms:** Select if the impedance of any speaker is 4 ohms or more but less than 6.  
**6ohms:** Select if the impedances of all speakers are between 6 and 16 ohms.

**6**



**Press the [Setup] button.**  
The setup menu closes.

**Note:**  
This procedure can also be performed on the AV receiver by using its [Setup] button, arrow buttons, and [Enter] button.

## TV Format Setup (not North American models)

For the onscreen setup menus to display properly, you must specify the TV system used in your area.

**1**

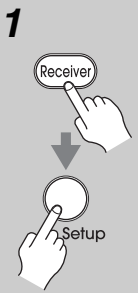

**Press the [Receiver] button followed by the [Setup] button.**  
The main menu appears onscreen. If the main menu doesn't appear, make sure the appropriate external input is selected on your TV.

**2**

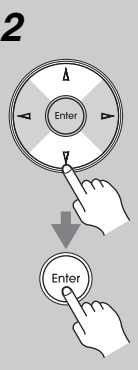

**Use the Up and Down [▲]/[▼] buttons to select “6. Miscellaneous”, and then press [Enter].**  
The “Miscellaneous” menu appears.

Integra

6. Miscellaneous

- 1. Volume Setup
- 2. OSD Setup
- 3. 12V Trigger A Setup
- 4. 12V Trigger B Setup
- 5. 12V Trigger C Setup

**3**

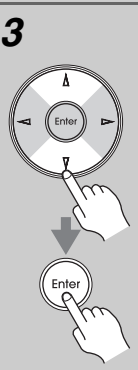

**Use the Up and Down [▲]/[▼] buttons to select “2. OSD Setup”, and then press [Enter].**  
The “OSD Setup” menu appears.

Integra

6-2. OSD Setup

- Immediate Display On ◀▶
- Monitor Type 16 : 9
- Display Position Bottom
- TV Format Auto
- Language English

**4**

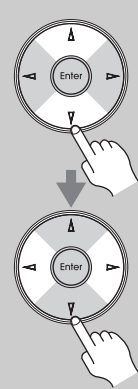

**Use the Up and Down [▲]/[▼] buttons to select “TV Format”, and then use the Left and Right [◀]/[▶] buttons to select:**

- Auto:** Select this to automatically detect the TV system from the video input signals.
- NTSC:** Select if the TV system in your area is NTSC.
- PAL:** Select if the TV system in your area is PAL.

**5**



**When you've finished, press the [Setup] button.**  
The setup menu closes.

**Note:**  
This procedure can also be performed on the AV receiver by using its [Setup] button, arrow buttons, and [Enter] button.

## AM Frequency Step Setup (not North American models)

For AM tuning to work properly, you must specify the AM frequency step used in your area. Note that when this setting is changed, all radio presets are deleted.

**1**



**Press the [Receiver] button, followed by the [Setup] button.**  
The main menu appears onscreen.  
If the main menu doesn't appear, make sure the appropriate external input is selected on your TV.

**2**



**Use the Up and Down [▲]/[▼] buttons to select “7. Hardware Setup”, and then press [Enter].**  
The “Hardware Setup” menu appears.

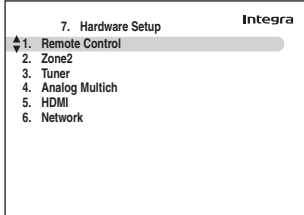

**3**



**Use the Up and Down [▲]/[▼] buttons to select “3. Tuner”, and then press [Enter].**  
The “Tuner” menu appears.

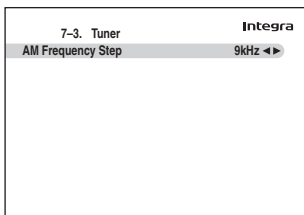

**4**

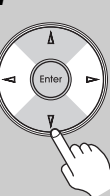

**Use the Left and Right [◀]/[▶] buttons to select:**

**10kHz:** Select if 10 kHz steps are used in your area.

**9kHz:** Select if 9 kHz steps are used in your area.

**5**



**Press the [Setup] button.**  
The setup menu closes.

**Note:**  
This procedure can also be performed on the AV receiver by using its [Setup] button, arrow buttons, and [Enter] button.

## Changing the Input Display



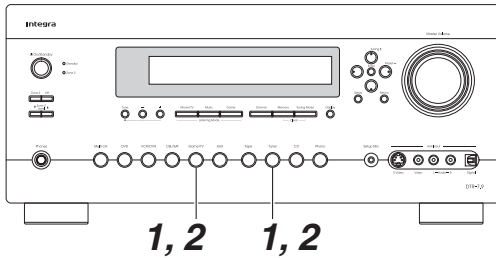

If you connect an **RI**-capable Onkyo MiniDisc recorder, CD recorder, or RI Dock to the TAPE IN/OUT or GAME/TV IN jacks, for **RI** to work properly, you must change this setting.

This setting can only be changed on the AV receiver.



### iPod photo:

If you're using an iPod photo with the RI Dock, connect the RI Dock to the GAME/TV IN jacks.

<b>1</b> Tape  or Game/TV 	<b>Press the [Tape] or [Game/TV] input selector button so that "TAPE" or "GAME/TV" appears on the display.</b>  _____ TAPE _____  _____ GAME/TV _____
<b>2</b> Tape  or Game/TV  (3 seconds)	<b>Press and hold down the [Tape] or [Game/TV] input selector button (about 3 seconds) to change the setting.</b> Repeat this step to select MD, CDR, or DOCK. For the Tape input selector, the setting changes in this order: TAPE → MD → CDR → DOCK ↑ For the Game/TV input selector, the setting changes in this order: GAME/TV ↔ DOCK

### Note:

DOCK can be selected for the Tape input selector or Game/TV input selector, but not both at the same time.



### Automatic Speaker Setup (Audyssey MultEQ®)

With the supplied calibrated microphone, Audyssey MultEQ automatically determines the number of speakers connected, their size for purposes of bass management, optimum crossover frequencies to the subwoofer (if present), and distances from the primary listening position. Audyssey MultEQ then removes the distortion caused by room acoustics by capturing room acoustical problems over the listening area in both the frequency and time domain. The result is clear, well-balanced sound for everyone. Enabling Audyssey MultEQ allows you to also use Audyssey Dynamic EQ™, which maintains the proper octave-to-octave balance at any volume level (see page 101).

Before using this function, connect and position all of your speakers.

#### Measurement Positions

To create a listening environment in your home theater that all listeners will enjoy, Audyssey MultEQ takes measurements at up to six positions within the listening area.

##### ■ 1st measurement position

This is the center position of your listening area, or the listening position if there's only one listener.

##### ■ 2nd–6th measurement positions

These are the other listening positions (i.e., the places where the other listeners will sit). You can measure up to six positions.

The following examples show some typical home theater seating arrangements. Choose the one that best matches yours, and position the microphone accordingly when prompted.

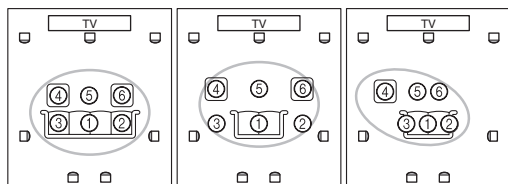
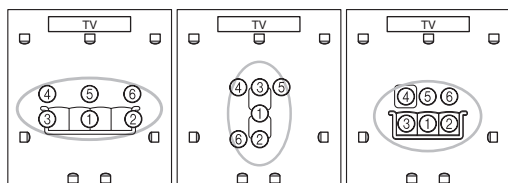
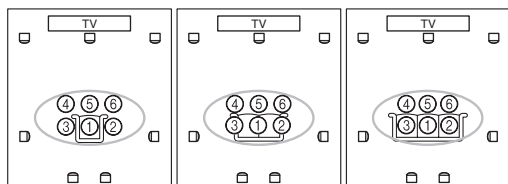

○ : listening area      ①—⑥ : listening position

### Using Audyssey MultEQ®

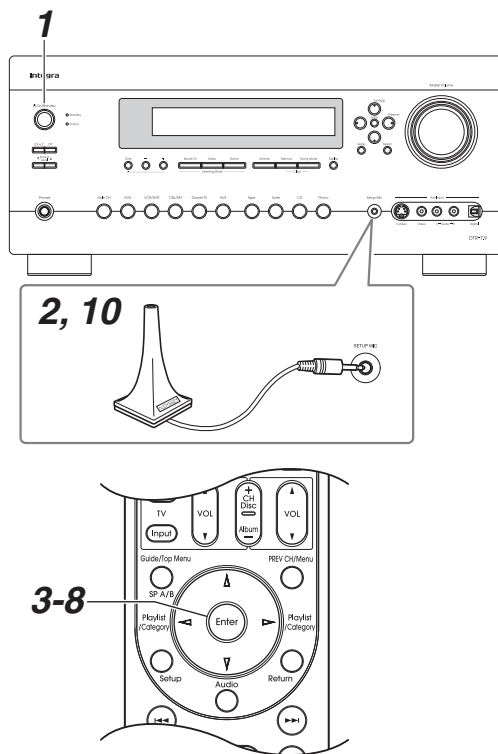

#### Notes:

- If any of your speakers is 4 ohms, change the “Speaker Impedance” setting before running the automatic speaker setup (see page 45).
- If the AV receiver is muted, it will be unmuted automatically when the automatic speaker setup starts.
- Automatic speaker setup cannot be performed while a pair of headphones is connected.
- It takes about 15 minutes to complete the automatic speaker setup for three positions. Total measurement time varies depending on the number of positions and speakers.
- Do not disconnect the speaker setup microphone during the automatic speaker setup, unless you want to cancel the setup.
- Do not connect or disconnect any speakers during the automatic speaker setup.

#### 1

#### Turn on the AV receiver and the connected TV.

On the TV, select the input to which the AV receiver is connected.

## 2

Setup Mic



Place the speaker setup microphone at measurement point ① (page 49), and connect it to the Setup Mic jack.

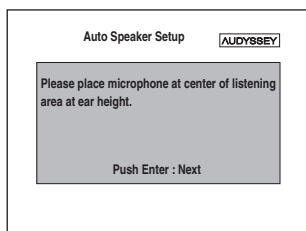

### Notes:

- Before starting Audyssey MultEQ® Automatic Speaker Setup, arrange the room and connect the speakers as you would for enjoying movies. Changes to the room after auto setup requires you run the auto setup again, as room EQ characteristics may have changed.
- When starting the automatic speaker setup, do not stand between the speakers and microphone, and avoid obstacles blocking the path between speakers and microphone. This will produce inaccurate results.
- Position the microphone at ear height of a seated listener with the microphone tip pointed directly at the ceiling using a tripod. Do not hold the microphone in your hand during measurements as this will produce inaccurate results.
- Make the room as quiet as possible. Background noise can disrupt the room measurements. Close windows, silence cell phones, televisions, radios, air conditioners, fluorescent lights, home appliances, light dimmers, or other devices.
- Cell phones should be turned off or placed away from all audio electronics during the measurement process as Radio Frequency Interference (RFI) may cause measurement disruptions (even if the cell phone is not in use).

## 3



Press [Enter].

The automatic speaker setup starts.

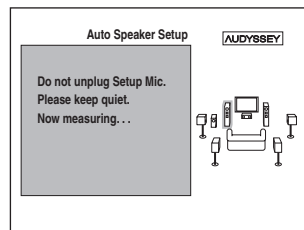

Test tones are played through each speaker as Audyssey MultEQ Automatic Speaker Setup runs. This process takes a few minutes. Please refrain from talking during measurements and do not stand between speakers and the microphone.

## 4

The following screen appears.

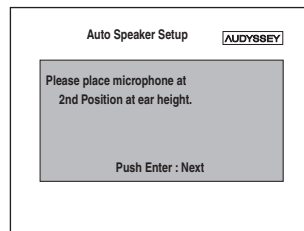

Place the setup microphone at the next position (page 49), and then press [Enter].

Audyssey MultEQ performs more measurements. This takes a few minutes.

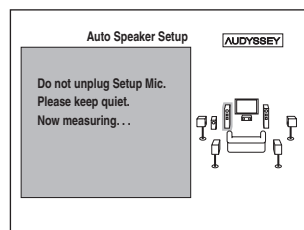

## 5

When prompted, place the setup microphone at the next position, and repeat step 4.

6

After the 3rd to the 5th measurement, the following screen appears.

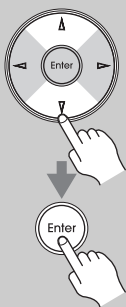
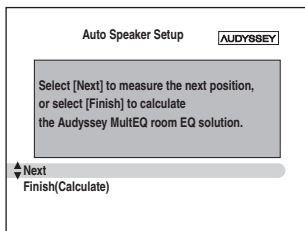

Use the Up and Down [▲]/[▼] buttons to select an option, and then press [Enter].

**Next:**

Select “Next” to begin measuring the next measurement position. After the 6th measurement has been taken, the procedure automatically proceeds to step 7.

**Finish (Calculate):**

Select this if you don’t want to measure any more listening positions and are ready to calculate the results, then go to step 7.

7

When the measurements are complete, the following screen appears.

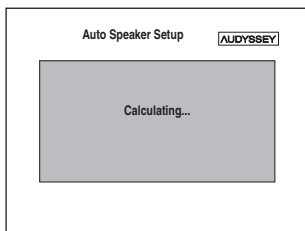

8

When the calculations are complete, the following screen appears.

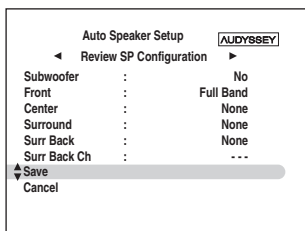

Use the Up and Down [▲]/[▼] buttons to select an option, and then press [Enter].

The options are:

**Save:**

Save the calculated settings and exit the automatic speaker setup.

**Cancel:**

Cancel the automatic speaker setup.

**Note:**

You can view the calculated settings for the speaker configuration, speaker distances, and speaker levels by using the Left and Right [◀]/[▶] buttons.

9

If you selected “Save”, the results are saved, and the following screen appears.

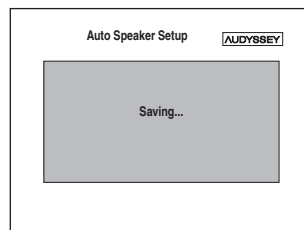

10

Disconnect the speaker setup microphone.

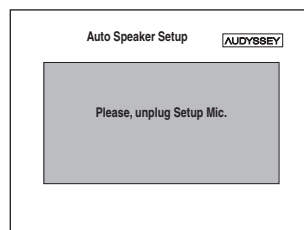

**Notes:**

- When the automatic speaker setup is complete, the “Equalizer Settings” (page 95) will be set to “Audyssey”.
- You can cancel the automatic speaker setup at any point in this procedure simply by disconnecting the setup microphone.

## Error Messages

While the automatic speaker setup is in progress, one of the following error messages may appear:

### ❑ Ambient noise is too high.

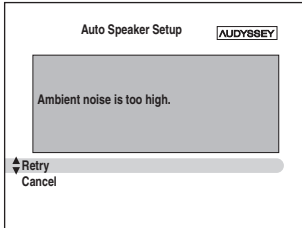

This message appears if the background noise is too loud and the measurements cannot be performed properly.

Remove the source of the noise and try again.

**Retry:** Return to the measured point immediately before and start set up again.

**Cancel:** Cancel the automatic speaker setup.

### ❑ Speaker Detect Error

This message appears if a speaker is not detected. “Yes” means that a speaker was detected. “No” means that no speaker was detected.

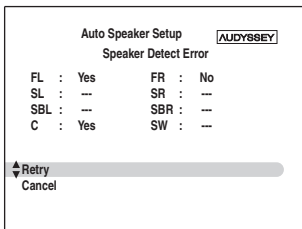

One of the front speakers has not been detected.

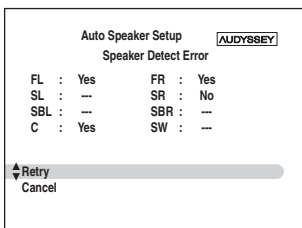

One of the surround speakers has not been detected.

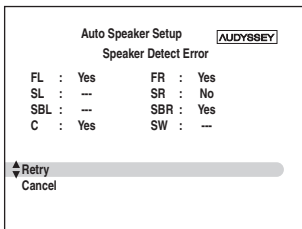

The surround back speakers have been detected but the surround speakers haven't.

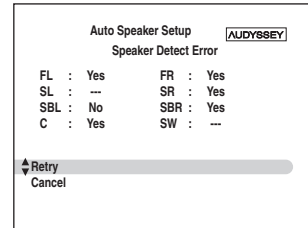

The right surround back speaker has been detected but the left surround back speaker hasn't.

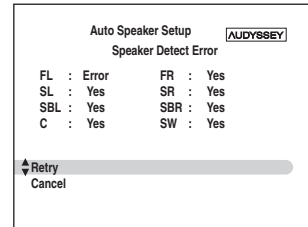

The speaker type detected does not match what was expected. The speaker may be or incorrect type or broken. Please check that it is the correct speaker type, or that all drivers are working.

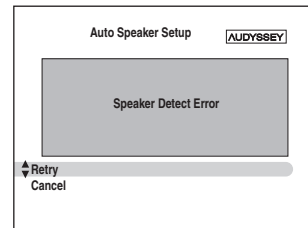

The number of speakers detected on the second or third measurement was different to the number detected on the first measurement.

Make sure speakers that cannot be detected are connected properly.

**Retry:** Return to step 2 and try again.

**Cancel:** Cancel the automatic speaker setup.

### ❑ Writing Error!

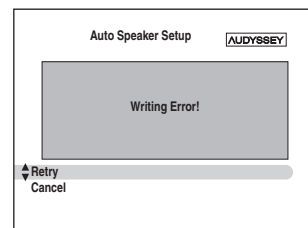

This message appears if saving fails.

Try saving again. If this message appears after 2 or 3 attempts, the AV receiver is probably malfunctioning. Contact the dealer.

**Retry:** Return to step 2 and try again.

**Cancel:** Cancel the automatic speaker setup.

### ***Changing the Speaker Settings Manually***

---

If you wish to make changes to the settings found during the automatic speaker setup, follow the directions on see pages 90–97.

#### **Notes:**

- Please note that THX recommends any THX main speakers be set to “80Hz(THX)”. If you set up your speakers using the Automatic Speaker Setup function, please make sure manually that any THX speakers are set to 80 Hz (THX) crossover (see page 90).
- Sometimes due to the electrical complexities of subwoofers and the interaction with the room, THX recommends setting the level and the distance of the subwoofer manually.
- Sometimes due to interaction with the room, you may notice irregular results when setting the level and/or distance of the main speakers. If this happens, THX recommends setting them manually.

### ***Using a Powered Subwoofer***

---

If you’re using a powered subwoofer and it outputs very low-frequency sound at a low volume level, it may not be detected by the automatic speaker setup.

If the “Subwoofer” appears on the “Review SP Configuration” screen as “No”, increase the subwoofer’s volume to the half-way point, set it to its highest crossover frequency, and then try running the automatic speaker setup again. Note that if the volume is set too high and the sound distorts, detection issues may occur, so use an appropriate volume level. If the subwoofer has a low-pass filter switch, set it to Off or Direct. Refer to your subwoofer’s instruction manual for details.

# Basic Operations

## Selecting the Input Source

This section explains how to select the input source (i.e., the AV component that you want to listen to or watch).

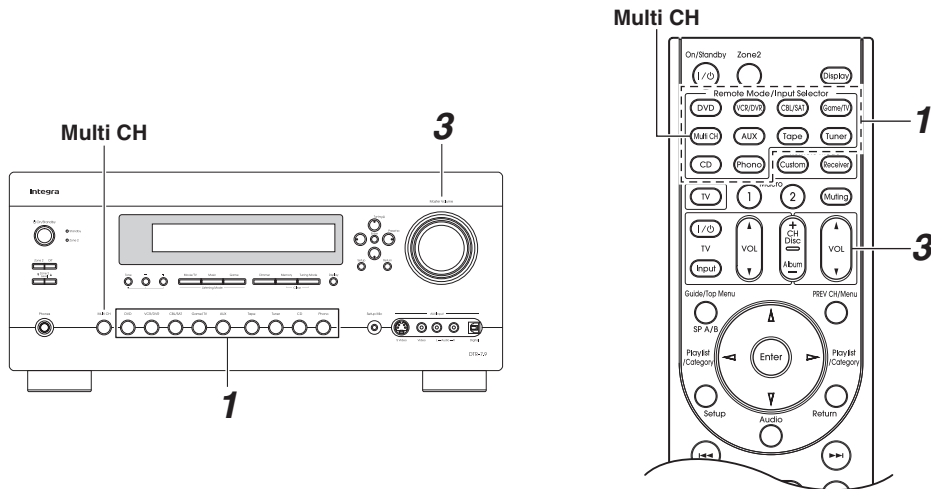

<p><b>1 AV receiver</b></p> <p><b>Remote controller</b></p> <p>or</p>	<p><b>Use the AV receiver's input selector buttons to select the input source.</b></p> <p><b>To select the input source with the remote controller, use the Input Selector buttons.</b></p>
<p><b>2</b></p>	<p><b>Start playback on the source component.</b></p> <p>When you select DVD or another video component, on your TV, you'll need to select the video input that's connected to the AV receiver's HDMI OUT, COMPONENT VIDEO MONITOR OUT or MONITOR OUT. On some DVD players, you may need to turn on the digital audio output.</p>
<p><b>3 AV receiver</b></p> <p><b>Remote controller</b></p> <p>or</p>	<p><b>To adjust the volume, use the Master Volume control, or the remote controller's VOL [▲]/[▼] button.</b></p> <p>The volume can be set to <math>-\infty</math> dB, <math>-81.5</math> dB through <math>+18.0</math> dB (relative display).</p> <p>The AV receiver is designed for home theater enjoyment. It has a wide volume range, allowing precise adjustment.</p> <p>The volume level can also be displayed as an absolute value. See "Volume Setup" on page 106.</p>
<p><b>4</b></p>	<p><b>Select a listening mode and enjoy!</b></p> <p>See "Using the Listening Modes" on page 79.</p>

### Using the Multichannel DVD Input

The multichannel DVD input is for connecting a component with a 7.1-channel analog audio output, such as a DVD-Audio or SACD-capable DVD player, or an MPEG decoder. See page 26 for hookup information.

	<p><b>Press the [Multi CH] button.</b></p> <p>“Multich” appears on the display. Audio from the multichannel DVD input will now be used for the DVD input source.</p>
---	--

#### Notes:

- While the multichannel DVD input is selected, the Speaker Configuration settings on page 90 are ignored, and signals from the multichannel input are fed to the speakers as they are.
- The multichannel DVD input cannot be used if “Speakers Type” is set to “Bi-Amp” (see page 45).
- This procedure can also be performed on the AV receiver by using its [Multi CH] button.

### Adjusting the Bass & Treble

You can adjust the bass and treble for the front speakers, except when the Direct or THX listening mode is selected.

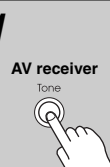
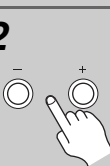
<p><b>1</b></p> 	<p><b>Press the [Tone] button repeatedly to select either “Bass” or “Treble”.</b></p>
<p><b>2</b></p> 	<p><b>Use the Tone [-]/[+] buttons to adjust.</b></p>

#### ■ Bass

You can boost or cut low-frequency sounds output by the front speakers from -10 dB to +10 dB in 2 dB steps.

#### ■ Treble

You can boost or cut high-frequency sounds output by the front speakers from -10 dB to +10 dB in 2 dB steps.

#### Notes:

- This setting is not available when the multichannel DVD input is selected.
- This procedure can also be performed on the remote controller by using [Audio] button (see page 100).

### Displaying Source Information

You can display various information about the current input source as follows.

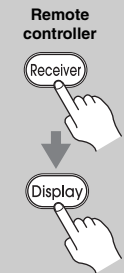
	<p><b>Press the [Receiver] button, and then press the [Display] button repeatedly to cycle through the available information.</b></p>
---	---

#### Note:

This procedure can also be performed on the AV receiver by using its [Display] button.

The following information can typically be displayed for input sources.



- \* If the input signal is analog, no format information is displayed. If the input signal is PCM, the sampling frequency is displayed. If the input signal is digital but not PCM, the signal format and the number of channels is displayed. For some digital input signals, including multichannel PCM, the signal format, number of channels, and sampling frequency is displayed. Information is displayed for about three seconds, then the previously displayed information reappears.

### Setting the Display Brightness

You can adjust the brightness of the AV receiver’s display.

	<p><b>Press the [Receiver] button, and then press the [Dimmer] button repeatedly to select: Normal, Dim, or Dimmer.</b></p> <p>Alternatively, you can use the AV receiver’s [Dimmer] button (North American models only).</p>
---	---

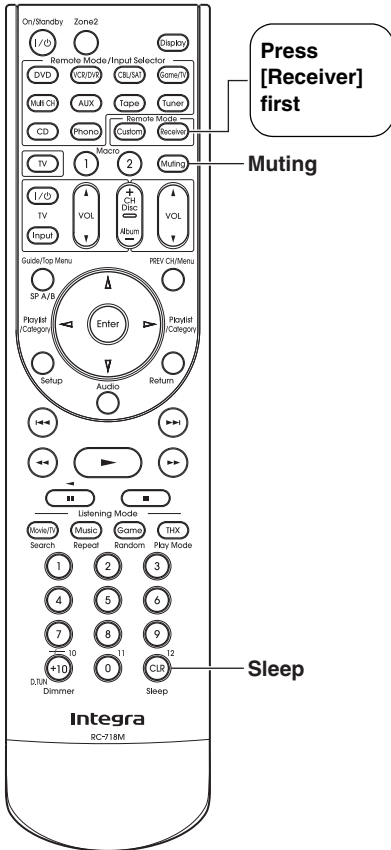

### Using the Sleep Timer

With the sleep timer, you can set the AV receiver to turn off automatically after a specified period.

**Press the [Receiver] button, and then press the [Sleep] button repeatedly to select the required sleep time.**

The sleep time can be set from 90 to 10 minutes in 10 minute steps.

The Sleep indicator appears on the display when the sleep timer has been set. The specified sleep time appears on the display for about five seconds, then the previous display reappears.

If you need to cancel the sleep timer, press the [Sleep] button repeatedly until the SLEEP indicator disappears.

To check the time remaining until the AV receiver sleeps, press the [Sleep] button. Note that if you press the [Sleep] button while the sleep time is being displayed, you'll shorten the sleep time by 10 minutes.

### Using Headphones

You can connect a pair of stereo headphones (1/4-inch phone plug) to the AV receiver's Phones jack for private listening, as shown.

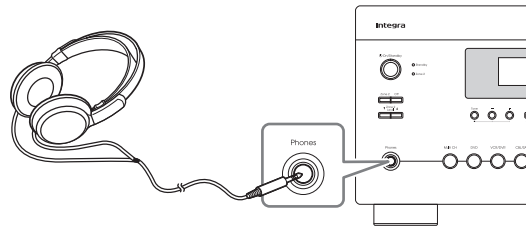

**Notes:**

- Always turn down the volume before connecting your headphones.
- While the headphones plug is inserted in the Phones jack, the speakers are turned off and the Headphone indicator lights up. (The Powered Zone 2 speakers are not turned off.)
- When you connect a pair of headphones, the listening mode is set to Stereo, unless it's already set to Stereo, Mono, or Direct.
- Only the Stereo, Direct, and Mono listening modes can be used with headphones (the listening modes available also depend on the currently selected input source).
- When the multichannel input is used, only the front left and right audio can be heard in the headphones.

### Muting the AV receiver

You can temporarily mute the output of the AV receiver.

**Press the [Receiver] button, and then press the [Muting] button.**

The output is muted and the MUTING indicator flashes on the display, as shown.

To unmute the AV receiver, press the [Muting] button again, or adjust the volume.

The Mute function is cancelled when the AV receiver is set to Standby.

**Tip:**

You can specify how much the output is muted with the "Muting Level" setting (see page 106).



# Listening to the Radio

## Using the Tuner

With the built-in tuner you can enjoy AM and FM radio stations. You can store your favorite stations as presets for quick selection.

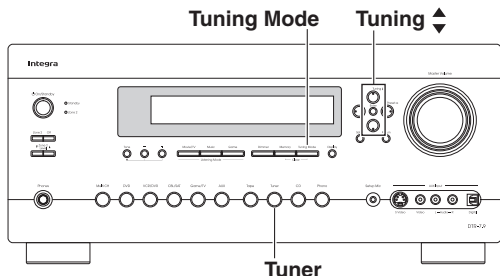

## Listening to the Radio



**Use the [Tuner] input selector button to select either AM or FM.** In this example, FM has been selected. Each time you press the [Tuner] button, the input source changes between AM and FM.

Band	Frequency
FM	87.5 MHz

(Actual display depends on country)

## Tuning into Radio Stations

### Auto Tuning Mode

- Press the [Tuning Mode] button so that the AUTO indicator appears on the display.**
- Press the Tuning Up or Down [▲]/[▼] buttons.** Searching stops when a station is found.

When tuned into a station, the TUNED indicator appears. When tuned into a stereo FM station, the FM STEREO indicator appears on the display, as shown.

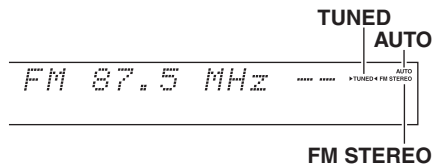

### Manual Tuning Mode

- Press the [Tuning Mode] button so that the AUTO indicator disappears from the display.**
- Press and hold the Tuning Up or Down [▲]/[▼] buttons.** The frequency stops changing when you release the button. Press the buttons repeatedly to change the frequency one step at a time.

The North American models change FM frequency in 0.2 MHz steps, 10 kHz steps for AM. For other models it's 0.05 MHz steps for FM and 9 kHz steps for AM. In Manual Tuning mode, FM stations will be in mono.

### Tuning into weak FM stereo stations

If the signal from a stereo FM station is weak, it may be impossible to get good reception. In this case, switch to Manual Tuning mode and listen to the station in mono.

### Tuning into Stations by Frequency

You can tune into AM and FM stations directly by entering the appropriate frequency.

- Press the [Tuner] button repeatedly to select AM or FM, followed by the [D.TUN] button.**

(Actual display depends on country.)
- Within 8 seconds, use the number buttons to enter the frequency of the radio station.** For example, to tune to 87.5 (FM), press 8, 7, 5.

## Presetting AM/FM Stations

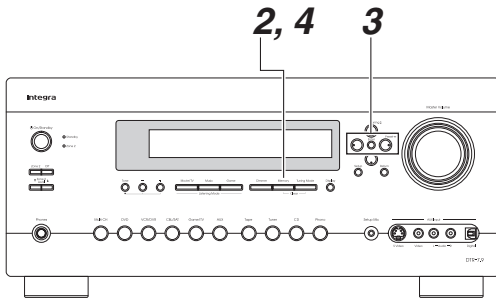

You can store a combination of up to 40 of your favorite AM/FM radio stations as presets.

<b>1</b>	<p><b>Tune into the AM/FM station that you want to store as a preset.</b></p>
<b>2</b>	<p><b>Press the [Memory] button.</b> The preset number flashes.</p>
<b>3</b>	<p><b>While the preset number is flashing (about 8 seconds), use the Preset [◀]/[▶] buttons to select a preset from 1 through 40.</b></p>
<b>4</b>	<p><b>Press the [Memory] button again to store the station or channel.</b> The station or channel is stored and the preset number stops flashing. Repeat this procedure for all of your favorite AM/FM radio stations.</p>

**Note:**

You can name your radio presets for easy identification (see page 104). Its name is displayed instead of the band and frequency.

## Selecting Presets

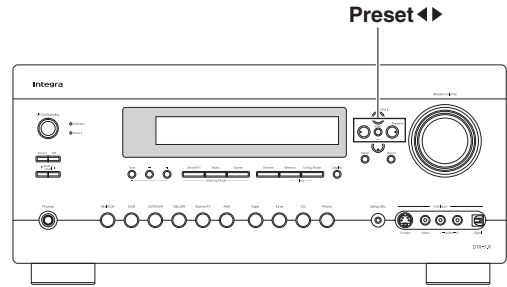

<p><b>AV receiver</b> Preset ◀▶</p>	<p><b>To select a preset, use the Preset [◀]/[▶] buttons, or the remote controller's CH [+/-] button.</b></p>
<p><b>Remote controller</b> + CH Disc - Album</p>	<p><b>You can also use the remote controller's number buttons to select a preset directly.</b></p>

## Deleting Presets

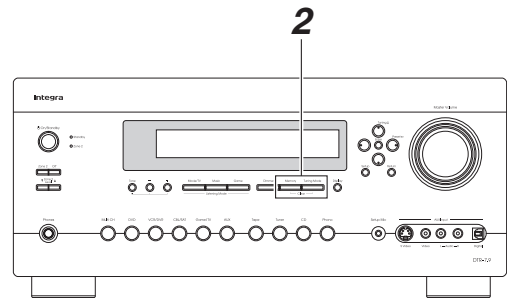

<b>1</b>	<p><b>Select the preset that you want to delete.</b> See the previous section.</p>
<b>2</b>	<p><b>While holding down the [Memory] button, press the [Tuning Mode] button.</b> The preset is deleted and its number disappears from the display.</p>

### Listening to XM Satellite Radio® (North American Model Only)

#### About XM Radio

XM is North America's number one satellite radio company, offering an extraordinary variety of commercial-free music, plus the best in premier sports, news, talk radio, comedy, children's and entertainment programming, broadcast in superior digital audio quality coast to coast. For more information, or to subscribe, U.S. customers visit [xmradio.com](http://xmradio.com) or call XM Listener Care at 1-800-XMRADIO (1-800-967-2346); Canadian customers visit [xmradio.ca](http://xmradio.ca) or call XM Listener Care at 1-877-GETXMSR (1-877-438-9677).

#### XM Ready® Legal

XM monthly service subscription sold separately. XM Mini-Tuner and Home Dock required (each sold separately) to receive XM service. It is prohibited to copy, decompile, disassemble, reverse engineer, hack, manipulate or otherwise make available any technology or software incorporated in receivers compatible with the XM satellite Radio System. Installation costs and other fees and taxes, including a one-time activation fee may apply. All fees and programming subject to change. Channels with frequent explicit language are indicated with an XL. Channel blocking is available for XM radio receivers by calling 1-800-XMRADIO (U.S. residents) and 1-877-GETXMSR (Canadian residents). Only available in the 48 contiguous United States and Canada. ©2007 XM Satellite Radio Inc. All rights reserved.

#### XM Ready® Subscription

Once you have installed the XM Mini-Tuner Home Dock, inserted the XM Mini-Tuner, connected the XM Mini-Tuner Home Dock to your XM Ready® audio system, and installed the antenna, you are ready to subscribe and begin receiving XM programming. There are three places to find your eight character XM Radio ID: On the XM Mini-Tuner, on the XM Mini-Tuner package, and on XM Channel 0. Record the Radio ID below for reference.

--	--	--	--	--	--	--	--

**Note:**

The XM Radio ID does not use the letters "I", "O", "S" or "F".

Activate your XM Satellite Radio service in the U.S. online at <http://activate.xmradio.com> or call 1-800-XMRADIO (1-800-967-2346). Activate your XM Satellite Radio service in Canada online at <https://activate.xmradio.ca> or call 1-877-GET-XMSR (1-877-438-9677). You will need a major credit card. XM will send a signal from the satellites to activate the full channel

lineup. Activation normally takes 10-15 minutes, but during peak busy periods you may need to keep your XM Ready audio system on for up to an hour. When you can access the full lineup on your XM Ready audio system you are done.

#### Connecting the XM Mini-Tuner and Home Dock

To receive XM Satellite Radio, you need an XM Mini-Tuner and Home Dock, which includes a home antenna. These are sold separately. For connection information, refer to the instruction manual supplied with the XM Mini-Tuner and Home Dock.

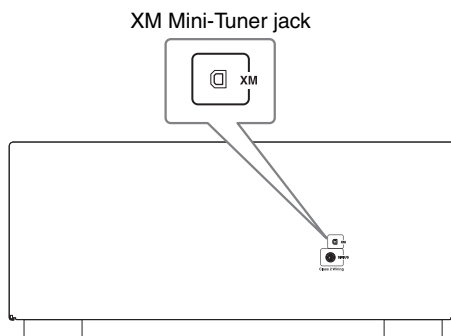

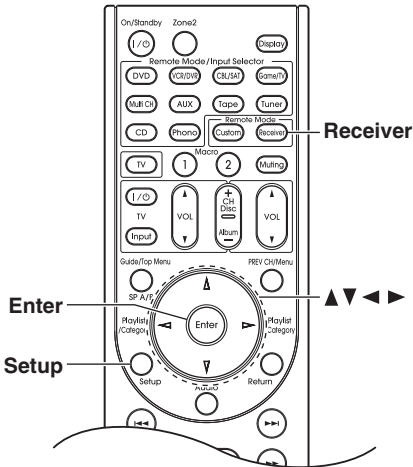

**Setting the Satellite Radio Mode**

Before you can listen to XM Satellite Radio, you must set the SAT Radio Mode to “XM”.

**1**

**Press the [Receiver] button, followed by the [Setup] button.**  
The main menu appears onscreen.

**2**

**Use the Up and Down [▲]/[▼] buttons to select “7. Hardware Setup”, and then press [Enter].**  
The “Hardware Setup” menu appears.

Integra

7. Hardware Setup

- ▲ 1. Remote Control
- 2. Zone2
- 3. Tuner
- 4. Analog Multich
- 5. HDMI
- 6. Network

**3**

**Use the Up and Down [▲]/[▼] buttons to select “3. Tuner”, and then press [Enter].**  
The “Tuner” screen appears.

Integra

7-3. Tuner

- ▲ SAT Radio Mode XM ◀▶
- Antenna Aiming
- SURIUS Parental Lock

**4**

**Use the Left and Right [◀]/[▶] buttons to select “XM”.**  
**If there are 2 items on the Tuner screen, use Up and Down [▲]/[▼] buttons to select “SAT Radio Mode”.**

Pressing the Left and Right [◀]/[▶] buttons cycles through the following options: None → XM → SIRIUS → XM/SIRIUS

- None:** Select if you’re not using Satellite Radio.
- XM:** Select to use XM Satellite Radio.
- SIRIUS:** Select to use SIRIUS Satellite Radio.
- XM/SIRIUS:** Select to use XM Satellite Radio and SIRIUS Satellite Radio.

**5**

**When you’ve finished, press the [Setup] button.**  
The setup menu closes.

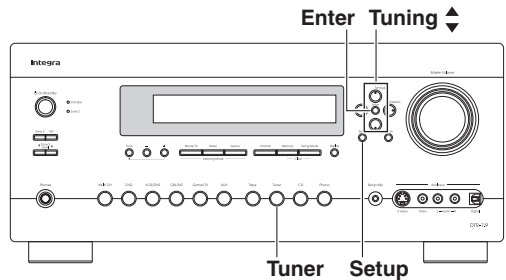

**Selecting XM Satellite Radio**

**AV receiver**

**On the AV receiver, press the [Tuner] button repeatedly to select “XM”.**

**Remote controller**

**On the remote controller, press the [Tuner] button repeatedly to select “XM”.**

If “CHECK XM TUNER” appears on the display, make sure the XM Mini-Tuner is connected properly.

## Signing Up for XM Satellite Radio

Once you have installed the XM Mini-Tuner and Home Dock, you are ready to subscribe to XM Satellite Radio. You'll need a major credit card and your XM Radio ID. There are three places you can find your 8-character XM Radio ID:

1. On the XM Mini-Tuner
2. On the XM Mini-Tuner packaging
3. On XM Channel 0, as explained below

<b>1</b> AV receiver 	<p><b>Use the Tuning Up and Down [▲]/[▼] buttons to select RADIO ID.</b></p> <p>Your XM Radio ID number is displayed. Write it below for reference.</p> <p style="text-align: center;">ID _____</p>
<b>2</b>	<p><b>To sign up, go to:</b>  <a href="http://activate.xmradio.com">http://activate.xmradio.com</a>  <b>Or call: 1-800-967-2346</b></p> <p><b>For XM Canada, go to:</b>  <a href="http://xmradio.ca">http://xmradio.ca</a>  <b>Or call: 1-877-438-9677</b></p>

### Notes:

- RADIO ID cannot be selected in Category Search mode. You must select Channel Search mode (see below).
- The following letters are not used in XM Satellite Radio IDs: I, O, S, F.
- XM Satellite Radio will transmit a special signal to your AV receiver to activate the full channel lineup. Activation normally takes between 10 and 15 minutes, but during busy peak periods, you may need to leave the AV receiver turned on for up to an hour.

## Selecting XM Radio Channels

There are three ways to select XM radio channels:

1. **Channel Search mode:** select any channel.
2. **Category Search mode:** select channels by category.
3. **Direct tuning:** enter channel number.

### Note:

You cannot select Channel Search or Category Search mode while the Tuning Arrow ▲ ◀ ▶ indicators are flashing, as tuning is in progress.

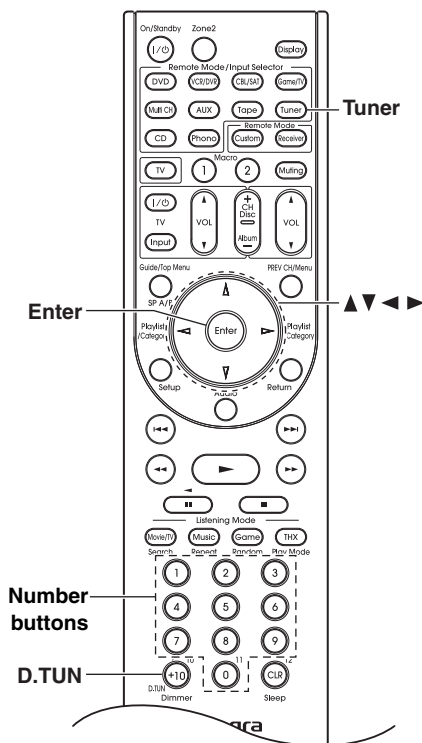

### ■ Channel Search Mode

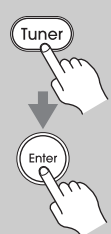
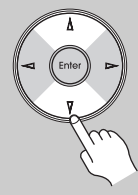
<b>1</b> 	<p><b>Press the [Tuner] button, and then press the [Enter] button repeatedly to select Channel Search mode.</b></p> <p style="text-align: center;">ChannelSearch</p> <p>This procedure can also be performed on the AV receiver by using its [Tuner] button, and [Tuning Mode] button.</p>
<b>2</b> 	<p><b>Use the Up and Down [▲]/[▼] buttons to select a channel.</b></p> <p style="text-align: center;">Channel number</p> <p style="text-align: center;">XM 050 5</p> <p style="text-align: center;">The Loft</p> <p style="text-align: center;">Channel name</p> <p>You can also use the Left and Right [◀]/[▶] buttons to select a category.</p>

## ■ Category Search Mode

**1** **Remote controller**

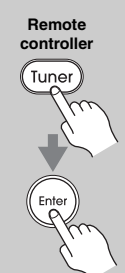

Press the [Tuner] button, and then press the [Enter] button repeatedly to select Category Search mode.

*Category Search*

This procedure can also be performed on the AV receiver by using its [Tuner] button, and [Tuning Mode] button.

**2**

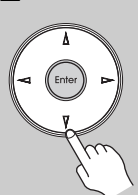

Use the Left and Right [◀]/[▶] buttons to select a category, and use the Up and Down [▲]/[▼] buttons to select a channel in that category.

## ■ Direct Tuning

You can select an XM radio channel directly by entering its number.

**1** **Remote controller**



Press the [Tuner] button, followed by the [D.TUN] button.

*XM* 

**2**



Within 8 seconds, use the number buttons to enter the channel number.

For example, to select channel #20, press 0, 2, 0, or 2, 0, [Enter].

**Note:** While the [Tuner] button is flashing, you cannot select another input source with the remote controller.

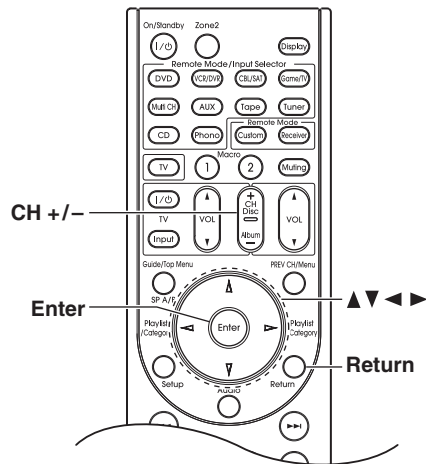
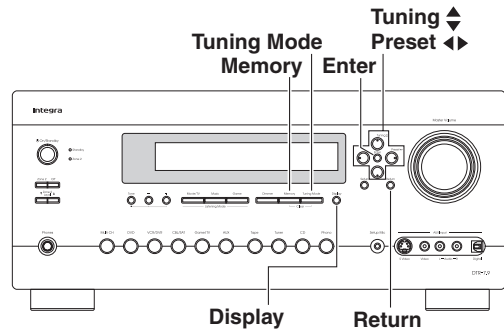

Selecting Channels on the AV receiver:

**1** **AV receiver** Tuning Mode



Press the [Tuning Mode] button repeatedly to select Channel Search mode or Category Search mode.

**2** **AV receiver** Enter



Press [Enter] repeatedly to select a category.

**3** **AV receiver** Tuning Mode



Use the Tuning Up and Down [▲]/[▼] buttons to select a channel.

In Channel Search mode, you can select any channel.

In Category Search mode, you can only select channels from the currently selected category.

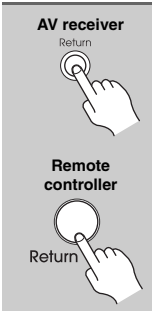

## Listening to the Radio—Continued

### Selecting the Previous Channel:

 <p>AV receiver Return</p> <p>Remote controller Return</p>	<p>To listen to the previously selected XM channel, press the [Return] button.</p>
---	--

### Presetting XM Channels

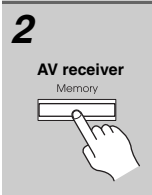
You can store a combination of up to 40 of your favorite XM channels and AM/FM radio stations as presets.

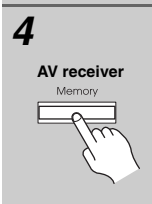
<p><b>1</b></p>	<p>Tune into the XM channel that you want to store as a preset.</p>
 <p>AV receiver Memory</p>	<p><b>2</b> Press the [Memory] button. The preset number flashes.</p>
 <p>AV receiver Preset</p>	<p><b>3</b> While the preset number is flashing (about 8 seconds), use the Preset [◀]/[▶] buttons to select a preset from 1 through 40.</p>
 <p>AV receiver Memory</p>	<p><b>4</b> Press the [Memory] button again to store the channel. The channel is stored and the preset number stops flashing. Repeat this procedure for all of your favorite XM channels.</p>

### Selecting Presets

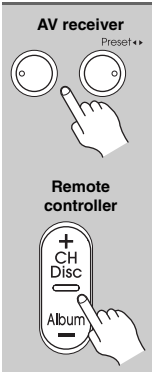
 <p>AV receiver Preset</p> <p>Remote controller CH Disc</p>	<p>To select a preset, use the Preset [◀]/[▶] buttons, or the remote controller's CH [+/-] button.</p>
--	--

### Deleting Presets

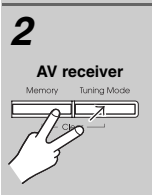
<p><b>1</b></p>	<p>Select the preset that you want to delete. See the previous section.</p>
 <p>AV receiver Tuning Mode</p>	<p><b>2</b> While holding down the [Memory] button, press the [Tuning Mode] button. The preset is deleted and its number disappears from the display.</p>

### Displaying XM Radio Information

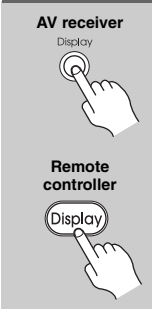
 <p>AV receiver Display</p> <p>Remote controller Display</p>	<p>Press the [Display] button repeatedly to cycle through the available information.</p>
---	--

The following information can be displayed:

```

Channel name
  ↓
Category
  ↓
Artist
  ↓
Song title
  ↓
Listening mode
    
```

#### Note:

If the category, artist, or song title is not available, “- - -” will be displayed instead.

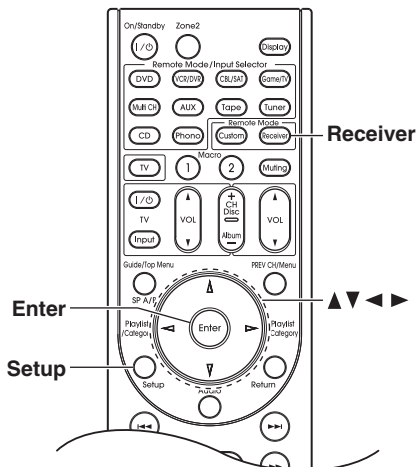

## Positioning the XM Mini-Tuner System

You can check the signal strength of the XM radio signal and adjust the position of the XM Mini-Tuner System accordingly.

**1** Press the [Receiver] button, followed by the [Setup] button. The main menu appears onscreen.

**2** Use the Up and Down [▲]/[▼] buttons to select “7. Hardware Setup”, and then press [Enter] button. The Hardware Setup menu appears.

Integra

7. Hardware Setup

- 1. Remote Control
- 2. Zone2
- 3. Tuner
- 4. Analog Multich
- 5. HDMI
- 6. Network

**3** Use the Up and Down [▲]/[▼] buttons to select “3. Tuner”, and then press [Enter] button. The Tuner screen appears.

Integra

7-3. Tuner

- ▲ SAT Radio Mode XM ◀▶
- Antenna Aiming

**4** Use the Left and Right [◀]/[▶] buttons to select “XM”. Use the Up and Down [▲]/[▼] buttons to select “Antenna Aiming”, and then press [Enter]. The “Antenna Aiming” screen appears.

**Note:** If the SAT Radio Mode is set to “None” (see page 60), the “Antenna Aiming” item is not available.

**5** Position the XM Mini-Tuner Antenna so that as many bars as possible (up to 3) appear on the XM Satellite signal strength meter.

The best signal is achieved when the antenna is pointing to the southern sky through an unobstructed window.

7-3. Tuner      Integra

XM Antenna Aiming

Satellite	Terrestrial
-----------	-------------

If you cannot receive a satellite signal, position the XM Mini-Tuner System so that as many bars as possible (up to 3) appear on the XM Terrestrial signal strength meter.

- Notes:**
- So long as the signal strength is good, you can enjoy XM Radio by using either satellite or terrestrial reception.
  - Terrestrial signals are only available in certain areas.
  - The XM information is only displayed when the SAT Radio Mode is set to “XM” or “XM/SIRIUS” (see page 60).
  - If you’re using both XM Satellite Radio and SIRIUS Satellite Radio and the SAT Radio Mode is set to “XM/SIRIUS” (see page 60), signal strength meters for both systems appear on the same screen.



### **XM Radio Messages**

---

The following messages may appear while using XM Satellite radio.

#### **❑ CHECK ANTENNA**

The XM antenna is not properly connected to the Mini-Tuner Dock. Check the connection. Check the antenna cable for damage.

#### **❑ CH UNAUTHORIZED**

The XM channel you selected is blocked or cannot be received with your XM subscription package.

Check [xmradio.com](http://xmradio.com) or [xmradio.ca](http://xmradio.ca) for the latest channel listing.

To receive the desired channel, contact XM Satellite Radio.

#### **❑ NO SIGNAL**

The XM Mini-Tuner can not receive the satellite signal. Check the XM antenna for obstructions to the southern sky. Check the antenna positioning with the Antenna Aiming function (see page 64).

#### **❑ LOADING**

The AV receiver is tuning or decoding audio or text data. Please wait. If this occurs often, check the XM antenna position with the Antenna Aiming function. (see page 64)

#### **❑ OFF AIR**

The XM channel you selected is not currently broadcasting. Select another channel.

#### **❑ UPGRADE XM TUNER**

The connected XM CNP-1000 is incompatible. The AV receiver features advanced technology that is designed for use with the XM Mini-Tuner. Contact XM Listener Care and ask about upgrading your XM CNP-1000 to an XM Mini-Tuner. Have the AV receiver's model name and CNP-1000 XM ID number ready beforehand, and explain that your AV receiver is displaying the message "Upgrade XM Tuner". If you already have an XM Mini-Tuner connected and you see this message, turn off the AV receiver, make sure the XM Mini-Tuner is properly seated in the Mini-Tuner Dock, and then turn the AV receiver back on again. If the message reappears, contact XM Listener Care and explain the issue that you're experiencing and the corrective actions you've tried.

#### **❑ CHECK XM TUNER**

The AV receiver is having difficulty communicating with the XM Mini-Tuner module. Make sure the XM Mini-Tuner is properly seated in the Mini-Tuner Dock. And make sure the Mini-Tuner Dock cable is properly connected to the AV receiver and is not damaged. If the issue persists, contact XM Listener Care. Have the AV receiver's model name ready

beforehand, and explain the issue that you're experiencing and the corrective actions you've tried.

#### **❑ CH UNAVAILABLE**

You may be attempting to select a channel that is unavailable or has changed to a different channel number. Check [xmradio.com](http://xmradio.com) or [xmradio.ca](http://xmradio.ca) for the latest channel listing.

<b>XM Listener Care phone number:</b>
<b>US: 1-800-967-2346</b>
<b>Canada: 1-877-438-9677</b>

### Listening to SIRIUS Satellite Radio® (North American Models Only)

#### Important SIRIUS Satellite Radio Information

SIRIUS is available in the US for subscribers with addresses in the continental US and is available in Canada for subscribers with a Canadian address. To Get SIRIUS Satellite Radio a subscription and compatible tuner and antenna are required and sold separately. Visit [sirius.com](http://sirius.com) for the most complete and up-to-date channel lineup and information. “SIRIUS” and the SIRIUS dog logo and related marks are trademarks of SIRIUS Satellite Radio Inc.

#### Note:

Hardware and required basic monthly subscription sold separately. Installation costs and other fees and taxes, including a one-time activation fee may apply. Subscription fee is consumer only. All fees and programming subject to change.

#### What is SIRIUS Satellite Radio?

Simply The Best Radio on Radio™ with all your favorite entertainment including 100% commercial-free music, plus superior sports coverage, uncensored talk and comedy, world-class entertainment, news, weather and more for your car, home or office. For more information visit [sirius.com](http://sirius.com) or [siriuscanada.ca](http://siriuscanada.ca)

#### A warning against reverse engineering:

It is prohibited to copy, decompile, disassemble, reverse engineer, or manipulate any technology incorporated in receivers compatible with the SIRIUS Satellite Radio system.

“SIRIUS” and the SIRIUS dog logo are registered trademarks of SIRIUS Satellite Radio Inc.



### Setting Up the SiriusConnect™ Home Tuner

The optional SiriusConnect Home tuner kit includes everything for easy home installation, including the SiriusConnect receiver, indoor/outdoor antenna with 21-foot cable, 8-pin mini DIN connector cable, and an AC power adapter. See the SiriusConnect Home tuner's instructions for more information.

Use the 8-pin mini DIN connector cable to connect the SiriusConnect receiver to the SIRIUS jack on the rear of the AV receiver.

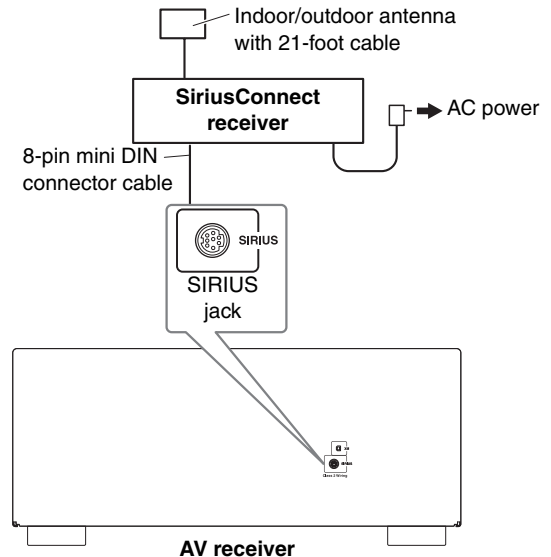

To use the included antenna indoors, you must place it at a north-, west-, or east-facing window, depending on where you live. If this isn't possible, you'll need to install it outside, away from any overhead obstructions.

## Positioning the Antenna

For a consistent satellite signal, the antenna must be positioned correctly. Use the following map to determine which area you are in and position the antenna accordingly.

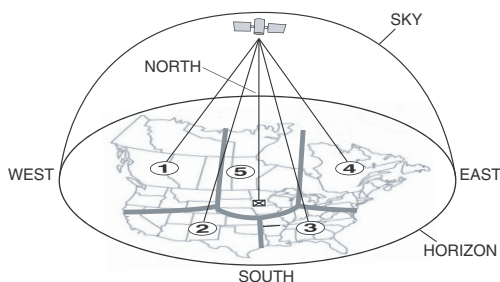

**Area 1:** Point the antenna toward the sky in the *east, north-east, or southeast*, either through a window or outside.

**Area 2:** Point the antenna toward the sky in the *north or northeast*, either through a window or outside.

**Area 3:** Point the antenna toward the sky in the *north or northwest*, either through a window or outside.

**Area 4:** Point the antenna toward the sky in the *west, north-west, or southwest*, either through a window or outside.

**Area 5:** Put the antenna outside and point it *straight up*. The antenna cannot be used indoors.

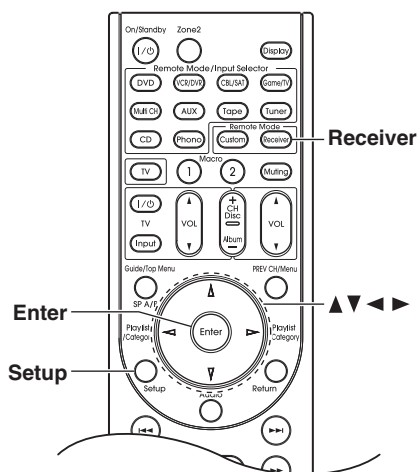

## Setting the Satellite Radio Mode

Before you can listen to SIRIUS Satellite Radio, you must set the SAT Radio Mode to “SIRIUS”.

**1**



**Press the [Receiver] button, followed by the [Setup] button.**

The main menu appears onscreen.

**2**



**Use the Up and Down [▲]/[▼] buttons to select “7. Hardware Setup”, and then press [Enter].**

The “Hardware Setup” menu appears.

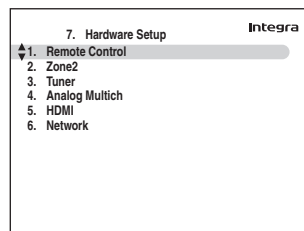

**3**



**Use the Up and Down [▲]/[▼] buttons to select “3. Tuner”, and then press [Enter].**

The “Tuner” screen appears.

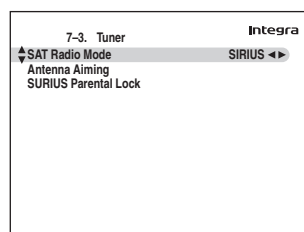

**4**

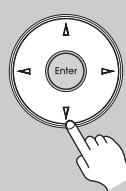

**Use the Left and Right [◀]/[▶] buttons to select “SIRIUS”.**

**If there are 2 items on the Tuner screen, use Up and Down [▲]/[▼] buttons to select “SAT Radio Mode”.**

Pressing the Left and Right [◀]/[▶] buttons cycles through the following options: None → XM → SIRIUS → XM/SIRIUS

**None:** Select if you’re not using Satellite Radio.

**XM:** Select to use XM Satellite Radio.

**SIRIUS:** Select to use SIRIUS Satellite Radio.

**XM/SIRIUS:** Select to use XM Satellite Radio and SIRIUS Satellite Radio.

**5**



**When you’ve finished, press the [Setup] button.**

The setup menu closes.

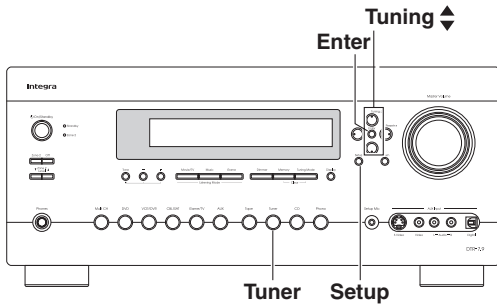

## Selecting SIRIUS Satellite Radio

### AV receiver



On the AV receiver, press the [Tuner] button repeatedly to select “SIRIUS”.

### Remote controller



On the remote controller, press the [Tuner] button repeatedly to select “SIRIUS”.

If “CHECK SIRIUS TUNER” appears on the display, make sure the SiriusConnect receiver is connected properly. If “ANTENNA ERROR” appears, make sure the antenna is connected properly.

## Signing Up for SIRIUS Satellite Radio

Before you can use SIRIUS Satellite Radio, you must first sign up for an account. You’ll need a major credit card and your *SIRIUS Satellite Radio ID*, which you can get from the AV receiver, as explained below, or from the SiriusConnect Home tuner package.

**1**

### AV receiver

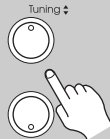

Use the Tuning Up and Down [▲]/[▼] buttons to select channel 0.

Your SIRIUS Satellite Radio ID number is displayed. Write it below.

ID \_\_\_\_\_

**2**

To sign up, go to:  
<http://activate.siriusradio.com>  
 Or call: 1-888-539-SIRIUS (7474)

### Note:

Your ID is also displayed on the Satellite Radio screen. See “Positioning the SiriusConnect Home antenna” on page 74

## Selecting SIRIUS Satellite Radio Channels

There are three ways to select SIRIUS Satellite Radio channels:

- Channel Search mode:** select any channel.
- Category Search mode:** select channels by category.
- Direct tuning:** enter channel number.

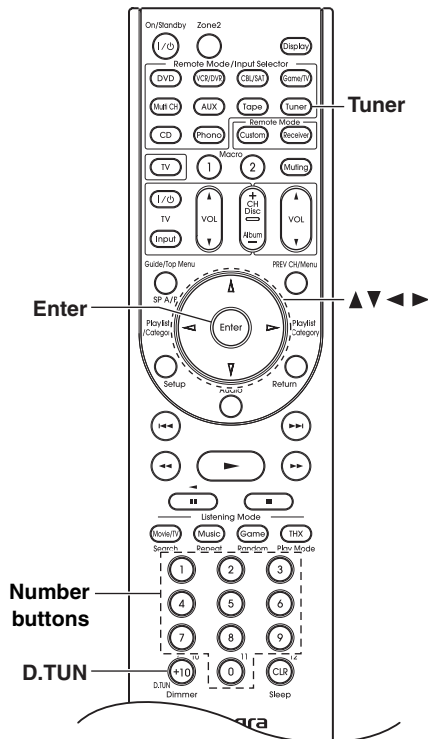

### ■ Channel Search Mode

**1**



Press the [Tuner] button, and then press the [Enter] button repeatedly to select Channel Search mode.

ChannelSearch

This procedure can also be performed on the AV receiver by using its [Tuner] button, and [Tuning Mode] button.

**2**

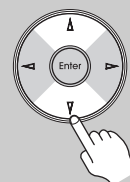

Use the Up and Down [▲]/[▼] buttons to select a channel.

Channel number

SR 050  
Hot Jans

Channel name

You can also use the Left and Right [◀]/[▶] buttons to select a category.

## ■ Category Search Mode

**1**

Remote controller



Press the [Tuner] button, and then press the [Enter] button repeatedly to select Category Search mode.

Category Search

This procedure can also be performed on the AV receiver by using its [Tuner] button, and [Tuning Mode] button.

**2**

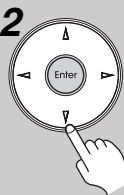

Use the Left and Right [◀]/[▶] buttons to select a category, and use the Up and Down [▲]/[▼] buttons to select a channel in that category.

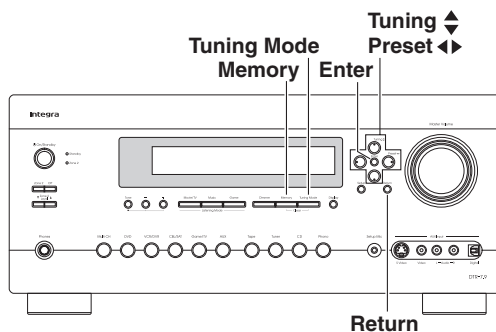

## ■ Direct Tuning

You can select a SIRIUS Satellite Radio channel directly by entering its number.

**1**

Remote controller



Press the [Tuner] button, followed by the [D.TUN] button.

SR

**2**



Within 8 seconds, use the number buttons to enter the channel number.

For example, to select channel #20, press 0, 2, 0, or 2, 0, [Enter].

**Note:**

While the [Tuner] button is flashing, you cannot select another input source with the remote controller.

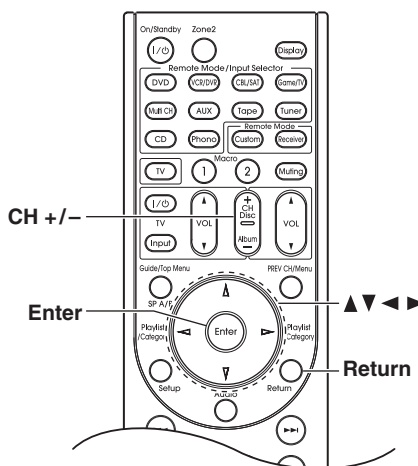

Selecting Channels on the AV receiver:

**1**

AV receiver



Press the [Tuning Mode] button repeatedly to select Channel Search mode or Category Search mode.

**2**

AV receiver



Press the [Enter] button repeatedly to select a category.

**3**

AV receiver



Use the Tuning Up and Down [▲]/[▼] buttons to select a channel.



In Channel Search mode, you can select any channel.

In Category Search mode, you can only select channels from the currently selected category.

### Notes:

- If you select an unavailable channel, “INVALID CHANNEL” appears on the display.
- If you select a channel that you are not subscribed to, “CALL SIRIUS” appears on the display.
- Channels that are locked must be unlocked before you can listen to them. See “Parental Lock” on page 71 for more information.

## Selecting the Previous Channel:



 <p>AV receiver Return</p>	<p>To listen to the previously selected SIRIUS Satellite Radio channel, press the [Return] button.</p>
 <p>Remote controller Return</p>	

## Presetting SIRIUS Channels

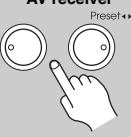
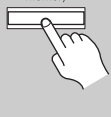
You can store a combination of up to 40 of your favorite SIRIUS Satellite Radio channels and AM/FM radio stations as presets.

<b>1</b>	<p><b>Tune into the SIRIUS channel that you want to store as a preset.</b></p>
<b>2</b>	<p><b>Press the [Memory] button.</b> The preset number flashes.</p>  <p>AV receiver Memory</p>
<b>3</b>	<p><b>While the preset number is flashing (about 8 seconds), use the Preset [◀]/[▶] buttons to select a preset from 1 through 40.</b></p>  <p>AV receiver Preset ◀▶</p>
<b>4</b>	<p><b>Press the [Memory] button again to store the channel.</b> The channel is stored and the preset number stops flashing. Repeat this procedure for all of your favorite SIRIUS Satellite Radio channels.</p>  <p>AV receiver Memory</p>

## Selecting Presets

 <p>AV receiver Preset ◀▶</p>	<p>To select a preset, use the Preset [◀]/[▶] buttons, or the remote controller's CH [+/-] button.</p>
 <p>Remote controller CH Disc Album</p>	

## Deleting Presets

<b>1</b>	<p><b>Select the preset that you want to delete.</b> See the previous section.</p>
<b>2</b>	<p><b>While holding down the [Memory] button, press the [Tuning Mode] button.</b> The preset is deleted and its number disappears from the display.</p>  <p>AV receiver Memory Tuning Mode</p>

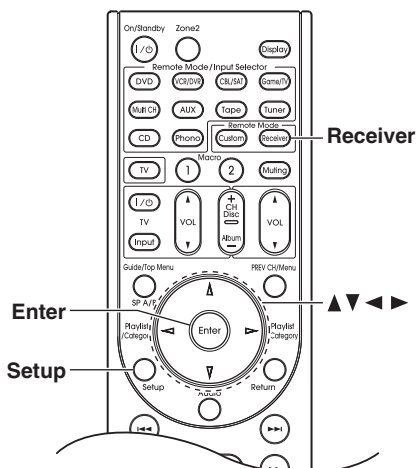

## Parental Lock

With SIRIUS Parental Lock, you can lock out channels that you do not want to receive and use a 4-digit PIN number to prevent others from unlocking them.



**1** Press the [Receiver] button, followed by the [Setup] button. The main menu appears onscreen.

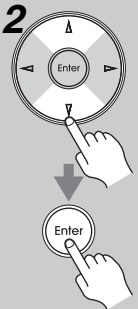

**2** Use the Up and Down [▲]/[▼] buttons to select “7. Hardware Setup”, and then press [Enter]. The “Hardware Setup” menu appears.

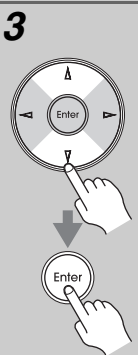
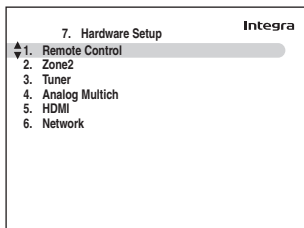

**3** Use the Up and Down [▲]/[▼] buttons to select “3. Tuner”, and then press [Enter]. The “Tuner” screen appears.

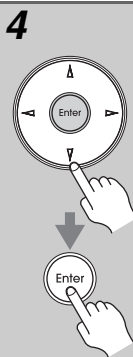
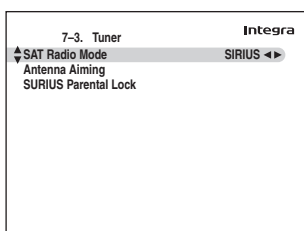

**4** Use the Left and Right [◀]/[▶] buttons to select “SIRIUS”. Use the Up and Down [▲]/[▼] buttons to select “SIRIUS Parental Lock”, and then press [Enter]. The “SIRIUS Parental Lock” screen appears.

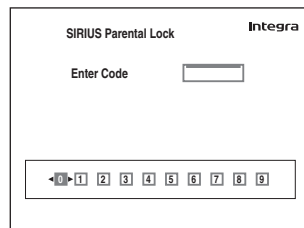

**Note:** If the SAT Radio Mode is set to “None” or “XM” (see page 67), the “SIRIUS Parental Lock” item is not available.

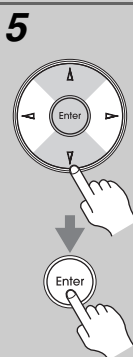

**5** Use the Left and Right [◀]/[▶] buttons to select a number on the screen, and then press [Enter]. Repeat this for each of the four digits in the PIN number. If you’re entering the PIN number for the very first time, the PIN is stored, and the following screen appears.

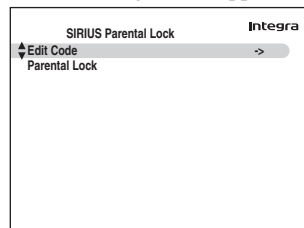

If you’ve already set a PIN number, you must enter the correct PIN to get to this screen. If you enter the wrong PIN, the message “Wrong Code!” appears and you’ll have to enter the PIN again.

**Note:** The SIRIUS Parental Lock cannot be set unless the SiriusConnect receiver is connected to the AV receiver.

**6** Use the Up and Down [▲]/[▼] buttons to select “Parental Lock”, and then press [Enter].  
The “Parental Lock” screen appears.

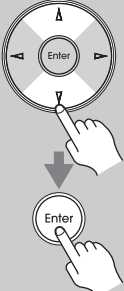

**7** Use the Up and Down [▲]/[▼] buttons to select a channel, and use the Left and Right [◀]/[▶] buttons to select Locked or Unlocked.  
The number, name, and status of the currently selected channel is displayed.

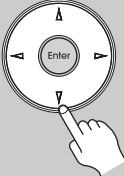

**8** When you’ve finished, press [Enter] to save your changes, or press [Return] to return to the previous screen without saving.  
When [Enter] is pressed, the confirmation message “Locked” or “Unlocked” appears.



**9** Press the [Setup] button.  
The setup menu closes.



**Notes:**

- While a channel is locked, it cannot be selected for listening.
- To unlock a channel, you must enter the correct PIN number and change it to Unlocked in step 6.

### Changing the PIN Number

**1** Press the [Receiver] button, followed by the [Setup] button.  
The main menu appears onscreen.

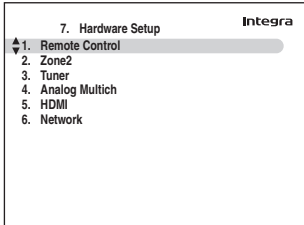

**2** Use the Up and Down [▲]/[▼] buttons to select “7. Hardware Setup”, and then press [Enter].  
The Hardware Setup menu appears.

**3** Use the Up and Down [▲]/[▼] buttons to select “3. Tuner”, and then press [Enter].  
The “Tuner” screen appears.

**4** Use the Left and Right [◀]/[▶] buttons to select “SIRIUS”.  
Use the Up and Down [▲]/[▼] buttons to select “SIRIUS Parental Lock”, and then press [Enter].  
The “SIRIUS Parental Lock” screen appears.

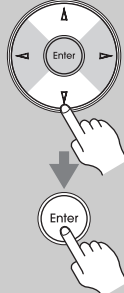
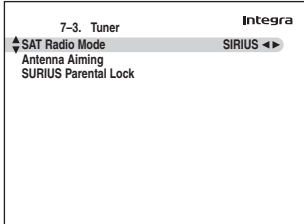
**Note:**  
If the SAT Radio Mode is set to “None” or “XM” (see page 67), the “SIRIUS Parental Lock” item is not available.

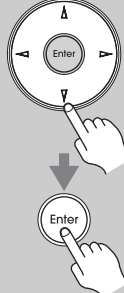
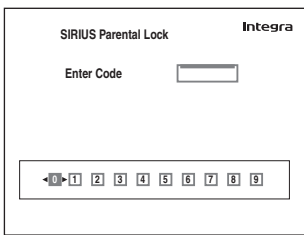

**5**



Use the Left and Right [◀]/[▶] buttons to select a number on the screen, and then press [Enter]. Repeat this for each of the four digits in the PIN number.

If you're entering the PIN number for the very first time, the PIN is stored, and the following screen appears.

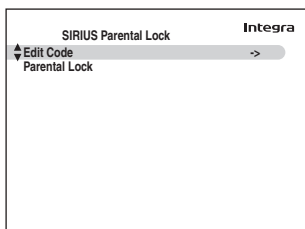

If you've already set a PIN number, you must enter the correct PIN to get to this screen. If you enter the wrong PIN, the message "Wrong Code!" appears and you'll have to enter the PIN again.

**Note:**

The SIRIUS Parental Lock cannot be set unless the SiriusConnect receiver is connected to the AV receiver.

**6**

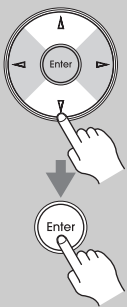

Use the Up and Down [▲]/[▼] buttons to select "Edit Code", and then press [Enter].

The "New Code" screen appears.

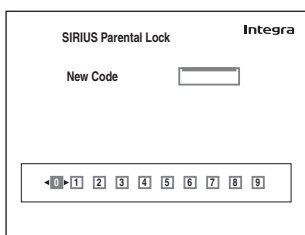

**7**

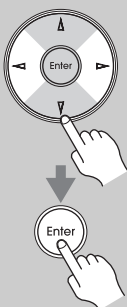

Use the Left and Right [◀]/[▶] buttons to select a number on the screen, and then press [Enter]. Repeat this for each of the four digits in the new PIN number.

The "Confirm" screen appears.

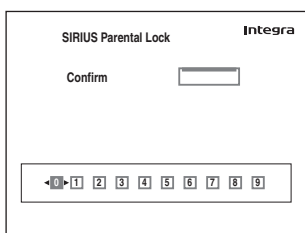

**8**

Confirm the new PIN number by entering it again.

If you confirm the PIN number correctly, the new PIN is saved and the message "Complete" appears.

If you confirm the PIN number incorrectly, "Wrong Code!" appears, and you'll be returned to step 5 to try again.

**9**



Press the [Setup] button.

The setup menu closes.

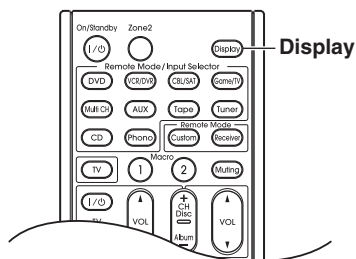

## Displaying SIRIUS Satellite Radio Information

AV receiver



Remote controller

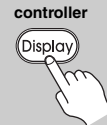

Press the [Display] button repeatedly to cycle through the available information.

The following information can be displayed:

- Channel name
- ↓
- Category
- ↓
- Artist/composer
- ↓
- Song title
- ↓
- Listening mode

**Note:**

If the category, artist/composer, or song title is not available, "--" will be displayed instead.

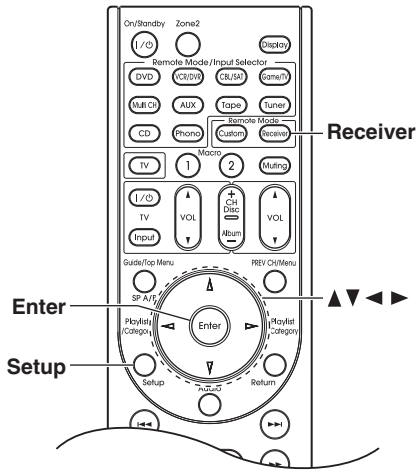

## Positioning the SiriusConnect Home antenna

You can check the strength of the SIRIUS Satellite Radio signal and adjust the position of the SiriusConnect Home antenna accordingly.

**1** Press the [Receiver] button, followed by the [Setup] button. The main menu appears onscreen.

**2** Use the Up and Down [▲]/[▼] buttons to select “7. Hardware Setup”, and then press [Enter]. The “Hardware Setup” menu appears.

Integra

7. Hardware Setup

- ▲ 1. Remote Control
- ▼ 2. Zone2
- 3. Tuner
- 4. Analog Multich
- 5. HDMI
- 6. Network

**3** Use the Up and Down [▲]/[▼] buttons to select “3. Tuner”, and then press [Enter].

The “Tuner” screen appears.

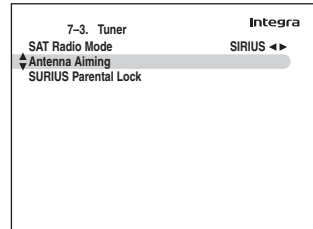
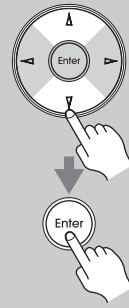

**4** Use the Up and Down [▲]/[▼] buttons to select “Antenna Aiming”, and then press [Enter].

The “Antenna Aiming” screen appears.

**Note:**

If the SAT Radio Mode is set to “None” (see page 67), the “Antenna Aiming” item is not available.



**5** Position the SiriusConnect Home antenna so that as many bars as possible (up to 3) appear on the SIRIUS Satellite signal strength meter.

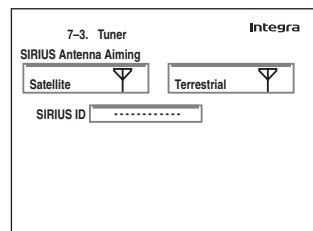

If you cannot receive a satellite signal, position the SiriusConnect Home antenna so that as many bars as possible (up to 3) appear on the SIRIUS Terrestrial signal strength meter.

### Notes:

- So long as the signal strength is good, you can enjoy SIRIUS Satellite Radio by using either satellite or terrestrial reception.
- Terrestrial signals are only available in certain areas.
- The SIRIUS information is only displayed when the SAT Radio Mode is set to “SIRIUS” or “XM/SIRIUS” (see page 67).
- If you’re using both XM Satellite Radio and SIRIUS Satellite Radio and the SAT Radio Mode is set to “XM/SIRIUS” (see page 67), signal strength meters for both systems appear on the same screen.

### **SIRIUS Satellite Radio Messages**

---

The following messages may appear while using SIRIUS Satellite Radio.

❑ **ACQUIRING**

The SiriusConnect receiver is acquiring the signal or no signal is present. Make sure the SiriusConnect Home tuner is connected properly and that there are no obstacles close by.

❑ **ANTENNA ERROR**

Make sure the SiriusConnect Home tuner is connected properly.

❑ **SUB UPDATED**

Displayed while your subscription is being updated. No operations can be performed until this message has cleared.

❑ **UPDATING XXX%**

Displayed while the channel map is being updated. Wait until the updating is complete.

❑ **UPDATING**

Displayed while the SiriusConnect receiver's firmware is being updated.

❑ **INVALID CHANNEL**

Displayed if you select an unavailable channel.

❑ **CALL SIRIUS**

Displayed when you select a channel to which you are not subscribed. Call SIRIUS if you want to subscribe.

❑ **CHECK SR TUNER**

Displayed if the SiriusConnect receiver is not connected. Make sure the SiriusConnect receiver is connected properly, and make sure its AC adapter is plugged in.

### Using RDS (not North American model)

RDS only works in areas where RDS broadcasts are available.

When tuned into an RDS station, the RDS indicator appears.

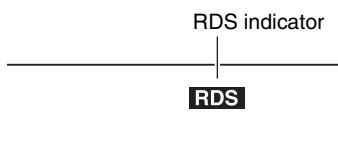

#### ■ What is RDS?

RDS stands for *Radio Data System* and is a method of transmitting data in FM radio signals. It was developed by the European Broadcasting Union (EBU) and is available in most European countries. Many FM stations use it these days. In addition to displaying text information, RDS can also help you find radio stations by type (e.g., news, sport, rock, etc.).

The AV receiver supports four types of RDS information:

#### PS (Program Service)

When tuned to an RDS station that's broadcasting PS information, the station's name will be displayed. Pressing the [Display] button will display the frequency for 3 seconds.

#### RT (Radio Text)

When tuned to an RDS station that's broadcasting text information, the text will be shown on the display (see page 77).

#### PTY (Program Type)

This allows you to search for RDS radio stations by type (see page 77).

#### TP (Traffic Program)

This allows you to search for RDS radio stations that broadcast traffic information (see page 77).

#### Notes:

- In some cases, the text characters displayed on the AV receiver may not be identical to those broadcast by the radio station. Also, unexpected characters may be displayed when unsupported characters are received. This is not a malfunction.
- If the signal from an RDS station is weak, RDS data may be displayed intermittently or not at all.

### RDS Program Types (PTY)

Type	Display
None	None
News reports	News
Current affairs	Affairs
Information	Info
Sport	Sport
Education	Educate
Drama	Drama
Culture	Culture
Science and technology	Science
Varied	Varied
Pop music	Pop M
Rock music	Rock M
Middle of the road music	Easy M
Light classics	Light M
Serious classics	Classics
Other music	Other M
Weather	Weather
Finance	Finance
Children's programmes	Children
Social affairs	Social
Religion	Religion
Phone in	Phone In
Travel	Travel
Leisure	Leisure
Jazz music	Jazz
Country music	Country
National music	Nation M
Oldies music	Oldies
Folk music	Folk M
Documentary	Document
Alarm test	TEST
Alarm	Alarm!

## Listening to the Radio—Continued

When tuned to an RDS station that's broadcasting text information, the text can be displayed.

### Displaying Radio Text (RT)

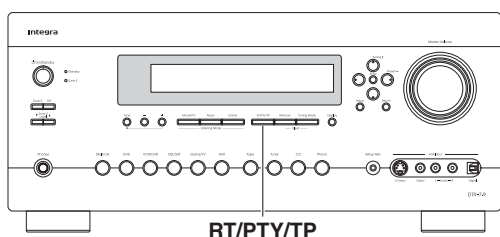

RT/PTY/TP

**Press the [RT/PTY/TP] button once.**

The RT information scrolls across the display.

#### Notes:

- The message "Waiting" may appear while the AV receiver waits for the RT information.
- If the message "No Text Data" appears on the display, no RT information is available.

### Finding Stations by Type (PTY)

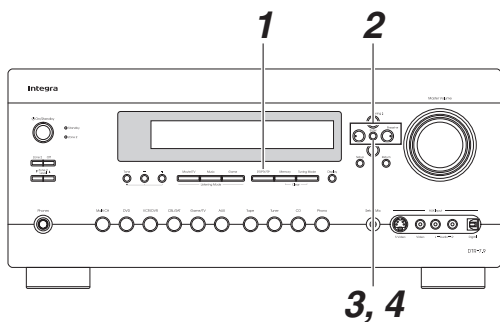

You can search for radio stations by type.

**1**

**Press the [RT/PTY/TP] button twice.**

The current program type appears on the display.

**2**

**Use the Preset [◀]/[▶] buttons to select the type of program you want.**

See the table on page 76.

**3**



**To start the search, press [Enter].**

The AV receiver searches until it finds a station of the type you specified, at which point it stops briefly before continuing with the search.

**4**



**When a station you want to listen to is found, press [Enter].**

If no stations are found, the message "Not Found" appears.

### Listening to Traffic News (TP)

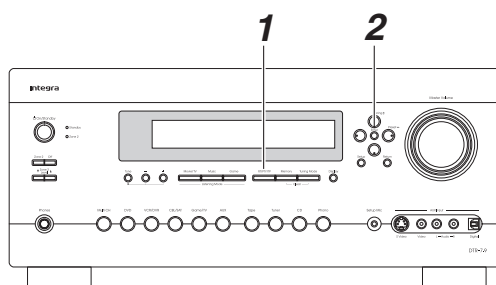

You can search for stations that broadcast traffic news.

**1**



**Press the [RT/PTY/TP] button three times.**

If the current radio station is broadcasting TP (Traffic Program), "[TP]" will appear on the display, and traffic news will be heard as and when it's broadcast. If "TP" without square brackets appears, this means that the station is not broadcasting TP.

**2**



**To locate a station that is broadcasting TP, press [Enter].**

The AV receiver searches until it finds a station that's broadcasting TP.

If no stations are found, the message "Not Found" appears.

# Recording

This section explains how to record the selected input source to a component with recording capability, and how to record audio and video from different sources.

## Notes:

- The surround sound and DSP listening modes cannot be recorded.
- Copy-protected DVDs cannot be recorded.
- You cannot record from the DVD analog multichannel input.
- Various restrictions apply to digital recording. Refer to the manuals supplied with your digital recording equipment for more details.
- Digital input signals are output by only the digital outputs, and analog input signals are output by only the analog outputs. There is no internal conversion from digital to analog or vice versa.
- DTS signals will be recorded as noise, so don't attempt analog recording of DTS CDs or LDs.

## AV Recording

Audio sources can be recorded to a recorder (e.g., cassette deck, CDR, MD) connected to the TAPE OUT, DIGITAL OPTICAL OUT or DIGITAL COAXIAL OUT jacks. Video sources can be recorded to a video recorder (e.g., VCR, DVD recorder) connected to the VCR/DVR OUT jack. See pages 22 to 38 for hookup information.

<b>1</b>	<p><b>Use the input selector buttons to select the source that you want to record.</b></p> <p>You can watch the source while recording. The AV receiver's Master Volume control has no effect on recording.</p>
<b>2</b>	<p><b>On your recorder, start recording.</b></p>
<b>3</b>	<p><b>On the source component, start playback.</b></p> <p>If you select another input source during recording, that input source will be recorded.</p>



## Recording Separate AV Sources

Here you can record audio and video from completely separate sources, allowing you to overdub audio onto your video recordings. This function takes advantage of the fact that when an audio-only input source (i.e., Tape, Tuner, CD or Phono) is selected, the video input source remains unchanged.

In the following example, audio from the CD player connected to the CD IN, and video from the camcorder connected to the AUX INPUT VIDEO jack are recorded by the VCR connected to the VCR/DVR OUT jacks.

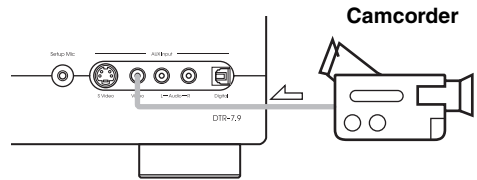

↗ : video signal  
↘ : audio signal

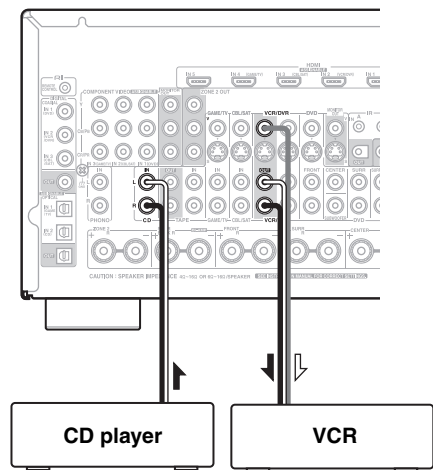

- 1 Prepare the camcorder and CD player for playback.**
- 2 Prepare the VCR for recording.**
- 3 Press the [AUX] input selector button.**
- 4 Press the [CD] input selector button.**  
This selects the CD player as the audio source, but leaves the camcorder as the video source.
- 5 Start recording on the VCR and start playback on the camcorder and CD player.**  
The video from the camcorder and the audio from the CD player are recorded by the VCR.

# Using the Listening Modes

## Selecting Listening Modes

See “About the Listening Modes” on page 86 for detailed information about the listening modes.

- The Dolby Digital and DTS listening modes can only be selected if your DVD player is connected to the AV receiver with a digital audio connection (coaxial, optical, or HDMI).
- The listening modes you can select depends on the format of the input signal. To check the format, see “Displaying Source Information” on page 55.
- While a pair of headphones is connected, you can only select the Mono, Direct, or Stereo listening mode.

## Selecting on the AV receiver

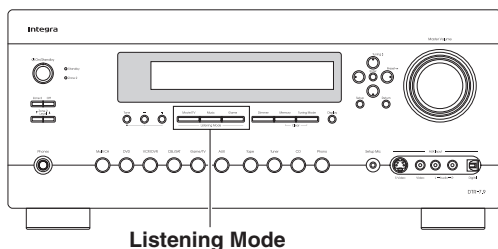

### ■ Listening Mode buttons

#### [Movie/TV] button

This button selects the listening modes intended for use with movies and TV.

#### [Music] button

This button selects the listening modes intended for use with music.

#### [Game] button

This button selects the listening modes intended for use with video games.

## Selecting with the Remote Controller

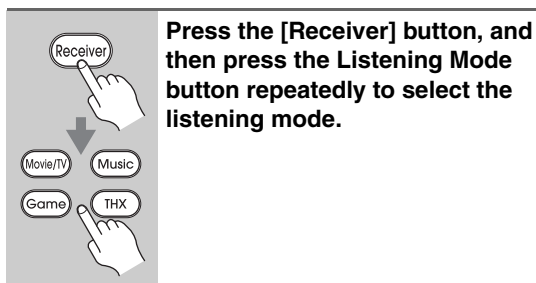
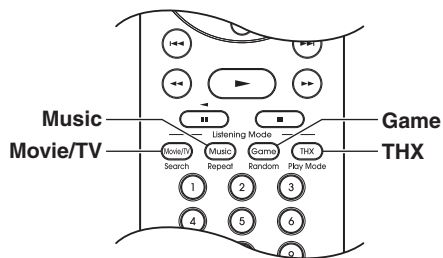

Press the [Receiver] button, and then press the Listening Mode button repeatedly to select the listening mode.

### ■ Listening Mode buttons

#### [Movie/TV] button

This button selects the listening modes intended for use with movies and TV.

#### [Music] button

This button selects the listening modes intended for use with music.

#### [Game] button

This button selects the listening modes intended for use with video games.

#### [THX] button

This button selects the THX listening modes.

**Listening Modes Available for Each Source Format**

**Analog and PCM Sources**

✓: Available Listening Modes

Source format	Analog/PCM		Multi channel Analog	Multichannel PCM					
	32–96 kHz <sup>*1</sup>	176.4/192kHz <sup>*2</sup>		32–96 kHz <sup>*1</sup>			176.4/192 kHz <sup>*2</sup>		
				Multi channel	2ch	Mono/Multiplex	Multi channel	2ch	Mono/Multiplex
Media	CD, TV, radio,		DVD	DVD			DVD		
Listening Mode									
Direct	✓	✓	✓	✓	✓	✓	✓	✓	✓
Stereo	✓	✓		✓	✓	✓	✓	✓	✓
Mono	✓			✓	✓	✓			
Multichannel			✓	✓			✓		
Neo:6				✓ <sup>*4</sup>					
Dolby PLII Movie/ Dolby PLIIx Movie <sup>*3</sup>	✓			✓ <sup>*4</sup>	✓				
Dolby PLII Music/ Dolby PLIIx Music <sup>*3</sup>	✓			✓ <sup>*4</sup>	✓				
Dolby PLII Game/ Dolby PLIIx Game <sup>*3</sup>	✓				✓				
Dolby EX				✓ <sup>*4</sup>					
Neo:6 Cinema	✓				✓				
Neo:6 Music	✓				✓				
THX Cinema/Music/Games <sup>*5</sup>				✓					
Dolby PLII/Dolby PLIIx Movie + THX Cinema <sup>*5</sup>	✓ <sup>*3</sup>			✓ <sup>*4</sup>	✓ <sup>*3</sup>				
Dolby PLII/Dolby PLIIx Music + THX Music <sup>*5</sup>	✓ <sup>*3</sup>			✓ <sup>*4</sup>	✓ <sup>*3</sup>				
Dolby PLII/Dolby PLIIx Games + THX Games <sup>*5</sup>	✓ <sup>*3</sup>				✓ <sup>*3</sup>				
Neo:6 Cinema/Music + THX Cinema/Music <sup>*5</sup>	✓			✓ <sup>*4</sup>	✓				
PLII Game + THX Ultra2 Cinema	✓				✓				
THX Surround EX				✓ <sup>*4</sup>					
THX Ultra2 Cinema/Music/Games				✓ <sup>*4</sup>					
Neo:6 + THX Games				✓ <sup>*4</sup>					
MonoMovie <sup>*5*6</sup>	✓			✓	✓	✓			
Orchestra <sup>*5*6</sup>	✓			✓	✓	✓			
Unplugged <sup>*5*6</sup>	✓			✓	✓	✓			
Studio-Mix <sup>*5*6</sup>	✓			✓	✓	✓			
TV Logic <sup>*5*6</sup>	✓			✓	✓	✓			
AllChStereo	✓			✓	✓	✓			
FullMono	✓			✓	✓	✓			
T-D <sup>*6</sup>	✓			✓	✓	✓			

\*1. 32/44.1/48/88.2/96kHz

\*2. DVD-Audio discs output multichannel 176.4/192 kHz PCM only via HDMI.

\*3. If there are no surround back speakers, or Powered Zone 2 is being used, Dolby Pro Logic II is used.

\*4. Cannot be selected with some source formats.

\*5. Available only when using surround speakers.

\*6. PCM of 88.2kHz and 96kHz are processed at 44.1kHz and 48kHz respectively.

■ : Requires 6.1/7.1 speakers. Not available while Powered Zone 2 is being used.

■ : Requires 7.1 speakers. Not available while Powered Zone 2 is being used.



## Using the Listening Modes—Continued

### Dolby Digital, and Dolby Digital Plus Sources

✓: Available Listening Modes

Source format	Dolby Digital			Dolby Digital Plus		
	Multichannel	2ch	Mono/Multiplex	Multichannel	2ch	Mono/Multiplex
<b>Media</b>	DVD, DTV, etc.			Blu-ray, HD DVD		
<b>Listening Mode</b>	DVD, DTV, etc.			Blu-ray, HD DVD		
Direct	✓	✓	✓	✓	✓	✓
Stereo	✓	✓	✓	✓	✓	✓
Mono	✓	✓	✓	✓	✓	✓
Neo:6	✓ <sup>*3</sup>			✓ <sup>*3</sup>		
DolbyDigital	✓					
DolbyDigital Plus				✓ <sup>*1</sup>		
Dolby PLII Movie/ Dolby PLIIx Movie <sup>*2</sup>	✓ <sup>*3</sup>	✓		✓ <sup>*3</sup>	✓	
Dolby PLII Music/ Dolby PLIIx Music <sup>*2</sup>	✓ <sup>*3</sup>	✓		✓ <sup>*3</sup>	✓	
Dolby PLII Game/ Dolby PLIIx Game <sup>*2</sup>		✓			✓	
Dolby EX	✓ <sup>*3</sup>			✓ <sup>*3</sup>		
Neo:6 Cinema		✓			✓	
Neo:6 Music		✓			✓	
THX Cinema/Music/Games <sup>*4</sup>	✓			✓		
Dolby PLII/Dolby PLIIx Movie + THX Cinema <sup>*4</sup>	✓ <sup>*3</sup>	✓ <sup>*2</sup>		✓ <sup>*3</sup>	✓ <sup>*2</sup>	
Dolby PLII/Dolby PLIIx Music + THX Music <sup>*4</sup>	✓ <sup>*3</sup>	✓ <sup>*2</sup>		✓ <sup>*3</sup>	✓ <sup>*2</sup>	
Dolby PLII/Dolby PLIIx Game + THX Games <sup>*4</sup>		✓ <sup>*2</sup>			✓ <sup>*2</sup>	
Neo:6 Cinema/Music + THX Cinema/Music <sup>*4</sup>	✓ <sup>*3</sup>	✓		✓ <sup>*3</sup>	✓	
PLII Game + THX Ultra2 Cinema		✓			✓	
THX Surround EX	✓ <sup>*3</sup>			✓ <sup>*3</sup>		
THX Ultra2 Cinema/Music/Games	✓ <sup>*3</sup>			✓ <sup>*3</sup>		
Neo:6 + THX Games	✓ <sup>*3</sup>			✓ <sup>*3</sup>		
MonoMovie <sup>*4</sup>	✓	✓	✓	✓	✓	✓
Orchestra <sup>*4</sup>	✓	✓	✓	✓	✓	✓
Unplugged <sup>*4</sup>	✓	✓	✓	✓	✓	✓
Studio-Mix <sup>*4</sup>	✓	✓	✓	✓	✓	✓
TV Logic <sup>*4</sup>	✓	✓	✓	✓	✓	✓
AllChStereo	✓	✓	✓	✓	✓	✓
FullMono	✓	✓	✓	✓	✓	✓
T-D	✓	✓	✓	✓	✓	✓

\*1. If there are no surround back speakers, depending on the input signal, Dolby Digital may be used.

\*2. If there are no surround back speakers, or Powered Zone 2 is being used, Dolby Pro Logic II is used.

\*3. Cannot be selected with some source formats.

\*4. Available only when using surround speakers.

■ : Requires 6.1/7.1 speakers. Not available while Powered Zone 2 is being used.

■ : Requires 7.1 speakers. Not available while Powered Zone 2 is being used.

#### Note:

With some HD DVD and Blu-ray discs, a noise may be heard during playback. This may occur when the audio format changes during playback. It is not a malfunction.

## Using the Listening Modes—Continued

### DTS Sources

✓: Available Listening Modes

Source format	DTS, DTS96/24			DTS-ES Discrete/Matrix
	Multichannel	2ch	Mono	
Media	DVD, CD, etc.			DVD, CD, etc.
Listening Mode	DVD, CD, etc.			DVD, CD, etc.
Direct	✓	✓	✓	✓
Stereo	✓	✓	✓	✓
Mono	✓	✓	✓	✓
DTS, DTS 96/24	✓			✓
DTS-ES Discrete/Matrix				✓ <sup>*1</sup>
Neo:6	✓ <sup>*3</sup>			
Dolby PLII Movie/ Dolby PLIIx Movie <sup>*2</sup>	✓ <sup>*3</sup>	✓		
Dolby PLII Music/ Dolby PLIIx Music <sup>*2</sup>	✓ <sup>*3</sup>	✓		
Dolby PLII Game/ Dolby PLIIx Game <sup>*2</sup>		✓		
Dolby EX	✓ <sup>*3</sup>			
Neo:6 Cinema		✓		
Neo:6 Music		✓		
THX Cinema/Music/Games <sup>*4</sup>	✓			✓
Dolby PLII/Dolby PLIIx Movie + THX Cinema <sup>*4</sup>	✓ <sup>*3</sup>	✓ <sup>*2</sup>		
Dolby PLII/Dolby PLIIx Music + THX Music <sup>*4</sup>	✓ <sup>*3</sup>	✓ <sup>*2</sup>		
Dolby PLII/Dolby PLIIx Game + THX Games <sup>*4</sup>		✓ <sup>*2</sup>		
Neo:6 Cinema/Music + THX Cinema/Music <sup>*4</sup>	✓ <sup>*3</sup>	✓		
PLII Game + THX Ultra2 Cinema		✓		
THX Surround EX	✓ <sup>*3</sup>			
THX Ultra2 Cinema/Music/Games	✓ <sup>*3</sup>			
Neo:6 + THX Games	✓ <sup>*3</sup>			
MonoMovie <sup>*4 *5</sup>	✓	✓	✓	✓
Orchestra <sup>*4*5</sup>	✓	✓	✓	✓
Unplugged <sup>*4*5</sup>	✓	✓	✓	✓
Studio-Mix <sup>*4*5</sup>	✓	✓	✓	✓
TV Logic <sup>*4*5</sup>	✓	✓	✓	✓
AllChStereo	✓	✓	✓	✓
FullMono	✓	✓	✓	✓
T-D <sup>*5</sup>	✓	✓	✓	✓

\*1. If there are no surround back speakers, or Powered Zone 2 is being used, DTS is used.

\*2. If there are no surround back speakers, or Powered Zone 2 is being used, Dolby Pro Logic II is used.

\*3. Cannot be selected with some source formats.

\*4. Available only when using surround speakers.

\*5. DTS 96/24 is processed as DTS.

■ : Requires 6.1/7.1 speakers. Not available while Powered Zone 2 is being used.

■ : Requires 7.1 speakers. Not available while Powered Zone 2 is being used.

## Using the Listening Modes—Continued

### TrueHD Sources

✓: Available Listening Modes

Source format	TrueHD			TrueHD 192kHz		
	Multichannel	2ch	Mono/Multiplex	Multichannel	2ch	Mono/Multiplex
<b>Media</b>	Blu-ray, HD DVD			Blu-ray, HD DVD		
<b>Listening Mode</b>	Blu-ray, HD DVD			Blu-ray, HD DVD		
Direct	✓	✓	✓	✓	✓	✓
Stereo	✓	✓	✓	✓	✓	✓
Mono	✓	✓	✓			
TrueHD	✓			✓		
Neo:6	✓*2					
Dolby PLII Movie/ Dolby PLIIx Movie*1	✓*2	✓				
Dolby PLII Music/ Dolby PLIIx Music*1	✓*2	✓				
Dolby PLII Game/ Dolby PLIIx Game*1		✓				
Dolby EX	✓*2					
Neo:6 Cinema		✓				
Neo:6 Music		✓				
THX Cinema/Music/Games*3	✓					
Dolby PLII/Dolby PLIIx Movie + THX Cinema*3	✓*2	✓*1				
Dolby PLII/Dolby PLIIx Music + THX Music*3	✓*2	✓*1				
Dolby PLII/Dolby PLIIx Game + THX Games*3		✓*1				
Neo:6 Cinema/Music + THX Cinema/Music*3	✓*2	✓				
PLII Game + THX Ultra2 Cinema		✓				
THX Surround EX	✓*2					
THX Ultra2 Cinema/Music/Games	✓*2					
Neo:6 + THX Games	✓*2					
MonoMovie*3	✓	✓	✓			
Orchestra*3	✓	✓	✓			
Unplugged*3	✓	✓	✓			
Studio-Mix*3	✓	✓	✓			
TV Logic*3	✓	✓	✓			
AllChStereo	✓	✓	✓			
FullMono	✓	✓	✓			
T-D	✓	✓	✓			

\*1. If there are no surround back speakers, or Powered Zone 2 is being used, Dolby Pro Logic II is used.

\*2. Cannot be selected with some source formats.

\*3. Available only when using surround speakers.

■ : Requires 6.1/7.1 speakers. Not available while Powered Zone 2 is being used.

■ : Requires 7.1 speakers. Not available while Powered Zone 2 is being used.

#### Note:

With some HD DVD and Blu-ray discs, a noise may be heard during playback. This may occur when the audio format changes during playback. It is not a malfunction.

# Using the Listening Modes—Continued

## DTS-HD Sources

✓: Available Listening Modes

Source format	DTS-HD High Resolution			DTS-HD Master Audio			DTS-HD Master Audio 192kHz		
	Multi channel	2ch	Mono	Multi channel	2ch	Mono	Multi channel	2ch	Mono
<b>Media</b>	Blu-ray, HD DVD			Blu-ray, HD DVD			Blu-ray, HD DVD		
<b>Listening Mode</b>	Blu-ray, HD DVD			Blu-ray, HD DVD			Blu-ray, HD DVD		
Direct	✓	✓	✓	✓	✓	✓	✓	✓	✓
Stereo	✓	✓	✓	✓	✓	✓	✓	✓	✓
Mono	✓	✓	✓	✓	✓	✓			
DTS-HD High Resolution	✓								
DTS-HD Master Audio				✓			✓		
Neo:6	✓ <sup>*2</sup>			✓ <sup>*2</sup>					
Dolby PLII Movie/ Dolby PLIIx Movie <sup>*1</sup>	✓ <sup>*2</sup>	✓		✓ <sup>*2</sup>	✓				
Dolby PLII Music/ Dolby PLIIx Music <sup>*1</sup>	✓ <sup>*2</sup>	✓		✓ <sup>*2</sup>	✓				
Dolby PLII Game/ Dolby PLIIx Game <sup>*1</sup>		✓			✓				
Dolby Digital EX/Dolby EX	✓ <sup>*2</sup>			✓ <sup>*2</sup>					
Neo:6 Cinema		✓			✓				
Neo:6 Music		✓			✓				
THX Cinema/Music/Games <sup>*3</sup>	✓			✓					
Dolby PLII/Dolby PLIIx Movie + THX Cinema <sup>*3</sup>	✓ <sup>*2</sup>	✓ <sup>*1</sup>		✓ <sup>*2</sup>	✓ <sup>*1</sup>				
Dolby PLII/Dolby PLIIx Music + THX Music <sup>*3</sup>	✓ <sup>*2</sup>	✓ <sup>*1</sup>		✓ <sup>*2</sup>	✓ <sup>*1</sup>				
Dolby PLII/Dolby PLIIx Game + THX Games <sup>*3</sup>		✓ <sup>*1</sup>			✓ <sup>*1</sup>				
Neo:6 Cinema/Music + THX Cinema/Music <sup>*3</sup>	✓ <sup>*2</sup>	✓		✓ <sup>*2</sup>	✓				
PLII Game + THX Ultra2 Cinema		✓			✓				
THX Surround EX	✓ <sup>*2</sup>			✓ <sup>*2</sup>					
THX Ultra2 Cinema/Music/Games	✓ <sup>*2</sup>			✓ <sup>*2</sup>					
Neo:6 + THX Games	✓ <sup>*2</sup>			✓ <sup>*2</sup>					
MonoMovie <sup>*3</sup>	✓	✓	✓	✓	✓	✓			
Orchestra <sup>*3</sup>	✓	✓	✓	✓	✓	✓			
Unplugged <sup>*3</sup>	✓	✓	✓	✓	✓	✓			
Studio-Mix <sup>*3</sup>	✓	✓	✓	✓	✓	✓			
TV Logic <sup>*3</sup>	✓	✓	✓	✓	✓	✓			
AllChStereo	✓	✓	✓	✓	✓	✓			
FullMono	✓	✓	✓	✓	✓	✓			
T-D	✓	✓	✓	✓	✓	✓			

\*1. If there are no surround back speakers, or Powered Zone 2 is being used, Dolby Pro Logic II is used.

\*2. Cannot be selected with some source formats.

\*3. Available only when using surround speakers.

■ : Requires 6.1/7.1 speakers. Not available while Powered Zone 2 is being used.

■ : Requires 7.1 speakers. Not available while Powered Zone 2 is being used.

### Note:

With some HD DVD and Blu-ray discs, a noise may be heard during playback. This may occur when the audio format changes during playback. It is not a malfunction.

## Using the Listening Modes—Continued

### DTS Express and DSD Sources

Source format	DTS Express			DSD <sup>*1</sup>	
	Multichannel	2ch	Mono	Multichannel (3/2.1)	2ch
<b>Media</b>	Blu-ray, HD DVD			SACD	
<b>Listening Mode</b>					
Direct	✓	✓	✓	✓	✓
Stereo	✓	✓	✓	✓	✓
Mono	✓	✓	✓	✓	✓
DTS Express	✓				
DSD				✓	
Neo:6	✓ <sup>*3</sup>			✓	
Dolby PLII Movie/ Dolby PLIIx Movie <sup>*2</sup>	✓ <sup>*3</sup>	✓		✓	✓
Dolby PLII Music/ Dolby PLIIx Music <sup>*2</sup>	✓ <sup>*3</sup>	✓		✓	✓
Dolby PLII Game/ Dolby PLIIx Game <sup>*2</sup>		✓			✓
Dolby EX	✓ <sup>*3</sup>			✓	
Neo:6 Cinema		✓			✓
Neo:6 Music		✓			✓
THX Cinema/Music/Games <sup>*4</sup>	✓			✓	
Dolby PLII/Dolby PLIIx Movie + THX Cinema <sup>*4</sup>	✓ <sup>*3</sup>	✓ <sup>*2</sup>		✓	✓ <sup>*2</sup>
Dolby PLII/Dolby PLIIx Music + THX Music <sup>*4</sup>	✓ <sup>*3</sup>	✓ <sup>*2</sup>		✓	✓ <sup>*2</sup>
Dolby PLII/Dolby PLIIx Game + THX Games <sup>*4</sup>		✓ <sup>*2</sup>			✓ <sup>*2</sup>
Neo:6 Cinema/Music + THX Cinema/Music <sup>*4</sup>	✓ <sup>*3</sup>	✓		✓	✓
PLII Game + THX Ultra2 Cinema		✓			✓
THX Surround EX	✓ <sup>*3</sup>			✓	
THX Ultra2 Cinema/Music/Games	✓ <sup>*3</sup>			✓	
Neo:6 + THX Games	✓ <sup>*3</sup>			✓	
MonoMovie <sup>*4</sup>	✓	✓	✓	✓	✓
Orchestra <sup>*4</sup>	✓	✓	✓	✓	✓
Unplugged <sup>*4</sup>	✓	✓	✓	✓	✓
Studio-Mix <sup>*4</sup>	✓	✓	✓	✓	✓
TV Logic <sup>*4</sup>	✓	✓	✓	✓	✓
AllChStereo	✓	✓	✓	✓	✓
FullMono	✓	✓	✓	✓	✓
T-D	✓	✓	✓	✓	✓

\*1. DSD sources are converted and handled as PCM.

\*2. If there are no surround back speakers, or Powered Zone 2 is being used, Dolby Pro Logic II is used.

\*3. Cannot be selected with some source formats.

\*4. Available only when using surround speakers.

■ : Requires 6.1/7.1 speakers. Not available while Powered Zone 2 is being used.

■ : Requires 7.1 speakers. Not available while Powered Zone 2 is being used.



If you can select PCM or DSD output on your SACD player, in some cases, selecting PCM will provide the best sound quality.

#### Note:

With some HD DVD and Blu-ray discs, a noise may be heard during playback. This may occur when the audio format changes during playback. It is not a malfunction.

### About the Listening Modes

The AV receiver's listening modes can transform your listening room into a movie theater or concert hall, with high fidelity and stunning surround sound.

The Listening Mode button illustration shows that listening modes can be selected.

Button: 

The Listening Mode button illustration shows the remote controller buttons.

See "Selecting Listening Modes" on page 79 for information on the use of the Listening Mode buttons.

#### Direct

Button: 

In this mode, audio from the input source is output directly with minimal processing, providing high-fidelity reproduction. All of the source's audio channels are output as they are.

#### Stereo

Button: 

Sound is output by the front left and right speakers and subwoofer.

#### Mono

Button: 

Use this mode when watching an old movie with a mono soundtrack, or use it with the foreign language soundtracks recorded in the left and right channels of some movies. It can also be used with DVDs or other sources containing multiplexed audio, such as karaoke DVDs.

#### Multichannel

Button:   

This mode is for use with analog or PCM multichannel sources.

#### Dolby Pro Logic IIx

##### Dolby Pro Logic II

**Dolby Pro Logic IIx** expands any 2-channel source for 7.1-channel playback. It provides a very natural and seamless surround-sound experience that fully envelops the listener. As well as music and movies, video games can also benefit from the dramatic spatial effects and vivid imaging. If you're not using any surround back speakers, **Dolby Pro Logic II** will be used instead of Dolby Pro Logic IIx.

- **Dolby PLIIx Movie**

Button: 

Use this mode with any stereo or Dolby Surround (Pro Logic) movie (e.g., TV, DVD, VHS).

- **Dolby PLIIx Music**

Button: 

Use this mode with any stereo or Dolby Surround (Pro Logic) music source (e.g., CD, radio, cassette, TV, VHS, DVD).

- **Dolby PLIIx Game**

Button: 

Use this mode with video games, especially those that bear the Dolby Pro Logic II logo.

#### Dolby Digital

Button:   

Use this mode with DVDs that bear the Dolby Digital logo, and Dolby Digital TV broadcasts. This is the most common digital surround-sound format, and it'll put you right in the middle of the action, just like being in a movie theater or concert hall.

##### 5.1-channel source + Dolby EX

Button:   

These modes expand 5.1-channel sources for 6.1/7.1-channel playback. They're especially suited to Dolby EX soundtracks that include a matrix-encoded surround back channel. The additional channel adds an extra dimension and provides an enveloping surround sound experience, perfect for rotating and fly-by sound effects.

#### Dolby Digital Plus

Button:   

Developed for use with HDTV, including the new video disc formats Blu-ray and HD DVD, this is the latest multichannel audio format from Dolby. It supports up to 7.1 channels with 48 kHz sampling rate.

### Dolby TrueHD

Button:   

Designed to take full advantage of the additional storage space offered by the new Blu-ray and HD DVD disc formats, this new Dolby format offers up to 7.1 discrete channels of digital audio with 48/96 kHz, up to 5.1-channels with 192 kHz sampling rate.

For the signals supported by the AV receiver, see page 82.

### 5.1-channel source + Dolby PLIIx Music

Button: 

These modes use the Dolby Pro Logic IIx Music mode to expand 5.1-channel sources for 6.1/7.1-channel playback.

### 5.1-channel source + Dolby PLIIx Movie

Button: 

These modes use the Dolby Pro Logic IIx Movie mode to expand 5.1-channel sources for 7.1-channel playback.

### DTS

Button:   

The DTS digital surround-sound format supports up to 5.1 discrete channels and uses less compression for high-fidelity reproduction. Use it with DVDs and CDs that bear the DTS logo.

### DTS 96/24

Button:   

This mode is for use with DTS 96/24 sources. This is high-resolution DTS with a 96 kHz sampling rate and 24-bit resolution, providing superior fidelity. Use it with DVDs that bear the DTS 96/24 logo.

### DTS-ES Discrete

Button:   

This mode is for use with DTS-ES Discrete soundtracks, which use a discrete surround back channel for true 6.1/7.1-channel playback. The seven totally separate audio channels provide better spatial imaging and 360-degree sound localization, perfect for sounds that pan across the surround channels. Use it with DVDs that bear the DTS-ES logo, especially those with a DTS-ES Discrete soundtrack.

### DTS-ES Matrix

Button:   

This mode is for use with DTS-ES Matrix soundtracks, which use a matrix-encoded back-channel for 6.1/7.1-channel playback. Use it with DVDs that bear the DTS-ES logo, especially those with a DTS-ES Matrix soundtrack.

### DTS Neo:6

Button:   

This mode expands any 2-channel source for up to 7.1-channel playback. It uses seven full-bandwidth channels of matrix decoding for matrix-encoded material, providing a very natural and seamless surround sound experience that fully envelops the listener.

- **Neo:6 Cinema**

Use this mode with any stereo movie (e.g., TV, DVD, VHS).

- **Neo:6 Music**

Use this mode with any stereo music source (e.g., CD, radio, cassette, TV, VHS, DVD).

### 5.1-channel source + Neo:6

Button:   

This mode uses Neo:6 to expand 5.1-channel sources for 6.1/7.1-channel playback.

### DTS-HD High Resolution Audio

Button:   

Developed for use with HDTV, including the new video disc formats Blu-ray and HD DVD, this is the latest multichannel audio format from DTS. It supports up to 7.1 channels with 96 kHz sampling rate.

### DTS-HD Master Audio

Button:   

Designed to take full advantage of the additional storage space offered by the new Blu-ray and HD DVD disc formats, this new DTS format offers up to 7.1 discrete channels of digital audio with 48/96 kHz, up to 5.1-channels with 192 kHz sampling rate.

For the signals supported by the AV receiver, see page 84.

### DTS Express

Button:   

This format supports up to 5.1 channels and a lower sampling rate of 48 kHz. Applications include interactive audio and commentary encoding for HD DVD Sub Audio and Blu-ray Secondary Audio. Also broadcast and media servers.

### DSD

Button:   

DSD stands for Direct Stream Digital and is the format used to store digital audio on Super Audio CDs (SACD). This mode can be used with SACDs that feature multichannel audio.

### THX

Founded by George Lucas, THX develops stringent standards that ensure movies are reproduced in movie theaters and home theaters just as the director intended.

THX Modes carefully optimize the tonal and spatial characteristics of the soundtrack for reproduction in the home-theater environment. They can be used with 2-channel matrixed and multichannel sources.

Surround back speaker output depends on the source material and the selected listening mode.

- **THX Cinema**

Button:  

THX Cinema mode corrects theatrical soundtracks for playback in a home theater environment. In this mode, THX Loudness Plus is configured for cinema levels and Re-EQ, Timbre Matching, and Adaptive Decorrelation are active.

- **THX Music**

Button:  

THX Music mode is tailored for listening to music, which is typically mastered at significantly higher levels than movies. In this mode, THX Loudness Plus is configured for music playback and only Timbre Matching is active.

- **THX Games**

Button:  

THX Games mode is meant for spatially accurate playback of game audio, which is often mixed similarly to movies but in a smaller environment. THX Loudness Plus is configured for game audio levels, with Timbre Matching active.

- **THX Ultra2 Cinema**

Button:  

This mode expands 5.1-channel sources for 7.1-channel playback. It does this by analyzing the composition of the surround source, optimizing the ambient and directional sounds to produce the surround back channel output.

- **THX Ultra2 Music**

Button:  

This mode is designed for use with music. It expands 5.1-channel sources for 7.1-channel playback.

- **THX Ultra2 Games**

Button:  

This mode is designed for use with video games. It can expand 5.1-channel sources for 6.1/7.1-channel playback.

- **THX Surround EX**

Button:  

This mode expands 5.1-channel sources for 6.1/7.1-channel playback. It's especially suited to Dolby

Digital EX sources. THX Surround EX, also known as Dolby Digital Surround EX, is a joint development between Dolby Laboratories and THX Ltd.

### Onkyo Original DSP Modes

---

#### Mono Movie

Button: 

This mode is suitable for old movies and other mono sources. The center speaker outputs the sound as it is, while reverb is applied to the sound output by the other speakers, giving presence to even mono material.

#### Orchestra

Button: 

Suitable for classical or operatic music, this mode emphasizes the surround channels in order to widen the stereo image, and simulates the natural reverberation of a large hall.

#### Unplugged

Button: 

Suitable for acoustic instruments, vocals, and jazz, this mode emphasizes the front stereo image, giving the impression of being right in front of the stage.

#### Studio-Mix

Button: 

Suitable for rock or pop music, listening to music in this mode creates a lively sound field with a powerful acoustic image, like being at a club or rock concert.

#### TV Logic

Button: 

This mode adds realistic acoustics to TV shows produced in a TV studio, surround effects to the entire sound, and clarity to voices.

#### All Ch Stereo

Button:   



Ideal for background music, this mode fills the entire listening area with stereo sound from the front, surround, and surround back speakers.

#### Full Mono

Button:   

In this mode, all speakers output the same sound in mono, so the sound you hear is the same regardless of where you are within the listening room.

#### T-D (Theater-Dimensional)

Button:  

With this mode you can enjoy a virtual 5.1 surround sound even with only two or three speakers. This works by controlling how sounds reach the listener's left and right ears. Good results may not be possible if there's too much reverb, so we recommend that you use this mode in an environment with little or no natural reverb.



# Advanced Setup

## Onscreen Setup Menus

The onscreen setup menus appear on the connected TV and provide a convenient way to change the AV receiver's various settings. Settings are organized into eight categories on the **main menu**, most containing a **submenu**.

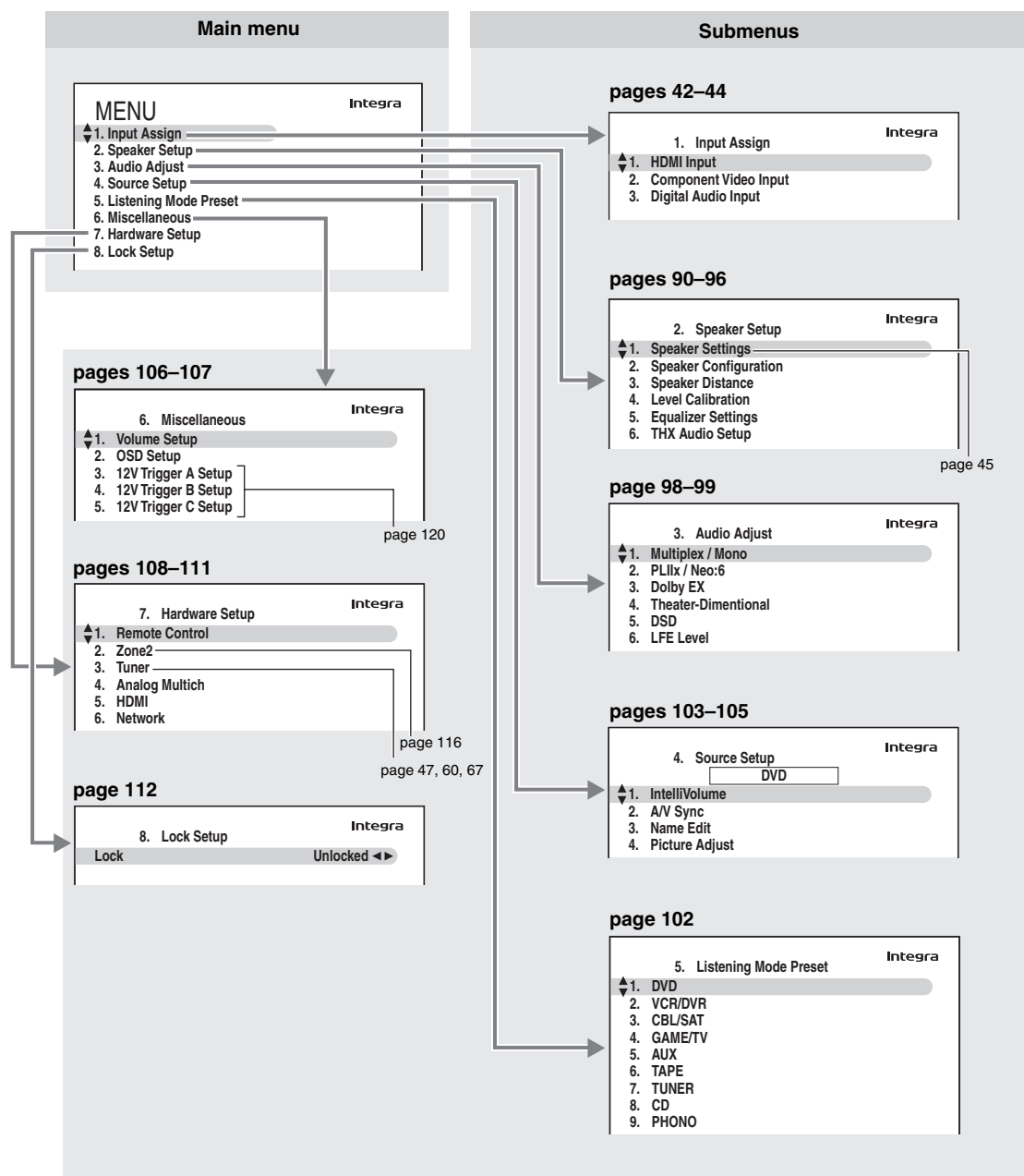

## Speaker Setup

Some of the settings in this section are set automatically by the Automatic Speaker Setup function (see page 49). Here you can check the settings made by the Automatic Speaker Setup function, or set them manually, which is useful if you change one of the connected speakers after using the Automatic Speaker Setup function.

### Note:

The Speaker Setup cannot be carried out while headphones are connected to the AV receiver.

## Speaker Settings

See “Speaker Settings” on page 45.

## Speaker Configuration

These settings are set automatically by the Automatic Speaker Setup function (see page 49).

With these settings, you can specify which speakers are connected and a crossover frequency for each speaker.

The following crossover frequencies can be specified:

“Full Band”, “40Hz”, “45Hz”, “50Hz”, “55Hz”, “60Hz”, “70Hz”, “80Hz (THX)”, “90Hz”, “100Hz”, “110Hz”, “120Hz”, “130Hz”, “150Hz”, or “200Hz”.

Specify “Full Band” for speakers that can output low-frequency bass sounds adequately, for example, speakers with a good sized woofer. For smaller speakers, specify a crossover frequency. Sounds below the crossover frequency will be output by the subwoofer instead of the speaker. Refer to your speaker’s manuals to determine the optimum crossover frequencies.

Please note that THX recommends any THX main speakers be set to “80Hz(THX)”. If you set up your speakers using the Automatic Speaker Setup function, please make sure manually that any THX speakers are set to 80 Hz (THX) crossover.

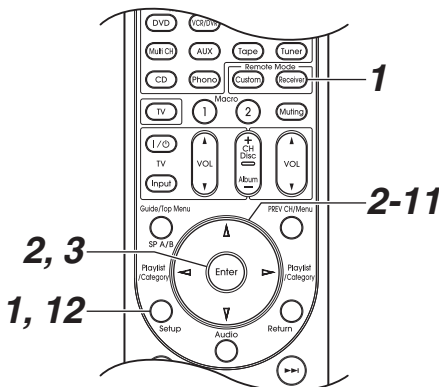

**1**



**Press the [Receiver] button followed by the [Setup] button.**

The main menu appears onscreen.

If the main menu doesn't appear, make sure the appropriate external input is selected on your TV.

**2**

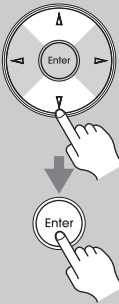

**Use the Up and Down [▲]/[▼] buttons to select “2. Speaker Setup”, and then press [Enter].**

The “Speaker Setup” menu appears.

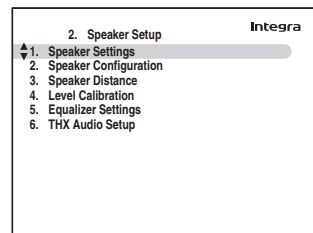

**3**

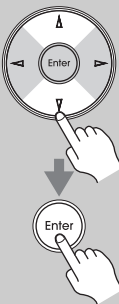

**Use the Up and Down [▲]/[▼] buttons to select “2. Speaker Configuration”, and then press [Enter].**

The “Speaker Configuration” menu appears.

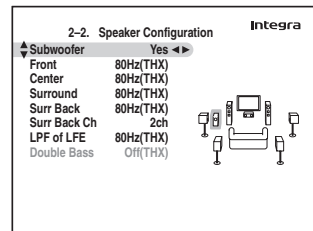

**4**

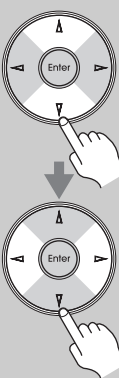

**Use the Up and Down [▲]/[▼] buttons to select “Subwoofer”, and then use the Left and Right [◀]/[▶] buttons to select:**

**Yes:** Select if a subwoofer is connected.

**No:** Select if no subwoofer is connected.

5

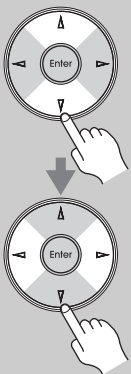

Use the Up and Down [▲]/[▼] buttons to select “Front”, and then use the Left and Right [◀]/[▶] buttons to select a crossover frequency.

**Note:**

If the “Subwoofer” setting in step 4 is set to “No”, this setting is fixed at “Full Band”.

6

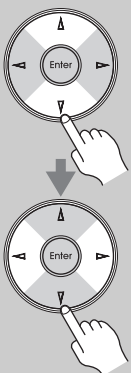

Use the Up and Down [▲]/[▼] buttons to select “Center”, and then use the Left and Right [◀]/[▶] buttons to select a crossover frequency.

If no center speaker is connected, select “None”.

**Note:**

If the “Front” setting in step 5 is set to anything other than “Full Band”, “Full Band” cannot be selected here.

7

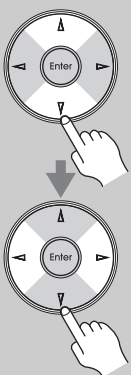

Use the Up and Down [▲]/[▼] buttons to select “Surround”, and then use the Left and Right [◀]/[▶] buttons to select a crossover frequency.

If no surround left and right speakers are connected, select “None”.

**Note:**

If the “Front” setting in step 5 is set to anything other than “Full Band”, “Full Band” cannot be selected here.

8

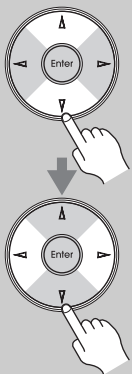

Use the Up and Down [▲]/[▼] buttons to select “Surr Back”, and then use the Left and Right [◀]/[▶] buttons to select a crossover frequency.

If no surround back speakers are connected, select “None”.

**Notes:**

- If the “Surround” setting in step 7 is set to “None”, this setting cannot be selected.
- If the “Surround” setting in step 7 is set to anything other than “Full Band”, “Full Band” cannot be selected here.
- If the “Speakers Type” setting is set to “Bi-Amp” (page 45), or Powered Zone 2 is being used (page 116), this setting cannot be selected.

9

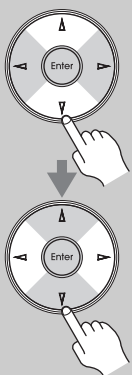

Use the Up and Down [▲]/[▼] buttons to select “Surr Back Ch”, and then use the Left and Right [◀]/[▶] buttons to select:

- 1ch:** Select if one surround back speaker is connected.
- 2ch:** Select if two (left and right) surround back speakers are connected.

**Note:**

If the “Surr Back” Setting in step 8 is set to “None”, this setting cannot be selected.

Continue with step 10 on the next page.

### Low-Pass Filter for the LFE Channel

This setting is **not** set automatically by the Automatic Speaker Setup function (see page 49).

With this setting, you can specify the cutoff frequency of the LFE channel's low-pass filter (LPF), which can be used to filter out unwanted hum. The LPF only applies to sources that use the LFE channel.

\* If you're using THX-certified speakers, select "80Hz (THX)".

**10**

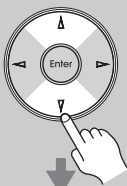

Use the Up and Down [▲]/[▼] buttons to select "LPF of LFE", and then use the Left and Right [◀]/[▶] buttons to select a low-pass filter frequency.

The following low-pass filter frequencies can be selected: "80Hz (THX)", "90Hz", "100Hz", or "120Hz".

Continue with step 11 in the next column.

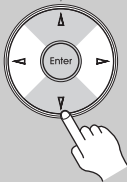

### Double Bass

This setting is **not** set automatically by the Automatic Speaker Setup function (see page 49).

With the Double Bass function, you can boost bass output by feeding bass sounds from the front left and right channels to the subwoofer. This function can be set only if the "Subwoofer" setting in step 4 is set to "Yes", and the "Front" setting in step 5 is set to "Full Band".

In the speaker setup screen, you can choose how bass information is distributed to your speakers only if you have large front left and right speakers and a subwoofer.

\* If you're using THX-certified speakers, select "Off (THX)".

**11**

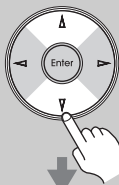

Use the Up and Down [▲]/[▼] buttons to select "Double Bass", and then use the Left and Right [◀]/[▶] buttons to select:

**On:** Double Bass function on (default). Front left and right bass also goes to the subwoofer simultaneously.

**Off (THX):**

Double Bass function off.

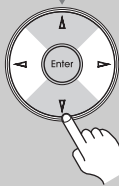

**12**



Press the [Setup] button.

The setup menu closes.

#### Note:

This procedure can also be performed on the AV receiver by using its [Setup] button, arrow buttons, and [Enter] button.

## Speaker Distance

This setting is set automatically by the Automatic Speaker Setup function (see page 49).

Here you can specify the distance from each speaker to the listening position so that the sound from each speaker arrives at the listener's ears as the sound designer intended.

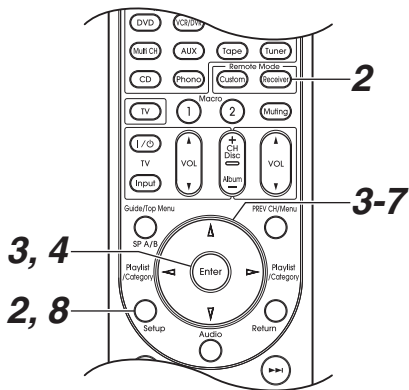

**1** Measure and make a note of the distance from each speaker to the listening position.

**2** Press the [Receiver] button followed by the [Setup] button. The main menu appears onscreen. If the main menu doesn't appear, make sure the appropriate external input is selected on your TV.

**3** Use the Up and Down [▲]/[▼] buttons to select "2. Speaker Setup", and then press [Enter]. The "Speaker Setup" menu appears.

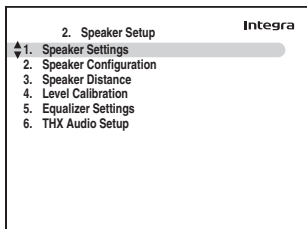

**4** Use the Up and Down [▲]/[▼] buttons to select "3. Speaker Distance", and then press [Enter]. The "Speaker Distance" menu appears.

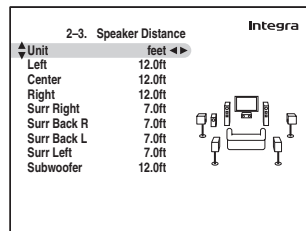

**5** Use the Up and Down [▲]/[▼] buttons to select "Unit", and then use the Left and Right [◀]/[▶] buttons to select:

**feet:** Select if you want to enter distances in feet. Can be set from 0.2 to 30 feet in 0.2-foot steps.

**meters:** Select if you want to enter distances in meters. Can be set from 0.06 to 9 meters in 0.06-meter steps.

**6** Use the Up and Down [▲]/[▼] buttons to select "Left", and then use the Left and Right [◀]/[▶] buttons to specify the distance. Specify the distance from the front left speaker to your listening position.

**7** Repeat step 6 for all speakers.

**Note:**

Speakers that you set to "No" or "None" on the Speaker Configuration page (page 90) cannot be selected.

**8** Press the [Setup] button. The setup menu closes.

**Note:** This procedure can also be performed on the AV receiver by using its [Setup] button, arrow buttons, and [Enter] button.

## Speaker Level Calibration

This setting is set automatically by the Automatic Speaker Setup function (see page 49).

Here you can adjust the level of each speaker with the built-in test tone so that the volume of each speaker is the same at the listening position.

### Notes:

- The speakers cannot be calibrated while the output of the AV receiver is muted.
- The test tone is output at the standard level for THX, which is 0 dB (absolute volume setting 82). If you normally listen at volume settings below this, be careful because the test tone will be much louder.

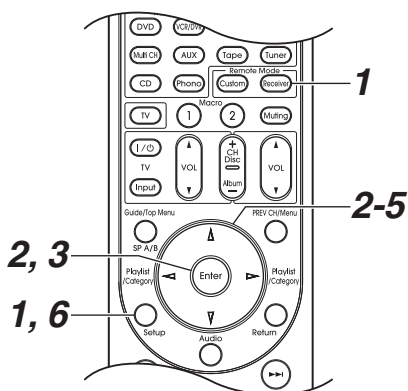

**1** Press the [Receiver] button followed by the [Setup] button. The main menu appears onscreen. If the main menu doesn't appear, make sure the appropriate external input is selected on your TV.

**2** Use the Up and Down [▲]/[▼] buttons to select "2. Speaker Setup", and then press [Enter]. The "Speaker Setup" menu appears.

2. Speaker Setup		Integra
▲	1. Speaker Settings	←
2.	Speaker Configuration	→
3.	Speaker Distance	
4.	Level Calibration	
5.	Equalizer Settings	
6.	THX Audio Setup	

**3** Use the Up and Down [▲]/[▼] buttons to select "4. Level Calibration", and then press [Enter]. The "Level Calibration" menu appears and the pink noise test tone is output by the front left speaker.

2-4. Level Calibration		Integra
▲	Left	←
Center	0.0dB	→
Right	0.0dB	
Surr Right	0.0dB	
Surr Back R	0.0dB	
Surr Back L	0.0dB	
Surr Left	0.0dB	
Subwoofer	0.0dB	

**4** Use the Up and Down [▲]/[▼] buttons to select each speaker, and use the Left and Right [◀]/[▶] buttons to set the volume. The volume can be adjusted from -12.0 to +12.0 dB (-15.0 dB to +12.0 dB for the subwoofer) in 0.5 dB steps.

**5** Repeat step 4 until the volume of the test tone from each speaker is the same.

If you're using a handheld sound level meter, adjust the level of each speaker so that it reads 75 dB SPL at the listening position, measured with C-weighting and slow reading.

**6** Press the [Setup] button. The setup menu closes.

**Note:** This procedure can also be performed on the AV receiver by using its [Setup] button, arrow buttons, and [Enter] button.

## Equalizer Setting

This setting is set automatically by the Automatic Speaker Setup function (see page 49).

With the Equalizer settings, you can adjust the tone of speakers individually with a 7-band equalizer. The volume of each speaker can be set on page 94.

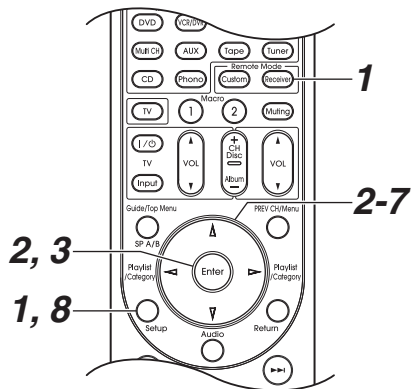

**1**



**Press the [Receiver] button followed by the [Setup] button.**

The main menu appears onscreen. If the main menu doesn't appear, make sure the appropriate external input is selected on your TV.

**2**



**Use the Up and Down [▲]/[▼] buttons to select "2. Speaker Setup", and then press [Enter].**

The "Speaker Setup" menu appears.

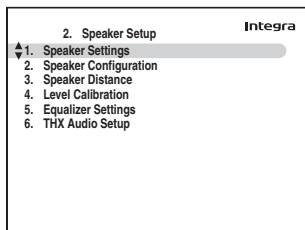

**3**



**Use the Up and Down [▲]/[▼] buttons to select "5. Equalizer Settings", and then press [Enter].**

The "Equalizer Settings" menu appears.

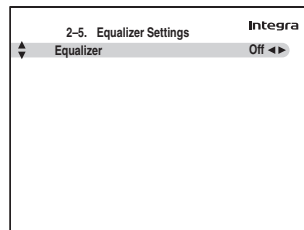

**4**

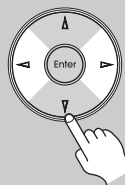

**Use the Left and Right [◀]/[▶] buttons to select:**

**Off:**

Equalizer off, response flat.

**Audyssey:**

The tone for each speaker is set automatically by the Automatic Speaker Setup function.

Be sure to select this setting after having performed the Automatic Speaker Setup.

**Manual:**

You can adjust the equalizer for each speaker manually.

If you select "Manual", continue with this procedure. If you select "Off" or "Audyssey", go to step 8.

**5**



**Use the Down [▼] button to select "Channel", and then use the Left and Right [◀]/[▶] buttons to select a speaker.**

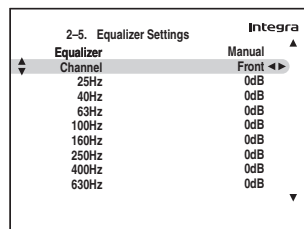

**6**



Use the Up and Down [▲]/[▼] buttons to select a frequency, and then use the Left and Right [◀]/[▶] buttons to adjust the level at that frequency.

You can select: “25Hz”, “40Hz”, “63Hz”, “100Hz”, “160Hz”, “250Hz”, “400Hz”, “630Hz”, “1000Hz”, “1600Hz”, “2500Hz”, “4000Hz”, “6300Hz”, “10000Hz”, or “16000Hz”. And for the subwoofer, “25Hz”, “40Hz”, “63Hz”, “100Hz”, or “160Hz”.

The volume at each frequency can be adjusted from -6 to +6 dB in 1 dB steps.

**Tip:**

Low frequencies (e.g., 160Hz) affect bass sounds; high frequencies (e.g., 6300Hz) affect treble sounds.

**7**



Use the Up and Down [▲]/[▼] buttons to select “Channel”, and then use the Left and Right [◀]/[▶] buttons to select another speaker.

Repeat step 6 and 7 for each speaker.

**8**



Press the [Setup] button.

The setup menu closes.

**Notes:**

- When the listening mode is set to Direct, no effect will be produced.
- The Equalizer settings have no effect on 176.4/ 192 kHz input signals.
- This procedure can also be performed on the AV receiver by using its [Setup] button, arrow buttons, and [Enter] button.

## THX Audio Setup

These settings are **not** set automatically by the Automatic Speaker Setup function (see page 49).

With the “Surr Back Sp Spacing” setting, you can specify the distance between your surround back speakers. If you’re using a THX-certified subwoofer, set the “THX Ultra2/Select2 Subwoofer” setting to “Yes”. You can then apply THX’s Boundary Gain Compensation (BGC) to compensate the perceived exaggeration of low frequencies for listeners sitting very close to a room boundary (i.e., wall).

You can also set the THX Loudness Plus. When the “Loudness Plus” is set to “On”, it is possible to enjoy even subtle nuances of audio expression at low volume. This result is only available when the THX listening mode is selected.

**1**



Press the [Receiver] button, followed by the [Setup] button.

The main menu appears onscreen. If the main menu doesn’t appear, make sure the appropriate external input is selected on your TV.

**2**



Use the Up and Down [▲]/[▼] buttons to select “2. Speaker Setup”, and then press [Enter].

The “Speaker Setup” menu appears.

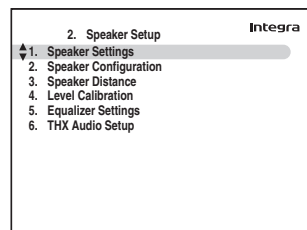

**3**

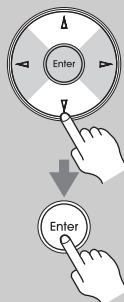

Use the Up and Down [▲]/[▼] buttons to select “6. THX Audio Setup”, and then press [Enter].

The “THX Audio Setup” screen appears.

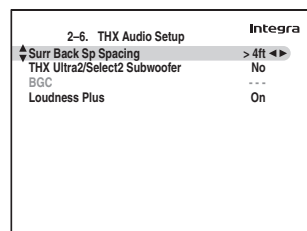



4

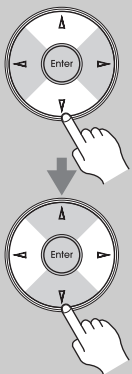

Use the Up and Down [▲]/[▼] buttons to select “Surr Back Sp Spacing”, and use the Left and Right [◀]/[▶] buttons to specify the distance between your surround back speakers:

**< 1ft (< 0.3m):**

Select this if your surround back speakers are between 0 and 1 foot (0–30 cm) apart.

**1ft – 4ft (0.3 m – 1.2 m):**

Select this if your surround back speakers are between 1 and 4 feet (0.3–1.2 m) apart.

**> 4ft (> 1.2m) (default):**

Select this if your surround back speakers are more than 4 feet (1.2 m) apart.

**Note:**

This setting is only available if the “Surr Back Ch” setting in the Speaker Configuration is set to “2ch” (page 91).

5

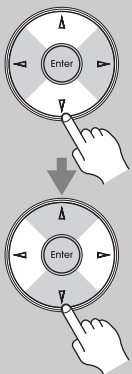

Use the Up and Down [▲]/[▼] buttons to select “THX Ultra2/Select2 Subwoofer”, and use the Left and Right [◀]/[▶] buttons to select:

**No:** Select this if you do not have a THX-certified subwoofer.

**Yes:** Select this if you have a THX-certified subwoofer.

6

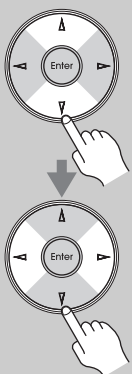

Use the Up and Down [▲]/[▼] buttons to select “BGC”, and use the Left and Right [◀]/[▶] buttons to select:

**Off:** Select this to turn off BGC.

**On:** Select this to turn on BGC.

**Note:**

This setting is only available if “THX Ultra2/Select2 Subwoofer” is set to “Yes” (step 5).

7



Use the Up and Down [▲]/[▼] buttons to select “Loudness Plus”, and use the Left and Right [◀]/[▶] buttons to select:

**Off:** Select this to turn off Loudness Plus.

**On:** Select this to turn on Loudness Plus.

8



Press the [Setup] button.

The setup menu closes.

**Note:**

This procedure can also be performed on the AV receiver by using its [Setup] button, arrow buttons, and [Enter] button.

**THX Loudness Plus**

THX Loudness Plus is a new volume control technology featured in THX Ultra2 Plus™ and THX Select2 Plus™ Certified receivers. With THX Loudness Plus, home theater audiences can now experience the rich details in a surround mix at any volume level. A consequence of turning the volume below Reference Level is that certain sound elements can be lost or perceived differently by the listener. THX Loudness Plus compensates for the tonal and spatial shifts that occur when the volume is reduced by intelligently adjusting ambient surround channel levels and frequency response. This enables users experience the true impact of soundtracks regardless of the volume setting. THX Loudness Plus is automatically applied when listening in any THX listening mode. The new THX Cinema, THX Music, and THX Games modes are tailored to apply the proper THX Loudness Plus settings for each type of content.

## Audio Adjust Functions

Here you can set listening mode-related settings and functions.

**1**

Remote controller

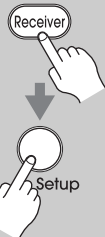

**Press the [Receiver] button followed by the [Setup] button.**

The main menu appears onscreen. If the main menu doesn't appear, make sure the appropriate external input is selected on your TV.

**2**

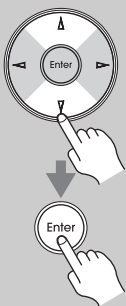

**Use the Up and Down [▲]/[▼] buttons to select "3. Audio Adjust", and then press [Enter].**

The "Audio Adjust" menu appears.

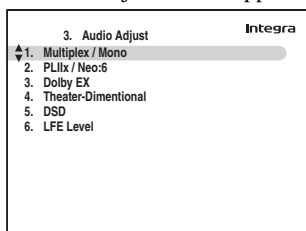

**3**

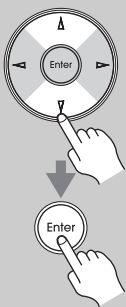

**Use the Up and Down [▲]/[▼] buttons to select the functions, and then press [Enter].**

The function menu you selected appears.

**4**

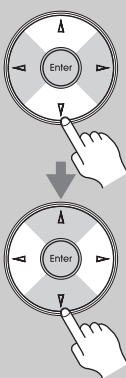

**Use the Up and Down [▲]/[▼] buttons to select the settings, and use the Left and Right [◀]/[▶] buttons to set them.**

The settings are explained below.

**5**



**When you've finished, press the [Setup] button.**

The setup menu closes.

**Note:**

This procedure can also be performed on the AV receiver by using its [Setup] button, arrow buttons, and [Enter] button.

## Multiplex/Mono Settings

### ■ Multiplex

#### Input Ch

This setting determines which channel is output from a stereo multiplex source. Use it to select audio channels or languages with multiplex sources, multilingual TV broadcasts, and so on.

**Main:** The main channel is output (default).

**Sub:** The sub channel is output.

**Main/Sub:** Both the main and sub channels are output.

### ■ Mono

#### Input Ch

This setting specifies the channel to be used for playing any 2-channel digital source such as Dolby Digital, or 2-channel analog/PCM source in the Mono listening mode.

**Left + Right:** Both the left and right channels are output (default).

**Left:** Only the left channel is output.

**Right:** Only the right channel is output.

#### Output Speaker

This setting determines which speakers output mono audio when the Mono listening mode is selected.

**Left / Right:** Mono audio is output by the front left and right speakers.

**Center:** Mono audio is output by the center speaker (default).

## PLIIx/Neo:6 Music Mode Settings

### ■ PLIIx Music (2ch Input)

These settings provide for playing any 2-channel digital source such as Dolby Digital, or 2-channel analog/PCM source in the Dolby PLIIx Music listening mode.

#### Panorama

With this function, you can broaden the width of the front stereo image when using the Dolby Pro Logic II Music or Dolby Pro Logic IIx Music listening mode.

**On:** Panorama function on.

**Off:** Panorama function off (default).

### Dimension

With this setting, you can move the sound field forward or backward when using the Dolby Pro Logic II Music or Dolby Pro Logic IIX Music listening mode. It can be adjusted from -3 to +3 (default is 0). Lower settings move the sound field forward. Higher settings move it backward.

If the stereo image feels too wide, or there is too much surround sound, move the sound field forward to improve the balance. Conversely, if the stereo image feels like it is in mono, or there is not enough surround sound, move it backward.

### Center Width

With this function, you can adjust the width of the sound from the center speaker when using the Dolby Pro Logic II Music or Dolby Pro Logic IIX Music listening mode. Normally, if you are using a center speaker, the center channel sound is output by only the center speaker. (If you are not using a center speaker, the center channel sound will be distributed to the front left and right speakers to create a phantom center.) This setting controls the front left, right, and center mix, allowing you to adjust the weight of the center channel sound. It can be adjusted from 0 to 7 (default is 3).

### ■ Neo:6 Music

#### Center Image

The DTS Neo:6 Music listening mode creates 6-channel surround sound from 2-channel (stereo) sources. With this setting, you can specify by how much the front left and right channel output is attenuated in order to create the center channel. It can be adjusted from 0 to 5 (default is 2). This setting is unavailable if no surround speakers are connected.

When set to 0, the front left and right channel output is attenuated by half (-6 dB), giving the impression that the sound is located centrally. This setting works well when the listening position is considerably off center. When set to 5, the front left and right channels are not attenuated, maintaining the original stereo balance.

### Dolby EX Input Signal Setting

#### ■ Dolby EX

This setting determines how Dolby EX encoded signals are handled. This setting is unavailable if no surround back speakers are connected. This setting is effective with Dolby Digital, Dolby Digital Plus and Dolby TrueHD only.

**Auto:** If the source signal contains a Dolby EX flag, the Dolby EX or THX Surround EX listening mode is used (default).

**Manual:** You can select any available listening mode.

### T-D (Theater-Dimensional) Listening Setting

#### ■ Listening Angle

With this setting, you can specify the angle of the front left and right speakers relative to the listening position. Processing for the Theater-Dimensional listening mode is based on this setting. Ideally, the front left and right speakers should be equidistant from the listening position and at an angle close to one of the two available settings.

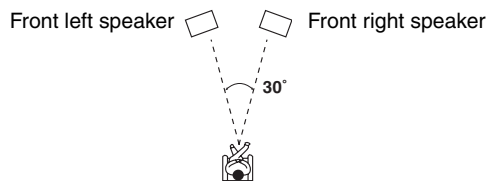

**Narrow:** Select if the angle is less than 30 degrees.

**Wide:** Select if the angle is greater than 30 degrees (default).

### DSD Setting

#### ■ DAC Direct

This setting determines whether or not DSD (SACD) audio signals are passed through the DSP for A/V Sync, delay, etc., processing when the Direct listening mode is selected.

**No:** DSD signals are processed by the DSP (default).

**Yes:** DSD signals are not processed by the DSP.

### LFE Level Settings

With these settings, you can set the level of the LFE (Low Frequency Effects) channel individually for Dolby Digital, DTS, multichannel PCM, Dolby TrueHD, DTS-HD Master Audio, and DSD sources. The level can be set to  $-\infty$ , -10 dB, or 0 dB (default).

If you find that low-frequency effects are too loud when using one of these sources, change the setting to -10 dB or  $-\infty$  dB.

#### ■ Dolby Digital

Sets the level of the LFE channel for Dolby Digital and Dolby Digital Plus sources.

#### ■ DTS

Sets the level of the LFE channel for DTS and DTS-HD High Resolution sources.

#### ■ Multichannel PCM

Sets the level of the LFE channel for multichannel PCM sources. (Multichannel PCM is input via HDMI.)

#### ■ Dolby TrueHD

Sets the level of the LFE channel for Dolby TrueHD sources.

#### ■ DTS-HD Master Audio

Sets the level of the LFE channel for DTS-HD Master Audio sources.

#### ■ DSD

Sets the level of the LFE channel for DSD (SACD) sources.

### Adjust Using the Audio Button

You can change various audio settings by pressing the [Audio] button.

#### Note:

When the “Audio TV Out” setting is set to “On” (page 110), the [Audio] button is disabled.

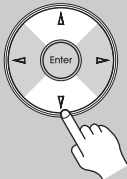
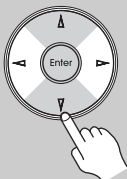
<p><b>1</b></p> 	<p><b>Press the [Receiver] button followed by the [Audio] button.</b></p> <p>The setting item appears on the display.</p>
<p><b>2</b></p> 	<p><b>Use the Up and Down [▲]/[▼] buttons to select an item.</b></p>
<p><b>3</b></p> 	<p><b>Use the Left and Right [◀]/[▶] buttons to change the setting.</b></p> <p>Repeat this step for the other settings.</p>

The Audio Adjust settings are explained below.

### Tone Control Settings

You can adjust the bass and treble for the front speakers, except when the Direct or THX listening mode is selected.

#### ■ Bass

You can boost or cut low-frequency sounds output by the front speakers from -10 dB to +10 dB in 2 dB steps.

#### ■ Treble

You can boost or cut high-frequency sounds output by the front speakers from -10 dB to +10 dB in 2 dB steps.

#### Notes:

- This setting is not available when the multichannel DVD input is selected.
- This procedure can also be performed on the AV receiver by using its [Tone], [-], and [+] buttons (see page 55).

### Late Night Function

#### ■ Late Night

With the Late Night function, you can reduce the dynamic range of Dolby Digital material so that you can still hear quiet parts even when listening at low volume levels—ideal for watching movies late at night when you don’t want to disturb anyone.

For **Dolby Digital and Dolby Digital Plus** sources, the options are:

**Off:** Late Night function off (default).

**Low:** Small reduction in dynamic range.

**High:** Large reduction in dynamic range.

For **Dolby TrueHD** sources, the options are:

**Auto:** The Late Night function is set to “On” or “Off” automatically (default).

**Off:** Late Night function off.

**On:** Late Night function on.

#### Note:

The effect of the Late Night function depends on the material that you are playing and the intention of the original sound designer, and with some material there will be little or no effect when you select the different options.

### Re-EQ Function

With the Re-EQ function, you can compensate a soundtrack whose high-frequency content is too harsh, making it more suitable for home theater viewing.

#### ■ Re-EQ

This function can be used with the following listening modes:

- Dolby Digital, Dolby Digital EX, Dolby Pro Logic II Movie, Dolby Pro Logic IIx Movie
- DTS, DTS-ES, DTS Neo:6 Cinema, DTS 96/24
- Multichannel

#### ■ Re-EQ (THX)

This function can be used with the following listening modes:

- THX Cinema, THX Surround EX, THX Ultra2 Cinema

**Off:** Re-EQ Function off.

**On:** Re-EQ Function on.

#### Note:

Settings of “On” and “Off” for the Re-EQ function are kept in each listening mode. However, in THX listening mode, when the AV receiver is turned off, it will return to “On”.

### Audyssey Dynamic EQ™

---

#### ■ DynamicEQ (Applies to Non-THX Listening Modes)

#### ■ THX+DynamicEQ (Applies to THX Listening Modes)

With Audyssey Dynamic EQ, you can enjoy great sound even when listening at low volume levels.

Audyssey Dynamic EQ solves the problem of deteriorating sound quality as volume is decreased by taking into account human perception and room acoustics.

It does so by selecting the correct frequency response and surround volume levels moment-by-moment so that the content sounds the way it was created at any volume level—not just at reference level.

**Off:** Audyssey Dynamic EQ off.

**On:** Audyssey Dynamic EQ on.

#### Notes:

- Audyssey Dynamic EQ can be set only when the “Equalizer Settings” on page 95 are set to “Audyssey”.
- When “Loudness Plus” is set to “On” (see page 97), the THX+Dynamic EQ is not available even with THX listening mode selected.

### Music Optimizer

---

#### ■ M.Optimizer

The Music Optimizer function enhances the sound quality of compressed music files. Use it with music files that use “lossy” compression, such as MP3.

**Off:** Music Optimizer off (default).

**On:** Music Optimizer on.

#### Note:

The Music Optimizer function only works with PCM digital audio input signals with a sampling rate below 48 kHz and analog audio input signals. The Music Optimizer is disabled when the Direct listening mode is selected.

### Speaker Levels

---

You can adjust the volume of each speaker while listening to an input source.

These temporary adjustments are cancelled when the AV receiver is set to Standby.

#### ■ Subwoofer

You can adjust the level from –15.0 dB to +12.0 dB.

#### ■ Center

You can adjust the level from –12.0 dB to +12.0 dB.

#### Notes:

- You cannot use this function while the AV receiver is muted.
- Speakers that are set to “No” or “None” in the “Speaker Configuration” cannot be adjusted (see page 90).

### A/V Sync

---

#### ■ A/V Sync

When using progressive scanning on your DVD player, you may find that the picture and sound are out of sync.

With this setting, you can correct this by delaying the audio signals. You can set it from 0 to 250 milliseconds (ms) in 2 millisecond steps.

#### Notes:

- This setting is not available when the Direct listening mode is used with an analog input signal.
- This setting is not available when the multichannel DVD input is selected.

## Assigning Listening Modes to Input Sources

You can assign a default listening mode to each input source that will be selected automatically when you select each input source. For example, you can set the default listening mode to be used with Dolby Digital input signals. You can select other listening modes during playback, but the mode specified here will be resumed once the AV receiver has been set to Standby.

**1**

Remote controller



Press the [Receiver] button followed by the [Setup] button.

The main menu appears onscreen.

If the main menu doesn't appear, make sure the appropriate external input is selected on your TV.

**2**

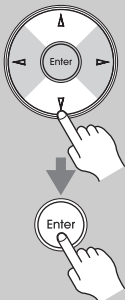

Use the Up and Down [▲]/[▼] buttons to select "5. Listening Mode Preset", and then press [Enter].

The "Listening Mode Preset" menu appears.

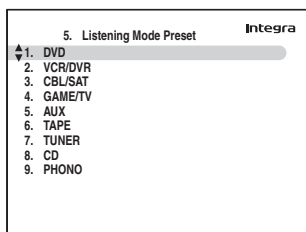

**3**

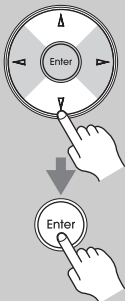

Use the Up and Down [▲]/[▼] buttons to select the input source that you want to set, and then press [Enter].

The signal format selection menu appears.

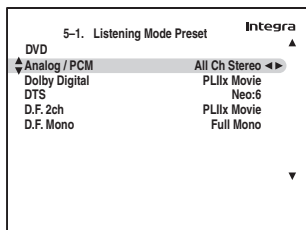

For TUNER input selector only "Analog" will be available.

**4**



Use the Up and Down [▲]/[▼] buttons to select the signal format that you want to set, and then use the Left and Right [◀]/[▶] buttons to select a listening mode.

Only listening modes that can be used with each input signal format can be selected (see page 80).

The Last Valid option means that the listening mode selected last will be used.

**Analog / PCM:** With this setting, you can specify the listening mode to be used when an analog (CD, TV, LD, VHS, MD, turntable, radio, cassette, cable, satellite, etc.) or PCM digital (CD, DVD, etc.) audio signal is played.

**Dolby Digital:** With this setting, you can specify the listening mode to be used when a Dolby Digital or Dolby Digital Plus format digital audio signal is played (DVD, etc.).

**DTS:** With this setting, you can specify the listening mode to be used when a DTS or DTS-HD High Resolution format digital audio signal is played (DVD, LD, CD, etc.).

**D.F. 2ch:** With this setting, you can specify the listening mode to be used when a 2-channel (2/0) digital audio signal (Dolby Digital, DTS) is played (DVD, etc.).

**D.F. Mono:** With this setting, you can specify the listening mode to be used when a mono digital audio signal is played (DVD, etc.).

**Multich PCM:** Specifies the default listening mode for multichannel PCM sources input via a HDMI IN, such as DVD-Audio.

**192k/176.4k:** Specifies the default listening mode for high resolution 176.4 kHz and 192 kHz digital audio sources such as DVD-Audio.

**Dolby TrueHD:** Specifies the default listening mode for Dolby TrueHD sources, such as Blu-ray or HD DVD (input via HDMI).

**DTS-HD Master Audio:** Specifies the default listening mode for DTS-HD Master Audio sources, such as Blu-ray or HD DVD (input via HDMI).

**DSD:** Specifies the default listening mode for DSD multichannel sources, such as SACD.

**5**

When you've finished, press the [Setup] button.

The setup menu closes.



**Note:**

This procedure can also be performed on the AV receiver by using its [Setup] button, arrow buttons, and [Enter] button.

## Source Setup

This section explains items on the "Source Setup" menu. Items can be set individually for each input selector.

**1**

Press the input selector buttons to select an input source, and then press the [Receiver] button.



**2**

Press the [Setup] button.

The main menu appears onscreen. If the main menu doesn't appear, make sure the appropriate external input is selected on your TV.



**3**

Use the Up and Down [▲]/[▼] buttons to select "4. Source Setup", and then press [Enter].

The "Source Setup" menu appears. The name of the currently selected input selector is displayed in a box.

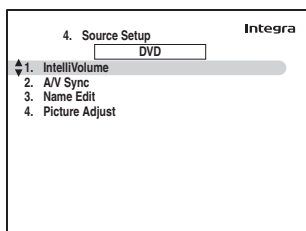
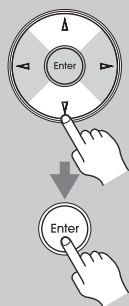

**4**

Use the Up and Down [▲]/[▼] buttons to select an item, and then press [Enter].



**5**

Use the Left and Right [◀]/[▶] buttons to change it.

The "Source Setup" menu items are explained below.

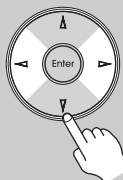

**6**

When you've finished, press the [Setup] button.

The setup menu closes.



## IntelliVolume

With IntelliVolume, you can set the input level for each input selector individually. This is useful if one of your source components is louder or quieter than the others. Use the Left and Right [◀]/[▶] buttons to set the level. If a component is noticeably louder than the others, use the Left [◀] button to reduce its input level. If it's noticeably quieter, use the Right [▶] button to increase its input level. The input level can be adjusted from -12 dB to +12 dB in 1 dB steps.

**Note:**

IntelliVolume does not apply for Zone 2.

### A/V Sync

When using your DVD player's progressive scanning function, you may find that the picture and sound are out of sync. With the A/V Sync setting, you can correct this by applying a delay to the audio signal. The delay can be set from 0 to 250 milliseconds (msec) in 2 millisecond steps.

Use the Left and Right [◀]/[▶] buttons to set the delay. To view the TV picture while setting the delay, press [Enter].

To return to the previous screen, press the [Return] button.

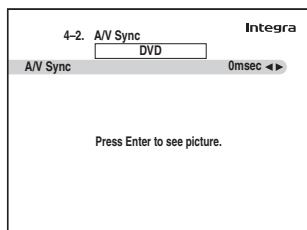

If HDMI Lip Sync is enabled (see page 110), and your TV or display supports HDMI Lip Sync, the displayed delay time will be the A/V Sync delay time. The HDMI Lip Sync delay time is displayed underneath in parentheses.

#### Note:

A/V Sync is disabled when the Direct listening mode is used with an analog input source.

### Name Edit

You can enter a custom name for each individual input selector and radio preset for easy identification. When entered, the custom name will appear on the display. The custom name is edited using the character input screen.

1. Use the arrow [▲]/[▼]/[◀]/[▶] buttons to select a character, and then press [Enter].  
Repeat this step to enter up to 10 characters.
2. When you've finished, to store a name, be sure to use the arrow [▲]/[▼]/[◀]/[▶] buttons to select "OK", and then press [Enter]. Otherwise it will not be saved.

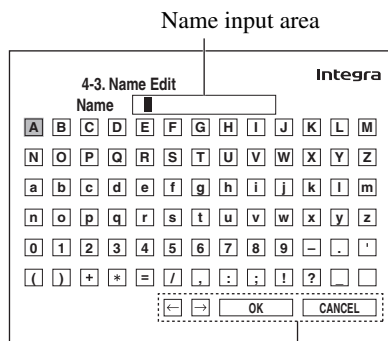

← (Left)/ → (Right):

Selected when the cursor is moved within the Name input area.

OK:

Selects when the entry is complete.

CANCEL:

Selects when you want to cancel the name entry.

#### To correct a character:

1. Use the arrow [▲]/[▼]/[◀]/[▶] buttons to select "←"(Left) or "→"(Right) and then press [Enter].
2. Press [Enter] several times to select the incorrect character (The cursor moves one letter each time [Enter] is pressed).
3. Use the arrow [▲]/[▼]/[◀]/[▶] buttons to select the correct character, and then press [Enter].

#### Notes:

- To name a radio preset, use the [Tuner] button to select AM or FM, and then select the preset (see step 1 on page 103).
- You cannot enter a custom name for XM or SIRIUS radio presets.
- To restore a custom name to the default, erase the custom name by entering an empty white space for each letter.
- This procedure can also be performed on the AV receiver by using its [Setup], [Enter], and arrow buttons.



### Picture Adjust

Using Picture Adjust, you can adjust the picture quality and reduce any noise appearing on the screen and set it to that adjustment.

Use the Up and Down [▲]/[▼] buttons to select the settings, and use the Left and Right [◀]/[▶] buttons to set them.

To view the TV picture while setting, press [Enter].

To return to the previous screen, press the [Return] button.

#### ■ Picture Mode

AV receiver comes with three Picture Modes (picture setting patterns): “Mode1” (default), “Mode2”, and “Mode3”.

#### ■ Brightness

With this setting you can adjust the picture brightness. Can be adjusted from -20 to +20 in steps of 1 (default is 0).

“-20” is the darkest.

“+20” is the brightest.

#### ■ Contrast

With this setting you can adjust Contrast. Can be adjusted from -20 to +20 in steps of 1 (default is 0).

“-20” is the least.

“+20” is the greatest.

#### ■ Hue

With this setting you can adjust the red/green balance. Can be adjusted from -20 to +20 in steps of 1 (default is 0).

“-20” is the strongest green.

“+20” is the strongest red.

#### ■ Saturation

With this setting you can adjust saturation. Can be adjusted from -20 to +20 in steps of 1 (default is 0).

“-20” is the weakest color.

“+20” is the strongest color.

#### ■ Edge Enhancement

With this setting you can adjust the sharpness of edges in the picture.

Can be adjusted from 0 to +10 in steps of 1 (default is 0).

“0” is the softest.

“+10” is the sharpest.

#### ■ Default

You can reset the “Picture Adjust” to its default settings. Press the Right [▶] button or [Enter] to reset “Picture Adjust” settings.

#### Note:

For optimal video performance, THX recommends that the “Picture Adjust” be set to its default settings.

#### ■ Noise Reduction

With this setting, you can reduce noise appearing on the screen.

**Off:** Noise reduction off.

**Low:** Low noise reduction (default).

**Mid:** Medium noise reduction.

**High:** High noise reduction.

#### Notes:

- When the video signals from HDMI input are “1080p”, “Noise Reduction” in the Picture Adjust settings is not available.
- The “Picture Adjust” (except “Default”) can also be set using the [Display] button on the remote controller.
  1. Press and hold the [Display] button until the setting item appears on the display.
  2. Use the Up and Down [▲]/[▼] buttons to select an item, and use the Left and Right [◀]/[▶] buttons to change the setting.

## Miscellaneous (Volume/OSD) Setup

This section explains the items on the “Miscellaneous” menu.

**1**

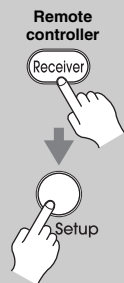

**Remote controller**

**Receiver**

**Setup**

**Press the [Receiver] button followed by the [Setup] button.**  
The main menu appears onscreen. If the main menu doesn't appear, make sure the appropriate external input is selected on your TV.

**2**

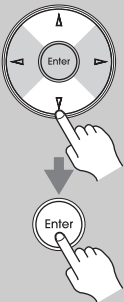

**Use the Up and Down [▲]/[▼] buttons to select “6. Miscellaneous”, and then press [Enter].**  
The “Miscellaneous” menu appears.

Integra

6. Miscellaneous

- ▲ 1. Volume Setup
- 2. OSD Setup
- 3. 12V Trigger A Setup
- 4. 12V Trigger B Setup
- 5. 12V Trigger C Setup

**3**

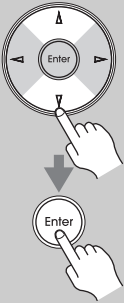

**Use the Up and Down [▲]/[▼] buttons to select an item, and then press [Enter].**  
The screen for that item appears.

**4**

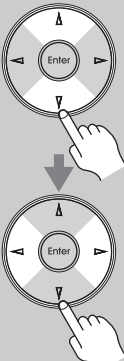

**Use the Up and Down [▲]/[▼] buttons to select an item, and use the Left and Right [◀]/[▶] buttons to change it.**  
The items are explained below.

**5**

**When you've finished, press the [Setup] button.**

The setup menu closes.



### Note:

This procedure can also be performed on the AV receiver by using its [Setup] button, arrow buttons, and [Enter] button.

## Volume Setup

### ■ Volume Display

With this setting, you can choose how the volume level is displayed.

**Absolute:** Display range is “Min”, 0.5 through 99.5, “Max”.

**Relative:** Display range is  $-\infty$  dB,  $-81.5$  dB through  $+18.0$  dB.

The absolute value 82 is equivalent to the relative value 0 dB.

### ■ Muting Level

This setting determines how much the output is muted when the Muting function is used (see page 56). It can be set to  $-\infty$  dB (fully muted) or from  $-50$  dB to  $-10$  dB in 10 dB steps.

### ■ Maximum Volume

With this setting, you can limit the maximum volume. When the “Volume Display” setting is set to “Absolute”, the Maximum Volume range is “Off”, 50 to 99. When it's set to “Relative”, the range is “Off”,  $-32$  dB to  $+17$  dB. To disable this setting, select “Off”.

### ■ PowerOn Volume

With this preference, you can specify the volume setting to be used each time the AV receiver is turned on. When the “Volume Display” preference is set to “Absolute”, the range is “Last”, “Min”, 1 to 99 or “Max”. When it's set to “Relative”, the range is “Last”,  $-\infty$  dB,  $-81$  dB to  $+18$  dB.

To use the same volume level that was used when the AV receiver was turned off, select “Last”.

The “PowerOn Volume” cannot be set higher than the “Maximum Volume” setting.

### ■ Headphone Level

With this preference, you can specify the headphone volume relative to the main volume. This is useful if there's a volume difference between your speakers and your headphones. The headphones level can be set from  $-12$  dB to  $+12$  dB.

### ■ Zone2 Maximum Volume

With this setting, you can limit the maximum volume for Zone 2.

When the “Volume Display” setting is set to “Absolute”, the Maximum Volume range is “Off”, 50 to 99.

When it’s set to “Relative”, the range is “Off”, –32 dB to +17 dB. To disable this setting, select “Off”.

### ■ Zone2 PowerOn Volume

This setting determines what the volume will be for Zone 2 each time the AV receiver is turned on.

When the “Volume Display” preference is set to “Absolute”, the range is “Last”, “Min”, 1 to 99 or “Max”.

When it’s set to “Relative”, the range is “Last”, –∞ dB, –81 dB to +18 dB. To use the same volume level that was used when the AV receiver was turned off, select “Last”.

## OSD Setup

---

### ■ Immediate Display

This preference determines whether operation details are displayed onscreen when an AV receiver function is adjusted.

**On:** Displayed (default).

**Off:** Not displayed.

Even when “On” is selected, operation details may not be output if the input source is connected to a COMPONENT VIDEO IN or HDMI IN.

For optimal video performance, THX recommends that Immediate Display be turned off.

### ■ Monitor Type

With this preference, you can specify the aspect ratio of your TV so that the operation details are displayed properly.

**4 : 3:** Select if your TV is 4 : 3.

**16 : 9:** Select if your TV is 16 : 9 (default).

### ■ Display Position

This preference determines where on the screen operation details are displayed.

**Bottom:** Bottom of the screen (default).

**Top:** Top of the screen.

### ■ TV Format (not North American models)

See “TV Format Setup (not North American models)” on page 46.

### ■ Language

This setting determines the language used for the onscreen setup menus. You can select: English, German, French, Spanish, Italian, Dutch, Swedish, or Japanese.





## 12V Trigger A/B/C Setup

---

See “Using the 12V Triggers” on page 120.

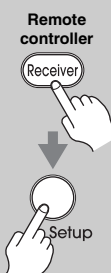
## Hardware Setup

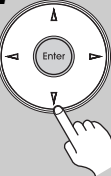
This section explains items on the “Hardware Setup” menu.

<p><b>1</b></p> 	<p><b>Press the [Receiver] button followed by the [Setup] button.</b></p> <p>The main menu appears onscreen. If the main menu doesn't appear, make sure the appropriate external input is selected on your TV.</p>
<p><b>2</b></p> 	<p><b>Use the Up and Down [▲]/[▼] buttons to select “7. Hardware Setup”, and then press [Enter].</b></p> <p>The “Hardware Setup” menu appears.</p> <div style="border: 1px solid black; padding: 5px; margin: 10px 0;"> <p style="text-align: right;">Integra</p> <p>7. Hardware Setup</p> <ul style="list-style-type: none"> <li>▲ 1. Remote Control</li> <li>2. Zone2</li> <li>3. Tuner</li> <li>4. Analog Multich</li> <li>5. HDMI</li> <li>6. Network</li> </ul> </div>
<p><b>3</b></p> 	<p><b>Use the Up and Down [▲]/[▼] buttons to select an item, and then press [Enter].</b></p> <p>The screen for that item appears.</p>
<p><b>4</b></p> 	<p><b>Use the Up and Down [▲]/[▼] buttons to select an item, and use the Left and Right [◀]/[▶] buttons to change it.</b></p> <p>The items are explained below.</p>
<p><b>5</b></p> 	<p><b>When you've finished, press the [Setup] button.</b></p> <p>The setup menu closes.</p>

**Note:**

This procedure can also be performed on the AV receiver by using its [Setup] button, arrow buttons, and [Enter] button.

## Remote Control

### Remote ID

When several Integra/Onkyo components are used in the same room, their remote ID codes may overlap. To differentiate the AV receiver from the other components, you can change its remote ID from 1, the default, to 2 or 3.

**Note:**

If you do change the AV receiver's remote ID, be sure to change the remote controller to the same ID (see below), otherwise, you won't be able to control it with the remote controller.

### Changing the Remote Controller's ID

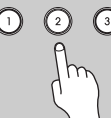
<p><b>1</b></p>  <p>(3 seconds)</p>	<p><b>While holding down the [Receiver] button, press and hold down the [Setup] button until the [Receiver] button lights up (about 3 seconds).</b></p>
<p><b>2</b></p> 	<p><b>Use the number buttons to enter ID 1, 2, or 3.</b></p> <p>The [Receiver] button flashes twice.</p>

### Zone 2

See “Zone 2” on page 114.

### Tuner

#### AM Frequency Step (not North American models)

See “AM Frequency Step Setup (not North American models)” on page 47.

#### SAT Radio Mode (on North American model)

If you connect an XM Satellite Radio antenna or SIRIUS Satellite Radio antenna to the AV receiver (both sold separately), set this setting to “XM” or “SIRIUS” respectively. If you connect both types of antenna, select “XM/SIRIUS”. Otherwise, select “None”. See “Listening to XM Satellite Radio® (North American Model Only)” on page 59 and see “Listening to SIRIUS Satellite Radio® (North American Models Only)” on page 66 for more information.

#### Antenna Aiming (on North American model)

The ID of the Sirius Connect Home Tuner is displayed here. You must sign up to obtain a SIRIUS ID. See “Positioning the SiriusConnect Home antenna” on page 74 for more information. See “Positioning the XM Mini-Tuner System” on page 64 for information about the XM Mini-Tuner Antenna.

### ■ SIRIUS Parental Lock (on North American model)

This item is for use with SIRIUS Satellite Radio. It's not available if "SAT Radio Mode" is set to "None". See "Parental Lock" on page 71 for more information.

### Analog Multich

#### ■ Subwoofer Input Sensitivity

Some DVD players output the LFE channel from their analog subwoofer output at 15 dB higher than normal. With this setting, you can change the AV receiver's subwoofer sensitivity to match your DVD player. Note that this setting only affects signals connected to the AV receiver's DVD SUBWOOFER jack.

You can select 0 dB, 5 dB, 10 dB, or 15 dB.

If you find that your subwoofer is too loud, try the 10 dB or 15 dB setting.

### HDMI

#### ■ Monitor Out

See "Monitor Setup" on page 40.

#### ■ Output Resolution

You can specify the output resolution for the HDMI outputs and have the AV receiver upconvert the picture resolution as necessary to match the resolution supported by your TV.

See the "Video Resolution Chart" on page 139 to see how the AV receiver handles video input at different resolutions.

**Through:** Select this to pass video through the AV receiver at the same resolution and with no conversion (default).

**Auto:** Select this to have the AV receiver automatically convert video at resolutions not supported by your TV. (Not available when the "Monitor Out" setting is set to "Analog".)

**480p (480/576p):** Select this for 480p or 576p output and video conversion as necessary.

**720p:** Select this for 720p output and video conversion as necessary.

**1080i:** Select this for 1080i output and video conversion as necessary.

**1080p:** Select this for 1080p output and video conversion as necessary. (Not available when the "Monitor Out" setting is set to "Analog".)

#### Note:

For optimal video performance, THX recommends that the "Output Resolution" be set to "Through".

#### ■ Zoom Mode

This setting determines the aspect ratio.

**Auto:** The AV receiver automatically selects the Zoom Mode in accordance with the input signal (default).

#### Normal:

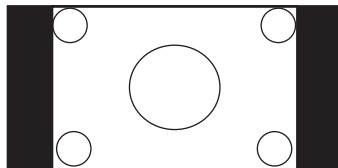
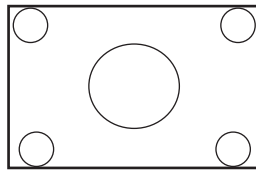

#### Full:

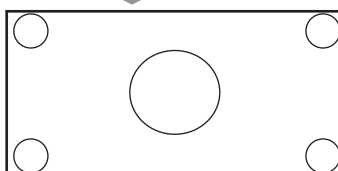
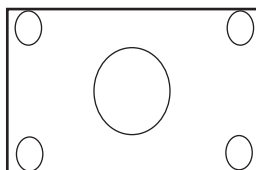

#### Zoom:

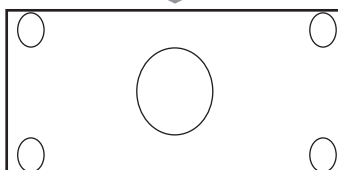
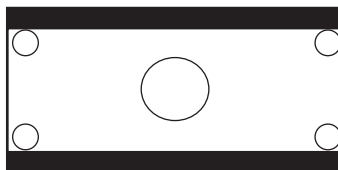

#### Wide Zoom:

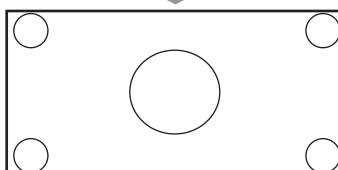
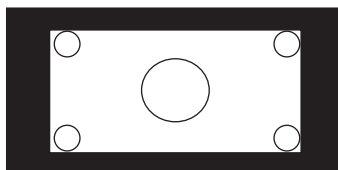

### Note:

The “Zoom Mode” can also be set using the [Display] button on the remote controller.

1. Press and hold the [Display] button until the setting item appears on the display.
2. Use the Up and Down [▲]/[▼] buttons to select “Zoom Mode”, and use the Left and Right [◀]/[▶] buttons to change the setting.

### ■ Film Mode

The AV receiver will adjust to the picture source, processing in either “3:2 pulldown” or “2:2 pulldown” (Film Mode). It automatically converts the source to the appropriate progressive signal and reproduces the natural quality of the original picture.

When the “Film Mode” setting is set to “Auto”, the AV receiver automatically detects the picture source and in either “3:2 pulldown” or “2:2 pulldown”. However, there may be times when you will get a better picture by setting “Film Mode” yourself.

**Auto:** Adjusts to the picture source, automatically selecting Film Mode.

**Off:** Does not process in either “3:2 pulldown” or “2:2 pulldown” (default).

**3:2 pulldown:** Selected when the picture source is movie film, etc.

**2:2 pulldown:** Selected when the picture source is computer graphics, animation, etc.

### Note:

The “Film Mode” can also be set using the [Display] button on the remote controller.

1. Press and hold the [Display] button until the setting item appears on the display.
2. Use the Up and Down [▲]/[▼] buttons to select “Film Mode”, and use the Left and Right [◀]/[▶] buttons to change the setting.

### ■ Audio TV Out

This preference determines whether audio received at the HDMI IN is output by the HDMI OUT. You may want to turn this preference on if your TV is connected to the HDMI OUT and you want to listen to the audio from a component that’s connected to an HDMI IN, through your TV’s speakers. Normally, this should be set to “Off”.

**Off:** HDMI audio is not output (default).

**On:** HDMI audio is output.

### Notes:

- If “On” is selected and the signal can be output by the TV, the AV receiver will output no sound through its speakers.
- When “TV Control” is enabled, this setting is set to “Auto”.
- With some TVs and input signals, no sound may be output even when this setting is set to “On”.
- When the “Audio TV Out” setting is set to “On”, or “TV Control” is set to “Enable” and you’re listening through your TV’s speakers (see page 33), if you turn

up the AV receiver’s volume control, the sound will be output by the AV receiver’s front left and right speakers. To stop the AV receiver’s speakers producing sound, change the settings, change your TV’s settings, or turn down the AV receiver’s volume.

### ■ Lip Sync

The AV receiver can be set to automatically correct any delay between the video and the audio, based on the data from the connected monitor.

**Disable:** HDMI lip sync disabled (default).

**Enable:** HDMI lip sync enabled.

### Notes:

- This function works only if your HDMI-compatible TV supports HDMI Lip Sync.
- You can check the amount of delay being applied by the HDMI Lip Sync function on the A/V Sync screen (see page 104).

### ■ x.v.Color

If your HDMI source and HDMI-compatible TV both support the “x.v.Color,” you can enable “x.v.Color” on the AV receiver with this setting.

**Disable:** “x.v.Color” disabled (default).

**Enable:** “x.v.Color” enabled.

### Notes:

- If the color is unnatural when “x.v.Color” is set to “Enable”, change the setting to “Disable”.
- Refer to the connected component’s instruction manual for details.

### ■ Control

This function allows **RIHD**-compatible components connected via HDMI to be controlled with the AV receiver.

**Disable:** **RIHD** disabled (default).

**Enable:** **RIHD** enabled.

#### Notes:

- **RIHD**, which stands for Remote Interactive over HDMI, is the name of the system control function found on Integra/Onkyo components. The AV receiver can be used with CEC (Consumer Electronics Control), which allows system control over HDMI and is part of the HDMI standard. CEC provides interoperability between various components, however, operation with components other than **RIHD**-compatible components cannot be guaranteed.
- Set to “Disable” when a connected piece of equipment is not compatible or it is unclear whether the equipment is compatible or not.
- If movement is unnatural when set to “Enable”, change the setting to “Disable”.
- Refer to the connected component’s instruction manual for details.

### Power Control

To link the power functions of **RIHD**-compatible components connected via HDMI, select “Enable”.

**Disable:** Power Control disabled.

**Enable:** Power Control enabled.

#### Notes:

- The “Power Control” setting can be set only when the above “Control” setting is set to “Enable”.
- HDMI power control only works with **RIHD**-compatible components that support it and may not work properly with some components due to their settings or compatibility.
- When set to “Enable”, power consumption will increase.
- When set to “Enable”, regardless of whether the AV receiver is On or on Standby, both audio and video received by an HDMI input will be output by the HDMI OUT for playback on the TV or other component that’s connected to the HDMI OUT.
- Refer to the connected component’s instruction manual for details.

### TV Control

Set to “Enable” when you want to control the AV receiver from an **RIHD**-compatible TV that is connected to HDMI.

**Disable:** TV Control disabled.

**Enable:** TV Control enabled.

#### Notes:

- Set to “Disable” when the TV is not compatible or when it is unclear whether the TV is compatible or not.
- The “TV Control” setting can be set only when the above “Control” and “Power Control” settings are both set to “Enable”.

- Refer to the connected component’s instruction manual for details.

#### Note:

After changing the settings of the “Control”, “Power Control”, or “TV Control”, turn off the power to all connected pieces of equipment and then turn on again. Refer to the User’s Manuals for all connected pieces of equipment.



### Network

---

These settings are for use with home automation equipment and external controllers.

### Lock Setup

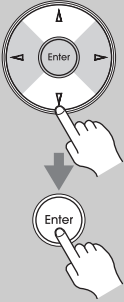
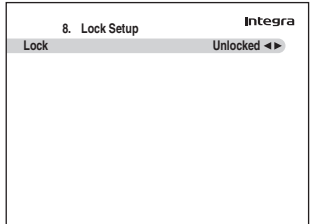
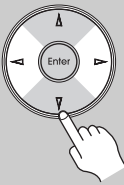
With this preference, you can protect your settings by locking the setup menus.

<p><b>1</b></p> <p>Remote controller</p> 	<p><b>Press the [Receiver] button followed by the [Setup] button.</b></p> <p>The main menu appears onscreen.</p> <p>If the main menu doesn't appear, make sure the appropriate external input is selected on your TV.</p>
<p><b>2</b></p> 	<p><b>Use the Up and Down [▲]/[▼] buttons to select "8. Lock Setup", and then press [Enter].</b></p> <p>The "Lock Setup" menu appears.</p> 
<p><b>3</b></p> 	<p><b>Use the Left and Right [◀]/[▶] buttons to select:</b></p> <p>When the setup menus are locked, you cannot change any setting.</p> <p><b>Locked:</b> Setup menus locked.</p> <p><b>Unlocked:</b> Setup menus not locked.</p>
<p><b>4</b></p> 	<p><b>Press the [Setup] button.</b></p> <p>The setup menu closes.</p>



## Automatic Audio Input Selection Setup

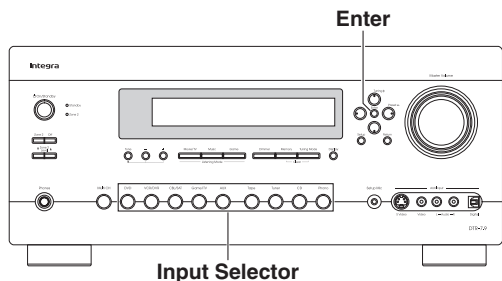

When an input source is selected, the AV receiver checks the relevant audio inputs for the presence of an audio signal and automatically selects an input. With this setting, you can specify which audio inputs the AV receiver will check for signals.

**1** Press the input selector button for the input selector whose setting you want to change.



The setting for the Tuner input selector cannot be changed and is fixed at “Analog”.

**2** Press and hold the [Enter] button.



The current setting is displayed.

Digital Input  
#HDMI1(Auto)

**3** Press the [Enter] button repeatedly to select an option.



### HDMIx (Auto):

This option can be selected when an HDMI input is assigned to an input selector (see page 42). When this option is selected, the relevant HDMI, digital, and analog inputs will be checked for the presence of an audio signal. If signals are present at more than one input, the inputs will be selected in the following order of priority: HDMI, digital, analog.

### COAXx (Auto)/OPTx (Auto):

This option can be selected when a digital input is assigned to an input selector (see page 44). When this option is selected, the relevant digital and analog inputs will be checked for the presence of an audio signal. If signals are present at more than one input, the inputs will be selected in the following order of priority: digital, analog. Any audio signals present at the HDMI inputs will not be output.

### Analog:

When this option is selected, the signal from the relevant analog audio input is output. Any audio signals present at HDMI or digital inputs will not be output.

### Note:

You can select a different option for each input selector.

## Digital Input Signal Formats

The digital input signal formats are available only for the input sources that you have assigned a digital input jack; otherwise you will see “Analog” indicated on the screen (see page 44).

Normally, the AV receiver detects the signal format automatically. However, if you experience either of the following issues when playing PCM or DTS material, you can manually set the signal format to PCM or DTS:

- If the beginnings of tracks from a PCM source are cut off, try setting the format to PCM.
- If noise is produced when fast forwarding or reversing a DTS CD, try setting the format to DTS.

**1** Press and hold the AV receiver’s [Enter] button for about 3 seconds.

**2** While “Auto” is displayed (about 3 seconds), use the Left and Right [◀]/[▶] buttons to select: PCM, DTS or Auto.

### PCM:

Only 2-channel PCM format input signals will be heard. If the input signal is not PCM, the PCM indicator will flash and noise may also be produced.

### DTS:

Only DTS (but not DTS-HD) format input signals will be heard. If the input signal is not DTS, the DTS indicator will flash and there will be no sound.

### Auto (default):

The format is detected automatically. If no digital input signal is present, the corresponding analog input is used instead.

# Zone 2

In addition to your main listening room, you can also enjoy playback in the other room, or as we call Zone 2. And, you can select a different source for each room.

## Connecting Zone 2

There are two ways you can connect Zone 2 speakers:

1. Connect them directly to the AV receiver.
2. Connect them to an amp in Zone 2.

### Connecting Your Zone 2 Speakers Directly to the AV receiver

This setup allows 5.1-channel playback in your main room and 2-channel stereo playback in Zone 2, with a different source in each room. This is called Powered Zone 2, as the Zone 2 speakers are powered by the AV receiver. Note that when Powered Zone 2 is turned off, you can enjoy 7.1-channel playback in your main room.

To use this setup, you must set the “Powered Zone2” setting to “Act” (see page 116).

#### Hookup

- Connect your Zone 2 speakers to the AV receiver’s Zone 2 L/R speaker terminals.

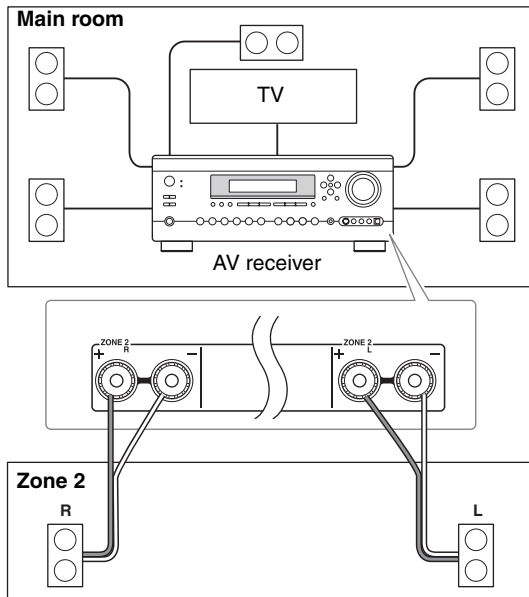

#### Notes:

- With this setup, the Zone 2 volume is controlled by the AV receiver.
- Powered Zone2 cannot be used if “Speakers Type” is set to “Bi-Amp” (see page 45).

### Connecting Your Zone 2 Speakers to an Amp in Zone 2

This setup allows 7.1-channel playback in your main listening room and 2-channel stereo playback in Zone 2, with a different source in each room.

#### Hookup

- Use an RCA audio cable to connect the AV receiver’s ZONE 2 PRE OUT L/R jacks to an analog audio input on your Zone 2 amp.
- Connect your Zone 2 speakers to the speaker terminals on your Zone 2 amp.

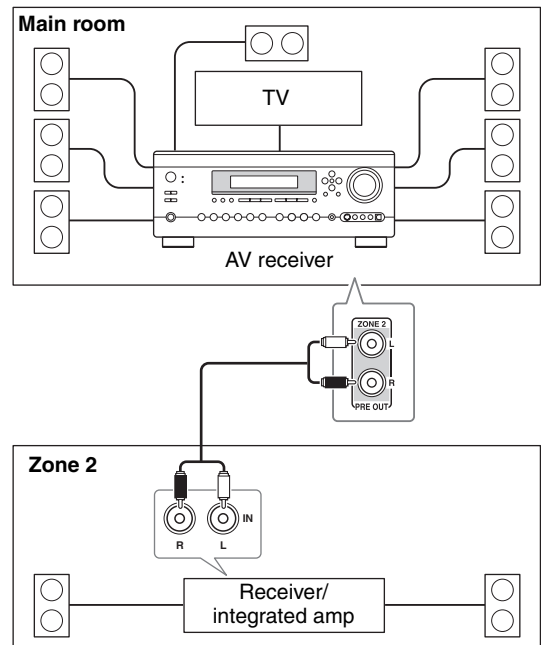

#### Note:

With the default settings, the Zone 2 volume must be set on the Zone 2 amp. If your Zone 2 amp has no volume control, set the “Zone2 Out” setting to “Variable” so that you can set the Zone 2 volume on the AV receiver (see page 117).

## Zone 2—Continued

---

### Zone 2 Video Outputs

The AV receiver features a component video output for connection to a TV in Zone 2, so you can enjoy both audio and video in that zone.

#### Hookup

- Use a component video cable to connect the AV receiver's COMPONENT VIDEO ZONE 2 OUT jacks to a component video input on your Zone 2 TV.

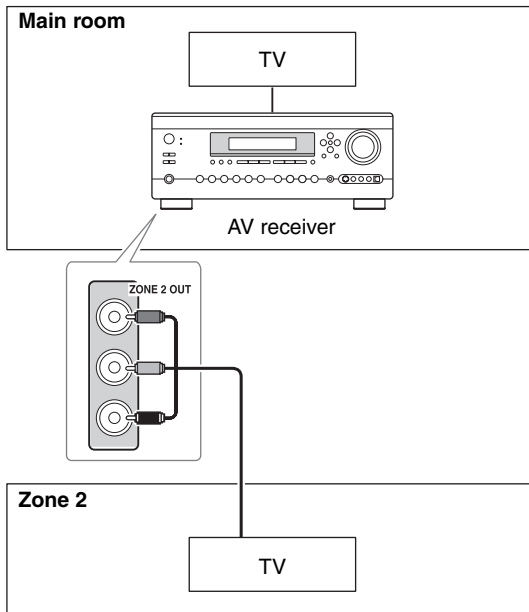

#### Note:

The COMPONENT VIDEO ZONE 2 OUT outputs video only from components connected to component video inputs.

### Setting the Powered Zone 2

If you've connected your Zone 2 speakers to the AV receiver, as explained in "Connecting Your Zone 2 Speakers Directly to the AV receiver" on page 114, you must set the "Powered Zone2" setting to "Act" (Activated).

**1**

**Remote controller**



**Press the [Receiver] button followed by the [Setup] button.**  
The main menu appears onscreen. If the main menu doesn't appear, make sure the appropriate external input is selected on your TV.

**2**

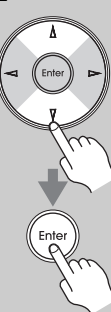

**Use the Up and Down [▲]/[▼] buttons to select "7. Hardware Setup", and then press [Enter].**  
The "Hardware Setup" menu appears.

Integra

7. Hardware Setup

- ▲ 1. Remote Control
- ▼ 2. Zone2
- 3. Tuner
- 4. Analog Multich
- 5. HDMI
- 6. Network

**3**



**Use the Up and Down [▲]/[▼] buttons to select "2. Zone2", and then press [Enter].**  
The "Zone2" menu appears.

Integra

7-2. Zone2

- ▲ Powered Zone2 Not Act ◀▶
- ▼ Zone2 Out Fixed

**4**

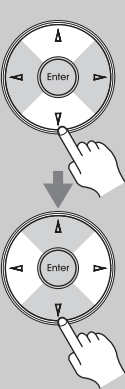

**Use the Up and Down [▲]/[▼] buttons to select "Powered Zone2", and use the Left and Right [◀]/[▶] buttons to select:**

**Not Act:**  
Zone 2 L/R speaker terminals not activated (Powered Zone 2 disabled).

**Act:**  
Zone 2 L/R speaker terminals activated (Powered Zone 2 enabled).

**5**



**Press the [Setup] button.**  
The setup menu closes.

**Notes:**

- When "Act" is selected and Zone 2 turned on, the Zone 2 speakers connected to the Zone 2 L/R speaker terminals output sound, but the surround back speakers connected to the SURR BACK L/R speaker terminals do not. When "Act" is selected and Zone 2 turned off, the surround back speakers output sound as normal.
- Powered Zone2 cannot be used if "Speakers Type" is set to "Bi-Amp" (see page 45).
- This procedure can also be performed on the AV receiver by using its [Setup] button, arrow buttons, and [Enter] button.

## Setting the Zone2 Out

If you've connected your Zone 2 speakers to an amp with no volume control, set the "Zone2 Out" setting, respectively, to "Variable" so that you can set the zone's volume, balance, and tone on the AV receiver.

**1**

Remote controller



**Press the [Receiver] button followed by the [Setup] button.**

The main menu appears onscreen. If the main menu doesn't appear, make sure the appropriate external input is selected on your TV.

**2**

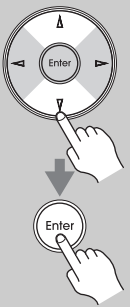

**Use the Up and Down [▲]/[▼] buttons to select "7. Hardware Setup", and then press [Enter].**

The "Hardware Setup" menu appears.

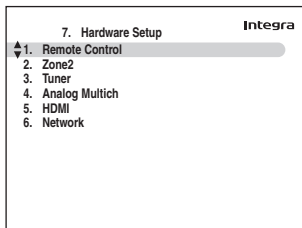

**3**

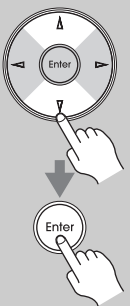

**Use the Up and Down [▲]/[▼] buttons to select "2. Zone2", and then press [Enter].**

The "Zone2" menu appears.

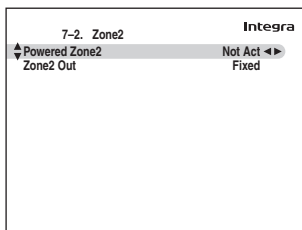

**4**

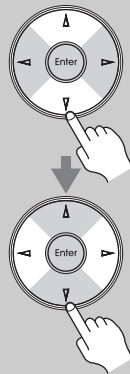

**Use the Up and Down [▲]/[▼] buttons to select "Zone2 Out", and use the Left and Right [◀]/[▶] buttons to select:**

**Fixed:**

The Zone 2 volume must be set on the amp in that zone.

**Variable:**

The Zone 2 volume can be set on the AV receiver.

**5**



**Press the [Setup] button.**

The setup menu closes.

**Note:**

This procedure can also be performed on the AV receiver by using its [Setup] button, arrow buttons, and [Enter] button.

**Using Zone 2**

This section explains how to turn Zone 2 on and off, how to select an input source for Zone 2, and how to adjust the volume for Zone 2.

**Controlling Zone 2 from the AV receiver**

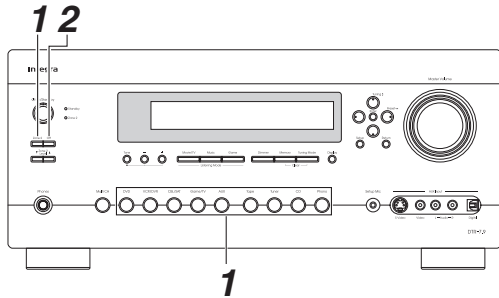

**1** To turn on Zone 2 and select an input source, press the [Zone 2] button repeatedly.



Alternatively, press the [Zone 2] button followed by an input selector button within 8 seconds.

Zone 2 turns on, the Zone 2 indicator lights up.

To select AM or FM press the [Tuner] input selector button repeatedly. On the North American model, you can also select XM or SIRIUS.

To select the same source as that of the main room, press the [Zone 2] button repeatedly until “Z2 Selector: Source” appears on the display.

**Note:**  
You cannot select different AM or FM radio stations for your main room and Zone 2. The same AM/FM radio station will be heard in each room.

**2** To turn off Zone 2, press the [Off] button.



**Note:**  
While Powered Zone 2 is being used, listening modes that require surround back speakers (6.1/7.1), such as Dolby Digital EX, DTS-ES, and THX Ultra2 Cinema, are unavailable.

**Controlling Zone 2 with the Remote Controller**

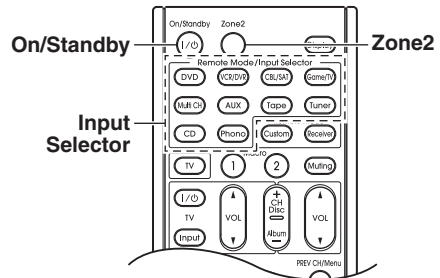

**Note:**  
To control Zone 2, you must press the remote controller's [Zone 2] button first.

**1** Press the [Zone 2] button, then point the remote controller at the AV receiver and press the [On/Standby] button.  
Zone 2 turns on, the Zone 2 indicator lights up.



**2** To select an input source for Zone 2, press the [Zone 2] button, followed by an Input Selector button.

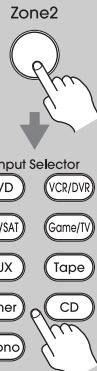

To select AM or FM press the [Tuner] Input Selector button repeatedly. On the North American model, you can also select XM or SIRIUS.

**Note:**  
You cannot select different AM or FM radio stations for your main room and Zone 2. The same AM/FM radio station will be heard in each room.

**3** To turn off Zone 2, press the [Zone 2] button, followed by the [On/Standby] button.



### Adjusting the Volume for Zone 2

**Remote controller Zone2**



**AV receiver Zone 2**



**On the remote controller, press the [Zone 2] button, and then use the VOL [▲]/[▼] button.**

**On the AV receiver, press the [Zone 2] button, and then use the Zone 2 Level Up and Down [▲]/[▼] buttons.**

### Muting Zones

**Remote controller Zone2**



**On the remote controller, press the [Zone 2] button, and then press the [Muting] button.**

**To unmute a zone, on the remote controller, press the [Zone 2] button, and then press the [Muting] button again.**

### Adjusting the Tone and Balance of Zone 2

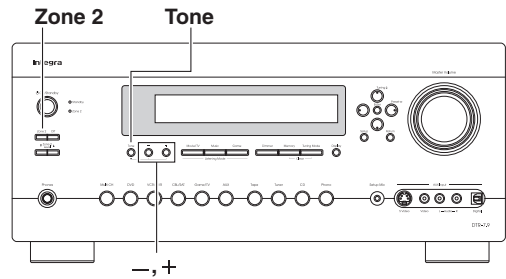

- 1**

**AV receiver**



**On the AV receiver, press the [Zone 2] button.**
- 2**

**Tone**



**Press the AV receiver's [TONE] button repeatedly to select "Bass", "Treble" or "Balance".**
- 3**

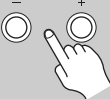

**Use the Tone Plus [ + ] and Minus [ - ] buttons to adjust the Bass, Treble or Balance.**

  - You can boost or cut the Bass or Treble from -10 dB to +10 dB in 2 dB steps.
  - You can adjust the balance from 0 in the center to +10 dB to the right or -10 dB to the left in 2 dB steps.

#### Notes:

- Only analog input sources are output by the ZONE 2 PRE OUT and Zone 2 L/R speaker terminals. Digital input sources are not output. If no sound is heard when an input source is selected, check if it's connected to an analog input.
- While Powered Zone 2 is being used, listening modes that need surround back speakers (i.e., Dolby Digital EX, DTS-ES, and THX Ultra2 Cinema) are unavailable.
- While Zone 2 is on, **RI** functions will not work.
- You cannot select different AM or FM radio stations for your main room and Zone 2. The same AM/FM radio station will be heard in each room. For example, if you have an FM station for the main room, that station will also be used in Zone 2.
- Zones can also be unmuted by adjusting the volume.
- The Zone 2 level, balance, and tone functions have no effect on the ZONE 2 PRE OUT when the "Zone2 Out" setting is set to "Fixed" (page 117).

### Using the 12V Triggers

The 12V triggers A, B, and C can be used to turn on 12V trigger-capable components automatically when they are selected as the input source. The triggers can be set so that they activate when a connected component is selected as the input source for the main room, Zone 2 or any combination of rooms.

When triggered, the output from a 12V TRIGGER OUT goes high (+12 volts, 100 milliamperes max).

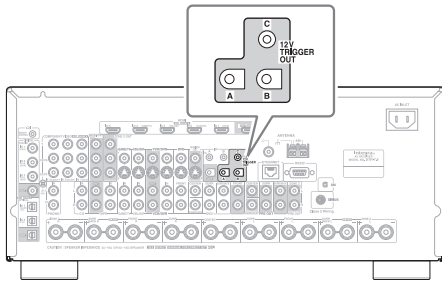

#### Hookup

- Use a miniplug cable to connect the AV receiver's 12V TRIGGER OUT A, B, or C jack to the 12 V trigger input on a connected component.

When several components are turned on simultaneously by using triggers A, B, and C, depending on the type of components, a large amount of current may be drawn momentarily. To prevent this, you can delay trigger signals A, B, and C individually. Another application for trigger delay is eliminating the "thump" noise that's sometimes heard when a source component is turned on. Delaying the trigger signal for your power amplifier so that it's the last component to be turned on will accomplish this.

**1**

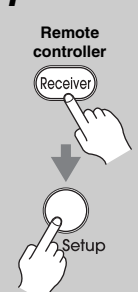

**Remote controller**

Receiver

Setup

**Press the [Receiver] button, followed by the [Setup] button.**  
The main menu appears onscreen.

**2**

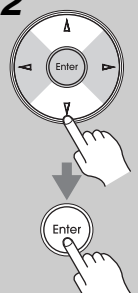

**Use the Up and Down [▲]/[▼] buttons to select "6. Miscellaneous", and then press [Enter].**  
The Miscellaneous menu appears.

**3**

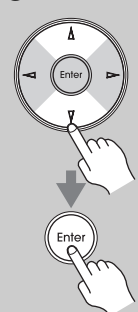

**Use the Up and Down [▲]/[▼] buttons to select "12V Trigger A, B, or C", and then press [Enter].**  
The 12V Trigger A, B, or C Setup screen appears.

6-3. 12V Trigger A Setup		Integra
Delay	0sec	▶
DVD	Main	
VCR/DVR	Main	
CBL/SAT	Main	
GAME/TV	Main	
AUX	Main	
TAPE	Main	
TUNER	Main	
CD	Main	
PHONO	Main	

**4**

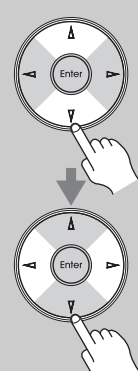

**Use the Up and Down [▲]/[▼] buttons to select "Delay", and use the Left and Right [◀]/[▶] buttons to select: 0 sec, 1 sec, 2 sec, or 3 sec.**  
When 0 sec is selected, the trigger signal is output as soon as the input source is changed.

**5**

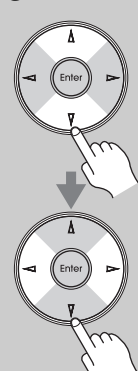

**Use the Up and Down [▲]/[▼] buttons to select an input source, and use the Left and Right [◀]/[▶] buttons to select an option.**

**Off:** No trigger signal is output. A 12-volt trigger signal is output when the connected component is selected as the source for:

**Main:** Main room.  
**Zone2:** Zone 2.  
**Main/Zone2:** Main room or Zone 2.

**Note:**  
By default, all input sources on the 12V Trigger A Setup menu are set to Main, those on the 12V Trigger B Setup menu are set to Main/Zone 2, and those on the 12V Trigger C Setup menu are set to Zone 2.

**6**



**When you've finished, press the [Setup] button.**  
The setup menu closes.



### Using the Remote Controller in Zone 2 and Multiroom Control Kits

To control the AV receiver with the remote controller while you're in the Zone 2 room, you'll need a commercially available multiroom remote control kit.

- Multiroom kits are made by Niles and Xantech. These kits can also be used when there isn't a clear line of sight to the AV receiver's remote sensor, such as when it's installed inside a cabinet.

### Using a Multiroom Kit with Zone 2

In this setup, the IR receiver in Zone 2 picks up the infrared signals from the remote controller and feeds them through the connecting block to the AV receiver in the main room via the connecting block.

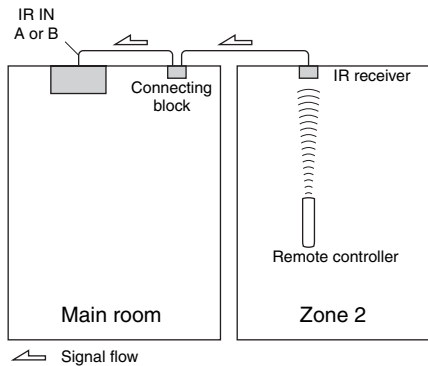

The miniplug cable from the connecting block should be connected to the AV receiver's IR IN A or B jack, as shown below. The IR IN A and B jacks are identical. Up to two IR receivers can be connected.

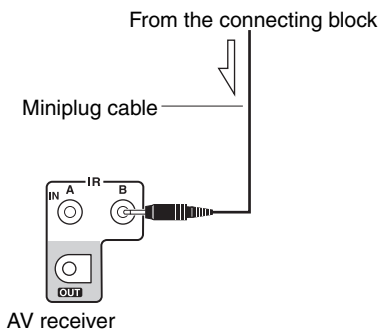

### Using a Multiroom Kit with a Cabinet

In this setup, the IR receiver picks up the infrared signals from the remote controller and feeds them to the AV receiver located in the cabinet via the connecting block.

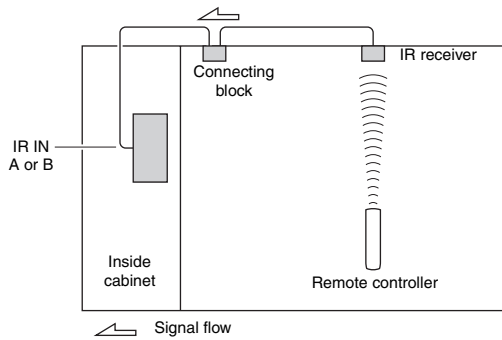

### Using a Multiroom Kit with Other Components

In this setup, an IR emitter is connected to the AV receiver's IR OUT jack and placed in front of the other component's remote control sensor. Infrared signals received at the AV receiver's IR IN A or B jack are fed through to the other component via the IR emitter. Signals picked up by the AV receiver's remote control sensor are not output.

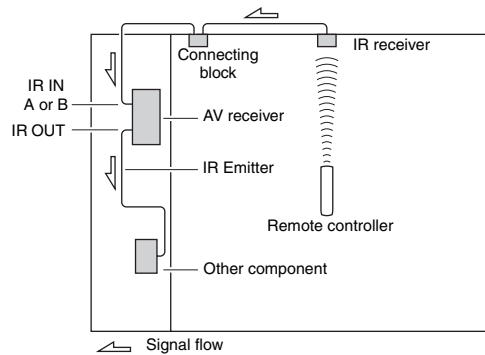

The IR emitter should be connected to the AV receiver's IR OUT jack, as shown below.

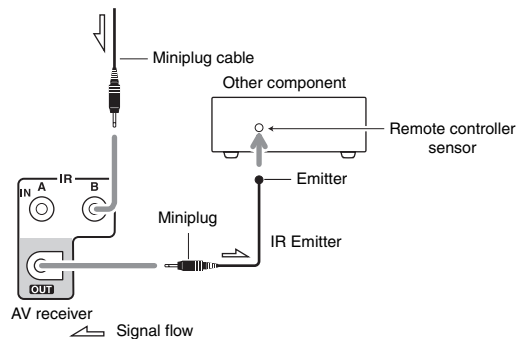

# Controlling Other Components





You can use the AV receiver's remote controller (RC-718M) to control your other AV components, including those made by other manufacturers. This section explains how to:

- Enter the remote control code for a component that you want to control: DVD, TV, VCR, etc.
- Learn commands directly from another component's remote controller (see page 131).
- Program the Macro buttons to perform a sequence of up to eight remote control actions (see page 132).

## Preprogrammed Remote Control Codes

The following Remote Mode buttons are preprogrammed with remote control codes for controlling the components listed. You do not need to enter a remote control code to control these components.

For details on controlling these components, see the pages indicated.

-  Integra/Onkyo DVD player (page 125)
-  Integra/Onkyo CD player (page 128)
-  Onkyo cassette recorder with **RI** (page 130)
-  Onkyo RI Dock with **RI** (page 129)

## Entering Remote Control Codes

You'll need to enter a code for each component that you want to control.

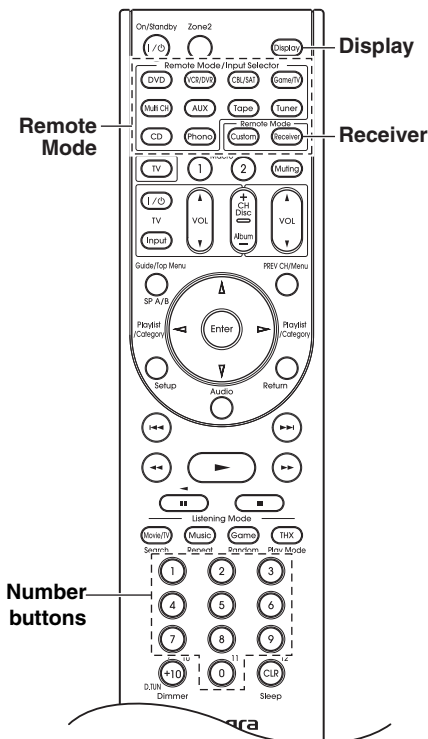

**1**

**Look up the appropriate remote control code in the separate Remote Control Codes list.**

The codes are organized by category (e.g., DVD player, TV, etc.).

**2**



**While holding down the Remote Mode button to which you want to enter a code, press and hold down the [Display] button (about 3 seconds).**

The Remote Mode button lights up.

**Notes:**

- Remote control codes cannot be entered for the [Receiver] and [Zone 2] buttons.
- Only TV remote control codes can be entered for the [TV] button.
- Apart from the [Receiver], [TV], and [Zone 2] buttons, remote control codes from any category can be entered for the Remote Mode buttons. However, these buttons also work as input selector buttons (page 54), so choose a Remote Mode button that corresponds with the input to which you connect your component. For example, if you connect your CD player to the CD input, choose the [CD] button when entering its remote control code.

**3**



**Within 30 seconds, use the number buttons to enter the 5-digit remote control code.**

The Remote Mode button flashes twice.

If the remote control code is not entered successfully, the Remote Mode button will flash once slowly.

**Note:**

The remote control codes provided are correct at the time of printing, but are subject to change.

## Remote Control Codes for Integra/Onkyo Components Connected via RI

Integra/Onkyo components that are connected via **RI** are controlled by pointing the remote controller at the AV receiver, not the component. This allows you to control components that are out of view, in a rack, for example.

### 1 Make sure the Integra/Onkyo component is connected with an RI cable and an analog audio cable (RCA).

See page 38 for details.

### 2 Enter the appropriate remote control code for the Remote Mode button.

- [DVD] button  
31612: Integra/Onkyo DVD player with **RI**
- [CD] button  
71327: Integra/Onkyo CD player with **RI**
- [Tape] button  
42157: Onkyo cassette recorder with **RI** (default)

See the previous page for how to enter remote control codes.

### 3 Press the Remote Mode button, point the remote controller at the AV receiver, and operate the component.

If you want to control an Integra/Onkyo component by pointing the remote controller directly at it, or you want to control an Integra/Onkyo component that's not connected via **RI**, use the following remote control codes:

- [DVD] button  
30627: Integra/Onkyo DVD player without **RI** (default)
- [CD] button  
71817: Integra/Onkyo CD player without **RI** (default)

#### Note:

If you connect an **RI**-capable Onkyo MiniDisc recorder, CD recorder, or RI Dock to the TAPE IN/OUT jacks, or connect an RI Dock to the Game/TV jacks, for **RI** to work properly, you must set the Input Display accordingly (see page 48).

## Resetting Remote Mode Buttons

You can reset a Remote Mode button to its default remote control code.

1



While holding down the Remote Mode button that you want to reset, press and hold down the [Audio] button until the Remote Mode button lights up (about 3 seconds).

2



Within 30 seconds, press the Remote Mode button again.

The Remote Mode button flashes twice, indicating that the button has been reset.

Each of the Remote Mode buttons is preprogrammed with a remote control code. When a button is reset, its preprogrammed code is restored.

## Resetting the Remote Controller

You can reset the remote controller to its default settings.

1



While holding down the [Receiver] button, press and hold down the [Audio] button until the [Receiver] button lights up (about 3 seconds).

2



Within 30 seconds, press the [Receiver] button again.

The [Receiver] button flashes twice, indicating that the remote controller has been reset.

## Controlling a TV

By pressing the [TV] or [Game/TV] buttons that's been programmed with the remote control code for your TV (TV/DVD combination or TV/VCR combination), you can control your TV with the following buttons.

For details on entering a remote control code for a different component, see page 122.

The [TV] and [Game/TV] buttons are preprogrammed with the remote control code for controlling a TV that supports the **RIHD**\*<sup>1</sup>. The TV must be able to receive remote control commands via **RIHD** and be connected to the AV receiver via HDMI. If controlling your TV via **RIHD** doesn't work very well, program your TV's remote control code into the [TV] button and use the TV remote mode to control your TV.

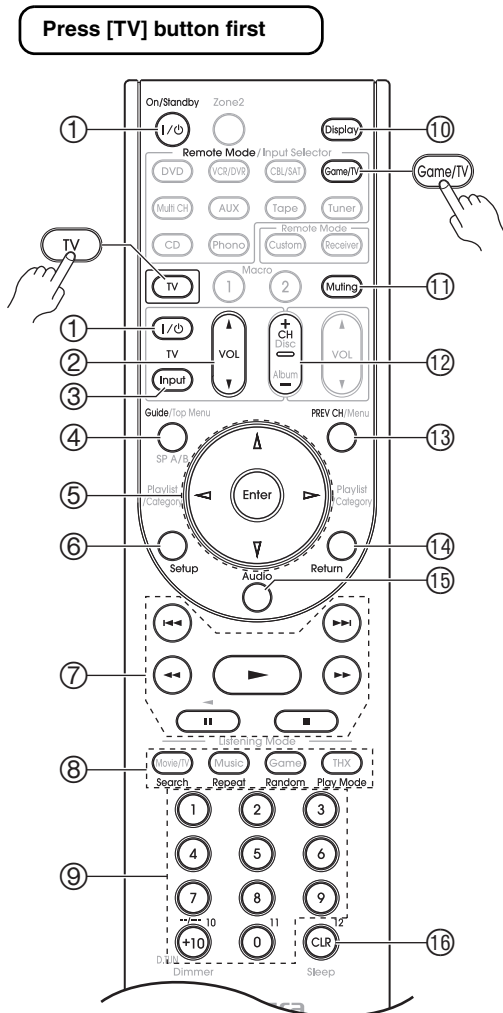

\* With some components, certain buttons may not work as expected, and some may not work at all.

- ① **On/Standby, TV [I/⏻] buttons**  
Set the TV to On or Standby.
- ② **TV VOL [▲]/[▼]**  
Adjust the TV's volume.
- ③ **TV [Input] button**  
Selects the TV's external inputs.
- ④ **Guide button\***  
Displays the program guide.
- ⑤ **Arrow [▲]/[▼]/[◀]/[▶] and Enter buttons\***  
Used to navigate menus and select items.
- ⑥ **Setup button\***  
Displays a menu.
- ⑦ **[▶], [II], [■], [◀◀], [▶▶], [◀◀◀], [▶▶▶] buttons\***  
Play, Pause, Stop, Rewind, Fast forward, Previous, and Next.  
These buttons works for combination devices.
- ⑧ **Search, Repeat, Random, and Play Mode buttons\***  
Function as colored buttons or A, B, C, D buttons.
- ⑨ **Number buttons**  
Enter numbers. 0 button enters 11 on some components. +10 button\* works as “-.-” button or +10.
- ⑩ **Display button**  
Displays information.
- ⑪ **Muting button**  
Mutes the TV.
- ⑫ **CH +/- button**  
Select channels on the TV.
- ⑬ **PREV CH button**  
Selects the previous or last channel.
- ⑭ **Return button\***  
Exits the TV's setup menu.
- ⑮ **Audio button\***  
Selects foreign language soundtracks and audio formats (e.g., Dolby Digital or DTS).
- ⑯ **CLR button\***  
Cancels functions and clears entered numbers, or enters 12.

\* Buttons marked with an asterisk (\*) are not supported by the **RIHD** function.

\*<sup>1</sup> The **RIHD** supported by the AV receiver is the CEC system control function of the HDMI standard.

## Controlling a DVD Player or DVD Recorder

By pressing the Remote Mode button that's been programmed with the remote control code for your DVD player (HD DVD, Blu-ray, or TV/DVD combination), you can control your player with the following buttons. The [DVD] button is preprogrammed with the remote control code for controlling an Integra/Onkyo DVD player.

For details on entering a remote control code for a different component, see page 122.

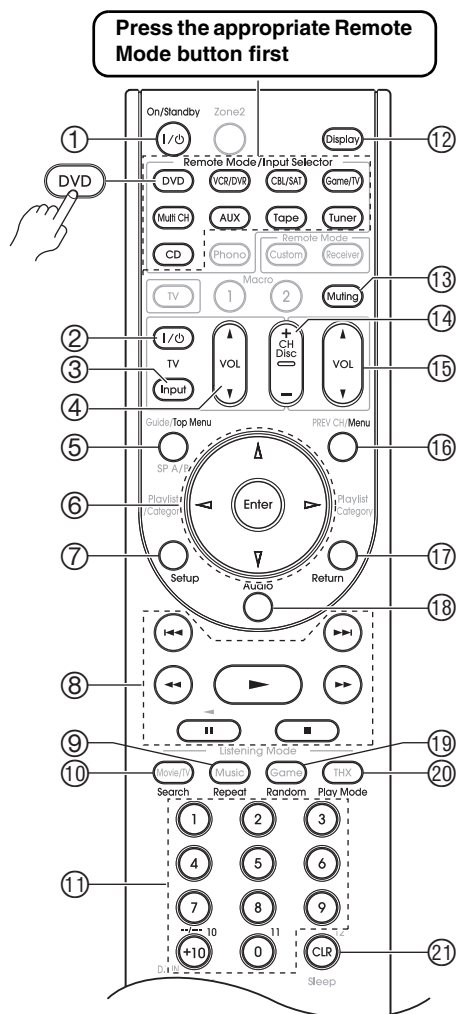

\* With some components, certain buttons may not work as expected, and some may not work at all.

### ① On/Standby button

Sets the DVD player to On or Standby.

### ② TV [I/⏻] buttons

Set the TV to On or Standby.

### ③ TV [Input] button

Selects the TV's external inputs.

### ④ TV VOL [▲]/[▼]

Adjust the TV's volume.

### ⑤ Top Menu button

Displays a DVD's top menu or a DVD's title.

### ⑥ Arrow [▲]/[▼]/[◀]/[▶] and Enter buttons

Used to navigate menus and select items.

### ⑦ Setup button

Used to access the DVD player's settings.

### ⑧ [▶], [⏸], [■], [◀◀], [▶▶], [◀◀◀], [▶▶▶] buttons

Play, Pause, Stop, Rewind, Fast forward, Previous, and Next.

### ⑨ Repeat button

Used with the repeat playback functions.

### ⑩ Search buttons

Used to search title, chapter, and track numbers, and to search times for locating specific points.

### ⑪ Number buttons

Used to enter title, chapter, and track numbers, and to enter times for locating specific points. The [+10] button works as a +10 button or "--" button.

### ⑫ Display button

Displays information about the current disc, title, chapter, or track, including elapsed time, remaining time, total time, and so on.

### ⑬ Muting button (56)

Mutes or unmutes the AV receiver.

### ⑭ Disc +/-, CH +/- button

Selects discs on a DVD changer. Selects TV channels on a component with a built-in tuner.

### ⑮ VOL [▲]/[▼] button (54)

Adjusts the volume of the AV receiver.

### ⑯ Menu button

Displays a DVD's menu.

### ⑰ Return button

Exits the DVD player's setup menu or returns to the previous menu.

### ⑱ Audio button

Selects foreign language soundtracks and audio formats (e.g., Dolby Digital or DTS).

### ⑲ Random button

Used with the random playback function.

### ⑳ Play Mode button

Selects play modes on components with selectable play modes.

### ㉑ CLR button

Cancels functions and clears entered numbers.

### Note:

If you enter the remote control code for a HD DVD or Blu-ray player that has A, B, C, and D or colored buttons, the [Search], [Repeat], [Random], and [Play Mode] buttons will work as colored or A, B, C, D buttons. In this case, these buttons cannot be used to set repeat playback, random playback, or select play modes.

## Controlling a VCR or PVR

By pressing the Remote Mode button that's been programmed with the remote control code for your VCR (TV/VCR, PVR, DBS/PVR combination or cable/PVR combination), you can control your video recorder with the following buttons.

For details on entering a remote control code for a different component, see page 122.

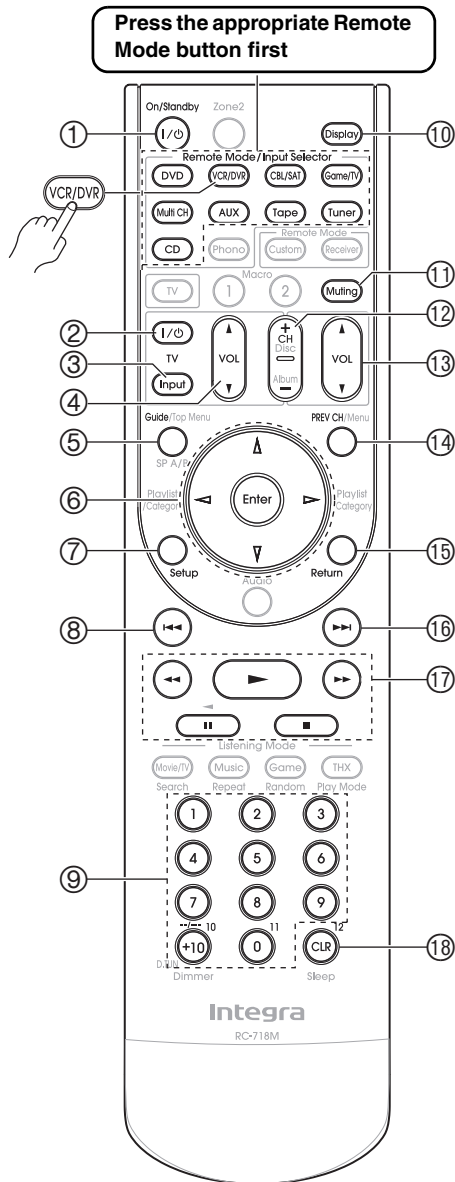

- ① **On/Standby button**  
Set the video recorder to On or Standby.
- ② **TV [I/⏻] buttons**  
Set the TV to On or Standby.
- ③ **TV [Input] button**  
Selects the TV's external inputs.
- ④ **TV VOL [▲]/[▼]**  
Adjust the TV's volume.
- ⑤ **Guide button**  
Displays the program guide or navigation list.
- ⑥ **Arrow [▲]/[▼]/[◀]/[▶] and Enter buttons**  
Used to navigate menus and select items.
- ⑦ **Setup button**  
Displays the video recorders setup menu.
- ⑧ **Previous [◀◀] button**  
Previous or instant replay function.
- ⑨ **Number button**  
Enter numbers. The [0] button enters 11 on some components. The [+10] button works as a +10 button or "--" button.
- ⑩ **Display button**  
Displays information.
- ⑪ **Muting button (56)**  
Mutes or unmutes the AV receiver.
- ⑫ **CH +/- button**  
Selects TV channels on the video recorder.
- ⑬ **VOL [▲]/[▼] button (54)**  
Adjusts the volume of the AV receiver.
- ⑭ **PREV CH button**  
Selects the previous channel.
- ⑮ **Return button**  
Exits the menu or returns to the previous menu.
- ⑯ **Next [▶▶] button**  
Next or advance function.
- ⑰ **Playback button**  
From left to right: Rewind, Pause, Play, Stop, and Fast Forward.
- ⑱ **CLR button**  
Cancels functions or enters the number 12.

\* With some components, certain buttons may not work as expected, and some may not work at all.

## Controlling a Satellite Receiver or Cable Receiver

By pressing the Remote Mode button that's been programmed with the remote control code for your satellite receiver, cable receiver, or DVD recorder (DBS/PVR combination or cable/PVR combination), you can control your player with the following buttons.

For details on entering a remote control code for a different component, see page 122.

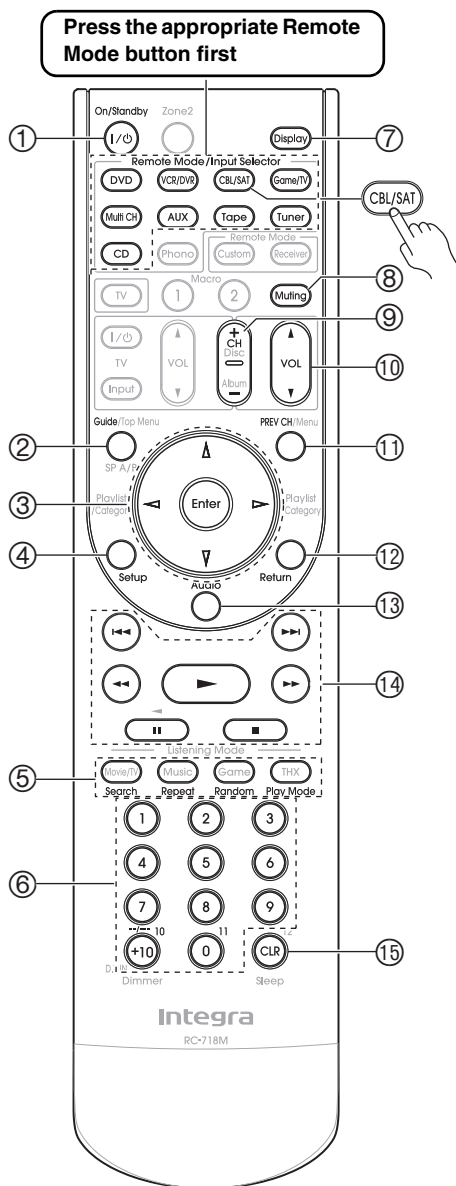

- ① **On/Standby button**  
Set the video recorder to On or Standby.
- ② **Guide button**  
Displays the onscreen program guide.
- ③ **Arrow [▲]/[▼]/[◀]/[▶] and Enter buttons**  
Used to navigate menus and select items.
- ④ **Setup button**  
Displays the setup menu.
- ⑤ **Search, Repeat, Random, and Play Mode buttons**  
Function as colored buttons or A, B, C, D buttons.
- ⑥ **Number buttons**  
Enter numbers. The [+10] button works as a +10 button or “-.-” button.
- ⑦ **Display button**  
Displays information.
- ⑧ **Muting button (56)**  
Mutes or unmutes the AV receiver.
- ⑨ **CH +/- button**  
Selects satellite/cable channels.
- ⑩ **VOL [▲]/[▼] button (54)**  
Adjusts the volume of the AV receiver.
- ⑪ **PREV CH button**  
Selects the previous channel.
- ⑫ **Return button**  
Exits the menu.
- ⑬ **Audio button**  
Selects foreign language soundtracks and audio formats (e.g., Dolby Digital or DTS).
- ⑭ **[▶], [⏸], [■], [◀◀], [▶▶], [◀◀▶], [▶▶◀] buttons**  
Play, Pause, Stop, Rewind, Fast forward, Previous, and Next.
- ⑮ **CLR button**  
Cancels functions and clears entered numbers.

\* With some components, certain buttons may not work as expected, and some may not work at all.

## Controlling a CD Player, CD Recorder, or MD Player

By pressing the Remote Mode button that's been programmed with the remote control code for your CD player, CD recorder, or MD player, you can control your player with the following buttons.

The [CD] button is preprogrammed with the remote control code for controlling an Integra/Onkyo CD player. For details on entering a remote control code for a different component, see page 122.

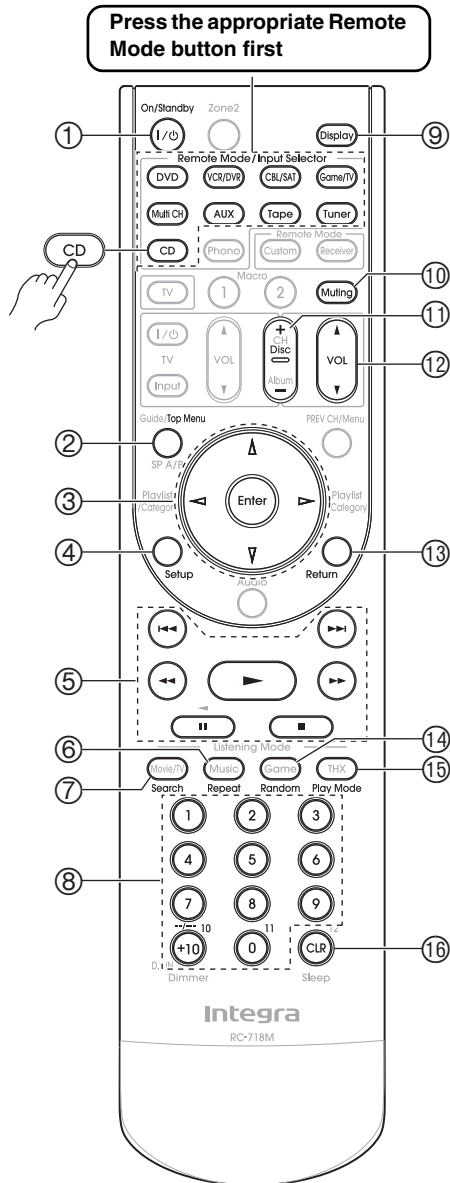

- ① **On/Standby button**  
Set the video recorder to On or Standby.
- ② **Top Menu button**  
Displays a menu.
- ③ **Arrow [▲]/[▼]/[◀]/[▶] and Enter buttons**  
Used to navigate menus and select items.
- ④ **Setup button**  
Used to access the Integra/Onkyo CD player's settings.
- ⑤ **[▶], [||], [■], [◀◀], [▶▶], [◀◀], [▶▶] buttons**  
Play, Pause, Stop, Rewind, Fast forward, Previous, and Next.
- ⑥ **Repeat button**  
Used with the repeat playback function.
- ⑦ **Search buttons**  
Used to locate specific points.
- ⑧ **Number buttons**  
Used to enter track numbers and times for locating specific points. The [+10] button works as a +10 button or "-.-" button.
- ⑨ **Display button**  
Displays information about the current disc or track, including elapsed time, remaining time, total time, and so on.
- ⑩ **Muting button (56)**  
Mutes or unmutes the AV receiver.
- ⑪ **Disc +/- button**  
Selects discs on a CD changer.
- ⑫ **VOL [▲]/[▼] button (54)**  
Adjusts the volume of the AV receiver.
- ⑬ **Return button**  
Exits the menu.
- ⑭ **Random button**  
Used with the random playback function.
- ⑮ **Play Mode button**  
Selects play modes on components with selectable play modes.
- ⑯ **CLR button**  
Cancels functions and clears entered numbers.

\* With some components, certain buttons may not work as expected, and some may not work at all.



## Controlling an RI Dock

By pressing the Remote Mode button that's been programmed with the remote control code for your RI Dock, you can control your iPod in the RI Dock with the following buttons.

The [Custom] button is preprogrammed with the remote control code for controlling an RI Dock.

For details on entering a remote control code, see page 122.

### When Using an RI Dock:

- Connect the RI Dock to the TAPE IN or GAME/TV IN L/R jacks.
- Set the RI Dock's RI MODE switch to HDD or HDD/DOCK.
- Set the AV receiver's Input Display to DOCK (see page 48).
- See to the RI Dock's instruction manual for more information.

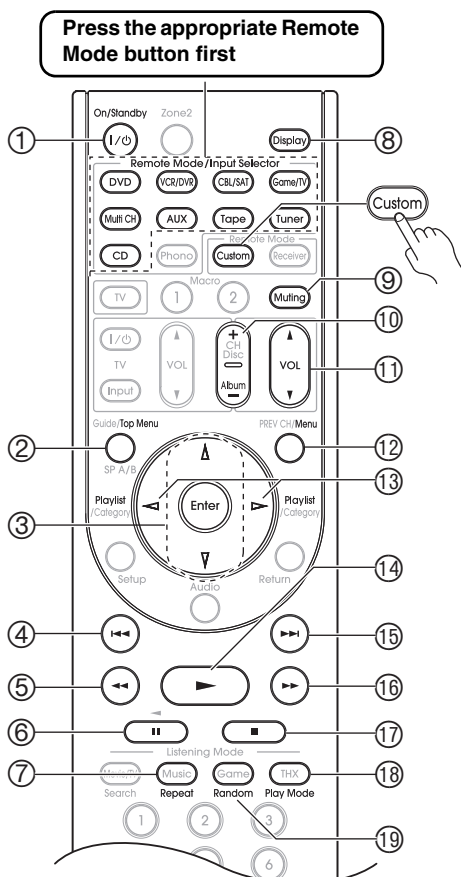

\* With some components, certain buttons may not work as expected, and some may not work at all.

- On/Standby button**  
Turns the iPod on or off.

### Notes:

- This button does not turn the Onkyo DS-A2 or DS-A2X RI Dock on or off.
- Your iPod may not respond the first time you press this button, in which case you should press it again.

This is because the remote controller transmits the On and Standby commands alternately, so if your iPod is already on, it will remain on when the remote controller transmits an On command. Similarly, if your iPod is already off, it will remain off when the remote controller transmits an Off command.

- Top Menu button**  
Works as a Mode button when used with a DS-A2 RI Dock.
  - Arrow [▲]/[▼] and Enter buttons\***  
Used to navigate menus and select items.
  - Previous [◀◀] button**  
Restarts the current song. Press it twice to select the previous song.
  - Rewind [◀◀] button**  
Press and hold to rewind.
  - Pause [⏸] button**  
Pauses playback. (With 3rd generation iPod models, it works as a Play/Pause button.)
  - Repeat button\***  
Used with the repeat function.
  - Display button\***  
Turns on the backlight for 30 seconds.
  - Muting button (56)**  
Mutes or unmutes the AV receiver.
  - Album +/- button\***  
Selects the next or previous album.
  - VOL [▲]/[▼] button (54)**  
Adjusts the volume of the AV receiver.
  - Menu button\***  
Exits the menu.
  - Playlist [◀]/[▶] buttons\***  
Selects the previous or next playlist on the iPod.
  - Play [▶] button**  
Starts playback. If the component is off, it will turn on automatically. (With 3rd generation iPod models, this button works as a Play/Pause button.)
  - Next [▶▶] button**  
Selects the next song.
  - Fast Forward [▶▶] button**  
Press and hold to fast forward.
  - Stop [■] button**  
Stops playback and displays a menu.
  - Play Mode button**  
Selects play modes on components with selectable play modes.  
Works as a Resume button when used with a DS-A2 RI Dock.
  - Random button\***  
Used with the shuffle function.
- \* Buttons marked with an asterisk (\*) are not supported by 3rd generation iPod models.

## Controlling a Cassette Recorder

By pressing the Remote Mode button that's been programmed with the remote control code for your cassette recorder, you can control your cassette recorder with the following buttons.

The [Tape] button is preprogrammed with the remote control code for controlling an Onkyo cassette recorder when used with an **RI** connection.

For details on entering a remote control code for a different component, see page 122.

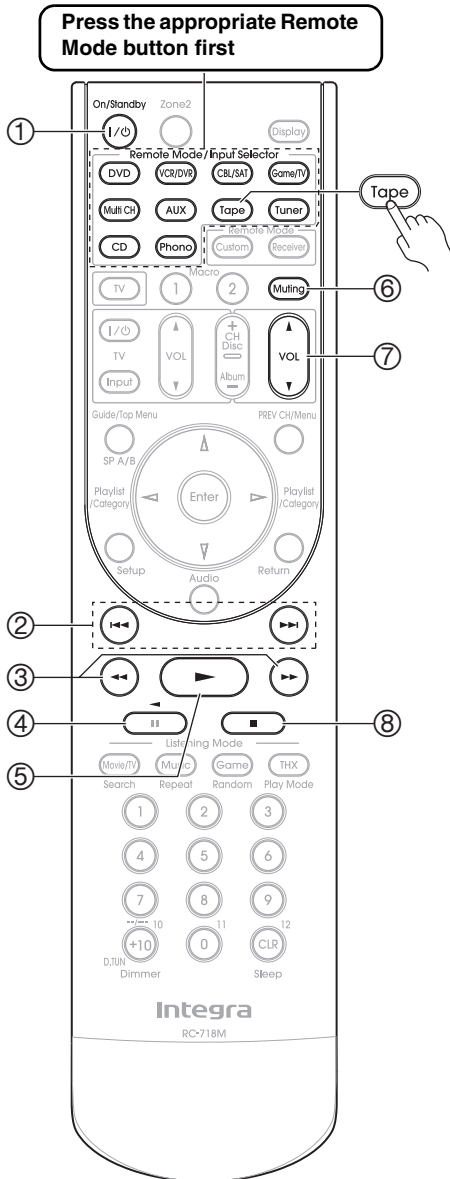

On twin cassette decks, only Deck B can be controlled.

- ① **On/Standby button**  
Turns the cassette recorder on or off.
- ② **Previous and Next [◀◀]/[▶▶] buttons**  
The Previous [◀◀] button selects the previous track. During playback it selects the beginning of the current track. The Next [▶▶] button selects the next track.  
Depending on how they were recorded, the Previous and Next [◀◀]/[▶▶] buttons may not work properly with some cassette tapes.
- ③ **Rewind and Fast Forward [◀◀]/[▶▶] buttons**  
The Rewind [◀◀] button starts rewind. The Fast Forward [▶▶] button starts fast forward.
- ④ **Reverse Play [◀] button**  
Starts reverse playback.
- ⑤ **Play [▶] button**  
Starts playback.
- ⑥ **Muting button (56)**  
Mutes or unmutes the AV receiver.
- ⑦ **VOL [▲]/[▼] button (54)**  
Adjusts the volume of the AV receiver.
- ⑧ **Stop [■] button**  
Stops playback.

**Note:**

An Onkyo cassette recorder connected via **RI** can also be controlled in Receiver mode.

\* With some components, certain buttons may not work as expected, and some may not work at all.

## Learning Commands

The AV receiver's remote controller can learn the commands of other remote controllers. By transmitting, for example, the Play command from your CD player's remote controller, the remote controller can learn it, and then transmit the exact same command when its Play [▶] button is pressed in the CD remote mode.

This is useful when you've entered the appropriate remote control code (page 122) but some buttons don't work as expected.

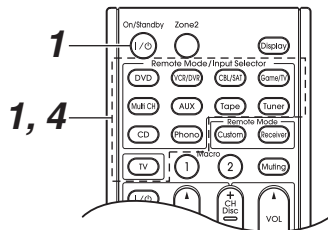

**1** While holding down the Remote Mode button for the mode in which you want to use the command, press and hold down the [On/Standby] button until the Remote Mode button lights up (about 3 seconds).



**2** On the supplied remote controller, press the button you want to learn the new command.

**3** Point the remote controllers at each other, about 2 to 6 inches (5–15 cm) apart, and then press and hold the button whose command you want to learn until the Remote Mode button flashes.

If the command is learned successfully, the Remote Mode button flashes twice.

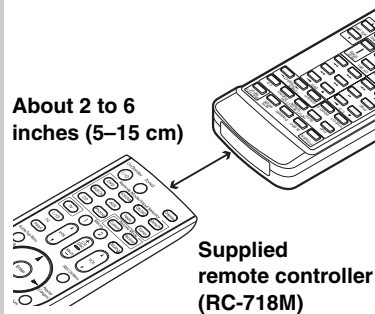

**4** To learn more commands, repeat steps 2 and 3.

Press any Remote Mode button when you've finished. The Remote Mode button flashes twice.

### Notes:

- The following buttons cannot learn new commands: Remote Mode, Macro [1], [2].
- The remote controller can learn approximately 70 to 90 commands, although this will be less if commands that use a lot of memory are learned.
- Remote controller buttons such as Play, Stop, Pause, and so on are preprogrammed with commands for controlling Onkyo CD players, cassette decks, and DVD players. However, they can learn new commands, and you can restore the preprogrammed commands at any time by resetting the remote controller (see page 123).
- To overwrite a previously learned command, repeat this procedure.
- Depending on the remote controller that you are using, there may be some buttons that won't work as expected, or even some remotes that cannot be learned at all.
- Only commands from infrared remote controllers can be learned.
- When the remote controller's batteries expire, all learned commands will be lost and will have to be learned all over again, so don't discard your other remote controllers.

### ■ Deleting Learning Commands

1. While holding down the Remote Mode button for the mode in which you want to delete the command, press and hold down the TV [I/⏻] button until the Remote Mode button lights up (about 3 seconds).
2. Press the Remote Mode button or the button from which you want to delete the commands. The Remote Mode button flashes twice. When you press the Remote Mode button, all commands learned in that remote mode will be deleted.

## Using Macros

You can program the remote controller's Macro buttons to perform a sequence of remote control actions.

### Example:

To play a CD you typically need to perform the following actions:

1. Press the [Receiver] button to select the Receiver remote controller mode.
2. Press the [On/Standby] button to turn on the AV receiver.
3. Press the [CD] button to select the CD input source.
4. Press the Play [▶] button to start playback on the CD player.

You can program a Macro button so that all four actions are performed with just one button press.

## Making Macros

Each Macro button can store one macro, and each macro can contain up to 32 commands.

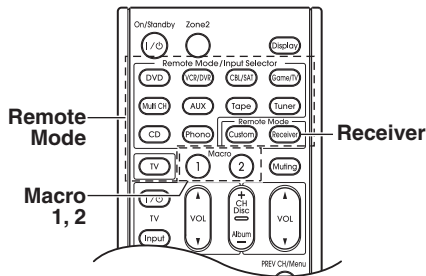

**1**

(3 seconds)

**While holding down the [Receiver] button, press and hold down the Macro button [1] or [2] until the [Receiver] button lights up (about 3 seconds).**

**2**

**Press the buttons whose actions you want to program into the macro in the order you want them performed.**

For the CD example above, you'd press the following buttons: [On/Standby], [CD], Play [▶].

**3**

**When you've finished, press the Macro button again.**

The Remote Mode button flashes twice.

If you enter 32 commands, the process will finish automatically.

**Note:**  
If any of the buttons you used to make a macro are taught new commands, the macro will no longer work properly and will have to be made again.

## Running Macros

**1**

**Press the Macro [1] or [2] button.**

The commands in the macro are transmitted in the order in which they were programmed. Keep the remote controller pointed at the AV receiver until all of the commands have been transmitted.

Macros can be run at any time, regardless of the current remote controller mode.

## Deleting Macros

**1**

(3 seconds)

**While holding down the [Receiver] button, press and hold down the Macro button whose macro you want to delete until the [Receiver] button lights up (about 3 seconds).**

**2**

**Press the Macro button again.**

The [Receiver] button flashes twice.

# Specifications

## Amplifier Section

### Rated Output Power

#### All channels:

North American:  
**130 watts minimum continuous power per channel, 8 ohm loads, 2 channels driven from 20 Hz to 20 kHz, with a maximum total harmonic distortion of 0.08% (FTC)**  
**145 watts minimum continuous power per channel, 8 ohm loads, 2 channels driven at 1 kHz, with a maximum total harmonic distortion of 0.7% (FTC)**  
**160 watts minimum continuous power per channel, 6 ohm loads, 2 channels driven at 1 kHz, with a maximum total harmonic distortion of 0.1% (FTC)**

Australian:  
7 ch × 180 W at 6 ohms, 1 kHz, 1 ch driven (IEC)

### Maximum Output Power

7 ch × 230 W at 6 ohms, 1 kHz, 1 ch driven (JEITA)

### Dynamic Power

300 W (3 Ω, Front)  
250 W (4 Ω, Front)  
150 W (8 Ω, Front)

### THD (Total Harmonic Distortion)

0.08% (Power Rated)

### Damping Factor

60 (Front, 1 kHz, 8 Ω)

### Input Sensitivity and Impedance

200 mV/47 kΩ (LINE)  
2.5 mV/47 kΩ (PHONO MM)

### Phono Overload

70 mV (MM 1 kHz, 0.5%)

### Output Level and Impedance

200 mV/470 Ω (REC OUT)

### Frequency Response

5 Hz - 100 kHz/+1 dB - 3 dB (Direct mode)

### Tone Control

±10 dB, 50 Hz (BASS)  
±10 dB, 20 kHz (TREBLE)

### Signal to Noise Ratio

110 dB (LINE, IHF-A)  
80 dB (PHONO, IHF-A)

### Speaker Impedance

4 Ω - 16 Ω

## Video Section

### Input Sensitivity/Output Level and Impedance

1 V<sub>p-p</sub>/75 Ω (Component and S-Video Y)  
0.7 V<sub>p-p</sub>/75 Ω (Component P<sub>B</sub>/C<sub>B</sub>, P<sub>R</sub>/C<sub>R</sub>)  
0.28 V<sub>p-p</sub>/75 Ω (S-Video C)  
1 V<sub>p-p</sub>/75 Ω (Composite)

### Component Video Frequency Response

5 Hz - 50 MHz - 3 dB

## Tuner Section

### FM Tuning Frequency Range

North American:  
87.5 MHz - 107.9 MHz  
Australian: 87.50 MHz - 108.00 MHz, RDS

### AM Tuning Frequency Range

North American: 530 kHz - 1710 kHz  
Australian: 522/530 kHz - 1611/1710 kHz

### Preset Channel

40

### Digital Tuner (North American models only):

XM, SIRIUS

## General

### Power Supply

North American: AC 120 V, 60 Hz  
Australian: AC 220 - 240 V, 50/60 Hz

### Power Consumption

North American: 7.8 A  
Australian: 740 W

### Dimensions (W × H × D)

435 × 194 × 427 mm  
17-1/8" × 7-5/8" × 16-13/16"

### Weight

North American: 16.8 kg (37.1 lbs.)  
Australian: 17.4 kg (38.4 lbs.)

## Video Inputs

### HDMI

IN 1, IN 2, IN 3, IN 4, IN 5

### Component

IN 1, IN 2, IN 3

### S-Video

DVD, VCR/DVR, CBL/SAT, GAME/TV, AUX

### Composite

DVD, VCR/DVR, CBL/SAT, GAME/TV, AUX

## Video Outputs

### HDMI

OUT

### Component

MONITOR OUT, ZONE2 OUT

### S-Video

MONITOR OUT, VCR/DVR OUT

### Composite

MONITOR OUT, VCR/DVR OUT

## Audio Inputs

### Digital Inputs

Optical: 2 (Rear), 1 (Front)  
Coaxial: 3

### Analog Inputs

DVD (Multichannel), VCR/DVR, CBL/SAT, GAME/TV, AUX, TAPE, CD, PHONO

### Multichannel Inputs

7.1

## Audio Outputs

### Digital Outputs

Optical: 1  
Coaxial: 1

### Analog Outputs

TAPE, VCR/DVR, ZONE2 PRE OUT, PRE OUT

### Multichannel Pre Outputs

7

### Subwoofer Pre Output

1

### Speaker Outputs

Main (L, R, C, SL, SR, SBL, SBR) + ZONE2 (L, R)

### Phones

1

## Control Terminal

### MIC

Yes

### RS232

1

### Ethernet

1

### IR Input/Output

2/1

### 12 V Trigger Out

3

Specifications and features are subject to change without notice.

# Troubleshooting

If you have any trouble using the AV receiver, look for a solution in this section. If you can't resolve the issue yourself, contact the dealer.

If you can't resolve the issue yourself, try resetting the AV receiver before contacting the dealer.

**To reset the AV receiver to its factory defaults, turn it on and, while holding down the [VCR/DVR] button, press the [On/Standby] button. "Clear" will appear on the display and the AV receiver will enter Standby mode.**



Note that resetting the AV receiver will delete your radio presets and custom settings.

## Power

### Can't turn on the AV receiver

- Make sure that the power cord is properly plugged into the wall outlet.
- Unplug the power cord from the wall outlet, wait five seconds or more, then plug it in again.

### The AV receiver turns off as soon as it's turned on

- The amp protection circuit has been activated. Remove the power cord from the wall outlet immediately. Disconnect all speaker cables and input sources, and leave the AV receiver with its power cord disconnected for 1 hour. After that, reconnect the power cord and set the volume to maximum. If the AV receiver stays on, set the volume to minimum, disconnect the power cord, and reconnect your speakers and input sources. If the AV receiver turns off when you set the volume to maximum, disconnect the power cord, and contact the dealer.

## Audio

### There's no sound, or it's very quiet

- Make sure that the digital input source is selected properly (page 44).
- Make sure that all audio connecting plugs are pushed in all the way (page 21).
- Make sure that the inputs and outputs of all components are connected properly (page 24-37).
- Make sure that the polarity of the speaker cables is correct, and that the bare wires are in contact with the metal part of each speaker terminal (page 17).
- Make sure that the input source is properly selected (page 54).
- Make sure that the speaker cables are not shorting.
- Check the volume. It can be set to  $-\infty$  dB,  $-81.5$  dB through  $+18.0$  dB (page 54). The AV receiver is

designed for home theater enjoyment. It has a wide volume range, allowing precise adjustment.

- While a pair of headphones is connected to the Phones jack, no sound is output by the speakers (page 56).
- If there's no sound from a DVD player connected to an HDMI IN, check the DVD player's output settings, and be sure to select a supported audio format.
- Check the digital audio output setting on the connected device. On some game consoles, such as those that support DVD, the default setting is off.
- With some DVD-Video discs, you need to select an audio output format from a menu.
- If your turntable uses an MC cartridge, you must connect an MC head amp, or an MC transformer.
- Make sure that none of the connecting cables are bent, twisted, or damaged.
- Not all listening modes use all speakers (page 86).
- Specify the speaker distances (page 93) and adjust the individual speaker levels (page 94).
- Make sure that the speaker setup microphone is not still connected.
- The input signal format is set to PCM or DTS. Set it to Auto (page 113).

### Only the front speakers produce sound

- When the Stereo listening mode is selected, only the front speakers and subwoofer produce sound.
- In the Mono listening mode, only the front speakers output sound if the "Output Speaker" setting is set to "Left/Right" (page 98).
- Check the Speaker Configuration (page 90).

### Only the center speaker produces sound

- If you use the Dolby Pro Logic IIx Movie, Dolby Pro Logic IIx Music, or Dolby Pro Logic IIx Game listening mode with a mono source, such as an AM radio station or mono TV program, the sound is concentrated in the center speaker.
- In the Mono listening mode, only the front speakers output sound if the "Output Speaker" setting is set to "Center" (page 98).
- Make sure the speakers are configured correctly (page 90).

### The surround speakers produce no sound

- When the Stereo or Mono listening mode is selected, the surround speakers produce no sound.
- Depending on the source and current listening mode, not much sound may be produced by the surround speakers. Try selecting another listening mode.
- Make sure the speakers are configured correctly (page 90).

### The center speaker produces no sound

- When the Stereo listening mode is selected, the center speaker produces no sound.
- In the Mono listening mode, only the front speakers output sound if the “Output Speaker” setting is set to “Left/Right” (page 98).
- Make sure the speakers are configured correctly (page 90).

### The surround back speakers produce no sound

- The surround back speakers are not used with all listening modes. Select another listening mode (page 86).
- Not much sound may be produced by the surround back speakers with some sources.
- Make sure the speakers are configured correctly (page 90).
- While Powered Zone 2 is being used, playback in the main room is reduced to 5.1-channels and the surround back speakers produce no sound (page 114).

### The subwoofer produces no sound

- When you play source material that contains no information in the LFE channel, the subwoofer produces no sound.
- Make sure the speakers are configured correctly (page 90).

### There’s no sound with a certain signal format

- Check the digital audio output setting on the connected device. On some game consoles, such as those that support DVD, the default setting is off.
- With some DVD-Video discs, you need to select an audio output format from a menu.
- Depending on the input signal, some listening modes cannot be selected (pages 80-85).

### Can’t get 6.1/7.1 playback

- If no surround back speakers are connected, or the Zone 2 speakers are being used, 6.1/7.1 playback is not possible.
- You can not always select all of the listening modes, depending on the number of the speakers connected (pages 80-85).

### The speaker volume cannot be set as required (The volume cannot be set to +18.0 dB)

- Check to see if a maximum volume has been set (page 106).
- After the Automatic Speaker Setup function has been run, or the volume level of each individual speaker has been adjusted (page 94), the maximum volume may be reduced.
- When the “Equalizer Settings” (page 95) is set to “Audyssey”, the maximum possible volume is reduced by 6 dB.

### Noise can be heard

- Using cable ties to bundle audio cables with power cords, speaker cables, and so on may degrade the audio performance, so don’t do it.

- An audio cable may be picking up interference. Try repositioning your cables.

### The Late Night function doesn’t work

- Make sure the source material is Dolby Digital, Dolby Digital Plus, and Dolby TrueHD (page 100).

### The DVD analog multichannel input doesn’t work

- Check the DVD analog multichannel input connections (page 26).
- To select the DVD analog multichannel input, press the [Multi CH] input selector button.
- Make sure that the “Speakers Type” is not set to “Bi-Amp”. The multichannel DVD input cannot be used if “Speakers Type” is set to “Bi-Amp” (page 45).
- Check the audio output settings on your DVD player.

### About DTS signals

- When DTS program material ends and the DTS bitstream stops, the AV receiver remains in DTS listening mode and the DTS indicator remains on. This is to prevent noise when you use the pause, fast forward, or fast reverse function on your player. If you switch your player from DTS to PCM, because the AV receiver does not switch formats immediately, you may not hear any sound, in which case you should stop your player for about three seconds, and then resume playback.
- With some CD and LD players, you won’t be able to playback DTS material properly even though your player is connected to a digital input on the AV receiver. This is usually because the DTS bitstream has been processed (e.g., output level, sampling rate, or frequency response changed) and the AV receiver doesn’t recognize it as a genuine DTS signal. In such cases, you may hear noise.
- When playing DTS program material, using the pause, fast forward, or fast reverse function on your player may produce a short audible noise. This is not a malfunction.

### The beginning of audio received by an HDMI IN can’t be heard

- Since it takes longer to identify the format of an HDMI signal than it does for other digital audio signals, audio output may not start immediately.

## Video

### There’s no picture

- Make sure that all video connecting plugs are pushed in all the way (page 21).
- Make sure that each video component is properly connected. (pages 24-37)

- If your TV is connected to the HDMI OUT, set the Monitor Out setting to “HDMI” (page 40), and select “- - - -” in the “HDMI Input Setup” on page 42 to watch composite video, S-Video, and component video sources.
- If your TV is connected to the COMPONENT VIDEO MONITOR OUT or COMPONENT VIDEO ZONE 2 OUT, set the Monitor Out setting to “Analog” (page 40), and select “- - - -” in the “Component Video Setup” on page 43 to watch composite video and S-Video sources.
- If the video source is connected to a component video input, you must assign that input to an input selector (page 43), and your TV must be connected to either the HDMI OUT or COMPONENT VIDEO MONITOR OUT (pages 24 and 33).
- If the video source is connected to an HDMI input, you must assign that input to an input selector (page 42), and your TV must be connected to the HDMI OUT (page 33).
- On your TV, make sure that the video input to which the AV receiver is connected is selected.

### There’s no picture from a source connected to an HDMI IN

- Reliable operation with an HDMI-to-DVI adapter is not guaranteed. In addition, video signals from a PC are not supported (page 33).
- When the “Monitor Out” is set to “Analog” (page 40), or the “Output Resolution” (page 109) is set to any resolution not supported by the TV, no video is output by the HDMI OUT.

### The onscreen menus don’t appear

- If your TV is connected to the analog outputs, set the “Monitor Out” setting to “Analog” (page 40).
- On non-North American models, specify the TV system used in your area in the “TV Format Setup” on page 46.
- On your TV, make sure that the video input to which the AV receiver is connected is selected.

### The picture is distorted

- On non-North American models, specify the TV system used in your area in the “TV Format Setup” on page 46.

### The immediate display does not appear

- The immediate display will not appear when the input signal from the COMPONENT VIDEO IN is output to a device connected to the COMPONENT VIDEO MONITOR OUT.
- Depending on the input signal, the immediate display may not appear when the input signal from the HDMI IN is output to a device connected to the HDMI OUT.

## Tuner

### Reception is noisy, FM stereo reception is noisy, or the FM STEREO indicator doesn’t appear

- Relocate your antenna.
- Move the AV receiver away from your TV or computer.
- Listen to the station in mono (page 57).
- When listening to an AM station, operating the remote controller may cause noise.
- Passing cars and airplanes can cause interference.
- Concrete walls weaken radio signals.
- If nothing improves the reception, install an outdoor antenna.

## Remote Controller

### The remote controller doesn’t work

- Make sure that the batteries are installed with the correct polarity (page 13).
- Install new batteries. Don’t mix different types of batteries, or old and new batteries (page 13).
- Make sure that the remote controller is not too far away from the AV receiver, and that there’s no obstruction between the remote controller and the AV receiver’s remote control sensor (page 13).
- Make sure that the AV receiver is not subjected to direct sunshine or inverter-type fluorescent lights. Relocate if necessary.
- If the AV receiver is installed in a rack or cabinet with colored-glass doors, the remote controller may not work reliably when the doors are closed.
- Make sure you’ve selected the correct remote controller mode (pages 14 and 124-130).
- When using the remote controller to control other manufacturers’ AV components, some buttons may not work as expected.
- Make sure you’ve entered the correct remote control code.
- Make sure to set the same ID on both the AV receiver and remote controller (page 108).

### Can’t control other components

- If it’s an Integra/Onkyo component, make sure that the **RI** cable and analog audio cable are connected properly. Connecting only an **RI** cable won’t work (page 38).
- Make sure you’ve selected the correct remote controller mode (pages 14 and 124-130).
- If you’ve connected an **RI**-capable Onkyo MD recorder, CD recorder, **RI** Dock to the TAPE IN/OUT jacks, or an **RI** Dock to the GAME/TV IN jacks, for the remote controller to work properly, you must set the display to MD, CDR, or DOCK (page 48). If you cannot operate it, you will need to enter the appropriate remote control code (page 122).
- To control another manufacturer’s component, point the remote controller at that component.



- To control an Integra/Onkyo component that's connected via **RI**, point the remote controller at the AV receiver. Be sure to enter the appropriate remote control code first (page 123).
- To control an Integra/Onkyo component that's not connected via **RI**, or another manufacturer's component, point the remote controller at the component. Be sure to enter the appropriate remote control code first (page 122).
- The entered remote control code may not be correct. If more than one code is listed, try each one.
- If none of the codes work, use the Learning function to learn the commands of the other component's remote controller (page 131).

### Can't learn commands from another remote controller

- When learning commands, make sure that the transmitting ends of both remote controllers are pointing at each other.
- Are you trying to learn from a remote controller that cannot be used for learning? Some commands cannot be learned, especially those that contain several instructions.

## Recording

### Can't record

- On your recorder, make sure the correct input is selected.

## Zone 2

### There's no sound

- Only components connected to analog inputs can be played in Zone 2.

## Others

### The sound changes when I connect my headphones

- When a pair of headphones is connected, the listening mode is set to Stereo, unless it's already set to Stereo, Mono, or Direct.

### How do I change the language of a multiplex source

- Use the "Multiplex" setting on the "Audio Adjust" menu to select "Main" or "Sub" (page 98).

### The **RI** functions don't work

- To use **RI**, you must make an **RI** connection and an analog audio connection (RCA) between the component and AV receiver, even if they are connected digitally (page 38).

### The functions Auto Power On/Standby and Direct Change don't work for components connected via **RI**

- These functions don't work when Zone 2 is turned on.

### When performing "Automatic Speaker Setup", the measurement fails showing the message "Ambient noise is too high".

- This can be caused by any malfunction in your speaker unit. Check if the unit produces normal sounds.

### The following settings can be made for the S-Video and composite video inputs

You must use the buttons on the unit to make these settings.

1. While holding down the input selector button for the input source that you want to set, press the [Setup] button.
2. Use the Left and Right [◀]/[▶] buttons to change the setting.
3. Press the [Setup] button when you've finished.

#### • Video Attenuation

This setting can be made for the DVD, VCR/DVR, CBL/SAT, GAME/TV, or AUX input.

If you have a games console connected to the S-Video or composite video input, and the picture isn't very clear, you can attenuate the gain.

**Video ATT:OFF:** (default).

**Video ATT:ON:** Gain is reduced by 2 dB.

The AV receiver contains a microcomputer for signal processing and control functions. In very rare situations, severe interference, noise from an external source, or static electricity may cause it to lockup. In the unlikely event that this happens, unplug the power cord from the wall outlet, wait at least five seconds, and then plug it back in again.

Integra/Onkyo is not responsible for damages (such as CD rental fees) due to unsuccessful recordings caused by the unit's malfunction. Before you record important data, make sure that the material will be recorded correctly.

Set the AV receiver to Standby before disconnecting the power cord from the wall outlet.

### Important Note Regarding Video Playback

The AV receiver can upconvert component video, S-Video, and composite video sources for display on a TV connected to the HDMI OUT. However, if the picture quality of the source is poor, upconversion may make the picture worse or disappear altogether.

In this case, try setting the “HDMI Output Resolution” setting (page 109) to “480p” or “720p”. If that doesn’t improve the picture quality, try the following:

**1 If the video source is connected to a component video input, connect your TV to the COMPONENT VIDEO MONITOR OUT.**

**If the video source is connected to an S-Video input, connect your TV to an S-Video output.**

**If the video source is connected to a composite video input, connect your TV to a composite video output.**

**2 On the main menu, select “1. Input Assign,” and then select “1. HDMI Input.”**  
**Select the relevant input selector, and assign it to “- - - -” (page 42).**

**3 On the main menu, select “1. Input Assign,” and then select “2. Component Video Input” (page 43):**

If the video source is connected to COMPONENT VIDEO IN1, select the relevant input selector, and assign it to “IN1”.

If the video source is connected to COMPONENT VIDEO IN2, select the relevant input selector, and assign it to “IN2”.

If the video source is connected to COMPONENT VIDEO IN3, select the relevant input selector, and assign it to “IN3”.

If the video source is connected to an S-Video input or composite video input, select the relevant input selector, and assign it to “- - - -”.

# Video Resolution Chart

The following tables show how video signals at different resolutions are output by the AV receiver.

✓: Output

## NTSC

Output Input		HDMI <sup>*1</sup>					COMPONENT				S-VIDEO	COMPOSITE
		1080p	1080i	720p	480p	480i	1080i	720p	480p	480i	480i	480i
HDMI	1080p	✓										
	1080i	✓	✓	✓								
	720p	✓	✓	✓								
	480p	✓	✓	✓	✓							
	480i	✓	✓	✓	✓	✓						
COMPONENT	1080i	✓	✓	✓			✓					
	720p	✓	✓	✓				✓				
	480p	✓	✓	✓	✓				✓			
	480i	✓	✓	✓	✓	✓				✓		
S-VIDEO	480i	✓	✓	✓	✓	✓	✓	✓	✓	✓		✓
COMPOSITE	480i	✓	✓	✓	✓	✓	✓	✓	✓	✓		✓

## PAL

Output Input		HDMI <sup>*1</sup>					COMPONENT				S-VIDEO	COMPOSITE
		1080p	1080i	720p	576p	576i	1080i	720p	576p	576i	576i	576i
HDMI	1080p	✓										
	1080i	✓	✓	✓								
	720p	✓	✓	✓								
	576p	✓	✓	✓	✓							
	576i	✓	✓	✓	✓	✓						
COMPONENT	1080i	✓	✓	✓			✓					
	720p	✓	✓	✓				✓				
	576p	✓	✓	✓	✓				✓			
	576i	✓	✓	✓	✓	✓				✓		
S-VIDEO	576i	✓	✓	✓	✓	✓	✓	✓	✓	✓		✓
COMPOSITE	576i	✓	✓	✓	✓	✓	✓	✓	✓	✓		✓

\*1 The video signal is output only when the "Monitor Out" setting is set to "HDMI".

■ : The video signal is output only when the "Monitor Out" setting is set to "Analog".

■ : The video signal will be output only when the "Monitor Out" setting is set to "Analog" and the "Output Resolution" setting is set to "Through".

Integra Division of  
**ONKYO U.S.A. CORPORATION**  
18 park Way, Upper Saddle River, N.J. 07458, U.S.A.  
Tel: 201-818-9200 Fax: 201-785-2650 <http://www.integrahometheater.com>

Integra Division of  
**ONKYO CORPORATION**  
Sales & Product Planning Div.: 2-1, Nisshin-cho, Neyagawa-shi, OSAKA 572-8540, JAPAN  
Tel: 072-831-8023 Fax: 072-831-8163



Y0810-2

SN 29344745A

(C) Copyright 2008 ONKYO CORPORATION Japan. All rights reserved.



\* 2 9 3 4 4 7 4 5 A \*

Download from [Www.Somanuals.com](http://www.Somanuals.com). All Manuals Search And Download.

## Free Manuals Download Website

<http://myh66.com>

<http://usermanuals.us>

<http://www.somanuals.com>

<http://www.4manuals.cc>

<http://www.manual-lib.com>

<http://www.404manual.com>

<http://www.luxmanual.com>

<http://aubethermostatmanual.com>

Golf course search by state

<http://golfingnear.com>

Email search by domain

<http://emailbydomain.com>

Auto manuals search

<http://auto.somanuals.com>

TV manuals search

<http://tv.somanuals.com>