

# ONKYO®

## AV Receiver

# TX-NR709

## Instruction Manual

Thank you for purchasing an Onkyo AV Receiver. Please read this manual thoroughly before making connections and plugging in the unit. Following the instructions in this manual will enable you to obtain optimum performance and listening enjoyment from your new AV Receiver. Please retain this manual for future reference.

## Contents

Introduction .....2

Connections..... 12

Turning On & Basic Operations .....22

Advanced Operations .....43

Controlling Other Components...66

Appendix .....74



## WARNING:

TO REDUCE THE RISK OF FIRE OR ELECTRIC SHOCK, DO NOT EXPOSE THIS APPARATUS TO RAIN OR MOISTURE.

## CAUTION:

TO REDUCE THE RISK OF ELECTRIC SHOCK, DO NOT REMOVE COVER (OR BACK). NO USER-SERVICEABLE PARTS INSIDE. REFER SERVICING TO QUALIFIED SERVICE PERSONNEL.



**WARNING**  
RISK OF ELECTRIC SHOCK  
DO NOT OPEN

**AVIS**  
RISQUE DE CHOC ELECTRIQUE  
NE PAS OUVRIR



The lightning flash with arrowhead symbol, within an equilateral triangle, is intended to alert the user to the presence of uninsulated "dangerous voltage" within the product's enclosure that may be of sufficient magnitude to constitute a risk of electric shock to persons.



The exclamation point within an equilateral triangle is intended to alert the user to the presence of important operating and maintenance (servicing) instructions in the literature accompanying the appliance.

## Important Safety Instructions

1. Read these instructions.
2. Keep these instructions.
3. Heed all warnings.
4. Follow all instructions.
5. Do not use this apparatus near water.
6. Clean only with dry cloth.
7. Do not block any ventilation openings. Install in accordance with the manufacturer's instructions.
8. Do not install near any heat sources such as radiators, heat registers, stoves, or other apparatus (including amplifiers) that produce heat.
9. Do not defeat the safety purpose of the polarized or grounding-type plug. A polarized plug has two blades with one wider than the other. A grounding type plug has two blades and a third grounding prong. The wide blade or the third prong are provided for your safety. If the provided plug does not fit into your outlet, consult an electrician for replacement of the obsolete outlet.
10. Protect the power cord from being walked on or pinched particularly at plugs, convenience receptacles, and the point where they exit from the apparatus.
11. Only use attachments/accessories specified by the manufacturer.
12. Use only with the cart, stand, tripod, bracket, or table specified by the manufacturer, or sold with the apparatus. When a cart is used, use caution when moving the cart/apparatus combination to avoid injury from tip-over.  

PORTABLE CART WARNING  
S3125A
13. Unplug this apparatus during lightning storms or when unused for long periods of time.
14. Refer all servicing to qualified service personnel. Servicing is required when the apparatus has been damaged in any way, such as power-supply cord or plug is damaged, liquid has been spilled or objects have fallen into the apparatus, the apparatus has been exposed to rain or moisture, does not operate normally, or has been dropped.
15. Damage Requiring Service  
Unplug the apparatus from the wall outlet and refer servicing to qualified service personnel under the following conditions:
  - A. When the power-supply cord or plug is damaged,
  - B. If liquid has been spilled, or objects have fallen into the apparatus,
  - C. If the apparatus has been exposed to rain or water,
  - D. If the apparatus does not operate normally by following the operating instructions. Adjust only those controls that are covered by the operating instructions as an improper adjustment of other controls may result in damage and will often require extensive work by a qualified technician to restore the apparatus to its normal operation,
  - E. If the apparatus has been dropped or damaged in any way, and
  - F. When the apparatus exhibits a distinct change in performance this indicates a need for service.
16. Object and Liquid Entry  
Never push objects of any kind into the apparatus through openings as they may touch dangerous voltage points or short-out parts that could result in a fire or electric shock.  
The apparatus shall not be exposed to dripping or splashing and no objects filled with liquids, such as vases shall be placed on the apparatus.  
Don't put candles or other burning objects on top of this unit.
17. Batteries  
Always consider the environmental issues and follow local regulations when disposing of batteries.
18. If you install the apparatus in a built-in installation, such as a bookcase or rack, ensure that there is adequate ventilation.  
Leave 20 cm (8") of free space at the top and sides and 10 cm (4") at the rear. The rear edge of the shelf or board above the apparatus shall be set 10 cm (4") away from the rear panel or wall, creating a flue-like gap for warm air to escape.

# Precautions

---

1. **Recording Copyright**—Unless it's for personal use only, recording copyrighted material is illegal without the permission of the copyright holder.
2. **AC Fuse**—The AC fuse inside the unit is not user-serviceable. If you cannot turn on the unit, contact your Onkyo dealer.
3. **Care**—Occasionally you should dust the unit all over with a soft cloth. For stubborn stains, use a soft cloth dampened with a weak solution of mild detergent and water. Dry the unit immediately afterwards with a clean cloth. Don't use abrasive cloths, thinners, alcohol, or other chemical solvents, because they may damage the finish or remove the panel lettering.

## 4. Power

### WARNING

BEFORE PLUGGING IN THE UNIT FOR THE FIRST TIME, READ THE FOLLOWING SECTION CAREFULLY.

AC outlet voltages vary from country to country. Make sure that the voltage in your area meets the voltage requirements printed on the unit's rear panel (e.g., AC 230 V, 50 Hz or AC 120 V, 60 Hz).

The power cord plug is used to disconnect this unit from the AC power source. Make sure that the plug is readily operable (easily accessible) at all times.

Pressing the [ON/STANDBY] button to select Standby mode does not fully disconnect from the mains. If you do not intend to use the unit for an extended period, remove the power cord from the AC outlet.

## 5. Preventing Hearing Loss

### Caution

Excessive sound pressure from earphones and headphones can cause hearing loss.

## 6. Batteries and Heat Exposure

### Warning

Batteries (battery pack or batteries installed) shall not be exposed to excessive heat as sunshine, fire or the like.

7. **Never Touch this Unit with Wet Hands**—Never handle this unit or its power cord while your hands are wet or damp. If water or any other liquid gets inside this unit, have it checked by your Onkyo dealer.

## 8. Handling Notes

- If you need to transport this unit, use the original packaging to pack it how it was when you originally bought it.
- Do not leave rubber or plastic items on this unit for a long time, because they may leave marks on the case.
- This unit's top and rear panels may get warm after prolonged use. This is normal.
- If you do not use this unit for a long time, it may not work properly the next time you turn it on, so be sure to use it occasionally.

## For U.S. models

### FCC Information for User

#### CAUTION:

The user changes or modifications not expressly approved by the party responsible for compliance could void the user's authority to operate the equipment.

#### NOTE:

This equipment has been tested and found to comply with the limits for a Class B digital device, pursuant to Part 15 of the FCC Rules. These limits are designed to provide reasonable protection against harmful interference in a residential installation.

This equipment generates, uses and can radiate radio frequency energy and, if not installed and used in accordance with the instructions, may cause harmful interference to radio communications. However, there is no guarantee that interference will not occur in a particular installation. If this equipment does cause harmful interference to radio or television reception, which can be determined by turning the equipment off and on, the user is encouraged to try to correct the interference by one or more of the following measures:

- Reorient or relocate the receiving antenna.
- Increase the separation between the equipment and receiver.
- Connect the equipment into an outlet on a circuit different from that to which the receiver is connected.
- Consult the dealer or an experienced radio/TV technician for help.

## For Canadian Models

**NOTE:** THIS CLASS B DIGITAL APPARATUS COMPLIES WITH CANADIAN ICES-003.

For models having a power cord with a polarized plug:

**CAUTION:** TO PREVENT ELECTRIC SHOCK, MATCH WIDE BLADE OF PLUG TO WIDE SLOT, FULLY INSERT.

## Modèle pour les Canadien

**REMARQUE:** CET APPAREIL NUMÉRIQUE DE LA CLASSE B EST CONFORME À LA NORME NMB-003 DU CANADA.

Sur les modèles dont la fiche est polarisée:

**ATTENTION:** POUR ÉVITER LES CHOCS ÉLECTRIQUES, INTRODUIRE LA LAME LA PLUS LARGE DE LA FICHE DANS LA BORNE CORRESPONDANTE DE LA PRISE ET POUSSER JUSQU'AU FOND.

## For British models

Replacement and mounting of an AC plug on the power supply cord of this unit should be performed only by qualified service personnel.

### IMPORTANT

The wires in the mains lead are coloured in accordance with the following code:

Blue: Neutral

Brown: Live

As the colours of the wires in the mains lead of this apparatus may not correspond with the coloured markings identifying the terminals in your plug, proceed as follows:

The wire which is coloured blue must be connected to the terminal which is marked with the letter N or coloured black.

The wire which is coloured brown must be connected to the terminal which is marked with the letter L or coloured red.

### IMPORTANT

The plug is fitted with an appropriate fuse. If the fuse needs to be replaced, the replacement fuse must be approved by ASTA or BSI to BS1362 and have the same ampere rating as that indicated on the plug. Check for the ASTA mark or the BSI mark on the body of the fuse.

If the power cord's plug is not suitable for your socket outlets, cut it off and fit a suitable plug. Fit a suitable fuse in the plug.

## For European Models

### Declaration of Conformity

We, ONKYO EUROPE  
ELECTRONICS GmbH  
LIEGNITZERSTRASSE 6,  
82194 GROEBENZELL,  
GERMANY



declare in own responsibility, that the ONKYO product described in this instruction manual is in compliance with the corresponding technical standards such as EN60065, EN55013, EN55020 and EN61000-3-2, -3-3.

GROEBENZELL, GERMANY

K. MIYAGI

ONKYO EUROPE ELECTRONICS GmbH

## Supplied Accessories

Make sure you have the following accessories:

Indoor FM antenna (→ page 21)

AM loop antenna (→ page 21)

Power cord (European, Australian, Asian and Taiwan models) (→ page 21)

Speaker cable labels (→ page 13)

Speaker setup microphone (→ page 31)

Remote controller (RC-807M) and two batteries (AA/R6)

(Note for China: The battery for the remote controller is not supplied for this unit.)

\* In catalogs and on packaging, the letter at the end of the product name indicates the color. Specifications and operations are the same regardless of color.

### ■ Installing the batteries

#### Note

- If the remote controller doesn't work reliably, try replacing the batteries.
- Don't mix new and old batteries or different types of batteries.
- If you intend not to use the remote controller for a long time, remove the batteries to prevent damage from leakage or corrosion.
- Remove expired batteries as soon as possible to prevent damage from leakage or corrosion.

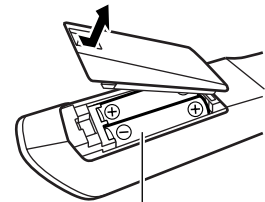

Batteries (AA/R6)

### ■ Aiming the remote controller

To use the remote controller, point it at the AV receiver's remote control sensor, as shown below.

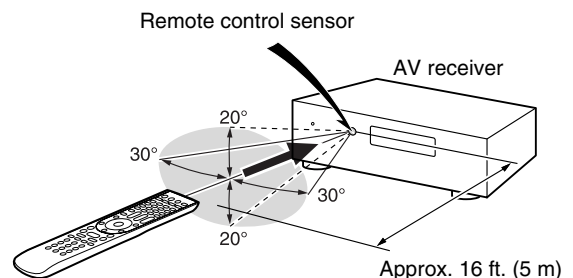

# Contents

## Introduction

Important Safety Instructions .....	2
Precautions.....	3
Supplied Accessories.....	4
Features .....	6
Front & Rear Panels.....	8
Front Panel.....	8
Display.....	9
Rear Panel .....	10
Remote Controller .....	11
Controlling the AV Receiver .....	11

## Connections

Connecting the AV Receiver.....	12
Connecting Your Speakers .....	12
About AV Connections .....	16
Connecting Components with HDMI .....	17
Connecting Your Components .....	18
Connecting Onkyo <b>RI</b> Components .....	20
Connecting a Recording Component .....	20
Connecting the Antennas .....	21
Connecting the Power Cord .....	21

## Turning On & Basic Operations

Turning On/Off the AV Receiver .....	22
Turning On .....	22
Turning Off .....	22
Playback.....	23
Selecting the Language for the Onscreen Setup Menus.....	23
Playing the Connected Component.....	23
Controlling Contents of USB or Network Devices .....	23
Understanding Icons on the Display.....	24
Playing an iPod/iPhone via USB .....	24
Playing a USB Device .....	25
Listening to Internet Radio .....	25
Playing Music Files on a Server .....	27
Remote Playback .....	27
Listening to AM/FM Radio .....	28
Using Basic Functions .....	31
Using the Automatic Speaker Setup .....	31
Using the Listening Modes .....	34
Using the Home Menu.....	40
Using the Sleep Timer.....	40
Setting the Display Brightness .....	40
Displaying Source Information .....	41
Changing the Input Display .....	41
Selecting Speaker Layout .....	41
Muting the AV Receiver.....	41
Using Headphones.....	41
Using Easy Macros .....	42
Recording .....	42

## Advanced Operations

Advanced Setup .....	43
On-screen Setup Menus.....	43
Common Procedures in Setup Menu .....	43
Input/Output Assign .....	44
Speaker Setup .....	46
Audio Adjust .....	50
Source Setup .....	52
Listening Mode Preset.....	56
Miscellaneous .....	57
Hardware Setup.....	57
Remote Controller Setup .....	61
Lock Setup.....	61
Using the Audio Settings .....	61
Zone 2.....	63
Making Zone 2 Connections.....	63
Controlling Zone 2 Components.....	64
Using the Remote Controller in Zone 2 and Multiroom Control Kits .....	65

## Controlling Other Components

iPod/iPhone Playback via Onkyo Dock .....	66
Using the Onkyo Dock.....	66
Controlling Your iPod/iPhone .....	67
Controlling Other Components.....	69
Preprogrammed Remote Control Codes .....	69
Looking up for Remote Control Code .....	69
Entering Remote Control Codes.....	69
Remote Control Codes for Onkyo Components Connected via <b>RI</b> .....	70
Resetting REMOTE MODE Buttons .....	70
Resetting the Remote Controller .....	70
Controlling Other Components .....	70
Learning Commands .....	72
Using Normal Macros .....	73

## Appendix

Troubleshooting .....	74
Firmware Update .....	80
Connection Tips and Video Signal Path .....	83
Using an RIHD-compatible TV, Player, or Recorder ...	86
About HDMI.....	88
Network/USB Features.....	89
Specifications .....	92

To reset the AV receiver to its factory defaults, turn it on and, while holding down VCR/DVR, press **⏻ ON/STANDBY** (→ page 74).

# Features

---

## Amplifier

---

- 110 Watts/Channel @ 8 ohms (FTC)
- 170 Watts/Channel @ 6 ohms (IEC)
- 185 Watts/Channel @ 6 ohms (JEITA)
- WRAT—Wide Range Amplifier Technology (5 Hz to 100 kHz bandwidth)
- Linear Optimum Gain Volume Circuitry
- 3-Step Inverted Darlington Circuitry
- H.C.P.S. (High Current Power Supply) Massive High Power Transformer
- Jitter Cleaning Circuit Technology

## Processing

---

- THX Select2 Plus<sup>\*1</sup> Certified
- Incorporates Qdeo™<sup>2</sup> technology for HDMI Video Upscaling (to 4K Compatible)
- HDMI (Audio Return Channel, 3D, DeepColor, x.v.Color<sup>3</sup>, Lip Sync, DTS<sup>4</sup>-HD Master Audio, DTS-HD High Resolution Audio, Dolby TrueHD<sup>5</sup>, Dolby Digital Plus, DSD and Multi-CH PCM)
- Dolby Pro Logic IIz<sup>5</sup> and Audyssey DSX™<sup>6</sup>
- Non-Scaling Configuration
- A-Form Listening Mode Memory
- Direct Mode
- Pure Audio Mode
- Music Optimizer<sup>7</sup> for Compressed Digital Music files
- 192 kHz/24-bit D/A Converters
- Powerful and Highly Accurate 32-bit Processing DSP

## Connections

---

- 8 HDMI<sup>8</sup> Inputs (1 on front panel) and 2 Outputs
- Onkyo **RIHD** for System Control
- 5 Digital Inputs (2 Optical/3 Coaxial)
- Component Video Switching (2 Inputs/1 Output)
- Universal Port for the Dock for iPod®/iPhone®<sup>9</sup>/HD Radio™<sup>10</sup> tuner module (**North American models**)/ DAB+ tuner module (**European, Australian and Asian models**)
- Banana Plug-Compatible Speaker Posts<sup>\*11</sup>
- Powered Zone 2
- Bi-Amping Capability for FL/FR with SBL/SBR
- Analog RGB Video Input (D-sub 15) for PC
- Internet Radio Connectivity (SiriusXM Internet Radio/vTuner/Last.fm/Pandora/Rhapsody/Slacker/Mediafly/Napster)
- \* Services available may vary depending on the region.
- Network Capability for Streaming Audio Files<sup>\*12</sup>
- Front-Panel USB Input for Memory Devices and iPod®/iPhone®<sup>9</sup> models (Enables Display of Album Artwork)

## Miscellaneous

---

- 40 AM/FM Presets
- Dolby Volume<sup>\*5</sup>
- Audyssey MultEQ® XT<sup>\*6</sup> to correct room acoustic problems
- Audyssey Dynamic EQ®<sup>6</sup> for loudness correction
- Audyssey Dynamic Volume®<sup>6</sup> to maintain optimal listening level and dynamic range
- Crossover Adjustment (40/50/60/70/80/90/100/120/150/200 Hz)
- A/V Sync Control Function (up to 800 ms)
- Auto Standby Function
- On-Screen Display via HDMI
- Preprogrammed (with onscreen display setup) RI-Compatible Learning Remote with 4 Activities and Mode-Key LEDs

\*1  THX and the THX logo are trademarks of THX Ltd. which may be registered in some jurisdictions. All rights reserved.

### THX Select2 Plus

Before any home theater component can be THX Select2 Plus certified, it must pass a rigorous series of quality and performance tests. Only then can a product feature the THX Select2 Plus logo, which is your guarantee that the Home Theater products you purchase will give you superb performance for many years to come. THX Select2 Plus requirements define hundreds of parameters, including power amplifier performance, and pre-amplifier performance and operation for both digital and analog domains. THX Select2 Plus receivers also feature proprietary THX technologies (e.g., THX Mode) which accurately translate movie soundtracks for home theater playback.

\*2 Qdeo and QuietVideo are trademarks of Marvell or its affiliates.

\*3 "x.v.Color" is a trademark of Sony Corporation.

\*4 

Manufactured under license under U.S. Patent #'s: 5,451,942; 5,956,674; 5,974,380; 5,978,762; 6,226,616; 6,487,535; 7,212,872; 7,333,929; 7,392,195; 7,272,567 & other U.S. and worldwide patents issued & pending. DTS and the Symbol are registered trademarks, & DTS-HD, DTS-HD Master Audio, and the DTS logos are trademarks of DTS, Inc. Product includes software.

© DTS, Inc. All Rights Reserved.

\*5 

Manufactured under license from Dolby Laboratories. Dolby, Pro Logic, Surround EX and the double-D symbol are trademarks of Dolby Laboratories.

\*6 

Manufactured under license from Audyssey Laboratories™, Inc. U.S. and foreign patents pending. Audyssey MultEQ® XT, Audyssey Dynamic EQ®, Audyssey Dynamic Volume® and Audyssey DSX™ are registered trademarks and trademark of Audyssey Laboratories, Inc.

\*7 Music Optimizer™ is a trademark of Onkyo Corporation.

\*8 

"HDMI, the HDMI Logo, and High-Definition Multimedia Interface are trademarks or registered trademarks of HDMI Licensing LLC in the United States and other countries."

\*9



iPhone, iPod, iPod classic, iPod nano, iPod shuffle, and iPod touch are trademarks of Apple Inc., registered in the U.S. and other countries.

"Made for iPod" and "Made for iPhone" mean that an electronic accessory has been designed to connect specifically to iPod or iPhone, respectively, and has been certified by the developer to meet Apple performance standards. Apple is not responsible for the operation of this device or its compliance with safety and regulatory standards.

Please note that the use of this accessory with iPod or iPhone may affect wireless performance.

\*10 

HD Radio™, HD Radio Ready™, and the HD Radio Ready logo are proprietary trademarks of iBiquity Digital Corporation.

This HD Radio Ready™ receiver is ready to receive HD Radio broadcasts when connected to the Onkyo UP-HT1 HD Radio tuner module (sold separately).

\*11 In Europe, using banana plugs to connect speakers to an audio amplifier is prohibited.

\*12 "DLNA®, the DLNA Logo and DLNA CERTIFIED™ are trademarks, service marks, or certification marks of the Digital Living Network Alliance."

\*13 Windows and the Windows logo are trademarks of the Microsoft group of companies.

\* "Xantech" is a registered trademark of Xantech Corporation.

\* "Niles" is a registered trademark of Niles Audio Corporation.

# Front & Rear Panels

## Front Panel

(North American and Taiwan models)

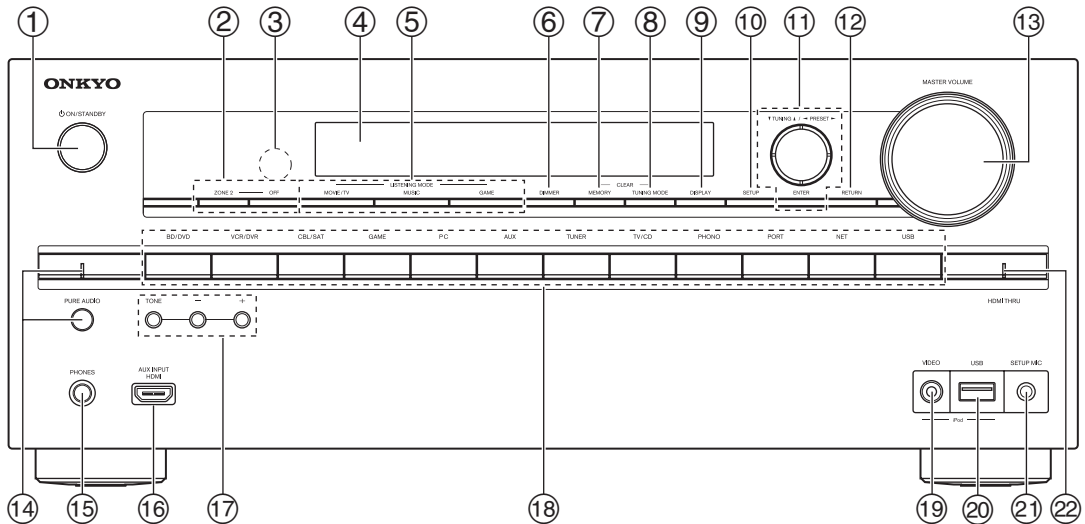

(European, Australian and Asian models)

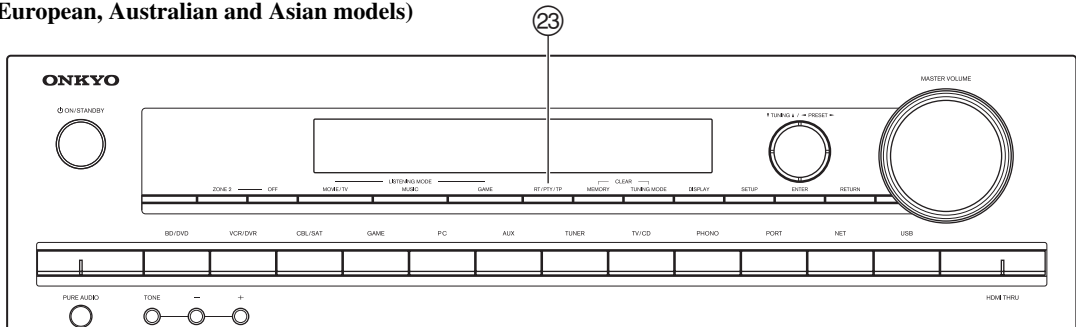

The page numbers in parentheses show where you can find the main explanation for each item.

- |   |   |
|---|---|
| ① ON/STANDBY button (22)                                | ⑬ MASTER VOLUME control and indicator (23)                      |
| ② ZONE 2, OFF buttons (64)                              | ⑭ PURE AUDIO button and indicator (34)                          |
| ③ Remote control sensor (4)                             | ⑮ PHONES jack (41)  |
| ④ Display (9)   | ⑯ AUX INPUT HDMI jack (17)                                      |
| ⑤ LISTENING MODE buttons (34)                           | ⑰ TONE and Tone Level buttons (61)                              |
| ⑥ DIMMER button (North American and Taiwan models) (40) | ⑱ Input selector buttons (23)                                   |
| ⑦ MEMORY button (29)                                    | ⑲ VIDEO jack (18)   |
| ⑧ TUNING MODE button (28)                               | ⑳ USB port (18)   |
| ⑨ DISPLAY button (41)                                   | ㉑ SETUP MIC jack (31)   |
| ⑩ SETUP button (43)                                     | ㉒ HDMI THRU indicator (58)                                      |
| ⑪ TUNING, PRESET (28 to 29), arrow and ENTER buttons    | ㉓ RT/PTY/TP button (European, Australian and Asian models) (30) |
| ⑫ RETURN button   |   |



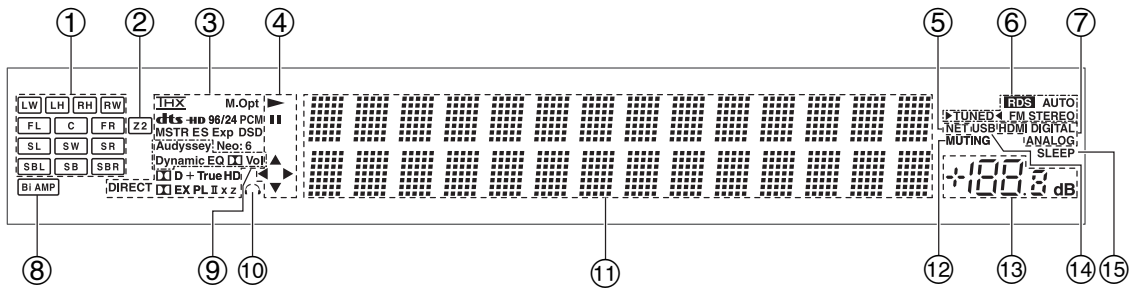

For detailed information, see the pages in parentheses.

- ① **Speaker/channel indicators**
- ② **Z2 (Zone 2) indicator (64)**
- ③ **Listening mode and format indicators (34, 62)**
- ④ **►, || and cursor indicators (24)**
- ⑤ **NET indicator (25, 60)**
- ⑥ **Tuning indicators**  
**RDS indicator (excluding North American and Taiwan models) (29)**  
**AUTO indicator (28)**  
**TUNED indicator (28)**  
**FM STEREO indicator (28)**
- ⑦ **Audio input indicators**
- ⑧ **Bi AMP indicator (14, 46)**
- ⑨ **Audyssey indicator (31, 52)**  
**Dynamic EQ indicator (52)**  
**◻ (Dolby) Vol indicator (51)**  
**Dynamic Vol indicator (52)**
- ⑩ **Headphone indicator (41)**
- ⑪ **Message area**
- ⑫ **MUTING indicator (41)**
- ⑬ **Volume level (23)**
- ⑭ **USB indicator (24, 25)**
- ⑮ **SLEEP indicator (40, 56)**

## Rear Panel

(North American models)

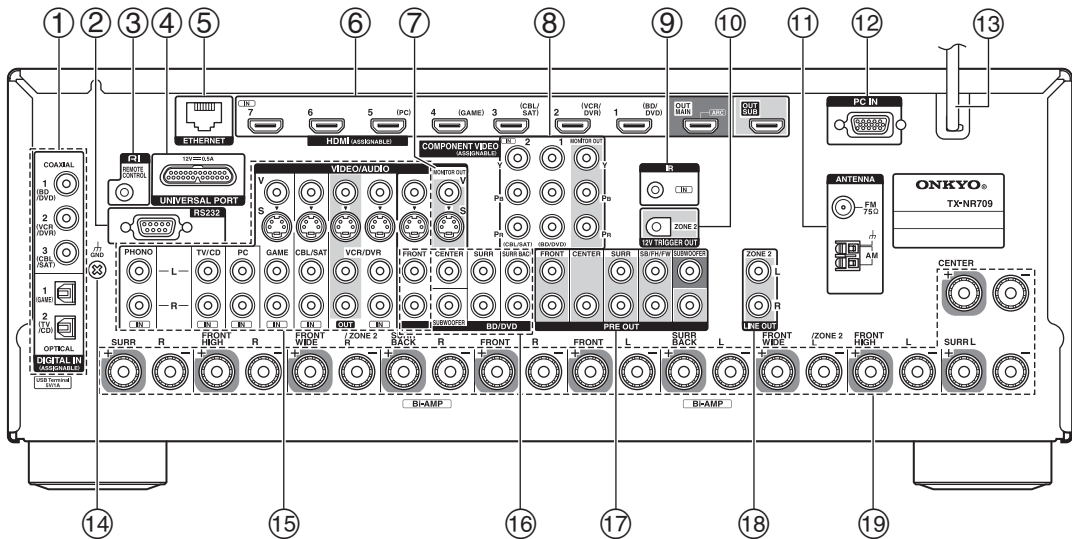

(European, Australian, Asian and Taiwan models)

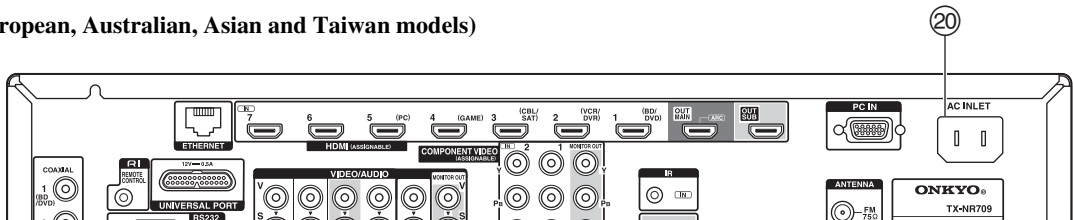

- ① **DIGITAL IN COAXIAL and OPTICAL jacks**
- ② **RS232 port**  
Terminal for control.
- ③ **RI REMOTE CONTROL jack**
- ④ **UNIVERSAL PORT jack**
- ⑤ **ETHERNET port**
- ⑥ **HDMI IN and HDMI output (HDMI OUT MAIN and HDMI OUT SUB) jacks**
- ⑦ **MONITOR OUT V and S jacks**
- ⑧ **COMPONENT VIDEO IN and MONITOR OUT jacks**
- ⑨ **IR IN jack**
- ⑩ **ZONE 2 12V TRIGGER OUT jack**
- ⑪ **FM ANTENNA jack and AM ANTENNA terminal**
- ⑫ **PC IN jack**
- ⑬ **Power cord (North American models)**
- ⑭ **GND screw**
- ⑮ **Composite, S-Video and analog audio jacks (BD/DVD IN, VCR/DVR IN and OUT, CBL/SAT IN, GAME IN, PC IN, TV/CD IN and PHONO IN)**
- ⑯ **Multichannel input jacks (FRONT L/R, CENTER, SURR L/R, SURR BACK L/R and SUBWOOFER)**
- ⑰ **PRE OUT jacks (FRONT L/R, CENTER, SURR L/R, SB/FH/FW L/R, SUBWOOFER)**  
\* SB...Surround Back, FH...Front High, FW...Front Wide
- ⑱ **ZONE 2 LINE OUT jacks**
- ⑲ **Speaker Terminals (FRONT L/R, CENTER, SURR L/R, SURR BACK L/R, FRONT HIGH L/R and FRONT WIDE/ZONE 2 L/R)**
- ⑳ **AC INLET (European, Australian, Asian and Taiwan models)**

See "Connecting the AV Receiver" for connection  
 (→ **pages 12 to 21**).

# Remote Controller

## Controlling the AV Receiver

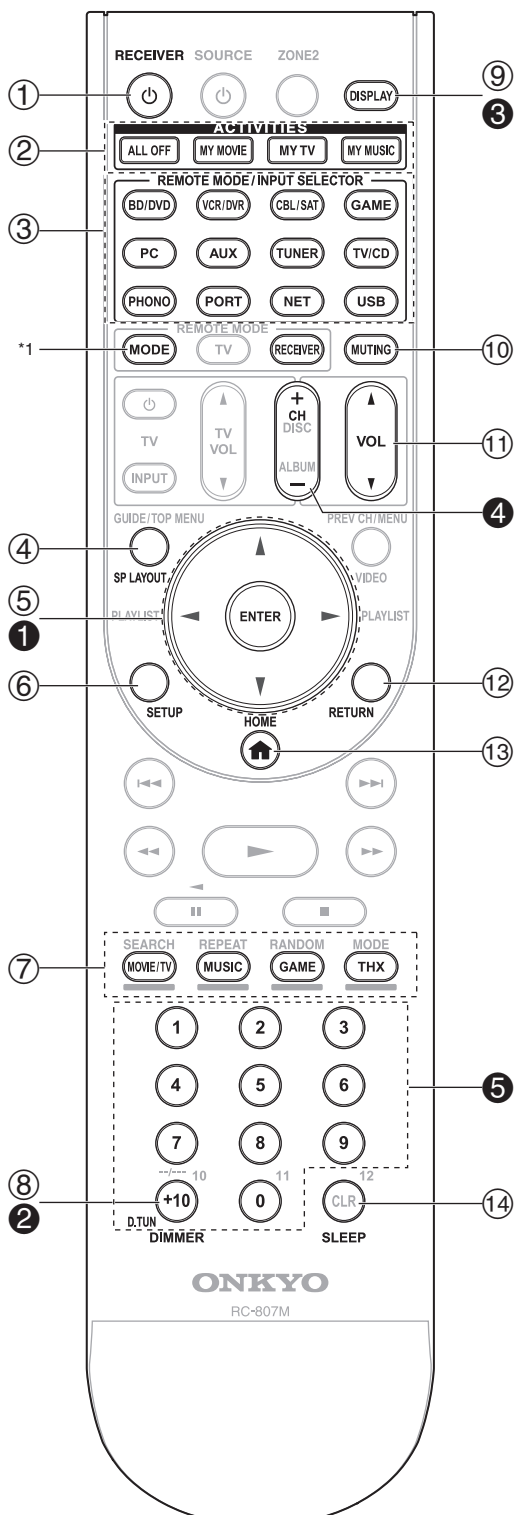

To control the AV receiver, press **RECEPTOR** to select Receiver mode.

You can also use the remote controller to control Onkyo Blu-ray Disc/DVD player, CD player, and other components.

See “Entering Remote Control Codes” for more details (→ page 69).

For detailed information, see the pages in parentheses.

- ① **RECEPTOR** button (22)
- ② **ACTIVITIES** buttons (42, 72)
- ③ **REMOTE MODE/INPUT SELECTOR** buttons (23)
- ④ **SP LAYOUT** button (41)
- ⑤ Arrow **▲/▼/◀/▶** and **ENTER** buttons
- ⑥ **SETUP** button (43)
- ⑦ **Listening Mode** buttons (34)
- ⑧ **DIMMER** button (40)
- ⑨ **DISPLAY** button (41)
- ⑩ **MUTING** button (41)
- ⑪ **VOL ▲/▼** button (23)
- ⑫ **RETURN** button
- ⑬ **HOME** button (40, 61)
- ⑭ **SLEEP** button (40)

### ■ Controlling the tuner

To control the AV receiver’s tuner, press **TUNER** (or **RECEPTOR**).

You can select AM or FM by pressing **TUNER** repeatedly.

- ① Arrow **▲/▼** buttons (28)
- ② **D.TUN** button (29)
- ③ **DISPLAY** button
- ④ **CH +/-** button (29)
- ⑤ **Number** buttons (29)

\*1 When you want to change the remote controller mode (target component) without changing the current input source, press **MODE** and within about 8 seconds, press **REMOTE MODE**. Then, using the same AV receiver’s remote controller, you can control the component corresponding to the button you pressed.

# Connecting the AV Receiver

## Connecting Your Speakers

### Connecting the Speaker Cables

The following illustration shows which speaker should be connected to each pair of terminals. If you're using only one surround back speaker, connect it to the **SURR BACK L** terminals.

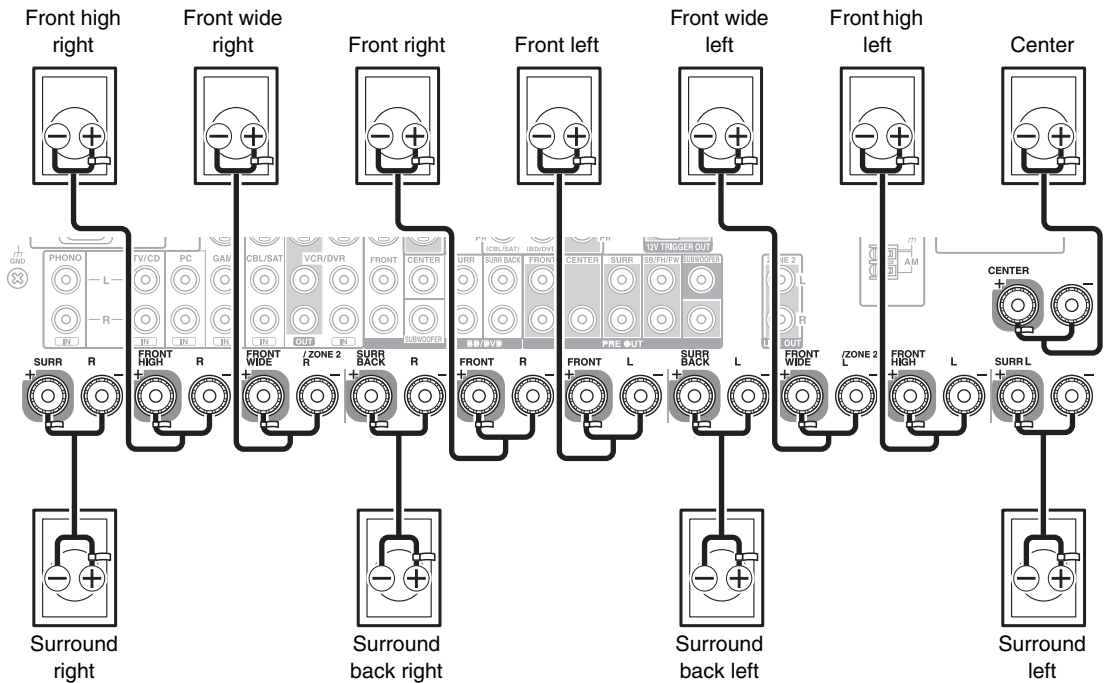

#### ■ Screw-type speaker terminals

Strip 1/2" to 5/8" (12 to 15 mm) of insulation from the ends of the speaker cables, and twist the bare wires tightly, as shown.

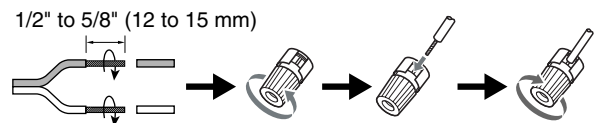

#### ■ Banana Plugs (North American models)

- If you are using banana plugs, tighten the speaker terminal before inserting the banana plug.
- Do not insert the speaker code directly into the center hole of the speaker terminal.

## Speaker Configuration

The following table indicates the channels you should use depending on the number of speakers that you have. No matter how many speakers you use, a powered subwoofer is recommended for a really powerful and solid bass.

To get the best from your surround sound system, you need to set the speaker settings automatically (→ **page 31**) or manually (→ **page 46**).

Number of speakers	2	3	4	5	6	7	7	8	8	9	9	9	10	11
Front speakers	✓	✓	✓	✓	✓	✓	✓	✓	✓	✓	✓	✓	✓	✓
Center speaker		✓		✓	✓	✓	✓	✓	✓	✓	✓	✓	✓	✓
Surround speakers			✓	✓	✓	✓	✓	✓	✓	✓	✓	✓	✓	✓
Surround back speaker*1*2					✓			✓	✓				✓	
Surround back speakers*2						✓				✓	✓			✓
Front high speakers*2							✓	✓		✓	✓	✓	✓	✓
Front wide speakers*2								✓	✓	✓	✓	✓	✓	✓

\*1 If you're using only one surround back speaker, connect it to the **SURR BACK L** terminals.

\*2 Front high, surround back and front wide speakers cannot be used at the same time.

## Attaching the Speaker Cable Labels

The speaker terminals are color-coded for identification purpose.

Speaker	Color
Front left, Front high left, Front wide left, Zone 2 left	White
Front right, Front high right, Front wide right, Zone 2 right	Red
Center	Green
Surround left	Blue
Surround right	Gray
Surround back left	Brown
Surround back right	Tan

The supplied speaker cable labels are also color-coded and you should attach them to the positive (+) side of each speaker cable in accordance with the table above. Then all you need to do is to match the color of each label to the corresponding speaker terminal.

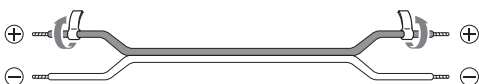

## Speaker Connection Precautions

Read the following before connecting your speakers:

- You can connect speakers with an impedance of between 4 and 16 ohms. If the impedance of any of the connected speakers is 4 ohms or more, but less than 6 ohms, be sure to set the minimum speaker impedance to “**4ohms**” (→ **page 46**). If you use speakers with a lower impedance, and use the amplifier at high volume levels for a long period of time, the built-in protection circuit may be activated.
- Disconnect the power cord from the wall outlet before making any connections.
- Read the instructions supplied with your speakers.
- Pay close attention to speaker wiring polarity. In other words, connect positive (+) terminals only to positive (+) terminals, and negative (-) terminals only to negative (-) terminals. If you get them the wrong way around, the sound will be out of phase and will sound unnatural.
- Unnecessarily long, or very thin speaker cables may affect the sound quality and should be avoided.
- Be careful not to short the positive and negative wires. Doing so may damage the AV receiver.
- Make sure the metal core of the wire does not have contact with the AV receiver's rear panel. Doing so may damage the AV receiver.

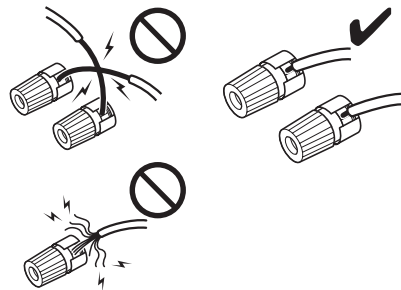

- Don't connect more than one cable to each speaker terminal. Doing so may damage the AV receiver.
- Don't connect one speaker to several terminals.

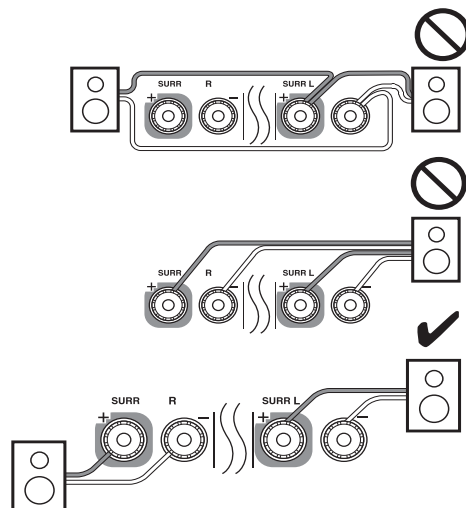

## Using Dipole Speakers

You can use dipole speakers for the surround and surround back speakers. Dipole speakers output the same sound in two directions.

Dipole speakers typically have an arrow printed on them to indicate how they should be positioned. The surround dipole speakers (A) should be positioned so that their arrows point toward the TV/screen, while the surround back dipole speakers (B) should be positioned so that their arrows point toward each other, as shown.

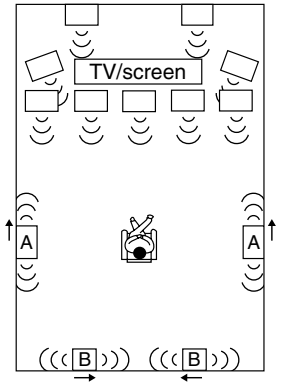

## Using a Powered Subwoofer

To find the best position for your subwoofer, while playing a movie or some music with good bass, experiment by placing your subwoofer at various positions within the room, and choose the one that provides the most satisfying results.

You can connect the powered subwoofer with two **SUBWOOFER PRE OUT** jacks respectively.

The same signal is output from each jack.

### Tip

- If your subwoofer is unpowered and you're using an external amplifier, connect the subwoofer pre out jack to an input on the amplifier.

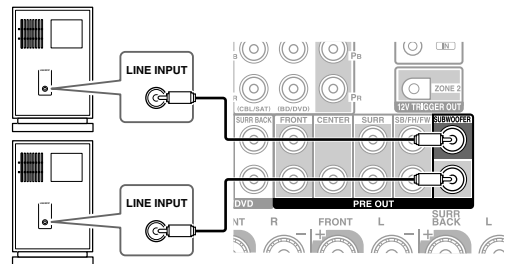

Powered subwoofer

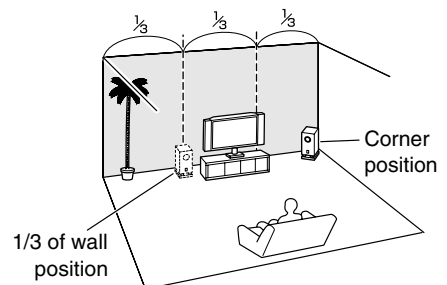

## Bi-amping the Front Speakers

### Important:

- When making the bi-amping connections, be sure to remove the jumper bars that link the speakers' tweeter (high) and woofer (low) terminals.
- Bi-amping can be used only with speakers that support bi-amping. Refer to your speaker manual.

Bi-amping provides improved bass and treble performance. When bi-amping is used, the AV receiver is able to drive up to a 5.1 speaker system in the main room.

Once you've completed the bi-amping connections as shown and turned on the AV receiver, you must set the speaker setting to enable bi-amping (→ **page 46**).

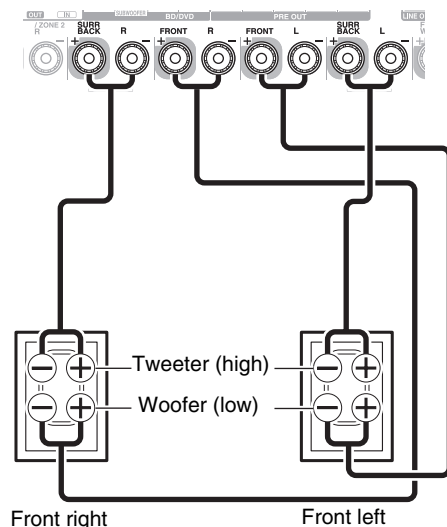

## Connecting a Power Amplifier

If you want to use a more powerful power amplifier, you can use the AV receiver as a preamp. Connect all speaker outputs to the power amplifier. See the manuals supplied with your amplifier for details.

### Note

\*1 Specify "**None**" for any channel that you don't want to output (→ [page 47](#)).

**SB**...Surround Back, **FH**...Front High, **FW**...Front Wide

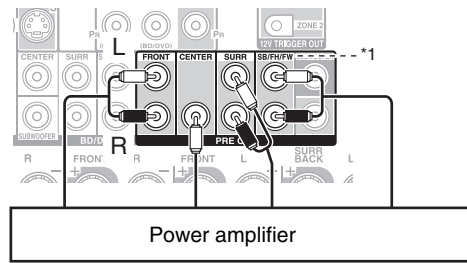

## Connecting AV components

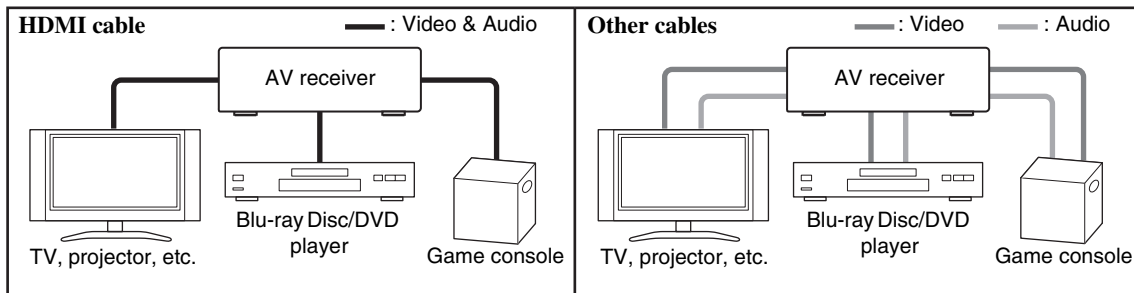

- Before making any AV connections, read the manuals supplied with your AV components.
- Don't connect the power cord until you've completed and double-checked all AV connections.
- Push plugs in all the way to make good connections (loose connections can cause noise or malfunctions).
- To prevent interference, keep audio and video cables away from power cords and speaker cables.

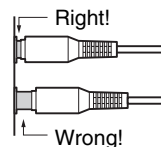

## AV Cables and Jacks

Signal	Cable	Jack	Description	
Video and Audio	HDMI	HDMI	HDMI connections can carry digital video and audio.	
Video	Component video	Y	Green	
		PB	Blue	
		PR	Red	
		Y PB PR		
Analog RGB			This is a conventional analog interface to connect a PC and a display device (also called D-Sub or D-subminiature).	
S-Video		S	S-Video separates the luminance from color signals and provides better picture quality than composite video.	
Composite video		V Yellow	Composite video is commonly used on TVs, VCRs, and other video equipment.	
Audio	Optical digital audio	OPTICAL	Optical digital connections allow you to enjoy digital sound such as PCM*, Dolby Digital or DTS. The audio quality is the same as coaxial.	
	Coaxial digital audio		COAXIAL Orange	Coaxial digital connections allow you to enjoy digital sound such as PCM*, Dolby Digital or DTS. The audio quality is the same as optical.
	Analog audio (RCA)		L White R Red	Analog audio connections (RCA) carry analog audio.
	Multichannel analog audio (RCA)		FRONT CENTER SURR FRONT BACK SURR/DIGITAL	This cable carries multichannel analog audio and is typically used to connect DVD players with a 7.1-channel analog audio output. Several standard analog audio channels can be used instead of a multichannel cable.

\* Available sampling rate for PCM input signal (stereo/mono) is 32/44.1/48/88.2/96 kHz. In case of an HDMI connection, 176.4/192 kHz is also available.

### Note

- The AV receiver does not support SCART plugs.
- The AV receiver's optical digital jacks have shutter-type covers that open when an optical plug is inserted and close when it's removed. Push plugs in all the way.

### Caution

- To prevent shutter damage, hold the optical plug straight when inserting and removing.



# Connecting Components with HDMI

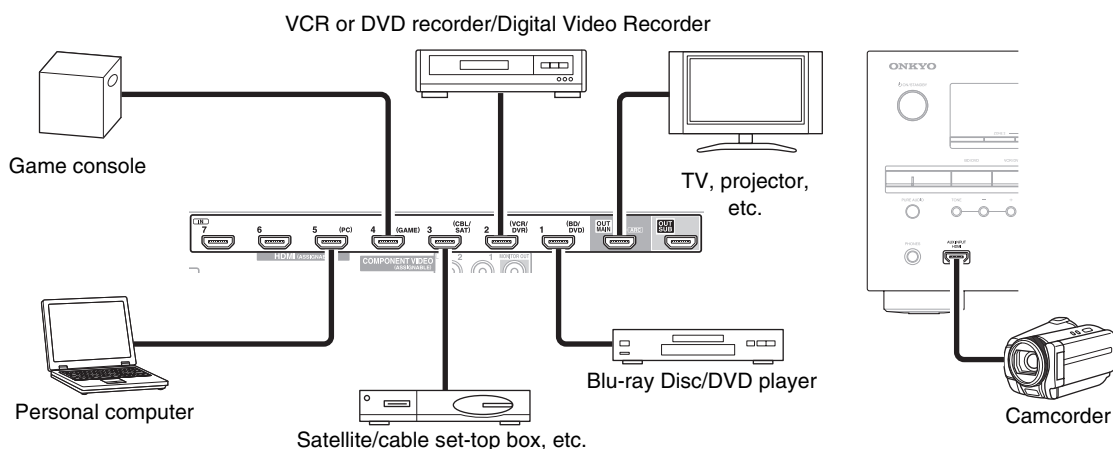

Connect your components to the appropriate jacks. The default input assignments are shown below.

✓: Assignment can be changed (→ page 45).

Jack	Components		Assignable
Input	HDMI IN 1	Blu-ray Disc/DVD player	✓
	HDMI IN 2	VCR or DVD recorder/Digital Video Recorder	✓
	HDMI IN 3	Satellite/cable set-top box, etc.	✓
	HDMI IN 4	Game console	✓
	HDMI IN 5	Personal computer	✓
	HDMI IN 6	Other components	✓
	HDMI IN 7	Other components	✓
	AUX INPUT HDMI	Camcorder	
Output	HDMI OUT MAIN	TV	
	HDMI OUT SUB	projector, etc.	

See also:

- “Connection Tips and Video Signal Path” (→ page 83)
- “Using an RIHD-compatible TV, Player, or Recorder” (→ page 86)
- “About HDMI” (→ page 88)

## ■ Audio Return Channel (ARC) function

Audio Return Channel (ARC) function enables an HDMI capable TV to send the audio stream to the **HDMI OUT MAIN** of the AV receiver.

- This function can be used when:
  - your TV is ARC capable, and
  - the **TV/CD** input selector is selected, and
  - “**HDMI Control(RIHD)**” is set to “**On**” (→ page 58), and
  - “**Audio Return Channel**” is set to “**Auto**” (→ page 59).

### Tip

- To listen to audio received by the **HDMI IN** jacks through your TV’s speakers:
  - Set the “**HDMI Control(RIHD)**” setting to “**On**” (→ page 58) for an **RIHD**-compatible TV.
  - Set the “**Audio TV Out**” setting to “**On**” (→ page 59) when the TV is not compatible with **RIHD**, or the “**HDMI Control(RIHD)**” setting to “**Off**”.
  - Set your Blu-ray Disc/DVD player’s HDMI audio output setting to PCM.
  - To listen to TV audio through the AV receiver, see “Connecting Your Components” (→ page 18).

### Note

- When listening to an HDMI component through the AV receiver, set the HDMI component so that its video can be seen on the TV screen (on the TV, select the input of the HDMI component connected to the AV receiver). If the TV power is off or the TV is set to another input source, this may result in no sound from the AV receiver or the sound may be cut off.
- As the “**Audio TV Out**” setting is set to “**On**” (→ page 59) to hear from your TV speakers, the sound will also be output from the AV receiver’s speakers if you adjust the volume of the AV receiver. Similarly, as the “**HDMI Control(RIHD)**” setting is set to “**On**” (→ page 58) to hear from the speakers of an **RIHD**-compatible TV, the AV receiver’s speakers will produce sound if you adjust the volume of the AV receiver, while the TV speakers will be muted. To stop the AV receiver’s speakers from producing sound, you can either change the settings on the AV receiver or on the TV, or turn down the volume of the AV receiver.

## Connecting Your Components

The on-screen menus appear only on a TV that is connected to the **HDMI OUT MAIN**. If your TV is connected to other video outputs, use the AV receiver's display when changing settings.

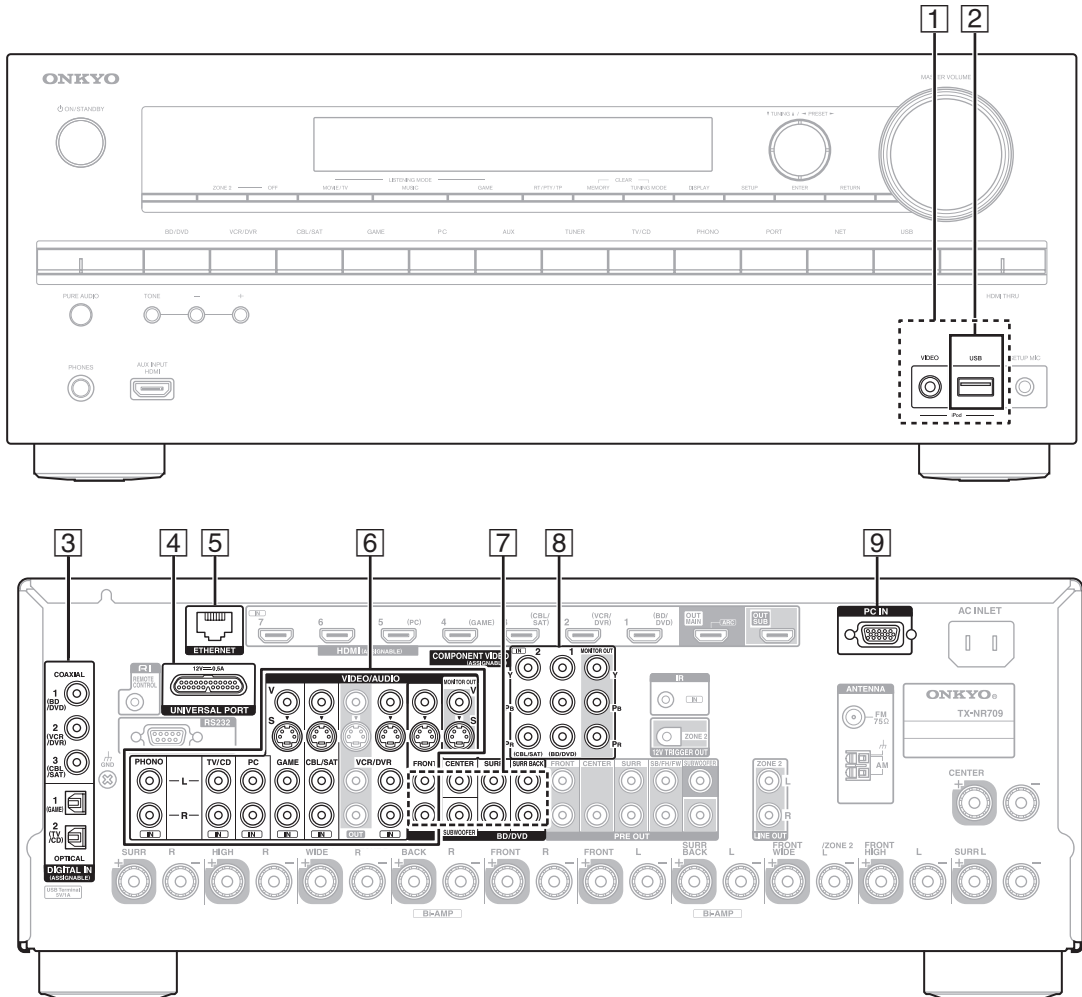

Connect your components to the appropriate jacks. The default input assignments are shown below. See “Connection Tips and Video Signal Path” for more information (→ [page 83](#)).

✓: Assignment can be changed (→ [page 45](#)).

No.	Jack/Port	Components	Assignable	
1	USB, VIDEO	iPod/iPhone (video playback)		
2	USB*1	iPod/iPhone, MP3 player, USB flash drive		
3	DIGITAL IN	COAXIAL		
		1 (BD/DVD)	Blu-ray Disc/DVD player	✓
		2 (VCR/DVR)	VCR or DVD recorder/digital video recorder, RI dock	✓
	3 (CBL/SAT)	Satellite/cable set-top box, RI dock, etc.	✓	
	OPTICAL			
1 (GAME)	Game console	✓		
2 (TV/CD)	TV, CD player	✓		
4	UNIVERSAL PORT	Universal port option dock (UP-A1 etc.)		
5	ETHERNET	Router		
6	MONITOR OUT	TV, projector, etc.		
	BD/DVD IN	Blu-ray Disc/DVD player		
	VCR/DVR IN	VCR or DVD recorder/digital video recorder, RI dock		
	CBL/SAT IN	Satellite/cable set-top box, etc.		
	GAME IN	Game console, RI dock		
	PC IN	Personal computer		
	TV/CD IN	TV, CD player, cassette tape deck, MD, CD-R, Turntable*2, RI dock		
	PHONO IN	Turntable*2		
7	Multichannel input*3	DVD player, DVD-Audio, Super Audio CD-capable player, MPEG decoder		
8	COMPONENT VIDEO	IN 1 (BD/DVD)	Blu-ray Disc/DVD player, RI dock	✓
		IN 2 (CBL/SAT)	Satellite/cable set-top box, RI dock, etc.	✓
	MONITOR OUT	TV, projector, etc.		
9	PC IN*4	Personal computer		

#### Note

\*1 Do not connect the AV receiver’s **USB** port to a USB port on your computer. Music on your computer cannot be played through the AV receiver in this way.

\*2 Connect a turntable (MM) that has a built-in phono preamp to **TV/CD IN**, or connect it to **PHONO IN** with the phono preamp turned off. If your turntable (MM) doesn’t have a phono preamp, connect it to **PHONO IN**. If your turntable has a moving coil (MC) type cartridge, you’ll need a commercially available MC head amp or MC transformer to connect to **PHONO IN**. See your turntable’s manual for details.

If your turntable has a ground wire, connect it to the AV receiver’s **GND** screw. With some turntables, connecting the ground wire may produce an audible hum. If this happens, disconnect it.

\*3 To select the multichannel input, select the **BD/DVD** input selector and see “Audio Selector” (→ [page 55](#)). To adjust the subwoofer sensitivity for the multichannel input, see “Subwoofer Input Sensitivity” (→ [page 46](#)).

\*4 When you connect your personal computer to **PC IN** and select the **PC** input selector, the video of the personal computer is output from the HDMI outputs. However, if you have assigned the HDMI inputs to the **PC** input selector, the AV receiver will output signals received from the HDMI inputs instead of signals from **PC IN**. To have the signals output from **PC IN**, select “- - - -” for “**PC**” in the “**HDMI Input**” setting (→ [page 45](#)).

- With connection [3](#), you can enjoy Dolby Digital and DTS. (To record or listen the audio in Zone 2 as well, use [3](#) and [6](#).)

- With connection [6](#), you can listen to and record audio from external components while you are in Zone 2.

- With connection [6](#), if your Blu-ray Disc/DVD player has both the main stereo and multichannel outputs, be sure to connect to the main stereo.

#### ■ How to record a video source

With the connections described above, you cannot record the videos through the AV receiver. See “Recording” about connections for video recording (→ [page 42](#)).

## Connecting Onkyo RI Components

- 1 Make sure that each Onkyo component is connected with an analog audio cable (connection 6 in the hookup examples) (→ page 18).
- 2 Make the RI connection (see the illustration).
- 3 If you're using an RI Dock, or cassette tape deck, change the Input Display (→ page 41).

With RI (Remote Interactive), you can use the following special functions:

### ■ System On/Auto Power On

When you start playback on a component connected via RI while the AV receiver is on Standby, the AV receiver will automatically turn on and select that component as the input source.

### ■ Direct Change

When playback is started on a component connected via RI, the AV receiver automatically selects that component as the input source.

### ■ Remote Control

You can use the AV receiver's remote controller to control your other RI-capable Onkyo components, pointing the remote controller at the AV receiver's remote control sensor instead of the component. You must enter the appropriate remote control code first (→ page 70).

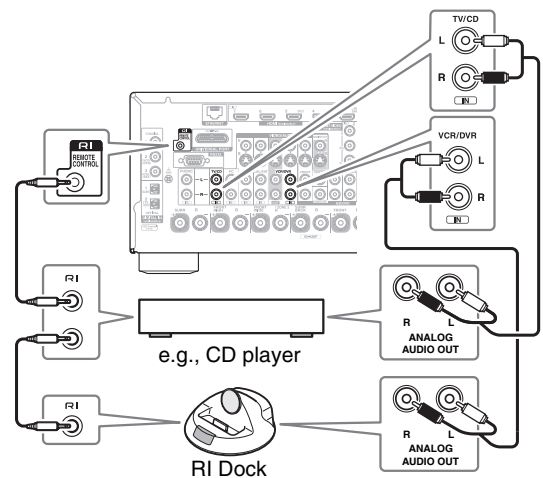

### Note

- Use only RI cables for RI connections. RI cables are supplied with Onkyo components.
- Some components have two RI jacks. You can connect either one to the AV receiver. The other jack is for connecting additional RI-capable components.
- Connect only Onkyo components to RI jacks. Connecting other manufacturer's components may cause a malfunction.
- Some components may not support all RI functions. Refer to the manuals supplied with your Onkyo components.
- While Zone 2 is on, the System On/Auto Power On and Direct Change RI functions do not work.

## Connecting a Recording Component

See "Recording" for details on recording (→ page 42).

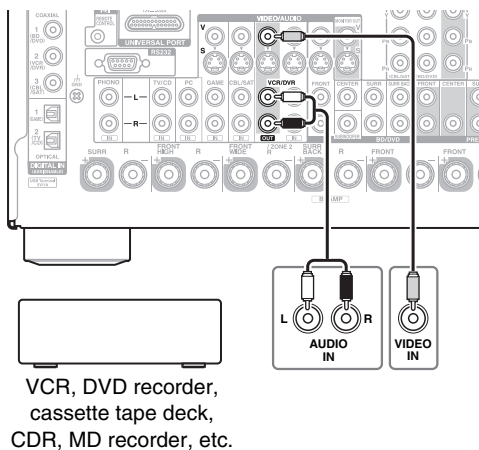

### Note

- The AV receiver must be turned on for recording. Recording is not possible while it's in standby mode.
- If you want to record directly from your TV or playback VCR to the recording VCR without going through the AV receiver, connect the TV/VCR's audio and video outputs directly to the recording VCR's audio and video inputs. See the manuals supplied with your TV and VCR for details.
- Video signals connected to composite video inputs can be recorded only via composite video outputs. For example, if your TV/VCR is connected to a composite video input, the recording VCR must be connected to a composite video output.
- The surround sound and DSP listening modes cannot be recorded.
- Copy-protected Blu-ray Discs and DVDs cannot be recorded.
- Sources connected to a digital input cannot be recorded. Only analog inputs can be recorded.
- DTS signals will be recorded as noise, so don't attempt analog recording of DTS CDs or LDs.
- While the listening mode is set to Pure Audio, the video circuitry is turned off and therefore no video signals are processed. If you want to make recordings, select another listening mode.

## Connecting the Antennas

This section explains how to connect the supplied indoor FM antenna and AM loop antenna.

The AV receiver won't pick up any radio signals without any antenna connected, so you must connect the antenna to use the tuner.

### Caution

- Be careful not to injure yourself when using thumbtacks.

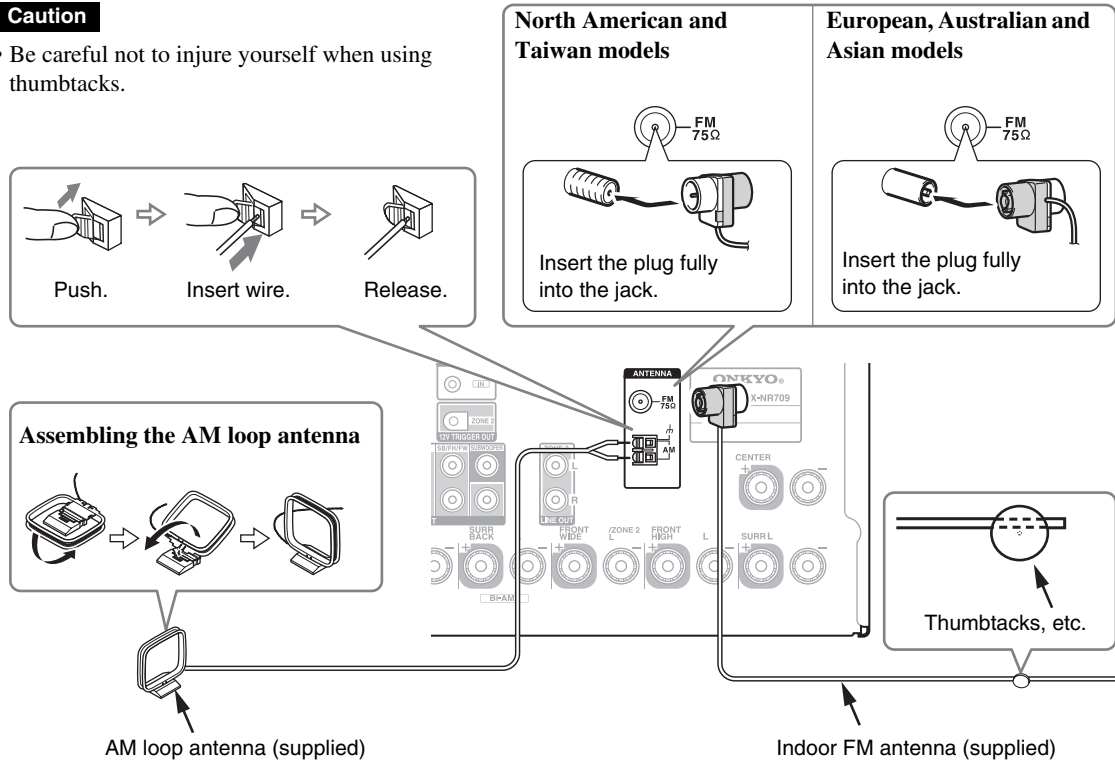

### Note

- Once your AV receiver is ready for use, you'll need to tune into a radio station and position the antenna to achieve the best possible reception.
- Keep the AM loop antenna as far away as possible from your AV receiver, TV, speaker cables, and power cords.

### Tip

- If you cannot achieve good reception with the supplied indoor FM antenna, try a commercially available outdoor FM antenna instead.
- If you cannot achieve good reception with the supplied indoor AM loop antenna, try using it with a commercially available outdoor AM antenna.

## Connecting the Power Cord

- (European, Australian, Asian and Taiwan models)**  
Connect the supplied power cord to the AV receiver's **AC INLET**.

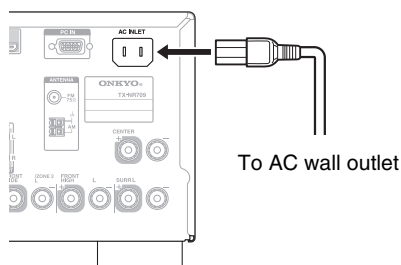

- Plug the power cord into an AC wall outlet.**

### Note

- Before connecting the power cord, connect all of your speakers and AV components.
- Turning on the AV receiver may cause a momentary power surge that might interfere with other electrical equipment on the same circuit. If this is a problem, plug the AV receiver into a different branch circuit.
- Do not use a power cord other than the one supplied with the AV receiver. The supplied power cord is designed exclusively for use with the AV receiver and should not be used with any other equipment.
- Never disconnect the power cord from the AV receiver while the other end is still plugged into a wall outlet. Doing so may cause an electric shock. Always disconnect the power cord from the wall outlet first, and then the AV receiver.

# Turning On/Off the AV Receiver

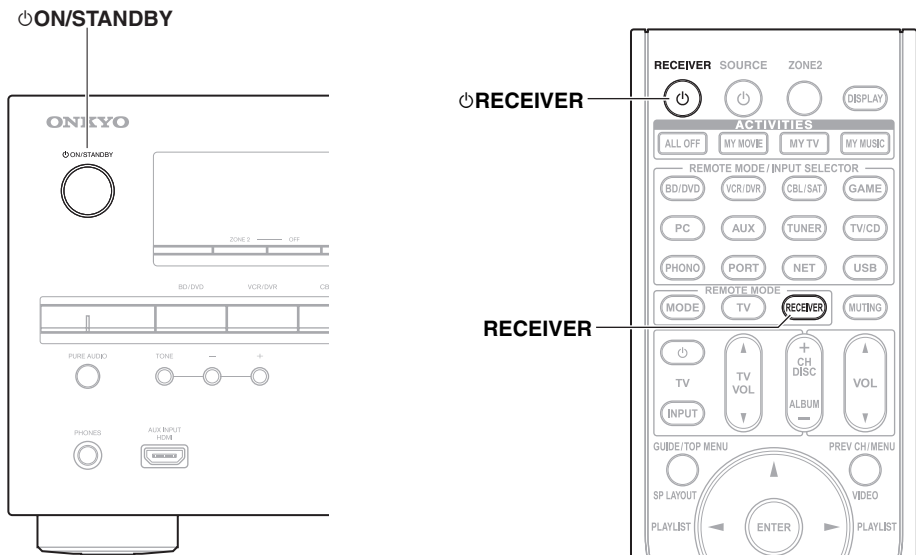

## Turning On

- 1 Press **ON/STANDBY** on the front panel.  
or  
Press **RECEIVER** followed by **ON/STANDBY** on the remote controller.  
The AV receiver comes on, the display lights.

## Turning Off

- 1 Press **ON/STANDBY** on the front panel.  
or  
Press **RECEIVER** followed by **ON/STANDBY** on the remote controller.  
The AV receiver will enter standby mode. To prevent any loud surprises when you turn on the AV receiver, always turn down the volume before you turn it off.

### Tip

- For details on power management settings, see “Auto Standby” (→ [page 59](#)).

# Playback

The on-screen menus appear only on a TV that is connected to the **HDMI OUT MAIN**. If your TV is connected to other video outputs, use the AV receiver's display when changing settings.

This section describes the procedure for using the remote controller unless otherwise specified.

## Selecting the Language for the Onscreen Setup Menus

You can determine the language used for the onscreen setup menus. See "Language" in the "OSD Setup" (→ page 57).

## Playing the Connected Component

### ■ Operating with the remote menu controller

- 1** Press **RECEIVER** followed by **INPUT SELECTOR**.
- 2** Start playback on the source component.  
See also:
  - "Playing an iPod/iPhone via USB" (→ page 24)
  - "Playing a USB Device" (→ page 25)
  - "Listening to Internet Radio" (→ page 25)
  - "Playing Music Files on a Server" (→ page 27)
  - "Remote Playback" (→ page 27)
  - "Listening to AM/FM Radio" (→ page 28)
  - "iPod/iPhone Playback via Onkyo Dock" (→ page 66)
  - "Controlling Other Components" (→ page 69)
- 3** To adjust the volume, use **VOL ▲/▼**.
- 4** Select a listening mode and enjoy!  
See also:
  - "Using the Listening Modes" (→ page 34)
  - "Audyssey" (→ page 52)

### ■ Operating on the AV receiver

- 1** Use the input selector buttons to select the input source.
- 2** Start playback on the source component.
- 3** To adjust the volume, use the **MASTER VOLUME** control.
- 4** Select a listening mode and enjoy!

## Controlling Contents of USB or Network Devices

See "Controlling Other Components" about the operation of other components (→ page 69).

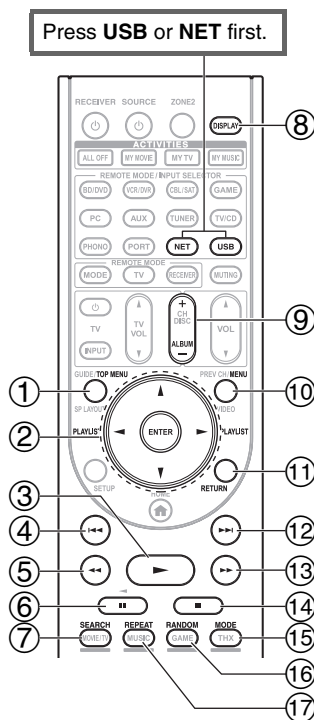

①	<b>TOP MENU</b> This button displays the top menu for each media or service.
②	<b>▲/▼ and ENTER</b> These buttons navigate through the menus. <b>◀/▶</b> This button cycles through pages. <b>PLAYLIST ◀/▶</b> In Standard Mode (iPod/iPhone), this button selects playlists.
③	<b>▶</b> This button starts playback.
④	<b>◀◀</b> This button selects the beginning of the current song. Pressing this button twice selects the previous song.
⑤	<b>◀◀</b> This button fast-reverses the current song.
⑥	<b>  </b> This button pauses playback.
⑦	<b>SEARCH</b> You can toggle between the playback screen and the list screen during playback.
⑧	<b>DISPLAY</b> This button switches between song informations.
⑨	<b>ALBUM +/-</b> In Standard Mode (iPod/iPhone), this button selects albums.

10	<b>MENU</b> This button returns to top menu of the Internet Radio service.
11	<b>RETURN</b> This button returns to the previous menu.
12	<b>▶▶</b> This button selects the next song.
13	<b>▶▶▶</b> This button fast-forwards the current song.
14	<b>■</b> This button stops playback.
15	<b>MODE</b> You can switch between Standard Mode and Extended Mode during iPod/iPhone playback.
16	<b>RANDOM</b> This button performs random playback.
17	<b>REPEAT</b> Press this button repeatedly to cycle through the repeat modes.













#### Note

- The buttons you can use will differ depending on the devices and media used for playback.

## Understanding Icons on the Display

This section describes icons that appear on the display during media playback.

#### Displayed Icons

Icon	Description
	Folder
	Track
	Playback
	Pause
	Fast Forward
	Fast Reverse
	Artist
	Album
	Repeat One Track
	Repeat Folder (USB Device)
	Repeat
	Shuffle
	Shuffle Album (iPod/iPhone)

## Playing an iPod/iPhone via USB

This section explains how to play music/video files on the iPod/iPhone.

Compatible iPod/iPhone models

Made for:

iPod touch (1st, 2nd, 3rd and 4th generation), iPod classic, iPod with video, iPod nano (1st, 2nd, 3rd, 4th, 5th and 6th generation), iPhone 4, iPhone 3GS, iPhone 3G, iPhone

- Press **USB** to select the “USB” input.
- Connect the USB cable that comes with the iPod/iPhone to the USB port on the front of the AV receiver.  
While reading the contents of your iPod/iPhone, the message “**Connecting...**” appears on the display. The USB indicator lights. It will flash if the AV receiver cannot read the iPod/iPhone.
- Press **MODE** repeatedly to switch to **Extended Mode (Music)** or **Extended Mode (Video)**.  
A list of your iPod/iPhone model’s contents appears. To open a folder, use **▲/▼** to select it, and then press **ENTER**.

#### Tip

- With the default settings, the iPod/iPhone is operated in Standard Mode.
- Pressing **MODE** repeatedly switches back to Standard Mode.
- When you disconnect the iPod/iPhone, the AV receiver stores the mode. This means that if you disconnect when in Extended Mode (Music), the AV receiver will start in Extended Mode (Music) the next time you connect the iPod/iPhone.
- You can also use **▲/▼**, **ENTER** and **TUNING MODE** buttons on the front panel. **TUNING MODE** allows you to switch modes.
- When connecting your iPod/iPhone with a USB cable, we recommend you use an official USB cable from Apple Inc.

- Use **▲/▼** to select a music/video file, and press **ENTER** or **▶** to start playback.

#### Note

- Do not disconnect the USB device or USB cable that comes with iPod/iPhone from the **USB** port at the front of the AV receiver, while the message “**Connecting...**” appears on the display.
- If you connect an iPod or iPhone to the **USB** port on this device, no sound will be output from the headphones jack.



## Extended Mode (Music) control

The music content information is displayed (lists are displayed), and you can control the music content while looking at the screen.

Top screen list:

Playlists, Artists, Albums, Genres, Songs, Composers, Shuffle Songs, Now Playing.

## Extended Mode (Video) control

The video content information is displayed (lists are displayed), and you can control the video content while looking at the screen.

Top screen list:

Movies, Music Videos, TV Shows, Video Podcasts, Rentals.

### Note

- To view the video contents of your iPod/iPhone, connect it to the **USB** port and **VIDEO** jack on the AV receiver's front panel, using the official Apple Composite AV Cable.
- Depending on your iPod/iPhone model and generation, the displayed items may vary and the support for Extended Mode (Video) is not guaranteed.

## Standard Mode control

The content information is not displayed, but can be operated using the iPod/iPhone or the remote controller (**USB**).

### Note

- The following iPod models are not supported in Standard Mode. (They can only be controlled in Extended Mode).
  - iPod with video
  - iPod nano (1st generation)

## Playing a USB Device

This section explains how to play music files from a USB device (e.g., USB flash drives and MP3 players).

See also:

- “Network/USB Features” (→ **page 89**).

- 1 Press **USB** to select the “USB” input.**
- 2 Plug your USB device into the AV receiver’s USB port.**

The **USB** indicator lights. It will flash if the AV receiver cannot read the USB device.
- 3 Press **ENTER**.**

A list of the device’s contents appears. To open a folder, use **▲/▼** to select it, and then press **ENTER**.
- 4 Use **▲/▼** to select a music file, and press **ENTER** or **▶** to start playback.**

### Note

- Do not disconnect the USB device or USB cable that comes with iPod/iPhone from the **USB** port at the front of the AV receiver, while the message “**Connecting...**” appears on the display.

## Listening to Internet Radio

You need to connect the AV receiver to your home network (→ **page 89**).

You can select Internet radio stations by connecting to the AV receiver from your computer and selecting stations in your web browser.

Internet radio URLs in the following formats are supported: PLS, M3U, and podcast (RSS). However, depending on the type of data or audio format used by the Internet radio station, you may not be able to listen to some stations.

### Note

- Services available may vary depending on the region. See the separate instructions for more information.

## Listening to vTuner Internet Radio

This unit includes the full vTuner Internet Radio Service at no additional charge. Once you have connected your unit to the Internet you can select vTuner Internet Radio to search for and play Internet radio stations and podcasts at any time. To enhance your Internet radio experience, the <http://onkyo.vtuner.com/> portal is available to you as an easy way to browse to find stations, set up/organize your favorites, add your own stations, get help, etc. After the first time you try vTuner Internet Radio on your unit you can use the MAC Address of your unit to create a member login account (email address and password) on the <http://onkyo.vtuner.com/> portal. To verify your MAC Address, please see “Network” (→ **page 60**).

- 1 Press **NET**.**

The “**NET**” screen appears, and the **NET** indicator lights. If it flashes, verify that the Ethernet cable is firmly connected to the AV receiver.
- 2 Use **▲/▼/◀/▶** to select “vTuner Internet Radio” and then press **ENTER**.**

### 3 Use ▲/▼ to select a program and then press **ENTER**.

Playback starts.

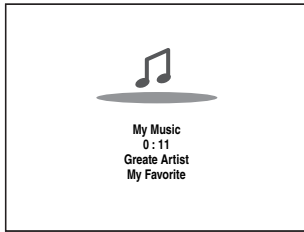

Press **MENU** to enable selection from the following menu items.

#### ▶ Stations like this:

Stations like the one currently being played back are displayed.

#### ▶ Add to My Favorites:

Adds a station to My Favorites list.

Press **TOP MENU** to go to the top menu of the Internet Radio services.

#### Tip

- By pressing **SEARCH**, you can toggle between the playback screen and the radio list screen.

## Listening to Other Internet Radio

To listen to other internet radio stations, insert the following step after step 1 in the “Listening to vTuner Internet Radio” section.

### 1 On your computer, start your web browser and enter the AV receiver’s IP address in the browser’s Internet address (URL) field.

The browser connects to the AV receiver (WEB Setup Menu).

#### Note

- The AV receiver’s IP address is shown on “IP Address” (→ page 60).
- If you’re using DHCP, your router may not always allocate the same IP address to the AV receiver, so if you find that you can’t connect to the AV receiver, recheck the AV receiver’s IP address on the “Network” screen.

### 2 Click on the “My Favorites” tab.

### 3 Enter the preset name and Internet address (URL).

### 4 Click “Save” to save the Internet radio station.

### 5 The Internet radio station is then added to “My Favorites”.

## Registering My Favorites\*1

You can add the currently playing song or station to the “My Favorites”. You can save up to 40 Internet radio stations.

Once you’ve added a station to the list, simply select it in the “My Favorites” menu, and then press **ENTER** to start playback.

\*1 From the search results you can save the stations and songs but cannot listen to them directly.

### ■ Top menu of Internet Radio

#### ▶ Create new station:

Add a favorite station or Internet radio to the My Favorites.

#### ▶ Rename this station:

You can rename the stations and songs saved in “My Favorites” list.

#### ▶ Delete from My Favorites:

You can delete the stations and songs saved in “My Favorites” list.

### 1 Press **MENU** with the station selected or while a song is playing.

### 2 Use ▲/▼ to select “Add to My Favorites”, and press **ENTER**.

### 3 Use ▲/▼/◀/▶ to select “OK”, and then press **ENTER**.

#### Tip

- If you choose to rename the station, see “Name Edit” (→ page 53).

## Playing Music Files on a Server

You need to connect the AV receiver to your home network (→ page 89).

This section explains how to play music files on a computer or media server through the AV receiver (Server Playback).

- 1 Start your computer or media server.
- 2 Press **NET**.  
The “NET” screen appears. The **NET** indicator lights. If it flashes, confirm the network connection.
- 3 Use **▲/▼/◀/▶** to select “**dlna**”, and press **ENTER**.  
**Tip**
  - To go back to the previous screen, press **RETURN**.
- 4 Use **▲/▼** to select a server, and then press **ENTER**.  
The menu is displayed according to the server functions.  
**Note**
  - The search function does not work with media servers which do not support this function.
  - Photos and movies stored on a media server cannot be accessed from the AV receiver.
  - Depending on the sharing settings in the media server, the AV receiver may not be able to access the content. See the instruction manual of the media server.
- 5 Use **▲/▼** to select an item, and then press **ENTER** or **▶** to start playback.

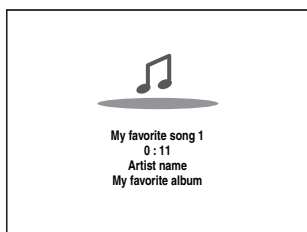

### Note

- Depending on the media server, **◀◀/▶▶/||** may not work.
- If the message “**No Item.**” appears, this means that no information can be retrieved from the server. In this case, check your server, network, and AV receiver connections.

## Windows Media Player 11 Setup

This section explains how to configure Windows Media Player 11 so that the AV receiver can play the music files stored on your computer.

- 1 Start Windows Media Player 11.
- 2 On the “**Library**” menu, select “**Media Sharing**”.  
The “Media Sharing” dialog box appears.
- 3 Select the “**Share my media**” check box, and then click “**OK**”.
- 4 Select the AV receiver in the list, and then click “**Allow**”.
- 5 Click “**OK**” to close the dialog box.  
This completes the Windows Media Player 11 configuration.  
You can now play the music files in your Windows Media Player 11 library through the AV receiver.  
**Tip**
  - Windows Media Player 11 can be downloaded for free from the Microsoft web site.

## Remote Playback

You need to connect the AV receiver to your home network (→ page 89).

Remote Playback means you can play the music files stored on a media server or personal computer with the AV receiver by operating the controller device in the home network.

## Windows Media Player 12 Setup

This section explains how to configure Windows Media Player 12 so that the AV receiver can play the music files stored on your personal computer.

- 1 Start Windows Media Player 12.
- 2 On the “**Stream**” menu, select “**Turn on media streaming**”.  
A dialog box appears.
- 3 Move your cursor and click on “**Turn on media streaming**”.  
A list of media server appears. Wording may vary slightly depending on the network location.
- 4 Select the product in the list, and then click “**Allowed**”.
- 5 Click “**OK**” to close the dialog box.  
This completes the Windows Media Player 12 configuration.  
You can now play the music files in your Windows Media Player 12 library.

### 1 Start Windows Media Player 12.

To enable remote playback, you must first configure Windows Media Player 12.

### 2 Press NET.

The “NET” screen appears. The NET indicator lights. If it flashes, verify the network connection.

### 3 Use ▲/▼/◀/▶ to select “dlna”, and press ENTER.

A list of media server appears.

#### Note

- Remote playback cannot be used while the music files of another media server are being played. You must stop their playback first.

### 4 On Windows Media Player 12, right-click on a music file.

The right-click menu appears. For selecting another media server, select the desired media server from the “Other Libraries” menu on Windows Media Player 12.

### 5 Select the AV receiver from the right-click menu.

The “Play to” window appears and playback on the product starts. Operations during remote playback can be made from the “Play to” window of Windows 7 on your personal computer. During remote playback, operations (such as Playback, Pause, Fast Forward, Fast Rewind, Previous, Next, Repeat, Random) cannot be made.

### 6 Adjusting the Volume

You can adjust the volume by adjusting the volume bar in the “Remote playback” window. The default maximum volume level is 82 (0dB). If you wish to change this, enter the value from the Web Setup in your browser.

The volume value of the remote window and the volume value of the AV receiver may not always match.

Adjustments you make to the volume in the AV receiver will not be reflected in the “Remote playback” window.

This section describes the procedure using the buttons on the front panel unless otherwise specified.

### Using the Tuner

With the built-in tuner you can enjoy AM and FM radio stations. You can store your favorite stations as presets for quick selection.

You can also change the frequency steps (→ page 58).

#### 1 Press TUNER to select either “AM” or “FM”.

In this example, FM has been selected.

Each time you press TUNER, the radio band changes between AM and FM.

Band	Frequency
FM	87.5 MHz

(Actual display depends on the country.)

### Tuning into Radio Stations

#### ■ Auto tuning mode

#### 1 Press TUNING MODE so that the AUTO indicator lights on the display.

#### 2 Press TUNING ▲/▼.

Searching stops when a station is found.

When tuned into a station, the TUNED indicator lights. When tuned into a stereo FM station, the FM STEREO indicator lights on the display, as shown.

▶ TUNED ◀
AUTO
FM 87.5 MHz
TUNED FM STEREO
FM STEREO

#### Tip

#### • Tuning into weak FM stereo stations

If the signal from a stereo FM station is weak, it may be impossible to get good reception. In this case, switch to manual tuning mode and listen to the station in mono.

#### ■ Manual tuning mode

In manual tuning mode, FM stations will be in mono.

#### 1 Press TUNING MODE so that the AUTO indicator goes off on the display.

#### 2 Press and hold TUNING ▲/▼.

The frequency stops changing when you release the button.

Press the buttons repeatedly to change the frequency one step at a time.

## ■ Tuning into stations by frequency

You can tune into AM and FM stations directly by entering the appropriate frequency.

- 1 On the remote controller, press **TUNER** repeatedly to select “AM” or “FM”, followed by **D.TUN**.

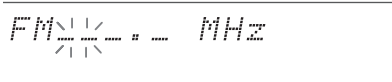

(Actual display depends on the country.)

- 2 Within 8 seconds, use the number buttons to enter the frequency of the radio station.

For example, to tune to 87.5 (FM), press **8**, **7**, **5**.

If you have entered the wrong number, you can retry after 8 seconds.

## Presetting AM/FM Stations

You can store a combination of up to 40 of your favorite AM/FM radio stations as presets.

- 1 Tune into the AM/FM station that you want to store as a preset.

See the previous section.

- 2 Press **MEMORY**.

The preset number flashes.

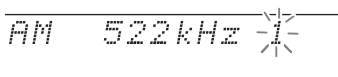

(Actual display depends on the country.)

- 3 While the preset number is flashing (about 8 seconds), use **PRESET** ◀/▶ to select a preset from 1 through 40.

- 4 Press **MEMORY** again to store the station or channel.

The station or channel is stored and the preset number stops flashing.

Repeat this procedure for all of your favorite AM/FM radio stations.

### Note

- You can name your radio presets for easy identification (→ **page 53**). Its name is displayed instead of the band and frequency.

## ■ Selecting Presets

- 1 To select a preset, use **PRESET** ◀/▶ on the AV receiver, or the remote controller's **CH +/-**.

### Tip

- You can also use the remote controller's number buttons to select a preset directly.

## ■ Deleting Presets

- 1 Select the preset that you want to delete.

See the previous section.

- 2 While holding down **MEMORY**, press **TUNING MODE**.

The preset is deleted and its number disappears from the display.

## Using RDS (excluding North American and Taiwan models)

**RDS works only in areas where RDS broadcasts are available.**

When tuned into an RDS station, the **RDS** indicator lights. When the station is broadcasting text information, the text can be displayed.

### ■ What is RDS?

RDS stands for Radio Data System and is a method of transmitting data in FM radio signals. It was developed by the European Broadcasting Union (EBU) and is available in most European countries. Many FM stations use it these days. In addition to displaying text information, RDS can also help you find radio stations by type (e.g., news, sport, rock, etc.).

The AV receiver supports four types of RDS information: **PS (Program Service)**

When tuned to an RDS station that's broadcasting PS information, the station's name will be displayed. Pressing **DISPLAY** will display the frequency for 3 seconds.

**RT (Radio Text)**

When tuned to an RDS station that's broadcasting text information, the text will be shown on the display as described in the next section.

**PTY (Program Type)**

This allows you to search for RDS radio stations by type (→ **page 30**).

**TP (Traffic Program)**

This allows you to search for RDS radio stations that broadcast traffic information (→ **page 30**).

### Note

- In some cases, the text characters displayed on the AV receiver may not be identical to those broadcast by the radio station. Also, unexpected characters may be displayed when unsupported characters are received. This is not a malfunction.
- If the signal from an RDS station is weak, RDS data may be displayed intermittently or not at all.

## ■ Displaying Radio Text (RT)

### 1 Press RT/PTY/TP once.

The RT information scrolls across the display.

#### Note

- The message “**Waiting**” may appear while the AV receiver waits for the RT information.
- If the message “**No Text Data**” appears on the display, no RT information is available.

## ■ Finding Stations by Type (PTY)

You can search for radio stations by type.

### 1 Press RT/PTY/TP twice.

The current program type appears on the display.

### 2 Use PRESET ◀/▶ to select the type of program you want.

See the table shown later in this chapter.

### 3 To start the search, press ENTER.

The AV receiver searches until it finds a station of the type you specified, at which point it stops briefly before continuing with the search.

### 4 When a station you want to listen to is found, press ENTER.

If no stations are found, the message “**Not Found**” appears.

## ■ Listening to Traffic News (TP)

You can search for stations that broadcast traffic news.

### 1 Press RT/PTY/TP three times.

If the current radio station is broadcasting TP (Traffic Program), “[TP]” will appear on the display, and traffic news will be heard as and when it’s broadcast. If “TP” without square brackets appears, this means that the station is not broadcasting TP.

### 2 To locate a station that is broadcasting TP, press ENTER.

The AV receiver searches until it finds a station that’s broadcasting TP.

If no stations are found, the message “**Not Found**” appears.

## RDS program types (PTY)

Type	Display
None	None
News reports	News
Current affairs	Affairs
Information	Info
Sport	Sport
Education	Educate
Drama	Drama
Culture	Culture
Science and technology	Science
Varied	Varied
Pop music	Pop M
Rock music	Rock M
Middle of the road music	Easy M
Light classics	Light M
Serious classics	Classics
Other music	Other M
Weather	Weather
Finance	Finance
Children’s programmes	Children
Social affairs	Social
Religion	Religion
Phone in	Phone In
Travel	Travel
Leisure	Leisure
Jazz music	Jazz
Country music	Country
National music	Nation M
Oldies music	Oldies
Folk music	Folk M
Documentary	Document
Alarm test	TEST
Alarm	Alarm!

# Using Basic Functions

## Using the Automatic Speaker Setup

With the supplied calibrated microphone, Audyssey MultEQ® XT automatically determines the number of speakers connected, their size for purposes of bass management, optimum crossover frequencies to the subwoofer (if present), and distances from the primary listening position.

Audyssey MultEQ XT then removes the distortion caused by room acoustics by capturing room acoustical problems over the listening area in both the frequency and time domain. The result is clear, well-balanced sound for everyone. Audyssey MultEQ XT can be used with Audyssey Dynamic EQ® and Audyssey Dynamic Volume® (→ [page 52](#)).

Before using this function, connect and position all of your speakers.

Audyssey MultEQ XT offers two ways of measuring: the “Audyssey Quick Start” and “Audyssey MultEQ XT Full Calibration”.

- “Audyssey Quick Start” uses the measurement from one position to perform the speaker setting only.
- “Audyssey MultEQ XT Full Calibration” uses the measurement from eight positions to correct room response in addition to the speaker setting.

The Quick Start takes 2 minutes and Full Calibration takes about 20 minutes.

Total measurement time varies depending on the number of speakers.

### Measurement procedure

To create a listening environment in your home theater that all listeners will enjoy, Audyssey MultEQ XT takes measurements at up to eight positions within the listening area. Position the microphone at ear height of a seated listener with the microphone tip pointed directly at the ceiling using a tripod. Do not hold the microphone in your hand during measurements as this will produce inaccurate results.

#### ■ First measurement position

Also referred to as the Main Listening Position this refers to the most central position where one would normally sit within the listening environment. Audyssey MultEQ XT uses the measurements from this position to calculate speaker distance, level, polarity, and the optimum crossover value for the subwoofer.

#### ■ Second–eighth measurement positions

These are the other listening positions (i.e., the places where the other listeners will sit). You can measure up to eight positions.

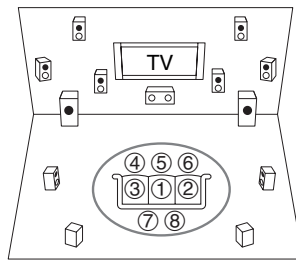

○ : Listening area      ① to ⑧: Listening position

#### Note

- Make the room as quiet as possible. Background noise and Radio Frequency Interference (RFI) can disrupt the room measurements. Close windows, televisions, radios, air conditioners, fluorescent lights, home appliances, light dimmers, or other devices. Turn off the cell phone (even if it is not in use) or place it away from all audio electronics.
- The microphone picks up test tones played through each speaker as Audyssey MultEQ XT Room Correction and Speaker Setup run.
- Audyssey MultEQ XT Room Correction and Speaker Setup cannot be performed while a pair of headphones is connected.

- 1 Turn on the AV receiver and the connected TV.**  
On the TV, select the input to which the AV receiver is connected.
- 2 Set the speaker setup microphone at the Main Listening Position ①, and connect it to the SETUP MIC jack.**

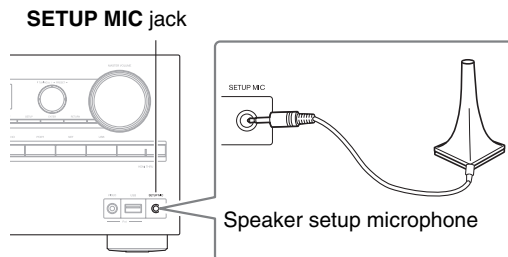

The speaker setting menu appears.

#### Note

- The on-screen menus appear only on a TV that is connected to the **HDMI OUT MAIN**. If your TV is connected to other video outputs, use the AV receiver’s display when changing settings.

- 3** When you've finished making the settings, press **ENTER**.

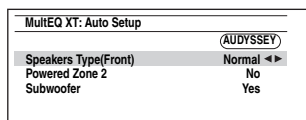

Perform the "Speaker Setup" according to your speaker configuration:

- **Speakers Type(Front)** (→ **page 46**)
- **Powered Zone 2** (→ **page 46**)
- **Subwoofer** (→ **page 47**)

If you use a powered subwoofer(s), go to step 4. If not, go to step 5.

When an optional unit is connected to the **UNIVERSAL PORT** jack on the AV receiver, the optional unit setting may appear on the speaker setting menu.

- 4** Adjust the subwoofer volume level to 75 dB.

Test tones are played through the subwoofer. Use the volume control on the subwoofer.

**Note**

- If your subwoofer does not have a volume control, disregard the displayed level and press **ENTER** to proceed to the next step.
- If you set the subwoofer's volume control to its maximum and the level displayed is lower than 75 dB, leave the subwoofer's volume control at its maximum and press **ENTER** to proceed to the next step.

- 5** Use **▲/▼** to select "Audyssey Quick Start" or "Audyssey MultEQ XT Full Calibration".

- 6** Press **ENTER**.

Audyssey MultEQ® XT Room Correction and Speaker Setup starts.

Test tones are played through each speaker as Audyssey MultEQ XT Room Correction and Speaker Setup runs. This process takes a few minutes. Please **refrain from talking** during measurements and **do not stand** between speakers and the microphone.

Do not disconnect the speaker setup microphone during Audyssey MultEQ XT Room Correction and Speaker Setup, unless you want to cancel the setup. If you select "Audyssey Quick Start", you will go to step 9.

- 7** Place the setup microphone at the next position, and then press **ENTER**.

Audyssey MultEQ XT performs more measurements. This takes a few minutes.

- 8** When prompted, repeat step 7.

- 9** Use **▲/▼** to select an option, and then press **ENTER**.

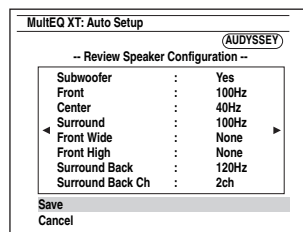

The options are:

▶ **Save:**

Save the calculated settings and exit Audyssey MultEQ XT Room Correction and Speaker Setup.

▶ **Cancel:**

Cancel Audyssey MultEQ XT Room Correction and Speaker Setup.

**Note**

- You can view the calculated settings for the speaker configuration, speaker distances, and speaker levels by using **◀/▶**.

- 10** Use **▲/▼** to select a target, and use **◀/▶** to change the setting.

After the results of Audyssey MultEQ XT have been saved, the menu will display the "Audyssey" (→ **page 52**), "Dynamic EQ" (→ **page 52**), "Dynamic Volume" (→ **page 52**) settings.

**Note**

- When "Audyssey Quick Start" has been used for measurement, "Audyssey" cannot be selected.
- These settings are applied to all input selectors.

- 11** Press **ENTER**.

- 12** Disconnect the speaker setup microphone.

**Note**

- You can cancel Audyssey MultEQ XT Room Correction and Speaker Setup at any point in this procedure simply by disconnecting the setup microphone.
- Do not connect or disconnect any speakers during Audyssey MultEQ XT Room Correction and Speaker Setup.
- If the AV receiver is muted, it will be unmuted automatically when Audyssey MultEQ XT Room Correction and Speaker Setup starts.
- Changes to the room after Audyssey MultEQ XT Room Correction and Speaker Setup requires you run Audyssey MultEQ XT Room Correction and Speaker Setup again, as room EQ characteristics may have changed.



## Error Messages

While Audyssey MultEQ® XT Room Correction and Speaker Setup is in progress, one of the error messages below may appear.

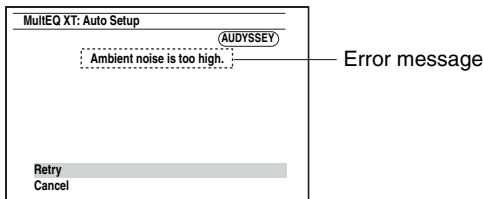

The options are:

- ▶ **Retry:**
  - Try again.
- ▶ **Cancel:**
  - Cancel Audyssey MultEQ XT Room Correction and Speaker Setup.
- **Ambient noise is too high.**
  - The background noise is too loud. Remove the source of the noise and try again.
- **Speaker Matching Error!**
  - The number of speakers detected was different from that of the first measurement. Check the speaker connection.
- **Writing Error!**
  - This message appears if saving fails. Try saving again. If this message appears after 2 or 3 attempts, contact your Onkyo dealer.
- **Speaker Detect Error**
  - This message appears if a speaker is not detected. “No” means that no speaker was detected.

### Tip

- See “Speaker Configuration” for appropriate settings (→ [page 13](#)).

## Changing the Speaker Setup Manually

You can manually make changes to the settings found during Audyssey MultEQ XT Room Correction and Speaker Setup.

See also:

- “Speaker Configuration” (→ [page 47](#))
- “Speaker Distance” (→ [page 48](#))
- “Level Calibration” (→ [page 48](#))
- “Equalizer Settings” (→ [page 49](#))

### Note

- Please note that THX recommends any THX main speakers be set to “80Hz(THX)”. If you set up your speakers using Audyssey MultEQ XT Room Correction and Speaker Setup, please make sure manually that any THX speakers are set to “80Hz(THX)” crossover (→ [page 47](#)).
- Sometimes due to the electrical complexities of subwoofers and the interaction with the room, THX recommends setting the level and the distance of the subwoofer manually.
- Sometimes due to interaction with the room, you may notice irregular results when setting the level and/or distance of the main speakers. If this happens, THX recommends setting them manually.

## Using a Powered Subwoofer

If you’re using a powered subwoofer and it outputs very low-frequency sound at a low volume level, it may not be detected by Audyssey MultEQ XT Room Correction and Speaker Setup.

If the “Subwoofer” appears on the “Review Speaker Configuration” screen as “No”, increase the subwoofer’s volume to the half-way point, set it to its highest crossover frequency, and then try running Audyssey MultEQ XT Room Correction and Speaker Setup again. Note that if the volume is set too high and the sound distorts, detection issues may occur, so use an appropriate volume level. If the subwoofer has a low-pass filter switch, set it to Off or Direct. Refer to your subwoofer’s instruction manual for details.

## Selecting Listening Modes

See “About Listening Modes” for detailed information about the listening modes (→ page 35).

### ■ Listening Mode Buttons

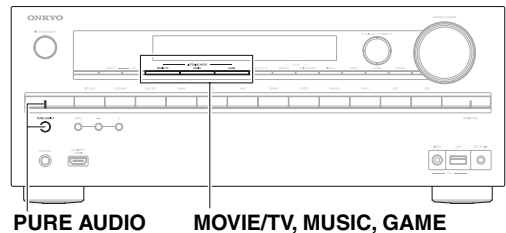
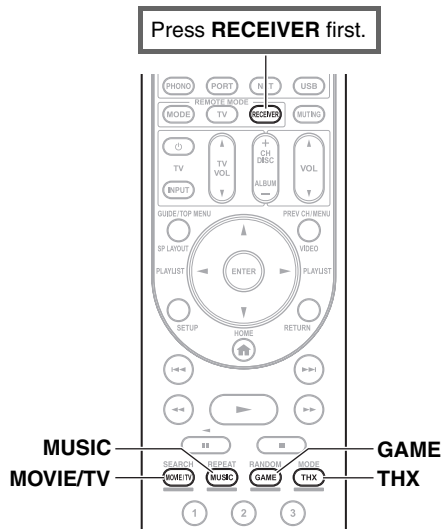

#### **MOVIE/TV button**

This button selects the listening modes intended for use with movies and TV.

#### **MUSIC button**

This button selects the listening modes intended for use with music.

#### **GAME button**

This button selects the listening modes intended for use with video games.

#### **THX button**

This button selects the THX listening modes.

#### **PURE AUDIO button and indicator**

This button selects the Pure Audio listening mode. When this mode is selected, the AV receiver’s display and video circuitry are turned off. Only video signals input through HDMI input can be output from an HDMI output(s). The indicator lights when this mode is selected. Pressing this button again will select the previous listening mode.

- The Dolby Digital and DTS listening modes can only be selected if your Blu-ray Disc/DVD player is connected to the AV receiver with a digital audio connection (coaxial, optical, or HDMI).
- The listening modes you can select depends on the format of the input signal. To check the format, see “Displaying Source Information” (→ page 41).
- While a pair of headphones is connected, you can select the following listening modes: Pure Audio, Mono, Direct, and Stereo.

## About Listening Modes

The AV receiver's listening modes can transform your listening room into a movie theater or concert hall, with high fidelity and stunning surround sound.

### ■ Explanatory Notes

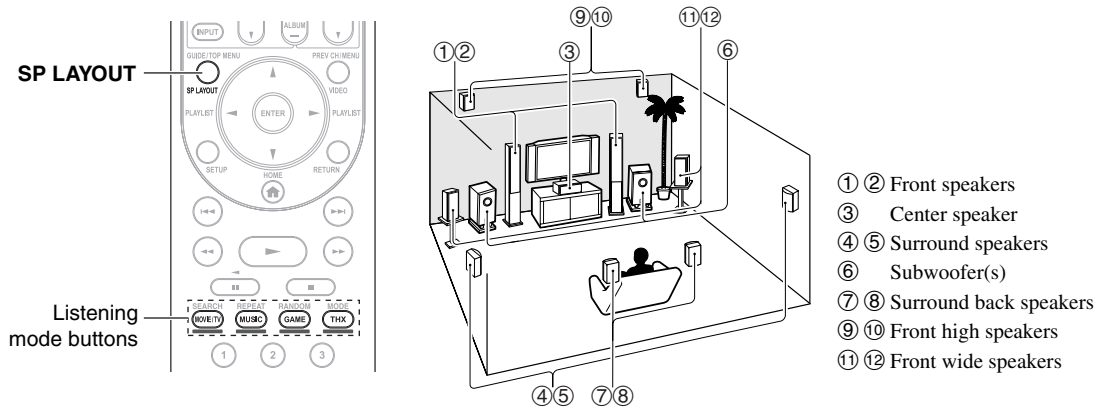

### Input Source

The following audio formats are supported by the listening mode.

<b>MONO</b>	This is mono (monophonic) sound.
<b>STEREO</b>	This is stereo (stereophonic) sound. Two independent audio signal channels are reproduced through two speakers.
<b>5.1ch</b>	This is 5.1-channel surround sound. This surround system has five main channels of sound and a sixth subwoofer channel (called the point-one channel).
<b>7.1ch</b>	This is 7.1-channel surround sound. This is a further sound enhancement to 5.1 channel sound with two additional speakers that provide greater sound envelopment and more accurate positioning of sounds.
<b>DTS-ES</b>	This is DTS-ES surround sound. This surround system can produce a discrete or a matrix-encoded sixth channel from existing DTS 5.1 encoded material.
<b>DJEX</b>	This is Dolby Digital EX surround sound. This provides a center back surround channel from 5.1-channel sources.

### Speaker Layout

The illustration shows which speakers are activated in each channel. See "Speaker Configuration" for the speaker setup (→ page 47).

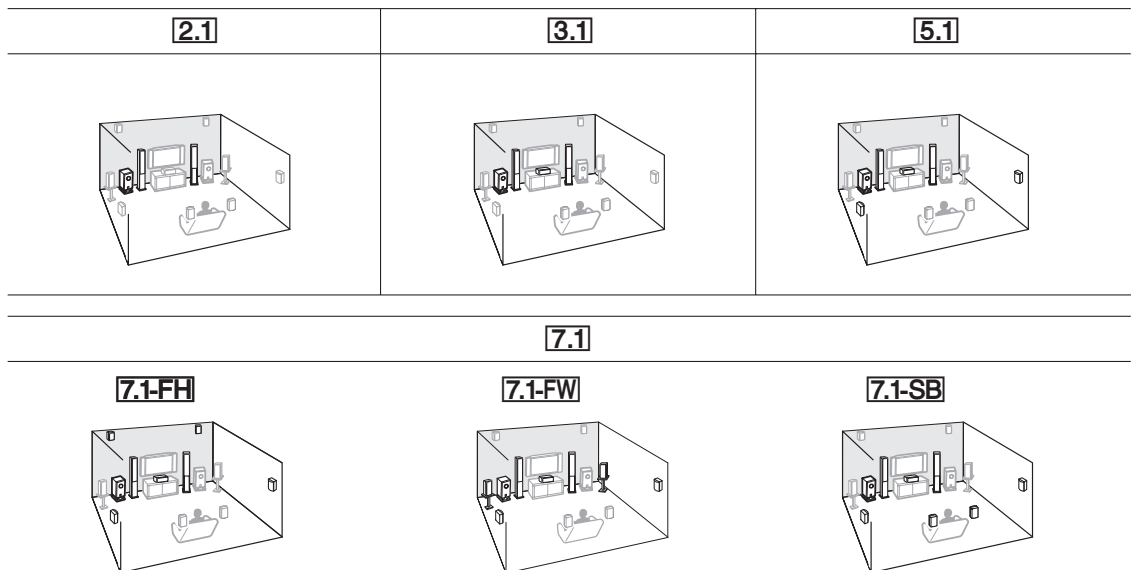

Press **RECEIVER** followed by **SP LAYOUT** repeatedly to select the speakers you want to use: front high, front wide, or surround back.

## ■ Onkyo-Original DSP Listening Modes

Listening Mode	Description	Input Source	Speaker Layout
<b>Orchestra</b> <i>Orchestra</i>	Suitable for classical or operatic music, this mode emphasizes the surround channels in order to widen the stereo image, and simulates the natural reverberation of a large hall.	<b>MONO</b> <b>STEREO</b> <b>5.1ch</b> <b>7.1ch</b> <b>DTS-ES</b> <b>DJEX</b>	<b>5.1</b> <b>7.1</b> *1
<b>Unplugged</b> <i>Unplugged</i>	Suitable for acoustic instruments, vocals, and jazz, this mode emphasizes the front stereo image, giving the impression of being right in front of the stage.		
<b>Studio-Mix</b> <i>Studio-Mix</i>	Suitable for rock or pop music, listening to music in this mode creates a lively sound field with a powerful acoustic image, like being at a club or rock concert.		
<b>TV Logic</b> <i>TV Logic</i>	This mode adds realistic acoustics to TV shows produced in a TV studio, surround effects to the entire sound, and clarity to voices.		
<b>Game-RPG</b> <i>Game-RPG</i>	In this mode, the sound has a dramatic feel with a similar atmosphere to Orchestra mode.		
<b>Game-Action</b> <i>Game-Action</i>	In this mode, sound localization is distinct with emphasis on bass.		
<b>Game-Rock</b> <i>Game-Rock</i>	In this mode, sound pressure is emphasized to heighten live feel.		
<b>Game-Sports</b> <i>Game-Sports</i>	In this mode, reverberation is increased and sound localization decreased slightly.		
<b>All Ch Stereo</b> <i>All Ch Stereo</i>	Ideal for background music, this mode fills the entire listening area with stereo sound from the front, surround, and surround back speakers.		<b>3.1</b> <b>5.1</b> <b>7.1</b> *1
<b>Full Mono</b> <i>Full Mono</i>	In this mode, all speakers output the same sound in mono, so the sound you hear is the same regardless of where you are within the listening room.		
<b>T-D (Theater-Dimensional)</b> <i>T-D</i>	With this mode you can enjoy a virtual surround sound even with only two or three speakers. This works by controlling how sounds reach the listener's left and right ears. Good results may not be possible if there's too much reverb, so we recommend that you use this mode in an environment with little or no natural reverb.		<b>2.1</b> <b>3.1</b> <b>5.1</b> <b>7.1</b>

## ■ Listening Modes

Listening Mode	Description	Input Source	Speaker Layout
<b>Pure Audio</b> *2 <i>Pure Audio</i>	In this mode, the display and video circuitry are turned off, minimizing possible noise sources for the ultimate in high-fidelity audio reproduction. A/V Sync does not have effect on the analog audio. (As the video circuitry is turned off, only video signals input through HDMI input can be output from an HDMI output(s).)	<b>MONO</b> <b>STEREO</b> <b>5.1ch</b> <b>7.1ch</b> <b>DTS-ES</b> <b>DJEX</b>	<b>2.1</b> <b>3.1</b> <b>5.1</b> <b>7.1</b> *3
<b>Direct</b> <i>Direct</i>	In this mode, audio from the input source is output without surround-sound processing. The speaker configuration (presence of speakers) and speaker distance settings are enabled, but much of the processing set via Home menu is disabled. A/V Sync does not have effect on the analog audio. See "Advanced Setup" for more details (→ <a href="#">page 43</a> ).		
<b>Stereo</b> <i>Stereo</i>	Sound is output from the front left and right speakers and subwoofer.		<b>2.1</b> <b>3.1</b> <b>5.1</b> <b>7.1</b>
<b>Mono</b> <i>Mono</i>	Use this mode when watching an old movie with a mono soundtrack, or use it with the foreign language soundtracks recorded in the left and right channels of some movies. It can also be used with DVDs or other sources containing multiplexed audio, such as karaoke DVDs.		
<b>Multichannel</b> <i>Multich</i>	This mode is for use with PCM multichannel sources.	<b>5.1ch</b> <b>7.1ch</b>	<b>3.1</b> <b>5.1</b> <b>7.1</b>

Listening Mode	Description	Input Source	Speaker Layout
<b>Dolby Pro Logic IIx</b> <sup>*4</sup> <b>Dolby Pro Logic II</b>	<b>Dolby Pro Logic IIx</b> expands any 2-channel source for 7.1-channel playback. It provides a very natural and seamless surround-sound experience that fully envelops the listener. As well as music and movies, video games can also benefit from the dramatic spatial effects and vivid imaging.		
<i>PL II Movie</i>			
<i>PL II Music</i>	If you're not using any surround back speakers, <b>Dolby Pro Logic II</b> will be used instead of Dolby Pro Logic IIx.	<b>STEREO</b>	<b>3.1</b> <b>5.1</b> <b>7.1</b>
<i>PL II Game</i>	• <b>Dolby PLIIx Movie</b> Use this mode with any stereo or Dolby Surround (Pro Logic) movie (e.g., TV, DVD, VHS).		
<i>PL IIx Movie</i>	• <b>Dolby PLIIx Music</b> Use this mode with any stereo or Dolby Surround (Pro Logic) music source (e.g., CD, radio, cassette, TV, VHS, DVD).		
<i>PL IIx Music</i>	• <b>Dolby PLIIx Game</b> Use this mode with video games, especially those that bear the Dolby Pro Logic II logo.		
<i>PL IIx Game</i>	• <b>Dolby PLIIx Movie</b> • <b>Dolby PLIIx Music</b> These modes use the Dolby Pro Logic IIx modes to expand 5.1-channel sources for 7.1-channel playback.	<b>5.1ch</b>	<b>7.1-SB</b>
<b>Dolby Pro Logic IIz Height</b>	<b>Dolby Pro Logic IIz Height</b> is designed to more effectively use existing program material when height channel speaker outputs are present. <b>Dolby Pro Logic IIz Height</b> can be used to upmix a variety of sources from movies and music, but are particularly well-suited to upmix game content.	<b>STEREO</b> <b>5.1ch</b> <b>7.1ch</b>	<b>7.1-FH</b>
<i>PL IIz Height</i>			
<b>Dolby EX</b>	These modes expand 5.1-channel sources for 6.1/7.1-channel playback. They're especially suited to Dolby EX soundtracks that include a matrix-encoded surround back channel. The additional channel adds an extra dimension and provides an enveloping surround sound experience, perfect for rotating and fly-by sound effects.	<b>5.1ch</b> <b>Dolby EX</b>	<b>7.1-SB</b>
<i>Dolby EX</i>			
<i>Dolby D EX</i>			
<b>Dolby Digital</b>	In this mode, audio from the input source is output without surround-sound processing. The speaker configuration (presence of speakers), crossover frequency, speaker distance, A/V Sync and much of the processing set via Home menu are enabled. See "Advanced Setup" for more details	<b>5.1ch</b>	<b>3.1</b> <b>5.1</b> <b>7.1</b>
<i>Dolby D</i>	(→ <b>page 43</b> ).		
<b>Dolby Digital Plus</b> <sup>*5</sup>		<b>5.1ch</b>	<b>3.1</b> <b>5.1</b> <b>7.1</b>
<i>Dolby D +</i>		<b>7.1ch</b>	<b>3.1</b> <b>5.1</b> <b>7.1</b> <sup>*3</sup>
<b>Dolby TrueHD</b>		<b>5.1ch</b>	<b>3.1</b> <b>5.1</b> <b>7.1</b>
<i>Dolby TrueHD</i>		<b>7.1ch</b>	<b>3.1</b> <b>5.1</b> <b>7.1</b> <sup>*3</sup>
<b>DTS</b>		<b>5.1ch</b>	<b>3.1</b> <b>5.1</b> <b>7.1</b>
<i>DTS</i>			
<b>DTS-HD High Resolution Audio</b>		<b>5.1ch</b>	<b>3.1</b> <b>5.1</b> <b>7.1</b>
<i>DTS-HD HR</i>		<b>7.1ch</b>	<b>3.1</b> <b>5.1</b> <b>7.1</b> <sup>*3</sup>
<b>DTS-HD Master Audio</b>		<b>5.1ch</b>	<b>3.1</b> <b>5.1</b> <b>7.1</b>
<i>DTS-HD MSTR</i>		<b>7.1ch</b>	<b>3.1</b> <b>5.1</b> <b>7.1</b> <sup>*3</sup>
<b>DTS Express</b>		<b>5.1ch</b>	<b>3.1</b> <b>5.1</b> <b>7.1</b>
<i>DTS Express</i>			
<b>DSD</b> <sup>*6</sup>			
<i>DSD</i>			
<b>DTS 96/24</b>	This mode is for use with DTS 96/24 sources. This is high-resolution DTS with a 96 kHz sampling rate and 24-bit resolution, providing superior fidelity. Use it with DVDs that bear the DTS 96/24 logo.	<b>5.1ch</b>	<b>3.1</b> <b>5.1</b> <b>7.1</b>
<i>DTS 96/24</i>			
<b>DTS-ES Discrete</b> <sup>*7</sup>	This mode is for use with DTS-ES Discrete soundtracks, which use a discrete surround back channel for true 6.1/7.1-channel playback. The seven totally separate audio channels provide better spatial imaging and 360-degree sound localization, perfect for sounds that pan across the surround channels. Use it with DVDs that bear the DTS-ES logo, especially those with a DTS-ES Discrete soundtrack.	<b>DTS-ES</b>	<b>7.1-SB</b>
<i>ES Discrete</i>			
<b>DTS-ES Matrix</b> <sup>*7</sup>	This mode is for use with DTS-ES Matrix soundtracks, which use a matrix-encoded back-channel for 6.1/7.1-channel playback. Use it with DVDs that bear the DTS-ES logo, especially those with a DTS-ES Matrix soundtrack.	<b>DTS-ES</b>	<b>7.1-SB</b>
<i>ES Matrix</i>			

Listening Mode	Description	Input Source	Speaker Layout
<b>Neo:6</b>	This mode expands any 2-channel source for up to 7.1-channel playback. It uses seven full-bandwidth channels of matrix decoding for matrix-encoded material, providing a very natural and seamless surround sound experience that fully envelops the listener.		
<i>Neo:6 Cinema</i>	<ul style="list-style-type: none"> <li>• <b>Neo:6 Cinema</b> Use this mode with any stereo movie (e.g., TV, DVD, VHS).</li> </ul>	<b>STEREO</b>	<b>3.1   5.1   7.1</b>
<i>Neo:6 Music</i>	<ul style="list-style-type: none"> <li>• <b>Neo:6 Music</b> Use this mode with any stereo music source (e.g., CD, radio, cassette, TV, VHS, DVD).</li> </ul>		
<i>Neo:6</i>	<ul style="list-style-type: none"> <li>• <b>Neo:6</b> This mode uses Neo:6 to expand 5.1-channel sources for 6.1/7.1-channel playback.</li> </ul>	<b>5.1ch</b>	<b>7.1-SB</b>
<b>Audyssey DSX<sup>8</sup></b>	<ul style="list-style-type: none"> <li>• <b>Audyssey DSX</b> Audyssey DSX™ is a scalable system that adds new speakers to improve surround impression. Starting with a 5.1 system Audyssey DSX first adds Wide channels for the biggest impact on envelopment. Research in human hearing has proven that information from the Wide channels is much more critical in the presentation of a realistic soundstage than Back Surround channels found in traditional 7.1 systems. Audyssey DSX then creates a pair of Height channels to reproduce the next most important acoustical and perceptual cues. In addition to these new Wide and Height channels, Audyssey DSX applies Surround Envelopment Processing to enhance the blend between the front and surround channels.</li> </ul>	<b>5.1ch</b> <b>7.1ch</b> <b>DTS-ES</b>	<b>7.1-FH   7.1-FW</b>
<i>PLII Movie DSX</i>	<ul style="list-style-type: none"> <li>• <b>Dolby Pro Logic II Movie + Audyssey DSX</b></li> <li>• <b>Dolby Pro Logic II Music + Audyssey DSX</b></li> <li>• <b>Dolby Pro Logic II Game + Audyssey DSX</b></li> </ul>	<b>STEREO</b>	<b>7.1-FH   7.1-FW</b>
<i>PLII Music DSX</i>	The combination of Dolby Pro Logic II and Audyssey DSX modes can be used.		
<i>PLII Game DSX</i>			
<b>THX</b>	Founded by George Lucas, THX develops stringent standards that ensure movies are reproduced in movie theaters and home theaters just as the director intended. THX Modes carefully optimize the tonal and spatial characteristics of the soundtrack for reproduction in the home-theater environment. They can be used with 2-channel matrixed and multichannel sources. Surround back speaker output depends on the source material and the selected listening mode.		
<i>THX Cinema</i>	<ul style="list-style-type: none"> <li>• <b>THX Cinema</b> THX Cinema mode corrects theatrical soundtracks for playback in a home theater environment. In this mode, THX Loudness Plus is configured for cinema levels and Re-EQ, Timbre Matching, and Adaptive Decorrelation are active.</li> </ul>	<b>5.1ch</b> <b>7.1ch</b> <b>DTS-ES</b>	<b>5.1   7.1</b>
<i>THX Music</i>	<ul style="list-style-type: none"> <li>• <b>THX Music</b> THX Music mode is tailored for listening to music, which is typically mastered at significantly higher levels than movies. In this mode, THX Loudness Plus is configured for music playback and only Timbre Matching is active.</li> </ul>		
<i>THX Games</i>	<ul style="list-style-type: none"> <li>• <b>THX Games</b> THX Games mode is meant for spatially accurate playback of game audio, which is often mixed similarly to movies but in a smaller environment. THX Loudness Plus is configured for game audio levels, with Timbre Matching active.</li> </ul>		
	<ul style="list-style-type: none"> <li>• <b>Dolby Pro Logic II/IIx Movie + THX Cinema</b></li> <li>• <b>Dolby Pro Logic II/IIx Music + THX Music</b></li> <li>• <b>Dolby Pro Logic II/IIx Game + THX Games</b></li> </ul>	<b>STEREO</b>	<b>5.1   7.1</b>
	The combination of Dolby Pro Logic II/IIx <sup>4</sup> and THX Cinema/Music/Games modes can be used. The <b>PLII</b> or <b>PLIIx</b> indicator lights on the display.		
	<ul style="list-style-type: none"> <li>• <b>Dolby Pro Logic IIx Movie + THX Cinema</b></li> <li>• <b>Dolby Pro Logic IIx Music + THX Music</b></li> </ul>	<b>5.1ch</b> <b>DD EX</b>	<b>7.1-SB</b>
	The combination of Dolby Pro Logic IIx and THX Cinema/Music modes can be used. The <b>PLIIx</b> indicator lights on the display.		

Listening Mode	Description	Input Source	Speaker Layout
	<ul style="list-style-type: none"> <li>• <b>Dolby Pro Logic IIz Height + THX Cinema</b></li> <li>• <b>Dolby Pro Logic IIz Height + THX Music</b></li> <li>• <b>Dolby Pro Logic IIz Height + THX Games</b></li> </ul> <p>The combination of Dolby Pro Logic IIz Height and THX Cinema/Music/Games modes can be used. The <b>PLIIz</b> indicator lights on the display.</p>	<b>STEREO</b> <b>5.1ch</b> <b>7.1ch</b> <b>DTS-ES</b> <b>DDEX</b>	<b>7.1-FH</b>
	<ul style="list-style-type: none"> <li>• <b>Neo:6 Cinema + THX Cinema</b></li> <li>• <b>Neo:6 Music + THX Music</b></li> </ul>	<b>STEREO</b>	<b>5.1</b> <b>7.1</b>
	<ul style="list-style-type: none"> <li>• <b>Neo:6 + THX Cinema</b></li> <li>• <b>Neo:6 + THX Music</b></li> <li>• <b>Neo:6 + THX Games</b></li> </ul> <p>The combination of Neo:6 and THX Cinema/Music/Games modes can be used. The <b>Neo:6</b> indicator lights on the display.</p>	<b>5.1ch</b> <b>DDEX</b>	<b>7.1-SB</b>
<i>THX S2 Cinema</i>	<ul style="list-style-type: none"> <li>• <b>THX Select2 Cinema</b></li> </ul> <p>This mode expands 5.1-channel sources for 7.1- channel playback. It does this by analyzing the composition of the surround source, optimizing the ambient and directional sounds to produce the surround back channel output.</p>	<b>5.1ch</b>	<b>7.1-SB</b>
<i>THX S2 Music</i>	<ul style="list-style-type: none"> <li>• <b>THX Select2 Music</b></li> </ul> <p>This mode is designed for use with music. It expands 5.1-channel sources for 7.1-channel playback.</p>		
<i>THX S2 Games</i>	<ul style="list-style-type: none"> <li>• <b>THX Select2 Games</b></li> </ul> <p>This mode is designed for use with video games. It can expand 5.1-channel sources for 6.1/7.1-channel playback.</p>		
<i>THX Surr EX</i>	<ul style="list-style-type: none"> <li>• <b>THX Surround EX</b></li> </ul> <p>This mode expands 5.1-channel sources for 6.1/7.1- channel playback. It's especially suited to Dolby Digital EX sources. THX Surround EX, also known as Dolby Digital Surround EX, is a joint development between Dolby Laboratories and THX Ltd.</p>		
	<ul style="list-style-type: none"> <li>• <b>Dolby Pro Logic II Game + THX Select2 Games</b></li> </ul> <p>The combination of Dolby Pro Logic II Game and THX Select2 Games modes can be used. The <b>PLII</b> indicator lights on the display.</p>	<b>STEREO</b>	<b>7.1-SB</b>

#### Note

- \*1 Depending on the “**Speaker Configuration**” setting (→ **page 47**), the output can be switched between the front high, front wide or surround back speakers by pressing **SP LAYOUT**.
- \*2 Pure Audio cannot be selected when Zone 2 is active.  
Besides, if you activate Zone 2 while Pure Audio is selected, the listening mode will automatically switch to Direct.
- \*3 Based on the audio channel signal contained in the source, the corresponding speakers will output the sound.
- \*4 If there are no surround back speakers, Dolby Pro Logic II is used.
- \*5 For the Blu-ray Discs, Dolby Digital is used in a 3.1/5.1-channel speaker system.
- \*6 AV receiver can input the DSD signal from HDMI IN. Setting the output setting on the player side to PCM might obtain a better sound according to the player. In that case, set the output setting on the player side to PCM.
- \*7 If there are no surround back speakers, DTS is used.
- \*8 • This listening mode can be selected only when all the following conditions are satisfied:
  - Center speaker is connected.
  - Either of front high or front wide speakers is connected.
- Depending on the “**Speaker Configuration**” setting (→ **page 47**), the output can be switched between the front high or front wide speakers by pressing **SP LAYOUT**.
- The listening modes cannot be selected with some source formats.

## Using the Home Menu

The Home menu provides you quick access to frequently used menus without having to go through the long standard menu. This menu enables you to change settings and view the current information.

**The on-screen menus appear only on a TV that is connected to the HDMI OUT MAIN. If your TV is connected to other video outputs, use the AV receiver's display when changing settings.**

### 1 Press RECEIVER followed by HOME.

The Home menu will be superimposed on the TV screen.

### 2 Use ▲/▼ and ENTER to make the desired selection.

#### ■ Input<sup>\*1</sup>

▶ You can select the input source while viewing the information as follows: the name of input selectors, input assignments, radio information, and ARC function setting.

Press **ENTER** to display the current input source, followed by ▲/▼ to select the desired input source. Pressing **ENTER** again switches to the selected input source.

#### ■ Audio

▶ You can change the following settings: “Bass”, “Treble”, “Subwoofer Level”, “Center Level”, “Dolby Volume”, “Audyssey”, “Dynamic EQ”, “Dynamic Volume”, “Late Night”, “Music Optimizer”, “Re-EQ” and “Re-EQ(THX)”.

See also:

- “Audyssey” (→ page 52)
- “Using the Audio Settings” (→ page 61)

#### ■ Video

▶ You can change the following settings: “Wide Mode” and “Picture Mode”<sup>\*2</sup>.

See also:

- “Picture Adjust” (→ page 54)

#### ■ Info<sup>\*3</sup>

▶ You can view the information of the following items: “Audio”, “Video” and “Tuner”.

#### ■ Listening Mode

▶ You can select the listening modes that are grouped in the following categories: **MOVIE/TV**, **MUSIC**, **GAME** and **THX**.

Use ▲/▼ to select the category and ◀/▶ to select the listening mode. Press **ENTER** to switch to the selected listening mode.

## Note

- \*1 For the **PORT** input selector, the name of Universal Port Option Dock will be displayed.
- \*2 Only when you have selected “**Custom**” in the “**Picture Mode**” (→ page 54), pressing **ENTER** allows you to adjust the following items via the Home menu: “**Brightness**”, “**Contrast**”, “**Hue**” and “**Saturation**”. Press **RETURN** to return to the “**Picture Mode**” setting.
- \*3 Depending on the input source and listening mode, not all channels shown here output the sound.

## Using the Sleep Timer

With the sleep timer, you can set the AV receiver to turn off automatically after a specified period.

### 1 Press RECEIVER followed by SLEEP repeatedly to select the required sleep time.

The sleep time can be set from 90 to 10 minutes in 10 minute steps.

The **SLEEP** indicator lights on the display when the sleep timer has been set. The specified sleep time appears on the display for about 5 seconds, then the previous display reappears.

#### Tip

- If you need to cancel the sleep timer, press **SLEEP** repeatedly until the **SLEEP** indicator goes off.
- To check the time remaining until the AV receiver sleeps, press **SLEEP**. Note that if you press again on **SLEEP** as the time being displayed is equal or inferior to 10 minutes, the sleep timer will go off.

## Setting the Display Brightness

You can adjust the brightness of the AV receiver's display.

### 1 Press RECEIVER followed by DIMMER repeatedly to select:

- Normal + **MASTER VOLUME** indicator lights.
- Normal + **MASTER VOLUME** indicator goes off.
- Dim + **MASTER VOLUME** indicator goes off.
- Dimmer + **MASTER VOLUME** indicator goes off.

#### Tip

- (North American and Taiwan models) Alternatively, you can use the AV receiver's **DIMMER**.



## Displaying Source Information

You can display various information about the current input source as follows. (Components connected to the **UNIVERSAL PORT** jack are excluded.)

- 1 Press **RECEIVER** followed by **DISPLAY** repeatedly to cycle through the available information.

The following information can typically be displayed.

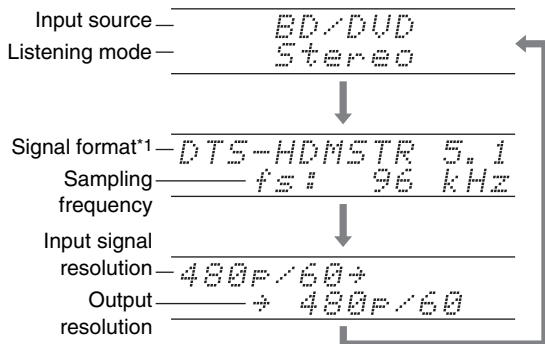

### Tip

- Alternatively, you can use the AV receiver's **DISPLAY**.

\*1 If the input signal is analog, "Analog" is displayed. If the input signal is PCM, the sampling frequency is displayed. If the input signal is digital but not PCM, the signal format is displayed. Information is displayed for about three seconds, then the previously displayed information reappears.

## Changing the Input Display

When you connect an **RI**-capable Onkyo component, you must configure the input display so that **RI** can work properly.

This setting can be done only from the front panel.

- 1 Press **TV/CD**, **GAME** or **VCR/DVR**. "TV/CD", "GAME" or "VCR/DVR" appears on the display.
- 2 Press and hold down **TV/CD**, **GAME** or **VCR/DVR** (about 3 seconds) to change the input display. Repeat this step to select the desired input display.

■ **TV/CD:** TV/CD → DOCK  
                  ↑ TAPE ←

■ **GAME:** GAME ↔ DOCK

■ **VCR/DVR:** VCR/DVR ↔ DOCK

### Note

- **DOCK** can be selected for the **TV/CD**, **GAME** or **VCR/DVR** input selector, but not at the same time.
- Enter the appropriate remote control code before using the remote controller for the first time (→ page 69).

## Selecting Speaker Layout

You can set which speakers you want to use by priority.

- 1 Press **RECEIVER** followed by **SP LAYOUT** repeatedly to select:

#### ▶ Speaker Layout:FH:

The sound from front high speakers is output by priority.

#### ▶ Speaker Layout:FW:

The sound from front wide speakers is output by priority.

#### ▶ Speaker Layout:SB:

The sound from surround back speakers is output by priority.

### Note

- If the "Speakers Type(Front)" setting is set to "Bi-Amp" (→ page 46), or the "Powered Zone 2" is set to "Yes" (→ page 46), this setting cannot be selected.
- Playback conditions may be limited depending on the settings in "Speaker Settings" (→ page 46) and "Speaker Configuration" (→ page 47).
- When a listening mode which doesn't support front high, front wide or surround back speakers is used, this setting cannot be selected.

## Muting the AV Receiver

You can temporarily mute the output of the AV receiver.

- 1 Press **RECEIVER** followed by **MUTING**.

The output is muted and the **MUTING** indicator flashes on the display.

### Tip

- To unmute, press **MUTING** again or adjust the volume.
- Muting is automatically cancelled when the AV receiver is set to standby.

## Using Headphones

- 1 Connect a pair of stereo headphones with a standard plug (1/4 inch or 6.3 mm) to the **PHONES** jack.

### Note

- Always turn down the volume before connecting your headphones.
- While the headphones plug is inserted in the **PHONES** jack, the speakers are turned off. (The Powered Zone 2 speakers are not turned off.)
- When you connect a pair of headphones, the listening mode is set to Stereo, unless it's already set to Stereo, Mono, Direct, or Pure Audio.
- If you connect an iPod or iPhone to the **USB** port on this device, no sound will be output from the headphones jack.

## Using Easy Macros

By using **ACTIVITIES** in Easy macro mode, you can sequentially operate Onkyo components via simple commands from a single-button press. These commands are user-definable. See "Using Normal Macros" (→ page 73).

### 1 Press **ACTIVITIES (MY MOVIE, MY TV, or MY MUSIC)** to start the Easy macro command.

The default sequences of actions are described below. To change the related source component, see "Changing the Source Components" shown later in this chapter.

#### ■ MY MOVIE

First, the TV, the Onkyo DVD player, and the AV receiver are turned on. The input selector is set to "**BD/DVD**". Finally the player starts playback.\*1

\*1 Depending on the start-up time of your Blu-ray Disc/DVD player, the AV receiver may not activate this playback command. In this case, press ► on the remote controller.

#### ■ MY TV

First, the TV, the cable set-top box, and the AV receiver are turned on. Then the input selector is set to "**CBL/SAT**".

#### ■ MY MUSIC

The Onkyo CD player and the AV receiver are turned on. The input selector is set to "**TV/CD**". Finally, the player starts playback.

#### Note

- While the Easy Macro command is being processed, you cannot use other **ACTIVITIES**. If you want to operate other components, first press **ALL OFF** and use the desired **ACTIVITIES**.

## Turning Off the Components

This button turns off all components activated by the Easy Macro mode.

### 1 Press **ALL OFF**.

First, the related components stop and turn off. Second, the AV receiver turns off. Finally, the TV turns off (or enters standby mode).\*1\*2

\*1 This step doesn't apply to **MY MUSIC**, with the default settings.

\*2 With some televisions, the power may not be turned off (or enter standby mode).

## Changing the Source Components

You can change the source components activated by the Easy Macro mode.

### 1 While holding down **REMOTE MODE** for the playback component you wish to assign, press and hold down the **ACTIVITIES** to be changed (**MY MOVIE, MY TV, or MY MUSIC**) (about 3 seconds).

**ACTIVITIES** flashes twice, indicating that the change is complete.

#### Examples:

If you wished to use **MY MUSIC** to start the Onkyo cassette recorder, you would press and hold down **MY MUSIC** (about 3 seconds) while holding down **TV/CD** until it flashes twice.

## Restoring Default

You can restore **ACTIVITIES** to the default settings.

### 1 While holding down **HOME**, press and hold down **ALL OFF** until **ALL OFF** lights (about 3 seconds).

### 2 Release **HOME** and **ALL OFF**, and press **ALL OFF** again.

**ALL OFF** flashes twice.

## Recording

This section explains how to record the selected input source to a component with recording capability, and how to record audio and video from different sources.

## AV Recording

Audio sources can be recorded to a recorder (e.g., cassette tape deck, CDR, MD recorder). Video sources can be recorded to a video recorder (e.g., VCR, DVD recorder).

### 1 Use the input selector buttons to select the source that you want to record.

You can watch the source while recording. The AV receiver's **MASTER VOLUME** control has no effect on recording.

### 2 On your recorder, start recording.

### 3 On the source component, start playback.

If you select another input source during recording, that input source will be recorded.

# Advanced Setup

The on-screen menus appear only on a TV that is connected to the HDMI OUT MAIN. If your TV is connected to other video outputs, use the AV receiver's display when changing settings.

This section describes the procedure for using the remote controller unless otherwise specified.

## On-screen Setup Menus

MENU	
①	1. Input/Output Assign
②	2. Speaker Setup
③	3. Audio Adjust
④	4. Source Setup
⑤	5. Listening Mode Preset
⑥	6. Miscellaneous
⑦	7. Hardware Setup
⑧	8. Remote Controller Setup
⑨	9. Lock Setup

<p>① <b>Input/Output Assign</b> (→ page 44)</p> <table border="1"> <tr><td>1. Input/Output Assign</td></tr> <tr><td>1. Monitor Out</td></tr> <tr><td>2. HDMI Input</td></tr> <tr><td>3. Component Video Input</td></tr> <tr><td>4. Digital Audio Input</td></tr> <tr><td>5. Analog Audio Input</td></tr> </table>	1. Input/Output Assign	1. Monitor Out	2. HDMI Input	3. Component Video Input	4. Digital Audio Input	5. Analog Audio Input	<p>⑥ <b>Miscellaneous</b> (→ page 57)</p> <table border="1"> <tr><td>6. Miscellaneous</td></tr> <tr><td>1. Volume Setup</td></tr> <tr><td>2. OSD Setup</td></tr> </table>	6. Miscellaneous	1. Volume Setup	2. OSD Setup					
1. Input/Output Assign															
1. Monitor Out															
2. HDMI Input															
3. Component Video Input															
4. Digital Audio Input															
5. Analog Audio Input															
6. Miscellaneous															
1. Volume Setup															
2. OSD Setup															
<p>② <b>Speaker Setup</b> (→ page 46)</p> <table border="1"> <tr><td>2. Speaker Setup</td></tr> <tr><td>1. Speaker Settings</td></tr> <tr><td>2. Speaker Configuration</td></tr> <tr><td>3. Speaker Distance</td></tr> <tr><td>4. Level Calibration</td></tr> <tr><td>5. Equalizer Settings</td></tr> <tr><td>6. THX Audio Setup</td></tr> </table>	2. Speaker Setup	1. Speaker Settings	2. Speaker Configuration	3. Speaker Distance	4. Level Calibration	5. Equalizer Settings	6. THX Audio Setup	<p>⑦ <b>Hardware Setup</b> (→ page 57)</p> <table border="1"> <tr><td>7. Hardware Setup</td></tr> <tr><td>1. Remote ID</td></tr> <tr><td>2. Tuner</td></tr> <tr><td>3. HDMI</td></tr> <tr><td>4. Auto Standby</td></tr> <tr><td>5. Network</td></tr> <tr><td>6. Firmware Update</td></tr> </table>	7. Hardware Setup	1. Remote ID	2. Tuner	3. HDMI	4. Auto Standby	5. Network	6. Firmware Update
2. Speaker Setup															
1. Speaker Settings															
2. Speaker Configuration															
3. Speaker Distance															
4. Level Calibration															
5. Equalizer Settings															
6. THX Audio Setup															
7. Hardware Setup															
1. Remote ID															
2. Tuner															
3. HDMI															
4. Auto Standby															
5. Network															
6. Firmware Update															
<p>③ <b>Audio Adjust</b> (→ page 50)</p> <table border="1"> <tr><td>3. Audio Adjust</td></tr> <tr><td>1. Multiplex/Mono</td></tr> <tr><td>2. Dolby</td></tr> <tr><td>3. DTS</td></tr> <tr><td>4. Audyssey DSX</td></tr> <tr><td>5. Theater-Dimensional</td></tr> <tr><td>6. LFE Level</td></tr> </table>	3. Audio Adjust	1. Multiplex/Mono	2. Dolby	3. DTS	4. Audyssey DSX	5. Theater-Dimensional	6. LFE Level	<p>⑧ <b>Remote Controller Setup</b> (→ page 69)</p> <table border="1"> <tr><td>8. Remote Controller Setup</td></tr> <tr><td>1. Remote Mode Setup</td></tr> </table>	8. Remote Controller Setup	1. Remote Mode Setup					
3. Audio Adjust															
1. Multiplex/Mono															
2. Dolby															
3. DTS															
4. Audyssey DSX															
5. Theater-Dimensional															
6. LFE Level															
8. Remote Controller Setup															
1. Remote Mode Setup															
<p>④ <b>Source Setup</b> (→ page 52)</p> <table border="1"> <tr><td>4. Source Setup</td></tr> <tr><td>1. Audyssey</td></tr> <tr><td>2. IntelliVolume</td></tr> <tr><td>3. A/V Sync</td></tr> <tr><td>4. Name Edit</td></tr> <tr><td>5. Picture Adjust</td></tr> <tr><td>6. Audio Selector</td></tr> </table>	4. Source Setup	1. Audyssey	2. IntelliVolume	3. A/V Sync	4. Name Edit	5. Picture Adjust	6. Audio Selector	<p>⑨ <b>Lock Setup</b> (→ page 61)</p> <table border="1"> <tr><td>9. Lock Setup</td></tr> <tr><td>Setup</td></tr> </table>	9. Lock Setup	Setup					
4. Source Setup															
1. Audyssey															
2. IntelliVolume															
3. A/V Sync															
4. Name Edit															
5. Picture Adjust															
6. Audio Selector															
9. Lock Setup															
Setup															
<p>⑤ <b>Listening Mode Preset</b> (→ page 56)</p> <table border="1"> <tr><td>5. Listening Mode Preset</td></tr> <tr><td>1. BD/DVD</td></tr> <tr><td>2. VCR/DVR</td></tr> <tr><td>3. CBL/SAT</td></tr> <tr><td>4. GAME</td></tr> <tr><td>5. PC</td></tr> <tr><td>6. AUX</td></tr> </table>	5. Listening Mode Preset	1. BD/DVD	2. VCR/DVR	3. CBL/SAT	4. GAME	5. PC	6. AUX								
5. Listening Mode Preset															
1. BD/DVD															
2. VCR/DVR															
3. CBL/SAT															
4. GAME															
5. PC															
6. AUX															

## Common Procedures in Setup Menu

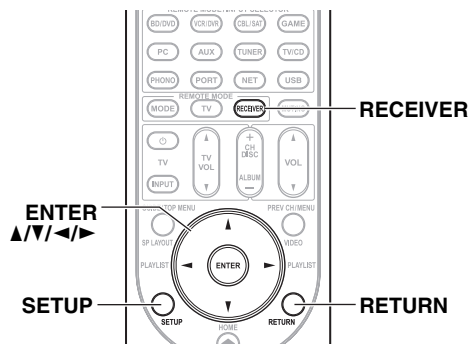

The on-screen setup menus appear on the connected TV and provide a convenient way to change the AV receiver's various settings. Settings are organized into 9 categories on the **main menu**.

Carry out the settings by using the on-screen display.

### 1 Press RECEIVER followed by SETUP.

#### Tip

- If the main menu doesn't appear, make sure the appropriate external input is selected on your TV.

### 2 Use ▲/▼ to select a menu, and then press ENTER.

### 3 Use ▲/▼ to select a target, and then press ENTER.

### 4 Use ▲/▼ to select an option, and use ◀/▶ to change the setting.

Press **SETUP** to close the menu.

Press **RETURN** to return to the previous menu.

#### Note

- This procedure can also be performed on the AV receiver by using **SETUP**, the arrow buttons, and **ENTER**.
- During Audyssey MultEQ® XT Room Correction and Speaker Setup, messages, etc., that are displayed on the TV screen will appear in the Display.

## Explanatory Notes

①	Main Menu	Speaker Configuration
②	Subwoofer	
③	Yes	No

① Menu selection

② Setting target

③ Setting options (default setting underlined)

## Monitor Out

If you connect your TV to HDMI output, “**Monitor Out**” setting is automatically set so that the onscreen setup menus are displayed and composite video, S-Video, and component video sources are upconverted\* and output.

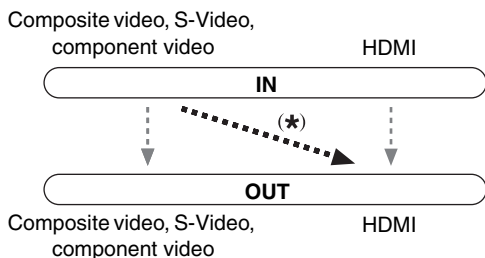

### Note

- See “Video Connection Formats” (→ [page 83](#)) for charts showing how the “**Monitor Out**” and “**Resolution**” settings affect the video signal flow through the AV receiver.

## Monitor Out

### ▶ **HDMI Main:**

Select this if your TV is connected to **HDMI OUT MAIN**.

### ▶ **HDMI Sub:**

Select this if your TV is connected to **HDMI OUT SUB**.

### ▶ **Both:**

Select this if your TVs are connected to **HDMI OUT MAIN** and **HDMI OUT SUB**. Video signals are output from both HDMI outputs at the resolution supported by both TVs.

### ▶ **Both(Main):**

Select this if your TVs are connected to **HDMI OUT MAIN** and **HDMI OUT SUB**. Video signals are output from both HDMI outputs but **HDMI OUT MAIN** will become a priority; depending on the resolution, video signals may not be output from **HDMI OUT SUB**.

### ▶ **Both(Sub):**

Select this if your TVs are connected to **HDMI OUT MAIN** and **HDMI OUT SUB**. Video signals are output from both HDMI outputs but **HDMI OUT SUB** will become a priority; depending on the resolution, video signals may not be output from **HDMI OUT MAIN**.

### Note

- When using the DeepColor function, if the “**Monitor Out**” setting is set to “**Both(Main)**” or “**Both(Sub)**”, the number of bits may be limited due to the capability of your TV connected to a priority output.

## Resolution

### ▶ **Through:**

Select this to pass video through the AV receiver at the same resolution and with no conversion.

### ▶ **Auto:**

Select this to have the AV receiver automatically convert video at resolutions supported by your TV.

### ▶ **480p (480p/576p), 720p, 1080i, 1080p:**

Select the desired output resolution.

### ▶ **1080p/24:**

Select this for 1080p output at 24 frames per second.

### ▶ **4K Upscaling:**

Select this for an output resolution four times that of 1080p, resulting in 3840 × 2160 pixels.

You can specify the output resolution for the **HDMI OUT MAIN** and have the AV receiver upconvert the picture resolution as necessary to match the resolution supported by your TV.

### Note

- Depending on the incoming video signal, the video playback may not be smooth or the vertical resolution may be lowered. In this case select anything other than “**1080p/24**”.
- If the “**Monitor Out**” setting is set to “**Both**”, this setting is fixed to “**Auto**”.
- When “**Monitor Out**” is set to either “**HDMI Sub**” or “**Both(Sub)**”, the “**Resolution**” setting is fixed to “**Through**”.

## HDMI Input

If you connect a video component to an HDMI input, you must assign that input to an input selector. For example, if you connect your Blu-ray Disc/DVD player to **HDMI IN 2**, you must assign “**HDMI2**” to the “**BD/DVD**” input selector.

If you’ve connected your TV to the AV receiver with an HDMI cable, composite video, S-video and component video sources can be upconverted\* and output by the HDMI output. You can set this for each input selector by selecting the “-----” option. See “Video Connection Formats” for more information on video signal flow and upconversion (→ [page 83](#)).

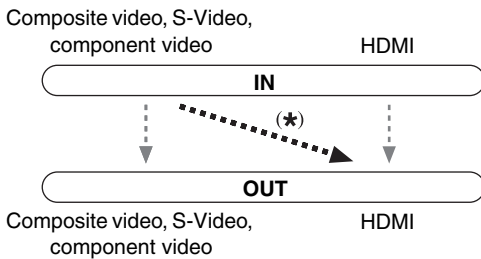

Here are the default assignments.

Input selector	Default assignment
BD/DVD	HDMI1
VCR/DVR	HDMI2
CBL/SAT	HDMI3
GAME	HDMI4
PC	HDMI5* <sup>1</sup>
AUX	FRONT (Fixed)
TV/CD	-----
PHONO	-----
PORT	-----

### ■ BD/DVD, VCR/DVR, CBL/SAT, GAME, PC, TV/CD, PHONO, PORT

#### ▶ HDMI1, HDMI2, HDMI3, HDMI4, HDMI5, HDMI6, HDMI7:

Select a corresponding HDMI input to which the video component has been connected.

#### ▶ -----:

Output composite video, S-Video, and component video sources from the HDMI output. The video output signal from the HDMI output is the one configured in “Component Video Input”.

\*<sup>1</sup> If you connect your personal computer to **PC IN** (Analog RGB), you must assign “-----” to the “**PC**” input selector.

Each HDMI input cannot be assigned to two input selectors or more. When **HDMI1 - HDMI7** have already been assigned, you must first set any unused input selectors to “-----” or you will be unable to assign **HDMI1 - HDMI7** to other input selectors.

### Note

- If no video component is connected to HDMI output (even if the HDMI input is assigned), the AV receiver selects the video source based on the setting of “**Component Video Input**”.
- When an **HDMI IN** is assigned to an input selector as explained here, the same **HDMI IN** will be set as a priority in the “**Digital Audio Input**” (→ [page 46](#)). In this case, if you want to use the coaxial or optical audio input, make the appropriate selection in the “**Audio Selector**” setting (→ [page 55](#)).
- The “**TUNER**” selector cannot be assigned and is fixed to the “-----” option.
- “**AUX**” is used only for input from the front panel.
- Do not assign an **HDMI IN** to the **TV/CD** selector while “**HDMI Control(RIHD)**” is set to “**On**” (→ [page 58](#)), otherwise appropriate CEC (Consumer Electronics Control) operation will not be guaranteed.
- If you assign “-----” to an input selector that is currently selected in “**HDMI Through**” (→ [page 58](#)), the “**HDMI Through**” setting will be automatically switched to “**Off**”.
- If you connect a component (such as UP-A1 Dock with docked iPod/iPhone) to the **UNIVERSAL PORT** jack, you cannot assign any input to the “**PORT**” selector.

## Component Video Input

If you connect a video component to a component video input, you must assign that input to an input selector. For example, if you connect your Blu-ray Disc/DVD player to **COMPONENT VIDEO IN 2**, you must assign “**IN2**” to the “**BD/DVD**” input selector.

Here are the default assignments.

Input selector	Default assignment
BD/DVD	IN1
VCR/DVR	-----
CBL/SAT	IN2
GAME	-----
PC	-----
TV/CD	-----
PHONO	-----
PORT	-----

### ■ BD/DVD, VCR/DVR, CBL/SAT, GAME, PC, TV/CD, PHONO, PORT

#### ▶ IN1, IN2:

Select a corresponding component video input to which the video component has been connected.

#### ▶ -----:

Output composite video and S-Video sources from the HDMI output.

### Note

- If you connect a component (such as UP-A1 Dock with docked iPod/iPhone) to the **UNIVERSAL PORT** jack, you cannot assign any input to the “**PORT**” selector.
- The “**AUX**” selector is fixed to the “-----” option.
- The “**TUNER**” selector cannot be assigned and is fixed to the “-----” option.

## Digital Audio Input

If you connect a component to a digital audio input, you must assign that input to an input selector. For example, if you connect your CD player to the **OPTICAL IN 1**, you must assign “**OPTICAL1**” to the “**TV/CD**” input selector.

Here are the default assignments.

Input selector	Default assignment
BD/DVD	COAXIAL1
VCR/DVR	COAXIAL2
CBL/SAT	COAXIAL3
GAME	OPTICAL1
PC	-----
TV/CD	OPTICAL2
PHONO	-----
PORT	-----

### ■ BD/DVD, VCR/DVR, CBL/SAT, GAME, PC, TV/CD, PHONO, PORT

#### ▶ COAXIAL1, COAXIAL2, COAXIAL3, OPTICAL1, OPTICAL2:

Select a corresponding digital audio input to which the component has been connected.

#### ▶ -----:

Select if the component is connected to an analog audio input.

#### Note

- When an **HDMI IN** is assigned to an input selector in “**HDMI Input**” (→ **page 45**), the same **HDMI IN** will be set as a priority in this assignment. In this case, if you want to use the coaxial or optical audio input, make the selection in the “**Audio Selector**” (→ **page 55**).
- Available sampling rates for PCM signals from a digital input (optical and coaxial) are 32/44.1/48/88.2/96 kHz/16, 20, 24 bit.
- If you connect a component (such as UP-A1 Dock with docked iPod/iPhone) to the **UNIVERSAL PORT** jack, you cannot assign any input to the “**PORT**” selector.
- The “**AUX**” selector is fixed to the “-----” option.
- The “**TUNER**” selector cannot be assigned and is fixed to the “-----” option.

## Analog Audio Input

Some DVD players output the LFE channel from their analog subwoofer output at 15 dB higher than normal. With this setting, you can change the AV receiver’s subwoofer sensitivity to match your DVD player.

### ■ Subwoofer Input Sensitivity

#### ▶ **0dB** to 15dB in 5 dB steps.

#### Note

- This setting only affects signals connected to the AV receiver’s multichannel input subwoofer jack.
- If you find that your subwoofer is too loud, try the 10 dB or 15 dB setting.

## Speaker Setup

### Main menu

### Speaker Setup

Some of the settings in this section are set automatically by Audyssey MultEQ® XT Room Correction and Speaker Setup function (→ **page 31**).

Here you can check the settings made by Audyssey MultEQ XT Room Correction and Speaker Setup function, or set them manually, which is useful if you change one of the connected speakers after using Audyssey MultEQ XT Room Correction and Speaker Setup function.

#### Note

- These settings are not available in either of the following cases:
  - a pair of headphones is connected.
  - the “**Audio TV Out**” setting is set to “**On**” (→ **page 59**).
  - “**HDMI Control(RIHD)**” is set to “**On**” (→ **page 58**) and you’re listening through your TV speakers.

## Speaker Settings

**If you change these settings, you must run Audyssey MultEQ XT Room Correction and Speaker Setup again (→ page 31).**

If the impedance of any speaker is 4 ohms or more but less than 6, set the minimum speaker impedance to 4 ohms.

If you bi-amp the front speakers, you must change the “**Speakers Type(Front)**” setting (→ **page 46**). For hookup information, see “**Bi-amping the Front Speakers**” (→ **page 14**).

#### Note

- When bi-amping is used, the AV receiver is able to drive up to 5.1 speakers in the main room.
- Before you change these settings, turn down the volume.

### ■ Speaker Impedance

#### ▶ **4ohms:**

Select if the impedance of any speaker is 4 ohms or more but less than 6.

#### ▶ **6ohms:**

Select if the impedances of all speakers are between 6 and 16 ohms.

### ■ Speakers Type(Front)

#### ▶ **Normal:**

Select this if you’ve connected your front speakers normally.

#### ▶ **Bi-Amp:**

Select this if you’ve bi-amped your front speakers.

### ■ Powered Zone 2

#### ▶ **No**

#### ▶ **Yes:**

Zone 2 speakers can be used. (Powered Zone 2 enabled.)

#### Note

- If the “**Speakers Type(Front)**” setting is set to “**Bi-Amp**”, Powered Zone 2 cannot be used.
- When the “**Powered Zone 2**” setting is set to “**Yes**”, the surround back, front wide and front high speakers cannot be used.

## Speaker Configuration

This setting is set automatically by Audyssey MultEQ® XT Room Correction and Speaker Setup function (→ **page 31**).

With these settings, you can specify which speakers are connected and a crossover frequency for each speaker. Specify “**Full Band**” for speakers that can output low frequency bass sounds adequately, for example, speakers with a good sized woofer. For smaller speakers, specify a crossover frequency. Sounds below the crossover frequency will be output by the subwoofer instead of the speaker. Refer to your speaker’s manuals to determine the optimum crossover frequencies. If you set up your speakers using Audyssey MultEQ XT Room Correction and Speaker Setup, please make sure manually that any THX speakers are set to “**80Hz(THX)**” crossover.

#### Note

- These settings are not available in either of the following cases:
  - a pair of headphones is connected.
  - the “**Audio TV Out**” setting is set to “**On**” (→ **page 59**).
  - “**HDMI Control(RIHD)**” is set to “**On**” (→ **page 58**) and you’re listening through your TV speakers.

### ■ Subwoofer

- ▶ **Yes**
- ▶ **No**

### ■ Front

- ▶ **Full Band**
- ▶ **40Hz to 80Hz(THX) to 100Hz, 120Hz, 150Hz, 200Hz**

#### Note

- If the “**Subwoofer**” setting is set to “**No**”, the “**Front**” setting is fixed to “**Full Band**”.

### ■ Center\*<sup>1</sup>, Surround\*<sup>1</sup>, Surround Back\*<sup>2</sup>\*<sup>3</sup>\*<sup>4</sup>

- ▶ **Full Band**
- ▶ **40Hz to 80Hz(THX) to 100Hz, 120Hz, 150Hz, 200Hz**
- ▶ **None**

### ■ Front Wide\*<sup>1</sup>\*<sup>2</sup>\*<sup>4</sup>, Front High\*<sup>1</sup>\*<sup>2</sup>\*<sup>4</sup>

- ▶ **Full Band**
- ▶ **40Hz to 80Hz(THX) to 100Hz, 120Hz, 150Hz, 200Hz**
- ▶ **None**

#### Note

- \*1 “**Full Band**” can be selected only when “**Full Band**” is selected in the “**Front**” setting.
- \*2 If the “**Surround**” setting is set to “**None**”, this setting cannot be selected.
- \*3 If the “**Surround**” setting is set to anything other than “**Full Band**”, “**Full Band**” cannot be selected here.
- \*4 If the “**Speakers Type(Front)**” setting is set to “**Bi-Amp**”, or the “**Powered Zone 2**” setting is set to “**Yes**”, this setting cannot be selected.

### ■ Surround Back Ch

- ▶ **1ch:**  
Select if only one surround back speaker L is connected.
- ▶ **2ch:**  
Select if two (left and right) surround back speakers are connected.

#### Note

- If the “**Surround Back**” Setting is set to “**None**”, this setting cannot be selected.

### ■ LPF of LFE (Low-Pass Filter for the LFE Channel)

- ▶ **80Hz, 90Hz, 100Hz, 120Hz**
- ▶ **Bypass:**

Low-Pass Filter is not applied.

With this setting, you can specify the cutoff frequency of the LFE channel’s low-pass filter (LPF), which can be used to filter out unwanted hum. The LPF only applies to sources that use the LFE channel.

#### Note

- If you’re using THX-certified speakers, select “**80Hz**”.

### ■ Double Bass

This setting is **NOT** set automatically by Audyssey MultEQ XT Room Correction and Speaker Setup function (→ **page 31**).

- ▶ **On**
- ▶ **Off(THX)**

Turn this setting on to boost bass output by feeding bass sounds from the front left, right, and center channels to the subwoofer.

#### Note

- This function can be set only if the “**Subwoofer**” setting is set to “**Yes**”, and the “**Front**” setting is set to “**Full Band**”.
- If you’re using THX-certified speakers, select “**Off(THX)**”.

### ■ Subwoofer Phase

- ▶ **0°**
- ▶ **180°:**

Moves the subwoofer phase.

#### Note

- If the “**Subwoofer**” setting is set to “**No**”, this setting cannot be selected (→ **page 47**).

## ■ Wireless Subwoofer

When an optional unit is connected to the **UNIVERSAL PORT** jack on the AV receiver, the speaker setting menu may appear on screen.

▶ **Yes:**

The audio is output from the speakers connected to the wireless unit.

▶ **No:**

The audio is not output from the speakers connected to the wireless unit.

When the wireless unit is connected to the **UNIVERSAL PORT** jack on the AV receiver, you can select if you wish to output the audio from the speakers connected to the wireless unit.

### Note

- If the “**Subwoofer**” setting is set to “**No**”, this setting cannot be selected (→ [page 47](#)).

## Speaker Distance

This setting is set automatically by Audyssey MultEQ® XT Room Correction and Speaker Setup function (→ [page 31](#)).

Here you can specify the distance from each speaker to the listening position so that the sound from each speaker arrives at the listener’s ears as the sound designer intended.

### ■ Unit

▶ **feet:**

Distances can be set in feet. Range: **0.5ft** to **30.0ft** in 0.5 foot steps.

▶ **meters:**

Distances can be set in meters. Range: **0.15m** to **9.00m** in 0.15 meter steps.

(The default setting varies from country to country.)

### ■ Left, Front Wide Left, Front High Left, Center, Front High Right, Front Wide Right, Right, Surround Right, Surround Back Right, Surround Back Left, Surround Left, Subwoofer

- ▶ Specify the distance from each speaker to your listening position.

### Note

- These settings are not available in either of the following cases:
  - a pair of headphones is connected.
  - the “**Audio TV Out**” setting is set to “**On**” (→ [page 59](#)).
  - “**HDMI Control(RIHD)**” is set to “**On**” (→ [page 58](#)) and you’re listening through your TV speakers.
- Speakers that you set to “**No**” or “**None**” in the “Speaker Configuration” cannot be selected (→ [page 47](#)).

## Level Calibration

This setting is set automatically by Audyssey MultEQ XT Room Correction and Speaker Setup function (→ [page 31](#)).

Here you can adjust the level of each speaker with the built-in test tone so that the volume of each speaker is the same at the listening position.

### ■ Left, Front Wide Left, Front High Left, Center\*<sup>1</sup>, Front High Right, Front Wide Right, Right, Surround Right, Surround Back Right, Surround Back Left, Surround Left

- ▶ **-12.0dB** to **0.0dB** to **+12.0dB** in 0.5 dB steps.

### ■ Subwoofer\*<sup>1</sup>

- ▶ **-15.0dB** to **0.0dB** to **+12.0dB** in 0.5 dB steps.

### Note

- These settings cannot be calibrated in either of the following cases:
  - a pair of headphones is connected.
  - the “**Audio TV Out**” setting is set to “**On**” (→ [page 59](#)).
  - “**HDMI Control(RIHD)**” is set to “**On**” (→ [page 58](#)) and you’re listening through your TV speakers.
  - the AV receiver is muted.
- Speakers that you set to “**No**” or “**None**” in the “Speaker Configuration” cannot be selected (→ [page 47](#)).
- The test tone is output at the standard level for THX, which is 0 dB (absolute volume setting 82). If you normally listen at volume settings below this, be careful because the test tone will be much louder.
- \*<sup>1</sup> For the center speaker and subwoofer, the level settings made by using the Home menu are saved in this menu (→ [page 40](#)).

### Tip

- If you’re using a handheld sound level meter, adjust the level of each speaker so that it reads 75 dB SPL at the listening position, measured with C-weighting and slow reading.



## Equalizer Settings

With the Equalizer settings, you can adjust the tone of speakers individually with a 7-band equalizer. The volume of each speaker can be set (→ [page 48](#)).

### ■ Equalizer

#### ▶ Manual:

You can adjust the equalizer for each speaker manually. Continue with the following procedure:

- 1** Press **▼** to select “Channel”, and then use **◀/▶** to select a speaker.
- 2** Use **▲/▼** to select a frequency, and then use the **◀/▶** to adjust the level at that frequency. The volume at each frequency can be adjusted from **-6dB** to **0dB** to **+6dB** in 1 dB steps.

#### Tip

- Low frequencies (e.g., 63Hz) affect bass sounds; high frequencies (e.g., 16000Hz) affect treble sounds.

- 3** Use **▲** to select “Channel”, and then use **◀/▶** to select another speaker.

Repeat steps 1 and 2 for each speaker.

You cannot select speakers that you set to “No” or “None” in the “Speaker Configuration” (→ [page 47](#)).

#### ▶ Off:

Tone off, response flat.

#### Note

- You can select: “63Hz”, “160Hz”, “400Hz”, “1000Hz”, “2500Hz”, “6300Hz”, or “16000Hz”. And for the subwoofer, “25Hz”, “40Hz”, “63Hz”, “100Hz”, or “160Hz”.
- When the Direct or Pure Audio listening mode is selected, the equalizer settings have no effect.
- If “Audyssey” is enabled, it prevails over this setting (→ [page 52](#)).

## THX Audio Setup

### ■ Surr Back Speaker Spacing

- ▶ <1ft (<0.3m)
- ▶ 1ft-4ft (0.3m-1.2m)
- ▶ >4ft (>1.2m)

You can specify the distance between your surround back speakers.

#### Note

- Cannot be set if:
  - “Surround Back Ch” is set to “1ch” (→ [page 47](#)).
  - “Speakers Type(Front)” is set to “Bi-Amp” (→ [page 46](#)).
  - “Surround Back” is set to “None” (→ [page 47](#)).
  - “Powered Zone 2” is set to “Yes” (→ [page 46](#)) and Zone 2 turned on (→ [page 64](#)).

### ■ THX Ultra2/Select2 Subwoofer

- ▶ No
- ▶ Yes

If you’re using a THX-certified subwoofer, set this setting to “Yes”.

#### Note

- If the “Subwoofer” setting is set to “No”, this setting cannot be selected (→ [page 47](#)).

### ■ BGC

- ▶ Off
- ▶ On

You can apply THX’s Boundary Gain Compensation (BGC) to compensate the perceived exaggeration of low frequencies for listeners sitting very close to a room boundary (i.e., wall).

#### Note

- This setting is only available if “THX Ultra2/Select2 Subwoofer” is set to “Yes”.
- If the “Subwoofer” setting is set to “No”, this setting cannot be selected (→ [page 47](#)).

### ■ Loudness Plus

- ▶ Off
- ▶ On

When the “Loudness Plus” is set to “On”, it is possible to enjoy even subtle nuances of audio expression at low volume.

This is only available when the THX listening mode is selected.

### ■ Preserve THX Settings

- ▶ Yes
- ▶ No

If this setting is set to “Yes”, Dynamic EQ and Dynamic Volume have no effect in THX listening mode.

#### Note

- This setting is fixed to “Yes” if “Loudness Plus” is set to “On”.

#### THX Loudness Plus

THX Loudness Plus is a new volume control technology featured in THX Ultra2 Plus™ and THX Select2 Plus™ Certified receivers. With THX Loudness Plus, home theater audiences can now experience the rich details in a surround mix at any volume level. A consequence of turning the volume below Reference Level is that certain sound elements can be lost or perceived differently by the listener. THX Loudness Plus compensates for the tonal and spatial shifts that occur when the volume is reduced by intelligently adjusting ambient surround channel levels and frequency response. This enables users experience the true impact of soundtracks regardless of the volume setting. THX Loudness Plus is automatically applied when listening in any THX listening mode. The new THX Cinema, THX Music, and THX Games modes are tailored to apply the proper THX Loudness Plus settings for each type of content.

With the Audio Adjust functions and settings, you can adjust the sound and listening modes as you like.

## Multiplex/Mono

### ■ Multiplex

#### Input Channel

▶ Main

▶ Sub

▶ Main/Sub

This setting determines which channel of a stereo multiplex source is output. Use it to select audio channels or languages with multiplex sources, multilingual TV broadcasts, and so on.

### ■ Mono

#### Input Channel

▶ Left + Right

▶ Left

▶ Right

This setting specifies the channel to be used for playing any 2-channel digital source such as Dolby Digital, or 2-channel analog/PCM source in the Mono listening mode.

#### Output Speaker

▶ Center:

Mono audio is output by the center speaker.

▶ Left / Right:

Mono audio is output by the front left and right speakers.

This setting determines which speakers output mono audio when the Mono listening mode is selected.

#### Note

- If the “Center” setting is set to “None” (→ page 47), this setting cannot be selected.

## Dolby

### ■ PL IIx Music (2ch Input)

These settings apply to only 2-channel stereo sources. If you’re not using any surround back speakers, these settings apply to Dolby Pro Logic II, not Dolby Pro Logic IIx.

#### Panorama

▶ On

▶ Off

With this setting, you can broaden the width of the front stereo image when using the Dolby Pro Logic IIx Music listening mode.

### Dimension

▶ -3 to 0 to +3

With this setting, you can move the sound field forward or backward when using the Dolby Pro Logic IIx Music listening mode. Higher settings move the sound field backward. Lower settings move it forward.

If the stereo image feels too wide, or there’s too much surround sound, move the sound field forward to improve the balance. Conversely, if the stereo image feels like it’s in mono, or there’s not enough surround sound, move it backward.

### Center Width

▶ 0 to 3 to 7

With this setting, you can adjust the width of the sound from the center speaker when using the Dolby Pro Logic IIx Music listening mode. Normally, if you’re using a center speaker, the center channel sound is output from only the center speaker. (If you’re not using a center speaker, the center channel sound will be distributed to the front left and right speakers to create a phantom center.) This setting controls the front left, right, and center mix, allowing you to adjust the weight of the center channel sound.

### ■ PL IIz Height Gain

▶ Low

▶ Mid

▶ High

The Height Gain Control in Dolby Pro Logic IIz enables the listener to select how much gain is applied to the front high speakers. There are three settings, “Low”, “Mid” and “High”, and the front high speakers are accentuated in that order. While “Mid” is the default listening setting, the listener may adjust the Height Gain Control to their personal preference.

#### Note

- If the “Front High” settings is set to “None” (→ page 47), this setting cannot be selected.

### ■ Dolby EX

▶ Auto:

If the source signal contains a Dolby EX flag, the Dolby EX or THX Surround EX listening mode is used.

▶ Manual:

You can select any available listening mode.

This setting determines how Dolby EX encoded signals are handled. This setting is unavailable if no surround back speakers are connected. This setting is effective with Dolby Digital, Dolby Digital Plus and Dolby TrueHD only.

#### Note

- If the “Surround Back” setting is set to “None” (→ page 47), this setting cannot be selected.
- If the “Front High” or “Front Wide” setting is enabled (→ page 47), this setting is fixed to “Manual”.

## ■ Dolby Volume

- ▶ **Off**
- ▶ **On**

Dolby Volume automatically adjusts the difference in volume levels which can occur between different contents or source components, freeing the user from having to make volume adjustments. Also, by adjusting the frequency balance according to the playback volume, it recreates the original source audio. Dolby Volume therefore provides comfortable listening, effectively controlling the volume level difference without unnatural changes in volume or sound quality to recreate the balance and nuance of the source audio.

### Note

- When the “**Dolby Volume**” setting is set to “**On**”, “**Dynamic EQ**” and “**Dynamic Volume**” will be set to “**Off**”.
- If you would like to use **Dolby Volume** in THX listening modes, set the “**Loudness Plus**” and “**Preserve THX Settings**” settings to “**Off**” and “**No**”, respectively.
- When “**Dolby Volume**” is set to “**On**”, the Late Night function cannot be set.

## ■ Volume Leveler

- ▶ **Off**
- ▶ **Low:**  
Low Compression Mode activated.
- ▶ **Mid:**  
Medium Compression Mode activated.
- ▶ **High:**  
High Compression Mode activated. This setting affects volume the most, causing all sounds to be of equal loudness.

“**Volume Leveler**” maintains the perceived loudness of all contents, coming from different channels or input sources.

### Note

- If the “**Dolby Volume**” setting is set to “**Off**”, this setting cannot be selected.

## ■ Half Mode

- ▶ **Off**
- ▶ **On**

The Half Mode parameter turns Dolby Volume Half Mode processing on and off.

In off mode, Dolby Volume applies a bass and treble attenuation to the audio when the system gain exceeds reference level. This enables a more perceptually flat listening experience as human ears are more sensitive to bass and treble at higher levels. Some listeners however, prefer to have more bass and treble performance at higher gain levels.

### Note

- If the “**Dolby Volume**” setting is set to “**Off**”, this setting cannot be selected.
- During Half Mode on playback, Dolby Volume does not apply a bass and treble attenuation when the system volume exceeds reference level thereby boosting perception of high and low frequencies.

## DTS

### ■ Neo:6 Music

#### Center Image

- ▶ 0 to 2 to 5

The DTS Neo:6 Music listening mode creates 6-channel surround sound from 2-channel stereo sources. With this setting, you can specify by how much the front left and right channel output is attenuated in order to create the center channel.

Changing the value from “0” to “5” will spread the sound of the center channel to left and right (outwards).

## Audyssey DSX™

### ■ Soundstage

- ▶ **-3dB** to **Reference** to **+3dB**

With this setting, you can adjust the sound stage when using Audyssey DSX.

### Note

- This listening mode can be selected only when all the following conditions are satisfied:
  - The center speaker is connected.
  - The front high and front wide speakers are connected.

## Theater-Dimensional

### ■ Listening Angle

- ▶ **Wide:**  
Select if the listening angle is 40 degrees.
- ▶ **Narrow:**  
Select if the listening angle is 20 degrees.

With this setting, you can optimize the Theater-Dimensional listening mode by specifying the angle of the front left and right speakers relative to the listening position. Ideally, the front left and right speakers should be equidistant from the listening position and at an angle close to one of the two available settings.

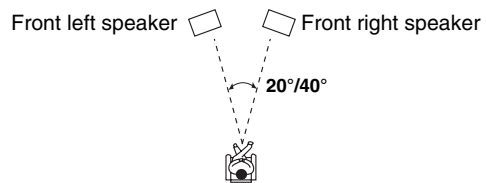

## LFE Level

### ■ Dolby Digital<sup>\*1</sup>, DTS<sup>\*2</sup>, Multich PCM, Dolby TrueHD, DTS-HD Master Audio, DSD<sup>\*3</sup>

- ▶ **-∞dB**, **-20dB**, **-10dB**, or **0dB**

With these settings, you can set the level of the LFE (Low Frequency Effects) channel individually for each input sources.

If you find that low-frequency effects are too loud when using one of these sources, change the setting to **-20 dB** or **-∞ dB**.

\*1 Dolby Digital and Dolby Digital Plus sources

\*2 DTS and DTS-HD High Resolution sources

\*3 DSD (Super Audio CD) sources

## Source Setup

Items can be set individually for each input selector.

### Preparation

Press the input selector buttons to select an input source.

Main menu

Source Setup

## Audyssey

The tone for each speaker is set automatically by Audyssey MultEQ® XT Room Correction and Speaker Setup. To enable the following settings, you must first perform the Room Correction and Speaker Setup (→ [page 31](#)).

### Audyssey

#### ▶ **Off**

#### ▶ **Movie:**

Select this setting for movie material.  
The **Audyssey** indicator lights.

#### ▶ **Music:**

Select this setting for music material.  
The **Audyssey** indicator lights.

### Note

- If the “**Audyssey**” setting is set to “**Off**”, the “**Equalizer**” settings are applied (→ [page 49](#)).
- When “**Audyssey Quick Start**” has been used for measurement, the “**Audyssey**” setting cannot be selected.
- Audyssey equalizing does not work with DSD sources.
- These technologies cannot be used when:
  - a pair of headphones is connected, or
  - either Pure Audio or Direct listening mode is selected.

### Dynamic EQ

#### ▶ **Off**

#### ▶ **On:**

Audyssey Dynamic EQ® becomes active.  
The **Dynamic EQ** indicator lights.

With Audyssey Dynamic EQ, you can enjoy great sound even when listening at low volume levels.

Audyssey Dynamic EQ solves the problem of deteriorating sound quality as volume is decreased by taking into account human perception and room acoustics. It does so by selecting the correct frequency response and surround volume levels moment-by-moment so that the content sounds the way it was created at any volume level — not just at reference level.

### Note

- These technologies cannot be used when:
  - a pair of headphones is connected, or
  - either Pure Audio or Direct listening mode is selected.

### Reference Level

#### Audyssey Dynamic EQ Reference Level Offset

##### ▶ **0dB:**

This should be used when listening to movies.

##### ▶ **5dB:**

Select this setting for content that has a very wide dynamic range, such as classical music.

##### ▶ **10dB:**

Select this setting for jazz or other music that has a wider dynamic range. This setting should also be selected for TV content as that is usually mixed at 10 dB below film reference.

##### ▶ **15dB:**

Select this setting for pop/rock music or other program material that is mixed at very high listening levels and has a compressed dynamic range.

Movies are mixed in rooms calibrated for film reference. To achieve the same reference level in a home theater system each speaker level must be adjusted so that –30 dBFS band-limited (500 Hz to 2000 Hz) pink noise produces 75 dB sound pressure level at the listening position. A home theater system automatically calibrated by Audyssey MultEQ XT will play at reference level when the master volume control is set to the 0 dB position. At that level you can hear the mix as the mixers heard it.

Audyssey Dynamic EQ is referenced to the standard film mix level. It makes adjustments to maintain the reference response and surround envelopment when the volume is turned down from 0 dB. However, film reference level is not always used in music or other non-film content. Audyssey Dynamic EQ Reference Level Offset provides three offsets from the film level reference (5 dB, 10 dB, and 15 dB) that can be selected when the mix level of the content is not within the standard.

### Note

- If “**Dynamic EQ**” setting is set to “**Off**”, these technologies cannot be used.

### Dynamic Volume

#### ▶ **Off**

#### ▶ **Light:**

Activates Light Compression Mode.

#### ▶ **Medium:**

Activates Medium Compression Mode.

#### ▶ **Heavy:**

Activates Heavy Compression Mode. This setting affects volume the most. It quiets the loud parts, such as explosions, and boosts the quiet parts so they can be heard.

## Note

- If you want to use Audyssey Dynamic EQ® or Audyssey Dynamic Volume® with THX listening modes, set the “**Loudness Plus**” setting to “**Off**” and set “**Preserve THX Settings**” to “**No**” (→ **page 49**).
- If you make Dynamic Volume active, “**Dynamic EQ**” is set to “**On**”. The **Dynamic Vol** indicator will light.
- When “**Dynamic EQ**” is set to “**Off**”, “**Dynamic Volume**” is automatically switched to “**Off**”.
- These technologies cannot be used when:
  - a pair of headphones is connected, or
  - either Pure Audio or Direct listening mode is selected.

### About Audyssey Dynamic EQ®

Audyssey Dynamic EQ solves the problem of deteriorating sound quality as volume is decreased by taking into account human perception and room acoustics. Dynamic EQ selects the correct frequency response and surround levels moment-by-moment at any user-selected volume setting. The result is bass response, tonal balance, and surround impression that remain constant despite changes in volume. Dynamic EQ combines information from incoming source levels with actual output sound levels in the room, a prerequisite for delivering a loudness correction solution. Audyssey Dynamic EQ works well by itself. However, if Audyssey MultEQ® XT is on, the two technologies work in tandem to provide well-balanced sound for every listener at any volume level.

### About Audyssey Dynamic Volume®

Audyssey Dynamic Volume solves the problem of large variations in volume level between television programs, commercials, and between the soft and loud passages of movies. Dynamic Volume looks at the preferred volume setting by the user and then monitors how the volume of program material is being perceived by listeners in real time to decide whether an adjustment is needed. Whenever necessary, Dynamic Volume makes the necessary rapid or gradual adjustments to maintain the desired playback volume level while optimizing the dynamic range. Audyssey Dynamic Volume works fine by itself, but can also be used with Audyssey Dynamic EQ. When both are on, Audyssey Dynamic EQ adjusts the perceived bass response, tonal balance, surround impression, and dialog clarity whether watching movies, flipping between television channels, or changing from stereo to surround sound content, when Dynamic Volume adjusts the volume.

## IntelliVolume

### ■ IntelliVolume

▶ **-12dB** to **0dB** to **+12dB** in 1 dB steps.

With IntelliVolume, you can set the input level for each input selector individually. This is useful if one of your source components is louder or quieter than the others.

Use ◀/▶ to set the level.

If a component is noticeably louder than the others, use ◀ to reduce its input level. If it's noticeably quieter, use ▶ to increase its input level.

## A/V Sync

### ■ A/V Sync

▶ **0msec** to **800msec** in 5 msec steps.

When using progressive scanning on your Blu-ray Disc/DVD player, you may find that the picture and sound are out of sync. With this setting, you can correct this by delaying the audio signals.

To view the TV picture while setting the delay, press **ENTER**.

To return to the previous screen, press **RETURN**.

The range of values you can adjust will depend on whether your TV or display supports HDMI Lip Sync and if the “**Lip Sync**” setting is set to “**On**” or not (→ **page 59**).

### Note

- A/V Sync is disabled when the Pure Audio listening mode is selected, or when the Direct listening mode is used with an analog input source.
- This setting cannot be used with the **NET** input selector.

## Name Edit

You can enter a custom name for each individual input selector and radio preset for easy identification. When entered, the custom name will appear on the display.

The custom name is edited using the character input screen.

### ■ Name

- 1 Use ▲/▼/◀/▶ to select a character, and then press ENTER.**  
Repeat this step to enter up to 10 characters.
- 2 To store a name when you're done, be sure to select “OK” by using ▲/▼/◀/▶, and then press ENTER.**

## Name input area

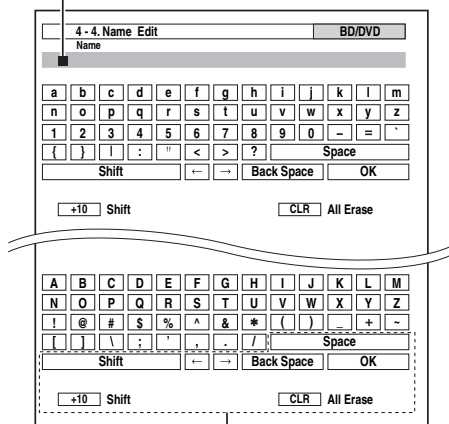

### Space:

Enter a space character.

### Shift\*1:

Toggles between lower and upper case characters.

← (Left)/ → (Right):

Moves the cursor left or right in the Name input area.

### Back Space\*2:

Moves the cursor backward and deletes one character.

### OK:

Confirms your entry.

### Tip

- \*1 This can also be performed by using **+10** on the remote controller.
- \*2 Press **CLR** on the remote controller to delete all the characters you have input.

## To correct a character:

- 1** Use **▲/▼/◀/▶** to select “←”(Left) or “→”(Right), and then press **ENTER**.
- 2** Press **ENTER** several times to highlight the incorrect character (For each pressure, the cursor is moved on the next character).
- 3** Use **▲/▼/◀/▶** to select the correct character, and then press **ENTER**.

### Tip

- To name a radio preset, use **TUNER** to select AM or FM, and then select the preset (→ **page 29**).
- To restore a custom name to its default, erase the custom name by entering an empty white space for each letter.

### Note

- This setting cannot be used for the **NET** and **USB** input selector.

## Picture Adjust

Using **Picture Adjust**, you can adjust the picture quality and reduce any noise appearing on the screen.

To view the TV picture while setting, press **ENTER**. To return to the previous screen, press **RETURN**.

### ■ Wide Mode\*1\*2

This setting determines the aspect ratio.

#### ▶ 4:3:

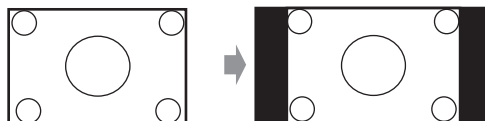

#### ▶ Full:

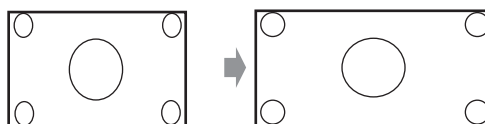

#### ▶ Zoom:

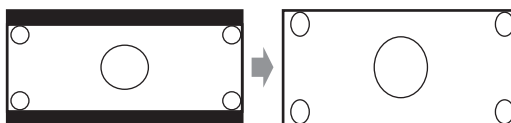

#### ▶ Wide Zoom:

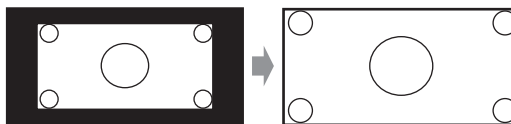

#### ▶ Auto:

According to the input signals and monitor output setting, the AV receiver automatically selects the “4 : 3”, “Full”, “Zoom” or “Wide Zoom” mode. See “Monitor Out” for details on the monitor output setting (→ **page 44**).

### ■ Picture Mode\*1

#### ▶ Custom:

All settings can be performed manually.

#### ▶ Cinema:

Select when the picture source is a movie or alike.

#### ▶ Game:

Select when the video source is a game console.

#### ▶ Through:

Does not adjust picture quality (changes resolution).

#### ▶ Direct:

Does not adjust picture quality (does not change resolution).

When video is output from **HDMI** output(s), it is processed the same as “Through”.

With “**Picture Mode**”, you can change the following settings to be suitable for the movie or game screen by one operation; “**Game Mode**”, “**Film Mode**”, “**Edge Enhancement**”, “**Noise Reduction**”, “**Brightness**”, “**Contrast**”, “**Hue**”, “**Saturation**” or “**Color Temperature**”.

## ■ Game Mode\*3\*4\*5

- ▶ Off
- ▶ On

If video signal delay occurs during playback on a video component (i.e., game console), select the corresponding input source and set the “**Game Mode**” setting to “**On**”. The delay will decrease but in return the picture quality will become poor.

## ■ Film Mode\*3\*5\*6

- ▶ **Video:**  
“**Film Mode**” detection is not applied and the input signal is handled as a video source.
- ▶ **Auto:**  
Detects whether the input signal is a video or a movie. If it is a movie, the appropriate conversion is applied.

The AV receiver will adjust to the picture source, automatically converting it to the appropriate progressive signal and reproducing the natural quality of the original picture.

## ■ Edge Enhancement\*3\*5\*6\*7

- ▶ Off
- ▶ Low
- ▶ Mid
- ▶ High

With Edge Enhancement, you can make the picture appear sharper.

## ■ Noise Reduction\*3\*5\*6\*7

- ▶ Off
- ▶ Low
- ▶ Mid
- ▶ High

With this setting, you can reduce noise appearing on the screen. Select the desired level.

## ■ Brightness\*1\*3\*5

- ▶ -50 to 0 to +50

With this setting you can adjust the picture brightness. “**-50**” is the darkest. “**+50**” is the brightest.

## ■ Contrast\*1\*3\*5

- ▶ -50 to 0 to +50

With this setting you can adjust contrast. “**-50**” is the least. “**+50**” is the greatest.

## ■ Hue\*1\*3\*5

- ▶ -50 to 0 to +50

With this setting you can adjust the red/green balance. “**-50**” is the strongest green. “**+50**” is the strongest red.

## ■ Saturation\*1\*3\*5

- ▶ -50 to 0 to +50

With this setting you can adjust saturation. “**-50**” is the weakest color. “**+50**” is the strongest color.

## ■ Color Temperature\*3\*5

- ▶ Warm
- ▶ Normal
- ▶ Cool

With this setting you can adjust the color temperature.

## Note

- “**Picture Adjust**” cannot be used with the **NET** input selector.
- \*1 This procedure can also be performed on the remote controller by using the Home menu (→ **page 40**).
- \*2 When a 3D video source is input, “**Wide Mode**” is fixed to “**Full**”.
- \*3 When the “**Picture Mode**” setting is set to anything other than “**Custom**”, this setting cannot be used.
- \*4 If the “**Resolution**” setting is set to “**4K Upscaling**” (→ **page 44**), this setting is fixed to “**Off**”.
- \*5 Press **CLR** if you want to reset to the default value.
- \*6 If you are using the analog RGB input, this setting is not available.
- \*7 If the “**Game Mode**” setting is set to “**On**”, this setting is fixed to “**Off**”.

## Audio Selector

You can set priorities of audio output when there are both digital and analog inputs.

### ■ Audio Selector

#### ▶ **ARC:**

The audio signal from your TV tuner can be sent to the **HDMI OUT MAIN** of the AV receiver.\*1  
With this selection, the TV’s audio can be automatically selected as a priority among other assignments.

#### ▶ **HDMI:**

This can be selected when **HDMI IN** has been assigned as an input source. If both HDMI (**HDMI IN**) and digital audio inputs (**COAXIAL IN** or **OPTICAL IN**) have been assigned, HDMI input is automatically selected as a priority.

#### ▶ **COAXIAL:**

This can be selected when **COAXIAL IN** has been assigned as an input source. If both coaxial and HDMI inputs have been assigned, coaxial input is automatically selected as a priority.

#### ▶ **OPTICAL:**

This can be selected when **OPTICAL IN** has been assigned as an input source. If both optical and HDMI inputs have been assigned, optical input is automatically selected as a priority.

#### ▶ **Multich:**

The AV receiver always outputs analog signals from multichannel analog input.

#### ▶ **Analog:**

The AV receiver always outputs analog signals.

## Note

- The setting is stored individually for each input selector.
- This setting can be made only for the input source that is assigned as **HDMI IN**, **COAXIAL IN**, or **OPTICAL IN**.
- The “**Audio Selector**” settings cannot be used with the **NET**, **USB** and **PORT** (with connected component) input selectors.
- “**Multich**” can be selected only when the selector is set to “**BD/DVD**”.
- \*1 You can select “**ARC**” if you select the **TV/CD** input selector. But you cannot if you’ve selected “**Off**” in the “**Audio Return Channel**” setting (→ **page 59**).

## ■ Fixed Mode

### ▶ **Off:**

The format is detected automatically. If no digital input signal is present, the corresponding analog input is used instead.

### ▶ **PCM:**

Only 2-channel PCM format input signals will be heard. If the input signal is not PCM, the **PCM** indicator will flash and noise may also be produced.

### ▶ **DTS:**

Only DTS (but not DTS-HD) format input signals will be heard. If the input signal is not DTS, the **DTS** indicator will flash and there will be no sound.

When “**HDMI**”, “**COAXIAL**” or “**OPTICAL**” is selected in the “**Audio Selector**” setting, you can then specify the signal type in “**Fixed Mode**”.

Normally, the AV receiver detects the signal format automatically. However, if you experience either of the following issues when playing PCM or DTS material, you can manually set the signal format to PCM or DTS.

- If the beginnings of tracks from a PCM source are cut off, try setting the format to PCM.
- If noise is produced when fast forwarding or reversing a DTS CD, try setting the format to DTS.

### Note

- The setting is stored individually for each input selector.
- The setting will be reset to “**Off**” when you change the setting in “**Audio Selector**” (→ page 55).

## Charge Mode

### ■ Charge Mode

#### ▶ **Auto:**

Power feeding is interrupted when your iPod/iPhone is fully charged.

#### ▶ **On:**

Power feeding continues even if your iPod/iPhone is fully charged.

#### ▶ **Off:**

Your iPod/iPhone is not charged.

You can specify how the power is fed to your iPod/iPhone when the AV receiver is in standby mode.

### Note

- This setting cannot be selected when:
  - the UP-A1 Dock with docked iPod/iPhone is not connected to the AV receiver, or
  - the docked iPod/iPhone model is not supported.
- When the “**Charge Mode**” setting is set to “**On**”, or to “**Auto**” with your iPod/iPhone recharging, the **SLEEP** indicator is dimly lit in standby mode. In such conditions, the power consumption of the AV receiver slightly increases. With “**Auto**”, when the iPod/iPhone becomes fully charged, the **SLEEP** indicator goes off and the power consumption in standby mode is reduced.

## Listening Mode Preset

You can assign a default listening mode to each input source that will be selected automatically when you select each input source. For example, you can set the default listening mode to be used with Dolby Digital input signals. You can select other listening modes during playback, but the mode specified here will be resumed once the AV receiver has been set to standby.

### Main menu

### Listening Mode Preset

- 1 Use **▲/▼** to select the input source that you want to set, and then press **ENTER**.

The following menu appears.

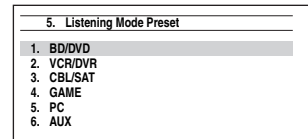

- 2 Use **▲/▼** to select the signal format that you want to set, and then use **◀/▶** to select a listening mode.

Only listening modes that can be used with each input signal format can be selected (→ pages 35 to 39).

The “**Last Valid**” option means that the listening mode selected last will be used.

### Note

- If you connect an input component (such as UP-A1 series Dock that seated iPod) to the **UNIVERSAL PORT** jack, the only listening modes you can assign to the “**PORT**” selector are specific to analog sound.
- For the **TUNER** input selector, only “**Analog**” will be available.
- For the **NET** or **USB** input selector, only “**Digital**” will be available.

### ■ Analog / PCM / Digital

With this setting, you can specify the listening mode used when an analog (CD, TV, LD, VHS, MD, turntable, radio, cassette, cable, satellite, etc.) or PCM digital (CD, DVD, etc.) audio signal is played.

### Note

- For the **AUX** input selector, only “**PCM**” is available.

### ■ Mono/Multiplex Source

With this setting, you can specify the listening mode used when a mono digital audio signal is played (DVD, etc.).

### ■ 2ch Source

With this setting, you can specify the listening mode used when 2-channel (2/0) stereo digital sources, such as Dolby Digital or DTS, are played.

### ■ Dolby D/Dolby D Plus/TrueHD

With this setting, you can specify the listening mode used when Dolby Digital or Dolby Digital Plus format digital audio signals are played (DVD, etc.). Specifies the default listening mode for Dolby TrueHD sources, such as Blu-ray or HD DVD (input via HDMI).



## ■ DTS/DTS-ES/DTS-HD

With this setting, you can specify the listening mode used when DTS or DTS-HD High Resolution format digital audio signals are played (DVD, LD, CD, etc.). Specifies the default listening mode for DTS-HD Master Audio sources, such as Blu-ray or HD DVD (input via HDMI).

## ■ Other Multich Source

Specifies the default listening mode for multichannel PCM sources from **HDMI IN** such as DVD-Audio, and DSD multichannel sources such as Super Audio CD.

## Miscellaneous

Main menu

Miscellaneous

## Volume Setup

### ■ Volume Display

#### ▶ Absolute:

Displayed range is **Min, 0.5 to 99.5, Max.**

#### ▶ Relative (THX):

Displayed range is **-∞dB, -81.5dB to +18.0dB.**

With this setting, you can choose how the volume level is displayed.

The absolute value 82 is equivalent to the relative value 0 dB.

### Note

- If the absolute value is set to 82, “**82Ref**” will appear on the display and the THX indicator will flash.

### ■ Muting Level

▶ **-∞dB** (fully muted), **-50dB to -10dB** in 10 dB steps.

This setting determines how much the output is muted when the muting function is used (→ **page 41**).

### ■ Maximum Volume

▶ Off, **50 to 99** (Absolute display)

▶ Off, **-32dB to +17dB** (Relative display)

With this setting, you can limit the maximum volume.

To disable this setting, select “**Off**”.

### ■ Power On Volume

▶ Last, **Min, 1 to 99** or **Max** (Absolute display)

▶ Last, **-∞dB, -81dB to +18dB** (Relative display)

With this preference, you can specify the volume setting to be used each time the AV receiver is turned on.

To use the same volume level that was used when the AV receiver was turned off, select “**Last**”.

The “**Power On Volume**” cannot be set higher than the “**Maximum Volume**” setting.

### ■ Headphone Level

▶ **-12dB to 0dB to +12dB**

With this preference, you can specify the headphone volume relative to the main volume. This is useful if there's a volume difference between your speakers and your headphones.

## OSD Setup

### ■ On Screen Display

#### ▶ On

#### ▶ Off

This preference determines whether operation details are displayed on-screen when an AV receiver function is adjusted.

Even when “**On**” is selected, operation details may not be output if the input source is connected to an **HDMI IN**.

### ■ Language

(North American and Taiwan models)

▶ English, Deutsch, Français, Español, Italiano, Nederlands, Svenska

(European, Australian and Asian models)

▶ English, Deutsch, Français, Español, Italiano, Nederlands, Svenska, 中文

This setting determines the language used for the on-screen setup menus.

## Hardware Setup

Main menu

Hardware Setup

## Remote ID

### ■ Remote ID

▶ **1, 2, or 3**

When several Onkyo components are used in the same room, their remote ID codes may overlap. To differentiate the AV receiver from the other components, you can change its remote ID from “**1**”, to “**2**” or “**3**”.

### Note

- If you do change the AV receiver's remote ID, be sure to change the remote controller to the same ID (see below), otherwise, you won't be able to control it with the remote controller.

### Changing the remote controller's ID

- 1** While holding down **RECEIVER**, press and hold down **SETUP** until **RECEIVER** lights (about 3 seconds) (→ **page 43**).
- 2** Use the number buttons to enter ID **1, 2, or 3**. **RECEIVER** flashes twice.

## Tuner

For AM/FM tuning to work properly, you must specify the AM/FM frequency step used in your area. Note that when this setting is changed, all radio presets will be deleted.

### ■ AM/FM Frequency Step (North American and Taiwan models)

#### ▶ **10kHz/200kHz:**

#### ▶ **9kHz/50kHz:**

Select the frequency step according to your area.

### ■ AM Frequency Step (European, Australian and Asian models)

#### ▶ **10kHz:**

#### ▶ **9kHz:**

Select the frequency step according to your area.

## HDMI

### ■ HDMI Control(RIHD)

#### ▶ **Off**

#### ▶ **On**

Turn this setting on to allow **RIHD**-compatible components connected via HDMI to be controlled by the AV receiver (→ **page 86**).

#### Note

- When the setting is set to “**On**” and the menu is closed, the names of connected **RIHD**-compatible components and “**RIHD On**” are displayed on the AV receiver. “**Search...**” → “**(name)**” → “**RIHD On**”  
When the AV receiver cannot receive the name of the component, it is displayed as “**Player\***” or “**Recorder\***”, etc (“\*” shows up and indicates the number of components, when two or more are received).
- When an **RIHD**-compatible component is connected to the AV receiver via an HDMI cable, the name of the connected component is displayed on the AV receiver display. For example, while you are watching TV broadcasting, if you operate a Blu-ray Disc/DVD player (being powered on) with the remote control of the AV receiver, the name of the Blu-ray Disc/DVD player will be displayed on the AV receiver.
- Set it to “**Off**” when a connected piece of equipment is not compatible or it is unclear whether the equipment is compatible or not.
- If operation is not normal when set to “**On**”, change the setting to “**Off**”.
- Refer to the connected component’s instruction manual for details.
- When “**HDMI Control(RIHD)**” setting is set to “**On**”, the power consumption on standby mode slightly increases. (Depending on the TV status, the AV receiver will enter standby mode as usual.)
- The **RIHD** control does not support **HDMI OUT SUB**. Use **HDMI OUT MAIN** instead.
- When the source equipment is connected with the **RI** connection, it may malfunction if “**HDMI Control(RIHD)**” is set to “**On**”.

### ■ HDMI Through

#### ▶ **Off**

#### ▶ **Auto:**

Detects the signal and automatically selects the input source.

#### ▶ **BD/DVD, VCR/DVR, CBL/SAT, GAME, PC, AUX, TV/CD, PHONO, PORT:**

Selects the input source for which the HDMI Through function is enabled.

#### ▶ **Last:**

The HDMI Through function is activated on the input source selected at the time of setting the AV receiver to standby mode.

When enabling the HDMI Through function, regardless of whether the AV receiver is on or in standby, both audio and video streams from an HDMI input will be output to the TV or other components via HDMI connection. The **HDMI THRU** and **HDMI** indicators light when enabled (**HDMI** is dimly-lit).

This setting is set to “**Auto**” automatically when the above “**HDMI Control(RIHD)**” is set to “**On**”.

#### Note

- Only the input source assigned to the **HDMI IN** via “**HDMI Input**” is enabled (→ **page 44**).
- The power consumption during standby mode will increase during the HDMI Through function: however in the following cases, the power consumption can be saved:
  - The TV is in standby mode.
  - You are watching a TV program.
- Refer to the connected component’s instruction manual for details.
- Depending on the connected component, the correct input source may not be selected with the setting set to “**Auto**”.
- This setting is set to “**Off**” automatically when the “**HDMI Control(RIHD)**” setting is set to “**Off**”.

## ■ Audio TV Out

- ▶ **Off**
- ▶ **On**

This preference determines whether the incoming audio signal is output from the HDMI output. You may want to turn this preference on if your TV is connected to the HDMI output and you want to listen to the audio from a connected component through your TV's speakers.

Normally, this should be set to "**Off**".

### Note

- If "**On**" is selected and the audio can be output from the TV, the AV receiver will output no sound through its speakers. In this case, "**TV Speaker**" appears on the display by pressing **DISPLAY**.
- When "**HDMI Control(RIHD)**" is set to "**On**", this setting is fixed to "**Auto**".
- With some TVs and input signals, no sound may be output even when this setting is set to "**On**".
- When "**Audio TV Out**" or "**HDMI Control(RIHD)**" is set to "**On**" and you're listening through your TV's speakers (→ **page 17**), turning up the AV receiver's volume control will make the sound be output from the AV receiver's front left and right speakers. To stop the AV receiver's speakers producing sound, change the settings, change your TV's settings, or turn down the AV receiver's volume.
- Listening mode cannot be changed when this setting is set to "**On**" and the input source is not HDMI.
- If the "**Monitor Out**" setting is set to "**Both(Main)**" or "**Both(Sub)**" (→ **page 44**) and if your TV connected to a priority output cannot output the audio, the sound will be heard from AV receiver's speakers.

## ■ Audio Return Channel

- ▶ **Off**
- ▶ **Auto**:

The audio signal from your TV tuner can be sent to the **HDMI OUT MAIN** of the AV receiver.

The audio return channel (ARC) function allows an ARC capable TV to send the audio stream to the **HDMI OUT MAIN** of the AV receiver. To use this function, you must select the **TV/CD** input selector and your TV must be ARC capable.

### Note

- If you set "**Audio Return Channel**" to "**Auto**", the "**Audio Selector**" settings of the **TV/CD** input selector will be automatically switched to "**ARC**" (→ **page 55**).
- The "**Audio Return Channel**" setting can be set only when the "**HDMI Control(RIHD)**" setting is set to "**On**".
- This setting is set to "**Auto**" automatically when the "**HDMI Control(RIHD)**" is set to "**On**" for the first time.

## ■ Lip Sync

- ▶ **Off**
- ▶ **On**

This function allows the AV receiver to automatically correct any delay between the video and the audio, based on the data from the connected monitor.

### Note

- This function works only if your HDMI-compatible TV supports HDMI Lip Sync.
- If the "**Monitor Out**" setting is set to "**HDMI Main**", "**Both(Main)**" or "**Both**" (→ **page 44**), the delay will be corrected in accordance with the monitor connected to **HDMI OUT MAIN**. On the other hand, if "**HDMI Sub**" or "**Both(Sub)**" is selected, the delay will be corrected in accordance with the monitor connected to **HDMI OUT SUB**.

After changing the settings of the "**HDMI Control(RIHD)**", "**HDMI Through**" or "**Audio Return Channel**" turn off the power on all connected pieces of equipment and then turn them on again. Refer to the user's manuals for all connected pieces of equipment.

## Auto Standby

### ■ Auto Standby

- ▶ **Off**
- ▶ **On**

When "**Auto Standby**" is set to "**On**", the AV receiver will automatically enter standby mode if there is no operation for 30 minutes with no audio and no video signal input.

"**Auto Standby**" will appear on the display and OSD 30 seconds before the Auto Standby comes on.

Default setting: **On (European, Australian and Asian models)**, **Off (North American and Taiwan models)**

### Note

- Set to "**On**", the Auto Standby function may activate itself during playback with some sources.
- The Auto Standby function does not work when Zone 2 is on.

## Network

---

After modifying the network settings, you must confirm the changes by executing “**Save**”.

This section explains how to configure the AV receiver’s network settings manually.

If your router’s DHCP server is enabled, you don’t need to change any of these settings, as the AV receiver is set to use DHCP to configure itself automatically by default (i.e., DHCP is set to “**Enable**”). If, however, your router’s DHCP server is disabled (you’re for example using static IP), you’ll need to configure these settings yourself, in which case, a knowledge of Ethernet networking is essential.

### What’s DHCP?

DHCP (Dynamic Host Configuration Protocol) is used by routers, computers, the AV receiver, and other devices to automatically configure themselves on a network.

### What’s DNS?

The DNS (Domain Name System) translates domain names into IP addresses. For example, when you enter a domain name such as *www.onkyousa.com* in your Web browser, before accessing the site, your browser uses DNS to translate this into an IP address, in this case 63.148.251.142.

### ■ MAC Address

This is the AV receiver’s MAC (Media Access Control) address. This address cannot be changed.

### ■ DHCP

- ▶ **Enable**
- ▶ **Disable**

This setting determines whether or not the AV receiver uses DHCP to automatically configure its IP Address, Subnet Mask, Gateway, and DNS Server settings.

#### Note

- If you select “**Disable**”, you must configure the “**IP Address**”, “**Subnet Mask**”, “**Gateway**”, and “**DNS Server**” settings yourself.

### ■ IP Address

- ▶ Class A:  
“**10.0.0.0**” to “**10.255.255.255**”
- ▶ Class B:  
“**172.16.0.0**” to “**172.31.255.255**”
- ▶ Class C:  
“**192.168.0.0**” to “**192.168.255.255**”

Enter a static IP address provided by your ISP. Most routers use Class C IP addresses.

### ■ Subnet Mask

Enter the subnet mask address provided by your ISP (typically **255.255.255.0**).

### ■ Gateway

Enter the gateway address provided by your ISP.

### ■ DNS Server

Enter the DNS server address provided by your ISP.

### ■ Proxy URL

To use a Web proxy, enter its URL here.

### ■ Proxy Port

If you’re using a Web proxy, enter a proxy port number here.

### ■ Network Control

- ▶ **Enable**
- ▶ **Disable**

This setting enables or disables control over the network.

#### Note

- When set to “**Enable**”, the **NET** indicator is dimly-lit and the power consumption slightly increases in standby mode.

### ■ Control Port

- ▶ “**49152**” to “**65535**”

This is the network port used for control over the network.

#### Note

- When the “**Network Control**” setting is set to “**Disable**”, this setting is cannot be selected.

## Firmware Update

---

See “Firmware Update” for the update procedure (→ **page 80**).

#### Note

- Perform the firmware update only when such an announcement is posted on the Onkyo web site. Visit the Onkyo web site for the latest information.
- It takes maximum 60 minutes to complete the firmware update.

### ■ Version

Displays the current version of the firmware.

### ■ Receiver

- ▶ **via NET:**  
Performs the firmware update via Internet. Check the network connection before updating.
- ▶ **via USB:**  
Performs the firmware update from a USB device.

These settings allow you to update the AV receiver’s firmware. Do not shutdown the power of the AV receiver while updating.

### ■ Universal Port

- ▶ **via NET:**  
Performs the firmware update via Internet. Check the network connection before updating.
- ▶ **via USB:**  
Performs the firmware update from a USB device.

These settings allow you to update Onkyo dock’s firmware. Do not shutdown the power of the AV receiver while updating.

#### Note

- This update shall not be performed when no dock is connected to the **UNIVERSAL PORT** jack.

## Remote Controller Setup

Main menu

Remote Controller Setup

### Remote Mode Setup

See “Looking up for Remote Control Code” (→ page 69).

## Lock Setup

With this preference, you can protect your settings by locking the setup menus.

Main menu

Lock Setup

#### ■ Setup

▶ **Locked**

▶ **Unlocked**

When “**Locked**” is selected, the setup menus will be locked and you cannot change any setting.

## Using the Audio Settings

You can change various audio settings from the Home menu (→ page 40).

- 1 Press **RECEIVER** followed by **HOME**.
- 2 Use **▲/▼** and **ENTER** to select “**Audio**”, and then use **▲/▼/◀/▶** to make the desired selection.

#### Note

- These settings are not available in either of the following cases:
  - a pair of headphones is connected.
  - the “**Audio TV Out**” setting is set to “**On**” (→ page 59).
  - “**HDMI Control(RIHD)**” is set to “**On**” (→ page 58) and you’re listening through your TV speakers.

### Tone Control Settings

#### ■ Bass

▶ **-10dB** to **0dB** to **+10dB** in 2 dB steps.

You can boost or cut low-frequency sounds output from the front speakers.

#### ■ Treble

▶ **-10dB** to **0dB** to **+10dB** in 2 dB steps.

You can boost or cut high-frequency sounds output from the front speakers.

You can adjust the bass and treble for the front speakers, except when the Direct, Pure Audio or THX listening mode is selected.

### Operating on the AV receiver

- 1 Press **TONE** repeatedly to select either “**Bass**” or “**Treble**”.
- 2 Use **+** and **-** to adjust.

#### Note

- To bypass the bass and treble tone circuits, select the Direct, Pure Audio or THX listening mode.
- This setting is not available when the multichannel Analog input is selected.

### Speaker Levels

#### ■ Subwoofer Level

▶ **-15.0dB** to **0.0dB** to **+12.0dB** in 0.5 dB steps.

#### ■ Center Level

▶ **-12.0dB** to **0.0dB** to **+12.0dB** in 0.5 dB steps.

You can adjust the volume of each speaker while listening to an input source.

These temporary adjustments are cancelled when the AV receiver is set to standby. To save the setting you made here, go to “**Level Calibration**” (→ page 48) before setting the AV receiver to standby.

#### Note

- You cannot use this function while the AV receiver is muted.
- Speakers that are set to “**No**” or “**None**” in “**Speaker Configuration**” (→ page 47) cannot be adjusted.

### Dolby Volume

#### ■ Dolby Volume

See “**Dolby Volume**” of “**Audio Adjust**” (→ page 51).

#### Note

- This setting cannot be used in either of the following cases:
  - Pure Audio or Direct listening mode is selected.
  - the multichannel analog input is selected.
  - any of the THX listening modes is selected, with “**Loudness Plus**” set to “**On**” or “**Preserve THX Settings**” set to “**Yes**” (→ page 49).
- When “**Dolby Volume**” is set to “**On**”, the “**Dynamic EQ**” and “**Dynamic Volume**” settings of all input selectors are switched to “**Off**”.

## Audyssey

---

### ■ Audyssey

See “Audyssey” in “Source Setup” (→ [page 52](#)).

### ■ Dynamic EQ

See “Dynamic EQ” in “Source Setup” (→ [page 52](#)).

### ■ Dynamic Volume

See “Dynamic Volume” in “Source Setup” (→ [page 52](#)).

#### Note

- These technologies can be used when all the following conditions are met:
  - Room Correction and Speaker Setup is completed. Note that “Audyssey” requires the “Audyssey MultEQ XT Full Calibration” method.
  - Any listening mode other than Direct or Pure Audio is selected.
  - A pair of headphones is not connected.
  - multichannel analog input is not selected.
- The setting is stored individually for each input selector.
- “Dynamic EQ” and “Dynamic Volume” cannot be selected when any of the THX listening modes is selected, with “Loudness Plus” set to “On” or “Preserve THX Settings” set to “Yes”.
- When “Dynamic EQ” is set to “On” or “Dynamic Volume” is set to anything else than “Off”, “Dolby Volume” will be switched to “Off”.

## Late Night

---

### ■ Late Night

For **Dolby Digital** and **Dolby Digital Plus** sources, the options are:

- ▶ **Off**
- ▶ **Low:**  
Small reduction in dynamic range.
- ▶ **High:**  
Large reduction in dynamic range.

For **Dolby TrueHD** sources, the options are:

- ▶ **Auto:**  
The Late Night function is set to “On” or “Off” automatically.
- ▶ **Off**
- ▶ **On**

Turn this setting on to reduce the dynamic range of Dolby Digital material so that you can still hear quiet parts even when listening at low volume levels—ideal for watching movies late at night when you don’t want to disturb anyone.

#### Note

- The effect of the Late Night function depends on the material that you are playing and the intention of the original sound designer, and with some material there will be little or no effect when you select the different options.
- The Late Night function can be used only when the input source is Dolby Digital, Dolby Digital Plus, or Dolby TrueHD.
- The Late Night function is set to “Off” when the AV receiver is set to standby. For Dolby TrueHD sources, it will be set to “Auto”.

## Music Optimizer

---

### ■ Music Optimizer

- ▶ **Off**
- ▶ **On**

Turn this setting on to enhance the sound quality of compressed music files. Use it with music files that use “lossy” compression, such as MP3.

#### Note

- The Music Optimizer function only works with PCM digital audio input signals with a sampling rate below 48 kHz and analog audio input signals. The Music Optimizer is disabled when the Direct or Pure Audio listening mode is selected.
- The setting is stored individually for each input selector.
- The **M.Opt** indicator will light (→ [page 9](#)).
- This setting is not available when the multichannel Analog input is selected.

## Re-EQ

---

With the Re-EQ function, you can compensate a soundtrack whose high-frequency content is too harsh, making it more suitable for home theater viewing.

### ■ Re-EQ

- ▶ **Off**
- ▶ **On**

This function can be used with the following listening modes: Dolby Digital, Dolby Digital Plus, Dolby TrueHD, Multichannel, DTS, DTS-HD High Resolution Audio, DTS-HD Master Audio, DTS Express, DSD, Dolby EX, Dolby Pro Logic IIz Height, Dolby PLIIx Movie, Neo:6 Cinema and 5.1-channel source + Neo:6.

### ■ Re-EQ(THX)

- ▶ **Off**
- ▶ **On**

This function can be used with the following listening modes: THX Cinema, THX Surround EX, and THX Select2 Cinema.

#### Note

- Settings for the Re-EQ function are kept in each listening mode. In THX listening mode however, the setting will return to “On” when the AV receiver is turned off.

# Zone 2

In addition to the main listening room, you can also enjoy playback in another room, which we call Zone 2. For either of the rooms, you can specify a different input source.

## Making Zone 2 Connections

There are two ways you can connect Zone 2 speakers:

1. Connect them directly to the AV receiver.
2. Connect them to an amp in Zone 2.

### Connecting Your Zone 2 Speakers Directly to the AV receiver

This setup allows 5.1-channel playback in your main room and 2-channel stereo playback in Zone 2, with a different source in each room. This is called Powered Zone 2, as the Zone 2 speakers are powered by the AV receiver.

To use this setup, you must set the “Powered Zone 2” setting to “Yes” (→ page 46).

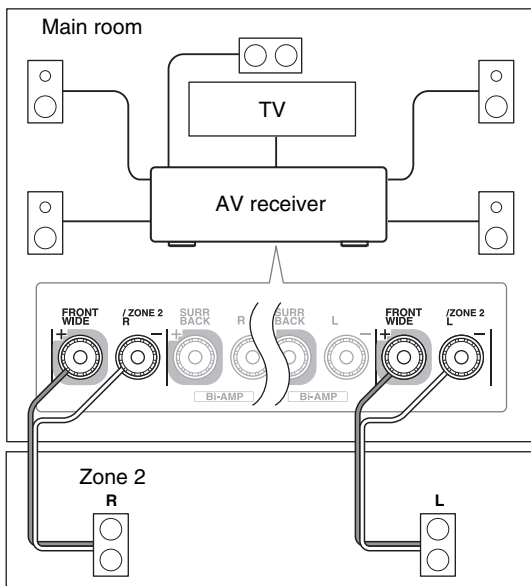

#### Note

- With this setup, the volume of Zone 2 is controlled by the AV receiver.
- Powered Zone 2 cannot be used if “Speakers Type(Front)” is set to “Bi-Amp” (→ page 46).
- When you connect Zone 2 speakers directly to the AV receiver, listening modes that require surround back speakers, front high speakers or front wide speakers (6.1/7.1), such as Dolby Digital EX, DTS-ES, THX Select2 Cinema, Dolby Pro Logic IIz Height, and Audyssey DSX™ are unavailable.

### Connecting the Zone Speakers to an Additional Amplifier

This setup allows 7.1-channel playback in your main listening room and 2-channel stereo playback in Zone 2.

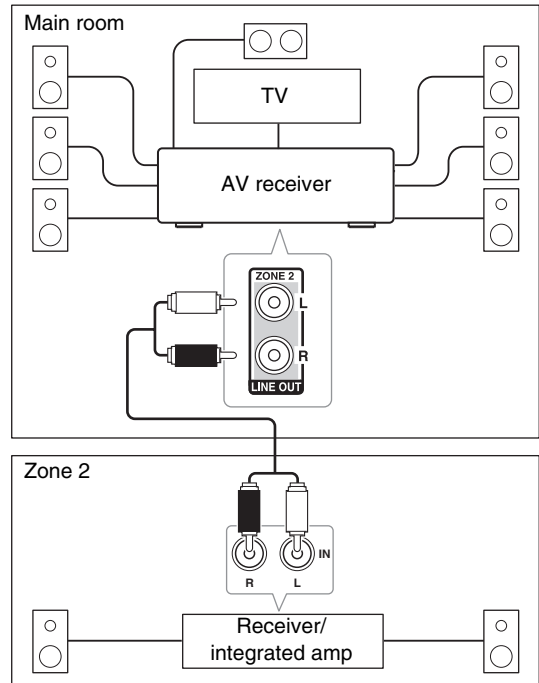

#### Note

- The volume of Zone 2 must be set on the Zone 2 amp.

### Zone 2 12V Trigger

When Zone 2 is turned on, the output from the **12V TRIGGER OUT** jack goes high (+12 V and max. 150 mA for Zone 2). Connecting this jack to a 12-volt trigger input on a component in Zone 2 will make that component turn on or off as the AV receiver turns on or off the Zone 2.

## Controlling Zone 2 Components

### ■ Operating on the AV receiver

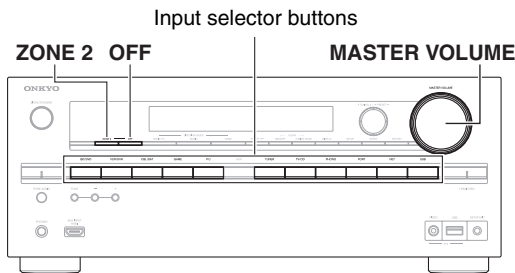

- 1 To turn on Zone 2 and select an input source, press **ZONE 2** followed by an input selector button within 8 seconds.

Zone 2 turns on, the **Z2** indicator lights on the display.

#### Tip

- The corresponding trigger output goes high (+12 V).

To select AM or FM, press the **TUNER** input selector button repeatedly.

To select the same source as the main room's, press **ZONE 2** repeatedly until "Z2 Selector: Source" appears on the display.

To turn off Zone 2, press **OFF**.

The zone is turned off.

#### Tip

- The corresponding trigger output goes low (0 volts).

### ■ Operating on the remote controller

To control Zone 2, you must press **ZONE2** on the remote controller first.

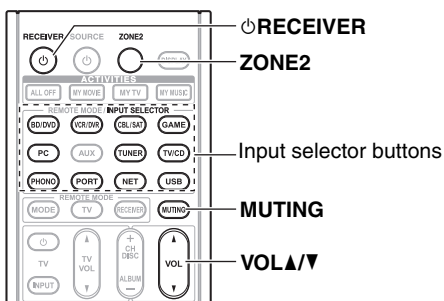

- 1 Press **ZONE2** and then press **RECEIVER**.  
Zone 2 turns on, the **Z2** indicator lights on the display.

#### Tip

- The corresponding trigger output goes high (+12 V).

- 2 To select an input source for Zone 2, press **ZONE2**, followed by an input selector button.

To select AM or FM, press the **TUNER** input selector button repeatedly.

#### Note

- You cannot select different AM or FM radio stations for your main room and Zone 2. The same AM/FM radio station will be heard in each room.

- 3 To turn off Zone 2, press **ZONE2** followed by **RECEIVER**.

#### Tip

- The corresponding trigger output goes low (0 volts).

## Adjusting the Volume for Zone 2

### ■ Operating on the remote controller

- 1 Press **ZONE2**.
- 2 Use **VOL ▲/▼** to adjust the volume.

### ■ Operating on the AV receiver

- 1 Press **ZONE 2** (the **Z2** indicator on the display flash).
- 2 Use **MASTER VOLUME** control within 8 seconds to adjust the volume.

If your Zone 2 speakers are connected to a receiver or integrated amp in Zone 2, use its volume control to adjust the volume.



## Muting Zone 2

### ■ Operating on the remote controller

#### 1 Press ZONE2 followed by MUTING.

#### Tip

- To unmute, press **ZONE2** followed by **MUTING** again.

#### Note

- Only analog input sources are output from the **ZONE 2 LINE OUT L/R** jacks and **FRONT WIDE/ZONE 2 L/R** terminals. Digital input sources are not output. If no sound is heard when an input source is selected, verify that the source is connected to an analog input.
- While Zone 2 is on, **RI** functions will not work.
- You cannot select different AM or FM radio stations for your main room and Zone 2. The same AM/FM radio station will be heard in each room. Namely, if you have selected an FM station for the main room, that station will also be output in Zone 2.
- When you have selected **NET** or **USB** as the input selector, the last selector selected will be set for both Main room and Zone 2.
- Zone 2 can also be unmuted by adjusting the volume.
- When Zone 2 is activated and its input selector is selected, the power consumption of standby mode slightly increases.
- When setting the AV receiver to standby mode while Zone 2 is active, the **Z2** indicator is dimly lit.
- Activating Zone 2 in the main room when the listening mode is set to Pure Audio will automatically switch it to Direct.
- **AUX** cannot be selected as the input selector for Zone 2.
- When **AUX** is the input source of Main room and Zone 2 is set to share the same source, no sound will be output from Zone 2.

## Using the Remote Controller in Zone 2 and Multiroom Control Kits

To control the AV receiver with the remote controller while you're in Zone 2, you'll need a commercially available multiroom remote control kit for each zone.

- Multiroom kits are made by Niles and Xantech.
- These kits can also be used when there isn't a clear line of sight to the AV receiver's remote sensor, such as when it's installed inside a cabinet.

### Using a Multiroom Kit with Zone 2

In this setup, the IR receiver in Zone 2 picks up the infrared signals from the remote controller and feeds them through to the AV receiver in the main room via the connecting block.

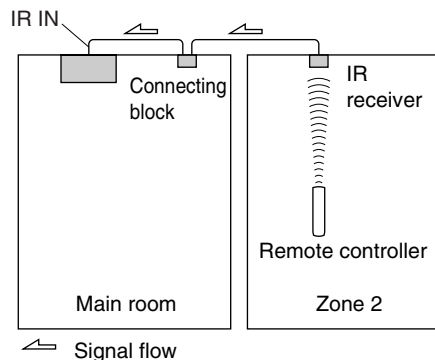

The miniplug cable from the connecting block should be connected to the AV receiver's **IR IN** jack, as shown below.

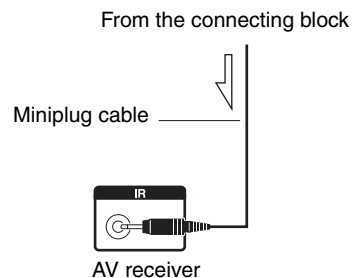

### Using a Multiroom Kit with a Cabinet

In this setup, the IR receiver picks up the infrared signals from the remote controller and feeds them to the AV receiver located in the cabinet via the connecting block.

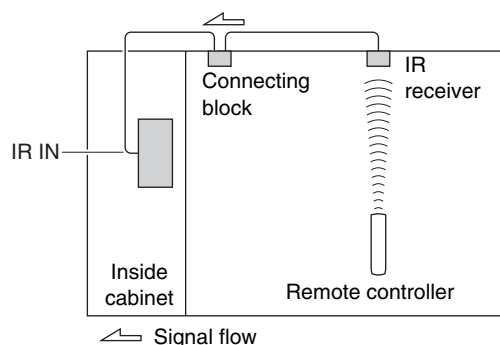

# iPod/iPhone Playback via Onkyo Dock

## Using the Onkyo Dock

The Dock is sold separately. Models sold are different depending on the region.

For the latest information on the Onkyo Dock components, see the Onkyo web site at: <http://www.onkyo.com>

Before using the Onkyo Dock components, update your iPod/iPhone with the latest software, available from the Apple web site.

For supported iPod/iPhone models, see the instruction manual of the Onkyo Dock.

## UP-A1 Dock

With the UP-A1 Dock, you can easily play the music, photos, or movies stored on your Apple iPod/iPhone through the AV receiver and enjoy great sound.

You can use the AV receiver's remote controller to operate your iPod/iPhone.

### ■ System Function

The AV receiver may take several seconds to startup, so you might not hear the first few seconds of the first song.

#### Auto Power On

If you start iPod/iPhone playback while the AV receiver is on standby, the AV receiver will automatically turn on and select your iPod/iPhone as the input source.

#### Direct Change

If you start iPod/iPhone playback while listening to another input source, the AV receiver will automatically select your iPod/iPhone as the input source.

#### Using the AV receiver's Remote Controller

You can use the AV receiver's remote controller to control basic iPod/iPhone functions (→ [page 67](#)).

### ■ Operating Notes

- Functionality depends on your iPod/iPhone model and generation.
- Before selecting a different input source, stop your iPod/iPhone playback to prevent the AV receiver from selecting the iPod/iPhone input source by mistake.
- If any accessories are connected to your iPod/iPhone, the AV receiver may not be able to select the input source properly.
- When connecting the UP-A1 Dock to the radio tuner UP-HT1 (North American models)/UP-DT1 (European, Australian and Asian models) with AUTO selected by the tuner's Mode Selector switch, you can switch the input source between UP-A1 Dock and the tuner, by pressing **PORT** repeatedly on the front panel.
- While your iPod/iPhone is in the UP-A1 Dock, its volume control has no effect. If you adjust your iPod/iPhone volume control while it's in the UP-A1 Dock, make sure it's not set too high before you reconnect your headphones.
- The Auto Power On function will not work if you set your iPod/iPhone in the UP-A1 Dock while it is playing.
- When Zone 2 is turned on, you can't use Auto Power On and Direct Change functions.
- Do not turn off the power with the iPod/iPhone still connected to this unit via the UP-A1 Dock.
- Set your iPod/iPhone in the UP-A1 Dock after the AV receiver turns on.
- The "**Charge Mode**" setting must be set to "**On**" to enable the Auto Power On and Direct Change functions (→ [page 56](#)).

### ■ Using Your iPod/iPhone Alarm Clock

You can use the Alarm Clock function of your iPod/iPhone to automatically turn on your iPod/iPhone and the AV receiver at a specified time. The AV receiver's input source will automatically be set to the **PORT** selector.

#### Note

- To use this function, your iPod/iPhone must be in the UP-A1 Dock, and the UP-A1 Dock must be connected to the AV receiver.
- This function works only in Standard mode (→ [page 68](#)).
- When you use this function, be sure to set the AV receiver's volume control to a suitable level.
- When Zone 2 is turned on, you can't use this function.
- This function doesn't work when alarms sounds are set on your iPod/iPhone.
- The "**Charge Mode**" setting must be set to "**On**" to enable the Alarm Clock function (→ [page 56](#)).

### ■ Charging Your iPod/iPhone Battery

When the UP-A1 Dock with docked iPod/iPhone is connected to the AV receiver, the battery of your iPod/iPhone is charged. Charging occurs when AV receiver is set to on or standby.

You can specify how the power is fed to your iPod/iPhone when the AV receiver is in standby mode (→ [page 56](#)).

#### Note

- When the UP-A1 Dock with docked iPod/iPhone is connected, the power consumption on standby mode slightly increases.

## ■ Status Messages

If either of the following messages is not displayed on the AV receiver's display, check the connection to your iPod/iPhone.

### • PORT Reading

The AV receiver is checking the connection with the dock.

### • PORT Not Support

The AV receiver do not support the connected dock.

### • PORT UP-A1

UP-A1 Dock is connected.

#### Note

- The AV receiver displays the message “UP-A1” for several seconds after recognizing the UP-A1.

## RI Dock

With the RI Dock, you can easily play the music stored on your Apple iPod/iPhone through the AV receiver and enjoy great sound, and watch iPod/iPhone slideshows and videos on your TV. In addition, the onscreen display (OSD) allows you to view, navigate, and select your iPod/iPhone model's contents on your TV, and with the supplied remote controller, you can control your iPod/iPhone from the comfort of your sofa. You can even use the AV receiver's remote controller to operate your iPod/iPhone.

#### Note

- Enter the appropriate remote control code before using the AV receiver's remote controller for the first time (→ page 69).
- Connect the RI Dock to the AV receiver with an **RI** cable (→ page 20).
- Set the RI Dock's RI MODE switch to “HDD” or “HDD/DOCK”.
- Set the AV receiver's Input Display to “DOCK” (→ page 41).

## ■ System Function

### System On

When you turn on the AV receiver, the RI Dock and iPod/iPhone turn on automatically. In addition, when RI Dock and iPod/iPhone are on, the AV receiver can be turned on by pressing **SOURCE**.

### Auto Power On

If you press the remote controller's **▶** (Playback) while the AV receiver is on standby, the AV receiver will automatically turn on, select your iPod/iPhone as the input source, and your iPod/iPhone will start playback.

### Direct Change

If you start iPod/iPhone playback while listening to another input source, the AV receiver will automatically switch to the input to which the RI Dock is connected.

### Other Remote Controllers

You can use the remote controller that came with the AV receiver to control other iPod/iPhone functions. The available functionality depends on the AV receiver.

## iPod/iPhone Alarm

If you use the Alarm function on your iPod/iPhone to start playback, the AV receiver will turn on at the specified time and select your iPod/iPhone as the input source automatically.

#### Note

- Linked operations do not work with video playback or when the alarm is set to play a sound.
- If you use your iPod/iPhone with any other accessories, iPod/iPhone playback detection may not work.
- This function works only in Standard mode (→ page 68).
- The System On function may not work depending on the RI Dock.

### ■ Operating Notes

- Use the AV receiver's volume control to adjust the playback volume.
- While your iPod/iPhone is inserted in the RI Dock, its volume control has no effect.
- If you do adjust the volume control on your iPod/iPhone while it's inserted in the RI Dock, be careful that it's not set too loud before you reconnect your headphones.

#### Note

- On the iPod with video and iPod nano (1st generation), the click wheel is disabled during playback.

## Controlling Your iPod/iPhone

By pressing the **REMOTE MODE** that's been programmed with the remote control code for your Dock, you can control your iPod/iPhone in the Dock with the buttons described further in this section.

See “Entering Remote Control Codes” for details on entering a remote control code (→ page 69).

See the Dock's instruction manual for more information.

## UP-A1 Dock

**PORT** is preprogrammed with the remote control code for controlling a Dock via Universal Port.

You can control your iPod/iPhone when “**PORT**” is selected as the input source.

## RI Dock

- Set the RI Dock's RI MODE switch to “HDD” or “HDD/DOCK”.
- **SOURCE** may not work with a remote control code (without **RI**). In this case, make an **RI** connection and enter the remote control code **81993** (with **RI**).

### ■ With the RI Control

Make an **RI** connection and enter the remote control code **81993** (with **RI**).

- Set the AV receiver's Input Display to “DOCK” (→ page 41).

### ■ Without the RI Control

You must enter the remote control code **82990** first (→ page 70).

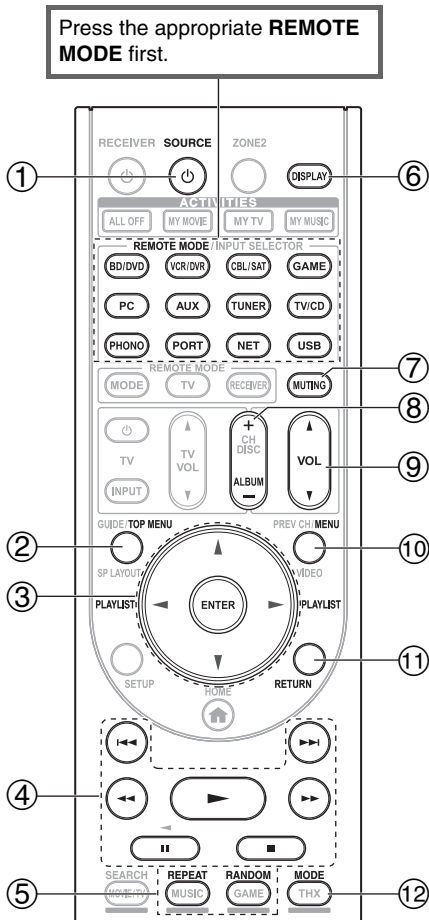

Buttons	Onkyo Dock	UP-A1 Dock	RI Dock
	①	POWER SOURCE*1	
②	TOP MENU*2		✓
③	▲/▼/◀/▶, ENTER	✓*3	✓
	PLAYLIST ◀/▶	✓*4	✓
④	▶, II, ■, ◀◀, ▶▶, ◀◀◀, ▶▶▶	✓	✓
⑤	REPEAT	✓	✓
	RANDOM	✓	✓
⑥	DISPLAY	✓*5	✓*6
⑦	MUTING	✓	✓
⑧	ALBUM +/-	✓*4	✓
⑨	VOL ▲/▼	✓	✓
⑩	MENU		✓
⑪	RETURN	✓	
⑫	MODE	✓*7	✓*8

- With some iPod/iPhone models, generations and RI Docks, certain buttons may not work as expected.
- For detailed operation of iPod/iPhone, please refer to the instruction manual of the RI Dock.

\*1 This button does not turn the Onkyo DS-A2 or DS-A2X RI Dock on or off. Also, your iPod/iPhone may not respond the first time you press this button, in which case you should press it again. This is because the remote controller transmits the On and Standby commands alternately, so if your iPod/iPhone is already on, it will remain on when the remote controller transmits the On command. Similarly, if your iPod/iPhone is already off, it will remain off when the remote controller transmits the Off command.

\*2 **TOP MENU** works as the mode button when used with the DS-A2 RI Dock.

\*3 In Extended mode (see \*7), ◀/▶ is used as the page jump button. This allows you to quickly locate your favorite songs even when such lists as the song or artist lists are very long.

\*4 In Extended mode (see \*7), this button doesn't work.

\*5 In Extended mode (see \*7), **DISPLAY** is used to switch between song informations. In Standard mode (see \*7), **DISPLAY** turns on backlight for a second.

\*6 **DISPLAY** turns on backlight for a second.

\*7 Press **MODE** to switch between the following modes:

**Standard mode**

Nothing is displayed on your TV. Contents are browsed and selected on your iPod/iPhone display.

**Extended mode (Music)**

The music contents (artists, albums, songs, and so on) are displayed on your TV, and you can browse and select them on screen.

**Extended mode (Video)**

The video contents (Movies, Music Videos, TV Shows, Video Podcasts or Rentals) are displayed on your TV, and you can browse and select them on screen.

\*8 **Resume mode**

With the Resume function, you can resume playback of the song that was playing when you removed your iPod/iPhone from the RI Dock.

**Note**

- In Extended mode (see \*7), you cannot operate your iPod/iPhone directly.
- In Extended mode (see \*7), it may take some time to acquire the contents.
- In Extended mode (see \*7), the on-screen navigation menus only appear on a TV that is connected to the **HDMI OUT MAIN**.

# Controlling Other Components

You can use the AV receiver's remote controller to control your other AV components, including those made by other manufacturers. This section explains how to enter the remote control code for a component that you want to control: DVD, TV, CD, etc.

"Learning Commands" for learning commands directly from another component's remote controller (→ [page 72](#)).

"Using Normal Macros" for programming **ACTIVITIES** to perform a sequence of remote control actions (→ [page 73](#)).

## Preprogrammed Remote Control Codes

The following **REMOTE MODE** buttons are preprogrammed with remote control codes for controlling the components listed. You do not need to enter a remote control code to control these components.

For details on controlling these components, see the indicated pages.

<b>BD/DVD</b>	Onkyo Blu-ray Disc player (→ <a href="#">page 70</a> )
<b>TV/CD</b>	Onkyo CD player (→ <a href="#">page 70</a> )
<b>PORT</b>	Onkyo Universal Port Option (→ <a href="#">page 67</a> )

## Looking up for Remote Control Code

You can look up for an appropriate remote control code from the on-screen setup menu.

### Note

- This can only be carried out using the on-screen setup menu.

### 1 Press **RECEIVER** followed by **SETUP**.

The main menu appears on-screen.

### Tip

- If the main menu doesn't appear, make sure the appropriate external input is selected on your TV.

### 2 Use **▲/▼** to select "**Remote Controller Setup**", and then press **ENTER**.

### 3 Use **▲/▼** to select "**Remote Mode Setup**", and then press **ENTER**.

### 4 Use **▲/▼** to select a remote mode, and then press **ENTER**.

The menu of category selection appears.

### 5 Use **▲/▼** to select a category, and then press **ENTER**.

The panel for brand name input appears.

### 6 Use **▲/▼/◀/▶** to select a character, and then press **ENTER**.

Repeat this step for the first three characters of the brand name.

When you have entered the 3rd character, select "**Search**" and press **ENTER**.

A list of brand names is retrieved.

**If the desired brand name is not found:**

Use **▶** to select "**Not Listed**", and then press **ENTER**.

The panel for brand name input appears.

### 7 Use **▲/▼** to select a brand, and then press **ENTER**.

A remote control code with its instructions are displayed. Follow the procedure.

### 8 If you can control the component, use **▲/▼** to select "**OK**", and then press **ENTER**.

The "**Remote Mode Setup**" menu appears.

**If you cannot control the component, use **▲/▼** to select "**Try next code**" and press **ENTER**.**

The next code is displayed.

## Entering Remote Control Codes

You'll need to enter a code for each component that you want to control.

### 1 Look up the appropriate remote control code in the separate **Remote Control Codes** list.

The codes are organized by category (e.g., DVD player, TV, etc.).

### 2 While holding down the **REMOTE MODE** to which you want to assign a code, press and hold down **DISPLAY** (about 3 seconds).

The **REMOTE MODE** button lights.

### Note

- Remote control codes cannot be entered for **RECEIVER** and **ZONE 2**.
- Only TV remote control codes can be entered for **TV**.
- Except for **RECEIVER**, **TV** and **ZONE 2**, remote control codes from any category can be assigned to the **REMOTE MODE**. However, these buttons also work as input selector buttons (→ [page 23](#)), so choose a **REMOTE MODE** that corresponds with the input to which you connect your component. For example, if you connect your CD player to the CD input, choose **TV/CD** when entering its remote control code.

### 3 Within 30 seconds, use the number buttons to enter the 5-digit remote control code.

**REMOTE MODE** button flashes twice.

If the remote control code is not entered successfully, **REMOTE MODE** button will flash once slowly.

### Note

- Though the provided remote control codes are correct at the time of printing, they are subject to change.

## Remote Control Codes for Onkyo Components Connected via RI

Onkyo components that are connected via **RI** are controlled by pointing the remote controller at the AV receiver, not the component. This allows you to control components that are out of view, in a rack, for example.

- 1 Make sure the Onkyo component is connected with an RI cable and an analog audio cable (RCA).**  
See “Connecting Onkyo **RI** Components” for details (→ page 20).
- 2 Enter the appropriate remote control code for REMOTE MODE, referring to the previous section.**
  - ▶ **42157:**  
Onkyo cassette tape deck with **RI**
  - ▶ **81993:**  
Onkyo Dock with **RI**
- 3 Press REMOTE MODE, point the remote controller at the AV receiver, and operate the component.**

### Controlling Onkyo components without RI

If you want to control an Onkyo component by pointing the remote controller directly at it, or you want to control an Onkyo component that’s not connected via **RI**, use the following remote control codes:

- ▶ **30627:**  
Onkyo DVD player without **RI**
- ▶ **71817:**  
Onkyo CD player without **RI**
- ▶ **32900/33100/33500:**  
Onkyo Blu-ray Disc player
- ▶ **32901/33104/33504:**  
Onkyo HD DVD player
- ▶ **70868:**  
Onkyo MD recorder without **RI**
- ▶ **71323:**  
Onkyo CD recorder without **RI**
- ▶ **82990:**  
Onkyo Dock without **RI**

## Resetting REMOTE MODE Buttons

You can reset a **REMOTE MODE** to its default remote control code.

- 1 While holding down REMOTE MODE that you want to reset, press and hold down HOME until REMOTE MODE button lights (about 3 seconds).**

- 2 Within 30 seconds, press REMOTE MODE again.** **REMOTE MODE** button flashes twice, indicating that the button has been reset.  
Each of **REMOTE MODE** is preprogrammed with a remote control code. When a button is reset, its preprogrammed code is restored.

### Note

- The learning command is also reset.

## Resetting the Remote Controller

You can reset the remote controller to its default settings.

- 1 While holding down RECEIVER, press and hold down HOME until RECEIVER lights (about 3 seconds).**
- 2 Within 30 seconds, press RECEIVER again.** **RECEIVER** flashes twice, indicating that the remote controller has been reset.

## Controlling Other Components

By pressing the **REMOTE MODE** that’s been programmed with the remote control code for your component, you can control your component as described below.

For details on entering a remote control code for other components, see “Entering Remote Control Codes” (→ page 69).

### Controlling a TV

**TV** is preprogrammed with the remote control code for controlling a TV that supports the **RIHD**\*1 (limited to some models). The TV must be able to receive remote control commands via **RIHD** and be connected to the AV receiver via HDMI. If controlling your TV via **RIHD** doesn’t work very well, program your TV’s remote control code into **TV** and use the TV remote mode to control your TV.

Use the following remote control codes:

- ▶ **11807/13100/13500:**  
TV with **RIHD**

### Controlling a Blu-ray Disc/DVD Player, HD DVD Player or DVD Recorder

**BD/DVD** is preprogrammed with the remote control code for controlling a component that supports the **RIHD**\*1 (limited to some models). The component must be able to receive remote control commands via **RIHD** and be connected to the AV receiver via HDMI.

Use the following remote control codes:

- ▶ **32910/33101/33501/31612:**  
Blu-ray Disc/DVD player with **RIHD**

\*1 The **RIHD** supported by the AV receiver is the CEC system control function of the HDMI standard.

Press the appropriate **REMOTE MODE** first.

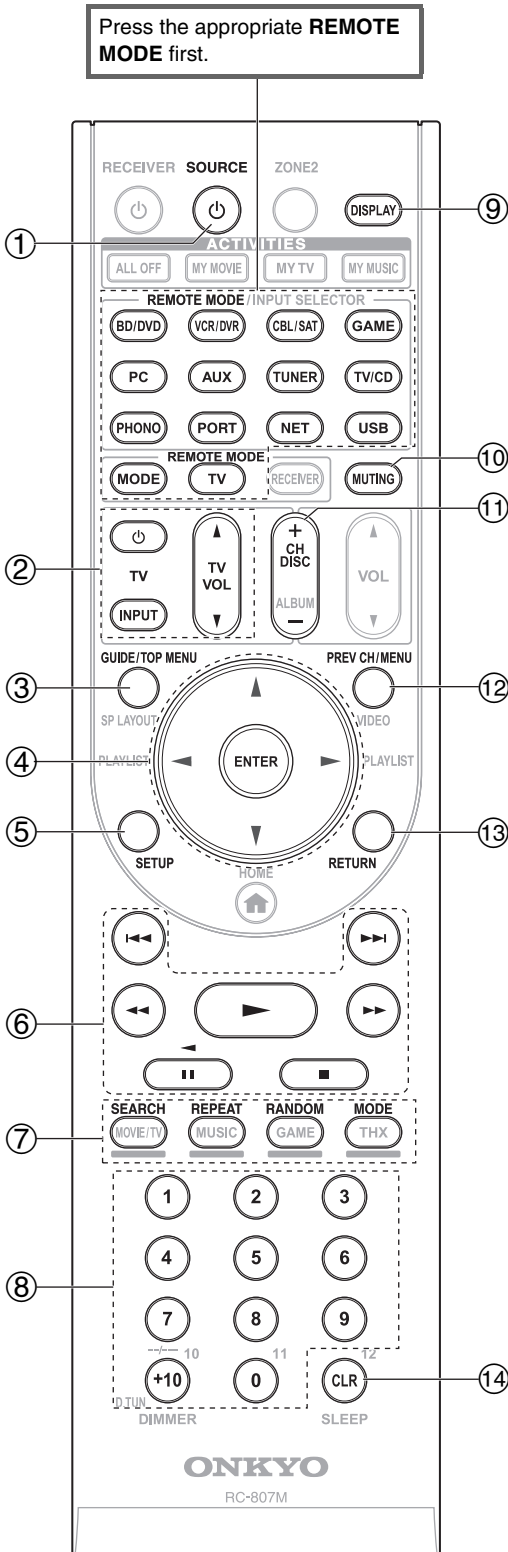

Buttons	Components						
	TV	DVD player/DVD recorder	Blu-ray Disc player HD DVD player	VCR/PVR	Satellite receiver Cable receiver	CD player/CD recorder MD recorder	Cassette tape deck
① <b>SOURCE</b> *1		✓		✓	✓	✓	✓
② <b>INPUT</b> , <b>TV VOL</b> ▲/▼	✓						
③ <b>GUIDE</b> <b>TOP MENU</b>	✓			✓	✓		
④ ▲/▼/◀/▶, <b>ENTER</b>	✓	✓		✓	✓	✓	
⑤ <b>SETUP</b>	✓	✓		✓	✓	✓	
⑥ ▶, ■, ■, ◀, ◀, ▶▶, ◀◀, ▶▶	✓ <sup>2</sup>	✓		✓	✓	✓	✓ <sup>3</sup>
⑦ <b>SEARCH</b> <b>REPEAT</b> <b>RANDOM</b> <b>MODE</b>	✓ <sup>2*4</sup>	✓ <sup>2</sup>	✓ <sup>4</sup>		✓ <sup>4</sup>	✓	
⑧ Number: <b>1 to 9, 0</b> Number: <b>+10</b>	✓	✓			✓	✓	
⑨ <b>DISPLAY</b>		✓			✓	✓	
⑩ <b>MUTING</b>		✓			✓	✓	✓
⑪ <b>CH +/-</b> <b>DISC +/-</b>	✓	✓			✓	✓	
⑫ <b>PREV CH</b> <b>MENU</b>	✓				✓	✓	
⑬ <b>RETURN</b>	✓	✓			✓	✓	
⑭ <b>CLR</b>	✓	✓			✓	✓	

\*1 When you press **SOURCE**, the related component is turned on (or off).

\*2 The **RIHD** function is not supported. The **RIHD** supported by the AV receiver is the CEC system control function of the HDMI standard.

\*3 **■** (Pause) functions as reverse playback.

\*4 These buttons function as colored buttons or A, B, C, D buttons.

**Note**

• See the “Controlling Your iPod/iPhone” about the operation of iPod/iPhone (→ **page 67**).

**Note**

• With some components, certain buttons may not work as expected, and some may not work at all.

## Learning Commands

The AV receiver's remote controller can learn the commands of other remote controllers. By transmitting, for example, the Play command from your CD player's remote controller, the supplied remote controller can learn it, and then reproduce the exact same command when its **▶** is pressed in CD remote mode.

This is useful when you've entered the appropriate remote control code (→ **page 69**) but some buttons don't work as expected.

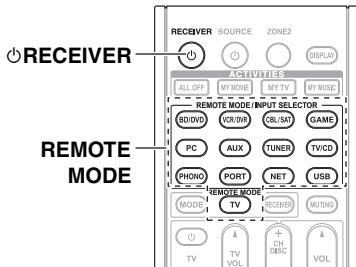

- 1** While holding down **REMOTE MODE** for the mode in which you want to use the command, press and hold down **REVERSE** until the **REMOTE MODE** button lights (about 3 seconds).
- 2** On the supplied remote controller, press the button to which you want to assign the new command.
- 3** Point the remote controllers at each other, within about 4 inches (10 cm) apart, and then press and hold the button whose command you want to acquire until the **REMOTE MODE** button flashes.

If the command is learned successfully, the **REMOTE MODE** button flashes twice.

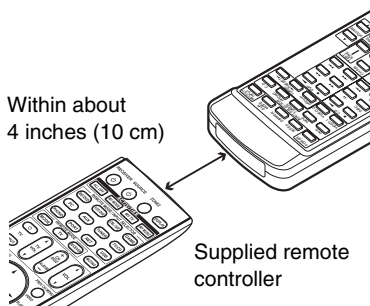

- 4** To learn more commands, repeat steps 2 and 3. Press any **REMOTE MODE** when you've finished. The **REMOTE MODE** button flashes twice.

### Note

- The following buttons cannot learn new commands: **REVERSE, ALL OFF, MY MOVIE, MY TV, MY MUSIC, REMOTE MODE, MODE, HOME.**
- The remote controller can learn approximately 70 to 90 commands, although this will be less if commands that use a lot of memory are learned.
- Remote controller buttons such as Play, Stop, and Pause are preprogrammed with commands for controlling Onkyo CD players, cassette decks, and DVD players. However, they can learn new commands, and you can restore the preprogrammed commands at any time by resetting the remote controller (→ **page 70**).
- To overwrite a previously acquire command, repeat this procedure.
- Depending on the remote controller that you are using, there may be some buttons that won't work as expected, or even some remotes with which learning is impossible.
- Only commands from infrared remote controllers can be acquire.
- When the remote controller runs out of batteries, all commands acquired will be lost and will have to be learned all over again. Therefore, do not discard your other remote controllers.

### Deleting Acquired Commands

1. While holding down **REMOTE MODE** for the mode from which you want to delete a command, press and hold down **TV** until the **REMOTE MODE** button lights (about 3 seconds).
2. Press **REMOTE MODE** or the button from which you want to delete the commands. The **REMOTE MODE** button flashes twice. When you press **REMOTE MODE**, all commands learned in that mode will be deleted.



## Using Normal Macros

You can program the remote controller's **ACTIVITIES** to perform a sequence of remote control actions.

### Example:

To play a CD you typically need to perform the following actions:

1. Press **RECEIVER** to select the Receiver remote controller mode.
2. Press **RECEIVER** to turn on the AV receiver.
3. Press **TV/CD** to select the TV/CD input source.
4. Press **▶** to start playback on the CD player.

You can program **ACTIVITIES** so that all four actions are performed with just one button press.

## Making Macros

Each **ACTIVITIES** can store one macro, and each macro can contain up to 32 commands.

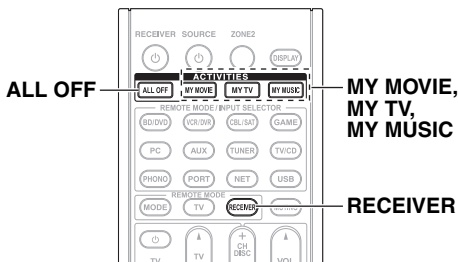

- 1 While holding down **RECEIVER**, press and hold down **MY MOVIE**, **MY TV**, or **MY MUSIC** until **MY MOVIE**, **MY TV**, or **MY MUSIC** lights (about 3 seconds).
- 2 Press the buttons whose actions you want to program into the macro in the order you want them performed.

For the CD example above, you would press the following buttons: **RECEIVER**, **TV/CD**, **▶**.

- 3 When you've finished, press **ACTIVITIES** again. **ACTIVITIES** button flashes twice.

If you enter 32 commands, the process will finish automatically.

### Note

- **MODE** cannot be operated during the macro-making process.
- Once you assign new macro commands, the previously registered macro will no longer work. If you wish to retrieve it, you will have to reassign the commands with the macro-making.

## Running Macros

- 1 Press **MY MOVIE**, **MY TV**, or **MY MUSIC**.

The commands in the macro are transmitted in the order in which they were programmed. Keep the remote controller pointed at the AV receiver until all of the commands have been transmitted.

Macros can be run at any time, regardless of the current remote controller mode.

## Deleting Macros

- 1 While holding down **HOME**, press and hold down **ALL OFF** until **ALL OFF** lights (about 3 seconds).
- 2 Press **ALL OFF** again. **ALL OFF** flashes twice.

### Note

- When Normal macros are deleted, **ACTIVITIES** are restored to their default settings, namely the Easy macro commands (→ page 42).
- When using Normal macros, Easy macros cannot be used, which includes changing the source components.

# Troubleshooting

If you have any trouble using the AV receiver, look for a solution in this section. If you can't resolve the issue yourself, contact your Onkyo dealer.

If you can't resolve the issue yourself, try resetting the AV receiver before contacting your Onkyo dealer.

**To reset the AV receiver to its factory defaults, turn it on and, while holding down VCR/DVR, press ON/STANDBY. "Clear" will appear on the display and the AV receiver will enter standby mode.**

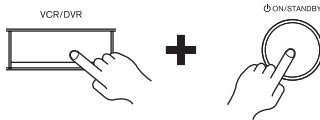

Note that resetting the AV receiver will delete your radio presets and custom settings.

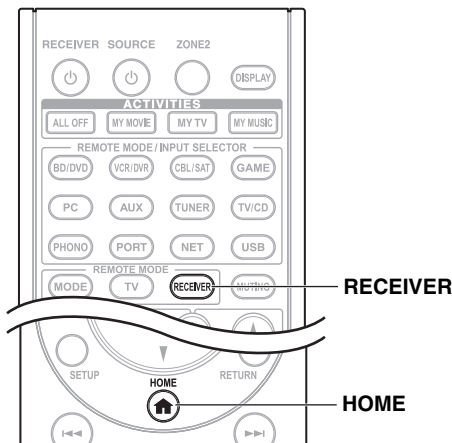

To reset the remote controller to its factory defaults, while holding down **RECEIVER**, press and hold down **HOME** until **RECEIVER** button lights (about 3 seconds). Within 30 seconds, press **RECEIVER** again.

The on-screen menus appear only on a TV that is connected to the **HDMI OUT MAIN**. If your TV is connected to other video outputs, use the AV receiver's display when changing settings.

## Power

### Can't turn on the AV receiver

Make sure that the power cord is properly plugged into the wall outlet.

Unplug the power cord from the wall outlet, wait five seconds or more, then plug it in again.

### The AV receiver turns off unexpectedly

The AV receiver will automatically enter standby mode when Auto Standby has been set and launches.

### When the power is restored after a power interruption, "CHECK SP WIRE" appears on the display

The protection circuit has been activated. Remove the power cord from the wall outlet immediately. Disconnect all speaker cables and input sources, and leave the AV receiver with its power cord disconnected for 1 hour. After that, reconnect the power cord and set the volume to maximum. If the AV receiver stays on, set the volume to minimum, disconnect the power cord, and reconnect your speakers and input sources. If the AV receiver turns off when you set the volume to maximum, disconnect the power cord, and contact your Onkyo dealer.

## Audio

### There's no sound, or it's very quiet

Make sure that the digital input source is selected properly. **46**

Make sure that all audio connecting plugs are pushed in all the way. **16**

Make sure that the inputs and outputs of all components are connected properly. **17-20**

Make sure that the polarity of the speaker cables is correct, and that the bare wires are in contact with the metal part of each speaker terminal. **13**

Make sure that the input source is properly selected. **23**

Make sure that the speaker cables are not shorting. **13**

Check the volume. The AV receiver is designed for home theater enjoyment. It has a wide volume range, allowing precise adjustment.

If the **MUTING** indicator is flashing on the display, press the remote controller's **MUTING** to unmute the AV receiver. **41**

While a pair of headphones is connected to the **PHONES** jack, no sound is output from the speakers. **41**

If there's no sound from a DVD player connected to an **HDMI IN**, check the DVD player's output settings, and be sure to select a supported audio format.

Check the digital audio output setting on the connected device. On some game consoles, such as those that support DVD, the default setting is off.

With some DVD-Video discs, you need to select an audio output format from a menu.

If your turntable uses an MC cartridge, you must connect an MC head amp, or an MC transformer.

Make sure that none of the connecting cables are bent, twisted, or damaged.

Not all listening modes use all speakers. **35**

Specify the speaker distances and adjust the individual speaker levels. **48**

Make sure that the speaker setup microphone is not still connected.

The input signal format is set to "PCM" or "DTS". Set it to "Off". **55**

## ■ Only the front speakers produce sound

When the Stereo or Mono listening mode is selected, only the front speakers and subwoofer produce sound. —

In the Mono listening mode, only the front speakers output sound if the “**Output Speaker**” setting is set to “**Left / Right**”. **50**

Check the Speaker Configuration. **47**

## ■ Only the center speaker produces sound

If you use the Dolby Pro Logic IIx Movie, Dolby Pro Logic IIx Music, or Dolby Pro Logic IIx Game listening mode with a mono source, such as an AM radio station or mono TV program, the sound is concentrated in the center speaker. —

In the Mono listening mode, only the center speaker output sound if the “**Output Speaker**” setting is set to “**Center**”. **50**

Make sure the speakers are configured correctly. **47**

## ■ The surround speakers produce no sound

When the T-D (Theater-Dimensional), Stereo or Mono listening mode is selected, the surround speakers produce no sound. —

Depending on the source and current listening mode, not much sound may be produced by the surround speakers. Try selecting another listening mode. —

Make sure the speakers are configured correctly. **47**

## ■ The center speaker produces no sound

When the Stereo or Mono listening mode is selected, the center speaker produces no sound. —

In the Mono listening mode, only the front speakers output sound if the “**Output Speaker**” setting is set to “**Left / Right**”. **50**

Make sure the speakers are configured correctly. **47**

## ■ The front high, front wide and surround back speakers produce no sound

Depending on the current listening mode, no sound may be produced by the front high, front wide and surround back speakers. Select another listening mode. **35**

Depending on the sound source, the sound produced by the front high, front wide and surround back speakers may be weak. —

Make sure the speakers are configured correctly. **47**

While the “**Powered Zone 2**” setting is set to “**Yes**”, playback in the main room is reduced to 5.1-channels and the front high, front wide and surround back speakers produce no sound. **63**

## ■ The subwoofer produces no sound

When you play a source material that contains no information in the LFE channel, the subwoofer produces no sound. —

Make sure the speakers are configured correctly. **47**

## ■ There's no sound with a certain signal format

Check the digital audio output setting on the connected device. On some game consoles, such as those that support DVD, the default setting is off. —

With some DVD-Video discs, you need to select an audio output format from a menu. —

Depending on the input signal, some listening modes cannot be selected. **35–39**

## ■ Can't select the Pure Audio listening mode

The Pure Audio listening mode cannot be selected while Zone 2 is on. —

## ■ Can't get 6.1/7.1 playback

If no surround back, front wide and front high speakers are connected, or the Zone 2 speakers are being used, 6.1/7.1 playback is not possible. —

Depending on the number of connected speakers, it is not always possible to select all of the listening modes. **35–39**

## ■ The speaker volume cannot be set as required

Check to see if a maximum volume has been set. **57**

If the volume level of each individual speaker has been adjusted to high positive values, then the maximum master volume possible may be reduced. Note that the individual speaker volume levels are set automatically after the Audyssey MultEQ® XT Room Correction and Speaker Setup has been performed. **31, 48**

## ■ Noise can be heard

Using cable ties to bundle audio cables with power cords, speaker cables, and the like may degrade the audio performance, so refrain from doing it. —

An audio cable may be picking up interference. Try repositioning your cables. —

## ■ The Late Night function doesn't work

Make sure the source material is Dolby Digital, Dolby Digital Plus, and Dolby TrueHD. **62**

## ■ About DTS signals

When DTS program material ends and the DTS bitstream stops, the AV receiver remains in DTS listening mode and the DTS indicator remains on. This is to prevent noise when you use the pause, fast forward, or fast reverse function on your player. If you switch your player from DTS to PCM, because the AV receiver does not switch formats immediately, you may not hear any sound, in which case you should stop your player for about three seconds, and then resume playback. —

With some CD and LD players, you won't be able to playback DTS material properly even though your player is connected to a digital input on the AV receiver. This is usually because the DTS bitstream has been processed (e.g., output level, sampling rate, or frequency response changed) and the AV receiver doesn't recognize it as a genuine DTS signal. In such cases, you may hear noise. —

Playing DTS program material, using the pause, fast forward, or fast reverse function on your player may produce a short audible noise. This is not a malfunction. —

## ■ The beginning of audio received by an HDMI IN can't be heard

Since it takes longer to identify the format of an HDMI signal than it does for other digital audio signals, audio output may not start immediately. —

### Video

## ■ There's no picture

Make sure that all video connecting plugs are pushed in all the way. 16

Make sure that each video component is properly connected. 17, 18

If your TV is connected to the HDMI output(s), select “- - - -” in the “**HDMI Input**” setup to watch composite video, S-Video and component video sources. 45

If the video source is connected to a component video input, you must assign that input to an input selector, and your TV must be connected to either the HDMI output(s) or **COMPONENT VIDEO MONITOR OUT**. 18, 44

If the video source is connected to a composite video input, your TV must be connected to the HDMI output(s) or the corresponding composite video output. 18

If the video source is connected to an HDMI input, you must assign that input to an input selector, and your TV must be connected to the HDMI output(s). 17, 45

While the Pure Audio listening mode is selected, the video circuitry is turned off and only video signals input through HDMI IN can be output. —

On your TV, make sure that the video input to which the AV receiver is connected is selected. —

If the “**Monitor Out**” setting is set to “**Both(Main)**” or “**Both(Sub)**” while your TV is connected to a secondary HDMI output (not a primary HDMI output), the picture may not appear. In this case, change the setting to “**Both**”. —

## ■ There's no picture from a source connected to an HDMI IN

Reliable operation with an HDMI-to-DVI adapter is not guaranteed. In addition, video signals from a PC are not guaranteed. 88

When the resolution is set to any resolution not supported by the TV, no video is output from the HDMI outputs. 45

If the message “**Resolution Error**” appears on the AV receiver's display, this indicates that your TV does not support the current video resolution and you need to select another resolution on your DVD player. —

## ■ The on-screen menus don't appear

On your TV, make sure that the video input to which the AV receiver is connected is selected. —

When the AV receiver is not connected to a TV via HDMI, onscreen menus are not displayed. —

## ■ The on screen display does not appear

Depending on the input signal, the on screen display may not appear when the input signal from the **HDMI IN** is output to a device connected to the **HDMI OUT MAIN**. 57

### Tuner

## ■ Reception is noisy, FM stereo reception is noisy, or the FM STEREO indicator doesn't light

Relocate your antenna. —

Move the AV receiver away from your TV or computer. —

Listen to the station in mono. 28

When listening to an AM station, operating the remote controller may cause noise. —

Passing cars and airplanes can cause interference. —

Concrete walls weaken radio signals. —

If nothing improves the reception, install an outdoor antenna. —

### Remote Controller

## ■ The remote controller doesn't work

Before operating this unit, be sure to press **RECEIVER**. —

Make sure that the batteries are installed with the correct polarity. 4

Install new batteries. Don't mix different types of batteries, or old and new batteries. 4

Make sure that the remote controller is not too far away from the AV receiver, and that there's no obstruction between the remote controller and the AV receiver's remote control sensor. 4

Make sure that the AV receiver is not subjected to direct sunshine or inverter-type fluorescent lights. Relocate if necessary. —

If the AV receiver is installed in a rack or cabinet with colored-glass doors, the remote controller may not work reliably when the doors are closed. —

Make sure you've selected the correct remote controller mode. 11, 70

When using the remote controller to control other manufacturers' AV components, some buttons may not work as expected. —

Make sure you've entered the correct remote control code. 69

Make sure to set the same ID on both the AV receiver and remote controller. 57

## ■ Can't control other components

If it's an Onkyo component, make sure that the **RI** cable and analog audio cable are connected properly. Connecting only an **RI** cable won't be enough. 20

Make sure you've selected the correct remote controller mode. 11, 70

For a proper operation of the remote controller as a cassette tape deck is connected to the **TV/CD IN** jack, or as an **RI Dock** is connected to the **TV/CD IN**, **VCR/DVR IN** or **GAME IN** jacks, you must set the input display accordingly. 41

If you cannot operate it, you will need to enter the appropriate remote control code. 69

To control another manufacturer's component, point the remote controller at that component. **69**

To control an Onkyo component that's connected via **RI**, point the remote controller at the AV receiver. Be sure to enter the appropriate remote control code first. **69**

To control an Onkyo component that's not connected via **RI**, point the remote controller at the component. Be sure to enter the appropriate remote control code first. **70**

The entered remote control code may not be correct. —  
If more than one code is listed, try each one.

## ■ Can't learn commands from another remote controller

When learning commands, make sure that the transmitting ends of both remote controllers are pointing at each other. —

Are you trying to learn from a remote controller that cannot be used for learning? Some commands cannot be learned, especially those that contain several instructions. —

## UP-A1 Dock for iPod/iPhone

### ■ There's no sound

Make sure your iPod/iPhone is actually playing. —

Make sure your iPod/iPhone is properly inserted in the Dock. —

Make sure the UP-A1 Dock is connected to the **UNIVERSAL PORT** jack on the AV receiver. —

Make sure the AV receiver is turned on, the correct input source is selected, and the volume is turned up. —

Make sure the plugs are pushed in all the way. —

Try resetting your iPod/iPhone. —

### ■ There's no video

Make sure that your iPod/iPhone model's TV OUT setting is set to On. —

Make sure the correct input is selected on your TV or the AV receiver. —

Some versions of the iPod/iPhone do not output video. —

### ■ The AV receiver's remote controller doesn't control my iPod/iPhone

Make sure your iPod/iPhone is properly inserted in the Dock. If your iPod/iPhone is in a case, it may not connect properly to the Dock. Always remove your iPod/iPhone from the case before inserting it into the Dock. —

The iPod/iPhone cannot be operated while it's displaying the Apple logo. —

Make sure you've selected the right remote mode. **23**

When you use the AV receiver's remote controller, point it toward your AV receiver. —

When connecting the UP-A1 Dock to the radio tuner UP-HT1 (**North American models**)/UP-DT1 (**European, Australian and Asian models**) with AUTO selected with the tuner's Mode Selector switch, you can switch the input source between the UP-A1 Dock and the tuner, by pressing **PORT** repeatedly on the front panel. —

If you still can't control your iPod/iPhone, start playback by pressing your iPod/iPhone model's Play button. Remote operation should then be possible. —

Try resetting your iPod/iPhone. —

Depending on your iPod/iPhone, some buttons may not work as expected. —

### ■ The AV receiver unexpectedly selects your iPod/iPhone as the input source

Always pause iPod/iPhone playback before selecting a different input source. If playback is not paused, the Direct Change function may select your iPod/iPhone as the input source by mistake during the transition between tracks. —

### ■ iPod/iPhone doesn't work properly

Try reconnecting your iPod/iPhone. —

## Recording

### ■ Can't record

On your recorder, make sure the correct input is selected. —

To prevent signal loops and damage to the AV receiver, input signals are not fed through to outputs with the same name (**VCR/DVR IN** to **VCR/DVR OUT**). —

When the Pure Audio listening mode is selected, recording is not possible because no video signals are output. Select another listening mode. —

## Zone 2

### ■ There's no sound

Only components connected to analog inputs can be played in Zone 2. —

### ■ The Zone 2 speakers produce no sound

Powered Zone 2 cannot be used if "Speakers Type(Front)" is set to "Bi-Amp". **46**

## Music Server and Internet Radio

### ■ Can't access the server or Internet radio

Check the network connection between the AV receiver and your router or switch. —

Make sure that your modem and router are properly connected, and make sure they are both turned on. —

Make sure the server is up and running and compatible with the AV receiver. **89, 91**

Check the "Network" settings. **60**

### ■ Playback stops while listening to music files on the server

Make sure your server is compatible with the AV receiver. **89, 91**

If you download or copy large files on your computer, playback may be interrupted. Try closing any unused programs, use a more powerful computer, or use a dedicated server. —

If the server is serving large music files to several networked devices simultaneously, the network may become overloaded and playback may be interrupted. Reduce the number of playback devices on the network, upgrade your network, or use a switch instead of a hub.

### ■ Can't connect to the AV receiver from a Web browser

If you're using DHCP, your router may not always allocate the same IP address to the AV receiver, so if you find that you can't connect to a server or Internet radio station, recheck the AV receiver's IP address on the "Network" screen.

Check the "Network" settings. 60

## USB Device Playback

### ■ Can't access the music files on a USB device

Make sure the USB device is plugged in properly.

The AV receiver supports USB devices that support the USB mass storage device class. However, playback may not be possible with some USB devices even if they conform to the USB mass storage device class.

USB memory devices with security functions cannot be played.

## Others

### ■ Standby power consumption

In the following cases, the power consumption in standby mode may reach up to a maximum of 60 W: 18, 58, 60

- You are using the Universal Port jack.
- "Network Control" is set to "Enable" in the "Network" setting.
- "HDMI Control(RIHD)" setting is set to "On". (Depending on the TV status, the AV receiver will enter standby mode as usual.)
- The "HDMI Through" setting is set to other than "Off".

### ■ The sound changes when I connect my headphones

When a pair of headphones is connected, the listening mode is set to Stereo, unless it's already set to Stereo, Mono, Direct, or Pure Audio.

### ■ The speaker distance cannot be set as required

In some cases, corrected values suitable for home theater use may be set automatically.

### ■ The display doesn't work

The display is turned off when the Pure Audio listening mode is selected.

### ■ How do I change the language of a multiplex source

Use the "Multiplex" setting on the "Audio Adjust" menu to select "Main" or "Sub". 50

### ■ The RI functions don't work

To use RI, you must make an RI connection and an analog audio connection (RCA) between the component and AV receiver, even if they are connected digitally. 20

### ■ The functions System On/Auto Power On and Direct Change don't work for components connected via RI

These functions don't work when Zone 2 is turned on. 20

### ■ When performing "Automatic Speaker Setup", the measurement fails showing the message "Ambient noise is too high."

This can be caused by a malfunction in your speaker unit. Check if the unit produces normal sounds.

### ■ The following settings can be made for the S-Video and composite video inputs

You must use the buttons on the unit to make these settings.

On the AV receiver, press the input selector for the input source that you want to set and the **SETUP** button simultaneously. While holding down the input selector button, press **SETUP** until "Video ATT:ON" appears on the display. Then, release both buttons. To reactivate the setting, repeat the above process so that "Video ATT:OFF" appears on the display, and release the buttons.

#### • Video Attenuation

This setting can be made for the **BD/DVD, VCR/DVR, CBL/SAT** or **GAME** input.

If you have a game console connected to the composite video input, and the picture isn't very clear, you can attenuate the gain.

**Video ATT:OFF**: (default).

**Video ATT:ON**: Gain is reduced by 2 dB.

■ **If the picture on your TV/monitor connected to the HDMI output(s) is unstable, try switching the DeepColor function off**

To turn off the DeepColor function, simultaneously press the **CBL/SAT** and **ON/STANDBY** buttons on the AV receiver. While holding down **CBL/SAT**, press **ON/STANDBY** until “Off” appears on the display. Then, release both buttons. To reactivate the DeepColor function, repeat the above process until “On” appears on the display and release the buttons.

The AV receiver contains a microcomputer for signal processing and control functions. In very rare situations, severe interference, noise from an external source, or static electricity may cause it to lockup. In the unlikely event that this happens, unplug the power cord from the wall outlet, wait at least five seconds, and then plug it back in.

Onkyo is not responsible for damages (such as CD rental fees) due to unsuccessful recordings caused by the unit’s malfunction. Before you record important data, make sure that the material will be recorded correctly.

Before disconnecting the power cord from the wall outlet, set the AV receiver to standby.

**Important Note Regarding Video Playback**

The AV receiver can upconvert component video, S-Video, and composite video sources for display on a TV connected to the HDMI output(s). However, if the picture quality of the source is poor, upconversion may make the picture worse or disappear altogether.

In this case, try the following:

**1 If the video source is connected to a component video input, connect your TV to the COMPONENT VIDEO MONITOR OUT.**

If the video source is connected to an S-Video input, connect your TV to a **MONITOR OUT S**.

If the video source is connected to a composite video input, connect your TV to the **MONITOR OUT V**.

**2 On the main menu, select “Input/Output Assign” and then “Component Video Input” (→ page 45).**

If the video source is connected to **COMPONENT VIDEO IN 1**, select the relevant input selector, and assign it to “**IN1**”.

If the video source is connected to **COMPONENT VIDEO IN 2**, select the relevant input selector, and assign it to “**IN2**”.

If the video source is connected to an S-Video input or composite video input, select the relevant input selector, and assign it to “- - - -”.

# Firmware Update

To update the firmware of the AV receiver, you can choose from the following two methods: update via network, or update via USB storage. Choose the one that best suits your environment. Before proceeding with the update, please read the corresponding explanations carefully.

## ■ Update via network

You need a wired Internet connection to update the firmware.

## ■ Update via USB storage (→ page 81)

Please prepare a USB storage device such as a USB flash memory stick. You need at least 32 MB of available space to update the firmware.

### Note

- Check the network connection before updating.
- Do not touch the any cable or device connected to the AV receiver during the update process.
- Do not attempt to access the AV receiver from your PC while it is being updated.
- Do not shutdown the power of the AV receiver while it is being updated.
- The storage media in the USB card reader may not work.
- If the USB device is partitioned, each section will be treated as an independent device.
- If the USB device contains a lot of data, the AV receiver may take a while to read it.
- Operation is not guaranteed for all USB devices, which includes the ability to power them.
- Onkyo takes no responsibility whatsoever for the loss or damage of data resulting from the use of a USB device with the AV receiver. Onkyo recommends that you back up your important music files beforehand.
- If you connect a USB hard disk drive to the USB port, Onkyo recommends that you use its AC adapter to power it.
- USB hubs and USB devices with hub functions are not supported. Do not connect your USB device via a USB hub.
- USB devices with security functions are not supported.

### Limitation of liability

The program and accompanying online documentation are furnished to you for use at your own risk. Onkyo will not be liable and you will have no remedy for damages for any claim of any kind whatsoever concerning your use of the program or the accompanying online documentation, regardless of legal theory, and whether arising in tort or contract. In no event will Onkyo be liable to you or any third party for any special, indirect, incidental, or consequential damages of any kind, including, but not limited to, compensation, reimbursement or damages on account of the loss of present or prospective profits, loss of data, or for any other reason whatsoever.

See the Onkyo web site for latest information.

## Updating the Firmware via Network

The AV receiver allows you to update the firmware using network connection on the rear panel.

### Note

- Make sure your AV receiver and TV are turned on and an Ethernet cable is connected to the rear panel of the AV receiver.
- Never unplug or turn off the AV receiver while it is being updated.
- Never plug or unplug an HDMI or Ethernet cable during the update process.
- Do not attempt to access the AV receiver from your PC while it is being updated.
- Never unplug the power cord during the update process.
- It takes maximum 60 minutes to complete the firmware update.
- The AV receiver will retain all your settings after the update is finished.

## Before you start

- Set the “**HDMI Control(RIHD)**” setting to “**Off**” (→ page 58).
- Turn off the controller device connected via Ethernet cable.
- Turn off Zone 2.
- Stop playback of contents from Internet Radio, iPod/iPhone, USB or servers, etc.

## Update procedure

- 1 Press RECEIVER followed by SETUP on the remote controller.**  
The Setup menu will be displayed on the TV screen. The procedures thereafter can also be performed on the AV receiver by using its **SETUP**, arrow and **ENTER** buttons.
- 2 Select “Hardware Setup” and press ENTER.**
- 3 Select “Firmware Update” and press ENTER.**  
Note that the “**Firmware Update**” option will be grayed out for a short while after the AV receiver is turned on. Please wait until it becomes operable.
- 4 Select “via NET” and press ENTER.**
- 5 Select “Update” and press ENTER.**  
The update process will begin.  
During the update process, the on-screen display may disappear depending on the updated program. When this occurs, you can still view the update progress on the front display of the AV receiver. The on-screen display will reappear after the update is complete, and upon turning the AV receiver off and on again.
- 6 The message “Completed!” appears on the front display of the AV receiver, indicating that the update has been completed.**



## 7 Using **ON/STANDBY** on the front panel, turn off and on the AV receiver.

Do not use **RECEIVER** on the remote controller. Congratulations! You now have the latest firmware installed on your Onkyo AV receiver.

## Troubleshooting

### Case 1:

If “**No Update**” is displayed on the front display of the AV receiver, it means that the firmware has already been updated. You do not need to do anything further.

### Case 2:

If an error occurs, “**Error!! \*-\*\* No media**” is displayed on the front display of the AV receiver. (Alpha-numeric characters on the front display are denoted by asterisks.) Refer to the following table and take appropriate action.

### ■ Errors during an update via network

Error Code	Description
*-10, *-20	The Ethernet cable was not detected. Reconnect the cable properly.
*-11, *-13, *-21, *-28	Internet connection error. Check the following items: <ul style="list-style-type: none"><li>• Make sure the IP address, subnet mask, gateway address, and DNS server are configured properly.</li><li>• Make sure the router is turned on.</li><li>• Make sure the AV receiver and the router are connected with an Ethernet cable.</li><li>• Make sure your router is configured properly. See the instruction manual of the router.</li><li>• If your network allows only one client connection and there is any other device already connected, the AV receiver will not be able to access the network. Consult your Internet Service Provider (ISP).</li><li>• If your modem does not function as a router, you will need a router. Depending on your network, you may need to configure the proxy server if necessary. See the document provided by your ISP. If you are still unable to access the Internet, the DNS or proxy server may be temporarily down. Contact your ISP.</li></ul>
Others	Retry the update procedure from the beginning. If the error persists, please contact Onkyo Support (→ <b>page 82</b> ) and provide the error code.

### Case 3:

If an error occurs during the update process, disconnect then reconnect the AC power cord and try again.

### Case 4:

If an error occurs due to a wrong selection of input sources, turn off and on the AV receiver. Then retry the update.

### Case 5:

If you do not have an Internet connection, please contact Onkyo Support (→ **page 82**).

## Updating the Firmware via USB

The AV receiver allows you to update the firmware using a USB device.

### Note

- Never unplug or turn off the AV receiver during the update process.
- Never plug or unplug an HDMI cable or a USB device during the update process.
- Never unplug the USB storage device containing the firmware file or the AC power cord during the update process.
- Do not attempt to access the AV receiver from your PC while it is being updated.
- It takes maximum 60 minutes to complete the firmware update.
- The AV receiver will retain all your settings after the update is finished.

## Before you start

- Set the “**HDMI Control(RIHD)**” setting to “**Off**” (→ **page 58**).
- Turn off the controller device connected via Ethernet cable.
- Turn off Zone 2.
- Stop playback of contents from Internet Radio, iPod/iPhone, USB or servers, etc.
- If there is any data in the USB device, remove it first.

## Update procedure

- 1 Connect a USB device to your PC. If there is any data in the USB device, remove it first.**
- 2 Download the firmware file from the Onkyo web site. The file name is as follows:**  
**ONKAVR\*\*\*\*\_\*\*\*\*\*.zip**  
**Unzip the downloaded file. The following three files are created:**  
**ONKAVR\*\*\*\*\_\*\*\*\*\*.of1**  
**ONKAVR\*\*\*\*\_\*\*\*\*\*.of2**  
**ONKAVR\*\*\*\*\_\*\*\*\*\*.of3**
- 3 Copy the extracted files to the USB device. Be careful not to copy the zip file.**
- 4 Remove the USB device from your PC and connect it to the USB port on the AV receiver.**
- 5 Make sure the AV receiver and TV are turned on.** If the AV receiver is in standby mode, press **ON/STANDBY** on the AV receiver to light up the front display.
- 6 Select the USB input source.** “**Now Initializing**” is displayed on the front display and then the name of the USB device is displayed. It takes 20 to 30 seconds to recognize the USB device.
- 7 Press RECEIVER followed by SETUP on the remote controller.**  
The setup menu will be displayed on the TV screen. The procedures thereafter can also be performed on the AV receiver by using its **SETUP**, arrow and **ENTER** buttons.

**8** Select “Hardware Setup” and press **ENTER**.

**9** Select “Firmware Update” and press **ENTER**.

**10** Select “via USB” and press **ENTER**.

**11** Select “Update” and press **ENTER**.

The update process will begin.

During the update process, the on-screen display may disappear depending on the updated program.

When this occurs, you can still view the update progress on the front display of the AV receiver. The on-screen display will reappear after the update is complete, and upon turning the AV receiver off and on again.

Do not turn off the AV receiver and do not remove the USB device during the update process.

**12** The message “Completed!” appears on the front display of the AV receiver, indicating that the update has been completed.

**13** Using **ON/STANDBY** on the front panel, turn off the AV receiver and then remove the USB device.

Do not use **RECEIVER** on the remote controller. Congratulations! You now have the latest firmware installed on your Onkyo AV receiver.

## Troubleshooting

### Case 1:

If “No Update” is displayed on the front display of the AV receiver, it means that the firmware has already been updated. You do not need to do anything further.

### Case 2:

If an error occurs, “Error!! \*-\* No media” is displayed on the front display of the AV receiver. (Alpha-numeric characters on the front display are denoted by asterisks.)

Refer to the following table and take appropriate action.

#### ■ Errors during an update via USB

Error Code	Description
*-10, *-20	The USB device was not detected. Make sure the USB flash memory or USB cable is properly connected to the USB port. If the USB storage device has its own power supply, use it to power the USB device.
*-14	The firmware file was not found in the root folder of the USB device, or the firmware file is for another model. Retry and download the file on the support page of the web site, following the on-site instructions. If the error persists, please contact Onkyo Support and provide the error code.
Others	Retry the update procedure from the beginning. If the error persists, please contact Onkyo Support and provide the error code.

### Case 3:

If an error occurs during the update, disconnect then reconnect the AC power cord and try again.

### Case 4:

If an error occurs due to a wrong selection of input sources, turn off and on the AV receiver. Then retry the update.

#### ONKYO SOUND & VISION CORPORATION

2-1, Nisshin-cho, Neyagawa-shi, OSAKA 572-8540, JAPAN

##### The Americas

ONKYO U.S.A. CORPORATION  
18 Park Way, Upper Saddle River, N.J. 07458, U.S.A.  
Tel: 800-229-1687, 201-785-2600  
Fax: 201-785-2650  
Hours: M-F 9am-8pm/Sat-Sun 10am-4pm ET  
<<http://www.us.onkyo.com/>>

##### Europe

ONKYO EUROPE ELECTRONICS GmbH  
Liegnitzerstrasse 6, 82194 Groebenzell, GERMANY  
Tel: +49-8142-4401-0 Fax: +49-8142-4401-555  
<<http://www.eu.onkyo.com/>>

##### China, Hong Kong

ONKYO CHINA LIMITED  
Unit 1&12, 9/F, Ever Gain Plaza Tower 1, 88, Container Port Road,  
Kwai Chung, N.T., Hong Kong  
Tel: 852-2429-3118 Fax: 852-2428-9039  
<<http://www.onkyochina.com/>>

##### Asia, Oceania, Middle East, Africa

Please contact an ONKYO distributor referring to Onkyo SUPPORT site.  
<[http://www.intl.onkyo.com/support/local\\_support/index.html](http://www.intl.onkyo.com/support/local_support/index.html)>

# Connection Tips and Video Signal Path

The AV receiver supports several connection formats for compatibility with a wide range of AV equipment. The format you choose will depend on the formats supported by your components. Use the following sections as a guide.

**The on-screen menus appear only on a TV that is connected to the HDMI OUT MAIN. If your TV is connected to other video outputs, use the AV receiver's display when changing settings.**

## Video Connection Formats

Video components can be connected by using any one of the following video connection formats: composite video, S-Video, PC IN (Analog RGB), component video or HDMI, the latter offering the best picture quality.

### Tip

- For optimal video performance, THX recommends that video signals pass through the system without upconversion (e.g., component video input passing through to component video output).

### ■ “Monitor Out” set to “HDMI Main” or “HDMI Sub”

Video input signals flow through the AV receiver as shown, with composite video, S-Video, PC IN (Analog RGB) and component video sources all being upconverted for the HDMI output. Use these settings if you connect either the **HDMI OUT MAIN** or **HDMI OUT SUB** of the AV receiver to your TV.

The composite video, S-Video and component video outputs pass through their respective input signals as they are.

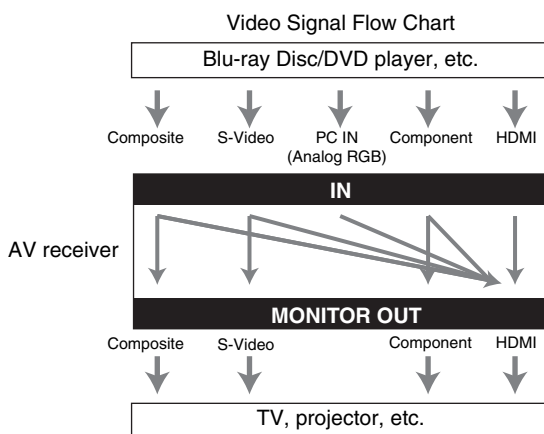

### ■ “Monitor Out” set to “Both”, “Both(Main)” or “Both(Sub)”

Video input signals flow through the AV receiver as shown, with composite video, S-Video, PC IN (Analog RGB) and component video sources all being upconverted for both HDMI outputs. **Use these settings if you connect both the HDMI OUT MAIN and HDMI OUT SUB of the AV receiver to your TV.**

The composite video, S-Video and component video outputs pass through their respective input signals as they are.

- ▶ **Both:** Video signals are output from both HDMI outputs at the resolution supported by both TVs. You cannot select “**Resolution**” setting.
- ▶ **Both(Main):** Video signals are output from both HDMI outputs but **HDMI OUT MAIN** takes priority; depending on the resolution, video signals may not be output from **HDMI OUT SUB**.
- ▶ **Both(Sub):** Video signals are output from both HDMI outputs but **HDMI OUT SUB** takes priority; depending on the resolution, video signals may not be output from **HDMI OUT MAIN**.

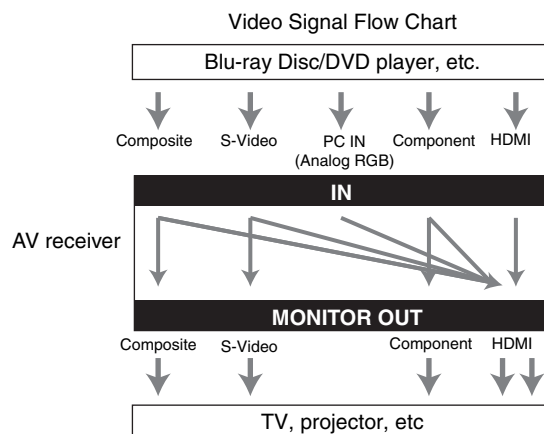

## Audio Connection Formats

Audio components can be connected by using any of the following audio connection formats: analog, analog multichannel, optical, coaxial or HDMI.

When choosing a connection format, bear in mind that the AV receiver does not convert digital input signals for analog line outputs and vice versa. For example, audio signals connected to an optical or coaxial digital input are not output by the analog **VCR/DVR OUT**.

If signals are present at more than one input, the inputs will be selected automatically in the following order of priority: HDMI, digital, analog.

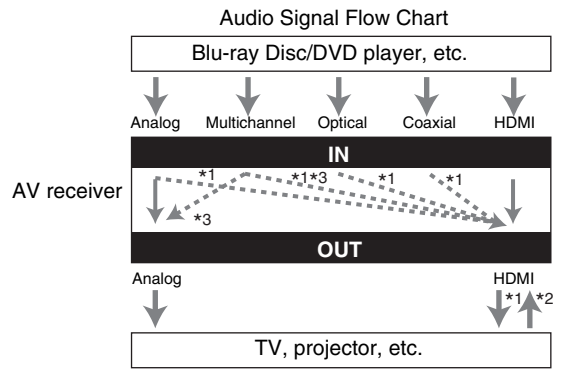

- \*1 Depends on the “**Audio TV Out**” setting (→ **page 59**).
- \*2 This is possible when “**Audio Return Channel**” is set to “**Auto**” (→ **page 59**), the **TV/CD** input selector is selected, and your TV is ARC capable.
- \*3 Only the front L/R channels are output.

## Video Resolution Chart

The following tables show how video signals at different resolutions are output by the AV receiver.

### NTSC/PAL

✓: Output

Input \ Output		HDMI						
		4K*2	1080p/24	1080p	1080i	720p	480p/576p	480i/576i
HDMI	1080p	✓	✓	✓				
	1080i	✓	✓	✓	✓	✓		
	720p	✓	✓	✓	✓	✓		
	480p/576p	✓	✓	✓	✓	✓	✓	
	480i/576i	✓	✓	✓	✓	✓	✓	✓
Component	1080p	✓	✓	✓				
	1080i	✓	✓	✓	✓	✓		
	720p	✓	✓	✓	✓	✓		
	480p/576p	✓	✓	✓	✓	✓	✓	
	480i/576i	✓	✓	✓	✓	✓	✓	✓
S-Video Composite	480i/576i	✓	✓	✓	✓	✓	✓	✓
PC IN (Analog RGB)*1		✓	✓	✓	✓	✓	✓	

Input \ Output		Component					S-Video Composite
		1080p	1080i	720p	480p/576p	480i/576i	480i/576i
HDMI	1080p						
	1080i						
	720p						
	480p/576p						
	480i/576i						
Component	1080p	✓					
	1080i		✓				
	720p			✓			
	480p/576p				✓		
	480i/576i					✓	
S-Video Composite	480i/576i						✓
PC IN (Analog RGB)*1							

\*1 Available resolutions: [640 × 480 60 Hz], [800 × 600 60 Hz], [1024 × 768 60 Hz], [1280 × 1024 60 Hz]

\*2 Available resolutions: [3840 × 2160 24/25/30 Hz]

\* The on-screen menus and superimposed menus are displayed via **HDMI OUT MAIN**.

# Using an RIHD-compatible TV, Player, or Recorder

**RIHD**, which stands for Remote Interactive over HDMI, is the name of the system control function found on Onkyo components. The AV receiver can be used with CEC (Consumer Electronics Control), which allows system control over HDMI and is part of the HDMI standard. CEC provides interoperability between various components, however, operation with components other than **RIHD**-compatible components cannot be guaranteed.

## About RIHD-compatible components

The following components are **RIHD**-compatible (as of January 2011).

### ■ TV

- Toshiba REGZA-LINK compatible TV
- Sharp TV

### ■ Players/Recorders

- Onkyo and Integra **RIHD**-compatible players
- Toshiba REGZA-LINK compatible players and recorders (only when used together with Toshiba REGZA-LINK compatible TV)
- Sharp players and recorders (only when used together with Sharp TV)

\* Models other than those mentioned above may have some interoperability if compatible with CEC, which is part of the HDMI Standard, but operation cannot be guaranteed.

### Note

- For proper linked operations, do not connect more **RIHD**-compatible components than the quantities specified below, to the HDMI input terminal.
  - Blu-ray Disc/DVD players: up to three.
  - Blu-ray Disc/DVD recorders/Digital Video Recorders: up to three.
  - Cable/Satellite Set-top boxes: up to four.
- Do not connect the AV receiver to the other AV receiver/AV amplifier via HDMI.
- Proper linked operations are not guaranteed when more **RIHD**-compatible components than the above-mentioned quantities are connected.

## Operations that can be performed with RIHD connection

### ■ For RIHD-compatible TV

The following linked operations are enabled by connecting the AV receiver to an **RIHD**-compatible TV.

- The AV receiver will enter standby mode when the power of the TV is turned to standby.
- You can set on the menu screen of the TV to either output the audio from the speakers connected to the AV receiver, or from the speakers of the TV.
- It is possible to output the video/audio coming from the antenna or from the input jack of the TV from the speakers connected to the AV receiver. (A connection such as optical digital cable or similar is required above the HDMI cable.)
- Input to the AV receiver can be selected with the remote controller of the TV.
- Operations such as volume adjustment or similar for the AV receiver can be performed from the remote controller of the TV.

### ■ For RIHD-compatible players/recorders

The following linked operations are enabled by connecting the AV receiver to an **RIHD**-compatible player/recorder.

- When the playback is started on the player/recorder, input of the AV receiver will switch to the HDMI input of the player/recorder that is playing back.
- Operation of the player/recorder is possible using the remote controller supplied with the AV receiver.

\* Depending on the model used, not all operations may be available.

## ■ How to connect and setup

### 1 Confirm the connecting and setting.

1. Connect the **HDMI OUT MAIN** jack to the HDMI input jack of the TV.

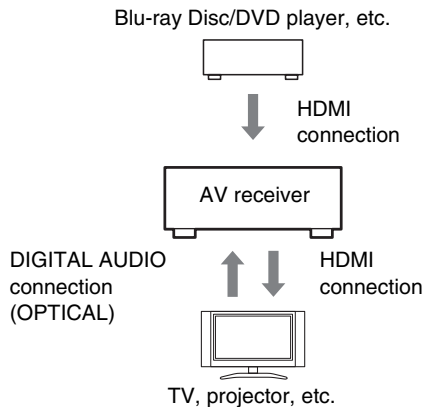

2. Connect the audio output from the TV to the **OPTICAL IN 2** jack of the AV receiver using an optical digital cable.

#### Note

- When the audio return channel (ARC) function is used with an ARC capable TV, this connection is not necessary (→ [page 59](#)).
3. Connect the HDMI output of the Blu-ray Disc/DVD player/recorder to the **HDMI IN 1** jack of the AV receiver.

#### Note

- It is necessary to assign the HDMI input when connecting the Blu-ray Disc/DVD player/recorder to other jacks (→ [page 45](#)). Do not assign the components connected to the HDMI IN to the TV/CD input at this time. Appropriate CEC (Consumer Electronics Control) operation can not be guaranteed.

### 2 Change each item in the “HDMI” menu according to the following settings:

- **HDMI Control(RIHD): On**
- **Audio Return Channel (ARC): Auto**

See details of each setting (→ [pages 58, 59](#)).

### 3 Confirm the settings.

1. Turn on the power for all connected components.
2. Turn off the power of the TV, and confirm that the power of the connected components is turned off automatically with the link operation.
3. Turn on the power of the Blu-ray Disc/DVD player/recorder.
4. Start playback on the Blu-ray Disc/DVD player/recorder, and verify the following.
  - The AV receiver automatically turns on, and selects the input to which the Blu-ray Disc/DVD player/recorder is connected.
  - The TV automatically turns on, and selects the input to which the AV receiver is connected.
5. Following the operating instructions of the TV, select “Use the TV speakers” from the menu screen of the TV, and confirm that the audio is output from the speakers of the TV, and not from the speakers connected to the AV receiver.
6. Select “Use the speakers connected from the AV receiver” from the menu screen of the TV, and confirm that the audio is output from the speakers connected to the AV receiver, and not from the TV speakers.

#### Note

- Perform the above operations when you use the AV receiver for the first time, when the settings of each component are changed, when the main power of each component is turned off, when the power cable is disconnected from the power supply, or when there has been a power outage.

### 4 Operate with the remote controller.

For buttons that can be operated (→ [page 70](#)).

#### Note

- Audio from DVD-Audio or Super Audio CD may not output from the TV speakers. You will be able to output the audio from the TV speakers by setting the audio output of the DVD player to 2ch PCM. (It may not be possible depending on the player models.)
- Even if you set to output audio on the TV speakers, audio will be output from the speakers connected to the AV receiver when you adjust the volume or switch the input on the AV receiver. To output audio from the TV speakers, redo the operations on the TV.
- In case of an **RIHD** connection with **RI** and **RI** audio control compatible components, do not connect the RI cable at the same time.
- On the TV, when you select anything other than the HDMI jack to which the AV receiver is connected, the input on the AV receiver will be switched to “**TV/CD**”.
- The AV receiver will automatically power on in conjunction when it determines it to be necessary. Even if the AV receiver is connected to an **RIHD** compatible TV or player/recorder, it will not power on if it is not necessary. It may not power on in conjunction when the TV is set to output audio from the TV.
- Linked functions with the AV receiver may not work depending on the component model connected. In such cases, operate the AV receiver directly.

# About HDMI

Designed to meet the increased demands of digital TV, HDMI (High Definition Multimedia Interface) is a new digital interface standard for connecting TVs, projectors, Blu-ray Disc/DVD players, set-top boxes, and other video components. Until now, several separate video and audio cables have been required to connect AV components. With HDMI, a single cable can carry control signals, digital video, and up to eight channels of digital audio (2-channel PCM, multichannel digital audio, and multichannel PCM).

The HDMI video stream (i.e., video signal) is compatible with DVI (Digital Visual Interface)\*1, so TVs and displays with a DVI input can be connected by using an HDMI-to-DVI adapter cable. (This may not work with some TVs and displays, resulting in no picture.)

The AV receiver uses HDCP (High-bandwidth Digital Content Protection)\*2, so only HDCP-compatible components can display the picture.

The AV receiver's HDMI interface is based on the following:

Audio Return Channel, 3D, x.v.Color, DeepColor, Lip Sync, DTS-HD Master Audio, DTS-HD High Resolution Audio, Dolby TrueHD, Dolby Digital Plus, DSD and Multichannel PCM.

## Supported Audio Formats

- 2-channel linear PCM (32–192 kHz, 16/20/24 bit)
- Multichannel linear PCM (up to 7.1 ch, 32–192 kHz, 16/20/24 bit)
- Bitstream (DSD, Dolby Digital, Dolby Digital Plus, Dolby TrueHD, DTS, DTS-HD High Resolution Audio, DTS-HD Master Audio)

Your Blu-ray Disc/DVD player must also support HDMI output of the above audio formats.

## About Copyright Protection

The AV receiver supports HDCP (High-bandwidth Digital Content Protection)\*2, a copy-protection system for digital video signals. Other devices connected to the AV receiver via HDMI must also support HDCP.

\*1 DVI (Digital Visual Interface): The digital display interface standard set by the DDWG\*3 in 1999.

\*2 HDCP (High-bandwidth Digital Content Protection): The video encryption technology developed by Intel for HDMI/DVI. It's designed to protect video content and requires a HDCP-compatible device to display the encrypted video.

\*3 DDWG (Digital Display Working Group): Led by Intel, Compaq, Fujitsu, Hewlett Packard, IBM, NEC, and Silicon Image, this open industry group's objective is to address the industry's requirements for a digital connectivity specification for high-performance PCs and digital displays.

### Note

- The HDMI video stream is compatible with DVI (Digital Visual Interface), so TVs and displays with a DVI input can be connected by using an HDMI-to-DVI adapter cable. (Note that DVI connections only carry video, so you'll need to make a separate connection for audio.) However, reliable operation with such an adapter is not guaranteed. In addition, video signals from a PC are not supported.
- The HDMI audio signal (sampling rate, bit length, etc.) may be restricted by the connected source component. If the picture is poor or there's no sound from a component connected via HDMI, check its setup. Refer to the connected component's instruction manual for details.



# Network/USB Features

## Connecting to the Network

The following diagram shows how you can connect the AV receiver to your home network. In this example, it's connected to a LAN port on a router, which has a 4-port 100Base-TX switch built-in.

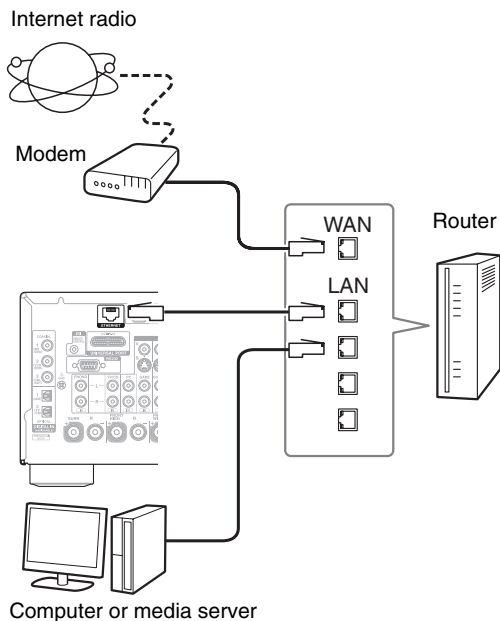

## Network Requirements

### ■ Ethernet Network

For the best results, a 100Base-TX switched Ethernet network is recommended. Although it's possible to play music on a computer that's connected to the network wirelessly, playback may be unreliable, so it is recommended to use wired connections.

### ■ Ethernet Router

A router manages the network, data-routing and supplying of IP addresses. Your router must support the following:

- NAT (Network Address Translation). NAT allows several networked computers to access the Internet simultaneously via a single Internet connection. The AV receiver needs Internet access for Internet radio.
- DHCP (Dynamic Host Configuration Protocol). DHCP supplies IP addresses to the network devices, allowing them to configure themselves automatically.
- A router with a built-in 100Base-TX switch is recommended.

Some routers have a built-in modem, and some ISPs require you to use specific routers. Please consult your ISP or computer dealer if you're unsure.

### ■ CAT5 Ethernet cable

Use a shielded CAT5 Ethernet cable (straight-type) to connect the AV receiver to your home network.

### ■ Internet Access (for Internet radio)

To receive Internet radio, your Ethernet network must have Internet access. A narrowband Internet connection (e.g., 56K modem, ISDN) will not provide satisfactory results, so a broadband connection is strongly recommended (e.g., cable modem, xDSL modem, etc). Please consult your ISP or computer dealer if you're unsure.

### Note

- To receive Internet radio with the AV receiver, your broadband Internet connection must be working and able to access the Web. Consult your ISP if you have any problems with your Internet connection.
- The AV receiver uses DHCP to configure its network settings automatically. If you want to configure these settings manually, see "Network" (→ **page 60**).
- The AV receiver does not support PPPoE settings, so if you have a PPPoE-type Internet connection, you must use a PPPoE-compatible router.
- Depending on your ISP, you may need to specify a proxy server to use Internet radio. If your computer is configured to use a proxy server, use the same settings for the AV receiver (→ **page 60**).

## Server Requirements

### ■ Server playback

The AV receiver can play digital music files stored on a computer or media server and supports the following technologies:

- Windows Media Player 11
- Windows Media Player 12
- Windows Media Connect 2.0
- DLNA-certified media server

If the operating system of your computer is Windows Vista, Windows Media Player 11 is already installed. Windows Media Player 11 for Windows XP can be downloaded for free from the Microsoft web site.

- The computer or media server must be on the same network as the AV receiver.
- Each folder may contain up to 20000 music files, and folders may be nested up to 16 levels deep.

### Note

- Depending on the media server, the AV receiver may not recognize it, or may not be able to play its music files.

### Minimum system requirements for Windows Media Player 11 on Windows XP

#### Operating system

Windows XP Home Edition (SP2), Windows XP Professional (SP2), Windows XP Tablet PC Edition (SP2), Update Rollup 2 for Windows XP Media Center Edition 2005 (KB900325), October 2006 Update Rollup for Windows XP Media Center Edition (KB925766)

**Processor:** 233 MHz Intel Pentium II, Advanced Micro Devices (AMD), etc.

**Memory:** 64 MB

**Hard disk:** 200 MB of free space

**Drive:** CD or DVD drive

**Modem:** 28.8 kbps

**Sound card:** 16-bit sound card

**Monitor:** Super VGA (800 x 600)

**Video card:** 64 MB VRAM, DirectX 9.0b

**Software:** Microsoft ActiveSync (only when using a Windows Mobile-based Pocket PC or smartphone)

**Web browser:** Microsoft Internet Explorer 6 or Netscape 7.1

### ■ Remote playback

- Windows Media Player 12
- DLNA-certified (within DLNA Interoperability Guidelines version 1.5) media server or controller device.

Setting varies depending on the device. Refer to your device's instruction manual for details.

If the operating system of your personal computer is Windows 7, Windows Media Player 12 is already installed. For more information, see the Microsoft web site.

## USB Device Requirements

- USB mass storage device class (but not always guaranteed).
- FAT16 or FAT32 file system format.
- If the storage device has been partitioned, each section will be treated as an independent device.
- Each folder may contain up to 20,000 music files and folders, and folders may be nested up to 16 levels deep.
- USB hubs and USB devices with hub functions are not supported.

### Note

- If the media you connect is not supported, the message “**No Storage**” will appear on the display.
- If you connect a USB hard disk drive to the AV receiver's **USB** port, we recommend that you use its AC adapter to power it.
- The AV receiver supports USB MP3 players that support the USB Mass Storage Class standard, which allows USB devices to be connected to computers without the need for special drivers or software. Note that not all USB MP3 players support the USB Mass Storage Class standard. Refer to your USB MP3 player's instruction manual for details.
- Protected WMA music files on an MP3 player cannot be played.
- Onkyo accepts no responsibility whatsoever for the loss or damage to data stored on a USB device when that device is used with the AV receiver. We recommend that you back up your important music files beforehand.
- MP3 players containing music files that are managed with special music software are not supported.
- Operation is not guaranteed for all USB devices, which includes the ability to power them.
- Do not connect your USB device via a USB hub. The USB device must be connected directly to the AV receiver's **USB** port.
- If the USB device contains a lot of data, the AV receiver may take a while to read it.
- USB devices with security functions cannot be played.

## Supported Audio File Formats

For server playback and playback from a USB device, the AV receiver supports the following music file formats.

Variable bit-rate (VBR) files are supported. However, playback time may not be displayed correctly.

### Note

- With remote playback, the AV receiver does not support the following music file formats: FLAC and Ogg Vorbis.
- In the case of server playback, the below-mentioned file formats may not be played depending on the server type.

### ■ MP3 (.mp3 or .MP3)

- MP3 files must be MPEG-1/MPEG-2 Audio Layer 3 format with a sampling rate of 8 kHz, 11.025 kHz, 12 kHz, 16 kHz, 22.05 kHz, 24 kHz, 32 kHz, 44.1 kHz, 48 kHz and bitrates of between 8 kbps and 320 kbps. Incompatible files cannot be played.

### ■ WMA (.wma or .WMA)

WMA stands for Windows Media Audio and is an audio compression technology developed by Microsoft Corporation. Audio can be encoded in WMA format by using Windows Media® Player.

- WMA files must have the copyright option turned off.
- Sampling rates of 8 kHz, 11.025 kHz, 12 kHz, 16 kHz, 22.05 kHz, 24 kHz, 32 kHz, 44.1 kHz, 48 kHz, bitrates of between 5 kbps and 320 kbps, and WMA DRM are supported.
- WMA Pro/Voice formats are not supported.

### ■ WMA Lossless (.wma or .WMA)

- Sampling rates of 44.1 kHz, 48 kHz, 88.2 kHz, 96 kHz are supported.
- Quantization bit: 16 bit, 24 bit

### ■ WAV (.wav or .WAV)

WAV files contain uncompressed PCM digital audio.

- Sampling rates of 8 kHz, 11.025 kHz, 12 kHz, 16 kHz, 22.05 kHz, 24 kHz, 32 kHz, 44.1 kHz, 48 kHz, 64 kHz, 88.2 kHz, and 96 kHz are supported.
- Quantization bit: 8 bit, 16 bit, 24 bit

### ■ AAC

(.aac/.m4a/.mp4/.3gp/.3g2/.AAC/.M4A/.MP4/.3GP or .3G2)

AAC stands for MPEG-2/MPEG-4 Audio.

- Sampling rates of 8 kHz, 11.025 kHz, 12 kHz, 16 kHz, 22.05 kHz, 24 kHz, 32 kHz, 44.1 kHz, 48 kHz, 64 kHz, 88.2 kHz, 96 kHz and bitrates of between 8 kbps and 320 kbps are supported.

### ■ FLAC (.flac or .FLAC)

FLAC is a file format for lossless audio data compression.

- Sampling rates of 8 kHz, 11.025 kHz, 12 kHz, 16 kHz, 22.05 kHz, 24 kHz, 32 kHz, 44.1 kHz, 48 kHz, 64 kHz, 88.2 kHz, and 96 kHz are supported.
- Quantization bit: 8 bit, 16 bit, 24 bit

### ■ Ogg Vorbis (.ogg or .OGG)

- Sampling rates of 8 kHz, 11.025 kHz, 12 kHz, 16 kHz, 22.05 kHz, 24 kHz, 32 kHz, 44.1 kHz, 48 kHz and bitrates of between 48 kbps and 500 kbps are supported. Incompatible files cannot be played.

### ■ LPCM (Linear PCM)

- Sampling rates of 8 kHz, 11.025 kHz, 12 kHz, 16 kHz, 22.05 kHz, 24 kHz, 32 kHz, 44.1 kHz, 48 kHz, 64 kHz, 88.2 kHz, and 96 kHz are supported.
- Quantization bit: 8 bit, 16 bit, 24 bit
- \* Only for playback via network.

## About DLNA

The Digital Living Network Alliance is an international, cross-industry collaboration. Members of DLNA develop a concept of wired and wireless interoperable networks where digital content such as photos, music, and videos can be shared through consumer electronics, personal computers, and mobile devices in and beyond the home. The AV receiver complies with the DLNA Interoperability Guidelines version 1.5.

# Specifications

## Amplifier Section

### Rated Output Power

All channels: (North American)  
110 watts minimum continuous power per channel, 8 ohm loads, 2 channels driven from 20 Hz to 20 kHz, with a maximum total harmonic distortion of 0.08% (FTC)  
130 watts minimum continuous power per channel, 6 ohm loads, 2 channels driven at 1 kHz, with a maximum total harmonic distortion of 0.1% (FTC)  
120 watts minimum continuous power per channel, 8 ohm loads, 2 channels driven at 1 kHz, with a maximum total harmonic distortion of 0.7% (FTC)  
(Others)  
7 ch x 170 W at 6 ohms, 1 kHz, 1 ch driven of 1% (IEC)

### Maximum Effective Output Power

(Asian)  
7 ch x 185 W at 6 ohms, 1 kHz, 1 ch driven (JEITA)

### Dynamic Power\*

\* IEC60268-Short-term maximum output power

250 W (3 Ω, Front)  
220 W (4 Ω, Front)  
130 W (8 Ω, Front)

### THD+N (Total Harmonic Distortion+Noise)

0.08% (20 Hz - 20 kHz, half power)

### Damping Factor

60 (Front, 1 kHz, 8 Ω)

### Input Sensitivity and Impedance (Unbalance)

200 mV/47 kΩ (LINE)  
2.5 mV/47 kΩ (PHONO MM)

### Rated RCA Output Level and Impedance

200 mV/470 Ω (PRE OUT)

### Maximum RCA Output Level and Impedance

4.6 V/470 Ω (PRE OUT)

### Phono Overload

70 mV (MM 1 kHz 0.5%)

### Frequency Response

5 Hz - 100 kHz/+1 dB, -3 dB (Direct mode)

### Tone Control Characteristics

±10 dB, 50 Hz (BASS)  
±10 dB, 20 kHz (TREBLE)

### Signal to Noise Ratio

106 dB (LINE, IHF-A)

80 dB (PHONO, IHF-A)

### Speaker Impedance

4 or 6 Ω - 16 Ω

## Video Section

### Input Sensitivity/Output Level and Impedance

1 V<sub>p-p</sub>/75 Ω (Component and S-Video Y)  
0.7 V<sub>p-p</sub>/75 Ω (Component Pb/Cb, Pr/Cr)  
0.25 V<sub>p-p</sub>/75 Ω (S-Video C)  
1 V<sub>p-p</sub>/75 Ω (Composite)

### Component Video Frequency Response

5 Hz - 100 MHz/+0 dB, -3 dB

## Tuner Section

### FM Tuning Frequency Range

(North American and Taiwan)  
87.5 MHz - 107.9 MHz  
(Others)  
87.5 MHz - 108.0 MHz, RDS

### AM Tuning Frequency Range

522/530 kHz - 1611/1710 kHz

### Preset Channel

40

## General

### Power Supply

(North American and Taiwan)  
AC 120 V, 60 Hz  
(Others)  
AC 220 - 240 V, 50/60 Hz

### Power Consumption

(North American) 6.3 A  
(Others) 640 W

### Stand-by Power Consumption

(North American and Taiwan)  
0.2 W  
(Others)  
0.3 W

### Dimensions (W x H x D)

435 mm x 174 mm x 379 mm  
17-1/8" x 6-7/8" x 14-15/16"

### Weight

12.2 kg (26.9 lbs.)

## HDMI

### Input

IN 1, IN 2, IN 3, IN 4, IN 5, IN 6, IN 7, AUX INPUT

### Output

OUT MAIN, OUT SUB

### Video Resolution

1080p

### Audio Format

Dolby TrueHD, DTS-HD Master Audio, DVD-Audio, DSD

### Supported

3D, Audio Return Channel, DeepColor, x.v.Color, LipSync, CEC (RIHD)

## Video Inputs

### Component

IN 1, IN 2

### S-Video

BD/DVD, VCR/DVR, CBL/SAT, GAME

### Composite

BD/DVD, VCR/DVR, CBL/SAT, GAME, AUX

### Analog RGB

PC IN

## Video Outputs

### Component

MONITOR OUT

### S-Video

MONITOR OUT, VCR/DVR OUT

### Composite

MONITOR OUT, VCR/DVR OUT

## Audio Inputs

### Digital

Optical: 2  
Coaxial: 3

### Analog

BD/DVD, VCR/DVR, CBL/SAT, GAME, PC, TV/CD, PHONO

### Multichannel Inputs

7.1

## ■ Audio Outputs

**Analog** VCR/DVR, ZONE2 LINE OUT

**Analog Multichannel Pre Outputs**

7

**Subwoofer Pre Outputs**

2

**Speaker Outputs** Main (L, R, C, SL, SR, SBL, SBR) + Front  
Wide/ZONE2 (L, R) + Front High (L, R)

**Phones** 1 (6.3  $\phi$ )

## ■ Others

**Setup Mic** 1

**RS232** 1

**Universal Port** 1

**RI** 1

**USB** 1 (Front)

**Ethernet** 1

**IR Input** 1

**12 V Trigger Out** 1

Specifications and features are subject to change  
without notice.

# Memo

---

---

# Memo

---

---



# ONKYO®

ONKYO SOUND & VISION CORPORATION  
2-1, Nisshin-cho, Neyagawa-shi, OSAKA 572-8540, JAPAN  
Tel: 072-831-8023 Fax: 072-831-8163  
<http://www.onkyo.com/>

ONKYO U.S.A. CORPORATION  
18 Park Way, Upper Saddle River, N.J. 07458, U.S.A.  
Tel: 800-229-1687, 201-785-2600 Fax: 201-785-2650  
<http://www.us.onkyo.com/>

ONKYO EUROPE ELECTRONICS GmbH  
Liegnitzerstrasse 6, 82194 Groebenzell, GERMANY  
Tel: +49-8142-4401-0 Fax: +49-8142-4401-555  
<http://www.eu.onkyo.com/>

ONKYO EUROPE ELECTRONICS GmbH (UK BRANCH)  
The Coach House 81A High Street, Marlow, Buckinghamshire, SL7 1AB, UK  
Tel: +44-(0)1628-473-350 Fax: +44-(0)1628-401-700

ONKYO CHINA LIMITED  
Unit 1 & 12, 9/F, Ever Gain Plaza Tower 1, 88, Container Port Road, Kwai Chung,  
N.T., Hong Kong. Tel: 852-2429-3118 Fax: 852-2428-9039  
<http://www.ch.onkyo.com/>

ONKYO CHINA PRC  
1301, 555 Tower, No.555 West NanJin Road, Jin an, Shanghai,  
China 200041, Tel: 86-21-52131366 Fax: 86-21-52130396

Y1102-1

SN 29400698

(C) Copyright 2011 ONKYO SOUND & VISION CORPORATION Japan. All rights reserved.



Download from [www.Somanuals.com](http://www.Somanuals.com). All Manuals Search And Download.

\* 2 9 4 0 0 6 9 8 \*



## Free Manuals Download Website

<http://myh66.com>

<http://usermanuals.us>

<http://www.somanuals.com>

<http://www.4manuals.cc>

<http://www.manual-lib.com>

<http://www.404manual.com>

<http://www.luxmanual.com>

<http://aubethermostatmanual.com>

Golf course search by state

<http://golfingnear.com>

Email search by domain

<http://emailbydomain.com>

Auto manuals search

<http://auto.somanuals.com>

TV manuals search

<http://tv.somanuals.com>