

ONKYO®

AV Receiver

TX-SR403

Instruction Manual

Thank you for purchasing an Onkyo AV Receiver. Please read this manual thoroughly before making connections and plugging in the unit. Following the instructions in this manual will enable you to obtain optimum performance and listening enjoyment from your new AV Receiver. Please retain this manual for future reference.

Contents

Introduction 2

Connection 15

Turning On & First Time Setup..... 30

Basic Operation

Playing your AV components 34

Using the Tuner..... 36

Enjoying the Listening Modes 40

Advanced Operation 44

Troubleshooting 50

Specification 53



WARNING:

TO REDUCE THE RISK OF FIRE OR ELECTRIC SHOCK, DO NOT EXPOSE THIS APPARATUS TO RAIN OR MOISTURE.

CAUTION:

TO REDUCE THE RISK OF ELECTRIC SHOCK, DO NOT REMOVE COVER (OR BACK). NO USER-SERVICEABLE PARTS INSIDE. REFER SERVICING TO QUALIFIED SERVICE PERSONNEL.



WARNING
RISK OF ELECTRIC SHOCK
DO NOT OPEN

AVIS
RISQUE DE CHOC ELECTRIQUE
NE PAS OUVRIR



The lightning flash with arrowhead symbol, within an equilateral triangle, is intended to alert the user to the presence of uninsulated "dangerous voltage" within the product's enclosure that may be of sufficient magnitude to constitute a risk of electric shock to persons.



The exclamation point within an equilateral triangle is intended to alert the user to the presence of important operating and maintenance (servicing) instructions in the literature accompanying the appliance.

Important Safety Instructions

1. Read these instructions.
2. Keep these instructions.
3. Heed all warnings.
4. Follow all instructions.
5. Do not use this apparatus near water.
6. Clean only with dry cloth.
7. Do not block any ventilation openings. Install in accordance with the manufacturer's instructions.
8. Do not install near any heat sources such as radiators, heat registers, stoves, or other apparatus (including amplifiers) that produce heat.
9. Do not defeat the safety purpose of the polarized or grounding-type plug. A polarized plug has two blades with one wider than the other. A grounding type plug has two blades and a third grounding prong. The wide blade or the third prong are provided for your safety. If the provided plug does not fit into your outlet, consult an electrician for replacement of the obsolete outlet.
10. Protect the power cord from being walked on or pinched particularly at plugs, convenience receptacles, and the point where they exit from the apparatus.
11. Only use attachments/accessories specified by the manufacturer.
12. Use only with the cart, stand, tripod, bracket, or table specified by the manufacturer, or sold with the apparatus. When a cart is used, use caution when moving the cart/apparatus combination to avoid injury from tip-over.

PORTABLE CART WARNING
S3125A
13. Unplug this apparatus during lightning storms or when unused for long periods of time.
14. Refer all servicing to qualified service personnel. Servicing is required when the apparatus has been damaged in any way, such as power-supply cord or plug is damaged, liquid has been spilled or objects have fallen into the apparatus, the apparatus has been exposed to rain or moisture, does not operate normally, or has been dropped.
15. Damage Requiring Service
Unplug the apparatus from the wall outlet and refer servicing to qualified service personnel under the following conditions:
 - A. When the power-supply cord or plug is damaged,
 - B. If liquid has been spilled, or objects have fallen into the apparatus,
 - C. If the apparatus has been exposed to rain or water,
 - D. If the apparatus does not operate normally by following the operating instructions. Adjust only those controls that are covered by the operating instructions as an improper adjustment of other controls may result in damage and will often require extensive work by a qualified technician to restore the apparatus to its normal operation,
 - E. If the apparatus has been dropped or damaged in any way, and
 - F. When the apparatus exhibits a distinct change in performance this indicates a need for service.
16. Object and Liquid Entry
Never push objects of any kind into the apparatus through openings as they may touch dangerous voltage points or short-out parts that could result in a fire or electric shock.
The apparatus shall not be exposed to dripping or splashing and no objects filled with liquids, such as vases shall be placed on the apparatus.
Don't put candles or other burning objects on top of this unit.
17. Batteries
Always consider the environmental issues and follow local regulations when disposing of batteries.
18. If you install the apparatus in a built-in installation, such as a bookcase or rack, ensure that there is adequate ventilation.
Leave 20 cm (8") of free space at the top and sides and 10 cm (4") at the rear. The rear edge of the shelf or board above the apparatus shall be set 10 cm (4") away from the rear panel or wall, creating a flue-like gap for warm air to escape.

Precautions

1. **Recording Copyright**—Unless it's for personal use only, recording copyrighted material is illegal without the permission of the copyright holder.
2. **AC Fuse**—The AC fuse inside the unit is not user-serviceable. If you cannot turn on the unit, contact your Onkyo dealer.
3. **Care**—Occasionally you should dust the unit all over with a soft cloth. For stubborn stains, use a soft cloth dampened with a weak solution of mild detergent and water. Dry the unit immediately afterwards with a clean cloth. Don't use abrasive cloths, thinners, alcohol, or other chemical solvents, because they may damage the finish or remove the panel lettering.

4. Power

WARNING

BEFORE PLUGGING IN THE UNIT FOR THE FIRST TIME, READ THE FOLLOWING SECTION CAREFULLY.

AC outlet voltages vary from country to country. Make sure that the voltage in your area meets the voltage requirements printed on the unit's rear panel (e.g., AC 230 V, 50 Hz or AC 120 V, 60 Hz).

Some models have a voltage selector switch for compatibility with power systems around the world. Before you plug in such a model, make sure that the voltage selector is set to the correct voltage for your area.

Setting the [STANDBY/ON] switch to STANDBY does not fully shutdown the unit. If you do not intend to use the unit for an extended period, remove the power cord from the AC outlet.

5. **Never Touch this Unit with Wet Hands**—Never handle this unit or its power cord while your hands are wet or damp. If water or any other liquid gets inside this unit, have it checked by your Onkyo dealer.
6. **Handling Notes**
 - If you need to transport this unit, use the original packaging to pack it how it was when you originally bought it.
 - Do not leave rubber or plastic items on this unit for a long time, because they may leave marks on the case.
 - This unit's top and rear panels may get warm after prolonged use. This is normal.
 - If you do not use this unit for a long time, it may not work properly the next time you turn it on, so be sure to use it occasionally.

Memory Backup

The AV receiver uses a battery-less memory backup system in order to retain radio presets and other settings when it's unplugged or in the case of a power failure. Although no batteries are required, the AV receiver must be plugged into an AC outlet in order to charge the backup system. Once it has been charged, the AV receiver will retain the settings for several weeks, although this depends on the environment and will be shorter in humid climates.

Supplied Accessories

Make sure you have the following accessories:

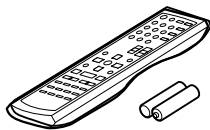

Remote controller & two batteries (AA/R6)

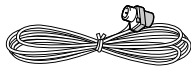

Indoor FM antenna



AM loop antenna

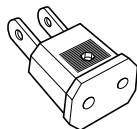

Power-plug adapter

Only supplied in certain countries. Use this adapter if your AC outlet does not match with the plug on the AV receiver's power cord. (Adapter varies from country to country.)

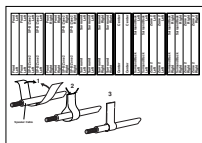

Speaker cable labels

* In catalogs and on packaging, the letter at the end of the product name indicates the color. Specifications and operation are the same regardless of color.

Features

Amp

- 6-channel amplifier
- 110 W (6Ω, 1 kHz, JEITA)
- WRAT (Wide Range Amplifier Technology)
- Optimum gain volume circuitry

Processing

- Dolby¹ Digital EX and Dolby Pro Logic IIx
- DTS, DTS-ES Matrix/Discrete, and DTS Neo:6 processing²
- Cinema Filter function
- Linear PCM 192 kHz/24-bit D/A converters on all channels
- Powerful and highly accurate 32-bit DSP Processing

Audio/Video

- Adjustable crossover (60, 80, 100, 120, 150 Hz)
- 3 S-Video inputs, 2 outputs
- 2 assignable digital inputs (1 optical, 1 coaxial)
- Subwoofer pre out
- Color-coded multichannel input for use with Super Audio CD and DVD-Audio
- A/B speaker drive
- Color-coded speaker terminal posts

FM/AM Tuner

- 30 FM/AM presets
- FM/AM auto tuning
- RDS (Radio Data System) (Europe only)

Remote Controller

- Remote controller can be used to control Onkyo CD, CDR, MD components, and cassette tape deck

Table of Contents

Introduction

Important Safety Instructions	2
Precautions	3
Supplied Accessories	4
Features	5
Front & Rear Panels	6
Before Using the AV receiver	9
Remote Controller	10

Connection

Connecting Your Speakers	15
Connecting Antenna	18
Connecting Your Components	20

Turning On & First Time Setup

Turning On	30
First Time Setup	31

Basic Operation

Playing Your AV Components	34
Using the Tuner	36
Common Functions	38

Enjoying the Listening Modes

Using the Listening Modes	40
----------------------------------------	-----------

Advanced Operation

Adjusting the Listening Modes	44
Recording	46
Advanced Setup	47

Troubleshooting

Specification.....

1. Manufactured under license from Dolby Laboratories. “Dolby”, “Pro Logic” and the double-D symbol are registered trademarks of Dolby Laboratories.
2. “DTS,” “DTS-ES,” and “Neo:6” are trademarks of Digital Theater Systems, Inc.

Front & Rear Panels

Front Panel

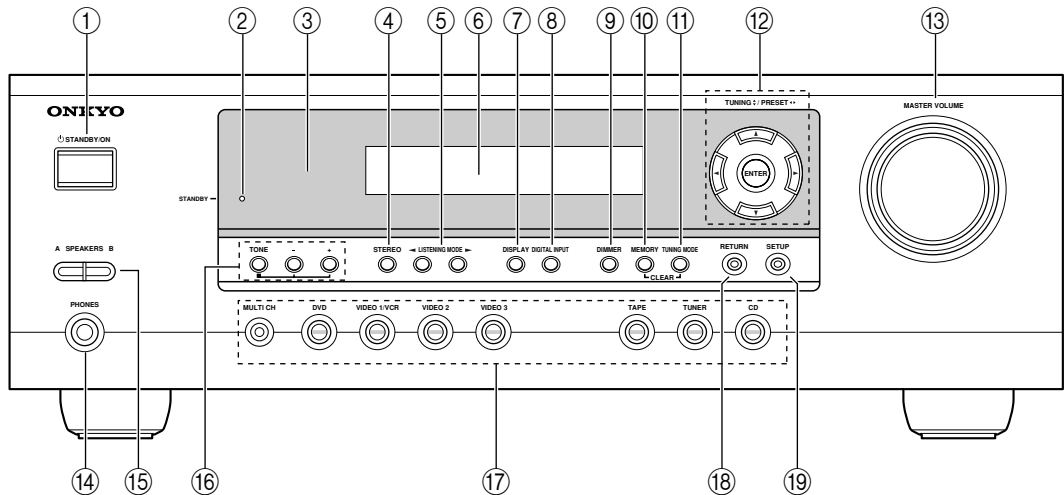

For detailed information, see the pages in parentheses.

- ① **STANDBY/ON button (30)**
This button is used to set the AV receiver to On or Standby.
- ② **STANDBY indicator (30)**
This indicator lights up when the AV receiver is in Standby mode, and it flashes while a signal is being received from the remote controller.
- ③ **Remote-control sensor (9)**
This sensor receives control signals from the remote controller.
- ④ **STEREO button (40)**
This button is used to select the Stereo listening mode.
- ⑤ **LISTENING MODE [◀]/[▶] buttons (40)**
These buttons are used to select the listening modes.
- ⑥ **Display**
See "Display" on page 7.
- ⑦ **DISPLAY button (35)**
This button is used to display various information about the currently selected input source.
- ⑧ **DIGITAL INPUT button (31)**
This button is used to assign the digital inputs and to specify the format of digital input signals.
- ⑨ **DIMMER button (38)**
This button is used to adjust the display brightness.
- ⑩ **MEMORY button (37)**
This button is used when storing or deleting radio presets.
- ⑪ **TUNING MODE button (36)**
This button is used to select the Auto or Manual tuning mode.
- ⑫ **Arrow/TUNING/PRESET & ENTER buttons**
When the AM or FM input source is selected, the TUNING [▲] [▼] buttons are used to tune the tuner, and the PRESET [◀] [▶] buttons are used to select radio presets (see page 37). When the setup menus are used, they work as arrow buttons and are used to select and set items. The ENTER button is also used with the setup menus.
- ⑬ **MASTER VOLUME control (34)**
This control is used to adjust the volume of the AV receiver to MIN, 1 through 79, or MAX
- ⑭ **PHONES jack (39)**
This 1/4-inch phone jack is for connecting a standard pair of stereo headphones for private listening.
- ⑮ **SPEAKER A & B buttons (34)**
These buttons are used to turn speaker sets A and B on or off.
- ⑯ **TONE, [-] & [+] buttons (38)**
These buttons are used to adjust the bass and treble.
- ⑰ **Input selector buttons (34)**
These buttons are used to select from the following input sources: MULTI CH, DVD, VIDEO 1/VCR, VIDEO 2, VIDEO 3, TAPE, TUNER, or CD.
The [MULTI CH] button selects the DVD analog multichannel input.
- ⑱ **RETURN button**
This button is used to return to the previously displayed setup menu.
- ⑲ **SETUP button**
This button is used to access various settings.

Display

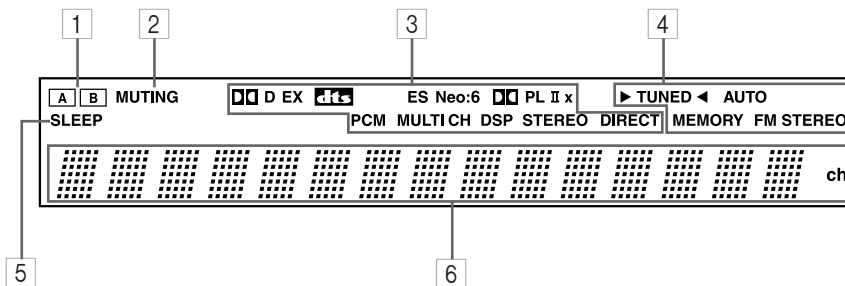

For detailed information, see the pages in parentheses.

1 A & B speaker indicators (34)

Indicator A lights up when speaker set A is on. Indicator B lights up when speaker set B is on.

2 MUTING indicator (38)

This indicator flashes when the AV receiver is muted.

3 Source/listening mode indicators (42)

These indicators show the currently selected listening mode and digital audio format.

4 Tuning indicators (36)

TUNED (36): This indicator lights up when the AV receiver is tuned to a radio station.

AUTO (36): This indicator lights up when Auto Tuning is selected and disappears when Manual Tuning is selected.

MEMORY (37): This indicator lights up when pre-setting radio stations.

FM STEREO (36): This indicator lights up when the AV receiver is tuned to a stereo FM station.

5 SLEEP indicator (39)

This indicator lights up when the Sleep function has been set.

6 Message area

This area of the display shows various information about the currently selected source.

Rear Panel

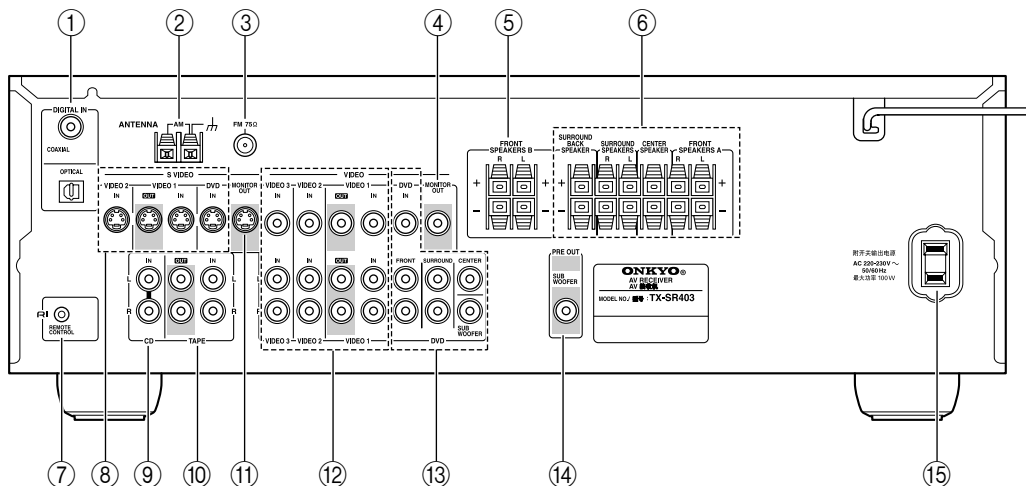

① DIGITAL IN OPTICAL & COAXIAL

These optical and coaxial jacks can be used to connect a CD or DVD player and other components with digital audio outputs.

② AM ANTENNA

These push terminals are for connecting an AM antenna.

③ FM ANTENNA

This jack is for connecting an FM antenna.

④ VIDEO MONITOR OUT

This composite video jack can be connected to a composite video input on your TV or projector.

⑤ FRONT SPEAKERS B

These push terminals are for connecting speaker set B.

⑥ FRONT SPEAKERS A, SURROUND SPEAKERS, CENTER SPEAKER & SURROUND BACK SPEAKER

These push terminals are for connecting speaker set A.

⑦ RI

This **RI** (Remote Interactive) jack can be connected to the **RI** jack on another Onkyo component. The AV receiver's remote controller can then be used to control that component. To use **RI**, you must make an analog audio connection (RCA) between the AV receiver and the other component, even if they are connected digitally.

Note:

RI can only be used with Onkyo components.

⑧ S VIDEO DVD IN, VIDEO 1 IN/OUT & VIDEO 2 IN

The DVD IN jack can be connected to an S-Video output on a DVD player. The VIDEO 1 IN/OUT

jacks can be used to connect a VCR. The VIDEO 2 IN jack can be used to connect another video source (e.g., cable TV, satellite TV, or a set-top-box).

⑨ CD IN

These analog inputs can be used to connect a CD player with analog outputs.

⑩ TAPE IN/OUT

These analog inputs and outputs can be used to connect a cassette recorder, MiniDisc recorder, or other recorder with analog inputs and outputs.

⑪ S VIDEO MONITOR OUT

This S-Video jack can be connected to an S-Video input on your TV or projector.

⑫ VIDEO 1 IN/OUT, VIDEO 2 IN & VIDEO 3 IN

The VIDEO 1 IN/OUT jacks can be used to connect a VCR. The VIDEO 2 IN and VIDEO 3 IN jacks can be used to connect other video sources (e.g., cable TV, satellite TV, or a set-top-box).

⑬ DVD IN

The FRONT, SURROUND, CENTER, and SUBWOOFER jacks can be used to connect a component with an analog multichannel audio output, such as a DVD player with a 5.1-channel analog output. The composite video input can be connected to the composite video output on a DVD player.

⑭ SUBWOOFER PRE OUT

A powered subwoofer can be connected here.

⑮ AC OUTLET

This switched AC outlet can be used to supply power to another component. The connector type depends on the country in which you purchased your AV receiver.

See pages 15–29 for connection information.

Before Using the AV receiver

Installing the Batteries

- 1 To open the battery compartment, press the small hollow and slide open the cover.**

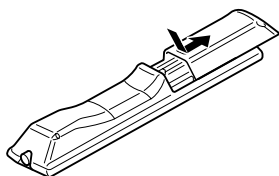

- 2 Insert the two supplied batteries (AA/R6) in accordance with the polarity diagram inside the battery compartment.**

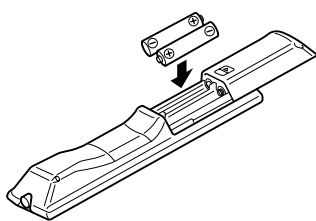

- 3 Slide the cover shut.**

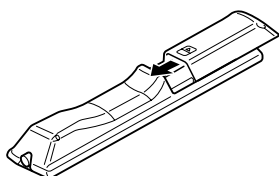

Notes:

- The batteries should last for about six months, although this will vary with usage.
- If the remote controller doesn't work reliably, try replacing the batteries.
- Don't mix new and old batteries or different types of batteries.
- If you intend not to use the remote controller for a long time, remove the batteries to prevent damage from leakage or corrosion.
- Expired batteries should be removed as soon as possible to prevent damage from leakage or corrosion.

Using the Remote Controller

To use the remote controller, point it at the AV receiver's remote control sensor, as shown below.

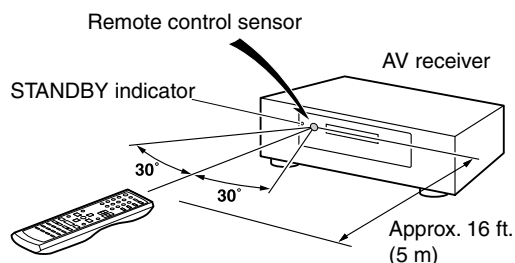

Notes:

- The remote controller may not work reliably if the AV receiver is subjected to bright light, such as direct sunlight or inverter-type fluorescent lights. Keep this in mind when installing.
- If another remote controller of the same type is used in the same room, or the AV receiver is installed close to equipment that uses infrared rays, the remote controller may not work reliably.
- Don't put anything, such as a book, on the remote controller, because the buttons may be pressed inadvertently, thereby draining the batteries.
- The remote controller may not work reliably if the AV receiver is installed in a rack behind colored glass doors. Keep this in mind when installing.
- The remote controller will not work if there's an obstacle between it and the AV receiver's remote control sensor.

Remote Controller

How to Use the Remote Controller

Including the AV receiver, the remote controller can be used to control up to six different components. The remote controller has a specific operating mode for use with each type of component. Modes are selected by using the five REMOTE MODE buttons.

RECEIVER/TAPE Mode

In RECEIVER/TAPE mode, you can control the AV receiver and an Onkyo cassette recorder connected via **RI**.



DVD, CD, MD, & CDR Modes

With these modes, you can control an Onkyo DVD player and CD/MD/CDR player/recorder.



1 Use the REMOTE MODE buttons to select a mode.

2 Use the buttons supported by that mode to control the component.

- RECEIVER mode: see page 10
- DVD mode: see page 12
- CD/MD/CDR mode: see page 13
- TAPE mode: see page 14

Note:

Some of the remote controller operations described in this manual may not work as expected with other components.

RECEIVER Mode

RECEIVER mode is used to control the AV receiver.

To set the remote controller to RECEIVER mode, press the [RECEIVER] REMOTE MODE button.

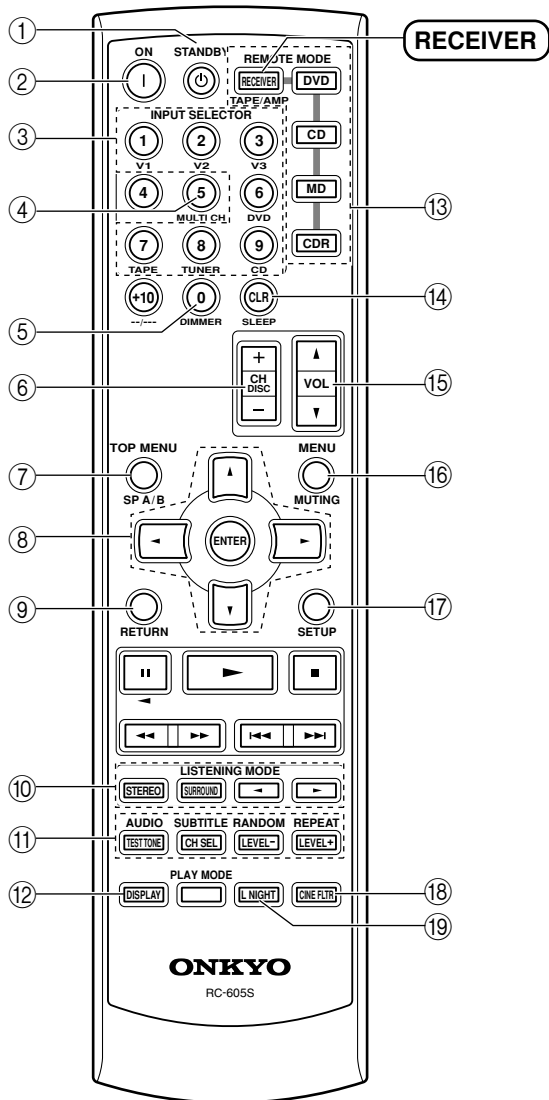

Remote Controller—Continued

For detailed information, see the pages in parentheses.

① **STANDBY button (30)**

This button is used to set the AV receiver to Standby.

② **ON button (30)**

This button is used to turn on the AV receiver.

③ **INPUT SELECTOR buttons (34)**

These buttons are used to select the input sources.

④ **MULTI CH button (35)**

This button is used to select the multichannel DVD input.

⑤ **DIMMER button (38)**

This button is used to adjust the display brightness.

⑥ **CH +/- button (37)**

This button is used to select radio presets.

⑦ **SP A/B button (34)**

This button is used to turn speaker sets A and B on or off.

⑧ **Arrow [▲]/[▼]/[◀]/[▶] & ENTER buttons**

These buttons are used to select and adjust settings.

⑨ **RETURN button**

This button is used to return to the previous display when changing settings.

⑩ **LISTENING MODE buttons (40)**

These buttons can be used to select listening modes regardless of the currently selected remote controller mode.

STEREO button

This button selects the Stereo listening mode.

SURROUND button

This button selects the Dolby and DTS listening modes.

[◀]/[▶] buttons

These buttons can be used to select any of the available listening modes.

⑪ **TEST TONE, CH SEL, LEVEL- & LEVEL+ buttons (33)**

These buttons are used to adjust the level of each speaker.

⑫ **DISPLAY button (35)**

This button is used to display various information about the currently selected input source.

⑬ **REMOTE MODE buttons (10)**

These buttons are used to select the remote controller modes. When you press a button on the remote controller, the REMOTE MODE button for the currently selected mode lights up.

⑭ **SLEEP button (39)**

This button is used to set the Sleep function.

⑮ **VOL [▲]/[▼] button (34)**

This button can be used to adjust the volume of the AV receiver regardless of the currently selected remote controller mode.

⑯ **MUTING button (38)**

This button is used to mute the AV receiver.

⑰ **SETUP button**

This button is used to access various settings.

⑱ **CINE FLTR button (44)**

This button is used to set the CinemaFILTER function.

⑲ **L NIGHT button (44)**

This button is used to set the Late Night function.

DVD Mode

To set the remote controller to DVD mode, press the [DVD] REMOTE MODE button.

Before selecting DVD mode and starting playback, you should press the [RECEIVER] mode button followed by the [DVD] INPUT SELECTOR button to select the DVD player as the input source.

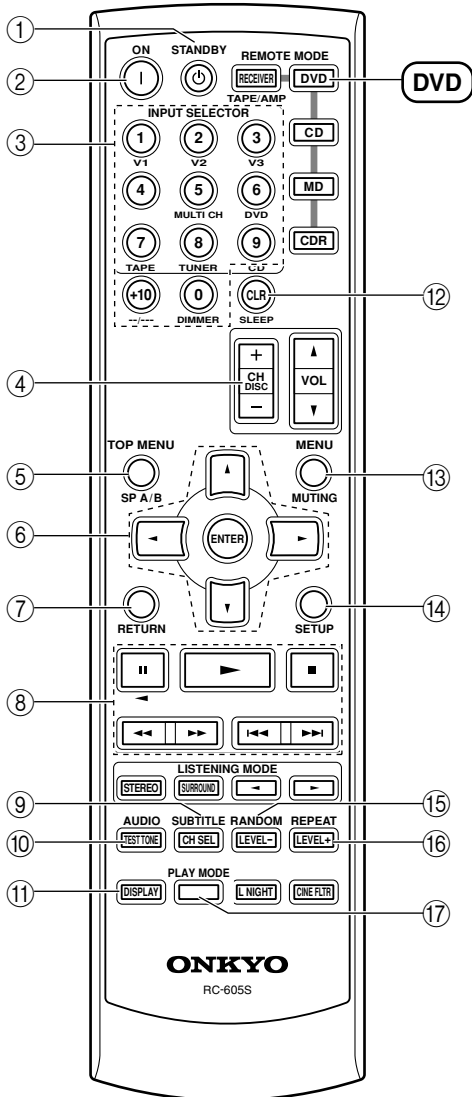

- ① **STANDBY button**
This button sets the DVD player to Standby.
- ② **ON button**
This button is used to turn on the DVD player.
- ③ **Number buttons**
These buttons are used to enter title, chapter, and track numbers and to enter times for locating specific points in time.
- ④ **DISC +/- button**
This button selects discs on a DVD changer.
- ⑤ **TOP MENU button**
This button is used to select a DVD's top menu.
- ⑥ **Arrow [▲]/[▼]/[◀]/[▶] & ENTER buttons**
These buttons are used to navigate DVD menus and the DVD player's onscreen setup menus.
- ⑦ **RETURN button**
This button is used to exit the DVD player's onscreen setup menu and to restart menu playback.
- ⑧ **Playback buttons**
From left to right: Pause, Play, Stop, Fast Reverse, Fast Forward, Previous, and Next.
- ⑨ **SUBTITLE button**
This button is used to select subtitles.
- ⑩ **AUDIO button**
This button selects foreign language soundtracks and audio formats (e.g., Dolby Digital or DTS).
- ⑪ **DISPLAY button**
This button is used to display information about the current disc, title, chapter, or track on the DVD player's display, including the elapsed time, remaining time, total time, and so on.
- ⑫ **CLR button**
This button is used to cancel functions and to clear entered numbers.
- ⑬ **MENU button**
This button is used to display a DVD's menu.
- ⑭ **SETUP button**
This button is used to access the DVD player's onscreen setup menus.
- ⑮ **RANDOM button**
This button is used with the random playback function.
- ⑯ **REPEAT button**
This button is used to set the repeat playback functions.
- ⑰ **PLAY MODE button**
This button is used to select play modes on a component with selectable play modes.

CD, MD, & CDR Mode

To set the remote controller to CD, MD, or CDR mode, press the [CD], [MD], or [CDR] REMOTE MODE button.

Before selecting a mode and starting playback, you should press the [RECEIVER] mode button followed by the [CD] or [TAPE] INPUT SELECTOR button to select the CD player, MiniDisc, or CD recorder as the input source.

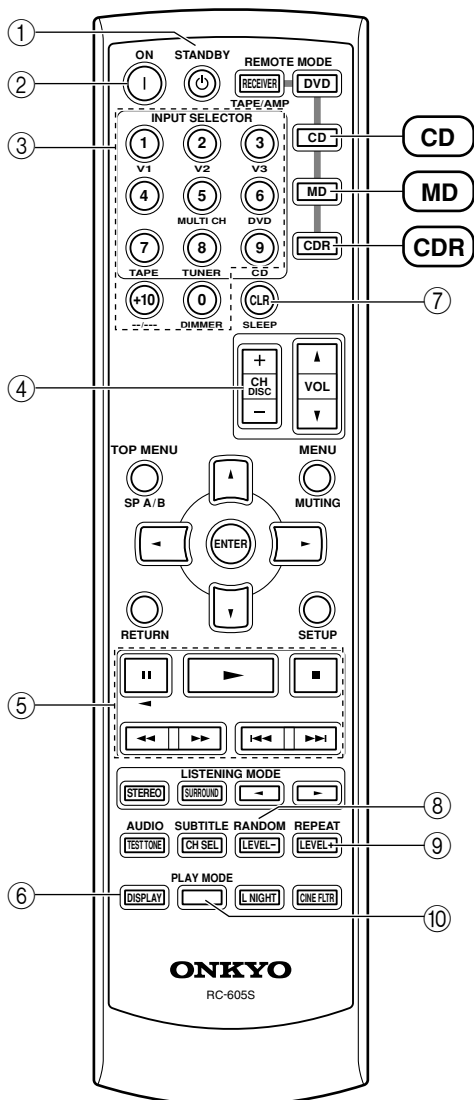

- ① **STANDBY button**
This button sets the CD player or MD/CD recorder to Standby.
- ② **ON button**
This button is used to set the CD player or MD/CD recorder to On or Standby.
- ③ **Number buttons**
These buttons are used to enter track numbers and to enter times for locating specific points in time.
- ④ **DISC +/- button**
This button selects discs on a CD changer.
- ⑤ **Playback buttons**
From left to right: Pause, Play, Stop, Fast Reverse, Fast Forward, Previous and Next.
- ⑥ **DISPLAY button**
This button is used to display information about the current disc or track on the CD player or MD/CD recorder's display, including the elapsed time, remaining time, total time, and so on.
- ⑦ **CLR button**
This button is used to cancel functions and to clear entered numbers.
- ⑧ **RANDOM button**
This button is used with the random playback function.
- ⑨ **REPEAT button**
This button is used to set the repeat playback functions.
- ⑩ **PLAY MODE button**
This button is used to select play modes on a component with selectable play modes.

TAPE Mode

TAPE mode is used to control an Onkyo cassette recorder connected to the AV receiver via **RI**.

To set the remote controller to TAPE mode, press the **[RECEIVER] REMOTE MODE** button.

Before selecting TAPE mode and starting playback, you should press the **[RECEIVER] REMOTE MODE** button followed by the **[TAPE] INPUT SELECTOR** button to select your cassette recorder as the input source.

For twin cassette decks, only deck B can be controlled.

- ① **Play [▶] button**
This button is used to start playback.
- ② **Stop [■] button**
This button is used to stop playback.
- ③ **Reverse Play [◀] button**
This button is used to start reverse playback.
- ④ **Rewind & FF [◀◀]/[▶▶] buttons**
The Rewind [◀◀] button is used to start rewind. The FF [▶▶] button is used to start fast forward.

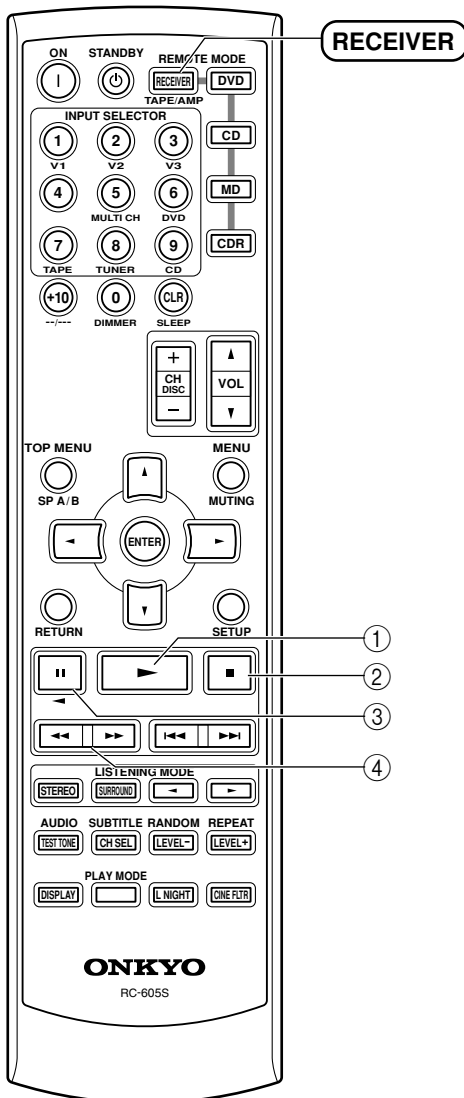

Connecting Your Speakers

Enjoying Home Theater

You can use two sets of speakers with the AV receiver: speaker set A and speaker set B.

Speaker set A should be installed in your main listening room and can be used with Dolby Digital and DTS surround material. Each speaker must be positioned at a specific location in your listening room to get the best from surround sound material. The following illustration shows the best positions for your surround-sound speakers. When speaker set B is turned on, speaker set A is reduced to 2.1-channel playback. If the multichannel DVD input is selected, and speaker set B is turned on, speaker set A is reduced to 2-channel playback.

Speaker set B can be installed in another room. Speakers can be positioned in the standard position for stereo speakers or however you like.

Front left and right speakers

These output the overall sound. Their role in a home theater is to provide a solid anchor for the sound image. They should be positioned facing the listener at about ear level, and equidistant from the TV. Angle them inward so as to create a triangle, with the listener at the apex.

Center speaker

This speaker enhances the front left and right speakers, making sound movements distinct and providing a full sound image. In movies it's used mainly for dialog.

Position it close to your TV (preferably on top) facing forward at about ear level, or at the same height as the front left and right speakers.

Subwoofer

The subwoofer handles the bass sounds of the LFE (Low-Frequency Effects) channel. The volume and quality of the bass output from your subwoofer will depend on its position, the shape of your listening room, and your listening position. In general, a good bass sound can be obtained by installing the subwoofer in a front corner, or at one-third the width of the wall, as shown.

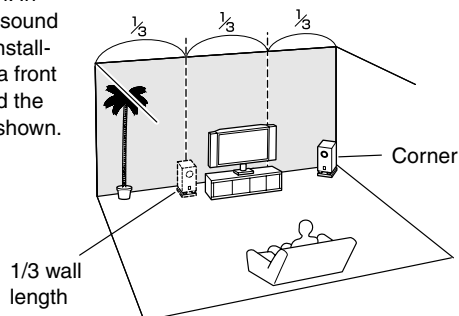

Surround back speaker

This speaker further enhances the realism of surround sound and improves sound localization behind the listener. It's essential to enjoy certain listening modes (i.e., Dolby Digital EX and DTS-ES). Position it behind the listener about 2–3 feet (60–100 cm) above ear level. Make sure that the listening position is within the range of the speaker.

Surround left and right speakers

These speakers are used for precise sound positioning and to add realistic ambience. Position them at the sides of the listener, or slightly behind, about 2–3 feet (60–100 cm) above ear level. Ideally they should be equidistant from the listener.

Connecting Your Speakers—Continued

Speaker Configuration

For the best surround-sound experience, you should connect six speakers and a powered subwoofer.

The following table shows which channels you should use based on the number of speakers that you have.

Number of speakers:	2	3	4	5	6
Front left	✓	✓	✓	✓	✓
Front right	✓	✓	✓	✓	✓
Center		✓		✓	✓
Surround left			✓	✓	✓
Surround right			✓	✓	✓
Surround back					✓

No matter how many speakers you use, a powered subwoofer is recommended for a really powerful and solid bass.

Before using the AV receiver, you must specify which speakers are connected and their sizes (see page 32).

To get the very best from your surround-sound system, you should also specify the distance between the listener and each individual speaker so that the sound from each speaker arrives at the listener's ears at the same time (see page 48). In addition, you should set the level of each individual speaker to achieve an equal balance (see page 48.)

Attaching the Speaker Labels

The AV receiver's positive (+) speaker terminals are color-coded for ease of identification. (The negative (-) speaker terminals are all black.)

Speaker terminal	Color
Front left	White
Front right	Red
Center	Green
Surround left	Blue
Surround right	Gray
Surround back	Brown

The supplied speaker labels are also color-coded and you should attach them to the positive (+) side of each speaker cable in accordance with the above table. All you need to do then is to match the color of each label to the corresponding speaker terminal.



Speaker Connection Precautions

Read the following before connecting your speakers:

- You can connect speakers with an impedance of **6 ohms or higher**. If you use speakers with a lower impedance, and use the amplifier at high volume levels for a long period of time, the built-in protection circuit may be activated.
- Disconnect the power cord from the wall outlet before making any connections.
- Read the instructions supplied with your speakers.
- Pay close attention to speaker wiring polarity. In other words, connect positive (+) terminals to only positive (+) terminals, and negative (-) terminals to only negative (-) terminals. If you get them the wrong way around, the sound will be out of phase and will sound unnatural.
- Unnecessarily long, or very thin speaker cables may affect the sound quality and should be avoided.
- Be careful not to short the positive and negative wires. Doing so may damage the AV receiver.
- Don't connect more than one cable to each speaker terminal. Doing so may damage the AV receiver.
- Don't connect one speaker to several terminals.

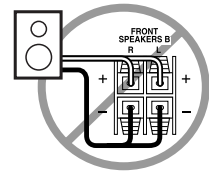
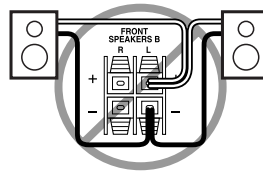

Connecting Your Speakers—Continued

Connecting Speaker

- Strip 3/8" (10 mm) of insulation from the ends of the speaker cables, and twist the bare wires tightly, as shown.

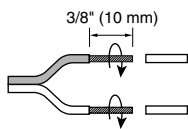

- While pressing the lever, insert the wire into the hole, and then release the lever. Make sure that the terminals are gripping the bare wires, not the insulation.

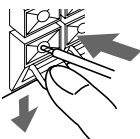

Note:

When speaker set B is turned on, speaker set A is reduced to 2.1-channel playback.

Connecting a Powered Subwoofer

Using a suitable cable, connect the AV receiver's SUBWOOFER PRE OUT to an input on your powered subwoofer, as shown. If your subwoofer is unpowered and you're using an external amplifier, connect the SUBWOOFER PRE OUT to an input on the amp.

Note:

Make sure the cable is plugged all the way.

The following illustration shows which speaker should be connected to each pair of terminals.

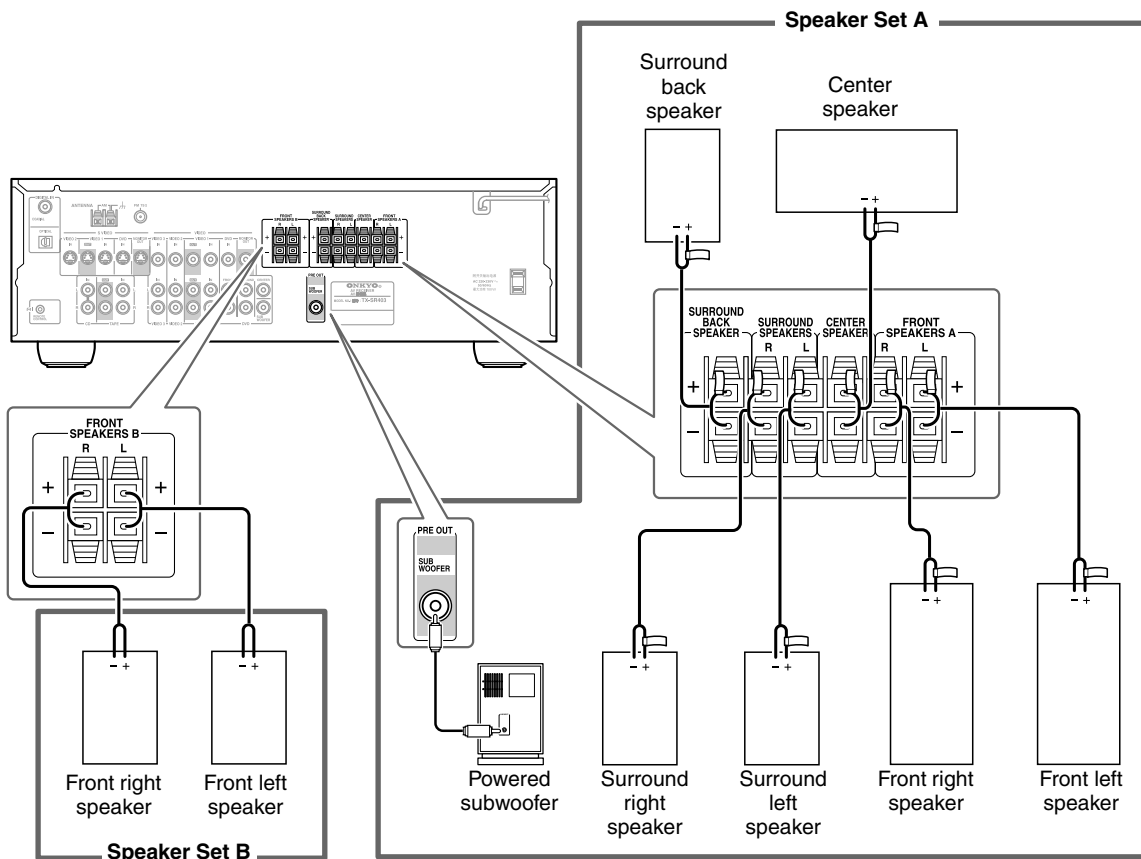

Connecting Antenna

This section explains how to connect the supplied indoor FM antenna and AM loop antenna, and how to connect commercially available outdoor FM and AM antennas. The AV receiver won't pick up any radio signals without any antenna connected, so you must connect the antenna to use the tuner.

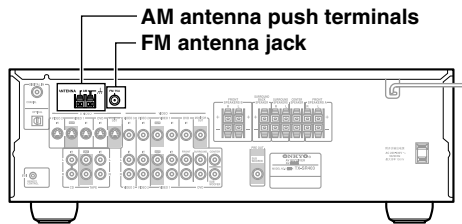

Connecting the Indoor FM Antenna

The supplied indoor FM antenna is for indoor use only.

1 Attach the FM antenna, as shown.

■ American Model

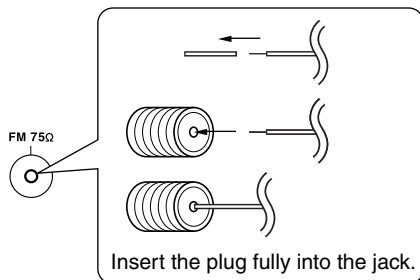

■ Other Models

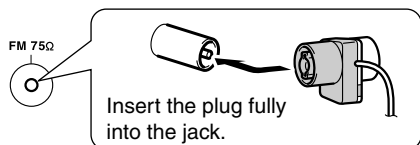

Once your AV receiver is ready for use, you'll need to tune into an FM radio station and adjust the position of the FM antenna to achieve the best possible reception.

2 Fully extend the antenna and point it in various directions to find the best reception. Secure it in that position with thumb-tacks or something similar.

If you cannot achieve good reception with the supplied indoor FM antenna, try a commercially available outdoor FM antenna instead (see page 19).

Connecting the AM Loop Antenna

The supplied indoor AM loop antenna is for indoor use only.

1 Assemble the AM loop antenna, inserting the tabs into the base, as shown.

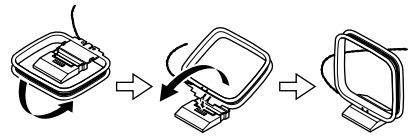

2 Connect both wires of the AM loop antenna to the AM push terminals, as shown.

(The antenna's wires are not polarity sensitive, so they can be connected either way around).

Make sure that the wires are attached securely and that the push terminals are gripping the bare wires, not the insulation.

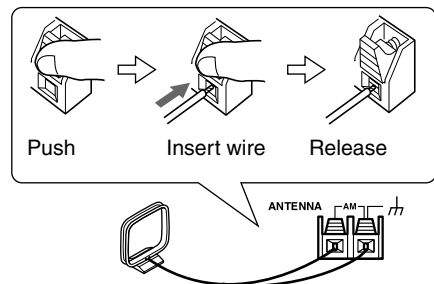

Once your AV receiver is ready for use, you'll need to tune into an AM radio station and adjust the position of the AM antenna to achieve the best possible reception.

Keep the antenna as far away as possible from your AV receiver, TV, speaker cables, and power cords.

If you cannot achieve good reception with the supplied indoor AM loop antenna, try using it with a commercially available outdoor AM antenna (see page 19).

Connecting Antenna—Continued

Connecting an Outdoor FM Antenna

If you cannot achieve good reception with the supplied indoor FM antenna, try a commercially available outdoor FM antenna instead.

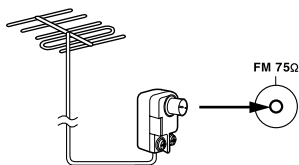

Notes:

- Outdoor FM antennas work best outside, but usable results can sometimes be obtained when installed in an attic or loft.
- For best results, install the outdoor FM antenna well away from tall buildings, preferably with a clear line of sight to your local FM transmitter.
- Outdoor antenna should be located away from possible noise sources, such as neon signs, busy roads, etc.
- For safety reasons, outdoor antenna should be situated well away from power lines and other high-voltage equipment.
- Outdoor antenna must be grounded in accordance with local regulations to prevent electrical shock hazards.

■ Using a TV/FM Antenna Splitter

It's best not to use the same antenna for both FM and TV reception, as this can cause interference problems. If circumstances demand it, use a TV/FM antenna splitter, as shown.

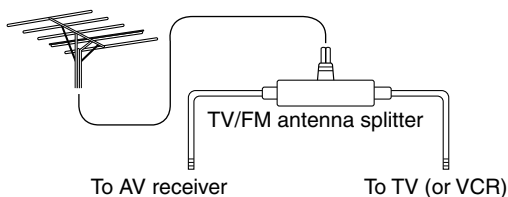

Connecting an Outdoor AM Antenna

If good reception cannot be achieved using the supplied AM loop antenna, an outdoor AM antenna can be used in addition to the loop antenna, as shown.

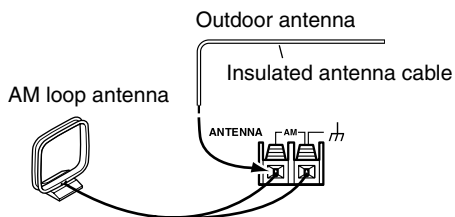

Outdoor AM antennas work best when installed outside horizontally, but good results can sometimes be obtained indoors by mounting horizontally above a window. Note that the AM loop antenna should be left connected. Outdoor antenna must be grounded in accordance with local regulations to prevent electrical shock hazards.

Connecting Your Components

About AV Connections

- Before making any AV connections, read the manuals supplied with your other AV components.
- Don't connect the power cord until you've completed and double-checked all AV connections.

Optical Digital Jacks

The AV receiver's optical digital jack has shutter-type cover that open when an optical plug is inserted and close when it's removed. Push plugs in all the way.

Caution: To prevent shutter damage, hold the optical plug straight when inserting and removing.

AV Connection Color Coding

RCA-type AV connections are usually color coded: red, white, and yellow. Use red plugs to connect right-channel audio inputs and outputs (typically labeled "R"). Use white plugs to connect left-channel audio inputs and outputs (typically labeled "L"). And use yellow plugs to connect composite video inputs and outputs.

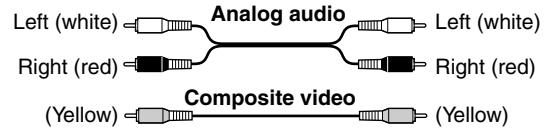



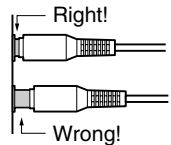

- Push plugs in all the way to make good connections (loose connections can cause noise or malfunctions).
- To prevent interference, keep audio and video cables away from power cords and speaker cables.



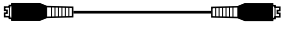

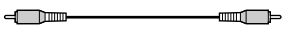



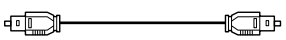

AV Cables & Jacks

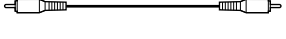
Video

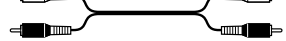
Cable	Jack	Description
	 S	S-Video separates the luminance and color signals and provides better picture quality than composite video.
	 V	Composite video is commonly used on TVs, VCRs, and other video equipment. Use only dedicated composite video cables.

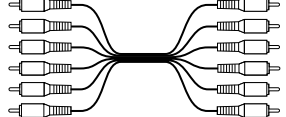
Audio

Cable	Jack	Description
	 OPTICAL	Offers the best sound quality and allows you to enjoy surround sound (e.g., Dolby Digital, DTS). The audio quality is the same as for coaxial.
	 COAXIAL	Offers the best sound quality and allows you to enjoy surround sound (e.g., Dolby Digital, DTS). The audio quality is the same as for optical.
	 L R	This cable carries analog audio. It's the most common connection format for analog audio and can be found on virtually all AV components.
	 FRONT SURROUND CENTER DVD SUR WOOFER	This cable carries multichannel analog audio and is typically used to connect DVD players with a 5.1-channel analog audio output. Several standard analog audio cables can be used instead of a multichannel cable.

Connecting Both Audio & Video

By connecting both the audio and video outputs of your DVD player and other AV components to the AV receiver, you can select both the audio and video simultaneously simply by selecting the appropriate input source on the AV receiver.

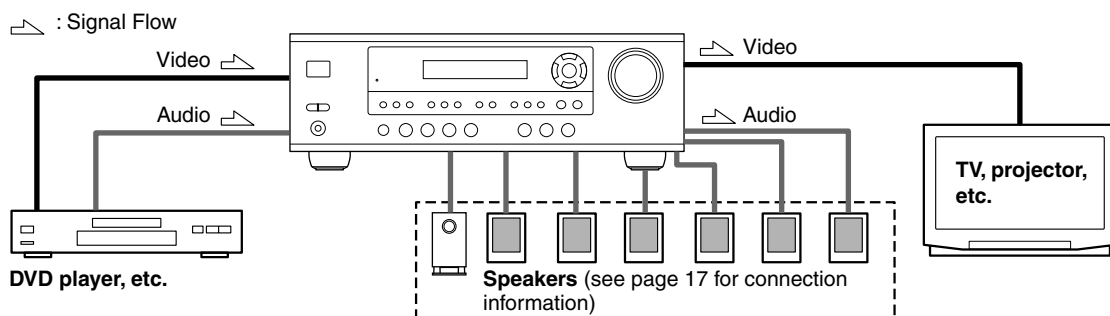

Which Connections Should I Use?

The AV receiver supports several connection formats for compatibility with a wide range of AV equipment. The format you choose will depend on the formats supported by your other components. Use the following sections as a guide. For video components, such as a DVD player, you must make two connections—one for audio, one for video.

Video Connection Formats

Video equipment can be connected to the AV receiver using one of the following video connection formats: composite video or S-Video, the latter offering the best picture quality.

When choosing a connection format, bear in mind that the AV receiver doesn't convert between formats, so only outputs of the same format as the input will output the signal.

For example, if you connect your DVD player to the S-VIDEO DVD IN, a video signal will be output by the S-VIDEO MONITOR OUT (for your TV) and the S-VIDEO VIDEO 1 OUT (for your VCR), but not by any composite video output.

Video Input/Output Diagram

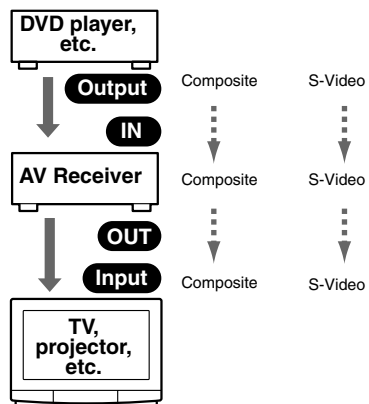

Audio Connection Formats

Audio equipment can be connected to the AV receiver using the following audio connection formats: analog, optical, coaxial, and multichannel.

When choosing a connection format, bear in mind that the AV receiver doesn't convert between formats.

For example, audio signals connected to an OPTICAL or COAXIAL digital input are not output by the analog TAPE OUT, so if you want to record from, for example, your CD player, in addition to connecting it to a digital input, you must also connect it to the analog CD IN.

Audio Input/Output Diagram for Recording

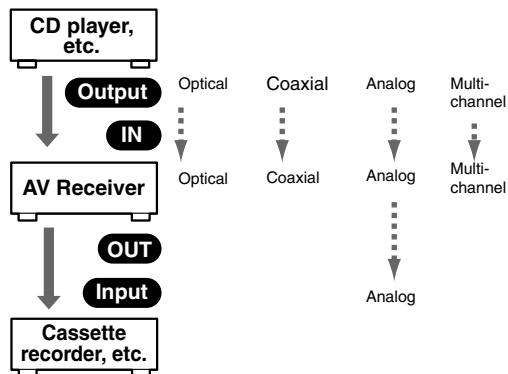

Connecting Your Components—Continued

Connecting a TV or Projector

Step 1: Video Connection

Choose a connection type **A** or **B** that matches the TV, and then make the connection.

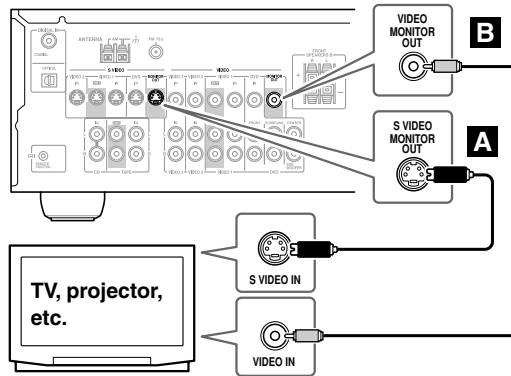

Connection	TX-SR403/8340	Signal flow	TV	Picture quality
A	S VIDEO MONITOR OUT	⇒	S-Video input	Better
B	VIDEO MONITOR OUT	⇒	Composite video input	Standard

Step 2: Audio Connection

Choose a connection type **a**, **b**, or **c** that matches the TV, and then make the connection.

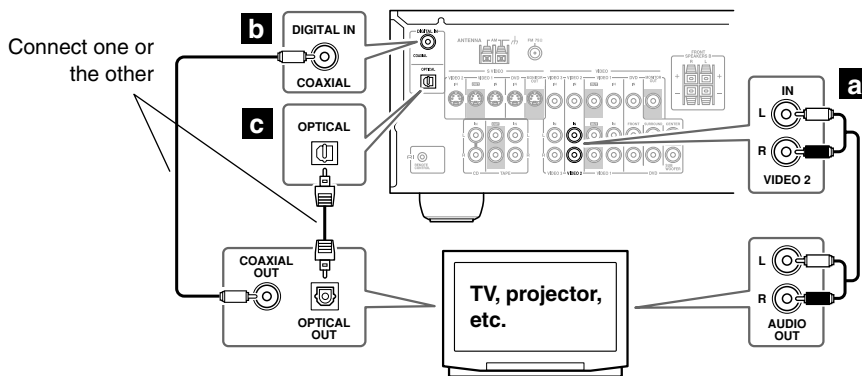

- With the basic **a** connection, you can listen to or record audio from the TV.
- To enjoy Dolby and DTS listening modes, use connection **b** or **c**. (Use **a** and **b** or **a** and **c** for recording.)

Connection	TX-SR403/8340	Signal flow	TV
a	VIDEO 2 IN L/R	←	Analog audio L/R output
b	DIGITAL IN COAXIAL	←	Digital coaxial output
c	DIGITAL IN OPTICAL	←	Digital optical output

Hint!

If your TV has no audio outputs, connect your VCR to the AV receiver and use its tuner.

Connecting Your Components—Continued

Connecting a DVD player

Step 1: Video Connection

Choose a connection type **A** or **B** that matches the DVD player, and then make the connection.

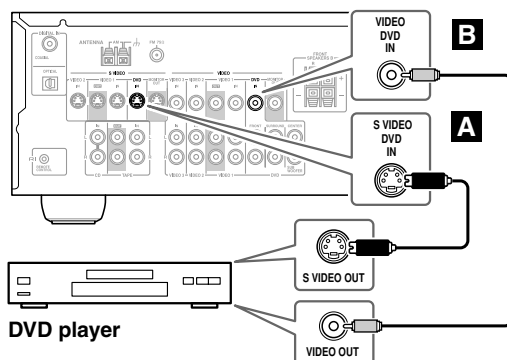

The TV must be connected to the AV receiver with the same type of connection.

Connection	TX-SR403/8340	Signal flow	DVD player	Picture quality
A	S VIDEO DVD IN	←	S-Video output	Better
B	VIDEO DVD IN	←	Composite video output	Standard

Step 2: Audio Connection

Choose a connection type **a**, **b**, **c**, or **d** that matches your DVD player, and then make the connection.

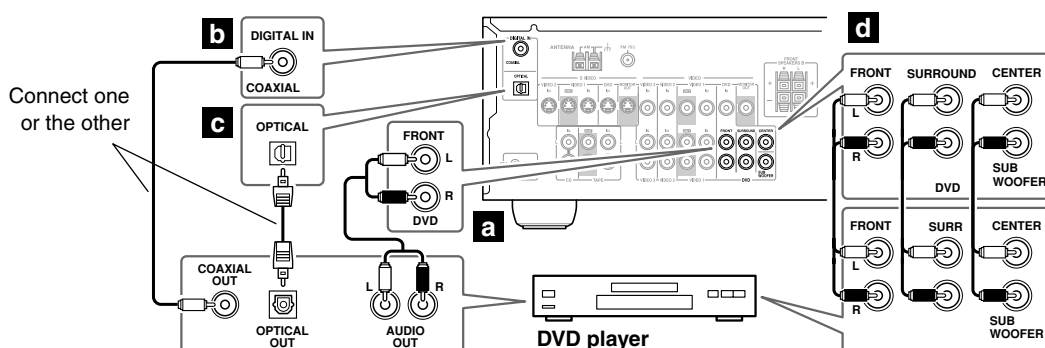

- With the basic **a** connection, you can listen to or record audio from a DVD.
- To enjoy Dolby and DTS listening modes, use connection **b** or **c**. (Use **a** and **b** or **a** and **c** for recording.)
- To enjoy DVD-Audio or SACD playback from a compatible DVD player with an analog multichannel output, use connection **d**.

Connection	TX-SR403/8340	Signal flow	DVD player
a	DVD IN FRONT	←	Analog audio L/R output
b	DIGITAL IN COAXIAL	←	Digital coaxial output
c	DIGITAL IN OPTICAL 1	←	Digital optical output
d	DVD IN FRONT, SURROUND, CENTER, and SUBWOOFER	←	Analog multichannel output

- If your DVD player has main left and right outputs and multichannel left and right outputs, be sure to use the main left and right outputs for connection **a**.

Connecting Your Components—Continued

Connecting a VCR or DVD Recorder for Playback

In addition to video playback, with this hookup example, you can use the VCR's tuner to listen to the sound of your favorite TV programs via the AV receiver. This is useful if the TV has no audio outputs.

Step 1: Video Connection

Choose a connection type **A** or **B** that matches the VCR/DVD recorder, and then make the connection. The TV must be connected to the AV receiver with the same type of connection.

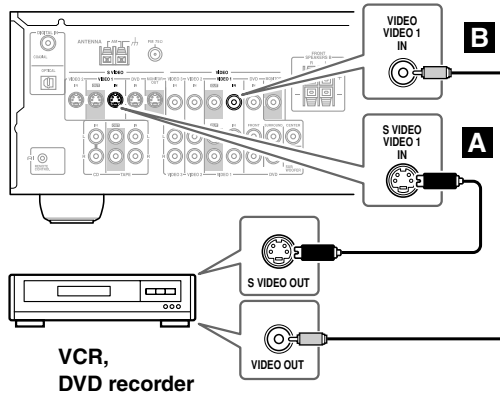

Connection	TX-SR403/8340	Signal flow	VCR/DVD recorder	Picture quality
A	S VIDEO VIDEO 1 IN	←	S-Video output	Better
B	VIDEO VIDEO 1 IN	←	Composite video output	Standard

Step 2: Audio Connection

Choose a connection type **a**, **b**, or **c**, and then make the connection.

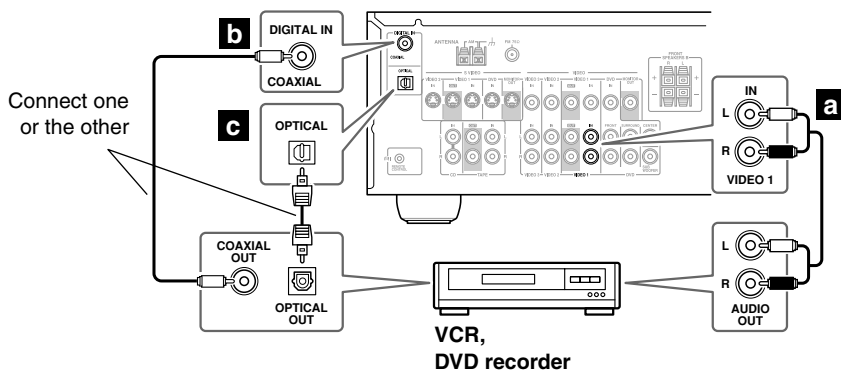

- With the basic **a** connection, you can listen to the VCR/DVD recorder.
- To enjoy Dolby and DTS listening modes, use connection **b** or **c**. (Use **a** and **b** or **a** and **c** for recording.)

Connection	TX-SR403/8340	Signal flow	VCR/DVD recorder
a	VIDEO 1 IN L/R	←	Analog audio L/R output
b	DIGITAL IN COAXIAL	←	Digital coaxial output
c	DIGITAL IN OPTICAL	←	Digital optical output

Connecting Your Components—Continued

Connecting a VCR or DVD Recorder for Recording

Step 1: Choose a video connection type (**A** or **B**) that matches the VCR/DVD recorder, and make the connection. The video source that you want to record must be connected to the AV receiver with the same type of connection.

Step 2: Make audio connection **a**.

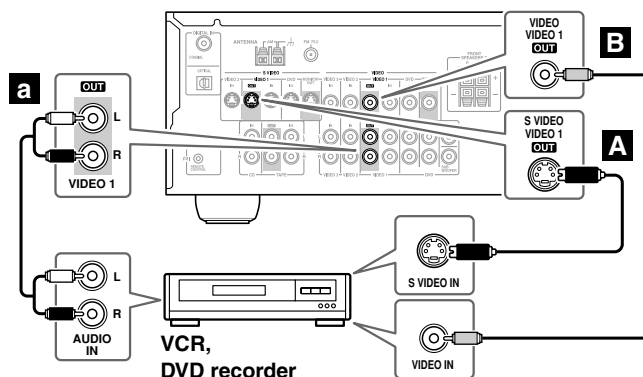

Connection	TX-SR403/8340	Signal flow	VCR/DVD recorder	Picture quality
A	S VIDEO VIDEO 1 OUT	⇒	S-Video input	Better
B	VIDEO VIDEO 1 OUT	⇒	Composite video input	Standard
a	VIDEO 1 OUT L/R	⇒	Audio L/R input	—

Connecting a Camcorder, Games Console, or Other Device

Step 1: Make video connection **A**.

Step 2: Make audio connection **a**.

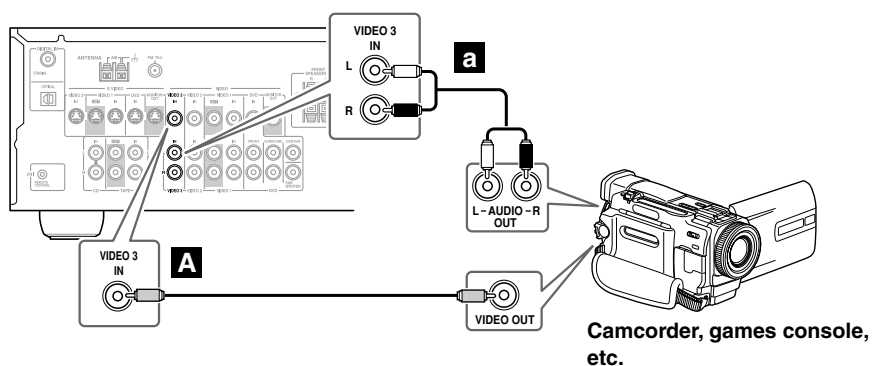

Connection	TX-SR403/8340	Signal flow	Camcorder/console
A	VIDEO 3 IN	←	Composite video output
a	VIDEO 3 IN L/R	←	Analog audio L/R output

Connecting Your Components—Continued

Connecting a Satellite, Cable, Set-top box, or Other Video Source

Step 1: Video Connection

Choose a connection type **A** or **B** that matches the video source, and then make the connection.

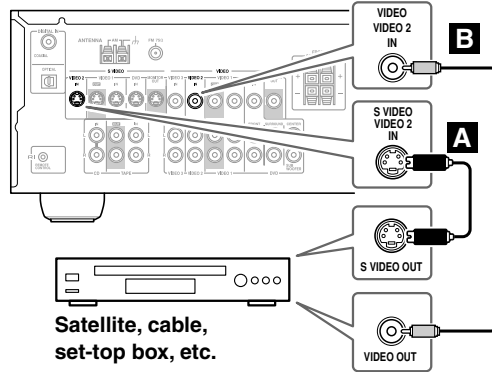

The TV must be connected to the AV receiver with the same type of connection.

Connection	TX-SR403/8340	Signal flow	Video source	Picture quality
A	S VIDEO VIDEO 2 IN	←	S-Video output	Better
B	VIDEO VIDEO 2 IN	←	Composite video output	Standard

Step 2: Audio Connection

Choose a connection type **a**, **b**, or **c** that matches the video source, and then make the connection.

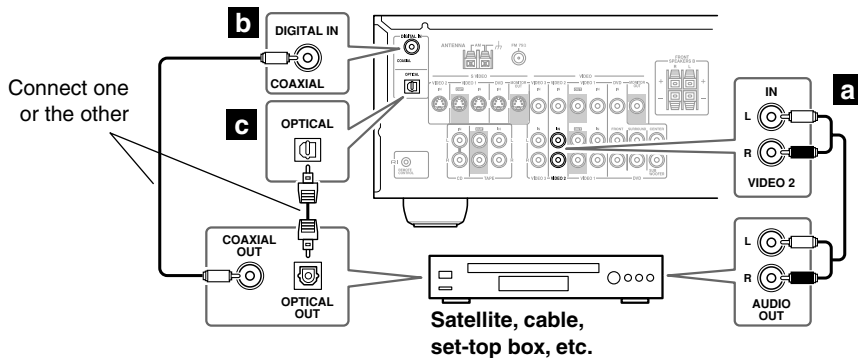

- With the basic **a** connection, you can listen to or record audio from the video source.
- To enjoy Dolby and DTS listening modes, use connection **b** or **c**. (Use **a** and **b** or **a** and **c** for recording.)

Connection	TX-SR403/8340	Signal flow	Video source
a	VIDEO 2 IN L/R	←	Analog audio L/R output
b	DIGITAL IN COAXIAL	←	Digital coaxial output
c	DIGITAL IN OPTICAL	←	Digital optical output

Connecting a CD Player or Turntable

■ CD Player, or Turntable with Built-in Phono Preamp

Step 1:

Choose a connection type (**a**, **b**, or **c**) that matches the CD player, or choose **a** for a turntable with a built-in phono preamp, and then make the connection.

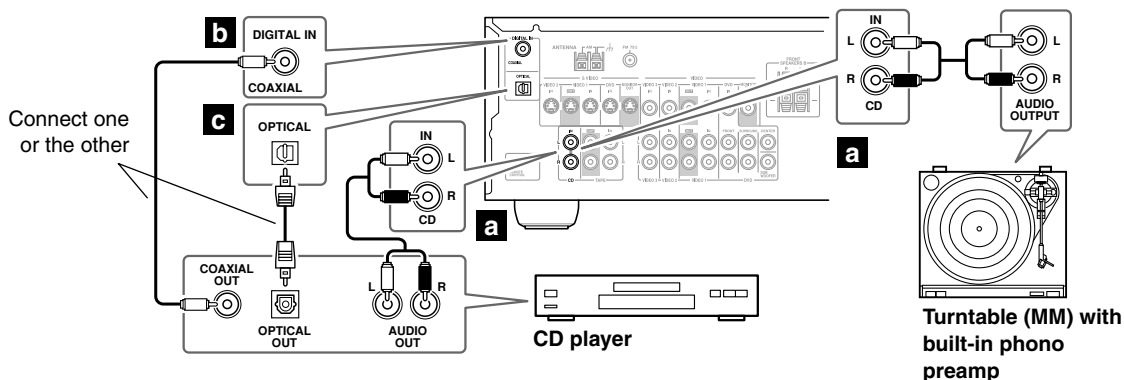

- With the basic **a** connection, you can listen to or record audio from the CD player or turntable.
- To connect the CD player digitally, use connection **b** or **c**. (Use **a** and **b** or **a** and **c** for recording.)

Connection	TX-SR403/8340	Signal flow	CD or turntable
a	CD IN L/R	←	Analog audio L/R output
b	DIGITAL IN COAXIAL	←	Digital coaxial output
c	DIGITAL IN OPTICAL	←	Digital optical output

■ Turntable with no Phono Preamp Built-in

A phono preamp is necessary to connect a turntable that doesn't have a phono preamp built-in.

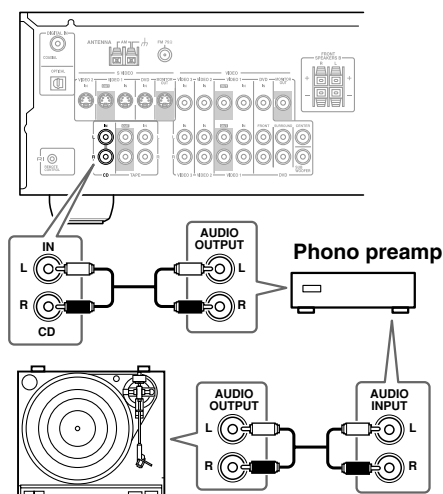

■ Turntable with an MC (Moving Coil) Cartridge

An MC head amp and phono preamp are necessary to connect a turntable with an MC (Moving Coil) cartridge.

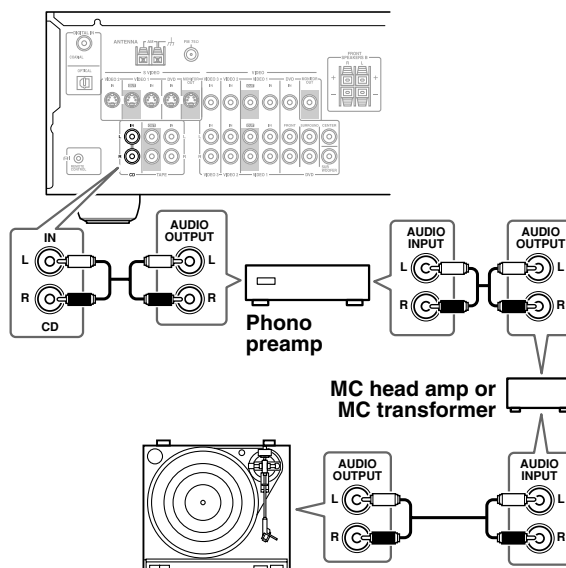

Connecting Your Components—Continued

Connecting a Cassette, CDR, MiniDisc, or DAT Recorder

Step 1:

Choose a connection type **(a)**, **(b)**, or **(c)** that matches the recorder, and then make the connection.

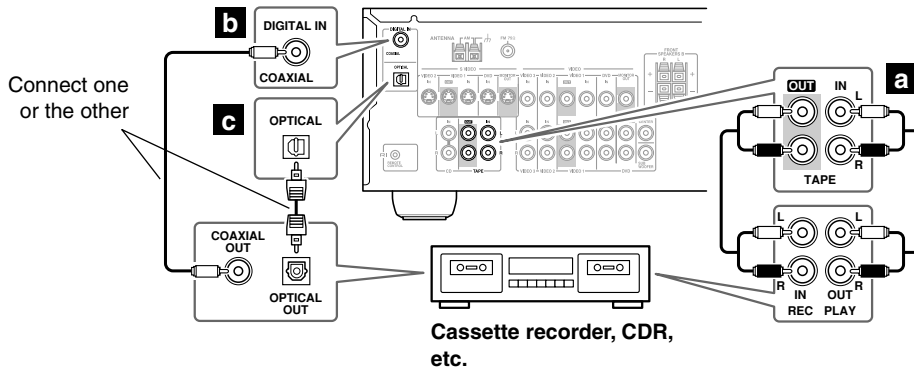

- With the basic **(a)** connection, you can play and record with the recorder.
- To connect the recorder digitally for playback purposes, use connections **(a)** and **(b)** or **(a)** and **(c)**.

Connection	TX-SR403/8340	Signal flow	Cassette/CDR/MD/DAT recorder
(a)	TAPE IN L/R TAPE OUT L/R	← ⇒	Analog audio L/R output Analog audio L/R input
(b)	DIGITAL IN COAXIAL	←	Digital coaxial output
(c)	DIGITAL IN OPTICAL	←	Digital optical output

Connecting the Power Cord of Another Component

The AV receiver has an AC outlet on its rear panel for connecting the power cord of another AV component. The other component's power switch can then be left in the ON position so that it turns on or off when the AV receiver is set to On or Standby.

Caution:

- Make sure that the capacity of the component that you connect to the AC OUTLET does not exceed the stated capacity (e.g., 100 W).

Notes:

- Onkyo components with **(R)** jacks should be connected directly to wall outlets, not the AV receiver's AC OUTLET.
- The socket type and capacity will depend on the country in which you purchased the AV receiver.

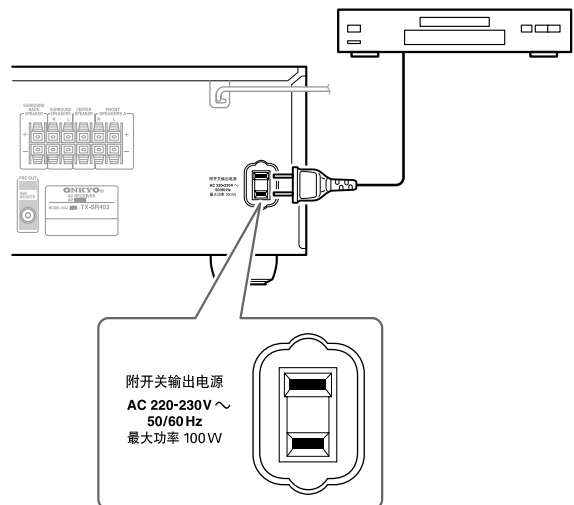

Connecting Onkyo RI Components

Step 1: Be sure that the Onkyo component is connected to the AV receiver with an analog audio cable (RCA).

Step 2: Make the **RI** connection.

With **RI** (Remote Interactive) you can use the following special **RI** functions:

Auto Power On/Standby

When you start playback on a component connected via **RI**, if the AV receiver is in Standby, it will turn on and select that component as the input source automatically. Similarly, when the AV receiver is set to Standby, all components connected via **RI** will also enter Standby. This function will not work if a component's power cord is connected to the AV receiver's AC OUTLET.

Direct Change

When playback is started on a component connected via **RI**, the AV receiver automatically selects that component as the input source. If the DVD player is connected to the AV receiver's multichannel input, you must press the [MULTI CH] button (see page 35) to listen to all channels because the Direct Change **RI** function selects only the DVD IN FRONT jacks.

Notes:

- Use only **RI** cables for **RI** connections. **RI** cables are supplied with Onkyo players (DVD, CD, etc.).
- Some components have two **RI** jacks, you can connect either one to the AV receiver. The other is for connecting additional **RI**-compatible components.
- Connect the AV receiver's **RI** jack to only Onkyo components. Connecting to other manufacturer's components may cause them to malfunction.
- Some components may not support all **RI** functions. Refer to the manuals supplied with your components.

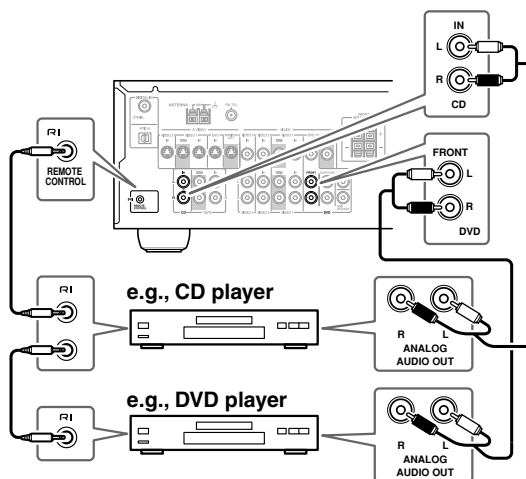

Connecting the Power Cord

Notes:

- **Before connecting the power cord, connect all of your speakers and AV components.**
- Turning on the AV receiver may cause a momentary power surge that might interfere with other electrical equipment on the same circuit. If this is a problem, plug the AV receiver into a different branch circuit.

Turning On

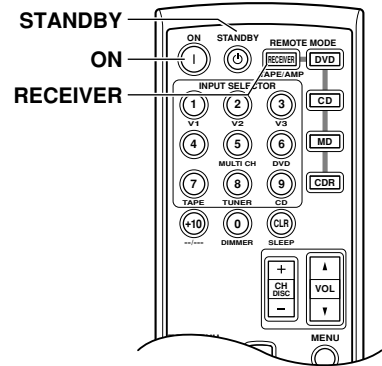
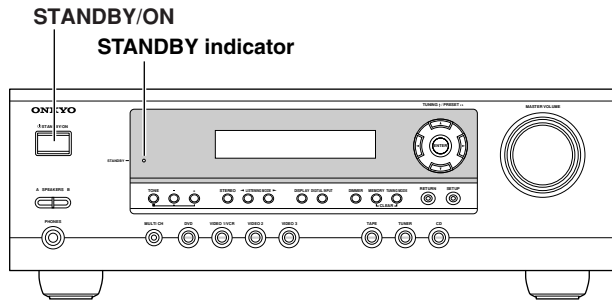

Turning On the AV Receiver

1

AV receiver



or

Remote controller

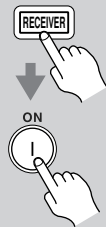

Press the [STANDBY/ON] button.

Alternatively, press the remote controller's [RECEIVER] button followed by the [ON] button.

The AV receiver comes on, the display lights up, and the STANDBY indicator goes off.

To turn the AV receiver off, press the [STANDBY/ON] button, or the remote controller's [STANDBY] button. The AV receiver will enter Standby mode. To prevent any loud surprises the next time you turn on the AV receiver, always turn down the volume before turning it off.

Smooth Operation in a Few Easy Steps

To ensure smooth operation, here's a few easy steps to help you configure the AV receiver before you use it for the very first time. These settings only need to be made once.

■ Have you connected a component to a digital audio input?

If you have, see "Assigning Digital Inputs to Input Sources" on page 31.

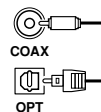

■ Have you connected an Onkyo MD recorder or CD recorder to the TAPE IN/OUT jacks?

If you have, see "Changing the TAPE/MD/CDR Display" on page 31.

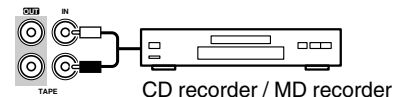

■ Do the speaker configuration—this is essential!

See "Speaker Configuration" on page 32.



First Time Setup

Assigning Digital Inputs to Input Sources

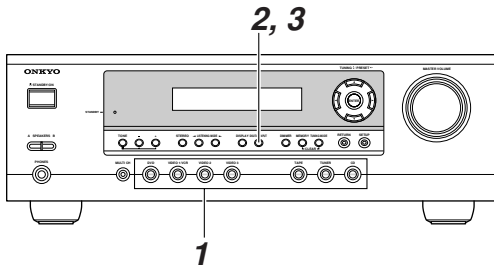

To enjoy Dolby Digital and DTS, you must connect your DVD player to the AV receiver by using a digital audio connection (coaxial or optical).

With this function, you can assign digital inputs to input sources. For example, if you connect your DVD player to DIGITAL IN OPTICAL, you'll need to assign that input (OPT) to the DVD input source.

You can change the assignments as follows.

Note:

Make sure you also set your digital sources to send out a digital signals. Please refer to the digital sources' manual.

1

Press the input selector button for the source that you want to assign.
(Digital inputs cannot be assigned to the TUNER input source.)

2

Press the [DIGITAL INPUT] button.
The current assignment appears.

DVD # COAX

3

Press the [DIGITAL INPUT] button repeatedly to select COAX, OPT or "----" (analog).

DVD # OPT

Changing the TAPE/MD/CDR Display

If you connect an **RI**-compatible Onkyo MiniDisc recorder or CD recorder to the TAPE IN/OUT jacks, for **RI** to work properly, you must change this setting. This setting can only be changed on the AV receiver.

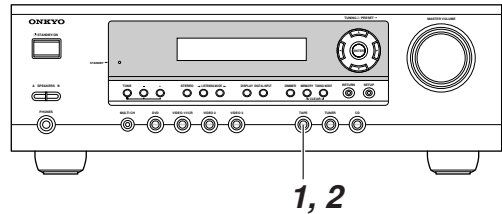

1

Press the [TAPE] input selector button so that "TAPE" appears on the display.

TAPE

2

Press and hold down the [TAPE] input selector button (about 3 seconds) to set the display.
Repeat this step to select TAPE, MD, or CDR.

MD

CDR

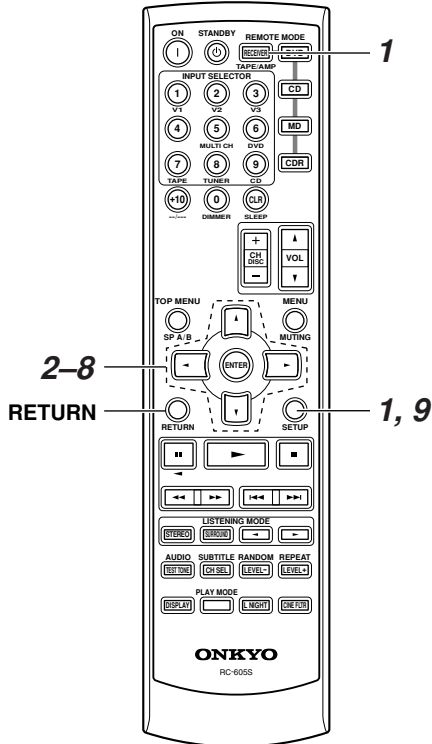

Speaker Configuration

This section explains how to specify which speakers are connected and their sizes.

For speakers with a cone diameter larger than 6-1/2 inches (16 cm), specify **Large**. For those with a smaller diameter, specify **Small**.

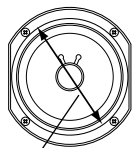

Cone diameter

1 Press the [RECEIVER] button followed by the [SETUP] button.

2 Use the Up and Down [▲]/[▼] buttons to select "1. Speaker Config," and then press the [ENTER] button.

1. Speaker Config

3 While the Subwoofer setting is selected, use the Left and Right [◀]/[▶] buttons to select Yes or No.

Yes: Select if a subwoofer is connected.
No: Select if no subwoofer is connected.

4 Use the Down [▼] button to select "Front," and then use the Left and Right [◀]/[▶] buttons to select Small or Large.

Small: Select if the front speakers are small.
Large: Select if the front speakers are large.

Note:

- If the Subwoofer setting in step 3 is set to No, this setting is fixed at Large and does not appear.

5 Use the Down [▼] button to select "Center," and then use the Left and Right [◀]/[▶] buttons to select Small, Large, or None.

Small: Select if the center speaker is small.
Large: Select if the center speaker is large.
None: Select if no center speaker is connected.

Note:

- If the Front setting in step 4 is set to Small, the Large option cannot be selected.

6

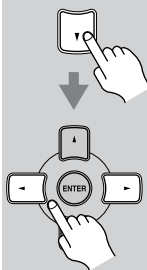

Use the Down [▼] button to select “Surround,” and then use the Left and Right [◀]/[▶] buttons to select **Small**, **Large**, or **None**.

Small: Select if the surround speakers are small.

Large: Select if the surround speakers are large.

None: Select if no surround speakers are connected.

Note:

- If the Front setting in step 4 is set to Small, the Large option cannot be selected.

7

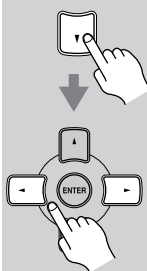

Use the Down [▼] button to select “Surr Back,” and use the Left and Right [◀]/[▶] buttons to select **Small**, **Large**, or **None**.

Small: Select if the surround back speaker is small.

Large: Select if the surround back speaker is large.

None: Select if no surround back speaker is connected.

Notes:

- If the Surround setting in step 6 is set to None, this setting does not appear.
- If the Surround setting in step 6 is set to Small, the Large option cannot be selected.

8



Press the [SETUP] button.

Setup closes.

TESTING THE SPEAKERS

To test that all of the speakers are working properly, **press the remote controller’s [TEST TONE] button**. The test tone will be output by each speaker in turn and the name of each speaker will appear on the display. To turn off the test tone, press the [TEST TONE] button again.

- If the test tone is not produced by a speaker, or it’s produced by a speaker other than that shown on the display, you may have wired the speakers incorrectly and you should check your connections (see page 17).
- If the test tone is not produced by a speaker and its name does not appear on the display, you may have set the speaker settings incorrectly (see page 32).

Playing Your AV Components

Basic AV Receiver Operation

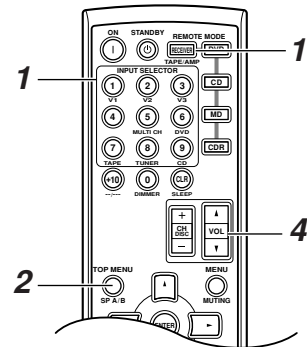
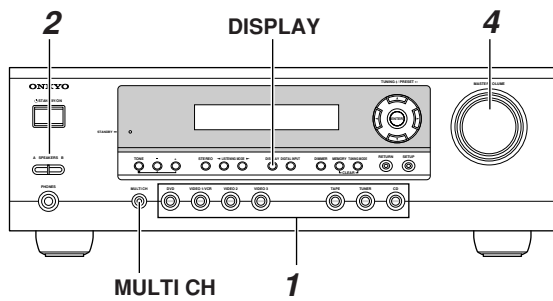

- 1**

AV receiver

Remote controller

Use the AV receiver's input selector buttons to select the input source.

To select the input source with the remote controller, press the [RECEIVER] button, and then use the INPUT SELECTOR buttons.

On the remote controller, the [V1], [V2], and [V3] buttons select the VIDEO 1/VCR, VIDEO 2, and VIDEO 3 input sources respectively.
- 2**

AV receiver

Remote controller

Use the SPEAKERS [A] and [B] buttons on the AV receiver or the [SP A/B] button on the remote controller to select the speaker set that you want to use.

Pressing the remote controller's [SP A/B] button cycles through the following settings: Speaker Set A → Speaker Set A&B → Speaker Set B → Off.

The A and B speaker indicators show whether each speaker set is on or off.

Note that when speaker set B is turned on, speaker set A is reduced to 2.1-channel playback.

A
B
Indicators
- 3**

AV receiver

Start playback on the source component.

When you select DVD or another video component, on your TV you'll need to select the video input that's connected to the AV receiver's MONITOR OUT.
- 4**

AV receiver

Remote controller

To adjust the volume, use the MASTER VOLUME control, or the remote controller's [VOL] button.

The volume can be set to MIN, 1 through 79, or MAX. The AV receiver is designed for home theater enjoyment and has a wide volume range for precise adjustment.
- 5**

AV receiver

Select a suitable listening mode and enjoy!

See page 40.

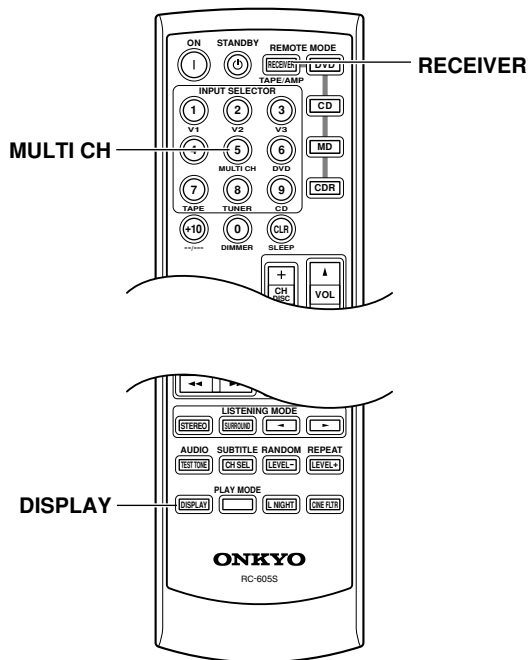

Displaying Source Information

You can display various information about the current input source as follows.

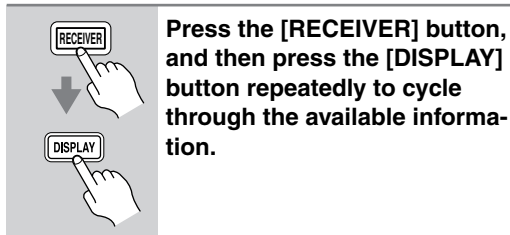

Press the [RECEIVER] button, and then press the [DISPLAY] button repeatedly to cycle through the available information.

The following information can typically be displayed for input sources.

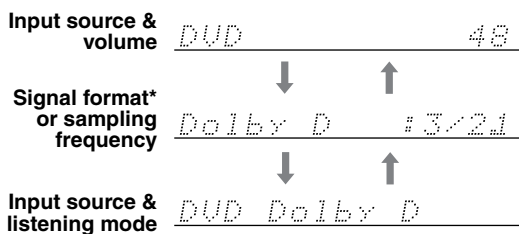

*If the input signal is analog, no format information is displayed. If the input signal is PCM, the sampling frequency is displayed. If the input signal is digital but not PCM, the signal format is displayed. Information is displayed for about three seconds, then the previously displayed information reappears.

Using the Multichannel Input

The multichannel input is for connecting a component with individual 5.1-channel analog audio output jacks, such as a DVD player or MPEG decoder. See page 23 for hookup information.

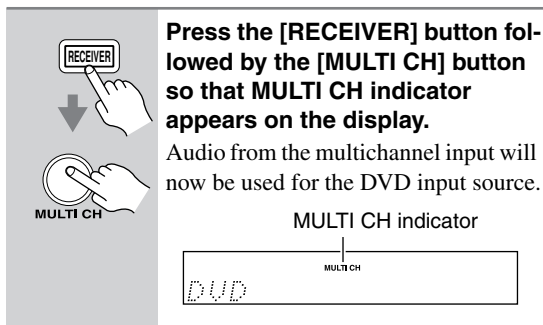

Note:

- While the multichannel input is selected, the Speaker Configuration settings on page 32 are ignored, and signals from the multichannel input are fed to the front left, front right, center, surround left, and surround right speakers and subwoofer regardless of those settings.

Interpreting Surround Channel Information

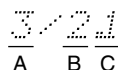

- A: The number of front channels (front left, front right, and center).
- B: The number of surround channels (surround left and surround right). If there's surround back channel information, this number will be 3.
- C: LFE channel for subwoofer (1 means yes).

Using the Tuner

Listening to the Radio

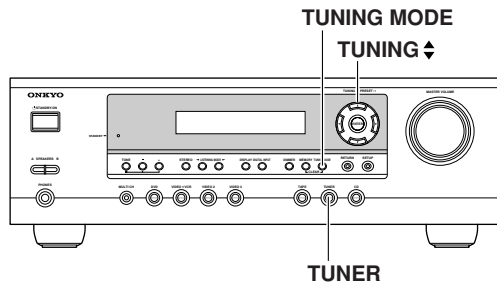

With the built-in tuner, you can enjoy AM and FM radio stations. You can store your favorite stations as presets for quick selection.

1 Use the [TUNER] input selector button to select either AM or FM. In this example, FM has been selected.



FM 87.5 MHz ---

Band Frequency

(Actual display depends on country.)

AM Frequency Step Setup

Here you can specify the AM frequency step used in your area. When this setting is changed, all radio presets are deleted.

- 1** Press the [SETUP] button and use the Up and Down [▲]/[▼] buttons to select “0. Hardware Setup,” and then press [ENTER].
- 2** Use the Up and Down [▲]/[▼] buttons to select “AM Freq,” and then use the Left and Right [◀]/[▶] buttons to select:
 - 10 kHz:** Select if 10 kHz steps are used in your area.
 - 9 kHz:** Select if 9 kHz steps are used in your area.
- 3** Press the [SETUP] button. Setup closes.

Note:

- This procedure can also be performed on the remote controller by using its [SETUP] button, arrow buttons, and [ENTER] button.

Tuning into Radio Stations

Auto Tuning Mode

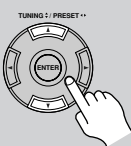
- 1** Press the [TUNING MODE] button so that the AUTO indicator appears on the display.
 
- 2** Press the TUNING Up or Down [▲]/[▼] button. Searching stops when a station is found.
 

When tuned into a station, the TUNED indicator appears. When tuned into a stereo FM station, the FM STEREO indicator appears on the display, as shown.

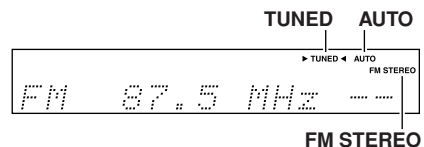

Manual Tuning Mode

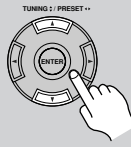
- 1** Press the [TUNING MODE] button so that the AUTO indicator disappears from the display.
 
- 2** Press and hold the TUNING Up or Down [▲]/[▼] button. The frequency stops changing when you release the button. Press the buttons repeatedly to change the frequency one step at a time.
 

It's 0.05 MHz steps for FM and 9 kHz steps for AM. In Manual Tuning mode, FM stations will be in mono.

Tuning into weak FM stereo stations

If the signal from a stereo FM station is weak, it may be impossible to get good reception. In this case, switch to Manual Tuning mode and listen to the station in mono.

Using the Tuner—Continued

Presetting Radio Stations

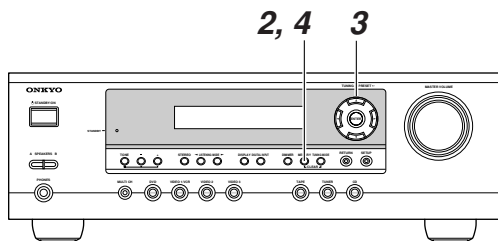

You can store up to 30 of your favorite radio stations as presets.

1 Tune into the station that you want to store as a preset.

2 Press the [MEMORY] button. The MEMORY indicator appears and the preset number flashes.

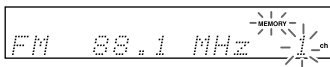

3 While the MEMORY indicator is displayed (about 8 seconds), use the PRESET [◀]/[▶] buttons to select a preset from 1 through 30. In this example, preset #3 is selected.

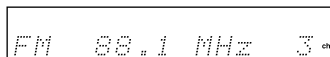

4 Press the [MEMORY] button again to store the station. The station is stored and the preset number stops flashing. Repeat this procedure for all your favorite radio stations.



Deleting Presets

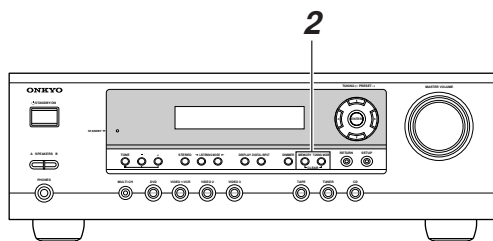

1 Select the preset that you want to delete. See the previous section.

2 While holding down the [MEMORY] button, press the [TUNING MODE] button. The selected preset is deleted and its number disappears from the display.

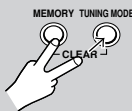

Displaying Radio Information

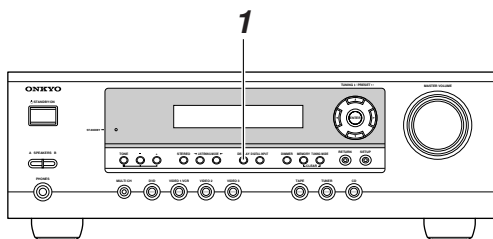

1 Press the [DISPLAY] button repeatedly to cycle through the available information.



Selecting Preset Stations

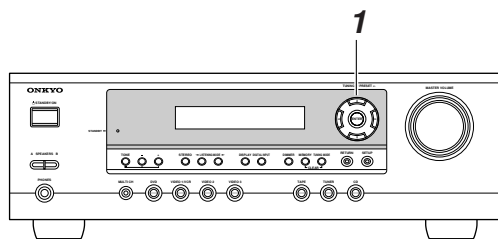

1 Use the PRESET [◀]/[▶] buttons, or the remote controller's CH [+/-] button to select a preset.



Band, preset # & frequency

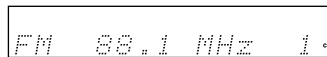

Listening mode

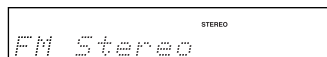

Common Functions

This chapter explains functions that can be used with any input source.

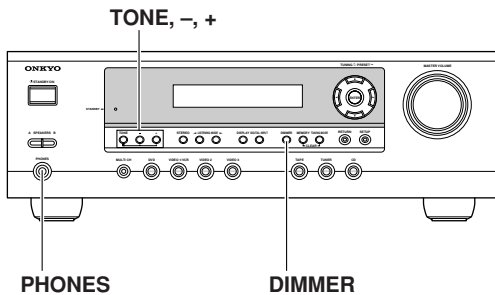
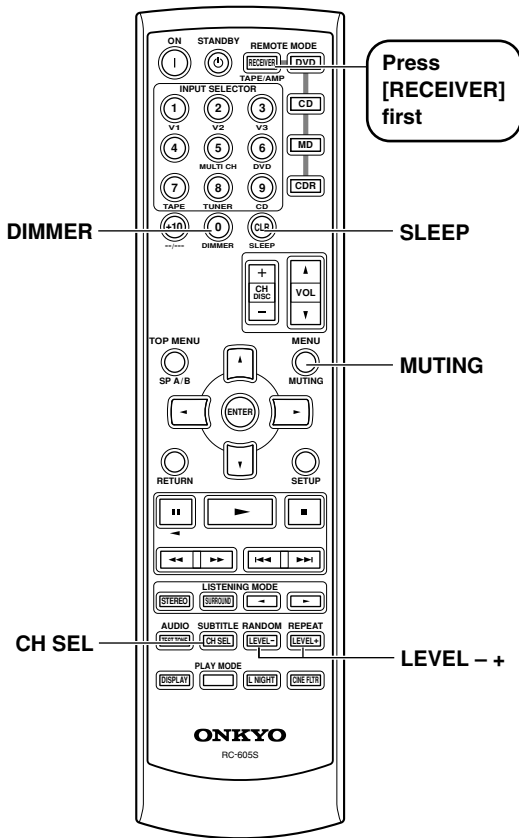

Setting the Display Brightness

With this function, you can adjust the brightness of the display.

AV receiver
DIMMER

Remote controller
DIMMER

Press the [DIMMER] button repeatedly to select: dim, dimmer, or normal brightness.

Adjusting the Bass & Treble

You can adjust the bass or treble for the front speakers except when the Direct listening mode is selected.

1

TONE

Press the AV receiver's [TONE] button repeatedly to select either Bass or Treble.

2

TONE [-]/[+]

Use the TONE [-]/[+] buttons to adjust.

■ Bass

You can boost or cut low-frequency sounds output by the front speakers from -10 dB to +10 dB in 2 dB steps.

■ Treble

You can boost or cut high-frequency sounds output by the front speakers from -10 dB to +10 dB in 2 dB steps.

Note:

- To bypass the bass and treble tone circuits, select the Direct listening mode.

Muting the AV Receiver

With this function, you can temporarily mute the output of the AV receiver.

MUTING

Press the remote controller's [MUTING] button.

The output is muted and the MUTING indicator flashes on the display, as shown.

To unmute the AV receiver, press the remote controller's [MUTING] button again, or adjust the volume. The output is unmuted and the MUTING indicator goes off. Muting is cancelled when the AV receiver is set to Standby.

Using the Sleep Timer

With the sleep timer, you can set the AV receiver so that it automatically turns off after a set period.



Press the remote controller's [SLEEP] button repeatedly to select the required sleep time.

You can set the sleep time from 90 to 10 minutes in 10 minute steps.

The SLEEP indicator appears on the display when the sleep timer has been set, as shown. The specified sleep time appears on the display for about five seconds, then the previous display reappears.

SLEEP indicator

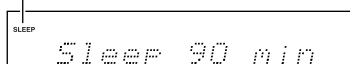

To cancel the sleep timer, press the [SLEEP] button repeatedly until the SLEEP indicator disappears.

To check the remaining sleep time, press the [SLEEP] button. Note that if you press the [SLEEP] button while the sleep time is being displayed, you'll shorten the sleep time by 10 minutes.

Using Headphones

You can connect a pair of stereo headphones (1/4-inch phone plug) to the AV receiver's PHONES jack for private listening, as shown.

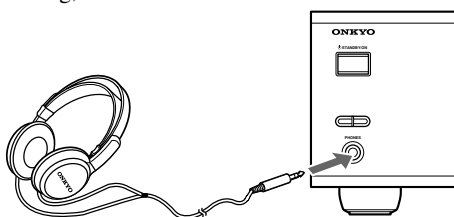

Notes:

- Always turn down the volume before connecting your headphones.
- Speaker sets A and B are turned off while the headphones plug is inserted in the PHONES jack.
- When you connect a pair of headphones, the listening mode is set to Stereo, unless it's already set to Mono, Stereo, or Direct.
- When the multichannel DVD input is selected, only the front left and front right channels can be heard in the headphones.

Adjusting Speaker Levels

You can adjust the level of each speaker in speaker set A while listening to an input source. These temporary adjustments are cancelled when the AV receiver is set to Standby.

1

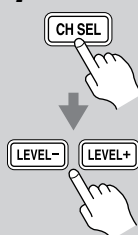

Use the remote controller's [CH SEL] button to select each speaker, and use the [LEVEL-] and [LEVEL+] buttons to adjust the volume.

You can adjust the volume of each speaker from -12 dB to +12 dB (-15 dB to +12 dB for the subwoofer).

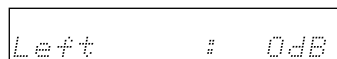

Notes:

- You cannot use this function while the AV receiver is muted.
- Speakers that are set to No or None in the Speaker Configuration cannot be adjusted.

■ Speaker Set B

While speaker set B is on, you can also adjust the levels of the left and right speakers in speaker set B, from -12 dB to +12 dB.

- These settings are stored when the AV receiver is set to Standby.
- While speaker set B is on, you can adjust the levels of the left and right speakers in speaker set A's and the subwoofer.

■ Headphones

While a pair of headphones is connected, you can adjust the volume of the left and right channels individually, from -12 dB to +12 dB each.

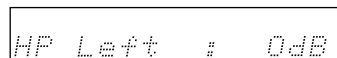

- These settings are stored when the AV receiver is set to Standby.

■ Multichannel DVD Input

While the multichannel DVD input is selected, you can adjust the level of each 5.1 channel input individually, from -12 dB to +12 dB. (-30 to +12 dB for the subwoofer.)

- These settings are stored when the AV receiver is set to Standby.
- Individual speaker levels can also be adjusted in "3. MultiLevel Setup" (see page 49).

Using the Listening Modes

Selecting Listening Modes

See “About the Listening Modes” on page 42 for detailed information about the listening modes.

- The Dolby Digital and DTS listening modes can only be selected if your DVD player is connected to the AV receiver with a digital audio connection (coaxial or optical).
- Listening mode availability depends on the format of the current input signal.
- While a pair of headphones is connected, or speaker B is on, you can select only the Mono, Direct, or Stereo listening mode.

Selecting on the AV receiver

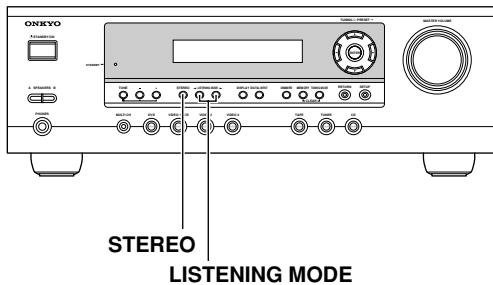

■ [STEREO] button

This button selects the Stereo listening mode.

■ LISTENING MODE [◀/▶] buttons

Pressing these buttons repeatedly cycles through all of the listening modes that can be used with the current input source.

Selecting with the Remote Controller

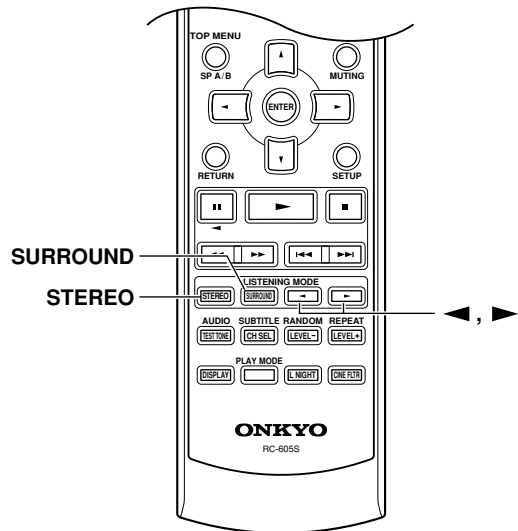

■ [STEREO] button

This button selects the Stereo listening mode.

■ [SURROUND] button

This button selects the Dolby Digital and DTS listening modes.

■ LISTENING MODE [◀/▶] buttons

Pressing these buttons repeatedly cycles through all of the listening modes that can be used with the current input source.

Using the Listening Modes—Continued

The following table lists all the listening modes and shows which modes can be selected for each input signal format.

Input signal format		Analog, PCM ^{*1}	Dolby D				DTS/DTS 96/24 ^{*2}			Multich
			*2	2/0 (Stereo)	1/0,1+1	Other	3/2.1	2/0 (Stereo)	DTS-ES	
Listening mode		Source	DVD, DTV, etc.				DVD, CD, etc.			DVD
Direct		✓	✓	✓	✓	✓	✓	✓	✓	✓
Stereo		✓	✓	✓	✓	✓	✓	✓	✓	
Mono										
Multich										✓
PLIIx Movie/Music/Game ^{*3}										
Neo:6 Cinema		✓		✓				✓		
Neo:6 Music ^{*4}										
Dolby	Dolby D		✓			✓				
	Dolby D EX		✓							
	Dolby D+PLIIx Music									
DTS	DTS					✓			✓ ^{*5}	
	DTS-ES Discrete							✓		
	DTS-ES Matrix								✓	
	DTS+Neo:6 DTS+Dolby EX DTS+PLIIx Music					✓				
Onkyo Original DSP	Mono Movie Orchestra Unplugged Studio-Mix TV Logic All Ch Stereo Full Mono ^{*4}	✓	✓	✓	✓	✓	✓	✓	✓	

*1. In the Direct listening modes, PCM signals at 32 kHz, 44.1 kHz, and 48 kHz are processed at 64 kHz, 88.2 kHz, and 96 kHz respectively. 96 kHz signals are processed at 48 kHz for all listening modes other than Direct, and Stereo.

*2. DTS 96/24 is always processed as DTS.

*3. If the Surr Back parameter is set to "None," PLII is used.

*4. Available only when Surround speakers are connected.

*5. If the Surr Back setting is set to "None," DTS is used.

■ : Not available when the Surr Back parameter is set to None.

Tip: You can check the format of the digital input signal on page 35, "Displaying Source Information."

About the Listening Modes

With its built-in surround-sound decoders and DSP programs, the AV receiver can transform your home listening room into a movie theater or concert hall.

The AV receiver's surround indicators show which speakers are active in each listening mode.

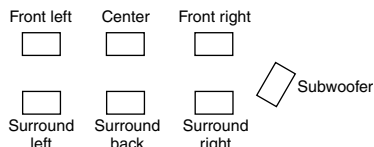

Direct

The selected input source is output directly with minimal processing for a pure sound.

Stereo

The selected input source is processed as a stereo signal and output by the front left and right speakers and the subwoofer.

Mono

Use this mode when watching an old movie with a mono soundtrack, or to select multilingual soundtracks recorded in the left and right channels of some movies. It can also be used when playing a DVD or other source with multiplexed audio, such as a karaoke DVD.

Dolby Pro Logic II Movie

Use this mode with DVDs and videos that bear the Dolby Surround logo or TV shows that feature Dolby Surround. You can also use this mode with stereo movies or TV shows and the AV receiver will create a 5.1 surround mix from the 2-channel stereo.

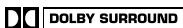

Dolby Pro Logic II Music

Use this mode to add 5.1 surround to stereo sources such as music CDs and DVDs.

Dolby Pro Logic II Game

Use this mode when playing game discs.

Dolby Pro Logic IIx

If you've connected surround back speaker to the AV receiver, Dolby Pro Logic IIx allows you to enjoy 7.1-channel playback from 2-channel or 5.1-channel music or movies. Dolby Pro Logic IIx provides a well defined, natural multichannel surround-sound experience, putting the listener in a seamless envelope of sound. The added drama and natural sound enhance the listening experience with CDs, movies, and games.

Dolby Pro Logic IIx has three modes of operation: Movie mode for movies, Music mode for listening to music, and Game mode for use with games consoles with 2-channel stereo outputs.

Dolby Digital

With this format you can experience the same superb sound that you get at a movie theater or concert hall. Use this mode with DVDs that bear the Dolby Digital logo.



Dolby Digital EX

With an added surround-back channel, this 6.1 channel format offers a heightened sense of space, for added realism with moving sounds, such as those that rotate 360 degrees or pass overhead. Dolby Digital EX material can also be played on conventional 5.1 channel systems, in which case the surround-back channel audio is split between the surround left and right channels. Use this mode with DVDs that have a 5.1-channel soundtrack and bear the Dolby Digital logo.



DTS

This digital surround format offers a surround sound experience with exceptional fidelity. It uses compressed digital audio data, with six discrete channels (5.1), and the ability to handle large amounts of audio data while remaining faithful to the original. DTS provides very high-quality sound. You'll need a DTS compatible DVD player in order to enjoy DTS material. Use this mode with DVDs and CDs that bear the DTS logo.



DTS-ES Discrete

This is DTS with an added surround back channel for 6.1 surround sound. Use it with program material recorded in DTS 6.1 format. With the additional surround back channel, this format offers 6.1 fully independent digital channels, providing a realistic sense of movement and space. Use it with program material recorded in DTS 6.1, such as CDs and DVDs that bear the DTS-ES logo.



DTS-ES Matrix

This is DTS with an added surround back channel for 6.1 surround sound. Use it to provide 6.1 channel surround playback with program material recorded in DTS 5.1 format. Since DTS 5.1 program material contains surround back channel information, all channels can be reconstructed for 6.1-channel playback. Use this mode with CDs and DVDs that bear the DTS-ES or DTS logo.



Neo:6

This mode provides 6.1-channel playback from 2-channel sources. It offers six full-bandwidth channels with excellent separation. There are two modes of operation: Cinema mode for movies, and Music mode for listening to music.

Cinema mode simulates the realistic sense of movement that you get with 6.1-channel surround sound sources. Use this mode with videos, DVDs, and TV shows that feature stereo sound.

Music mode uses the surround channels to simulate a natural sound field that cannot be produced with conventional stereo. Use this mode with stereo material such as music CDs.

Onkyo Original DSP Modes

Mono Movie

This mode is suitable for use with old movies and other mono sound sources. The center speaker outputs the sound as it is, while reverb is applied to the sound output by the other speakers, giving presence to even mono material.

Orchestra

Suitable for classical or operatic music. The surround channels are emphasized in order to widen the stereo image. In addition, it simulates the natural reverberation of a large hall.

Unplugged

Suitable for acoustic instrument sounds, vocals, and jazz music. By emphasizing the front stereo image, it simulates the stage-front experience.

Studio-Mix

Suitable for rock and pop music. Listening to music in this mode creates a lively sound field with a powerful acoustic image, like being at a club or rock concert.

TV Logic

Adds realistic acoustics to TV shows produced in a TV studio. In addition, it adds surround effects to the entire sound and adds clarity to voices.

All Ch Stereo

Ideal for background music. The front, surround, and surround back channels create a stereo image that fills the entire listening area.

Full Mono

In this mode, all speakers output mono audio, so the music sounds the same regardless of where you are.

Adjusting the Listening Modes

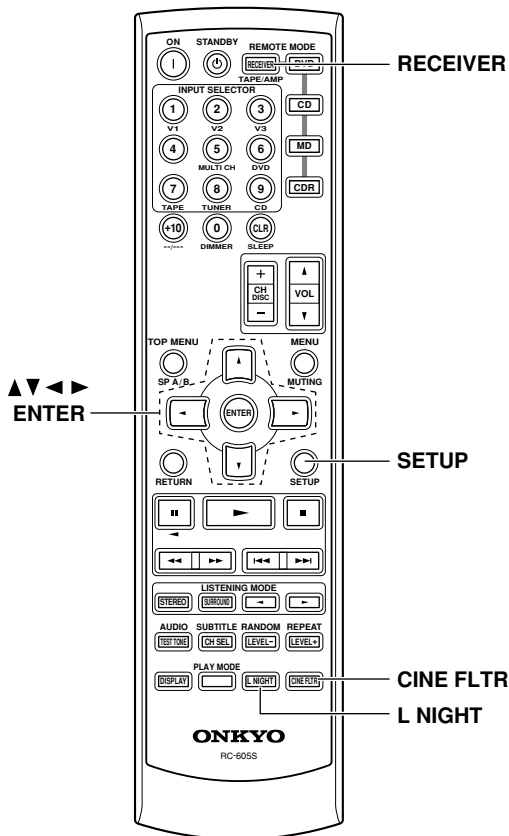

Using the Late Night Function (Dolby Digital only)

With the Late Night function, you can reduce the dynamic range of Dolby Digital material so that you can still hear quiet parts even when listening at low volume levels—ideal for watching movies late at night when you don't want to disturb anyone.

- Press the [RECEIVER] button, and then press the [L NIGHT] button repeatedly to select:

 - Off:** Late Night function off.
 - Low:** Small reduction in dynamic range.
 - High:** Big reduction in dynamic range.

Notes:

- The effect of the Late Night function depends on the Dolby Digital material that you are playing, and with some material there will be little or no effect.
- The Late Night function is set to Off when the AV receiver is set to Standby.

Using the CinemaFILTER

With the CinemaFILTER, you can soften overly bright movie soundtracks, which are typically mixed for reproduction in a movie theater.

CinemaFILTER can be used with the following listening modes: Dolby Digital, Dolby Digital EX, Dolby Pro Logic II Movie, Dolby Pro Logic IIx Movie, DTS, DTS-ES, DTS Neo:6 Cinema, DTS+Neo:6, and DTS+Dolby EX.

- Press the [RECEIVER] button, and then press the [CINE FLTR] button repeatedly to select:

 - On:** CinemaFILTER on.
 - Off:** CinemaFILTER off.



Using the Audio Adjust Functions

These functions only work with speaker set A. Audio Adjust provides various functions for adjusting the sound.

- Press the [RECEIVER] button followed by the [SETUP] button.
- Use the Up and Down [▲]/[▼] buttons to select "4. Audio Adjust," and then press the [ENTER] button.

4. Audio Adjust

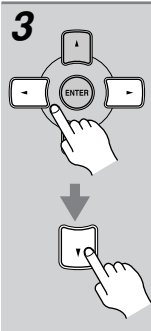
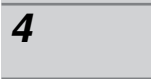
Adjusting the Listening Modes—Continued

	<p>3 Use the Left and Right [◀]/[▶] buttons to change the settings. Press the Down [▼] button to select the next setting.</p>
	<p>4 Repeat step 3 to complete all settings.</p>
	<p>5 Press the [SETUP] button. Setup closes.</p>

The Audio Adjust functions are explained below.

Input Channel Settings

■ Multiplex

This setting determines which channel is output from a stereo multiplex source. Use it to select audio channels or languages with multiplex sources, multilingual TV broadcasts, and so on.

Main: The main channel is output (default).

Sub: The sub channel is output.

M/S: Both the main and sub channels are output.

■ Mono (2ch)

This setting determines which channel is output when the Mono listening mode is used with a stereo source.

L+R: Both the left and right channels are output (default).

L: Only the left channel is output.

R: Only the right channel is output.

PL II & PL IIX Music Mode Settings

These settings apply to only 2-channel (stereo) sources.

■ Panorama

With this function, you can broaden the width of the front stereo image when using the Pro Logic II Music or Pro Logic IIX Music listening mode.

On: Panorama function on.

Off: Panorama function off (default).

■ Dimension

With this setting, you can move the sound field forward or backward when using the Pro Logic II Music or Pro Logic IIX Music listening mode. The default setting is 3. Higher settings move the sound field forward. Lower settings move it backward.

If the stereo image feels too wide, or there's too much surround sound, move the sound field forward to improve the balance. Conversely, if the stereo image feels like it's in mono, or there's not enough surround sound, move it backward.

■ Center Width

With this function, you can adjust the width of the sound from the center speaker when using the Pro Logic II Music or Pro Logic IIX Music listening mode. Normally if you're using a center speaker, the center channel sound is output by only the center speaker. (If you're not using a center speaker, the center channel sound will be distributed to the front left and right speakers to create a phantom center). This setting controls the front left, right, and center mix, allowing you to adjust the weight of the center channel sound. It can be adjusted from 0 to 7 (default is 3).

DTS Neo:6 Music Mode Setting

■ Center Image

The DTS Neo:6 Music listening mode creates 6-channel surround sound from 2-channel (stereo) sources. With this setting, you can specify by how much the front left and right channel output is attenuated in order to create the center channel. It can be adjusted from 0 to 5 (default is 3). This setting is unavailable if no surround speakers are connected.

When set to 0, the front left and right channel output is attenuated by half (–6 dB), giving the impression that the sound is located centrally. This setting works well when the listening position is considerably off center. When set to 5, the front left and right channels are not attenuated, maintaining the original stereo balance.

Dolby Digital EX Input Signal Setting

■ Dolby D EX

This setting determines how Dolby Digital EX signals are handled. This setting is unavailable if no surround back speaker is connected or speaker B is on.

Auto: If the source signal contains a Dolby Digital EX flag, the Dolby Digital EX listening mode is used (default).

Manual: You can select Pro Logic IIX Music, Dolby Digital, or Dolby Digital EX.

Recording

This chapter explains how to record the selected input source to an AV component with recording capability, and how to record audio and video from two different sources.

Recording the Input Source

You can record only to AV components that are connected to the TAPE OUT or VIDEO 1 OUT jacks. See pages 20–29 for information on connecting your AV components to the AV receiver.

1	<p>Use the input selector buttons to select the AV component that you want to record.</p> <p>Audio signals from the selected input source are output by the VIDEO 1 OUT and TAPE OUT jacks.</p> <p>You can listen to the source while recording. The AV receiver's VOLUME control has no effect on recording.</p>
2	<p>Start recording on the AV component connected to the TAPE OUT or VIDEO 1 OUT jacks.</p>
3	<p>Start playback on the source AV component.</p>

Notes:

- You cannot record from AV components that are connected to the digital inputs. You must use analog connections.
- The surround effects produced by the surround and DSP listening modes cannot be recorded.
- You cannot record from an AV component that is connected to the multichannel input.
- If you select another input source while recording, that input source will be recorded instead.

Recording from Different AV Sources

With this function, you can record audio and video from different sources, allowing you to overdub audio onto your video recordings. This function takes advantage of the fact that when an audio-only input source (i.e., TAPE, TUNER, or CD) is selected, the video input source remains unchanged. For example, if you first select the VIDEO 3 input source, followed by the CD input source, you can watch the video from the VIDEO 3 input and listen to the audio from the CD input.

In the following example, audio from the CD player connected to the CD IN jacks, and video from the camcorder connected to the VIDEO 3 IN jack are recorded by the VCR, which is connected to the VIDEO 1 OUT jacks.

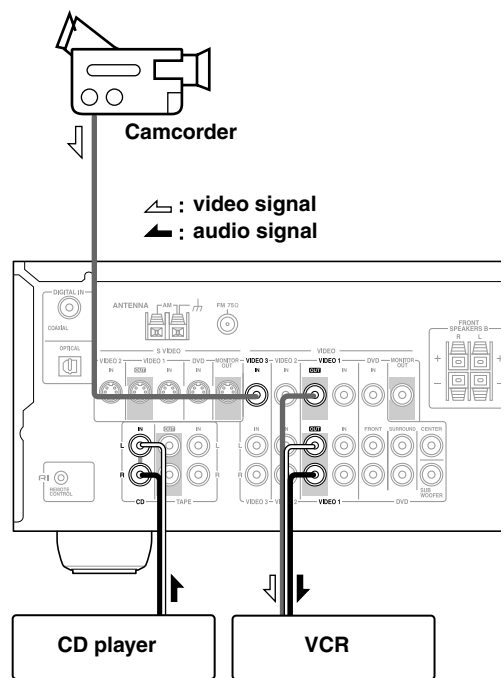

- 1. Prepare the camcorder and CD player for playback.**
- 2. Prepare the VCR for recording.**
- 3. Press the [VIDEO 3] input selector button.**
- 4. Press the [CD] input selector button.**

This selects the CD player as the audio source, but leaves the camcorder as the video source.
- 5. Start recording on the VCR and start playback on the camcorder and CD player.**

The video from the camcorder and the audio from the CD player are recorded by the VCR.

Advanced Setup

Advanced Speaker Settings

The advanced speaker settings cannot be changed while headphones are connected, Speaker set B is on, or the multichannel input is being used.



Crossover Frequency

To get the best bass performance from your speaker system, you need to set the crossover frequency according to the size and frequency response of your subwoofer and other speakers (front, center, and surround).

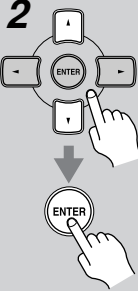
- 

1 Press the [RECEIVER] button followed by the [SETUP] button on the remote controller.
- 

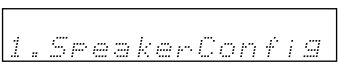
2 Use the Up and Down [▲]/[▼] buttons to select “1. Speaker Config,” and then press the [ENTER] button.

- 

3 Use the Down [▼] button to select “Crossover,” and then use the Left and Right [◀]/[▶] buttons to select a crossover frequency.

Choose a crossover frequency suitable for your setup.

If you’re using a subwoofer, choose a crossover frequency based on the diameter of your front speakers.

If you’re not using a subwoofer, use the diameter of the first speaker that you specified as Small in steps 4 through 7 in the “Speaker configuration” setting (see page 32).

Speaker cone diameter	Crossover frequency
Over 8 in. (20 cm)	60Hz
6-1/2 to 8 in. (16–20 cm)	80Hz
5-1/4 to 6-1/2 in. (13–16 cm)	100Hz
3-1/2 to 5-1/4 in. (9–13 cm)	120Hz
Under 3-1/2 in. (9 cm)	150Hz

Continue with step 4 of the “Double Bass” setting.

Note:

- For a more accurate setting, look up the frequency response in the manuals supplied with your speakers and set accordingly. In addition, listen to some music that you know well and choose a higher crossover frequency if you think there’s not enough sound coming from the subwoofer; a lower setting if you think there’s too much.

Double Bass

With the Double Bass function, you can boost bass output by feeding bass sounds from the front left and right channels to the subwoofer. This function can be set only if the Subwoofer setting (step 3) is set to Yes, and the Front setting (step 4) is set to Large in the Speaker Configuration on page 32.

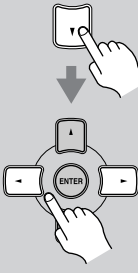
- 

4 Use the Down [▼] button to select “Double Bass,” and then use the Left and Right [◀]/[▶] buttons to select:











On: Double Bass function on.
Bass from the front left and right channels is also fed to the subwoofer (default).

Off: Double Bass function off.
- 

5 Press the [SETUP] button.
Setup closes.

Speaker Distance

To get the best from surround sound, it's important that the sound from each speaker reaches the listener at the same time. To achieve this, you need to specify the distance from each speaker to the listening position.

1	Measure and make a note of the distance from each speaker to the listening position.
2  	Press the [RECEIVER] button followed by the [SETUP] button on the remote controller.
3    	Use the Up and Down [▲]/[▼] buttons to select "2. Sp Distance," and then press the [ENTER] button. <div style="border: 1px solid black; padding: 5px; text-align: center; margin-top: 10px;">2. Sp Distance</div>
4  	While "Unit" is displayed, use the Left and Right [◀]/[▶] buttons to select "feet" or "meters". feet: Distances in feet. Can be set from 1 to 30 feet in 1-foot steps. meters: Distances in meters. Can be set from 0.3 to 9 meters in 0.3-meter steps.
5   	Use the Down [▼] button to select "Front," and use the Left and Right [◀]/[▶] buttons to specify the distance for the "front speakers," then press the Down [▼] button to select the next speaker.
6	Repeat step 5 for all speakers. Note: Speakers that you set to No or None in the Speaker Configuration (page 32) cannot be selected.
7	Press the [SETUP] button. Setup closes.





Notes:

- The Center and Subwoofer distances can be set up to 5 ft. (1.5 m) more or less than the Front distance. For example, if the Front distance is set to 20 ft. (6 m), the Center and Subwoofer distances can be set between 15 and 25 ft. (4.5 and 7.5 m).
- The Surround and Surround Back distances can be set up to 5 ft. (1.5 m) more or 15 ft. (4.5 m) less than the Front distance. For example, if the Front distance is set to 20 ft. (6 m), the SurrRight, Surr Left, Surr Back distances can be set between 5 and 25 ft. (1.5 and 7.5 m).

Speaker Levels

With this function, you can adjust the volume of each speaker so that all speakers can be heard equally at the listening position.

Speaker levels cannot be adjusted while the AV receiver is muted.

1  	Press the [RECEIVER] button followed by the [SETUP] button on the remote controller.
2   	Use the Up and Down [▲]/[▼] buttons to select "3. Level Cal," and then press the [ENTER] button. A pink noise test tone is output by the front left speaker. <div style="border: 1px solid black; padding: 5px; text-align: center; margin-top: 10px;">3. Level Cal</div>
3	Turn up the volume so that you can hear the test tone sufficiently. While each speaker outputs the test tone, its name appears on the display, as shown. <div style="border: 1px solid black; padding: 5px; text-align: center; margin-top: 10px;">Left : 0dB</div>

4

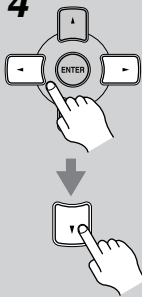

Use the Left and Right [◀]/[▶] buttons to adjust the speaker level, and use the Down [▼] button to select the next speaker.

The level can be adjusted from -12 to +12 dB in 1 dB steps (-15 to +12 dB for the subwoofer).

5

Repeat step 4 so that the level of the test tone from each speaker is the same.

Speakers that you set to No or None in the Speaker Configuration (page 32) do not output the test tone.

6

Press the [SETUP] button.

Setup closes.

Don't forget to turn down the volume if you turned it up while setting the levels.

Note:

- A quicker way to adjust the speaker levels is to press the remote controller's [TEST TONE] button to output the test tone, use the [LEVEL-] and [LEVEL+] buttons to adjust the levels, and use the [CH SEL] button to select the speakers.
- If the multichannel input is selected (page 35), in step 2, the "3. MultiLevel" menu appears instead of the "3. Level Cal" menu, and you can adjust the level of each channel of the multichannel input regardless of the Speaker Configuration settings.

Digital Input Signal Formats

The following table shows the display indicators for each supported digital signal format.

Format	Display
Dolby Digital	D
DTS	
PCM	PCM

Normally, the AV receiver detects the signal format automatically. However, if you experience either of the following issues when playing PCM or DTS material, you can manually set the signal format to PCM or DTS:

- If the beginnings of tracks from a PCM source are cut off, try setting the format to PCM.
- If noise is produced when fast forwarding or reversing a DTS CD, try setting the format to DTS.

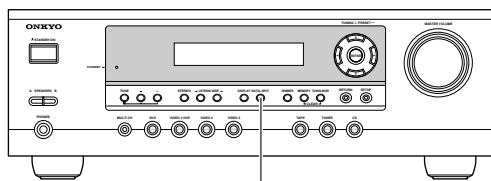

DIGITAL INPUT

1 Press and hold the AV receiver's [DIGITAL INPUT] button for about 3 seconds.

2 While "Auto" is displayed (about 3 seconds), press the [DIGITAL INPUT] button again to select: PCM, DTS, or Auto.

DTS or PCM: The DTS or PCM indicator, depending on which format you have set, flashes, and only signals in that format are output. Digital signals in other formats are ignored.

Auto (default): The format is detected automatically. If no digital input signal is present, the corresponding analog input is used instead.

Troubleshooting

If you have any trouble using the AV receiver, look for a solution in this section. If you can't resolve the issue yourself, contact your Onkyo dealer.

Power

Can't turn on the AV receiver?

- Make sure that the power cord is properly plugged into the wall outlet.
- Unplug the power cord from the wall outlet, wait five seconds or more, then plug it in again.

The AV receiver turns off as soon as it's turned on?

- The amp protection circuit has been activated. Remove the power cord from the wall outlet immediately. Disconnect all speaker cables and input sources, and leave the AV receiver with its power cord disconnected for one hour. After that, reconnect the power cord, and then set the volume to maximum. If the AV receiver stays on, set the volume to minimum, disconnect the power cord, and reconnect your speakers and input sources properly. If the AV receiver turns off when you set the volume to maximum, disconnect the power cord, and contact your Onkyo dealer.

Audio

There's no sound or it's very quiet?

- Make sure that the digital input source is selected properly (page 31). Press the [DIGITAL INPUT] button repeatedly.
- Make sure that all audio connecting plugs are pushed in all the way (page 20).
- Make sure that the polarity of the speaker cables is correct, and that the bare wires are in contact with metal part of each speaker terminal (page 17)
- Make sure that the speaker cables are not shorting.
- Check the volume. It can be set to MIN, 1 through 79, or MAX (page 34). The AV receiver is designed for home theater enjoyment and has a wide volume range for precise adjustment.
- If the MUTING indicator is shown on the display, press the remote controller's [MUTING] button to unmute the AV receiver (page 38).
- While a pair of headphones is connected to the PHONES jack, no sound is output by the speakers (page 39).
- Check the digital audio output setting on the connected device. On some games consoles, such as those that can play DVDs, the default setting is off.
- With some DVD-Video discs, you need to select an audio format from a menu.
- If your turntable doesn't have a phono preamp built-in, you must connect one between it and the AV receiver.

If your turntable uses an MC cartridge, you must connect an MC head amp, or an MC transformer and a phono preamp.

- Specify the speaker distances and adjust the individual speaker levels (pages 48, 49).
- The input signal format is set to PCM or DTS. Set it to Auto (page 49).

Only the front speakers produce sound?

- When the Stereo or Mono listening mode is selected, only the front speakers and subwoofer produce sound.
- Make sure the speakers are configured correctly (page 32).

Only the center speaker produces sound?

- If you use the Pro Logic IIX Movie or Pro Logic IIX Music listening mode with a mono source, such as an AM radio station or mono TV program, the sound is concentrated in the center speaker.
- Make sure the speakers are configured correctly (page 32).

The surround speakers produce no sound?

- When the Stereo or Mono listening mode is selected, the surround speakers produce no sound (page 40).
- Depending on the source and current listening mode, not much sound may be produced by the surround speakers. Try selecting another listening mode.
- Make sure the speakers are configured correctly (page 32).

The center speaker produces no sound?

- When the Stereo or Mono listening mode is selected, the center speaker produces no sound (page 40).
- Make sure the speakers are configured correctly (page 32).

The surround back speaker produces no sound?

- The surround back speaker is not used with all listening modes. Select another listening mode (page 40).
- Not much sound may be produced by the surround back speaker with some sources.
- Make sure the speakers are configured correctly (page 32).

The subwoofer produces no sound?

- The subwoofer outputs no sound while only speaker set B is on. Turn on speaker set A.
- When you play source material that contains no information in the LFE channel, the subwoofer produces no sound.
- Make sure the speakers are configured correctly (page 32).
- If the multichannel DVD input is selected and speaker set B is on, speaker set A is reduced to 2-channel playback, so the subwoofer outputs no sound.

There's no sound with a certain signal format?

- Check the digital audio output setting on the connected device. On some games consoles, such as those that can play DVDs, the default setting is off.
- With some DVD-Video discs, you need to select an audio output format from a menu.

Can't get 6.1-channel playback?

- When speaker B is turned on, speaker set A is reduced to 2.1-channel playback.

The volume cannot be set to 79?

- When the levels of all speakers have been calibrated (page 48), the maximum volume setting may change.

Noise can be heard?

- Using cable ties to bundle audio cables with power cords, speaker cables, and so on may degrade the audio performance, so don't do it.
- An audio cable may be picking up interference. Try repositioning your cables.

The Late Night function doesn't work?

- Make sure the source material is Dolby Digital (page 44).

The DVD analog multichannel input doesn't work?

- Check the DVD analog multichannel input connections (page 23).
- To select the DVD analog multichannel input, press the [MULTI CH] input selector button.
- Check the audio output settings on your DVD player.

About DTS signals

- When DTS program material ends and the DTS bitstream stops, the AV receiver remains in DTS listening mode and the DTS indicator remains on. This is to prevent noise when you use the pause, fast forward, or fast reverse function on your player. If you switch your player from DTS to PCM, because the AV receiver does not switch formats immediately, you may not hear any sound, in which case you should stop your player for about three seconds, and then resume playback.
- With some CD players, you won't be able to playback DTS material properly even though your player is connected to a digital input on the AV receiver. This is usually because the DTS bitstream has been processed (e.g., output level, sampling rate, or frequency response changed) and the AV receiver doesn't recognize it as a genuine DTS signal. In such cases, you may hear noise.
- When playing DTS program material, using the pause, fast forward, or fast reverse function on your player may produce a short audible noise. This is not a malfunction.

Video

There's no picture?

- Make sure that all video connecting plugs are pushed in all the way (page 20).
- Make sure that each video component is properly connected.
- The AV receiver does not convert between formats. So if your video component is connected to a composite video input, your TV must be connected to the composite video output (page 21).
- On your TV, make sure that the video input to which the AV receiver is connected is selected.

Tuner

Reception is noisy, stereo FM reception suffers from hiss, or the FM STEREO indicator doesn't appear?

- Relocate your antenna.
- Move the AV receiver away from your TV or computer.
- Listen to the station in mono (page 36).
- When listening to an AM station, operating the remote controller may cause noise.
- Passing cars and airplanes can cause interference.
- Concrete walls weaken radio signals.
- If nothing improves the reception, install an outdoor antenna.

Remote Controller

The remote controller doesn't work?

- Make sure that the batteries are installed with the correct polarity (page 9).
- Make sure that the remote controller is not too far away from the AV receiver, and that there's no obstruction between the remote controller and the AV receiver's remote control sensor (page 9).
- Make sure you've selected the correct remote controller mode (page 10).
- Make sure you've entered the correct remote control code.

Can't control other components?

- Make sure you've selected the correct remote controller mode (page 10).
- To control Onkyo cassette tape deck, point the remote controller at the AV receiver.
- To control Onkyo CD player or MD/CD recorder, point the remote controller at that component.

Recording

Can't record?

- On your recorder, make sure the correct input is selected.
- To prevent signal loops and damage to the AV receiver, input signals are not fed through to outputs with the same name (e.g., TAPE IN to TAPE OUT, or VIDEO 1 IN to VIDEO 1 OUT).

Others

The sound changes when I connect my headphones?

- When a pair of headphones is connected, the listening mode is set to Stereo, unless it's already set to Stereo, Mono, or Direct.

How do I change the language of a multiplex source?

- Use the "Multiplex" setting on the "4. Audio Adjust" menu to select Main or Sub (page 45).

The **RI** functions don't work?

- To use **RI**, you must make an **RI** connection and an analog audio connection (RCA) between the component and AV receiver, even if they are connected digitally (page 29).

The AV receiver contains a microcomputer for signal processing and control functions. In very rare situations, severe interference, noise from an external source, or static electricity may cause it to lockup. In the unlikely event that this happens, unplug the power cord from the wall outlet, wait at least five seconds, and then plug it back in again.

Onkyo is not responsible for damages (such as CD rental fees) due to unsuccessful recordings caused by the unit's malfunction. Before you record important data, make sure that the material will be recorded correctly.

To reset the AV receiver to its factory defaults, turn it on and, while holding down the [VIDEO 1/VCR] button, press the [STANDBY/ON] button. "Clear" will appear on the display and the AV receiver will enter Standby mode.

Before disconnecting the power cord from the wall outlet, set the AV receiver to Standby.

Specification

Amplifier Section

Power Output	
2 channel driven:	110 W + 110 W (6Ω, 1kHz, JEITA)
Dynamic Power	160 W + 160 W (3Ω, Front)
	125 W + 125 W (4Ω, Front)
	85 W + 85 W (8Ω, Front)
THD (Total Harmonic Distortion)	0.08% (Power Rated)
Damping Factor	60 (Front, 1kHz, 8Ω)
Input Sensitivity and Impedance	200 mV/ 47 kΩ (LINE)
Output Level and Impedance	200 mV/ 470 Ω (REC OUT)
Frequency Response	10 Hz–100 kHz/ +1 dB-3 dB (Direct mode)
Tone Control	±10 dB, 50 Hz (BASS)
	±10 dB, 20 kHz (TREBLE)
Signal to Noise Ratio	100 dB (LINE, IHF-A)
Speaker Impedance	6Ω– 16Ω

Video Section

Input Sensitivity/Output Level and Impedance	1 Vp-p /75Ω (S-Video Y)
	0.28 Vp-p /75Ω(S-Video C)
	1 Vp-p /75Ω(Composite)

Tuner Section

■ FM

Tuning Frequency Range	87.5 MHz– 108.0 MHz
Usable Sensitivity	Stereo: 17.2 dBf 2 μV(75Ω IHF)
	Mono: 11.2 dBf 1 μV(75Ω IHF)
Signal to Noise Ratio	Stereo: 70 dB (IHF-A)
	Mono: 76 dB (IHF-A)
THD	Stereo: 0.3% (1kHz)
	Mono: 0.2% (1kHz)
Frequency Response	30 Hz–15 kHz / ±1 dB
Stereo Separation	45 dB (1kHz)

■ AM

Tuning Frequency Range	522 kHz–1611 kHz
	530 kHz–1710 kHz
Usable Sensitivity	30 μV
Signal to Noise Ratio	40 dB
THD	0.70%

General

Power Supply	AC 220/230 V, 50/60 Hz
Power Consumption	370 W
Stand-by Power Consumption	0.5 W
Dimensions (W × H × D)	435 × 150 × 369 mm
	17-1/8" × 5-7/8" × 14-1/2"
Weight	8.6 kg (19.0 lbs.)

■ Video Inputs

S-Video	DVD, VIDEO1, VIDEO2
Composite	DVD, VIDEO1, VIDEO2, VIDEO3

■ Video Outputs

S-Video	MONITOR, VIDEO1
Composite	MONITOR, VIDEO1

■ Audio Inputs

Digital Inputs	Optical: 1
	Coaxial: 1
Analog Inputs	DVD(MULTICHANNEL), VIDEO1, VIDEO2, VIDEO3, TAPE, CD
Multichannel Inputs	6

■ Audio Outputs

Analog Outputs	TAPE, VIDEO1
Subwoofer Pre Outputs	1
Speaker Outputs	SP-A (L, C, R, SL, SR, SB) + SP-B (L, R)
Phones	1

Specifications and features are subject to change without notice.

Memo

Memo

ONKYO CORPORATION

Sales & Product Planning Div. : 2-1, Nisshin-cho, Neyagawa-shi, OSAKA 572-8540, JAPAN
Tel: 072-831-8023 Fax: 072-831-8124

ONKYO U.S.A. CORPORATION

18 Park Way, Upper Saddle River, N.J. 07458, U.S.A.
Tel: 201-785-2600 Fax: 201-785-2650 <http://www.us.onkyo.com/>

ONKYO EUROPE ELECTRONICS GmbH

Liegnitzerstrasse 6, 82194 Groebenzell, GERMANY
Tel: +49-8142-4401-0 Fax: +49-8142-4401-555 <http://www.eu.onkyo.com/>

ONKYO EUROPE UK Office

Suite 1, Gregories Court, Gregories Road, Beaconsfield, Buckinghamshire, HP9 1HQ
UNITED KINGDOM Tel: +44-(0)1494-681515 Fax: +44(0)-1494-680452

ONKYO CHINA LIMITED

Units 2102-2107, Metroplaza Tower I, 223 Hing Fong Road, Kwai Chung,
N.T., HONG KONG Tel: 852-2429-3118 Fax: 852-2428-9039
<http://www.ch.onkyo.com/>



I0503-2

SN 29343959A

(C) Copyright 2005 ONKYO CORPORATION Japan. All rights reserved.

Download from www.Somanuals.com. All Manuals Search And Download.



* 2 9 3 4 3 9 5 9 A *

Free Manuals Download Website

<http://myh66.com>

<http://usermanuals.us>

<http://www.somanuals.com>

<http://www.4manuals.cc>

<http://www.manual-lib.com>

<http://www.404manual.com>

<http://www.luxmanual.com>

<http://aubethermostatmanual.com>

Golf course search by state

<http://golfingnear.com>

Email search by domain

<http://emailbydomain.com>

Auto manuals search

<http://auto.somanuals.com>

TV manuals search

<http://tv.somanuals.com>