

**ONKYO**

**TX-SR444**  
**AV RECEIVER**

**Basic Manual**

[The Basic Manual](#) includes information needed when starting up and also instructions for frequently used operations. [The Advanced Manual](#) has more detailed information and advanced settings.

**CONTENTS**

Front Panel.....	3		
Rear Panel.....	4		
<b>Step 1: Connections.....</b>	<b>5</b>		
1 Connecting the TV and Players.....	5		
• Connection to TV .....	5		
• Connection with a player that has a HDMI jack .....	6		
• Connection with a player that does not have a HDMI jack.....	6		
2 Connecting the AM/FM Antenna.....	6		
3 Connecting Speakers.....	7		
• ZONE A Connection .....	7		
• Height speaker types .....	7		
• ZONE B Connection.....	9		
• Instructions on how to connect speakers .....	9		
<b>Step 2: Setting Up.....</b>	<b>10</b>		
1 Turning the Power On .....	10		
2 Making Automatic Speaker Setting .....	10		
3 HDMI Setup.....	11		
• HDMI CEC (RIHD).....	11		
• HDMI Standby Through .....	11		
• ARC (Audio Return Channel).....	11		
<b>Step 3: Playing Back .....</b>	<b>12</b>		
1 Basic Operations .....	12		
• Part names and functions of the remote controller ....	12		
• Display .....	13		
2 Bluetooth .....	13		
3 AM/FM Radio .....	13		
4 Multi-zone.....	14		
		5 Quick Setup Menu.....	14
		6 Other useful functions .....	15
		Troubleshooting.....	16
		Specifications .....	17
		Table of display resolutions .....	18
		Resolutions supported by HDMI.....	18
		Supplied Accessories .....	Back cover



# Features

- Equipped with 7 ch amplifier
  - Supports playback in Dolby Atmos format which provides 360-degree placement and movement of sounds including overhead sound
  - Dolby Surround listening mode expands 2 ch, 5.1 ch or 7.1 ch source to available speaker configurations
  - Equipped with 4K compatible HDMI IN/OUT jacks (To play 4K or 1080p video, use a high speed HDMI cable or high speed HDMI with Ethernet cable)
  - Supports the HDMI Standby Through function which allows signal transmission from players to the TV in standby state
  - Supports HDCP2.2, a strict copy-protection for providing high quality content
  - Supports ARC (Audio Return Channel)
  - Supports Bluetooth connection
  - A/V Sync Function to correct deviation of audio and video
  - Multi-zone function which allows you to play the same audio in another room as the main room
  - 32 bit DSP (Digital Signal Processor) with excellent calculation performance
  - Music Optimizer™ for compressed digital music files
  - Phase Matching Bass System
  - Automatic speaker setup available using supplied calibrated microphone (AccuEQ Room Calibration)
  - Supports multi-language on-screen displays  
English, German, French, Spanish, Italian, Dutch, Swedish, Russian\*1, Chinese\*2
- \*1 European, Australian and Asian models only
- \*2 European, Australian, Taiwanese and Asian models only
- OSD is not displayed when the input selector is "BLUETOOTH". Use the display on the main unit when operating the unit.

Refer to the back cover for supplied accessories.



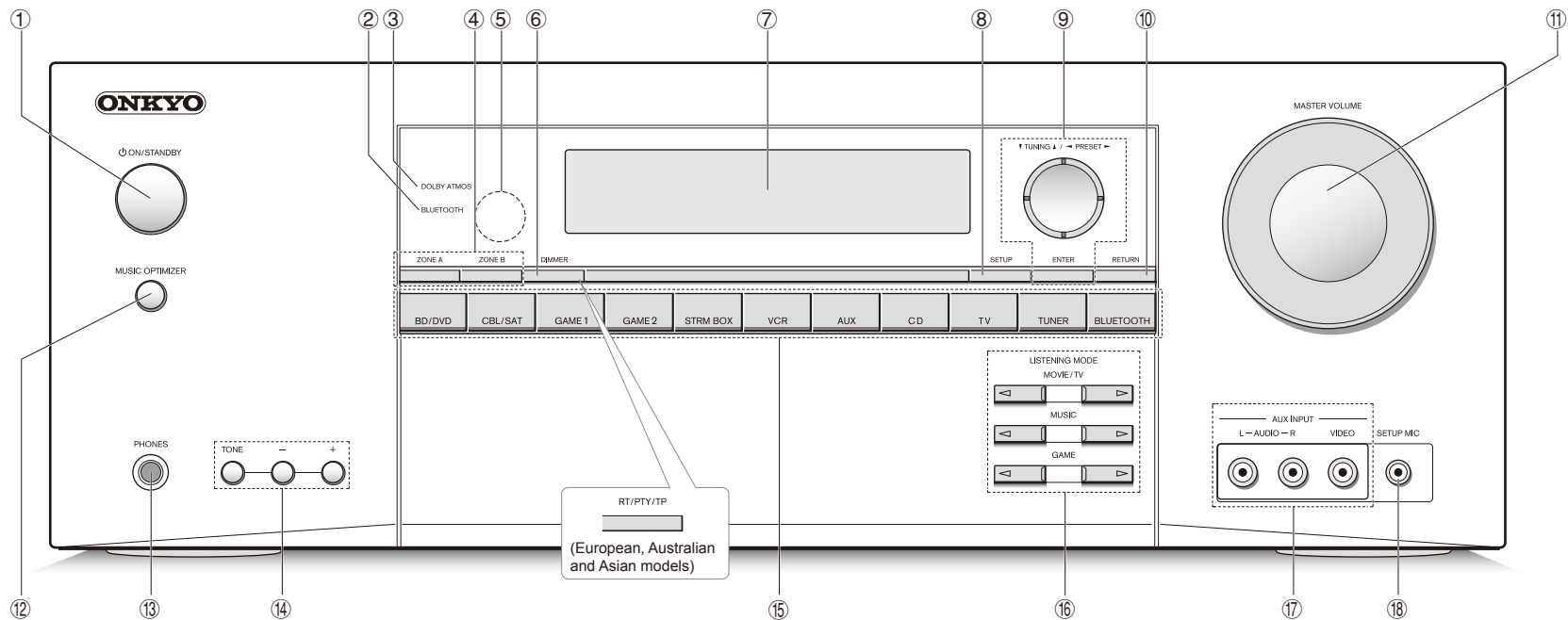

**Front Panel**

- ① **ON/STANDBY button:** Turns the unit on or into standby mode.
- ② **BLUETOOTH indicator:** Flashes while pairing with a Bluetooth-enabled device is in progress and stays lit when pairing is completed.
- ③ **DOLBY ATMOS indicator:** Lights when playing Dolby Atmos.
- ④ **ZONE A and ZONE B buttons:** Control the multi-zone function.
- ⑤ **Remote control sensor:** Receives signals from the remote controller.
- ⑥ **DIMMER button (North American and Taiwanese models):** Switches the brightness of the display.  
**RT/PTY/TP button (European, Australian and Asian models):** Can be used when receiving the station transmitting text information.
- ⑦ **Display:** Refer to [page 13](#) for details.
- ⑧ **SETUP button:** Used when making settings.
- ⑨ **Cursor buttons, ▼TUNING▲ button, ◀PRESET▶ button and ENTER button:** Move the cursor and confirms the selection. When listening to AM/FM broadcasting, tune in to the station with ▼TUNING▲ or select the registered station with ◀PRESET▶.
- ⑩ **RETURN button:** Returns the display to the previous state.
- ⑪ **MASTER VOLUME:** Allows you to adjust the volume.
- ⑫ **MUSIC OPTIMIZER button:** Turns on/off the MUSIC OPTIMIZER function that improves the quality of the compressed audio.
- ⑬ **PHONES jack:** Stereo headphones with a standard plug are connected.
- ⑭ **TONE and Tone Level buttons:** Adjust the high tone and low tone.
- ⑮ **Input selector buttons:** Switch the input to be played.
- ⑯ **LISTENING MODE buttons:** Allow you to select the listening mode.
- ⑰ **AUX INPUT VIDEO/AUDIO jacks:** A video camera or such other device is connected.
- ⑱ **SETUP MIC jack:** The supplied speaker setup microphone is connected.



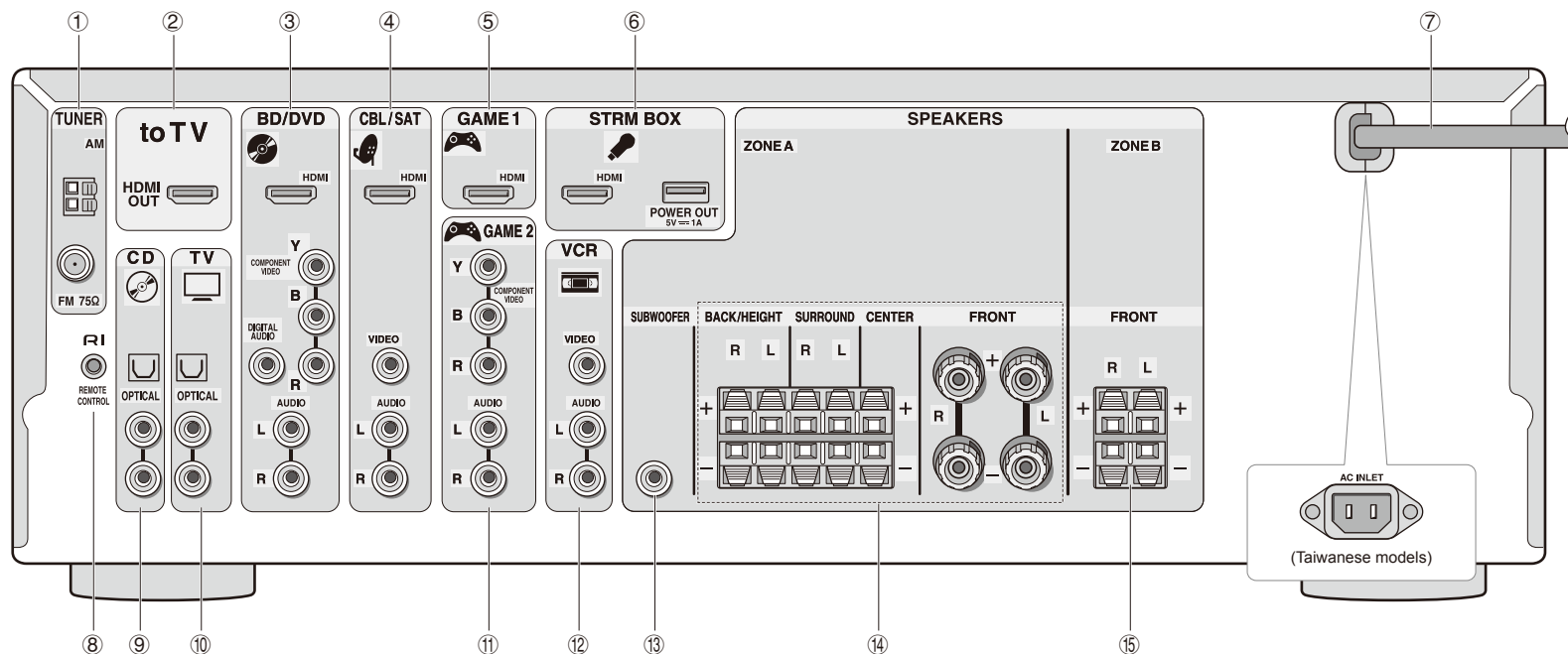

## Rear Panel

- ① **TUNER AM/FM (75Ω) terminal:** The supplied antennas are connected.
- ② **to TV jack:** Connect to a TV using a HDMI cable. Change the input selector to "TV" to hear audio from the TV.  
\* If your TV does not support ARC, you need connection ⑩ in addition to this connection.
- ③ **BD/DVD jacks:** Connect to a Blu-ray Disc Player or DVD Player using a HDMI cable. This corresponds with the "BD/DVD" input selector.
- ④ **CBL/SAT jack:** Connect to a Cable Set-top box using a HDMI cable. This corresponds with the "CBL/SAT" input selector.
- ⑤ **GAME 1 jack:** Connect to a Game console using a HDMI cable. This corresponds with the "GAME 1" input selector.
- ⑥ **STRM BOX jack:** Connect to a Streaming Media Player. When a power supply is required, connect using a USB cable to the POWER OUT port. This corresponds with the "STRM BOX" input selector.
- ⑦ **Power cord (North American, European, Australian and Asian models) AC INLET (Taiwanese models):** The supplied power cord is connected.
- ⑧ **RI REMOTE CONTROL jack:** An Onkyo product with RI jack can be connected and synchronized with this unit.
- ⑨ **CD jack:** Connect to audio equipment such as a CD Player using a digital optical cable. This corresponds with the "CD" input selector.
- ⑩ **TV jack:** If your TV does not support ARC, you need to connect this jack to the audio output jack on the TV, in addition to connection ②. This corresponds with the "TV" input selector.
- ⑪ **GAME 2 jack:** Connect a game console that has component video jacks. This corresponds with the "GAME 2" input selector.
- ⑫ **VCR jacks:** Connect to a Video Cassette Recorder. This corresponds with the "VCR" input selector.
- ⑬ **SUBWOOFER jacks (ZONE A):** A subwoofer with built-in amplifier placed in ZONE A is connected.
- ⑭ **SPEAKERS jacks (ZONE A):** Speakers placed in ZONE A are connected. Up to 7 channels of speakers can be connected.
- ⑮ **SPEAKERS jacks (ZONE B):** Speakers placed in ZONE B are connected. 2 channels of speakers can be connected.



# Step 1: Connections

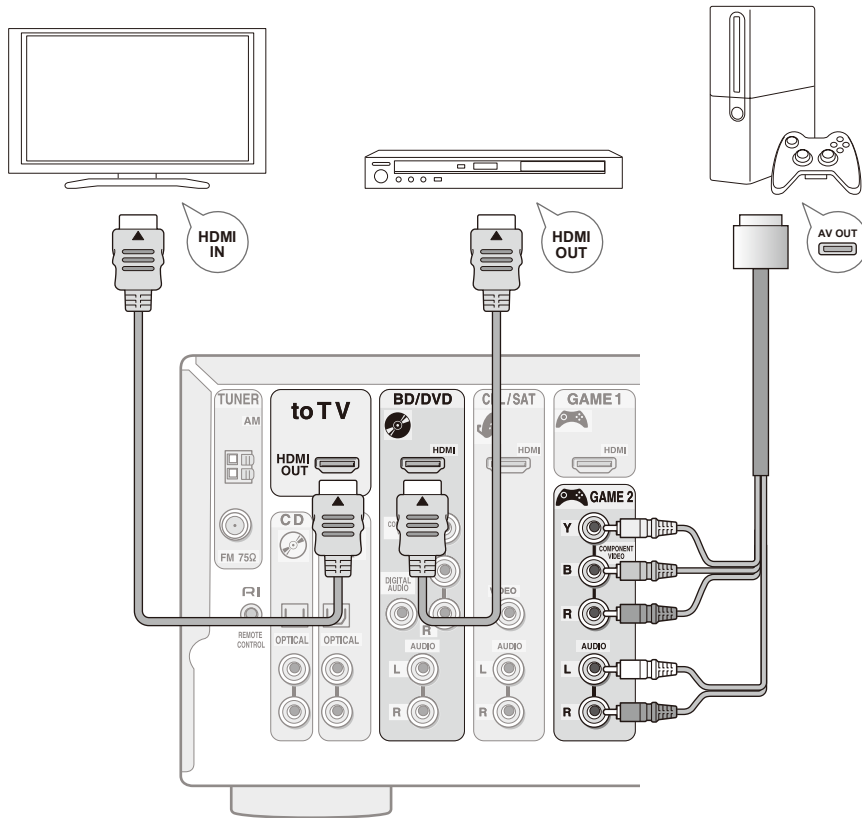

Connection example

## 1 Connecting the TV and Players

### Before Start

- Connect this unit between the TV and player.
- To select the source to play, select the input selector button with the same name as the jack to which it is connected. Input switches automatically when you have connected equipment that conforms to the CEC (Consumer Electronics Control) standard to this unit using a HDMI cable. (\*)
- This allows audio and video signal transmission from players to the TV even if this unit is in standby. (HDMI Standby Through function) (\*)
- The power cord must be connected only after all other connections are completed.
- \* It is necessary to make appropriate settings to enable this function. See "3 HDMI Setup" of "Step 2: Setting Up".

### Connection to TV

Connect the "to TV" jack and the HDMI IN jack of the TV with a HDMI cable. This is the only connection necessary with a TV that supports ARC. If your TV does not support ARC, you need to connect the "TV" jack to the audio output jack on the TV with a digital optical cable or an RCA cable, in addition to this connection to the "to TV" jack.

- \* This function enables you to play the audio from the TV through the speakers of this unit just by connecting this unit and the TV with a single HDMI cable. To use the ARC function, connect to the ARC compatible HDMI jack of the TV and make appropriate settings on this unit. See "3 HDMI Setup" of "Step 2: Setting Up".

- Audio connection with a TV not supporting ARC

\* Select an appropriate connection for your TV.

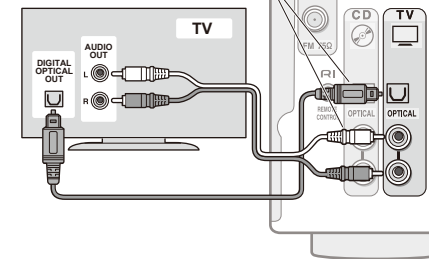

### Cable used for connection (sold separately)

- HDMI cable
- Component video cable
- Composite video cable
- Digital coaxial cable
- Digital optical cable
- Analog audio (RCA) cable



### Connection with a player that has a HDMI jack

Connect to the "BD/DVD", "CBL/SAT", "GAME 1", and "STRM BOX" jacks using a HDMI cable. Connect the equipment to the corresponding jack, for example a Blu-ray Disc Player to "BD/DVD", so that it is easy for you when selecting with the input selector. Connect a Streaming Media Player to the "STRM BOX" jack. When a power supply is required, connect using a USB cable to the POWER OUT port. (✱)

✱ The POWER OUT jack supports a 5V/1A power supply.

### Connection with a player that does not have a HDMI jack

Connect equipment with video output jacks to the "BD/DVD", "CBL/SAT", "GAME 2", and "VCR" jacks. Connect with component video cable or composite video cable for video signals and digital coaxial cable or RCA cable for audio signals.

Connect audio equipment such as a CD Player using a digital optical cable or an RCA cable to the "CD" jack.

- Video signals input to the component video input or the composite video input will be upconverted to HDMI signals and then output from the "to TV" jack. When upconverting video signals input to the component video input for output from the HDMI OUT jack, set the output resolution of the player to 480i or 576i. If the input has 480p/576p or higher resolution, a message prompting you to change the resolution setting will appear. If your player does not support 480i or 576i output, use the composite video jack.
- Connection with a digital coaxial cable or digital optical cable is necessary for playback of digital surround sources such as Dolby Digital. The digital in optical jack of the unit has a cover, push in the cable against the cover as it is turned inside.

## 2 Connecting the AM/FM Antenna

Connect the antennas to listen to AM/FM broadcast. When listening to the broadcast for the first time, adjust the antenna position and orientation to get the best reception.

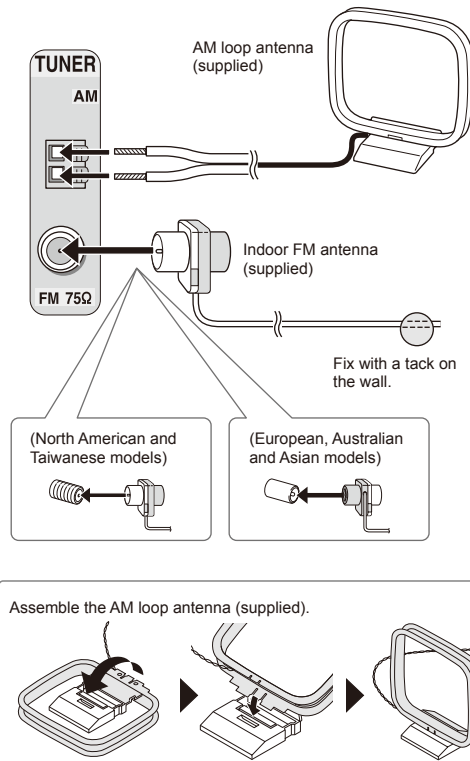

## Step 1: Connections

### 3 Connecting Speakers

#### ZONE A Connection

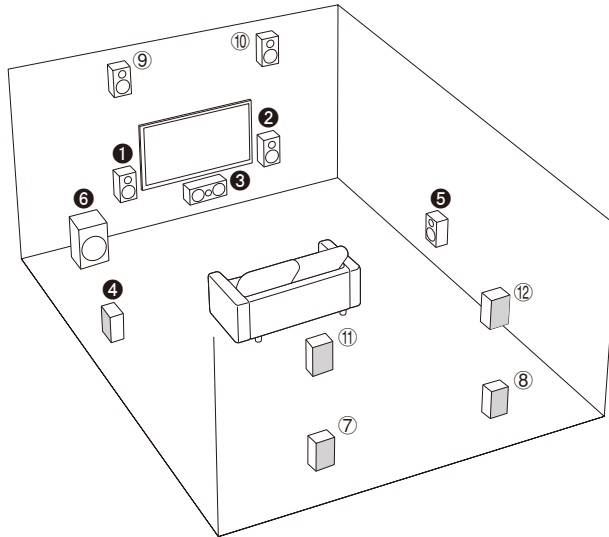

- ① ② Front speakers
- ③ Center speaker
- ④ ⑤ Surround speakers
- ⑥ Subwoofer
- ⑦ ⑧ Back speakers
- ⑨ ⑩ Height speakers (Front High)
- ⑪ ⑫ Height speakers (Rear High)

- 5.1 ch: ①②③④⑤⑥
- 7.1 ch: ①②③④⑤⑥+⑦⑧, or ①②③④⑤⑥+⑨⑩, or ①②③④⑤⑥+⑪⑫
- ⑦⑧, ⑨⑩ speakers and ⑪⑫ speakers share the same speaker terminals. Select one and make the connection.
- To enjoy the Dolby Atmos listening mode, height speakers or back speakers need to be installed. There are a variety of height speakers apart from this type. see the next section for details.

#### Important:

Connect speakers with 6 Ω to 16 Ω impedance. Using a speaker with less impedance than the supported value may result in failure.

#### Characteristics of speaker types

①② output front stereo sound and ③ outputs center sound such as dialogs and vocals. ④⑤ create back sound field. ⑥ reproduces bass sounds and creates rich sound field. Connecting ⑦⑧ speakers, ⑨⑩, or ⑪⑫ speakers enables playback in 7.1 ch configuration. ⑦⑧ (back) speakers improve sense of envelopment created by back sound field as well as seamlessness of back sounds, providing more natural sound experiences in the sound field. ⑨⑩ and ⑪⑫ (height) speakers produce surround effects on a height plane. Note that this unit can perform optimal sound field processing for the type of height speakers actually installed and registered in automatic speaker settings.

#### Height speaker types

##### Installing speakers in ceiling

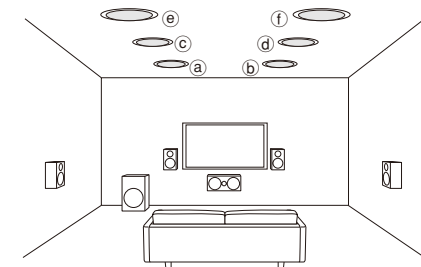

- ① ② Top Front
- ③ ④ Top Middle
- ⑤ ⑥ Top Rear

Ceiling speakers, etc. are used for maximizing effects in Dolby Atmos or Dolby Surround listening mode. Install Top Front speakers so that they are positioned at a point between directly above the listening position and directly above the front speakers. Install Top Middle speakers so they are directly above the listening position. Install Top Rear speakers so they are positioned at a point between directly above the listening position and directly above the back speakers. You can select ①②, ③④, or ⑤⑥ on the unit. For connection with the unit, use the SPEAKERS BACK/HEIGHT terminals.

- Dolby Laboratories recommends placing the speakers as described in "Installing speakers in ceiling" to obtain the best Dolby Atmos effect.



Step 1: Connections

Using Dolby Enabled Speakers

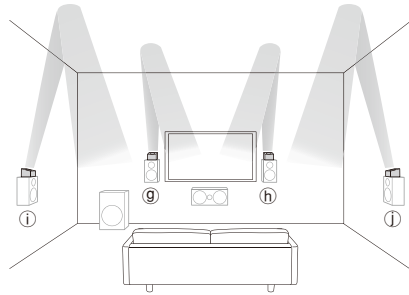

- ⑨ ⑩ Dolby Enabled Speakers (Front)
- ⑪ ⑫ Dolby Enabled Speakers (Surround)

A Dolby Enabled Speaker is specially designed to be used as a height speaker. There are two types of Dolby Enabled Speakers; one type is designed to be placed on top of other speakers such as front speakers and surround speakers, and the other type is designed to be integrated with normal speakers. Dolby Enabled Speakers placed with their diaphragms facing toward the ceiling create higher effect in the Dolby Atmos and Dolby Surround listening modes by providing sounds echoing off the ceiling. You can select ⑨⑩ or ⑪⑫ on the unit. For connection with the unit, use the SPEAKERS BACK/HEIGHT terminals.

When playing Dolby Atmos, the speakers required depend on how you have setup your back speakers or height speakers. The following shows combinations of speakers.

Connection pattern	Back or Height	Front	Center	Surround
1	Back	⊗	○	⊗
2	Front High	⊗	○	○
3	Rear High	⊗	○	○
4	Top Front	⊗	○	○
5	Top Middle	⊗	○	○
6	Top Rear	⊗	○	○
7	Dolby Enabled Speaker (Front)	⊗	○	○
8	Dolby Enabled Speaker (Surround)	⊗	○	⊗

⊗ Required ○ Optional \* Connection of a subwoofer is optional.

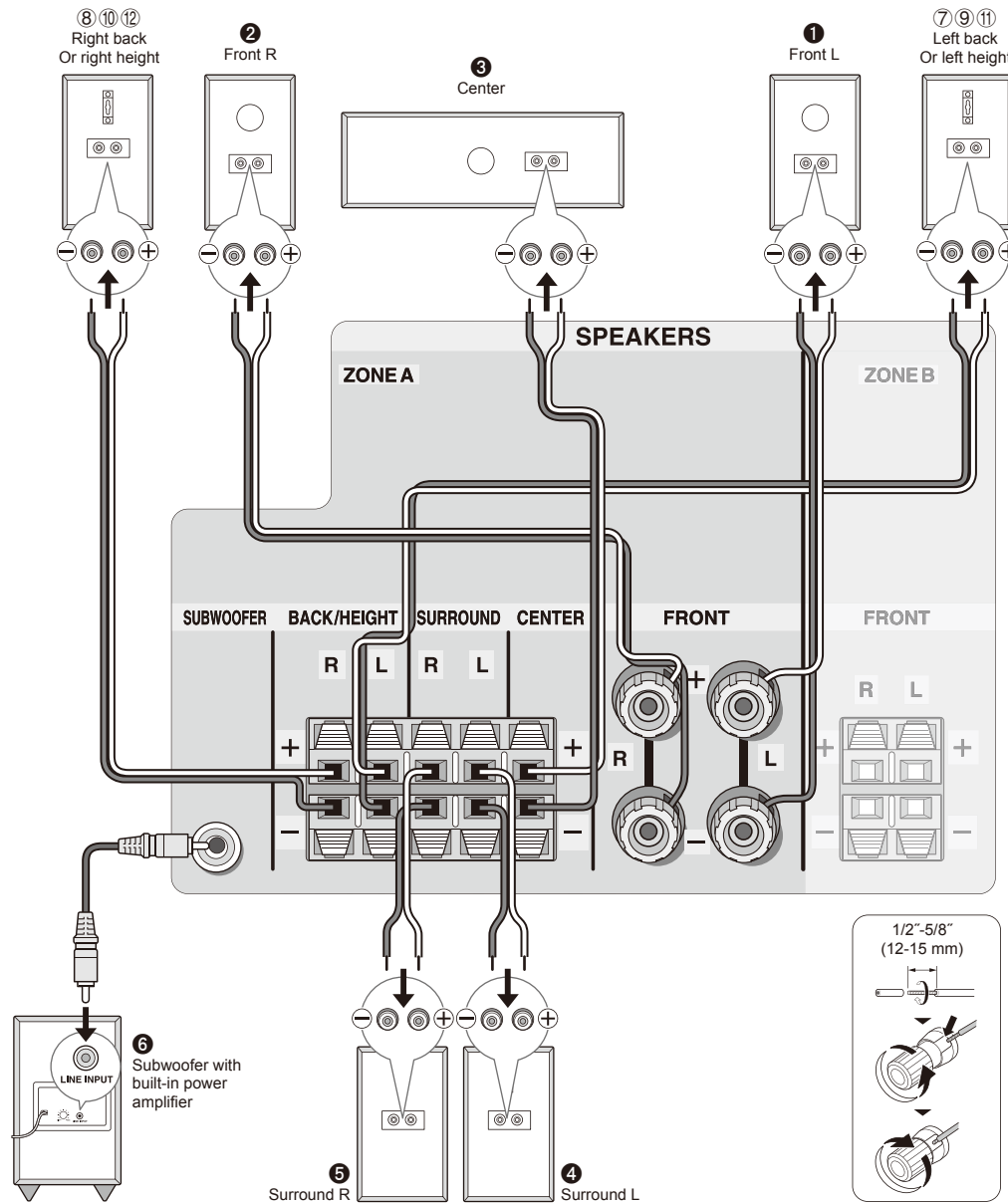

A speaker configuration where only one back speaker is connected is not supported.

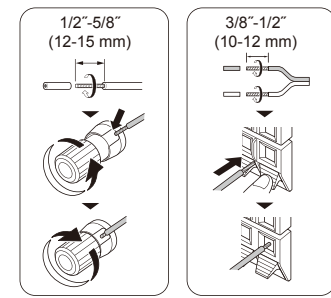



## Step 1: Connections

**ZONE B Connection**

You can listen to audio in a room (called ZONE B) other than ZONE A (the room where this unit is located).

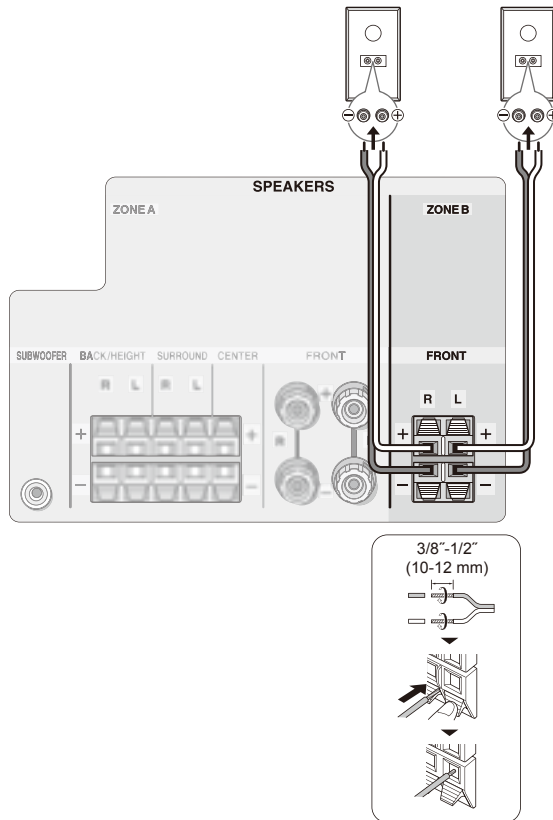
**Instructions on how to connect speakers**

Cut and remove the plastic coating from the end of the speaker cable, twist the core and connect it to the terminal. Be sure to make correct connection between the unit's jacks and speaker's jacks (+ to + and - to -) for each channel. If connection is wrong, a bass sound may become poor due to reverse phase. The subwoofer jack supports connection of a subwoofer with built-in power amplifier. Set the cut-off filter selection switch of the subwoofer to DIRECT. If the subwoofer does not have a cut-off filter selection switch but has a cut-off frequency adjusting dial, turn it to the maximum frequency. If your subwoofer does not have built-in power amplifier, you can connect a power amplifier between the unit and the subwoofer.

- The speaker setting is 7.1 channels at the time of purchase. You can change it manually or by using automatic speaker setting.
- Short-circuiting the + cable and - cable or contacting the cable core to the rear panel of the unit may cause failure. Also do not connect two or more cables to one speaker terminal or one speaker to several terminals.

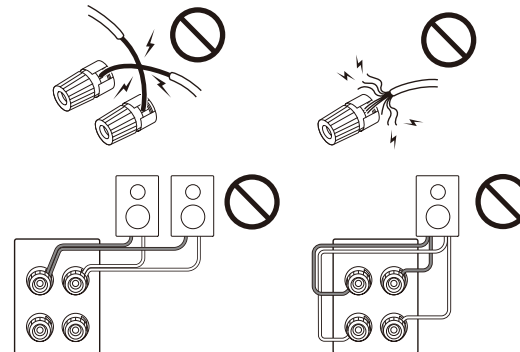

**When using commercially available banana plugs:** tighten the speaker terminals to the end and then insert the banana plugs. Do not insert the core of speaker cable directly into the hole for banana plug of speaker terminal. (North American models)

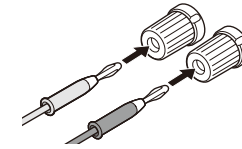

# Step 2: Setting Up

● **Operation:** Use the remote controller of this unit to operate the menus shown on the TV screen. To display the guidance, you need to make HDMI connection between the unit and TV. Select the item with the cursor buttons of the remote controller and press ENTER to confirm your selection. To return to the previous screen, press RETURN.

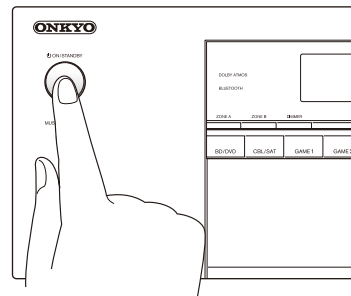
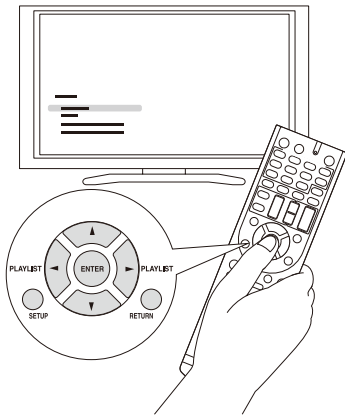

- When the unit is turned on, a large instantaneous current may flow affecting functionality of the computer and other devices. It is recommended to use a separate outlet from that for the computer or such other sensitive devices.

\* Taiwanese models include removable power cords. Connect the power cord to AC INLET of the unit and then connect to the outlet. Always disconnect the outlet side first when disconnecting the power cord.

## 2 Making Automatic Speaker Setting

The AccuEQ Room Calibration function, our proprietary technology, measures the test tone coming from each speaker with the supplied speaker setup microphone, setting of the number of speakers, volume level, each speaker's optimum crossover frequencies, and distance from the primary listening position, and also enables correction of distortion caused by the acoustic environment of the room.

- You cannot return to the previous screen during speaker setup, even if you press RETURN.

### 1. Place the speaker setup microphone.

Before starting the procedure, refer to the figure and place the supplied speaker setup microphone at the measurement position ★.

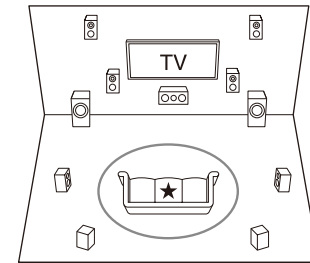

○ : Listening area    ★ : Measurement position with microphone

- \* Correct measurement will not be possible if the microphone is held by hand. Measurement is not possible if headphones are being used.
- \* The subwoofer sound may not be detected since it is extremely low frequencies. Set the subwoofer volume to around the half of its maximum volume and make its frequency to the maximum level.
- \* Measurement may be interrupted if there is ambient noise or radio frequency interference. Close the window and turn off the home appliance and fluorescent light.

### 1 Turning the Power On

Connect the power cord to the outlet (\*). Press ON/STANDBY on the main unit or RECEIVER on the remote controller to turn the unit on or to standby mode.

### 2. Connect the speaker setup microphone to the SETUP MIC jack of the unit.

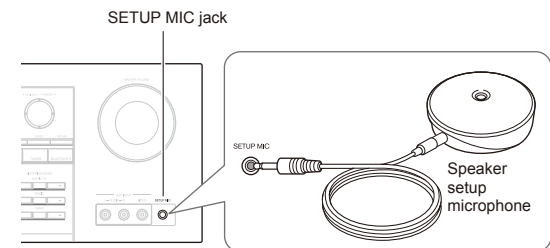

## Step 2: Setting Up

3. Select the settings for the connected speakers, the type of the height speakers, and other appropriate settings.

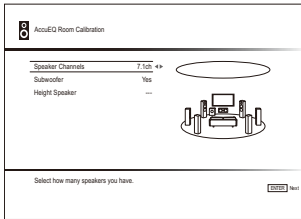

When the screen above is displayed, set the items with the cursor buttons on the remote controller.

Refer to the on-screen diagram for "Speaker Channels", which changes each time a different number of channels is selected. When all the items have been set, press ENTER on the remote controller. After that, follow the guidance displayed on the TV screen to operate the unit.

- Refer to the content of an item, which appears on the lower left of the screen when the cursor is on the item.
4. **The test tones sound from the connected speakers and automatic speaker setting starts.**  
Measurement will be made three times or more for each speaker. It takes several minutes to be completed. Keep the room as quiet as possible during measurement. If any of the speakers do not produce the test tone, check for disconnection.
- During measurement, each speaker outputs the test tones at a high volume. Be careful of sound leak that may disturb your neighbors, or be careful not to frighten young children.
  - To cancel measurement on the way, disconnect the microphone plug.
5. **When the measurement is completed, the measurement result is displayed.**  
Press ◀/▶ on the remote controller to check the settings. Press ENTER with "Save" selected. Select "On" in the next screen and press ENTER on the remote controller.
- You should normally select "On (All Channels)", and to disable just the front speakers, you should select "On (Except Front Left/Right)".
  - If there is an error message, follow the on-screen instruction to remove the error cause.

6. When "Please unplug setup microphone." is displayed, disconnect the microphone.

## 3 HDMI Setup

The unit supports the linked system function such as power on/off link when connected via HDMI cable with a CEC (Consumer Electronics Control) compliant TV or player. You need to change the default setting to use the linked system function, HDMI Standby Through function and ARC (Audio Return Channel) function.

### HDMI CEC (RIHD)

The following linked operations are possible with connected equipment when the CEC function is enabled.

- Turning the TV to standby mode will turn the unit to standby mode.
- On the TV side, it is possible to set whether to output audio from the speakers connected to the unit or from the TV's speakers.
- Starting playback of a CEC compliant player/recorder will automatically switch the unit's input to the HDMI input of the player/recorder. If the unit is in standby mode, it will automatically be turned on.

It is also possible to control the connected CEC compliant equipment with the remote controller of the unit. For details, see the Advanced Manual.

- \* RIHD is a name for the linked system function of Onkyo's CEC compliant products.

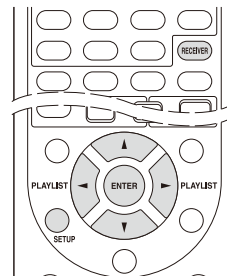

1. After pressing **RECEIVER**, press **SETUP** on the remote controller.

2. Select "5. Hardware" with the cursor and press ENTER.
3. Select "HDMI" with the cursor and press ENTER.
4. Select "HDMI CEC (RIHD)" with the cursor and select "On".

- When setting is complete, press SETUP to close the menu screen.

### HDMI Standby Through

The function allows transmission from players to the TV even if the unit is in standby. Setting the HDMI CEC (RIHD) setting mentioned above to "On" enables this setting automatically.

- Power consumption in standby mode increases when the HDMI Standby Through function is enabled.

### ARC (Audio Return Channel)

Simple connection to the ARC compatible TV using a single HDMI cable allows to listen to the TV audio signals from the speakers connected to the unit. Setting the HDMI CEC (RIHD) setting mentioned above to "On" enables the "Audio Return Channel" setting automatically.

#### Audio output of connected players

To enjoy digital surround sound including Dolby Digital and DTS, audio output should be set to "Bitstream output" on the connected Blu-ray Disc Player or other device.

Depending on the settings on the Blu-ray Disc Player, there may be cases when Dolby TrueHD, Dolby Atmos, and DTS-HD Master Audio is not output according to the format of the source.

In this case, in the Blu-ray Disc Player settings try setting "BD video supplementary sound" (or secondary sound) to "Off".

Change the listening mode after changing the setting to confirm.



# Step 3: Playing Back

## 1 Basic Operations

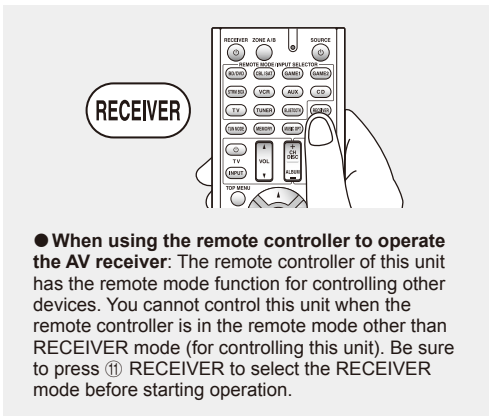

### 1. Turning the power on.

Press ① RECEPTOR on the remote controller to turn the power on.

- Switch the input to the TV to that assigned to the unit. Use the TV's remote controller.

### 2. Select the input on the unit.

Press the ② INPUT SELECTOR for the player you want to listen to. Press TV to listen to the TV's sound. You can also use the input selector buttons on the main unit.

- Input will automatically be selected if the TV or player is CEC compliant and connected to the unit with HDMI cable.

### 3. Select the desired listening mode.

After pressing ⑪ RECEPTOR, press the ⑦ listening mode buttons to switch the mode so that you can enjoy different listening modes.

### 4. Adjust the volume with ⑬ VOL.

## Part names and functions of the remote controller

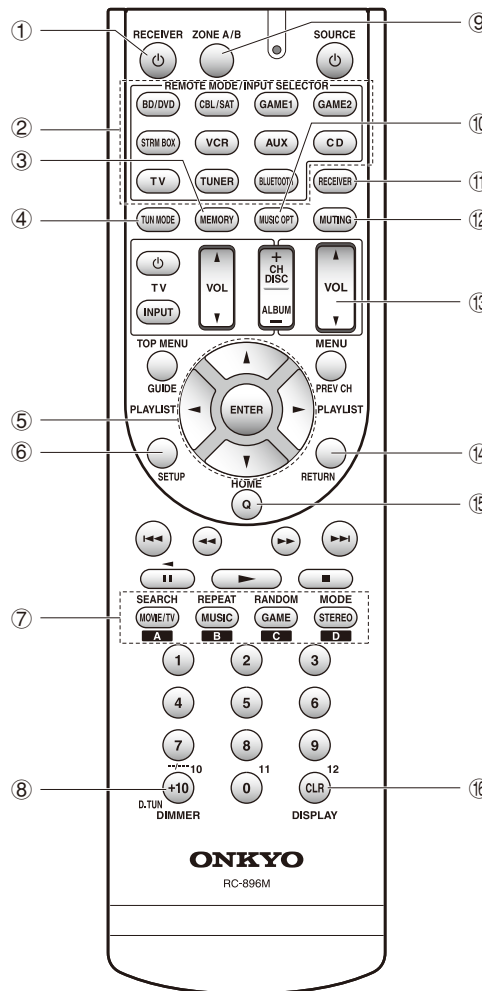

- ① **RECEPTOR button:** Turns the unit on or into standby mode.
- ② **REMOTE MODE/INPUT SELECTOR buttons:** Switch the input to be played. Furthermore, by registering a particular remote control code to a button, you can switch the remote control mode to operate other equipment by pressing that button.
- ③ **MEMORY button:** Registers a radio station.
- ④ **TUN MODE button:** Switches the tuning mode.
- ⑤ **Cursor buttons and ENTER button:** Move the cursor and confirms the selection.
- ⑥ **SETUP button:** Displays the screen for making various settings for this unit.
- ⑦ **Listening mode buttons:** Allow you to select the listening mode.
  - MOVIE/TV button:** You can select a listening mode suitable for movies and TV programs.
  - MUSIC button:** You can select a listening mode suitable for music.
  - GAME button:** You can select a listening mode suitable for games.
  - STEREO button:** You can select a listening mode for stereo and all channel stereo sources.
    - For details on the listening modes, see the Advanced Manual.
- ⑧ **DIMMER button:** Switches the brightness of the display.
- ⑨ **ZONE A/B button:** For use when the unit is connected with speakers in a separate room and sound is played there.
- ⑩ **MUSIC OPT button:** Turns on/off the MUSIC OPTIMIZER function that improves the quality of the compressed audio.
- ⑪ **RECEPTOR button:** Switches the remote controller to the mode for operating this unit.
- ⑫ **MUTING button:** Temporarily mutes audio. Press again to cancel muting.
- ⑬ **VOLUME buttons:** Allow you to adjust the volume. This button also cancels the muting.
- ⑭ **RETURN button:** Returns the display to the previous state.
- ⑮ **Q button:** Displays the Quick Setup menu that allows you to quickly access the frequently used setting items including sound quality adjustment.
- ⑯ **DISPLAY button:** Switches the information on the display.



## Step 3: Playing Back

## Display

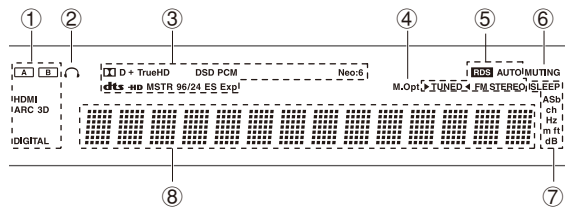

- ① Lights in the following conditions. "A": Output to ZONE A / "B": Output to ZONE B / "HDMI": HDMI signals are input and HDMI input selector is selected. This lights faintly when the HDMI Standby Through function is enabled and the unit is in standby. / "ARC": Audio signals are input from ARC compatible TV and TV input selector is selected. / "3D": Input signals are 3D. / "DIGITAL": Digital signals are input and selected.
- ② Stays lit when headphones are connected.
- ③ Lights according to the type of input digital signals and the listening mode.
- ④ Stays lit when Music Optimizer is enabled.
- ⑤ Lights in the following conditions. "AUTO": Tuning mode is auto. / "▶TUNED◀": Receiving AM/FM radio. ▶◀ flashes while tuning is automatically performed. / "FM STEREO": Receiving FM stereo. / "RDS" (European, Australian and Asian models): Receiving RDS broadcasting.
- ⑥ "MUTING": Flashes when muting is on.
- ⑦ Lights in the following conditions. "SLEEP": Sleep timer has been set. This lights faintly when the Power Out at Standby for STRM BOX function is enabled and the unit is in standby. / "ASb" (Auto Standby): Auto Standby is on. / "ch": Channel is being set. / "Hz": Crossover frequencies are being set. / "m/ft": Speaker distances are being set. / "dB": Speaker volume is being set.
- ⑧ Displays various information of the input signals. Pressing DISPLAY displays the type of input digital signals and the listening mode.

## 2 Bluetooth

You can wirelessly enjoy music files stored in a smartphone or other Bluetooth-enabled device. The coverage area is 48 feet (15 meters).

- The Bluetooth-enabled device needs to support the A2DP profile.
- Note that connection is not always guaranteed with all Bluetooth-enabled devices.

### ■ Pairing

Pairing is necessary when connecting the Bluetooth-enabled device for the first time. Before starting the procedure, learn how to enable the Bluetooth setting function and to connect with other devices on the Bluetooth-enabled device.

1. Press **BLUETOOTH** on the remote controller.  
The unit begins pairing and "Now Pairing..." is displayed.

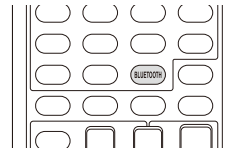

2. While "Now Pairing..." is on the display, complete connection on the Bluetooth-enabled device in the nearby area within about 1 minute.

If the name of this unit is displayed on the Bluetooth-enabled device's display, select this unit. Pairing will end after a short time.

- If a password is requested, enter "0000".
- You can pair with another Bluetooth-enabled device by pressing and holding the BLUETOOTH button until "Now Pairing..." is on the display. This unit can store the data of up to 8 paired devices.

### ■ Playing Bluetooth-enabled devices

If the unit is on and the Bluetooth-enabled device is connected, the input will be automatically switched to BLUETOOTH. Play music in this state. For details on using the remote controller for these operations, see the Advanced Manual.

- If the volume setting on the Bluetooth-enabled device is low, the sound will not be output from this unit.

- Due to the characteristics of Bluetooth wireless technology, the sound produced on this unit may slightly be behind the sound played on the Bluetooth-enabled device.
- The on-screen displays are not displayed when the OSD language is set to Chinese. Operate by confirming the display on the main unit. (European, Australian, Taiwanese and Asian models)

## 3 AM/FM Radio

The Basic Manual explains the method using automatic tuning. For manual tuning, see the Advanced Manual.

1. Press **TUNER** on the remote controller several times to select either "AM" or "FM".
2. Press **TUN MODE** so that the "AUTO" indicator on the display lights.
3. Press the **▲/▼** cursor buttons.  
The automatic tuning to a radio station starts. Searching stops when one is tuned. When tuned into a radio station, the "▶TUNED◀" indicator on the display lights. The "FM STEREO" indicator lights if the radio station is an FM radio station.
  - Alternatively you can press ▼TUNING▲ on the main unit.

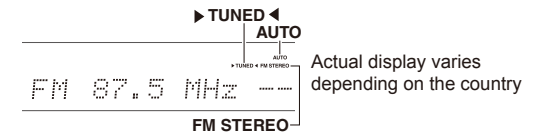

**Registering a radio station:** You can register up to 40 of your favorite AM/FM radio stations.

1. Tune into the AM/FM radio station you want to register.
2. Press **MEMORY** on the remote controller so that the preset number on the display flashes.
3. Press **CH +/-** several times to select a number between 1 and 40 while the preset number is flashing (about 8 seconds).
  - Alternatively you can press ◀PRESET▶ on the main unit.
4. Press **MEMORY** again to register the station. When registered, the preset number stops flashing. To



## Step 3: Playing Back

select a preset radio station, press ◀PRESET▶ on the main unit or CH +/- on the remote controller.

- To delete a preset station, after selecting the preset station you want to delete, press MEMORY on the remote controller, and with the preset number flashing on the display, press CLR on the remote controller.

**AM/FM frequency step setting**

It may be necessary for you to change the frequency step to tune the radio in your area. Change the step with the following procedure. Note that when this setting is changed, all radio presets are deleted.

- After pressing  RECEIVER on the remote controller, press SETUP.
- Select "5. Hardware" with the cursor and press ENTER.
- Select "Tuner" with the cursor and press ENTER.
- Select "AM / FM Frequency Step" (North American and Taiwanese models) or "AM Frequency Step" (European, Australian and Asian models) with the cursor and select the frequency step for your area.  
**(For Taiwanese models only)**  
The setting is "10 kHz / 0.2 MHz" at the time of purchase. Please change it to "9 kHz / 0.05 MHz".

## 4 Multi-zone

You can listen to audio in a room (called ZONE B) other than ZONE A (the room where this unit is located). You can play in both ZONE A and ZONE B or just in ZONE B.

**Press ZONE A/B on the remote controller several times to select the zone.**

Either "A" or "B" lights on the display of the main unit to indicate which zone is currently selected.

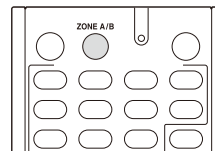

- Alternatively you can press ZONE A or ZONE B on the main unit.
- The volume of ZONE B is the same as the volume set for ZONE A.
- It is not possible to listen to different sources in ZONE A and ZONE B.
- The listening mode is fixed to All Ch Stereo when playing in ZONE B. Furthermore, no sound will be output from the back speakers and height speakers in ZONE A.

## 5 Quick Setup Menu

You can perform common settings on the TV screen while playing.

**1. Press Q on the remote controller.**

The Quick Setup menu is displayed on the connected TV's screen.

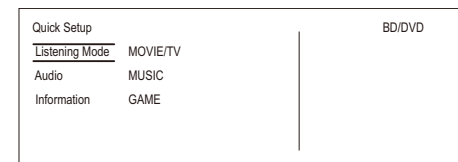
**2. Select the item with the cursors on the remote controller and then press ENTER.**

- To return to the previous screen, press RETURN.

**3. Select the setting with the cursors of the remote controller.**

■ **Listening Mode:** Select the listening mode from the categories of "MOVIE/TV", "MUSIC" and "GAME". After selecting the Listening Mode, press ENTER button to confirm.

- It cannot be set when audio is played from the TV's speakers.

■ **Audio:** You can perform various audio settings including audio quality and speaker level adjustment.

- You cannot select this item when audio is output from the TV's speakers.

**Bass, Treble:** Adjust volume of the front speaker.

- It cannot be set if the listening mode is Direct.

**Phase Matching Bass:** Suppress phase shift in the midrange to enhance bass sound. Thus smooth and powerful bass sound can be obtained.

- It cannot be set if the listening mode is Direct.

**Center Level, Subwoofer Level:** Adjust the speaker level while listening to the sound. The adjustment you made will be reset to the previous status when you turn the unit to standby mode.

- Changes may not be possible depending on the speaker settings.



## Step 3: Playing Back

- This setting is not possible during MUTING or when using headphones.

**A/V Sync:** If the video is behind the audio, you can delay the audio to offset the gap. Different settings can be set for each input selector.

- It cannot be set if the listening mode is Direct.

**AccuEQ Room Calibration:** Enable or disable the settings made by automatic speaker setting. To enable them, you should normally select "On (All Ch)", and to disable just the front speakers, you should select "On (ex. L/R)". The setting can be separately set to each input selector.

- This setting cannot be selected if the automatic speaker setting has not been performed.
- It cannot be set if headphones are connected or the listening mode is Direct.

**Music Optimizer:** Improve the quality of the compressed audio. Playback sound of lossy compressed files such as MP3 will be improved. The setting can be separately set to each input selector.

- The setting is effective in the signals of 48 kHz or less. The setting is not effective in the bitstream signals.
- It cannot be set if the listening mode is Direct.

**Late Night:** Make small sounds to be easily heard. It is useful when you need to reduce the volume while watching a movie late night. You can enjoy the effect only with Dolby Digital, Dolby Digital Plus, and Dolby TrueHD input sources.

- Turning the unit to standby mode will set the setting to "Off". In case of Dolby TrueHD, the setting will be set to "Auto".
- If "Loudness Management" is set to "Off", this function is not available when playing Dolby Digital Plus or Dolby TrueHD.

**Cinema Filter:** Adjust the soundtrack that was processed to enhance its treble, in order to make it suitable for home theater.

- This function can be used in the following listening modes: Dolby Digital, Dolby Digital Plus, Dolby TrueHD, Multichannel, DSD, DTS, DTS-ES, DTS Neo:6 Cinema, DTS 96/24, DTS-HD High Resolution Audio, DTS-HD Master Audio, DTS Express.

**Center Spread:** Adjust the width of the sound field of the front channel when playing in the Dolby Surround listening mode.

To spread the width of the sound field to the left and right, set to "On". To concentrate sound in the center, set to "Off".

- Depending on the speaker settings, this becomes "Off".

#### ■ Information:

**Audio:** Displays the audio input source, format, number of channels, sampling frequency, listening mode, and number of output channels.

**Video:** Displays information such as the video input source, resolution, color space, color depth, 3D information, Aspect and output.

**Tuner:** Displays information such as the band, frequency, and preset number. This is displayed only when "TUNER" is selected as the input source.

## 6 Other useful functions

### To adjust the sound quality

It is possible to enhance or moderate the bass and treble of front speakers. Press TONE on the main unit several times to select the desired setting from "Bass", "Treble" and "Phase Matching Bass", and adjust with +/-.

- It cannot be set if the listening mode is Direct.
- "Bass":** Allows you to enhance or moderate the bass.
- "Treble":** Allows you to enhance or moderate the treble.
- "Phase Matching Bass":** Allows you to keep the clear midrange and effectively enhance the bass.

### Checking the Input Format

Press DISPLAY on the remote controller several times to switch the display of the main unit in order of:

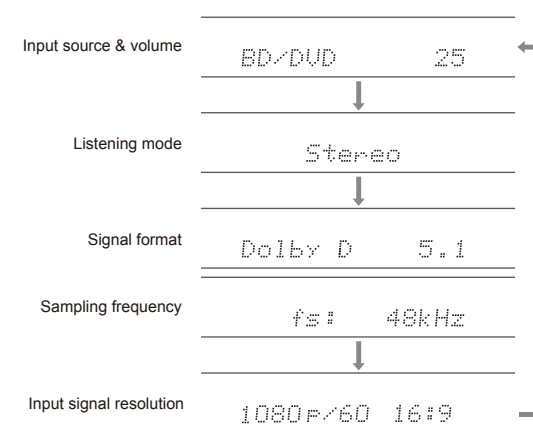

- If "Dolby D 5.1" is displayed in Signal format, the Dolby Digital 5.1 ch signals are being input. When listening to AM/FM radio, the band, frequency and preset number are displayed.

### Playing Audio and Video from Separate Sources

It is possible to play audio and video from different sources. For example, you can play audio from the CD player and video from the BD/DVD player. In this case, press BD/DVD and then CD. Then start playback on the BD/DVD player and CD player. This function is effective when an input with audio only has been selected (CD, TUNER or BLUETOOTH). (\*)

\* When BLUETOOTH is selected, press MODE on the remote controller.



# Others

## Troubleshooting

### Before starting the procedure

Problems may be solved by simply turning the power on/off or disconnecting/connecting the power cord, which is easier than working on the connection, setting and operating procedure. Try the simple measures on both the unit and the connected device. If the problem is that the video or audio is not output or the HDMI linked operation does not work, disconnecting/connecting the HDMI cable may solve it. When reconnecting, be careful not to wind the HDMI cable since if wound the HDMI cable may not fit well. After reconnecting, turn off and on the unit and the connected device.

### The AV receiver turns off unexpectedly.

- The AV receiver will automatically enter standby mode when Auto Standby or Sleep Timer is set and launched.
- The protection circuit may have been activated. If this is the case, when you turn the unit on again, "AMP Diag Mode" will appear on the main unit's display. The unit will then enter a mode that detects abnormal conditions. If no problems are detected, "AMP Diag Mode" will disappear and the unit will return to a normal state. If "CHECK SP WIRE" appears on the display, the speaker cables may be short-circuited. Turn the unit off, and check to see if the cable core of any of the speaker cables is in contact with that of another speaker cable or with the rear panel. After that, turn the unit on again. If "NG" appears, unplug the power cord immediately and contact your Onkyo dealer.

### There's no sound, or it's very quiet.

- A wrong input selector button has been selected. Select a correct input for the player. Also check that muting is not on.
- Not all listening modes use all speakers.

### There's no picture.

- A wrong input selector button has been selected.
- To display video from the connected player on the TV screen while the unit is in standby, you need to enable HDMI Standby Through function.
- When the TV image is blurry or unclear, power cord or connection cables of the unit may have interfered. In that case, keep distance between TV antenna cable and cables of the unit.

### Video and audio are out of synch.

- Video may be delayed relative to audio depending on the settings and connections with your TV. Adjust in "Step 3: Playing Back", "5 Quick Setup Menu", "A/V Sync".

### Cannot play digital surround.

- To enjoy digital surround sound including Dolby Digital and DTS, audio output should be set to "Bitstream output" on the connected Blu-ray Disc Player or other device.

### Cannot output audio such as Dolby Atmos according to the format of the source.

- If you cannot output audio according to the format of the source (Dolby TrueHD, Dolby Atmos, DTS-HD Master Audio, etc.), in the Blu-ray Disc Player settings try setting "BD video supplementary sound" (or secondary sound) to "Off". Change the listening mode for each source after changing the setting to confirm.

### HDMI control does not function correctly.

- Set the CEC link function of the unit to on. It is also necessary to make the HDMI linked system setting on the TV. See the TV's instruction manual for details.

## Resetting the unit

Resetting the unit to the status at the time of shipment may solve the problem. If the measures above do not solve the problem, reset the unit with the following procedure. If you reset the unit status, your preferences will be reset to the defaults. Note them down before starting reset.

### How to reset:

1. While holding down CBL/SAT on the main unit (note that step 2 must be performed with this button pressed down)
2. Press **ON/STANDBY** on the main unit. ("Clear" appears on the display and the unit returns to standby.)
  - Do not unplug the power cord until "Clear" disappears from the display.

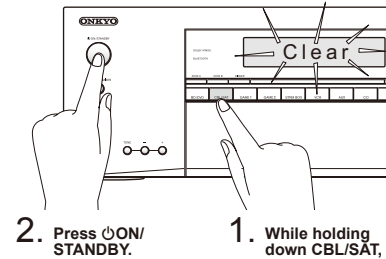

### How to reset the remote controller:

1. While holding down RECEIVER on the remote controller, press Q until the remote indicator stays lit (about 3 seconds).
2. Within 30 seconds, press RECEIVER again.

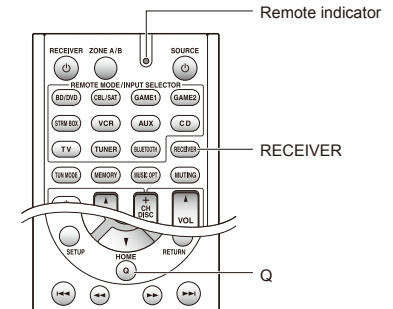



## Specifications

### Amplifier Section

#### Rated Output Power (North American)

With 8 ohm loads, both channels driven, from 20-20,000 Hz; rated 65 watts per channel minimum RMS power, with no more than 0.7% total harmonic distortion from 250 milliwatts to rated output.

#### Surround Mode Output Power (\*)

(6 ohms, 1 kHz THD 0.9%) 115 W per channel

\* Reference output for each speakers.

Depending on the source and the listening mode settings, there may be no sound output.

#### Rated Output Power (Others)

7 ch x 100 W at 6 ohms, 1 kHz, 1 ch driven of 1% (IEC)

#### Maximum Effective Output Power

7 ch x 120 W at 6 ohms, 1 kHz, 1 ch driven (JEITA) (Asian)

#### Dynamic Power (\*)

\* IEC60268-Short-term maximum output power

160 W (3 Ω, Front)

125 W (4 Ω, Front)

85 W (8 Ω, Front)

#### THD+N (Total Harmonic Distortion+Noise)

0.08% (20 Hz - 20 kHz, half power)

#### Input Sensitivity and Impedance (Unbalance)

200 mV/47 kΩ (LINE, 1 kHz 100 W/8 Ω)

#### Rated RCA Output Level and Impedance

1 V/470 Ω (SUBWOOFER PRE OUT)

#### Frequency Response

10 Hz - 100 kHz/+1 dB, -3 dB (Direct mode)

#### Tone Control Characteristics

±10 dB, 20 Hz (BASS)

±10 dB, 20 kHz (TREBLE)

#### Signal to Noise Ratio

100 dB (LINE, IHF-A)

#### Speaker Impedance

6 Ω - 16 Ω

### Video Section

#### Signal level

1.0 Vp-p/75 Ω (Component Y)

0.7 Vp-p/75 Ω (Component Pb/Cb, Pr/Cr)

1.0 Vp-p/75 Ω (Composite)

Maximum resolution supported by component video

480i/576i

### Tuner Section

#### FM Tuning Frequency Range

87.5 MHz - 107.9 MHz (North American and Taiwanese)

87.5 MHz - 108.0 MHz, RDS (Others)

#### AM Tuning Frequency Range

522/530 kHz - 1611/1710 kHz

#### Preset Channel

40

### Bluetooth Section

#### Communication system

Bluetooth Specification version 2.1 +EDR (Enhanced Data Rate)

#### Maximum communication range

Line of sight approx. 15 m (\*)

#### Frequency band

2.4 GHz band

#### Modulation method

FHSS (Freq Hopping Spread Spectrum)

#### Compatible Bluetooth profiles

A2DP 1.3 (Advanced Audio Distribution Profile)

AVRCP 1.5 (Audio Video Remote Control Profile)

#### Supported Codecs

SBC

#### Transmission range (A2DP)

20 Hz - 20,000 Hz (Sampling frequency 44.1 kHz)

\* The actual range will vary depending on factors such as obstacles between devices, magnetic fields around a microwave oven, static electricity, cordless phone, reception sensitivity, antenna's performance, operating system, software application, etc.

### General

#### Power Supply

AC 120 V, 60 Hz (North American and Taiwanese)

AC 220 - 240 V, 50/60 Hz (Others)

#### Power Consumption

4.3 A (North American and Taiwanese)

420 W (Others)

0.15 W (Stand-by, North American and Taiwanese)

0.3 W (Stand-by, Others)

55 W (No-sound)

#### Dimensions (W x H x D)

435 mm x 160 mm x 328 mm

17-1/8" x 6-5/16" x 12-15/16"

#### Weight

7.8 kg (17.2 lbs.) (North American and Taiwanese)

8.0 kg (17.6 lbs.) (Others)

### ● HDMI

#### Input

BD/DVD, CBL/SAT, GAME 1, STRM BOX

#### Output

HDMI OUT (to TV)

#### Video Resolution

4K 60 Hz (RGB/YCbCr 4:4:4/YCbCr 4:2:2, 24 bit)

#### Audio Format

Dolby Atmos, Dolby TrueHD, Dolby Digital Plus, Dolby Digital, DTS-HD Master Audio, DTS-HD High Resolution Audio, DTS 96/24,

DTS-ES, DTS, DTS Express, DSD, Multichannel PCM (up to 8ch)

#### Supported

3D, Audio Return Channel, Deep Color, x.v.Color™, LipSync, CEC, 4K, Extended Colorimetry (sYCC601, Adobe RGB, Adobe YCC601), Content Type, 3D Dual View, 21:9 Aspect Ratio Video Format

### ● Video Inputs

#### Component

COMPONENT VIDEO (BD/DVD, GAME 2)

#### Composite

VIDEO (CBL/SAT, VCR), AUX INPUT VIDEO (front)

### ● Audio Inputs

#### Digital

OPTICAL (CD, TV)

DIGITAL AUDIO (BD/DVD)

#### Analog

AUDIO (BD/DVD, CBL/SAT, GAME 2, VCR, CD, TV)

AUX INPUT (front)

### ● Audio Outputs

#### Analog

Pre Out (ZONE A SUBWOOFER)

#### Speaker Outputs

ZONE A (FRONT L/R, CENTER, SURROUND L/R, BACK/HEIGHT L/R),

ZONE B (FRONT L/R)

#### Phones

PHONES (Front, ø 6.3)

### ● Others

Setup Mic 1 (Front)

RI REMOTE CONTROL 1

STRM BOX POWER OUT 1 (5 V/1 A)

Specifications and features are subject to change without notice.



### Table of display resolutions

Refer to the following table for information about the image formats and resolutions output by this unit in response to input signals.

Input	Output	HDMI						
		4K	1080p/24	1080p	1080i	720p	480p/576p	480i/576i
HDMI	4K	○						
	1080p/24		○					
	1080p			○				
	1080i				○			
	720p					○		
	480p/576p						○	
Component	480i/576i							○
	1080p							
	1080i							
	720p							
	480p/576p							
Composite	480i/576i							○

### Resolutions supported by HDMI

Input support	Content protection technology	Display resolution	Frame rate	Color space	Color Depth	Remarks			
HDMI input (BD/DVD, CBL/SAT, GAME1, STRM BOX)	HDCP1.4 HDCP2.2	720×480i	60Hz	RGB/YCbCr4:4:4/ YCbCr4:2:2	8/10/12/16bit	With YCbCr4:2:2, Color Depth supported is up to 8/10/12bit.			
		720×576i	50Hz						
		720×480p	60Hz						
		720×576p	50Hz						
		1920×1080i	50/60Hz						
		1280×720p	24/25/30/50/60Hz						
		1680×720p	24/25/30/50/60Hz						
		1920×1080p	24/25/30/50/60Hz						
		2560×1080p	24/25/30/50/60Hz						
		4K (3840×2160p)	24/25/30Hz	RGB/YCbCr4:4:4/ YCbCr4:2:2	8/10/12/16bit	With YCbCr4:2:2, Color Depth supported is up to 8/10/12bit.			
							50/60Hz	RGB/YCbCr4:4:4	8bit
								YCbCr4:2:2	8/10/12bit
			50/60Hz	YCbCr4:2:0	8/10/12/16bit	With YCbCr4:2:2, Color Depth supported is up to 8/10/12bit.			
							4K SMPTE (4096×2160p)	24/25/30Hz	RGB/YCbCr4:4:4/ YCbCr4:2:2
50/60Hz	RGB/YCbCr4:4:4								
			YCbCr4:2:2	8/10/12bit					
		YCbCr4:2:0	8/10/12/16bit						



## Precautions

### For European Models

#### Declaration of Conformity

We declare, under our sole responsibility, that this product complies with the standards:

- Safety
  - Limits and methods of measurement of radio disturbance characteristics
  - Limits for harmonic current emissions
  - Limitation of voltage changes, voltage fluctuations and flicker
  - RoHS Directive, 2011/65/EU
- Hereby, Onkyo Corporation, declares that this TX-SR444 is in compliance with the essential requirements and other relevant provisions of Directive 1999/5/EC.
- С настоящето, Onkyo Corporation, декларира, че TX-SR444 е в съответствие със съществените изисквания и другитеприложими разпоредби на Директива 1999/5/EC.
- Onkyo Corporation tímto prohlašuje, že TX-SR444 splňuje základní požadavky a všechna příslušná ustanovení Směrnice 1999/5/ES.
- Undertegnede Onkyo Corporation erklærer herved, at følgende udstyr TX-SR444 overholder de væsentlige krav og øvrige relevante krav i direktiv 1999/5/EF.
- Hiermit erklärt Onkyo Corporation, dass sich das Gerät TX-SR444 in Übereinstimmung mit den grundlegenden Anforderungen und den übrigen einschlägigen Bestimmungen der Richtlinie 1999/5/EG befindet.
- Käesolevaga kinnitab Onkyo Corporation seadme TX-SR444 vastavust direktiivi 1999/5/EÜ põhinõuetele ja nimetatud direktiivi tulenevatele teistele asjakohastele sätetele.
- ΜΕ ΤΗΝ ΠΑΡΟΥΣΑ Ο ΚΑΤΑΣΚΕΥΑΣΤΗΣ Onkyo Corporation ΔΗΛΩΝΕΙ ΟΤΙ ΤΑ TX-SR444 ΣΥΜΜΟΡΦΟΝΕΤΑΙ ΠΡΟΣ ΤΙΣ ΟΥΣΙΩΔΕΙΣ ΑΠΑΙΤΗΣΕΙΣ ΚΑΙ ΤΙΣ ΛΟΙΠΕΣ ΣΧΕΤΙΚΕΣ ΔΙΑΤΑΞΕΙΣ ΤΗΣ ΟΔΗΓΙΑΣ 1999/5/ΕΚ
- Por la presente, Onkyo Corporation, declara que este TX-SR444 cumple con los requisitos esenciales y otras exigencias relevantes de la Directiva 1999/5/EC.
- Par la présente, Onkyo Corporation déclare que l'appareil TX-SR444 est conforme aux exigences essentielles et aux autres dispositions pertinentes de la directive 1999/5/CE.
- Con la presente Onkyo Corporation dichiara che questo TX-SR444 è conforme ai requisiti essenziali ed alle altre disposizioni pertinenti stabilite dalla direttiva 1999/5/CE.
- Ar šo Onkyo Corporation deklarē, ka TX-SR444 atbilst Direktīvas 1999/5/EK būtiskajām prasībām un citiem ar to saistītajiem noteikumiem.
- Šiuo Onkyo Corporation deklaruoja, kad šis TX-SR444 atitinka esminius reikalavimus ir kitas 1999/5/EB Direktivos nuostatas.
- A Onkyo Corporation ezzennel kijelenti, hogy a TX-SR444 típusú berendezés teljesíti az alapvető követelményeket és más 1999/5/EK irányelvben meghatározott vonatkozó rendelkezéseket.
- Hierbij verklaart Onkyo Corporation dat het toestel I TX-SR444 in overeenstemming is met de essentiële eisen en de andere relevante bepalingen van richtlijn 1999/5/EG.
- Niniejszym Onkyo Corporation deklaruje że TX-SR444 jest zgodny z zasadniczymi wymaganiami i innymi właściwymi postanowieniami Dyrektywy 1999/5/EC.
- Eu, Onkyo Corporation, declaro que o TX-SR444 cumpre os requisitos essenciais e outras provisões relevantes da Directiva 1999/5/EC.



- Prin prezenta, Onkyo Corporation, declară că aparatul TX-SR444 este în conformitate cu cerințele esențiale și cu alte prevederi pertinente ale Directivei 1999/5/CE.
- Onkyo Corporation tímto vyhlasuje, že TX-SR444 a splňa základné požiadavky a všetky príslušné ustanovenia Smernice 1999/5/ES.
- Onkyo Corporation izjavlja, da je ta TX-SR444 v skladu z bistvenimi zahtevami in drugimi relevantnimi določili direktive 1999/5/ES.
- Onkyo Corporation vakuuttaa täten että TX-SR444 tyyppinen laite on direktiivin 1999/5/EY oleellisten vaatimusten ja sitä koskevien direktiivin muiden ehtojen mukainen.
- Härmed förklarar Onkyo Corporation att denna TX-SR444 följer de väsentliga kraven och andra relevanta stadgar i Direktiv 1999/5/EC.
- Hér með lýsir Onkyo Corporation því yfir að varan TX-SR444 er í samræmi við grunnkröfur og aðrar kröfur sem gerðar eru í tilskipun 1999/5/EC.
- Onkyo Corporation erklærer herved at denne TX-SR444 er i overensstemmelse med vesentlige krav og andre relevante bestemmelser i direktiv 1999/5/EC.
- Ovime Onkyo Corporation, potvrđuje da je TX-SR444 u suglasnosti sa osnovnim zahtjevima i ostalim relevantnim odredbama Direktive 1999/5/EC.

## License and Trademark Information



Manufactured under license from Dolby Laboratories. Dolby, Dolby Atmos, Dolby Surround, and the double-D symbol are trademarks of Dolby Laboratories.



For DTS patents, see <http://patents.dts.com>. Manufactured under license from DTS, Inc. DTS, the Symbol, DTS in combination with the Symbol, the DTS-HD logo, and DTS-HD Master Audio are registered trademarks or trademarks of DTS, Inc. in the United States and/or other countries. © DTS, Inc. All Rights Reserved.



"CINEMA FILTER" and "CINEMA FILTER (logo)" are trademarks of Onkyo Corporation.



The terms HDMI and HDMI High-Definition Multimedia Interface, and the HDMI Logo are trademarks or registered trademarks of HDMI Licensing LLC in the United States and other countries.



The Bluetooth® word mark and logos are registered trademarks owned by Bluetooth SIG, Inc. and any use of such marks by Onkyo is under license. Other trademarks and trade names are those of their respective owners. Onkyo does not guarantee Bluetooth compatibility between the AV receiver and all Bluetooth-enabled devices. For compatibility between the AV receiver and another device with Bluetooth technology, consult the device's documentation and dealer. In some countries, there may be restrictions on using Bluetooth devices. Check with your local authorities.

Apple, iPod and iPhone are trademarks of Apple Inc., registered in the U.S. and other countries.

Apple TV is a trademark of Apple Inc., registered in the U.S. and other countries.

QR Code is a registered trademark of DENSO WAVE INCORPORATED.

"x.v.Color" is a trademark of Sony Corporation.





AccuEQ, Music Optimizer, RIHD and WRAT are trademarks of Onkyo Corporation.

"RIHD" and "RIHD (logo)" are trademarks of Onkyo Corporation.

"All other trademarks are the property of their respective owners."



## Supplied Accessories

-  Indoor FM antenna --- (1)
-  AM loop antenna --- (1)
-  Remote controller (RC-896M) --- (1)  
Batteries (AA/R6) --- (2)
-  Power cord (Taiwanese models) --- (1)
-  Speaker setup microphone --- (1)

\* The number in parenthesis indicates the quantity. On packaging, the letter at the end of the product name indicates the color.

## How to use the remote controller

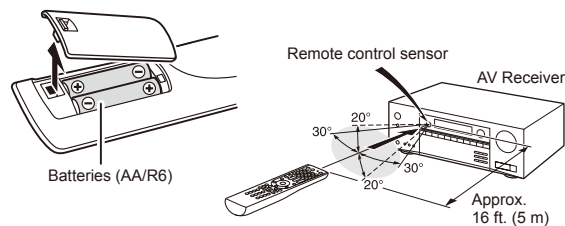

- \* If you do not use the remote controller for a long time, remove the batteries to prevent leakage.
- \* Note that keeping consumed batteries inside may cause corrosion resulting in damage of the remote controller.

# ONKYO

**Onkyo Corporation**  
Kitahama Chuo Bldg, 2-2-22 Kitahama, Chuo-ku,  
OSAKA 541-0041, JAPAN  
<http://www.onkyo.com/>

### The Americas

**Onkyo U.S.A. Corporation**  
18 Park Way, Upper Saddle River, N.J. 07458, U.S.A.  
For Dealer, Service, Order and all other Business Inquiries:  
Tel: 201-785-2600 Fax: 201-785-2650  
<http://www.us.onkyo.com/>

For Product Support Team Only:  
1-800-229-1687  
<http://www.us.onkyo.com/>

### Europe

**Onkyo Europe Electronics GmbH**  
Liegnitzerstrasse 6, 82194 Groebenzell, GERMANY  
Tel: +49-8142-4401-0 Fax: +49-8142-4208-213  
<http://www.eu.onkyo.com/>

### Onkyo Europe Electronics GmbH (UK Branch)

Meridien House, Ground floor, 69 - 71 Clarendon Road,  
Watford, Hertfordshire, WD17 1DS, United Kingdom  
Tel: +44 (0)8712-00-19-96 Fax: +44 (0)8712-00-19-95

### China

**Onkyo China Limited (Hong Kong)**  
Unit 1033, 10/F, Star House, No 3, Salisbury Road,  
Tsim Sha Tsui Kowloon, Hong Kong.  
Tel: 852-2429-3118 Fax: 852-2428-9039  
<http://www.hk.onkyo.com/>

### Onkyo China PRC (Mainland)

1301, 555 Tower, No.555 West NanJing Road, Jing'an District,  
Shanghai, China 200041,  
Tel: 86-21-52131366 Fax: 86-21-52130396  
<http://www.cn.onkyo.com/>

### Asia, Oceania, Middle East, Africa

Please contact an Onkyo distributor referring to Onkyo  
SUPPORT site.  
<http://www.intl.onkyo.com/support/>

The above-mentioned information is subject to change  
without prior notice.  
Visit the Onkyo web site for the latest update.

SN 29401965A

(C) Copyright 2015 Onkyo Corporation Japan. All rights reserved. Onkyo has the Privacy Policy. You can review it at [<http://www.onkyo.com/privacy/>].



\* 2 9 4 0 1 9 6 5 A \*

F1504-1



**ONKYO**

**TX-SR444**  
**AV RECEIVER**

**Advanced Manual**

[The Basic Manual](#) includes information needed when starting up and also instructions for frequently used operations. [The Advanced Manual](#) has more detailed information and advanced settings.

**CONTENTS**

<b>Details on AM/FM reception</b>	<b>2</b>	<b>3. Audio Adjust</b>	<b>20</b>	<b>Connecting and Operating Onkyo RI Components</b>	<b>31</b>
Tuning into a Radio Station	2	4. Source	21	About RI Function	31
Presetting a Radio Station	3	5. Hardware	22	RI Connection and Setting	31
Using RDS (European, Australian and Asian models)	3	6. Remote Controller	25	iPod®/iPhone® Operation	32
<b>Operating Music Files with the Remote Controller</b>	<b>5</b>	<b>Operating Other Components with the Remote Controller</b>	<b>26</b>	<b>Troubleshooting</b>	<b>33</b>
About the Remote Controller	5	Functions of REMOTE MODE Buttons	26	<b>Reference Information</b>	<b>38</b>
Remote Controller Buttons	5	Programming Remote Control Codes	26		
<b>Using the Listening Modes</b>	<b>6</b>	TV operation	27		
Selecting Listening Mode	6	Blu-ray Disc player/DVD player/DVD recorder operation	28		
Listening Mode Types	6	VCR/PVR operation	28		
Selectable Listening Modes	8	Satellite receiver / Cable receiver operation	29		
Checking the Input Format	15	CD player operation	30		
<b>Advanced Settings (Setup Menu)</b>	<b>16</b>	Cassette tape deck operation	30		
How to Set	16	To operate CEC-compatible components	30		
1. TV Out	17				
2. Speaker	17				



## Details on AM/FM reception

### Tuning into a Radio Station

#### ■ Tuning Automatically

1. Press TUNER on the remote controller several times to select either "AM" or "FM".

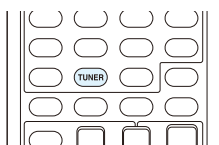

2. Press TUN MODE so that the "AUTO" indicator on the display lights.

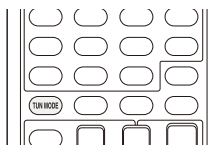

3. Press the cursors ▲/▼ to start automatic tuning.
  - Alternatively you can press ▼TUNING▲ on the main unit to start tuning automatically.
  - Searching automatically stops when a station is found. When tuned into a radio station, the "▶TUNED◀" indicator on the display lights. When tuned into an FM radio station, the "FM STEREO" indicator lights.
  - No sound is output while the "▶TUNED◀" indicator is off.

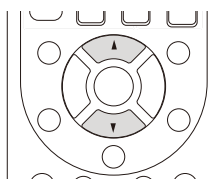

#### When the signal from an FM radio station is weak:

Radio wave may be weak depending on the building structure and environmental conditions. In that case, perform the procedure as explained below in "Tuning Manually" to manually select the desired station.

#### ■ Tuning Manually

1. Press TUNER on the remote controller several times to select either "AM" or "FM".

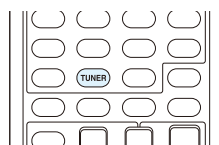

2. Press TUN MODE so that the "AUTO" indicator on the display goes off.

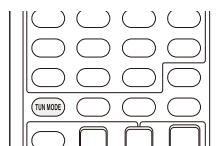

3. While pressing the cursors ▲/▼, select the desired radio station.
  - Alternatively you can press ▼TUNING▲ on the main unit.
  - The frequency changes by 1 step each time you press the button. The frequency changes continuously if the button is held down and stops when the button is released. Tune by looking at the display.

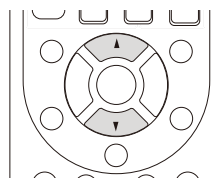

**To return to automatic tuning:** Press TUN MODE on the remote controller again. The unit tunes automatically into a radio station. Normally "AUTO" should be displayed.

#### ■ Directly inputting the frequency

It allows you to directly enter the frequency of the radio station you want to listen to.

1. Press TUNER on the remote controller several times to select either "AM" or "FM".

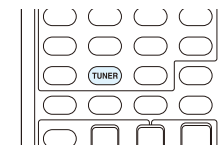

2. Press D.TUN.

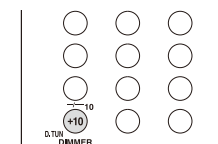

3. Using the number buttons, enter the frequency of the radio station within 8 seconds.
  - To enter 87.5 (FM), for example, press 8, 7, 5, or 8, 7, 5, 0. If you entered a wrong number, press D.TUN and enter a correct one.

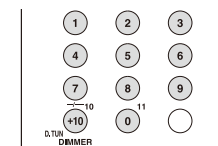

Details on AM/FM reception

## Presetting a Radio Station

It allows you to register up to 40 of your favorite AM/FM radio stations. Registering radio stations in advance allows you to tune into your radio station of choice directly.

### Registration Procedure

1. Tune into the AM/FM radio station you want to register.
2. Press MEMORY on the remote controller so that the preset number on the display flashes.

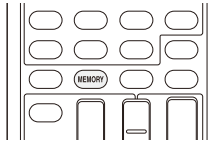

3. Press CH +/- several times to select a number between 1 and 40 while the preset number is flashing (about 8 seconds).
  - Alternatively you can press ◀PRESET▶ on the main unit.

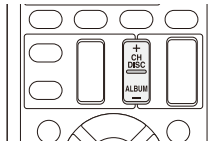

4. Press MEMORY again to register the station.
  - When the station is registered, the preset number stops flashing.
  - Repeat this procedure for all of your favorite AM/FM radio stations.

### Selecting a Preset Radio Station

1. Press CH +/- on the remote controller to select a preset number.
  - Alternatively you can press ◀PRESET▶ on the main unit. You can also select by directly entering the preset number with the number buttons on the remote controller.

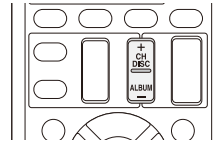

### Deleting a Preset Radio Station

1. Press CH +/- on the remote controller to select the preset number to delete.

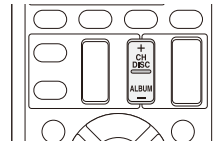

2. Press MEMORY so that the preset number on the display flashes.

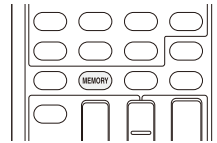

3. Press CLR while the preset number is flashing (about 8 seconds) to delete the preset number.
  - When deleted, the number on the display goes off.

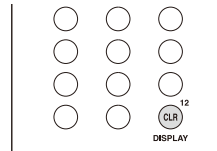

## Using RDS (European, Australian and Asian models)

RDS stands for Radio Data System and is a method of transmitting data in FM radio signals.

- RDS works only in areas where RDS broadcasts are available.
- In some cases, the text information appeared on the display is not identical to the content transmitted by the RDS station. Furthermore, unexpected characters may be displayed when the unit receives unsupported characters. However, this is not a malfunction.
- If the signal from an RDS station is weak, the RDS data may be displayed continuously or not at all.

**PS (Program Service):** Tuning into a radio station distributing Program Service information displays the radio station name. Pressing DISPLAY displays the frequency for 3 seconds.

**RT (Radio Text):** Tuning into a radio station transmitting Radio Text information displays text on the display of the unit.

**PTY (Program Type):** Allows you to search for RDS stations by program type.

**TP (Traffic Program):** Allows you to search for radio stations transmitting traffic information.

### Displaying Radio Text (RT)

1. Press RT/PTY/TP on the main unit once.
  - The Radio Text (RT) is displayed scrolling across the display. "No Text Data" is displayed when no text information is available.



### Searching by Type (PTY)

1. Press RT/PTY/TP on the main unit twice.
  - The current program type appears on the display.



2. Press ◀PRESET▶ to select the type of program to search for.



TUNING ▲ / PRESET ▼

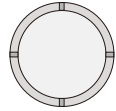

- The following RDS station types are displayed:

None  
 News (News reports)  
 Affairs (Current affairs)  
 Info (Information)  
 Sport  
 Educate (Education)  
 Drama  
 Culture  
 Science (Science and technology)  
 Varied  
 Pop M (Pop music)  
 Rock M (Rock music)  
 Easy M (Middle of the road music)  
 Light M (Light classics)  
 Classics (Serious classics)  
 Other M (Other music)  
 Weather  
 Finance  
 Children (Children's programmes)  
 Social (Social affairs)  
 Religion  
 Phone In  
 Travel  
 Leisure  
 Jazz (Jazz music)  
 Country (Country music)  
 Nation M (National music)  
 Oldies (Oldies music)  
 Folk M (Folk music)  
 Document (Documentary)

- Press ENTER to search the radio stations of the selected type.

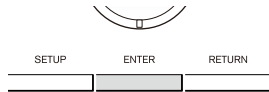

- When such a radio station is found, the indication on the display flashes. Then, press ENTER again.
  - If no stations are found, the message "Not Found" is displayed.

### ■ Listening to Traffic Information (TP)

- Press RT/PTY/TP on the main unit three times.
  - "[TP]" will be displayed if traffic information is transmitted by the radio station you are tuned in. "TP" only is displayed if no traffic information is available.

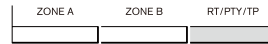

- Press ENTER to search a radio station distributing traffic information.

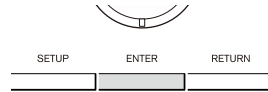

- When a radio station is found, searching stops and traffic information starts.
  - "Not Found" is displayed if no radio station distributing traffic information is found.





## Operating Music Files with the Remote Controller

### About the Remote Controller

Use the remote controller of this unit to play music files stored on a Bluetooth-enabled device.

- The Bluetooth-enabled devices must support the AVRCP profile. Some devices may not be operated, even when they support AVRCP profile.

### Remote Controller Buttons

1. Press BLUETOOTH on the remote controller.

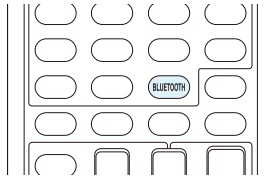

2. Operate the remote controller by referring to the name and function of each of the buttons.

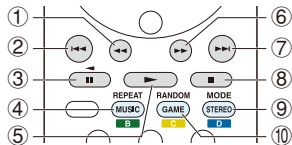

- ① ◀◀: This button fast-reverses the current track.
- ② ◀◀◀: This button plays the current track from the beginning. Pressing this button twice plays the previous track.
- ③ ||: This button pauses the playback.
- ④ REPEAT: This button replays the track (or tracks). Pressing this button repeatedly cycles through the repeat modes.
- ⑤ ▶: This button starts the playback.
- ⑥ ▶▶: This button fast-forwards the current track.

- ⑦ ▶▶|: This button plays the next track.
- ⑧ ■: This button stops the playback.
- ⑨ MODE: This button displays the video from the input selected in "Video Select". Each press of the button displays or turns off the video. You can change the display position of the OSD by pressing ENTER while the video is displayed on the screen.
  - These buttons are disabled when the OSD language is set to Chinese. (European, Australian, Taiwanese and Asian models)
- ⑩ RANDOM: This button performs random playback.



## Using the Listening Modes

### Selecting Listening Mode

The listening modes allow you to select the best sound effect for your input source.

1. After pressing RECEIVER on the remote controller, press one of the following four buttons.

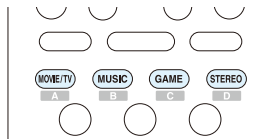

2. Press the selected button repeatedly to switch the modes displayed on the display of the unit.
  - Set the listening mode of your choice by listening to the actual sound.

Dolby D

For details on the listening modes see "Listening Mode Types". For listening modes selectable with each button, refer to "Selectable Listening Modes".

### Listening Mode Types

#### In alphabetical order

##### ■ AllCh Stereo

Ideal for background music, this mode fills the entire listening area with stereo sound.

##### ■ Direct

In this mode, audio from the input source is output as-is. For example, if a 2 ch source from a music CD is input, the output will be stereo, or if Dolby Digital signal is input, the sound field will be controlled in accordance with the number of channels present.

##### ■ Dolby Atmos

Introduced first in the cinema, Dolby Atmos brings a revolutionary sense of dimension and immersion to the Home Theater experience. Dolby Atmos is an adaptable and scalable object based format that reproduces audio as independent sounds (or objects) that can be accurately positioned and move dynamically throughout the 3 dimensional listening space during playback. A key ingredient of Dolby Atmos is the introduction of a height plane of sound above the listener.

##### ■ Dolby D (Dolby Digital)

Mode suitable for playing sources recorded in Dolby Digital.

- This listening mode can be selected only if your Blu-ray Disc/DVD player is digitally connected to the unit or the player's output setting is bitstream.

##### ■ Dolby D+ (Dolby Digital Plus)

Mode suitable for playing sources recorded in Dolby Digital Plus.

- This listening mode can be selected only if your Blu-ray Disc/DVD player is digitally connected to the unit or the player's output setting is bitstream.

##### ■ Dolby Surround

Dolby surround is a next generation surround technology that intelligently up mixes stereo; 5.1 and 7.1 content for playback through your surround speaker system. Dolby surround is compatible with traditional speaker layouts, as well as Dolby Atmos enabled playback systems that employ in-ceiling speakers or products with Dolby speaker technology.

##### ■ Dolby TrueHD

Mode suitable for playing sources recorded in Dolby TrueHD.

- This listening mode can be selected only if your Blu-ray Disc/DVD player is digitally connected to the unit or the player's output setting is bitstream.

##### ■ DSD

Mode suitable for playing sources recorded in DSD.

- This unit supports DSD signals input through HDMI input jack. However, depending on the connected player, better sound is possible when output from the PCM output of the player.
- This listening mode cannot be selected if the output setting on your Blu-ray Disc/DVD player is not set to DSD.

##### ■ DTS

Mode suitable for playing sources recorded in DTS.

- This listening mode can be selected only if your Blu-ray Disc/DVD player is digitally connected to the unit or the player's output setting is bitstream.

##### ■ DTS 96/24

Mode suitable for playing sources recorded in DTS 96/24. With 96 kHz sampling rate and 24-bit resolution, it provides superior fidelity.

- Depending on the settings, this listening mode becomes DTS.
- This listening mode can be selected only if your Blu-ray Disc/DVD player is digitally connected to the unit or the player's output setting is bitstream.

##### ■ DTS Express

Mode suitable for playing sources recorded in DTS Express.

- This listening mode can be selected only if your Blu-ray Disc/DVD player is digitally connected to the unit or the player's output setting is bitstream.

##### ■ DTS-HD HR (DTS-HD High Resolution Audio)

Mode suitable for playing sources recorded in DTS-HD High Resolution Audio.

- This listening mode can be selected only if your Blu-ray Disc/DVD player is digitally connected to the unit or the player's output setting is bitstream.



## Using the Listening Modes

**■ DTS-HD MSTR (DTS-HD Master Audio)**

Mode suitable for playing sources recorded in DTS-HD Master Audio.

- This listening mode can be selected only if your Blu-ray Disc/DVD player is digitally connected to the unit or the player's output setting is bitstream.

**■ DTS Neo:6**

This mode expands any 2 ch source for 5.1 ch multichannel surround playback. It offers full-bandwidth on all channels, with great independence between the channels. There are two variants for this mode: one ideal for movies and another ideal for music.

- **Neo:6 Cinema:** Use this mode with any 2 ch movie.
- **Neo:6 Music:** Use this mode with any 2 ch music source.

**■ ES Discrete (DTS-ES Discrete)**

This mode is for use with DTS-ES Discrete sources and enables 6.1 ch or 7.1 ch playback using back channel. Completely discrete seven channels will improve spatial imaging and enable 360-degree sound localization producing a sound crossing between the surround channels.

- This listening mode can be selected only if your Blu-ray Disc/DVD player is digitally connected to the unit or the player's output setting is bitstream.
- Use on the DVD with DTS ES logo, particularly on the software containing DTS-ES Matrix soundtrack.

**■ ES Matrix (DTS-ES Matrix)**

This mode is for use with DTS-ES Matrix soundtrack and enables 6.1 ch or 7.1 ch playback using matrix-encoded back channel.

- This listening mode can be selected only if your Blu-ray Disc/DVD player is digitally connected to the unit or the player's output setting is bitstream.
- Use on the CD, DVD or LD with DTS ES logo, particularly on the software containing DTS-ES Matrix soundtrack.

**■ Full Mono**

In this mode, all speakers output the same sound in mono, so the sound you hear is the same regardless of where you are within the listening room.

**■ Game-Action**

In this mode, sound localization is distinct with emphasis on bass.

**■ Game-Rock**

In this mode, sound pressure is emphasized to heighten live feel.

**■ Game-RPG**

In this mode, the sound has a dramatic feel with a similar atmosphere to Orchestra mode.

**■ Game-Sports**

Suitable for audio source with much reverberation.

**■ Mono**

Use this mode when watching an old movie with a mono soundtrack, or use it to separately reproduce soundtracks in two different languages recorded in the left and right channels of some movies. It is also suitable for DVDs or other sources containing multiplexed audio.

**■ Multich (Multichannel)**

Mode suitable for playing sources recorded in PCM multichannel.

**■ Orchestra**

Suitable for classical or operatic music. This mode emphasizes the surround channels in order to widen the stereo image, and simulates the natural reverberation of a large hall.

**■ Stereo**

In this mode, sound is output from the front left and right speakers and subwoofer.

**■ Studio-Mix**

Suitable for rock or pop music. Listening to music in this mode creates a lively sound field with a powerful acoustic image, like being at a club or rock concert.

**■ T-D (Theater-Dimensional)**

In this mode, you can enjoy a virtual playback of multichannel surround sound even with only two or three speakers. This works by controlling how sounds reach the

listener's left and right ears.

**■ TV Logic**

Suitable for TV shows produced in a TV studio. This mode enhances the surround effects to the entire sound to give clarity to voices and create a realistic acoustic image.

**■ Unplugged**

Suitable for acoustic instruments, vocals and jazz. This mode emphasizes the front stereo image, giving the impression of being right in front of the stage.



Using the Listening Modes

**Selectable Listening Modes**

Listening modes that can be selected with the listening mode buttons will differ depending on the input signal format and actual speaker configuration. Also note that depending on the player settings and content, some listening modes may not be available for selecting.

- Listening modes available when headphones are connected are: Mono, Direct, and Stereo.

■ **MOVIE/TV button**

You can select a mode suitable for movies and TV programs.

Input Format	Listening Mode
Analog	Direct
	Mono
	Dolby Surround
	Neo:6 Cinema*1
	TV Logic*2
	AllCh Stereo*3
	Full Mono*3
T-D	

\*1 Center speaker or surround speakers need to be installed.

\*2 Surround speakers or height speakers need to be installed.

\*3 Center speaker, surround speakers or height speakers need to be installed.

Input Format	Listening Mode
PCM	Direct
	Mono
	Dolby Surround
	Neo:6 Cinema*1
	TV Logic*2
	AllCh Stereo*3
	Full Mono*3
T-D	

\*1 Center speaker or surround speakers need to be installed.

\*2 Surround speakers or height speakers need to be installed.

\*3 Center speaker, surround speakers or height speakers need to be installed.

Input Format	Listening Mode
Multich PCM	Direct
	Mono
	Multich*1
	Dolby Surround
	TV Logic*2
	AllCh Stereo*3
	Full Mono*3
T-D	

\*1 Center speaker or surround speakers need to be installed.

\*2 Surround speakers or height speakers need to be installed.

\*3 Center speaker, surround speakers or height speakers need to be installed.

Input Format	Listening Mode
DSD	Direct
	Mono
	DSD*1 *2
	Dolby Surround
	Neo:6 Cinema*3
	TV Logic*4
	AllCh Stereo*5
	Full Mono*5
	T-D

\*1 Cannot be selected when the input format is monaural or 2 ch.

\*2 Center speaker or surround speakers need to be installed.

\*3 Can only be selected when the input format is 2 ch and a center speaker or surround speakers are installed.

\*4 Surround speakers or height speakers need to be installed.

\*5 Center speaker, surround speakers or height speakers need to be installed.

Input Format	Listening Mode
Dolby Atmos	Direct
	Mono
	Dolby Atmos
	TV Logic
	AllCh Stereo
	Full Mono
T-D	

- The listening mode of Dolby Digital Plus or Dolby TrueHD can be selected if back speakers or height speakers are not connected.

Input Format	Listening Mode
Dolby D	Direct
	Mono
	Dolby D*1 *2
	Dolby Surround
	Neo:6 Cinema*3
	TV Logic*4
	AllCh Stereo*5
	Full Mono*5
T-D	

\*1 Cannot be selected when the input format is monaural or 2 ch.

\*2 Center speaker or surround speakers need to be installed.

\*3 Can only be selected when the input format is 2 ch and a center speaker or surround speakers are installed.

\*4 Surround speakers or height speakers need to be installed.

\*5 Center speaker, surround speakers or height speakers need to be installed.



Using the Listening Modes

Input Format	Listening Mode
Dolby D+	Direct
	Mono
	Dolby D+ <sup>*1 *2</sup>
	Dolby Surround
	Neo:6 Cinema <sup>*3</sup>
	TV Logic <sup>*4</sup>
	AllCh Stereo <sup>*5</sup>
	Full Mono <sup>*5</sup>
	T-D

<sup>\*1</sup> Cannot be selected when the input format is monaural or 2 ch.

<sup>\*2</sup> Center speaker or surround speakers need to be installed.

<sup>\*3</sup> Can only be selected when the input format is 2 ch and a center speaker or surround speakers are installed.

<sup>\*4</sup> Surround speakers or height speakers need to be installed.

<sup>\*5</sup> Center speaker, surround speakers or height speakers need to be installed.

Input Format	Listening Mode
Dolby TrueHD	Direct
	Mono
	Dolby TrueHD <sup>*1 *2</sup>
	Dolby Surround
	Neo:6 Cinema <sup>*3</sup>
	TV Logic <sup>*4</sup>
	AllCh Stereo <sup>*5</sup>
	Full Mono <sup>*5</sup>
	T-D

<sup>\*1</sup> Cannot be selected when the input format is monaural or 2 ch.

<sup>\*2</sup> Center speaker or surround speakers need to be installed.

<sup>\*3</sup> Can only be selected when the input format is 2 ch and a center speaker or surround speakers are installed.

<sup>\*4</sup> Surround speakers or height speakers need to be installed.

<sup>\*5</sup> Center speaker, surround speakers or height speakers need to be installed.

Input Format	Listening Mode
DTS	Direct
	Mono
	DTS <sup>*1 *2</sup>
	Dolby Surround
	Neo:6 Cinema <sup>*3</sup>
	TV Logic <sup>*4</sup>
	AllCh Stereo <sup>*5</sup>
	Full Mono <sup>*5</sup>
	T-D

<sup>\*1</sup> Cannot be selected when the input format is monaural or 2 ch.

<sup>\*2</sup> Center speaker or surround speakers need to be installed.

<sup>\*3</sup> Can only be selected when the input format is 2 ch and a center speaker or surround speakers are installed.

<sup>\*4</sup> Surround speakers or height speakers need to be installed.

<sup>\*5</sup> Center speaker, surround speakers or height speakers need to be installed.

Input Format	Listening Mode
DTS 96/24	Direct
	Mono
	DTS 96/24 <sup>*1 *2</sup>
	Dolby Surround
	Neo:6 Cinema <sup>*3</sup>
	TV Logic <sup>*4</sup>
	AllCh Stereo <sup>*5</sup>
	Full Mono <sup>*5</sup>
	T-D

<sup>\*1</sup> Cannot be selected when the input format is monaural or 2 ch.

<sup>\*2</sup> Center speaker or surround speakers need to be installed.

<sup>\*3</sup> Can only be selected when the input format is 2 ch and a center speaker or surround speakers are installed.

<sup>\*4</sup> Surround speakers or height speakers need to be installed.

<sup>\*5</sup> Center speaker, surround speakers or height speakers need to be installed.

Input Format	Listening Mode
DTS Express	Direct
	Mono
	DTS Express <sup>*1 *2</sup>
	Dolby Surround
	Neo:6 Cinema <sup>*3</sup>
	TV Logic <sup>*4</sup>
	AllCh Stereo <sup>*5</sup>
	Full Mono <sup>*5</sup>
	T-D

<sup>\*1</sup> Cannot be selected when the input format is monaural or 2 ch.

<sup>\*2</sup> Center speaker or surround speakers need to be installed.

<sup>\*3</sup> Can only be selected when the input format is 2 ch and a center speaker or surround speakers are installed.

<sup>\*4</sup> Surround speakers or height speakers need to be installed.

<sup>\*5</sup> Center speaker, surround speakers or height speakers need to be installed.

Input Format	Listening Mode
DTS-HD HR	Direct
	Mono
	DTS-HD HR <sup>*1 *2</sup>
	Dolby Surround
	Neo:6 Cinema <sup>*3</sup>
	TV Logic <sup>*4</sup>
	AllCh Stereo <sup>*5</sup>
	Full Mono <sup>*5</sup>
	T-D

<sup>\*1</sup> Cannot be selected when the input format is monaural or 2 ch.

<sup>\*2</sup> Center speaker or surround speakers need to be installed.

<sup>\*3</sup> Can only be selected when the input format is 2 ch and a center speaker or surround speakers are installed.

<sup>\*4</sup> Surround speakers or height speakers need to be installed.

<sup>\*5</sup> Center speaker, surround speakers or height speakers need to be installed.



Using the Listening Modes

Input Format	Listening Mode
DTS-HD MSTR	Direct
	Mono
	DTS-HD MSTR*1 *2
	Dolby Surround
	Neo:6 Cinema*3
	TV Logic*4
	AllCh Stereo*5
	Full Mono*5
	T-D

\*1 Cannot be selected when the input format is monaural or 2 ch.

\*2 Center speaker or surround speakers need to be installed.

\*3 Can only be selected when the input format is 2 ch and a center speaker or surround speakers are installed.

\*4 Surround speakers or height speakers need to be installed.

\*5 Center speaker, surround speakers or height speakers need to be installed.

Input Format	Listening Mode
DTS-ES	Direct
	Mono
	DTS*1
	ES Matrix*2
	ES Discrete*2
	Dolby Surround*3
	TV Logic*4
	AllCh Stereo*5
	Full Mono*5
	T-D

\*1 Can only be selected when the back speakers are not installed.

\*2 Back speakers need to be installed.

\*3 Height speakers need to be installed.

\*4 Surround speakers or height speakers need to be installed.

\*5 Center speaker, surround speakers or height speakers need to be installed.

■ MUSIC button

You can select a mode suitable for music.

Input Format	Listening Mode
Analog	Direct
	Stereo
	Dolby Surround
	Neo:6 Music*1
	Orchestra*2
	Unplugged*2
	Studio-Mix*2
	AllCh Stereo*3
	Full Mono*3

\*1 Center speaker or surround speakers need to be installed.

\*2 Surround speakers or height speakers need to be installed.

\*3 Center speaker, surround speakers or height speakers need to be installed.

Input Format	Listening Mode
PCM	Direct
	Stereo
	Dolby Surround
	Neo:6 Music*1
	Orchestra*2
	Unplugged*2
	Studio-Mix*2
	AllCh Stereo*3
	Full Mono*3

\*1 Center speaker or surround speakers need to be installed.

\*2 Surround speakers or height speakers need to be installed.

\*3 Center speaker, surround speakers or height speakers need to be installed.

Input Format	Listening Mode
Multich PCM	Direct
	Stereo
	Multich*1
	Dolby Surround
	Orchestra*2
	Unplugged*2
	Studio-Mix*2
	AllCh Stereo*3
	Full Mono*3

\*1 Center speaker or surround speakers need to be installed.

\*2 Surround speakers or height speakers need to be installed.

\*3 Center speaker, surround speakers or height speakers need to be installed.

Input Format	Listening Mode
DSD	Direct
	Stereo
	DSD*1 *2
	Dolby Surround
	Neo:6 Music*3
	Orchestra*4
	Unplugged*4
	Studio-Mix*4
	AllCh Stereo*5
	Full Mono*5

\*1 Cannot be selected when the input format is monaural or 2 ch.

\*2 Center speaker or surround speakers need to be installed.

\*3 Can only be selected when the input format is 2 ch and a center speaker or surround speakers are installed.

\*4 Surround speakers or height speakers need to be installed.

\*5 Center speaker, surround speakers or height speakers need to be installed.



Using the Listening Modes

Input Format	Listening Mode
Dolby Atmos • The listening mode of Dolby Digital Plus or Dolby TrueHD can be selected if back speakers or height speakers are not connected.	Direct
	Stereo
	Dolby Atmos
	Orchestra
	Unplugged
	Studio-Mix
	AllCh Stereo
	Full Mono

Input Format	Listening Mode
Dolby D	Direct
	Stereo
	Dolby D <sup>*1 *2</sup>
	Dolby Surround
	Neo:6 Music <sup>*3</sup>
	Orchestra <sup>*4</sup>
	Unplugged <sup>*4</sup>
	Studio-Mix <sup>*4</sup>
	AllCh Stereo <sup>*5</sup>
Full Mono <sup>*5</sup>	

- <sup>\*1</sup> Cannot be selected when the input format is monaural or 2 ch.
- <sup>\*2</sup> Center speaker or surround speakers need to be installed.
- <sup>\*3</sup> Can only be selected when the input format is 2 ch and a center speaker or surround speakers are installed.
- <sup>\*4</sup> Surround speakers or height speakers need to be installed.
- <sup>\*5</sup> Center speaker, surround speakers or height speakers need to be installed.

Input Format	Listening Mode
Dolby D+	Direct
	Stereo
	Dolby D+ <sup>*1 *2</sup>
	Dolby Surround
	Neo:6 Music <sup>*3</sup>
	Orchestra <sup>*4</sup>
	Unplugged <sup>*4</sup>
	Studio-Mix <sup>*4</sup>
	AllCh Stereo <sup>*5</sup>
	Full Mono <sup>*5</sup>

- <sup>\*1</sup> Cannot be selected when the input format is monaural or 2 ch.
- <sup>\*2</sup> Center speaker or surround speakers need to be installed.
- <sup>\*3</sup> Can only be selected when the input format is 2 ch and a center speaker or surround speakers are installed.
- <sup>\*4</sup> Surround speakers or height speakers need to be installed.
- <sup>\*5</sup> Center speaker, surround speakers or height speakers need to be installed.

Input Format	Listening Mode
Dolby TrueHD	Direct
	Stereo
	Dolby TrueHD <sup>*1 *2</sup>
	Dolby Surround
	Neo:6 Music <sup>*3</sup>
	Orchestra <sup>*4</sup>
	Unplugged <sup>*4</sup>
	Studio-Mix <sup>*4</sup>
	AllCh Stereo <sup>*5</sup>
Full Mono <sup>*5</sup>	

- <sup>\*1</sup> Cannot be selected when the input format is monaural or 2 ch.
- <sup>\*2</sup> Center speaker or surround speakers need to be installed.
- <sup>\*3</sup> Can only be selected when the input format is 2 ch and a center speaker or surround speakers are installed.
- <sup>\*4</sup> Surround speakers or height speakers need to be installed.
- <sup>\*5</sup> Center speaker, surround speakers or height speakers need to be installed.

Input Format	Listening Mode
DTS	Direct
	Stereo
	DTS <sup>*1 *2</sup>
	Dolby Surround
	Neo:6 Music <sup>*3</sup>
	Orchestra <sup>*4</sup>
	Unplugged <sup>*4</sup>
	Studio-Mix <sup>*4</sup>
AllCh Stereo <sup>*5</sup>	
Full Mono <sup>*5</sup>	

- <sup>\*1</sup> Cannot be selected when the input format is monaural or 2 ch.
- <sup>\*2</sup> Center speaker or surround speakers need to be installed.
- <sup>\*3</sup> Can only be selected when the input format is 2 ch and a center speaker or surround speakers are installed.
- <sup>\*4</sup> Surround speakers or height speakers need to be installed.
- <sup>\*5</sup> Center speaker, surround speakers or height speakers need to be installed.

Input Format	Listening Mode
DTS 96/24	Direct
	Stereo
	DTS 96/24 <sup>*1 *2</sup>
	Dolby Surround
	Neo:6 Music <sup>*3</sup>
	Orchestra <sup>*4</sup>
	Unplugged <sup>*4</sup>
	Studio-Mix <sup>*4</sup>
AllCh Stereo <sup>*5</sup>	
Full Mono <sup>*5</sup>	

- <sup>\*1</sup> Cannot be selected when the input format is monaural or 2 ch.
- <sup>\*2</sup> Center speaker or surround speakers need to be installed.
- <sup>\*3</sup> Can only be selected when the input format is 2 ch and a center speaker or surround speakers are installed.
- <sup>\*4</sup> Surround speakers or height speakers need to be installed.
- <sup>\*5</sup> Center speaker, surround speakers or height speakers need to be installed.



Using the Listening Modes

Input Format	Listening Mode
DTS Express	Direct
	Stereo
	DTS Express* <sup>1</sup> * <sup>2</sup>
	Dolby Surround
	Neo:6 Music* <sup>3</sup>
	Orchestra* <sup>4</sup>
	Unplugged* <sup>4</sup>
	Studio-Mix* <sup>4</sup>
	AllCh Stereo* <sup>5</sup>
	Full Mono* <sup>5</sup>

\*<sup>1</sup> Cannot be selected when the input format is monaural or 2 ch.

\*<sup>2</sup> Center speaker or surround speakers need to be installed.

\*<sup>3</sup> Can only be selected when the input format is 2 ch and a center speaker or surround speakers are installed.

\*<sup>4</sup> Surround speakers or height speakers need to be installed.

\*<sup>5</sup> Center speaker, surround speakers or height speakers need to be installed.

Input Format	Listening Mode
DTS-HD HR	Direct
	Stereo
	DTS-HD HR* <sup>1</sup> * <sup>2</sup>
	Dolby Surround
	Neo:6 Music* <sup>3</sup>
	Orchestra* <sup>4</sup>
	Unplugged* <sup>4</sup>
	Studio-Mix* <sup>4</sup>
	AllCh Stereo* <sup>5</sup>
	Full Mono* <sup>5</sup>

\*<sup>1</sup> Cannot be selected when the input format is monaural or 2 ch.

\*<sup>2</sup> Center speaker or surround speakers need to be installed.

\*<sup>3</sup> Can only be selected when the input format is 2 ch and a center speaker or surround speakers are installed.

\*<sup>4</sup> Surround speakers or height speakers need to be installed.

\*<sup>5</sup> Center speaker, surround speakers or height speakers need to be installed.

Input Format	Listening Mode
DTS-HD MSTR	Direct
	Stereo
	DTS-HD MSTR* <sup>1</sup> * <sup>2</sup>
	Dolby Surround
	Neo:6 Music* <sup>3</sup>
	Orchestra* <sup>4</sup>
	Unplugged* <sup>4</sup>
	Studio-Mix* <sup>4</sup>
	AllCh Stereo* <sup>5</sup>
	Full Mono* <sup>5</sup>

\*<sup>1</sup> Cannot be selected when the input format is monaural or 2 ch.

\*<sup>2</sup> Center speaker or surround speakers need to be installed.

\*<sup>3</sup> Can only be selected when the input format is 2 ch and a center speaker or surround speakers are installed.

\*<sup>4</sup> Surround speakers or height speakers need to be installed.

\*<sup>5</sup> Center speaker, surround speakers or height speakers need to be installed.

Input Format	Listening Mode
DTS-ES	Direct
	Stereo
	DTS* <sup>1</sup>
	ES Matrix* <sup>2</sup>
	ES Discrete* <sup>2</sup>
	Dolby Surround* <sup>3</sup>
	Orchestra* <sup>4</sup>
	Unplugged* <sup>4</sup>
	Studio-Mix* <sup>4</sup>
	AllCh Stereo* <sup>5</sup>
Full Mono* <sup>5</sup>	

\*<sup>1</sup> Can only be selected when the back speakers are not installed.

\*<sup>2</sup> Back speakers need to be installed.

\*<sup>3</sup> Height speakers need to be installed.

\*<sup>4</sup> Surround speakers or height speakers need to be installed.

\*<sup>5</sup> Center speaker, surround speakers or height speakers need to be installed.

■ GAME button

You can select a mode suitable for games.

Input Format	Listening Mode
Analog	Direct
	Dolby Surround
	Game-RPG* <sup>1</sup>
	Game-Action* <sup>1</sup>
	Game-Rock* <sup>1</sup>
	Game-Sports* <sup>1</sup>
	AllCh Stereo* <sup>2</sup>
	Full Mono* <sup>2</sup>
T-D	

\*<sup>1</sup> Surround speakers or height speakers need to be installed.

\*<sup>2</sup> Center speaker, surround speakers or height speakers need to be installed.

Input Format	Listening Mode
PCM	Direct
	Dolby Surround
	Game-RPG* <sup>1</sup>
	Game-Action* <sup>1</sup>
	Game-Rock* <sup>1</sup>
	Game-Sports* <sup>1</sup>
	AllCh Stereo* <sup>2</sup>
	Full Mono* <sup>2</sup>
	T-D

\*<sup>1</sup> Surround speakers or height speakers need to be installed.

\*<sup>2</sup> Center speaker, surround speakers or height speakers need to be installed.





Using the Listening Modes

Input Format	Listening Mode
Multich PCM	Direct
	Multich* <sup>1</sup>
	Dolby Surround
	Game-RPG* <sup>2</sup>
	Game-Action* <sup>2</sup>
	Game-Rock* <sup>2</sup>
	Game-Sports* <sup>2</sup>
	AllCh Stereo* <sup>3</sup>
	Full Mono* <sup>3</sup>
T-D	

\*<sup>1</sup> Center speaker or surround speakers need to be installed.

\*<sup>2</sup> Surround speakers or height speakers need to be installed.

\*<sup>3</sup> Center speaker, surround speakers or height speakers need to be installed.

Input Format	Listening Mode
DSD	Direct
	DSD* <sup>1</sup> * <sup>2</sup>
	Dolby Surround
	Game-RPG* <sup>3</sup>
	Game-Action* <sup>3</sup>
	Game-Rock* <sup>3</sup>
	Game-Sports* <sup>3</sup>
	AllCh Stereo* <sup>4</sup>
	Full Mono* <sup>4</sup>
T-D	

\*<sup>1</sup> Cannot be selected when the input format is monaural or 2 ch.

\*<sup>2</sup> Center speaker or surround speakers need to be installed.

\*<sup>3</sup> Surround speakers or height speakers need to be installed.

\*<sup>4</sup> Center speaker, surround speakers or height speakers need to be installed.

Input Format	Listening Mode
Dolby Atmos	Direct
	Dolby Atmos
	Game-RPG
	Game-Action
	Game-Rock
	Game-Sports
	AllCh Stereo
	Full Mono
	T-D
	<ul style="list-style-type: none"> <li>The listening mode of Dolby Digital Plus or Dolby TrueHD can be selected if back speakers or height speakers are not connected.</li> </ul>

Input Format	Listening Mode
Dolby D	Direct
	Dolby D* <sup>1</sup> * <sup>2</sup>
	Dolby Surround
	Game-RPG* <sup>3</sup>
	Game-Action* <sup>3</sup>
	Game-Rock* <sup>3</sup>
	Game-Sports* <sup>3</sup>
	AllCh Stereo* <sup>4</sup>
	Full Mono* <sup>4</sup>
T-D	

\*<sup>1</sup> Cannot be selected when the input format is monaural or 2 ch.

\*<sup>2</sup> Center speaker or surround speakers need to be installed.

\*<sup>3</sup> Surround speakers or height speakers need to be installed.

\*<sup>4</sup> Center speaker, surround speakers or height speakers need to be installed.

Input Format	Listening Mode
Dolby D+	Direct
	Dolby D+* <sup>1</sup> * <sup>2</sup>
	Dolby Surround
	Game-RPG* <sup>3</sup>
	Game-Action* <sup>3</sup>
	Game-Rock* <sup>3</sup>
	Game-Sports* <sup>3</sup>
	AllCh Stereo* <sup>4</sup>
	Full Mono* <sup>4</sup>
T-D	

\*<sup>1</sup> Cannot be selected when the input format is monaural or 2 ch.

\*<sup>2</sup> Center speaker or surround speakers need to be installed.

\*<sup>3</sup> Surround speakers or height speakers need to be installed.

\*<sup>4</sup> Center speaker, surround speakers or height speakers need to be installed.

Input Format	Listening Mode
Dolby TrueHD	Direct
	Dolby TrueHD* <sup>1</sup> * <sup>2</sup>
	Dolby Surround
	Game-RPG* <sup>3</sup>
	Game-Action* <sup>3</sup>
	Game-Rock* <sup>3</sup>
	Game-Sports* <sup>3</sup>
	AllCh Stereo* <sup>4</sup>
	Full Mono* <sup>4</sup>
T-D	

\*<sup>1</sup> Cannot be selected when the input format is monaural or 2 ch.

\*<sup>2</sup> Center speaker or surround speakers need to be installed.

\*<sup>3</sup> Surround speakers or height speakers need to be installed.

\*<sup>4</sup> Center speaker, surround speakers or height speakers need to be installed.



Using the Listening Modes

Input Format	Listening Mode
DTS	Direct
	DTS* <sup>1</sup> * <sup>2</sup>
	Dolby Surround
	Game-RPG* <sup>3</sup>
	Game-Action* <sup>3</sup>
	Game-Rock* <sup>3</sup>
	Game-Sports* <sup>3</sup>
	AllCh Stereo* <sup>4</sup>
	Full Mono* <sup>4</sup>
	T-D

\*<sup>1</sup> Cannot be selected when the input format is monaural or 2 ch.

\*<sup>2</sup> Center speaker or surround speakers need to be installed.

\*<sup>3</sup> Surround speakers or height speakers need to be installed.

\*<sup>4</sup> Center speaker, surround speakers or height speakers need to be installed.

Input Format	Listening Mode
DTS 96/24	Direct
	DTS 96/24* <sup>1</sup> * <sup>2</sup>
	Dolby Surround
	Game-RPG* <sup>3</sup>
	Game-Action* <sup>3</sup>
	Game-Rock* <sup>3</sup>
	Game-Sports* <sup>3</sup>
	AllCh Stereo* <sup>4</sup>
	Full Mono* <sup>4</sup>
	T-D

\*<sup>1</sup> Cannot be selected when the input format is monaural or 2 ch.

\*<sup>2</sup> Center speaker or surround speakers need to be installed.

\*<sup>3</sup> Surround speakers or height speakers need to be installed.

\*<sup>4</sup> Center speaker, surround speakers or height speakers need to be installed.

Input Format	Listening Mode
DTS Express	Direct
	DTS Express* <sup>1</sup> * <sup>2</sup>
	Dolby Surround
	Game-RPG* <sup>3</sup>
	Game-Action* <sup>3</sup>
	Game-Rock* <sup>3</sup>
	Game-Sports* <sup>3</sup>
	AllCh Stereo* <sup>4</sup>
	Full Mono* <sup>4</sup>
	T-D

\*<sup>1</sup> Cannot be selected when the input format is monaural or 2 ch.

\*<sup>2</sup> Center speaker or surround speakers need to be installed.

\*<sup>3</sup> Surround speakers or height speakers need to be installed.

\*<sup>4</sup> Center speaker, surround speakers or height speakers need to be installed.

Input Format	Listening Mode
DTS-HD HR	Direct
	DTS-HD HR* <sup>1</sup> * <sup>2</sup>
	Dolby Surround
	Game-RPG* <sup>3</sup>
	Game-Action* <sup>3</sup>
	Game-Rock* <sup>3</sup>
	Game-Sports* <sup>3</sup>
	AllCh Stereo* <sup>4</sup>
	Full Mono* <sup>4</sup>
	T-D

\*<sup>1</sup> Cannot be selected when the input format is monaural or 2 ch.

\*<sup>2</sup> Center speaker or surround speakers need to be installed.

\*<sup>3</sup> Surround speakers or height speakers need to be installed.

\*<sup>4</sup> Center speaker, surround speakers or height speakers need to be installed.

Input Format	Listening Mode
DTS-HD MSTR	Direct
	DTS-HD MSTR* <sup>1</sup> * <sup>2</sup>
	Dolby Surround
	Game-RPG* <sup>3</sup>
	Game-Action* <sup>3</sup>
	Game-Rock* <sup>3</sup>
	Game-Sports* <sup>3</sup>
	AllCh Stereo* <sup>4</sup>
	Full Mono* <sup>4</sup>
	T-D

\*<sup>1</sup> Cannot be selected when the input format is monaural or 2 ch.

\*<sup>2</sup> Center speaker or surround speakers need to be installed.

\*<sup>3</sup> Surround speakers or height speakers need to be installed.

\*<sup>4</sup> Center speaker, surround speakers or height speakers need to be installed.

Input Format	Listening Mode
DTS-ES	Direct
	DTS* <sup>1</sup>
	ES Matrix* <sup>2</sup>
	ES Discrete* <sup>2</sup>
	Dolby Surround* <sup>3</sup>
	Game-RPG* <sup>4</sup>
	Game-Action* <sup>4</sup>
	Game-Rock* <sup>4</sup>
	Game-Sports* <sup>4</sup>
	AllCh Stereo* <sup>5</sup>
Full Mono* <sup>5</sup>	
T-D	

\*<sup>1</sup> Can only be selected when the back speakers are not installed.

\*<sup>2</sup> Back speakers need to be installed.

\*<sup>3</sup> Height speakers need to be installed.

\*<sup>4</sup> Surround speakers or height speakers need to be installed.

\*<sup>5</sup> Center speaker, surround speakers or height speakers need to be installed.



■ **STEREO button**

You can select a listening mode for stereo and all channel stereo sources.

Input Format	Listening Mode
All format	Stereo
	AllCh Stereo*1

\*1 Center speaker, surround speakers or height speakers need to be installed.

**Checking the Input Format**

While audio from the player is being input, press DISPLAY on the remote controller several times to switch the information shown on the main unit display. For example, if "Dolby D 5.1" is displayed, the Dolby Digital 5.1 ch signals are being input.

- The number of channels is not displayed when the input signal format is "Dolby Atmos".

---

Dolby D      5.1

---



## Advanced Settings (Setup Menu)

### How to Set

The unit allows you to configure advanced settings in order to provide even better experience.

● **Operation:** You can set up by viewing the guidance displayed on the TV screen. Select the item with the cursor buttons of the remote controller and press ENTER to confirm your selection. To return to the previous screen, press RETURN.

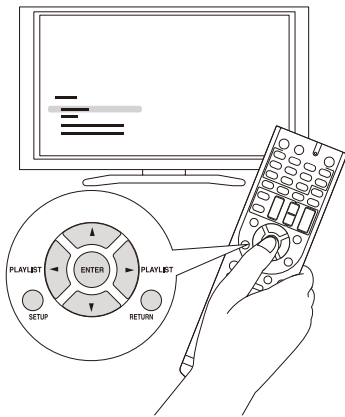

### ■ Operation

1. Press RECEIVER on the remote controller.
  - Always press RECEIVER first to change the remote controller to RECEIVER mode (the mode to operate this unit) since its mode may be changed to operate another component.

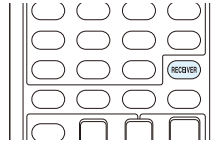

2. Press SETUP to display the Setup menu.

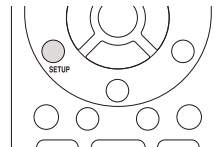

3. Press ▲/▼ to select the desired menu, and then press ENTER.

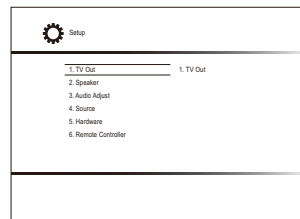

4. Press ▲/▼ to select the item, and then press ENTER.
5. With the ▲/▼/◀/▶ cursors, select the item to configure the settings.

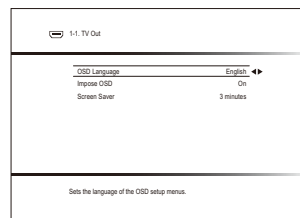

**To exit setup:** Press SETUP.

### Overview of the Setup menu

#### 1. TV Out

Make settings for the on-screen display function on the TV when you use the setting menu, for example.

#### 2. Speaker

Make advanced settings for the speakers.

#### 3. Audio Adjust

Make a variety of settings for sound.

#### 4. Source

Make settings for input sources, such as volume difference adjustments for each input selector for the connected equipment.

#### 5. Hardware

Make a variety of settings such as for linked operation with connected HDMI equipment and the standby mode for this unit.

#### 6. Remote Controller

Make settings related to the remote controller.



## 1. TV Out

### TV Out

Make settings for the on-screen display function on the TV when you use the setting menu, for example.

Setting Item	Default Value	Setting Details
OSD Language	English	Select the on-screen display language. Select from English, German, French, Spanish, Italian, Dutch, Swedish, Russian (European, Australian and Asian models), or Chinese (European, Australian, Taiwanese and Asian models).
Impose OSD	On	Set whether or not to display the information on the TV when the volume is adjusted or input is changed, for example. "On": OSD displayed on the TV. "Off": OSD not displayed on the TV. <ul style="list-style-type: none"> <li>OSD may not be displayed depending on the input signal even if "On" is selected. If the operation screen is not displayed, change the resolution of the connected device.</li> </ul>
Screen Saver	3 minutes	Set the time to start the screen saver. Select a value from "3 minutes", "5 minutes", "10 minutes" and "Off".

## 2. Speaker

Allows you to change the speaker configuration such as presence or not of subwoofer, crossover frequency, and so on. Settings are automatically configured if you use the Automatic Speaker Setup.  
This setting cannot be selected if headphones are connected or audio is output from the speakers of the TV.

### Configuration

Change speaker settings such as the number of channels connected, and the type of height speakers connected.

Setting Item	Default Value	Setting Details
Speaker Channels	7.1 ch	Select "2.1 ch", "3.1 ch", "4.1 ch", "5.1 ch", "6.1 ch", "7.1 ch", "2.1.2 ch", "3.1.2 ch", "4.1.2 ch", or "5.1.2 ch" to suit the number of speaker channels connected.
Subwoofer	Yes	Set whether a subwoofer is connected or not. "Yes": When subwoofer is connected "No": When subwoofer is not connected
Height Speaker	Front High	Set the speaker type if height speakers are connected to the BACK/HEIGHT terminals. Select "Front High", "Top Front", "Top Middle", "Top Rear", "Rear High", "Dolby Speaker (Front)", or "Dolby Speaker (Surr)" according to the type and layout of the connected speakers. <ul style="list-style-type: none"> <li>If an item cannot be selected even though connection is correct, check that the settings in "Speaker Channels" matches the number of connected channels.</li> </ul>



Advanced Settings (Setup Menu)

**Crossover**

Change speaker settings such as the crossover frequency of the speakers. Settings are automatically configured if you use the Automatic Speaker Setup. Audio will not be output while you are making this setting.

Setting Item	Default Value	Setting Details
Front	Small	Set the size for each of the speakers. Use the diameter of the cone as a guide. "Small": When the cone diameter is less than 6-1/2 inches (16 cm) "Large": When the cone diameter is greater than 6-1/2 inches (16 cm) <ul style="list-style-type: none"> <li>The setting is fixed to "Large" if "Configuration" - "Subwoofer" is set to "No".</li> </ul>
Center	Small	Set the size for each of the speakers. Use the diameter of the cone as a guide. "Small": When the cone diameter is less than 6-1/2 inches (16 cm) "Large": When the cone diameter is greater than 6-1/2 inches (16 cm) <ul style="list-style-type: none"> <li>"Large" can be selected only when "Front" is set to "Large".</li> <li>If an item cannot be selected even though connection is correct, check that the settings in "Configuration" - "Speaker Channels" matches the number of connected channels.</li> </ul>
Height	Small	Set the size for each of the speakers. Use the diameter of the cone as a guide. "Small": When the cone diameter is less than 6-1/2 inches (16 cm) "Large": When the cone diameter is greater than 6-1/2 inches (16 cm) <ul style="list-style-type: none"> <li>"Large" can be selected only when "Front" is set to "Large".</li> <li>If an item cannot be selected even though connection is correct, check that the settings in "Configuration" - "Speaker Channels" matches the number of connected channels.</li> </ul>

Setting Item	Default Value	Setting Details
Surround	Small	Set the size for each of the speakers. Use the diameter of the cone as a guide. "Small": When the cone diameter is less than 6-1/2 inches (16 cm) "Large": When the cone diameter is greater than 6-1/2 inches (16 cm) <ul style="list-style-type: none"> <li>"Large" can be selected only when "Front" is set to "Large".</li> <li>If an item cannot be selected even though connection is correct, check that the settings in "Configuration" - "Speaker Channels" matches the number of connected channels.</li> </ul>
Back	Small	Set the size for each of the speakers. Use the diameter of the cone as a guide. "Small": When the cone diameter is less than 6-1/2 inches (16 cm) "Large": When the cone diameter is greater than 6-1/2 inches (16 cm) <ul style="list-style-type: none"> <li>"Large" can be selected only when "Surround" is set to "Large".</li> <li>If an item cannot be selected even though connection is correct, check that the settings in "Configuration" - "Speaker Channels" matches the number of connected channels.</li> </ul>
Crossover	100Hz	Set the lowest frequency that each the speakers can output so that frequencies lower than this are output from the subwoofer. Set using the diameter of the speaker with the smallest cone as a guide. "40Hz", "50Hz", "60Hz": For cone diameters greater than 8 inches (20 cm) "70Hz", "80Hz", "90Hz": For cone diameters between 6-1/2 inches to 8 inches (16 to 20 cm) "100Hz": For cone diameters 5-1/4 to 6-1/2 inches (13 to 16 cm) "120Hz": For cone diameters 3-1/2 to 5-1/4 inches (9 to 13 cm) "150Hz", "180Hz", "200Hz": For cone diameters less than 3-1/2 inches (9 cm)



## Advanced Settings (Setup Menu)

Setting Item	Default Value	Setting Details
Double Bass	On	This can be selected only when "Configuration" - "Subwoofer" is set to "Yes" and "Front" is set to "Large". Boost bass output by feeding bass sounds from the front left and right, and center speakers to the subwoofer. "On": Bass output will be boosted. "Off": Bass output will not be boosted. <ul style="list-style-type: none"> <li>The setting will not automatically be configured even if you performed the automatic speaker setup.</li> </ul>

**Distance**

Set the distance from each speaker to the listening position. Settings are automatically configured if you use the automatic speaker setup.

Setting Item	Default Value	Setting Details
Unit	feet/meters	Specify the unit of distance for configuring settings. "feet": When setting in feet (0.1ft to 30.0ft, in increments of 0.1ft) "meters": When setting in meters (0.03m to 9.00m, in increments of 0.03m)
Front Left	12.0ft/3.60m	Specify the distance between each speaker and the listening position.
Center	12.0ft/3.60m	Specify the distance between each speaker and the listening position.
Front Right	12.0ft/3.60m	Specify the distance between each speaker and the listening position.
Height Left	9.0ft/2.70m	Specify the distance between each speaker and the listening position. <ul style="list-style-type: none"> <li>The setting cannot be changed during ZONE B playback.</li> </ul>
Height Right	9.0ft/2.70m	Specify the distance between each speaker and the listening position. <ul style="list-style-type: none"> <li>The setting cannot be changed during ZONE B playback.</li> </ul>
Surround Right	7.0ft/2.10m	Specify the distance between each speaker and the listening position.

Setting Item	Default Value	Setting Details
Back Right	7.0ft/2.10m	Specify the distance between each speaker and the listening position. <ul style="list-style-type: none"> <li>The setting cannot be changed during ZONE B playback.</li> </ul>
Back Left	7.0ft/2.10m	Specify the distance between each speaker and the listening position. <ul style="list-style-type: none"> <li>The setting cannot be changed during ZONE B playback.</li> </ul>
Surround Left	7.0ft/2.10m	Specify the distance between each speaker and the listening position.
Subwoofer	12.0ft/3.60m	Specify the distance between each speaker and the listening position.

- Default values vary depending on the regions.
- The speaker "Distance" may be unable to be changed depending on the settings in "Configuration" - "Speaker Channels" / "Subwoofer".

**Level Calibration**

Adjust the level of each speaker with the built-in test tone. Settings are automatically configured if you use the Automatic Speaker Setup.

Setting Item	Default Value	Setting Details
Front Left	0dB	Select a value between "-12dB" and "+12dB". A test tone will be output each time you change the value. Select the desired level.
Center	0dB	Select a value between "-12dB" and "+12dB". A test tone will be output each time you change the value. Select the desired level.
Front Right	0dB	Select a value between "-12dB" and "+12dB". A test tone will be output each time you change the value. Select the desired level.
Height Left	0dB	Select a value between "-12dB" and "+12dB". A test tone will be output each time you change the value. Select the desired level. <ul style="list-style-type: none"> <li>The setting cannot be changed during ZONE B playback.</li> </ul>
Height Right	0dB	Select a value between "-12dB" and "+12dB". A test tone will be output each time you change the value. Select the desired level. <ul style="list-style-type: none"> <li>The setting cannot be changed during ZONE B playback.</li> </ul>



Setting Item	Default Value	Setting Details
Surround Right	0dB	Select a value between "-12dB" and "+12dB". A test tone will be output each time you change the value. Select the desired level.
Back Right	0dB	Select a value between "-12dB" and "+12dB". A test tone will be output each time you change the value. Select the desired level. <ul style="list-style-type: none"> <li>The setting cannot be changed during ZONE B playback.</li> </ul>
Back Left	0dB	Select a value between "-12dB" and "+12dB". A test tone will be output each time you change the value. Select the desired level. <ul style="list-style-type: none"> <li>The setting cannot be changed during ZONE B playback.</li> </ul>
Surround Left	0dB	Select a value between "-12dB" and "+12dB". A test tone will be output each time you change the value. Select the desired level.
Subwoofer	0dB	Select a value between "-15dB" and "+12dB". A test tone will be output each time you change the value. Select the desired level.

- The speaker "Level Calibration" may be unable to be changed depending on the settings in "Configuration" - "Speaker Channels" / "Subwoofer".
- In the following cases, the settings for "Level Calibration" cannot be changed:
  - While MUTING is on
  - While audio is not being output from ZONE A

### 3. Audio Adjust

Configure various settings related to sound, such as settings for listening to multiplex audio or multilingual TV broadcasts and sound field settings for listening modes.

#### Multiplex/Mono

Setting Item	Default Value	Setting Details
Multiplex Input Channel	Main	Set the audio channel or language to be output when playing multiplex audio or multilingual TV broadcasts etc. "Main": Main channel only "Sub": Sub channel only "Main / Sub": Main and sub channels will be output at the same time. <ul style="list-style-type: none"> <li>If multiplex audio is being played, "1+1" will be displayed when DISPLAY is pressed.</li> </ul>
Mono Input Channel	Left + Right	Set the input channel to use for playing any 2 ch digital source such as Dolby Digital, or 2-ch analog/PCM source in the Mono listening mode. "Left": Left channel only "Right": Right channel only "Left + Right" : Left and right channels

#### Dolby

Make the settings for Dolby listening mode.

Setting Item	Default Value	Setting Details
Loudness Management	On	Enable the Late Night function that allows you to enjoy surround sound of Dolby TrueHD playback even in low volume. "On": Use this function "Off": Do not use this function





**DTS**

Make the settings for DTS Neo:6 Music listening mode.

Setting Item	Default Value	Setting Details
Neo:6 Music Center Image	2	Adjust the width of the sound field of the front channel when playing in the DTS Neo:6 Music listening mode. "0" to "5": Selecting a smaller value brings the sound field of the front channel to the center while selecting a larger value spreads the sound field of the front channel to left and right.

**Theater-Dimensional**

Make the settings for Theater-Dimensional listening mode.

Setting Item	Default Value	Setting Details
Listening Angle	Wide	To enhance the effect of Theater-Dimensional, select the actual angle of the left and right front speakers as it appears from the listening position. "Narrow": Less than 30° "Wide": Greater than 30°

- Position the front speakers 20° to the listening position if you have selected "Narrow" in "Listening Angle" and 40° if you have selected "Wide".

**4. Source**

Make settings for input sources, such as volume difference adjustments for each input selector for the connected equipment. When you select a desired input to check the audio, start playback of the connected device.

**IntelliVolume**

Setting Item	Default Value	Setting Details
IntelliVolume	0dB	Adjust the volume level difference between the devices connected to the unit. Select a value between "-12dB" and "+12dB". Set a negative value if the volume of the target device is larger than the others and a positive value if smaller.

**Name Edit**

Set an easy name to each input. The set name will be shown on the main unit display. Select the input selector to configure.

Setting Item	Default Value	Setting Details
Name	---	Select a name registered in the unit and replace the currently selected input selector name with it. <ul style="list-style-type: none"> <li>• The same name cannot be used for more than one input selector.</li> </ul>

- This cannot be set if the "TUNER" or "BLUETOOTH" input is selected.



## Audio Select

Make the audio input setting. The setting can be separately set to each input selector button. Select the input selector to configure.

Setting Item	Default Value	Setting Details
Audio Select	-	<p>Select the priority for input selection when multiple audio sources are connected to one input selector, such as connections to both the BD/DVD HDMI jack and AUDIO jack. You cannot select a jack that is not associated with the currently selected input.</p> <ul style="list-style-type: none"> <li>The priority is HDMI → DIGITAL AUDIO/ OPTICAL → Analog if this setting is not changed.</li> </ul> <p>"ARC": When giving priority to input signal from ARC compatible TV.</p> <ul style="list-style-type: none"> <li>The setting can be selected only when "HDMI" - "Audio Return Channel" is set to "Auto" and also the "TV" input is selected.</li> </ul> <p>"HDMI": When giving priority to input signal from HDMI jacks.</p> <p>"DIGITAL AUDIO": When giving priority to input signal from DIGITAL AUDIO (COAXIAL) jack.</p> <p>"OPTICAL": When giving priority to input signal from OPTICAL jacks.</p> <p>"Analog": When giving priority to input signal from AUDIO jacks.</p> <ul style="list-style-type: none"> <li>The setting cannot be changed when "GAME 1" or "STRM BOX" input is selected.</li> </ul>
PCM Fixed Mode	Off	<p>Select whether to fix input signals to PCM (except multi-channel PCM) when you have selected "HDMI", "DIGITAL AUDIO", or "OPTICAL" in the "Audio Select" setting. Set this item to "On" if noise is produced or truncation occurs at the beginning of a track when playing PCM sources. Select "Off" normally.</p> <ul style="list-style-type: none"> <li>Changing "Audio Select" changes the setting to "Off".</li> </ul>

- The setting cannot be changed when "GAME 2", "VCR", "AUX", "TUNER", or "BLUETOOTH" input is selected.

## Video Select

Setting Item	Default Value	Setting Details
Video Select	Last	<p>Select the video input played along with audio output when either "TUNER" or "BLUETOOTH" is selected.</p> <p>"Last": Select the video input played immediately prior.</p> <p>"BD/DVD", "CBL/SAT", "GAME 1", "GAME 2", "STRM BOX", "VCR", "AUX": Play the video from the selected input.</p>

- The setting cannot be changed when input other than "TUNER" or "BLUETOOTH" is selected.
- Switch between displaying and not displaying video by pressing MODE on the remote controller during Bluetooth playback.

## 5. Hardware

### Tuner

Setting Item	Default Value	Setting Details
AM / FM Frequency Step (North American and Taiwanese models)	10 kHz / 0.2 MHz	<p>Select a frequency step depending on your area of residence.</p> <p>Select "10 kHz / 0.2 MHz" or "9 kHz / 0.05 MHz".</p> <ul style="list-style-type: none"> <li>When this setting is changed, all radio presets are deleted.</li> </ul>
AM Frequency Step (European, Australian and Asian models)	9 kHz	<p>Select a frequency step depending on your area of residence.</p> <p>Select "10 kHz" or "9 kHz".</p> <ul style="list-style-type: none"> <li>When this setting is changed, all radio presets are deleted.</li> </ul>



Advanced Settings (Setup Menu)

HDMI

Setting Item	Default Value	Setting Details
HDMI CEC (RIHD)	Off	<p>Setting to "On" enables the input selection link and other link functions with HDMI connected CEC compliant device.</p> <p>"On": Use this function                      "Off": Do not use this function</p> <p>When changing this setting, turn off and then on again the power of all connected components.</p> <ul style="list-style-type: none"> <li>Depending on the TV set, a link may need to be configured on the TV.</li> <li>Setting to "On" and closing the on-screen menu displays the name of the CEC-compatible components and "CEC On" on the display.</li> <li>Power consumption in standby mode may increase if "On" is set. (Depending on the TV status, the unit will enter the normal standby mode.)</li> <li>If you operate the MASTER VOLUME control on the main unit when this setting is "On" and audio is output from the TV speakers, audio will be output also from the speakers connected to the unit. If you want to output from only either of them, change the unit or TV settings, or reduce the volume of the unit.</li> <li>If abnormal operation occurs when you set the setting to "On", set it to "Off".</li> <li>When connecting a non-CEC compatible component, or when you are not sure whether it is compatible, set the setting to "Off".</li> </ul>

Setting Item	Default Value	Setting Details
HDMI Standby Through	Off	<p>When this is set to anything other than "Off", you can play the video and audio of an HDMI connected player on the TV even if the unit is in standby mode. Only "Auto" and "Auto(Eco)" can be selected if "HDMI CEC (RIHD)" is set to "On". If you select anything else, set "HDMI CEC (RIHD)" to "Off."</p> <ul style="list-style-type: none"> <li>Power consumption in standby mode increases if set to anything other than "Off".</li> </ul> <p>"BD/DVD", "CBL/SAT", "GAME 1", "STRM BOX": For example, if you select "BD/DVD", you can play the equipment connected to the "BD/DVD" terminal on the TV even if the unit is in standby mode. Select this setting if you have decided which player to use with this function.</p> <p>"Last": You can play the video and audio of the input selected immediately prior to the unit being switched to standby on the TV. When "Last" is selected, you can switch the input of the unit even in the standby mode with the remote controller.</p> <p>"Auto", "Auto (Eco)": Select one of these settings when you have connected equipment that conforms to the CEC standard. You can play the video and audio of the input selected on the TV, irrespective of what input was selected immediately prior to the unit being switched to standby, using the CEC link function.</p> <ul style="list-style-type: none"> <li>To play players on the TV that do not conform to the CEC standard, you will need to turn the unit on and switch to the relevant input.</li> <li>When using a TV that conforms to the CEC standard, you can reduce the power consumption in standby mode by selecting "Auto (Eco)".</li> </ul>



## Advanced Settings (Setup Menu)

Setting Item	Default Value	Setting Details
Audio TV Out	Off	<p>You can enjoy audio through the speakers of the HDMI connected TV while this unit is on.</p> <p>"On": Use this function</p> <p>"Off": Do not use this function</p> <ul style="list-style-type: none"> <li>• If you select "On", set "HDMI CEC (RIHD)" to "Off."</li> <li>• The setting is fixed to "Auto" if "HDMI CEC (RIHD)" is set to "On".</li> <li>• Listening mode cannot be changed while "Audio TV Out" is set to "On" and audio is being output through the speakers of the TV.</li> <li>• Depending on your TV set or input signal of the component, audio may not output through the speakers of the TV even if this setting is set to "On". In such case, audio is output from the speakers of the unit.</li> <li>• If you operate the MASTER VOLUME control on the main unit when "Audio TV Out" or "HDMI CEC (RIHD)" is "On" and audio is output from the TV speakers, audio will be output from the unit. If you do not want to output audio from the unit, change the unit or TV settings, or reduce the volume of the unit.</li> </ul>
Audio Return Channel	Auto	<p>You can enjoy sound of the HDMI connected ARC compatible TV through the speakers connected to the unit. To use this function, set "HDMI CEC (RIHD)" to "On" in advance.</p> <p>"Auto": When enjoying the TV sound through the speakers connected to the unit</p> <p>"Off": When not using the ARC function</p>
Auto LipSync	On	<p>This setting automatically corrects any desynchronization between the video and audio signals based on data from the HDMI LipSync compatible TV.</p> <p>"On": Automatic correction will be enabled.</p> <p>"Off": Automatic correction will be disabled.</p>

## Power Management

Setting Item	Default Value	Setting Details
Sleep Timer	Off	<p>Allows the unit to enter standby automatically when the specified time elapses. Select a value between "10 min" to "90 min".</p> <p>"Off": Does not turn the unit to standby automatically.</p>
Auto Standby	On/Off	<p>This setting places the unit on standby automatically after 20 minutes of inactivity without any video or audio input.</p> <p>"On": The unit will automatically enter standby mode ("ASb" will light).</p> <p>"Off": The unit will not automatically enter standby mode.</p> <ul style="list-style-type: none"> <li>• "Auto Standby" is appeared on the display and TV screen 30 seconds before the Auto Standby comes on.</li> <li>• Default values vary depending on the regions.</li> </ul>
Auto Standby in HDMI Standby Through	Off	<p>Enable or disable "Auto Standby" while "HDMI Standby Through" is on.</p> <p>"On": The setting will be enabled.</p> <p>"Off": The setting will be disabled.</p> <ul style="list-style-type: none"> <li>• This setting cannot be set to "On" if "Auto Standby" is set to "Off".</li> </ul>
Power Out at Standby for STRM BOX	Off	<p>Devices connected to the USB port are supplied with electricity even when this unit is in standby mode when this function is "On".</p> <ul style="list-style-type: none"> <li>• Power consumption in standby mode may increase when this function is being used.</li> </ul>

## Bluetooth

Setting Item	Default Value	Setting Details
Bluetooth	On	<p>Select whether or not to use the Bluetooth function.</p> <p>"On": Enables connection with a Bluetooth-enabled device by using the Bluetooth function. Select "On" also when making various Bluetooth settings.</p> <p>"Off": When not using the Bluetooth function</p>



Setting Item	Default Value	Setting Details
Auto Input Change	On	The input of the unit will automatically be switched to "BLUETOOTH" when connection is made from a Bluetooth-enabled device to the unit. "On": The input will automatically become "BLUETOOTH" when a Bluetooth-enabled device is connected. "Off": The function is disabled. <ul style="list-style-type: none"> <li>If the input is not switched automatically, set to "Off" and change the input manually.</li> </ul>
Auto Reconnect	On	This function automatically reconnects to the Bluetooth-enabled device connected last when you change the input to "BLUETOOTH". "On": Use this function "Off": Do not use this function <ul style="list-style-type: none"> <li>This may not work with some Bluetooth-enabled devices.</li> </ul>
Pairing Information	-	The information of the previous pairing stored in this unit will be initialized. Pressing ENTER when "Clear" is displayed initializes the pairing information stored in this unit. <ul style="list-style-type: none"> <li>This function does not initialize the pairing information on the Bluetooth-enabled device. When pairing the unit again with the device, be sure to clear the pairing information on the Bluetooth-enabled device in advance. For information on how to clear the pairing information, refer to the Bluetooth-enabled device's instruction manual.</li> </ul>
Device	-	Displays the name of the Bluetooth-enabled device connected to the unit. <ul style="list-style-type: none"> <li>The name is not displayed when "Status" is "Ready" or "Pairing".</li> </ul>
Status	-	Displays the status of the Bluetooth-enabled device connected to the unit. "Ready": Not paired "Pairing": Pairing "Connected": Successfully connected

## 6. Remote Controller

### Remote ID

Setting Item	Default Value	Setting Details
Remote ID	1	Select an ID for the unit's remote controller from "1", "2", and "3" to prevent interference between the unit and other Onkyo components that are installed in the same room. After changing the ID on the main unit, change the ID on the remote controller accordingly with the following procedure. <ol style="list-style-type: none"> <li>While holding down RECEIVER, press and hold SETUP for about 3 seconds until the remote indicator lights.</li> <li>With the number buttons, press one of 1, 2, and 3. The remote indicator flashes twice.</li> </ol>



## Operating Other Components with the Remote Controller

### Functions of REMOTE MODE Buttons

You can control any other device than this unit by programming a specified remote control code to a REMOTE MODE button of the remote controller. Register a remote control code to a desired REMOTE MODE button and press it to enter the remote mode that allows you to operate the corresponding device.

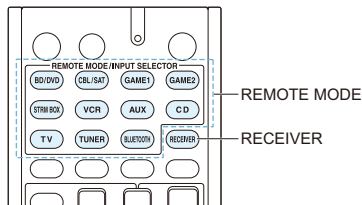

### Programming Remote Control Codes

#### ■ Consulting the Remote Control Code List

- Look up the [Remote Control Codes](#) for the corresponding remote control code.
  - The codes in the Remote Control Code List are those known as of the date of publication and may be changed.
  - The following REMOTE MODE buttons are preprogrammed with remote control codes.
    - BD/DVD: Onkyo Blu-ray Disc/DVD player
    - CD: Onkyo CD player
    - STRM BOX: Apple TV
  - Only TV remote control codes can be entered for TV.
  - Program a remote control code in accordance with the input since each button also works as the input selector. (For example, when the CD player is connected to the CD jack, program the remote control code for the CD player to CD)
- Press and hold DISPLAY for 3 or more seconds while holding down the REMOTE MODE button to which you want to program the remote control code.

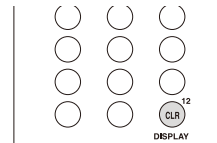

- The remote indicator lights in the input mode.

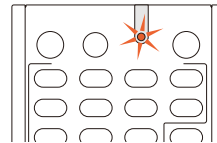

- With the number buttons, enter the 5-digit remote control code within 30 seconds.
  - Programming is complete when the remote indicator flashes twice. The remote indicator flashes once slowly when programming the remote control code fails. Try programming again.

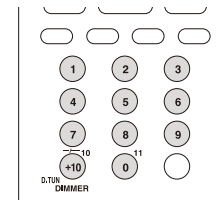

#### ■ Remapping the Colored Buttons

The colored button assignment on the AV receiver's remote controller can be remapped to match that on the remote controller of the component whose remote control code you programmed to REMOTE MODE.

- Hold down the REMOTE MODE button to map and A (Red) simultaneously until the remote indicator lights (about 3 seconds).
  - Remapping is possible only for codes included in the categories of the Remote Control Code List (such as DVD player and TV)
- Within 30 seconds, press the colored buttons from left to right, in the order you want to remap.
  - For example, if the colored buttons on the remote controller of the other component are yellow, green, blue, and red from left to right, press the buttons on the AV receiver's remote controller in that order.
  - Programming is complete when the remote indicator flashes twice. The remote indicator flashes once slowly when programming the remote control code fails. Try programming again.
  - Pressing any other button than a colored button cancels the remap operation.

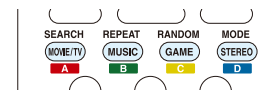
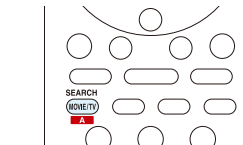

Operating Other Components with the Remote Controller

■ **Resetting the REMOTE MODE Buttons**

You can reset the remote control code registered in the REMOTE MODE button to its default status. This operation can be executed on a single REMOTE MODE button.

1. Press and hold Q for 3 or more seconds while holding down the REMOTE MODE button you want to reset.
  - The remote indicator will light.

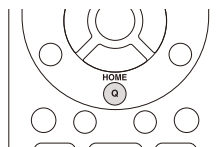

2. Within 30 seconds, press the REMOTE MODE button again.
  - Resetting is complete when the remote indicator flashes twice.

**To reset all the remote controller settings:** While holding down RECEIVER, press and hold Q for 3 or more seconds until the remote indicator stays lit. Within 30 seconds, press RECEIVER again. Resetting is complete when the remote indicator flashes twice.

**TV operation**

Press the REMOTE MODE button programmed with the remote control code for the relevant AV component to switch the remote controller mode to that for the AV component. Then, operate by using the corresponding buttons. Available buttons vary depending on the product category of the component. Operation may be incorrect or impossible depending on the product.

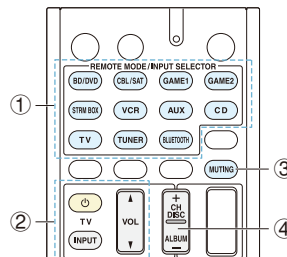

- ① REMOTE MODE
- ② ⏻, INPUT, VOL ▲/▼
- ③ MUTING
- ④ CH +/-

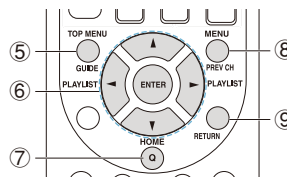

- ⑤ GUIDE
- ⑥ ▲/▼/◀/▶, ENTER
- ⑦ HOME
- ⑧ PREV CH
- ⑨ RETURN

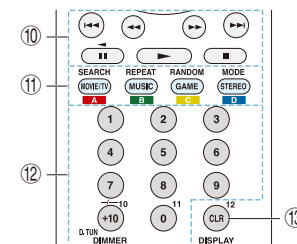

- ⑩ ▶, ||, ■, ◀, ▶, ◀▶, ▶▶ (\*),
- ⑪ A (Red), B (Green), C (Yellow), D (Blue)
- ⑫ Number 1 to 9, 0, +10
- ⑬ CLR, DISPLAY

\* Not CEC compatible.



### Blu-ray Disc player/DVD player/DVD recorder operation

Press the REMOTE MODE button programmed with the remote control code for the relevant AV component to switch the remote controller mode to that for the AV component. Then, operate by using the corresponding buttons. Available buttons vary depending on the product category of the component. Operation may be incorrect or impossible depending on the product.

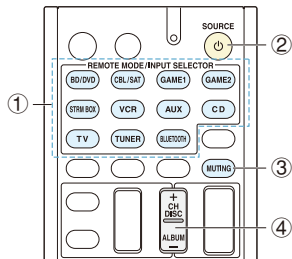

- ① REMOTE MODE
- ② SOURCE
- ③ MUTING
- ④ CH +/-, DISC +/-

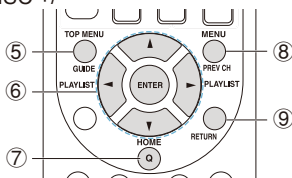

- ⑤ TOP MENU
- ⑥ ▲/▼/◀/▶, ENTER
- ⑦ HOME
- ⑧ MENU
- ⑨ RETURN

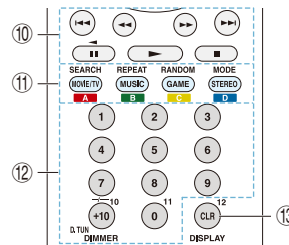

- ⑩ ►, ■, ■, ◀, ►, ◀, ►►
- ⑪ A (Red), B (Green), C (Yellow), D (Blue)
- ⑫ Number 1 to 9, 0, +10 (\*)
- ⑬ CLR, DISPLAY

\* Not CEC compatible.

### Operating Other Components with the Remote Controller

#### VCR/PVR operation

Press the REMOTE MODE button programmed with the remote control code for the relevant AV component to switch the remote controller mode to that for the AV component. Then, operate by using the corresponding buttons. Available buttons vary depending on the product category of the component. Operation may be incorrect or impossible depending on the product.

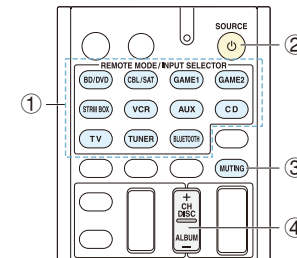

- ① REMOTE MODE
- ② SOURCE
- ③ MUTING
- ④ CH +/-

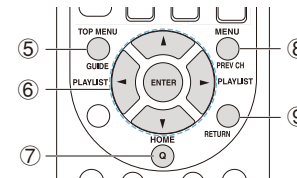

- ⑤ GUIDE
- ⑥ ▲/▼/◀/▶, ENTER
- ⑦ HOME
- ⑧ PREV CH
- ⑨ RETURN





Operating Other Components with the Remote Controller

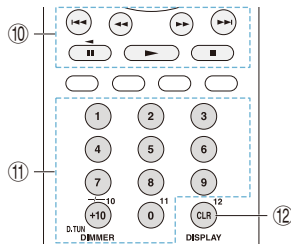

- ⑩ ►, ||, ■, ◀, ▶, ◀◀, ▶▶, ◀◀◀, ▶▶▶
- ⑪ Number 1 to 9, 0, +10
- ⑫ CLR, DISPLAY

**Satellite receiver / Cable receiver operation**

Press the REMOTE MODE button programmed with the remote control code for the relevant AV component to switch the remote controller mode to that for the AV component. Then, operate by using the corresponding buttons. Available buttons vary depending on the product category of the component. Operation may be incorrect or impossible depending on the product.

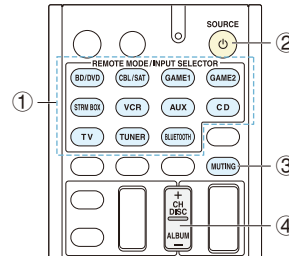

- ① REMOTE MODE
- ② SOURCE
- ③ MUTING
- ④ CH +/-

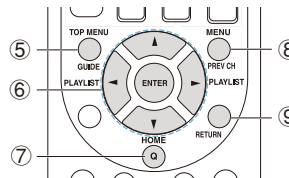

- ⑤ GUIDE
- ⑥ ▲/▼/◀/▶, ENTER
- ⑦ HOME
- ⑧ PREV CH
- ⑨ RETURN

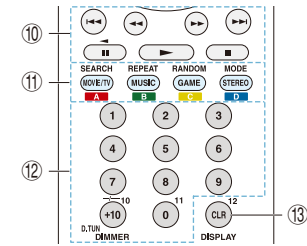

- ⑩ ►, ||, ■, ◀, ▶, ◀◀, ▶▶, ◀◀◀, ▶▶▶
- ⑪ A (Red), B (Green), C (Yellow), D (Blue)
- ⑫ Number 1 to 9, 0, +10
- ⑬ CLR, DISPLAY



Operating Other Components with the Remote Controller

**CD player operation**

Press the REMOTE MODE button programmed with the remote control code for the relevant AV component to switch the remote controller mode to that for the AV component. Then, operate by using the corresponding buttons. Available buttons vary depending on the product category of the component. Operation may be incorrect or impossible depending on the product.

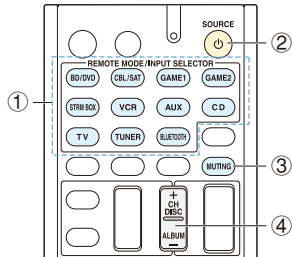

- ① REMOTE MODE
- ② SOURCE
- ③ MUTING
- ④ DISC +/-

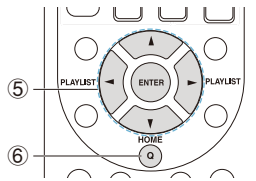

- ⑤ ▲/▼/◀/▶, ENTER
- ⑥ HOME

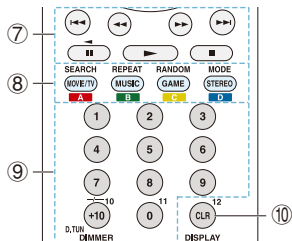

- ⑦ ▶, II, ■, ◀▶, I◀◀, ▶▶
- ⑧ SEARCH, REPEAT, RANDOM, MODE
- ⑨ Number 1 to 9, 0, +10
- ⑩ CLR, DISPLAY

**Cassette tape deck operation**

Press the REMOTE MODE button programmed with the remote control code for the relevant AV component to switch the remote controller mode to that for the AV component. Then, operate by using the corresponding buttons. Available buttons vary depending on the product category of the component. Operation may be incorrect or impossible depending on the product.

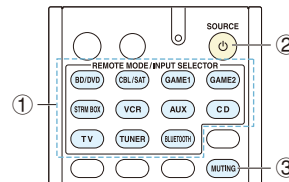

- ① REMOTE MODE
- ② SOURCE
- ③ MUTING

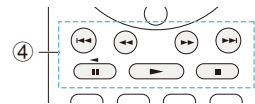

- ④ ▶, ◀ (Reverse Playback), ■, ◀◀, ▶▶, I◀◀, ▶▶

**To operate CEC-compatible components**

If this unit is connected via HDMI to a TV or BD/DVD player, you may be able to control the devices using the remote controller of this unit with CEC (Consumer Electronics Control) linked operation.

**TV:** The TV button on the remote controller is preprogrammed with remote control codes for linked operation of some CEC-compatible TV sets.

- If you cannot operate your CEC-compatible TV, program one of the following remote control codes (11807/13100/13500) to the TV button.

**BD/DVD player:** By registering a remote control code (32910/33101/33501/31612) in the BD/DVD button, your remote controller will be able to take advantage of linked operation with CEC-compatible BD/DVD players.



## Connecting and Operating Onkyo RI Components

### About RI Function

Connecting an Onkyo component with RI jack such as the separately sold RI Dock to the unit by using an RI cable and an analog audio cable enables the following RI functions:

**System On / Auto Power On:** Starting playback on a component connected via RI when the unit is on standby mode, automatically turns on the unit to select the relevant component as its input source.

**Direct Change:** When playback is started on a component connected via RI, the unit selects that component as the input source.

**Remote Controller Operation:** Allows you to operate RI-compatible Onkyo components using the AV receiver's remote controller. Point the remote controller at remote control sensor of the unit. This operation is possible only when the RI remote control code is programmed.

- Some components may not support all RI functions.
- For information on the RI functions, also refer to each component's instruction manual.

### RI Connection and Setting

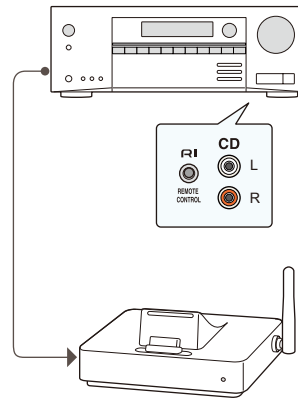

Connect an Onkyo component with RI jack to this unit using an RI cable and an analog audio cable. For details, refer to the instruction manual of the component with RI jack. The RI cable can be connected in any order. When there are two RI jacks, both jacks work in the same way and are interchangeable.

The following settings are necessary to connect the RI Dock or cassette tape deck via RI.

#### ■ To rename the input selector

To make the RI functions work, you must rename the input selectors on the unit. After pressing RECEIVER to switch to RECEIVER mode, press SETUP on the remote controller. Use the cursors in the Setup menu to select "4. Source" - "Name Edit" - "Name" and rename the input selector to "DOCK" or "TAPE".

#### ■ To program the RI remote control code

Program the remote control code to any REMOTE MODE button on the remote controller. This will allow you to operate the component by pointing the remote controller at the unit instead of the component.

1. Press and hold DISPLAY for 3 or more seconds while holding down the REMOTE MODE button to which you want to program the remote control code.
  - The remote indicator will light.

### Connecting and Operating Onkyo RI Components

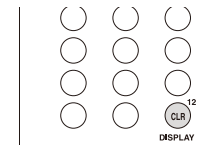

2. With the number buttons, enter the following 5-digit remote control code within 30 seconds.

RI Dock: 81993

Cassette tape deck with RI jack: 42157

- Programming is complete when the remote indicator flashes twice. The remote indicator flashes once slowly when programming the remote control code fails. Try programming again.

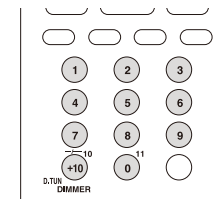

**Input selector on the RI Dock:** Select "DOCK" or "TAPE". For details, refer to the RI Dock's instruction manual.

To operate Onkyo components directly or Onkyo components that are not connected via RI, use the following remote control codes:

Onkyo DVD player: 30627

Onkyo CD player: 71817

RI Dock: 82990

- With some models, operation may be not possible in part or not possible at all.



### iPod®/iPhone® Operation

The RI Dock allows you to use the AV receiver's remote controller to operate and play music on your iPod/iPhone. Moreover, it also allows you to view videos on your iPod/iPhone on the screen of your TV, as well as perform RI operations if connected via RI. This operation is possible only when the RI remote control code is programmed.

**Before performing any operation:** Update the OS on your iPod/iPhone to the latest version. Certain buttons may not work for some iPod/iPhone models and generations, or RI Dock. For details on the operation, refer to the RI Dock's instruction manual.

Switch the remote controller mode by pressing the REMOTE MODE button programmed with the remote control code for the iPod/iPhone, and operate by using the corresponding buttons. Point the remote controller at the unit.

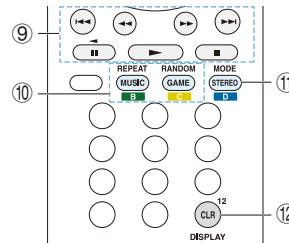

- ⑨ ◀, ▶, ■, ■, ▶▶, ▶▶▶, ▶▶▶▶
- ⑩ REPEAT, RANDOM
- ⑪ MODE
- ⑫ DISPLAY

- Pressing DISPLAY turns on the backlight for a few seconds.
- MODE allows you to use the Resume function.

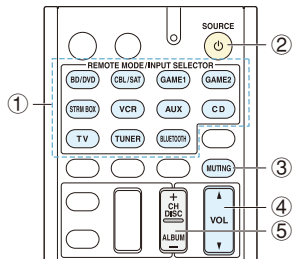

- ① REMOTE MODE
- ② SOURCE
- ③ MUTING
- ④ VOL ▲/▼
- ⑤ ALBUM +/-

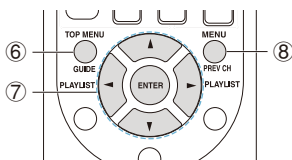

- ⑥ TOP MENU
- ⑦ ▲/▼/◀/▶, ENTER, PLAYLIST ◀/▶
- ⑧ MENU



## Troubleshooting

### Before starting the procedure

Problems may be solved by simply turning the power on/off or disconnecting/connecting the power cord, which is easier than working on the connection, setting and operating procedure. Try the simple measures on both the unit and the connected device. If the problem is that the video or audio is not output or the HDMI linked operation does not work, disconnecting/connecting the HDMI cable may solve it. When reconnecting, be careful not to wind the HDMI cable since if wound the HDMI cable may not fit well. After reconnecting, turn off and on the unit and the connected device.

- The AV receiver contains a microPC for signal processing and control functions. In very rare situations, severe interference, noise from an external source, or static electricity may cause it to lockup. In the unlikely event that this happens, unplug the power cord from the wall outlet, wait at least 5 seconds, and then plug it back in.
- Onkyo is not responsible for damages (such as CD rental fees) due to unsuccessful recordings caused by the unit's malfunction. Before you record important data, make sure that the material will be recorded correctly.

### Resetting the unit

Resetting the unit to the status at the time of shipment may solve the problem. If the measures mentioned in the troubleshooting do not solve the problem, reset the unit with the following procedure. If you reset the unit status, your preferences will be reset to the defaults. Note them down before starting reset.

#### ■ How to reset

1. While holding down CBL/SAT on the main unit (note that step 2 must be performed with this button pressed down)
2. Press  $\phi$ ON/STANDBY on the main unit. "Clear" is appeared on the display and the unit will enter standby mode.

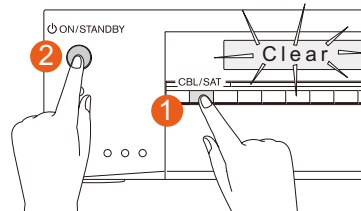

#### ■ How to reset the remote controller

1. While holding down ① RECEIVER on the remote controller (note that step 2 must be performed with this button pressed down)
2. Press and hold ② Q for 3 or more seconds until the ③ remote indicator stays lit. Within 30 seconds, press ① RECEIVER again to reset.

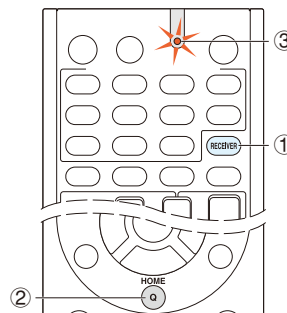

### Power

#### ■ Cannot turn on the unit

- Make sure that the power cord is properly plugged into the wall outlet.
- Unplug the power cord from the wall outlet, wait 5 seconds or more, then plug it in again.

#### ■ The unit turns off unexpectedly

- The AV receiver will automatically enter standby mode when Auto Standby or Sleep Timer is set and launched.
- The protection circuit may have been activated. If this is the case, when you turn the unit on again, "AMP Diag Mode" will appear on the main unit's display. The unit will then enter a mode that detects abnormal conditions. If no problems are detected, "AMP Diag Mode" will disappear and the unit will return to a normal state. If "CHECK SP WIRE" appears on the display, the speaker cables may be short-circuited. Turn the unit off, and check to see if the cable core of any of the speaker cables is in contact with that of another speaker cable or with the rear panel. After that, turn the unit on again. If "NG" appears, unplug the power cord immediately and contact your Onkyo dealer.

**WARNING:** If smoke, smell or abnormal noise is produced by the unit, unplug the power cord from the wall outlet immediately and contact the dealer or Onkyo Support.



## Audio

- Make sure that the speaker setup microphone is not still connected.
- Confirm that the connection between the output jack on the device and the input jack on this unit is correct.
- Make sure that none of the connecting cables are bent, twisted, or damaged.
- If the MUTING indicator on the display flashes, press MUTING on the remote controller to unmute the unit.
- While headphones are connected to the PHONES jack, no sound is output from the speakers.
- Set to "Off" if "Audio Select" - "PCM Fixed Mode" is set to "On".

Check the following if the above does not fix the problem:

### ■ There is no sound from the TV

- The input selector on this unit needs to be switched to TV.
- If your TV does not support ARC, you need, in addition to the HDMI OUT jack connection, a digital optical cable connection between the digital audio out optical jack of the TV and the TV OPTICAL input jack of the unit, or an analog audio cable connection between the audio output jack of the TV and the analog audio input jack for TV of the unit.

### ■ No sound from a connected player

- Change the input selector on this unit to the position of the terminal to which the player is connected.
- Check the digital audio output setting on the connected component. On some game consoles, such as those that support DVD, the default setting is off.
- With some DVD-Video discs, you need to select an audio output format from a menu.

### ■ A speaker produces no sound

- Make sure that the polarity of the speaker cables (+/-) is correct, and that no bare wires are in contact with the metal part of speaker terminals.
- Make sure that the speaker cables are not shorting.
- Make sure the speakers are configured correctly.

### ■ Only the front speakers produce sound

- When the Stereo or Mono listening mode is selected, only the front speakers and subwoofer produce sound.

### ■ Only the center speaker produces sound

- If you use the Dolby Surround listening mode with a mono source, such as an AM radio station or mono TV program, the sound is concentrated in the center

speaker.

### ■ The surround speakers produce no sound

- When the T-D (Theater-Dimensional), Stereo or Mono listening mode is selected, the surround speakers produce no sound.
- Depending on the source and current listening mode, not much sound may be produced by the surround speakers. Try selecting another listening mode.

### ■ The center speaker produces no sound

- When the Stereo or Mono listening mode is selected, the center speaker produces no sound.

### ■ No sound from the back speakers or height speakers

- Depending on the source and current listening mode, not much sound may be produced by the speakers. Try selecting another listening mode.

### ■ The subwoofer produces no sound

- When you play source material that contains no information in the LFE channel, the subwoofer produces no sound.

### ■ Volume is low

- Check the volume. The volume level is adjustable between Min, 1 to 79, Max (80). It is normal that the unit volume level is set up to 40 or around.

### ■ Noise can be heard

- Using cable ties to bundle audio cables with power cords, speaker cables, etc. may degrade the audio performance, so refrain from doing it.
- An audio cable may be picking up interference. Try repositioning your cables.

### ■ The sound changes when I connect my headphones

- When a listening mode other than Direct or Mono is selected, connecting a headphone automatically selects Stereo.

### ■ About DTS signals

- When DTS program material ends and the DTS bitstream stops, the unit remains in DTS listening mode and the dts indicator remains on. This is to prevent noise when you use the pause, fast forward, or fast reverse function on your player. If you switch your player from DTS to PCM, you may not hear any sound because the unit does not switch formats immediately. In such case, you should stop your player for about 3 or more seconds and then resume playback.
- With some CD and LD players, you will not be able

to playback DTS material properly even though your player is connected to a digital input on the unit. This is usually because the DTS bitstream has been processed (e.g., output level, sampling rate, or frequency response changed) and the unit does not recognize it as a genuine DTS signal. In such cases, you may hear noise.

- Playing DTS program material, using the pause, fast forward, or fast reverse function on your player may produce a short audible noise. This is not a malfunction.

### ■ The beginning of audio received by an HDMI input jack cannot be heard

- Since it takes longer to identify the format of an HDMI signal than it does for other digital audio signals, audio output may not start immediately.



## Listening Mode

- When listening to Dolby Digital and/or DTS sound, digital connection is necessary.
- Check the digital audio output setting on the connected component. On some game consoles, such as those that support DVD, the default setting is off.
- After pressing RECEIVER on the remote controller, repeatedly press DISPLAY to switch the display on the main unit. You can see the input format.

Check the following if the above does not fix the problem:

### ■ Cannot select a desired listening mode

- Depending on the connecting status of the speaker, some listening modes may not be selected. Check the details in "Selectable Listening Modes" section.

### ■ There is no sound with Dolby Atmos

- Back speakers or height speakers need to be installed. After connecting the speakers, check that the connection settings in "Configuration" - "Speaker Channels" are made correctly.
- Dolby Atmos signals need to be input for Dolby Atmos playback to be possible.

## Video

- Confirm that the connection between the output jack on the device and the input jack on this unit is correct.
- Make sure that none of the connecting cables are bent, twisted, or damaged.
- Make sure the switching of input screens is proper at the monitor side such as a TV.

Check the following if the above does not fix the problem:

### ■ There is no picture from a source connected to an HDMI input terminal

- Change the input selector on this unit to the position of the terminal to which the player is connected.
- Check if "Resolution Error" is displayed on the main unit display when video input via HDMI input jack is not displayed. In this case, the TV does not support the resolution of the video input from the player. Change the setting on the player.
- Reliable operation with an HDMI-to-DVI adapter is not guaranteed. In addition, video signals from a PC are not supported.
- Turn the Deep Color function off. To turn off the Deep Color function, simultaneously press the STRM BOX and ⏻ON/STANDBY buttons on the main unit. While holding down STRM BOX, press ⏻ON/STANDBY repeatedly until "Deep Color:Off" appears on the display. To reactivate the Deep Color function, repeat the above described step until "Deep Color:On" appears on the display.

### ■ Images flicker

- It is possible that the resolution of the player is not compatible with the TV's resolution. If you have connected the player to this unit with an HDMI cable, try changing the output resolution on the player. There also may be an improvement if you change the screen mode on the TV.

## Linked operation

### ■ There is no linked operation with CEC compliant devices, such as a TV

- Set the HDMI CEC (RIHD) setting of the unit to "On". After pressing RECEIVER on the remote controller, press the SETUP button, select "5. Hardware" - "HDMI" - "HDMI CEC (RIHD)" and turn it on.
- It is also necessary to set HDMI linking on the CEC compliant device. Check the instruction manual.

### ■ The RI functions do not work

- To use RI, you must make an RI connection and an analog audio connection (RCA) between the component and AV receiver.

## Tuner

### ■ Reception is noisy, FM stereo reception is noisy, or the "FM STEREO" indicator does not stay lit

- Re-check the antenna connection.
- Relocate your antenna.
- Move the unit away from your TV or PC.
- Passing cars and airplanes can cause interference.
- Concrete walls weaken radio signals.
- Listen to the station in mono.
- When listening to an AM station, operating the remote controller may cause noise.



## Bluetooth

- Try plugging/unplugging the power of the unit and try turning on/off the Bluetooth-enabled device. Re-startup of the Bluetooth-enabled device may be effective.
- The Bluetooth-enabled devices must support the A2DP profile.
- Near components such as microwave oven or cordless phone, which use the radio wave in the 2.4 GHz range, a radio wave interference may occur, which disables the use of this unit.
- If there is a metallic object near the unit, Bluetooth connection may not be possible as the metal can effect on the radio wave.

Check the following if the above does not fix the problem:

### ■ Cannot connect with this unit

- The Bluetooth function of the Bluetooth-enabled device is not enabled. Refer to the user manual of the Bluetooth-enabled device for how to enable the Bluetooth function.
- When Bluetooth connection fails the first time, select "5.Hardware" - "Bluetooth" - "Pairing Information", select "Clear". Turn your Bluetooth-enabled device off and then on again to clear the device name, and try to connect again.

### ■ Music playback is unavailable on the unit even after successful Bluetooth connection

- When the audio volume of your Bluetooth-enabled device is set low, the playback of audio may be unavailable. Increase the volume of the Bluetooth-enabled device.
- Depending on the Bluetooth-enabled device, Send/Receive selector switch may be provided. Select Send mode.
- Depending on the characteristics or specifications of your Bluetooth-enabled device, playback on the unit is not guaranteed.

### ■ Sound is interrupted

- Problem may be occurring at the Bluetooth-enabled device. Check the information on a web page.

### ■ The audio quality is poor after connection with a Bluetooth-enabled device

- The Bluetooth reception is poor. Move the Bluetooth-enabled device closer to the unit or remove any obstacle between the Bluetooth-enabled device and this unit.

### ■ The Auto Reconnect function of Bluetooth does not

## work

- This may not work with some Bluetooth-enabled devices. In that case, pair the unit and the Bluetooth-enabled device and then play again.

## Remote Controller

- Make sure that the batteries are installed with the correct polarity.
- Install new batteries. Do not mix different types of batteries, or old and new batteries.
- Make sure that the remote controller is not too far away from the unit, and that there is no obstruction between the remote controller and the remote control sensor of the unit.
- Make sure that the unit is not subjected to direct sunshine or inverter-type fluorescent lights. Relocate if necessary.
- If the unit is installed in a rack or cabinet with colored-glass doors or if the doors are closed, the remote controller may not work reliably.

Check the following if the above does not fix the problem:

### ■ The remote controller does not work

- Before operating this unit with the remote controller, be sure to first press RECEIVER.

### ■ Operating other Onkyo component by using a RI remote control code is not available

- Make sure that the Onkyo component is properly connected with RI cable. When RI cable is used for connection, make sure to connect analog audio cable as well. (Connecting only an RI cable will not be enough.)
- Make sure you have selected the correct remote controller mode.
- When the RI remote control code is input, point the remote controller at remote control sensor of the unit.
- Make sure that the input display is correctly set.
- Input the RI remote control code again.

### ■ Cannot operate Onkyo components (ones without RI connection) and components of other makers

- Operate the remote controller by setting toward the light receiving section of each component.
- When using the remote controller to control other manufacturers' AV components, some buttons may not work as expected. Some components may not start the operation.
- Make sure you have selected the correct remote

controller mode.

- Make sure you have entered the correct remote control code.
- Make sure to set the same ID on both the unit and remote controller.
- Input a correct remote control code again. If there are several codes, try each code.

## Display, OSD

### ■ The display does not light

- Make sure that Dimmer function is not working. Press DIMMER button and change the brightness level of the display.

### ■ The on-screen menus do not appear

- On your TV, make sure that the video input to which this unit is connected is selected.
- Set "TV Out" - "Impose OSD" to "On".
- The on-screen display are not displayed when the OSD language is set to Chinese if the input selector is "BLUETOOTH". Operate by confirming the display on the main unit. (European, Australian, Taiwanese and Asian models)





**RI Dock**

- Make sure the unit is turned on, the correct input source is selected, and the volume is turned up.
- Make sure the plugs are pushed in all the way.
- Make sure your iPod/iPhone is properly inserted in the Dock. If your iPod/iPhone is in a case, it may not connect properly to the Dock. Always remove your iPod/iPhone from the case before inserting it into the Dock. Try reconnecting your iPod/iPhone.
- Make sure your iPod/iPhone is actually playing.

Check the following if the above does not fix the problem:

**■ There is no sound**

- Try resetting your iPod/iPhone.

**■ There is no video**

- Make sure the correct input is selected on your TV or the unit.
- Make sure that your iPod/iPhone model's TV OUT setting is set to On.
- Some versions of the iPod/iPhone do not output video.

**■ The AV receiver's remote controller does not control your iPod/iPhone**

- The iPod/iPhone cannot be operated while it is displaying the Apple logo.
- Make sure you have selected the correct remote controller mode.
- When you use the AV receiver's remote controller, point it toward this unit.
- Before operating with the remote controller, you may need to play on your iPod/iPhone to make the input selector be recognized.
- Depending on your iPod/iPhone model and generation, some buttons may not work as expected.
- Try resetting your iPod/iPhone.

**■ The unit unexpectedly selects your iPod/iPhone as the input source**

- Always pause iPod/iPhone playback before selecting a different input source. If playback is not paused, the Direct Change function may select your iPod/iPhone as the input source by mistake during the transition between tracks.

**Others****■ Strange noises can be heard from the unit**

- If you have connected another unit to the same wall outlet as this unit, this noise may be an effect from the other unit. If the symptoms improve by unplugging the power cord of the other unit, use different wall outlets for this unit and the other unit.

**■ When performing Automatic Speaker Setup, the measurement fails and the message "Ambient noise is too high." is displayed**

- This can be caused by a malfunction in your speaker unit. Check if the unit produces normal sounds.

**■ The Late Night function does not work**

- Make sure the source material is Dolby Digital, Dolby Digital Plus or Dolby TrueHD.

**■ The Cinema Filter function does not work**

- This function can be used in the following listening modes: Dolby Digital, Dolby Digital Plus, Dolby TrueHD, Multichannel, DSD, DTS, DTS-ES, DTS Neo:6 Cinema, DTS 96/24, DTS-HD High Resolution Audio, DTS-HD Master Audio, DTS Express.

**■ How do I change the language of a multiplex source**

- Select "Main" or "Sub" for "Multiplex Input Channel" in "3. Audio Adjust" -"Multiplex/Mono".

**■ Power consumption in standby mode**

- In the following cases, the power consumption in standby mode may reach up to a maximum of 33 W:
  - When "HDMI CEC (RIHD)" is set to "On". (Depending on the TV status, the AV receiver will enter normal standby mode.)
  - The "HDMI Standby Through" setting is set to other than "Off".
  - The "Power Out at Standby for STRM BOX" setting is "On".



## Reference Information

### Linked Operation with CEC-compatible Components

Link operation with a product conforming to the CEC of the HDMI standard.

Note that linked operation is not always guaranteed with all CEC devices.

**Operation has been confirmed on the following devices (as of February 2015).**

TV (Random order):

- Toshiba TV sets
- Sharp TV sets

Players/Recorders (Random order):

- Onkyo and Integra RIHD-compatible players
- Toshiba players and recorders
- Sharp players and recorders (only when used together with Sharp TV sets)

**Caution:** For linking functions to work properly, do not connect more RIHD-compatible components than the quantities specified below, to the HDMI jacks. Linking functions are not guaranteed when more RIHD-compatible components than the below mentioned quantities are connected. Furthermore, do not connect the AV receiver to another AV receiver/AV amplifier via HDMI.

- Blu-ray Disc/DVD players: up to 3.
- Blu-ray Disc/DVD recorders: up to 3.
- Cable TV tuner, terrestrial digital tuner, and satellite broadcasting tuner: up to 4 units.

### Checking whether the HDMI Linked Operation Settings Are Enabled

1. Turn on the power of all connected components.
2. Turn off the power of the TV, and confirm that the power of the connected components is turned off automatically with the link operation.
3. Turn on the power of the Blu-ray Disc/DVD player/recorder.
4. Start playback on the Blu-ray Disc/DVD player/recorder, and verify the following:
  - The AV receiver automatically turns on, and selects the input to which the Blu-ray Disc/DVD player/recorder is connected.
  - The TV automatically turns on, and selects the input to which the AV receiver is connected.
5. Following the operating instructions of the TV, select "Use the TV speakers" from the menu screen of the TV, and confirm that the audio is output from the speakers of the TV, and not from the speakers connected to the AV receiver.
6. Select "Use the speakers connected from the AV receiver" from the menu screen of the TV, and confirm that the audio is output from the speakers connected to the AV receiver, and not from the TV speakers.

**Caution:**

- Even if you set to output audio on the TV speakers, audio will be output from the speakers connected to the AV receiver when you adjust the volume or switch the input on the AV receiver. To output audio from the TV speakers, redo the corresponding operations on the TV.
- In case of an RIHD connection with RI and RI EX audio control compatible components, do not connect the RI cable at the same time.
- On the TV, when you select anything other than the HDMI jack to which the AV receiver is connected, the input on the AV receiver will be switched to "TV".
- The AV receiver will automatically power on in conjunction when it determines it to be necessary. Even if the AV receiver is connected to an RIHD compatible TV or player/recorder, it will not power on if it is not necessary. It may not power on in conjunction when the TV is set to output audio from the TV.
- Linked system functions with the AV receiver may not work depending on the component model connected. In such cases, operate the AV receiver directly.

- When the player/recorder cannot be operated with the remote controller of the AV receiver, the corresponding component may not be programmed to support the remote controller operation of CEC. Program the remote control code of the component maker to the remote controller for using.



## About HDMI

HDMI (High-Definition Multimedia Interface) is a digital interface standard for connecting TVs, projectors, Blu-ray Disc/DVD players, set-top boxes, and other video components. Until now, several separate video and audio cables have been required to connect AV components. With HDMI, a single cable can carry control signals, digital video and digital audio (2-channel PCM, multichannel digital audio, and multichannel PCM).

The HDMI video stream (i.e., video signal) is compatible with DVI (Digital Visual Interface) (\*1), so TVs and displays with a DVI input can be connected by using an HDMI-to-DVI adapter cable. (This may not work with some TVs and displays, resulting in no picture.)

This unit supports HDCP (High-bandwidth Digital Content Protection) (\*2), so it can display picture only on HDCP-compatible components.

HDMI of the unit supports the following functions.

Audio Return Channel, 3D, x.v.Color, Deep Color, LipSync, 4K (Passthrough)

### Audio Formats Supported by The Unit:

- 2-channel linear PCM (32 - 192 kHz, 16/20/24 bit)
- Multichannel linear PCM (up to 7.1 ch, 32 - 192 kHz, 16/20/24 bit)
- Bitstream (Dolby Atmos, Dolby Digital, Dolby Digital Plus, Dolby TrueHD, DTS, DTS-HD High Resolution Audio, DTS-HD Master Audio)
- DSD

Your Blu-ray Disc/DVD player must also support HDMI output of the above audio formats.

### About Copyright Protection:

The HDMI jacks on this unit support Revision 1.4 and Revision 2.2 of the HDCP (High-bandwidth Digital Content Protection) (\*2), a copy-protection system for digital video signals. Other devices connected to the unit must also support HDCP.

\*1 DVI (Digital Visual Interface): The digital display interface standard set by the DDWG (\*3) in 1999.

\*2 HDCP (High-bandwidth Digital Content Protection): The video encryption technology developed by Intel for HDMI/DVI. It is designed to protect video content and requires a HDCP-compatible HDMI/DVI receiver to display the encrypted video.

\*3 DDWG (Digital Display Working Group): Lead by Intel, Compaq, Fujitsu, Hewlett Packard, IBM, NEC, and Silicon Image, this open industry group's objective is to address the industry's requirements for a digital connectivity specification for high-performance PC and digital displays.

### Caution:

- There are some content that can be played only with HDCP Rev. 2.2 compatible devices. To play such content, connect an HDCP Rev.2.2 compatible TV or player to a HDMI jack of the unit.
- The HDMI video stream (i.e., video signal) is compatible with DVI (Digital Visual Interface), so TVs and displays with a DVI input can be connected by using an HDMI-to-DVI adapter cable. (Note that DVI connections only carry video, so you will need to make a separate connection for audio.) However, reliable operation with such an adapter is not guaranteed. In addition, video signals from a PC are not supported.
- The HDMI audio signal (sampling rate, bit length, etc.) may be restricted by the connected source component. If the picture is poor or there is no sound from a component connected via HDMI, check its setup. Refer to the connected component's instruction manual for details.



## Reference Information

## Remote Control Codes

## ■ Television (A to E)

A.R. Systems	10037, 10556
ACCENT	10037
Acoustic Solutions	11667, 11585, 11523, 11037
Action	10650
Adcom	10625
Addison	10653, 11150
Admiral	10093
AEG	12197, 11037, 12239
Affinity	13717, 13870, 13577
Afron	13478
Aiko	10037
Aim	10037
Akai	12676, 10812, 10037, 10672, 10208, 10714, 11523, 13067, 12414, 13183, 10178, 10556, 12197
Akiba	10037
Akito	10037
Akura	12289, 10037, 11667, 10714, 10668, 11585, 10171, 11037, 11498, 11687, 11983, 12239
Alba	12676, 11037, 10037, 10668, 10714, 11585, 13005, 13067, 13790, 11667, 12104, 12561
Alfide	10672
Alien	11037
Allstar	10037

Amstrad	10037, 10171, 11037
Anam	10037, 10650
Andersson	12676, 11585
Anitech	10037
Ansonic	10668, 10037
AOC	11589, 12769, 11365, 13720, 12014, 12087, 13790, 10093, 10178, 10625, 11150
Apex Digital	12397
Apollo	12239
Ardem	10714, 10037
Arena	10037
Ario	12397
Aristona	10556, 10037
ART	11037
Art Mito	11585, 11667
AS	11667, 11585, 11523, 11037
Asberg	10037
Astra	10037
ATD	10698
Atlantic	10037
Atvio	13636
Audiosonic	10714, 12104, 10037, 13067, 11983
Audio-Technica	10000, 10093, 10150, 11150
Audiovox	11769
Audioworld	10698
Auria	12087, 12014
Autovox	12676
Aventura	10171
Axxon	10714
Azuki	12239
B & O	10620
Baier	12239
Baird	10208

Bang & Olufsen	10620
Barco	10556
Base	10698
Basic Line	10037, 10668, 11037, 10556
Bauer	12197
Baur	10037, 10512, 10195
BBK	12098, 11523
Beaumarck	10178
Beijing	10208, 10812
Beko	10714, 12125, 10037, 12239
Bell & Howell	10017
Belson	10698, 11667
Belstar	11037
BenQ	12563, 11562, 11523
Beon	10037
Berthen	10556, 10668
Bestar	10037
Bexa	12493
BGH	14070, 14029, 10898, 12414, 12098
Black Diamond	11037
Blaupunkt	10195, 12426
Blue Sky	10714, 10037, 11037, 10668, 10556, 10625
BlueDiamond	12426
Bluetech	12561
bogo	12561
BPL	10208, 10037
Brandt	10625, 11585, 10714
Brinkmann	10037, 10668
Brionvega	10037
Britania	12414
BuBuGao	12098, 11523

Bush	11037, 10037, 12676, 10668, 10714, 13790, 13005, 11667, 11687, 11983, 10556, 12125, 10208, 11585, 12104, 10698, 11589, 12673, 12964
Byd:sign	12209
Cameron	11523
Camper	10037
Carad	11037, 10668
Carena	10037
Carrefour	10037
Cascade	10037
Casio	10037
Cathay	10037
CCE	13782, 14091, 10037
Celcus	12676, 11585
Celebrity	10000
cello	12673
Centrum	11037
Centurion	10037
Changhong	13434, 12769, 11498, 10508, 10208
Chiawin	10810
Chimei	12769
CHL	13067
Chung Hsin	11150
Chunyun	10000, 11150, 11687
Cinema	10672
Clarivox	10037
Clatronic	10037, 10714
Clayton	11037
CME	10037, 10512
CMX	13332, 13067



Reference Information

Coby	13478, 12315, 13627
Commercial Solutions	11447
Condor	10037
Conia	11498, 11523, 11687
Conrowa	10698
Contec	10037
Cosmel	10037
CPTEC	10625
Crosley	10000
Crown	10037, 10714, 10208, 10672, 11037, 10668
Crown Mustang	10672, 10898
Crypton	11667
Currys Essentials	12486
Curtis	12855, 13577, 12466, 12352, 13895, 12397, 13636, 13382, 14035
Curtis Mathes	10093
Cyberpix	11667
Daenyx	10672
Daewoo	10634, 10037, 10672, 10556, 12098, 10178, 11150, 12125
Dansai	10037, 10208
Dantax	11037, 12676, 10714, 11667
Datsura	10208
DAWA	10037
Daytek	10672
Daytron	10037
De Graaf	10208
Decca	10037
Dell	11863
Denver	12197, 13067, 10037, 12239
Desmet	10037

Devant	12098
DGM	12239
Diamant	10037
Diamond	10698, 10672
Dick Smith Electronics	10698
Digatron	10037
Digihome	12676, 11667
Digiline	10037, 10668
Digimate	12239
Digisonic	11826
Digitor	10698, 10037
Digitrex	13067
Dikom	12561
diVision	12197, 12239
Dixi	10037
DNS	13434
Domeos	10668
Donghai	10037, 10668, 11037
Drean	10037
DSE	10698
Dual	12197, 11037, 12676, 11667, 10037, 11585, 10714
Dumont	10017
Durabrand	10171, 10178, 10714, 11037
Dux	10037
D-Vision	12197, 10037, 10556
DX Antenna	13817
Dynatron	10037
Dynex	12049
E.S.C.	10037
Easy Living	12104
ECE	10037
ECG	12197, 12125
Eiki	10735

Elbe	10037, 10556
Electroband	10000
Electrograph	11755
Electrohome	11670
Electrolux	11585
Electron	12466, 12855
Elektra	10017
Element	13559, 11687, 12183, 12964, 13907, 11886, 12256
Elfunk	11037
ELG	10037
Elin	10037
Elite	13867, 10037
Emerson	11864, 11394, 10171, 11886, 10178, 10037, 13623, 12183, 10668, 10714, 13559
e-motion	12426
Enox.	12673
Envision	11589, 11365, 12087, 12014, 11506
Epson	11379
EQD	12014, 12087
EQD Auria	12014, 12087
Erisson	13183
Erres	10037
ESA	10812, 10171
Essentials	12486
Euroman	10037
Europa	10037
Europhon	10037
Evesham Technology	11667
Evotel	12561
Excello	11037
Exquisit	10037

■ Television (F to J)

F&U	12676
FairTec	11585
Favi	13382
Fedders Lloyd	13639
Ferguson	10625, 11037, 13005, 10037, 12426, 10195, 11585, 12676
Fidelity	10037, 10512, 10171
Finlandia	10208
Finlux	11667, 12676, 10714, 10037, 10556
Firstline	10714, 10037, 10668, 11037, 10208, 10556
Fisher	11585, 10208
Flint	10037
Fluid	12964, 13907
Formenti	10037
Fortress	10093
Fraba	10037
Friac	10037
Frigidaire	11826
Fujimaro	11498, 11687
Fujimaru	11687
Fujitsu	10809
Fujitsu Siemens	10809
Funai	13817, 10171, 11394, 10000, 11037, 10714, 10668, 11864
Funai United	12676
Furriion	13332
Gaba	11037
Galaxi	10037
Galaxis	10037
Gateway	11755



Reference Information

GE	11447, 10178, 10735, 10625, 10093, 11454
GEC	10037
General Electric	11447, 10178, 10735, 10625, 10093, 11454
Genesis	10037
Genexxa	10037
GFM	10171, 11864, 11886
Gibraltar	10017
Gibson	11826
Gintai	11150
Godrej	11585
GoGen	12676, 11585
Goldfunk	10668
GoldStar	10178, 10037, 10714, 13183, 11150
Goodmans	10037, 11037, 10634, 11667, 10668, 11523, 11585, 11687, 11983, 10714, 10556, 10625, 12426, 12676
Gorenje	11585, 12676
Gradiente	10037
Graetz	10714
Gran Prix	12197
Granada	10037, 10208
Grandin	10037, 10714, 10668, 11037, 10556, 12125
Grundig	10195, 11223, 12125, 12239, 10556, 10037, 11523, 11667, 13067, 10672, 12561, 12676
Grunkel	11523

GVA	12098, 13067
Haier	12876, 11749, 12309, 13382, 11753, 13620, 13613, 13429, 10698, 11983, 12293, 13790, 13987, 10037, 10508
Hallmark	10178
Handic	12676
Hankook	10178
Hannspree	11826
Hanseatic	10037, 10634, 10714, 10625, 10556
Hantarex	12197, 10037
Hantor	10037
Harwood	10037
Hauppauge	10037
Havermy	10093
HB	10714
HB Ingelen	10714
H-Buster	13620, 13419
HCM	10037
Heran	11826
Herosonic	11826
Highline	10037
Hikona	11983
Hinari	10037, 10208
HiPlus	11826
Hisawa	10714
Hisense	12846, 12098, 13519, 12183, 10556, 13123, 10508, 14029, 10208, 13382

Hitachi	11643, 12676, 11576, 11585, 11037, 11691, 13317, 11667, 10634, 13639, 10037, 10679, 12170, 12846, 10150, 10178, 10508, 11150
Hitachi Fujian	10150
Hitec	10698
Hiteker	13118
Hoher	10714, 13434
Hongmei	10093
Hornophon	10037
Hua Tun	11150
Hypson	10037, 10714, 10556, 10668, 11037
Hyundai	10698, 12414, 12676, 11037, 11523
Iberia	10037
ICE	10037
iLo	11394
Imperial	10037
Indiana	10037
Ingelen	10714
Ingo Devices	12239
Inno Hit	11585, 11037
Innova	10037
Insignia	12049, 11423, 10171
Integra	11807, 13100, 13500
Inteq	10017
Interbuy	10037
Interfunk	10037, 10512
Internal	10556
Intervision	10037
Irradio	10037

IRT	10698
Isis	12676
Isukai	10037
iSymphony	13429, 13382, 13118
ITS	10037
ITT	12675, 12125, 12676, 10208, 11523
ITT Nokia	10208
ITV	10037
James	13183
Jay-tech	13067
JC Penney	10178
JCB	10000
JCM	12256
Jinfeng	10208
Jinxing	10556, 10037, 10698
JMB	12676, 10634, 10556, 12426
JTC	13067
Jubilee	10556
JVC	11774, 11653, 11601, 11818, 10653, 12321, 12271, 11428, 13650, 11670, 12676, 14070, 10650, 10093, 10508

■ Television (K to N)

Kaisui	10037
Karcher	12125, 10714
Kathrein	10556
KDS	11498, 11687
Kendo	11037, 11585, 12676, 10037
Kennex	11037



## Reference Information

Kioto	10556
Kiton	10037, 10668
KLL	10037
Kneissel	10037, 10556
Kolin	11610, 10150, 11755, 10037, 11150
Kolster	10037
Konig	10037, 10512
Konka	12881, 13419, 10037, 10714
Korpel	10037
Kosmos	10037
Kunlun	10208
Kuppersbusch	12676
L&S Electronic	10714
Lavis	11037
Leader	12876
Lecson	10037
Legend	12397, 12309
Lenco	12676, 11983, 10037, 11037
Leyco	10037
LG	11840, 11860, 11423, 12731, 12182, 12358, 10178, 12362, 13941, 12424, 10037, 10714, 10017, 10556, 10698, 11753
Liberton	13183
Liesenkotter	10037
Lifetec	10668, 10037, 11037, 10714
Linetech	12676
Linsar	12676, 11667, 11585
Lloyd	13639
Lodos	11037

Loewe	10512, 10633, 10037
Logic	11585
Logik	13432, 13005, 12486, 11037, 10698, 11585, 11687
Logix	10668
Luma	10037, 11037
Lumatron	10037, 10668
Lumenio	10037
Lux May	10037
Luxor	12676, 11037, 10208
LXI	10178, 10017
Madison	10037
MAG	11687, 11498
Magnavox	13623, 11866, 12372, 11454, 11506, 10171, 11365, 11755, 11867
Magnum	10714, 10037
Manesth	10037
Manhattan	10037, 11037, 10668
Marantz	10037, 10556, 11454
Mark	10037, 10714
Marks & Spencer	12673
Mascom	12197, 12125
Masters	10037
Mastro	10698
Masuda	10037
Matsui	10037, 10195, 10208, 12486, 11037, 10714, 11667, 12676, 10556, 12561
Matsushita	10650
Maxent	11755

Maxess	12493
Meck	10698
Mediator	10037, 10556
Medion	12676, 10714, 10037, 10668, 11037, 11585, 11667, 10512, 12239, 13067, 10556, 10698, 12563
Megatron	10178
MEI	11037
Meletronic	10037, 10195, 10634, 10512, 10714
Memorex	11687, 11037, 11670, 10178, 10150
Memory	11983
Mercury	10037
Mermaid	10037
Metronic	10625
Metz	11037, 10668, 10195
MGA	10150, 10178
Micromaxx	10037, 10668, 10714, 11037
Microsonic	13419
Midland	10017
Mikomi	11585, 11667
Minato	10037
Minerva	10195
Ministry Of Sound	11667
Minoka	10037
Miray	12414, 13183, 10898
Misakai	10171

Mitsubishi Electric	11250, 12313, 10150, 10178, 10512, 11797, 10093, 10556, 10037, 11150, 11037, 11171
Mivar	10609
Moree	10037
Morgan's	10037
Moserbaer	11585
Motorola	10093
MTC	10512
MTlogic	10714, 12104
Mudan	10208
Multitec	11037, 10037, 10668
Multitech	10037
Murphy	12673
Mx Onda	11983, 11498, 11687
Myryad	10556
Mystery	13047
NAD	10037, 10178
Naiko	10037
Nakimura	10037
National	10208, 10508
Naxa	12104, 13382
NEC	11797, 13257, 12293, 12461, 11585, 10037, 10178, 10508, 10653, 11150
Neckermann	10037, 10556
NEI	10037, 11037
Neoka	11826
Neon	12673
Netsat	10037
NetTV	11755
Neufunk	10037, 10556, 10714
Nevir	12676



Reference Information

New Acoustic Dimension	10037, 10178
New Sonic	11826
New Tech	10037, 10556
Newave	10093, 10178, 11150
NEX	13861
Nexus Electronics	12183
Nikkai	10037
Nikkei	12197, 10714
Nikko	10178, 10017
Nimbro	12104
Noblex	14029
Nokia	10208
Norcent	11365, 11589
Nordmende	13419, 13861, 10037, 10195, 11585, 13835, 10714, 11667
Normerel	10037
Nortek	10668
Novatronic	10037
Novex	11523
Novita	11585
NPG	13434

■ Television (O to S)

O.K.Line	11037
Oceanic	10208
OK Line	11037
OK.	13434, 12676, 13047
Okano	10037
OKI	11667, 12676, 12125, 13434, 11585
Olevia	11610
Omni	10698
Onei	11667
Onida	10653, 12414

Onimax	10714
Onix	10698
Onkyo	11807, 13100, 13500
Onn	12125, 11667
Opera	10037, 10714
Optimus	10650, 10679
Optoma	12796
Optonica	10093
Orava	11037
Orbit	10037
Orion	12108, 10037, 12676, 10556, 10714, 11037, 11667, 13540, 13650
Orline	10037
Ormond	10668, 11037
Osaki	10037, 10556
Osio	10037
Osume	10037
Otic	11983, 11498, 11687
Otto Versand	10037, 10512, 10093, 10556, 10195
Pacific	10714, 11037, 10556
Palladium	10037, 10714, 10556
Palsonic	12461, 10698, 13067, 10037
Panama	10037
Panasonic	11636, 11480, 11291, 10650, 11650, 13825, 12170, 10037, 10093, 10150, 10178, 10208, 10508
Panavideo	13825

Panavision	10037
Panavox	13835
Panda	10698, 10208, 10508
PARK	12104
Penney	10178
Peony	10208
Perdio	10037
Perfekt	10037
Philco	10171, 13426, 12414, 11394, 10037, 10178, 13639
Philips	11887, 11867, 10037, 12372, 12800, 10556, 13614, 11506, 11744, 12768, 12680, 11454, 10639, 11866, 10017, 10512, 13623, 10171, 12769, 11365, 11394, 10000, 10178, 11589
Phocus	10714
Phoenix	10037
PHOENIX Apollo	12239
Phonola	10037, 10556
Pioneer	10679, 11457, 10037, 10698, 11636, 10512, 12171
PJ	11506
Planar	10679, 14247, 11589
Plantron	10037
Playsonic	10714, 10037

Polaroid	11523, 11769, 11498, 11687, 11767, 12676, 14035, 12125, 11826
Powerpoint	10037, 10698
Premier	13419, 13183, 13793
Prestiz	13419
Prima	11753, 10037, 11749, 12461, 10698
Prinston	11037
Pro Vision	10037, 10556, 10714, 12197
Profitronic	10037
ProLine	10625, 10634, 10037, 11037, 12676
Proscan	11447, 12183, 12256, 13577, 13382, 13332, 13717, 13895, 12746, 13636, 14035
Prosonic	10714, 12676, 12125, 10668, 12197, 10037, 11523, 11585, 11667
Protech	10037, 10668, 11037
Proton	10178
Proview	11687, 11498
Proxima	10735
Pulsar	10017
Pye	10037, 10556
Q.Bell	12561
Quadro	11667
QuantumFX	12337
Quasar	11291, 13899, 10650





Reference Information

Quelle	10037, 10512, 11037, 10195, 10668
Radiola	10037, 10556
Radiomarelli	10037
Radionette	10714
RadioShack	10178, 10037
Radiotone	10037, 10668, 11037
RCA	12746, 12434, 12932, 11447, 12247, 13577, 11781, 10625, 12187, 13382, 10679, 13332, 13717, 10093, 13793, 12183, 12855, 13419, 10000, 10178, 10618, 11454, 13426, 13636
Realistic	10178
Recco	10898, 13183
Reconnect	13183
Recor	10037
Rectiligne	10037
Red Star	10037
Reflex	10037, 10668, 11037
RefleXion	12239
Relisys	11585
Relon	11826
Remotec	10037, 10093, 10171, 11150
Reoc	10714, 12197
Revox	10037
RFT	10037
R-Line	10037
Roadstar	11037, 10037, 10714, 10668

Rolsen	12098, 13067, 13434
Rowa	10898, 13047, 10698, 11038, 13001, 10037
RTF	10037
Runco	10017
Saba	10625, 12676, 10714
Saga	12197
Sagem	10618
Saivod	10668, 11037, 10037, 11667
Salora	12197, 12676, 12239, 12125, 13067, 10208
Sampo	11755, 10898, 13419, 10093, 10171, 10178, 10650
Samsung	12051, 10812, 11632, 10618, 11458, 11630, 12953, 10037, 10556, 10650, 10178, 10208, 11150
Sandstrom	12197, 13047
Sansui	13540, 11670, 13564, 10037, 10898, 10171, 10714, 13559
Sanyo	11142, 10208, 11585, 12676, 12461, 12994, 10735, 11974, 12881, 12769, 13488, 11498, 11365, 10508, 11037, 11150, 11667, 13861
Sanyuan	10093

Save	10037
SBR	10037, 10556
Sceptre	13899, 12528, 12337
Schaub Lorenz	10714, 12676, 12125, 12197, 11667, 12289
Schneider	10037, 10714, 10556, 11037, 10668, 11585, 12676
Schontech	11037
Scotch	10178
Scott	10178, 11983
Sears	10171, 10178
Seaway	10634
Seelver	10556, 11037
SEG	12673, 11037, 10037, 10668, 12125, 11523, 10634, 13434
SEI	10037
Seiki	13953, 12964, 13559, 10178
Seiko Epson	11379
Sei-Sinudyne	10037
Semp	11743, 13793
Semp Toshiba	11743, 13793
Sencor	13067, 12197, 10714
Senzu	12493
Serie Dorada	10178
Serino	10093
Shanghai	10208
Sharp	12360, 11659, 10818, 10093, 12951, 11393, 12676, 13867, 10650, 11165, 11423
Sheng Chia	10093, 11150

Shinelco	12104
Shintoshi	10037
Shivaki	12197, 10178, 10037
Siam	10037
Siemens	10195, 10037
Siera	10556, 10037
Silva	10037
Silva Schneider	12197, 10037, 12125
SilverCrest	12676, 11037
Sinudyne	10037
SKY	10037
Sky Brasil	10037
Skyworth	12899, 12963, 12889, 12769, 10037, 10698
SLX	10668
Sogo	13067
Solavox	10037
Soniko	10037
Soniq	12493, 13005
Sonitron	10208
Sonneclair	10037
Sonoko	10037
Sonolor	10208
Sontec	10037
Sontech	11983
Sony	12778, 10810, 11825, 10000, 11651, 11551, 11625, 11505, 11317, 10150, 11150, 10093, 11167
Soundesign	10178
Soundwave	10037, 11037, 12673
SOVOS	12239
Sowa	10178, 11150
Soyea	10698, 11743



Reference Information

Soyo	11826
Spectroniq	11498, 11687
Squareview	10171
SR Standard	10037, 11037
Starion	11037
Starlite	10037
STI	13793
Strato	10037
SunBriteTV	12337, 12528, 11610
Sunic Line	10037
Sunkai	10037, 11523
Sunny	10037
Sunstar	10037
Sunstech	12676
Sunwood	10037
Superior	11585
Superscan	10093, 10171
Supersonic	10208, 11753, 12104
SuperTech	10037, 10556
Supra	10178
Supreme	10000
SVA	11498
Svasa	10208
Swisstec	12106, 12104
Sylvania	10171, 11864, 11886, 11394
Symphonic	10171, 11394
Synco	11755, 11826, 10000, 10093, 10178
Syntax	11610
Sysline	10037

■ Television (T to Z)

Tacico	10178, 11150
Tai Yi	11150
Talent	10178

Tandy	10093
Tashiko	10650, 11150
Tatung	10037, 11150, 11687
Taurus	12197
TCL	13047, 13183, 12434, 13001, 10898, 11038, 12414, 13426, 12675, 10698
TCM	10714
Teac	10037, 11037, 10698, 10714, 11755, 10898, 10178, 10668, 10171, 10512, 11983, 13005
Tec	10037
Tech Line	10037, 10668, 11585
Technica	11037, 12106, 12426
Technical	12676, 11667
Technics	10017, 10556, 10650
Technika	12426, 12106, 12197, 11667, 11983, 12676, 13005, 12125, 13067
TechniSat	10556
Technisson	10714
Techno	11585
Technosonic	10556, 10625
Techwood	12676, 11667, 11037
Tecnimagen	10556
Teco	10093, 10178, 10653, 11523, 11687
Tedexlex	10208
Teknika	10150

TELE System	11585, 12125
Telecor	10037
Telefunken	10625, 12676, 12414, 10698, 12239, 11585, 11667, 10037, 10714
Telefusion	10037
Telegazi	10037
Telemagic	10735
Telemeister	10037
Telesonic	10037
Telestar	10037, 10556
Teletech	10037, 10668, 11037
Television	10037
Tennessee	10037
Tensai	10037, 11037
Terris	11667
Tesco	12426
Tesla	11037, 10037, 10556, 10714
Tevion	10714, 12426, 10668, 11037, 12125, 10037, 10556, 11498, 11585, 11667, 11687, 12197, 12289
ThemeScene	12796
Thomas	10625
Thomas America	10625
Thomson	10625, 13047, 12675, 11447, 10037
Thorn	10037, 10512
Tiane	10093
TMK	10178
TNCi	10017
Tokai	10037, 10668, 11037

Tokaido	11037
Tophouse	10672, 10698
Topline	10668, 11037
Toshiba	11508, 11524, 11656, 13323, 12676, 12598, 10508, 12724, 13570, 11743, 10650, 10618, 12108, 11037, 10093, 10195, 11150, 11169
Tosonic	11508
TRANS-continents	10037, 10556, 10668, 11037
Tranasonic	10037, 10698, 10512
Triad	10556
Trio	11498, 11687
Triumph	10037, 10556
Tucson	12676
TVE	12239
TVTEXT 95	10556
Uher	10037
Ultravox	10037
UMC	12106, 12426
Unic Line	10037
Uniden	12122, 12676, 11667
United	10714, 11037, 10037, 10556, 11523, 11983, 12125, 13434
Universal	10037, 10714
Universum	10037, 11037, 10512, 10668, 10618, 10195
Univox	10037
V7 Videoseven	11755
Vanguard	10037
VD-Tech	13067, 13332



## Reference Information

Venturer	13005
Vestel	11037, 11585, 10037, 12676, 10668, 11667
Vexa	10037
Victor	11428, 10000, 10093, 10150, 11150, 10650, 10653
Videocon	10508, 10037
Videoseven	11755
VideoSystem	10037
Vidikron	10735
Vidtech	10178
Viewsonic	12014, 12745, 12087, 13706, 11755, 11627, 12049, 11365
Viore	12352, 13382, 13118, 13429, 12104
Visa	10037
Vision	11826, 10037
VisionPlus	12426, 12106
Visual Innovations	12106
VIZIO	11758, 13758, 12707, 12757, 13415, 12512, 13174, 12209
Vortec	10037
Voxson	12197, 10178, 10037, 11667
VU	12098, 11365
Walker	12676, 11667, 11585
Waltham	10037, 11037, 10668
Wansa	12098
Wards	10178, 10017, 10000

Watson	11037, 10037, 10668, 10714
WeCube	11860
Wega	10037
Welltech	10714
Weltstar	11037
Westinghouse	11712, 13579, 13382, 13949, 11826, 12293, 11755, 12397
Westwood	11585
Wharfedale	11983, 11667, 10037, 10556
White Westinghouse	10037
Wilson	10556
Windsor	11037, 10668
Windy Sam	10556
Wintel	10714
Wyse	11365
Xenius	11667, 10634, 11585, 12676
Xiahua	11753, 10037, 11749, 12461, 10698
Xiron	11983, 11037
XLogic	10698
Xococo	11753, 10037, 11749, 12461, 10698
Xogego	11753, 10037, 11749, 12461, 10698
Xoro	13067
Xpeer	12051
XRYPTON	10037
Yamaha	11576, 10650
Yamishi	10037
Yokan	10037
Yoko	10037
YU-MA-TU	10037

Zenith	10017, 10178, 11423, 10000, 12731, 11365, 12358, 12362
Zepto	11585
Ziggo	11818
Zonda	10698

## ■ TV DVD Combination

Akai	32966
Alba	32966
Black Diamond	30713
Blue Sky	30713
Bush	30713, 32966
Celcus	32966
Centrum	30713
Crown	30713
Dantax	32966
Digihome	32966
Dual	32966, 30713
Elfunk	30713
Emerson	30675
Ferguson	30713, 32966
Finlux	32966
Funai	30675
Goodmans	30713, 32966
Grandin	30713
Grundig	30539, 32966
Hitachi	32966, 30713
Hyundai	32966
Insignia	32095
JMB	32966
JVC	32966
Kuppersbusch	32966
Linetech	32966
Linsar	32966
Logik	30713
Luxor	32966, 30713
Matsui	30713, 32966
Medion	32966

Mitsubishi Electric	34004
OK.	32966
OKI	32966
Orava	30713
Orion	30713
Panasonic	32859
Philips	30539
Polaroid	32966
ProLine	32966
Prosonic	32966
Saba	32966
Salora	32966
Sanyo	32966
SEG	30713
Sharp	32966, 30630
Sony	30864
Soundwave	30713
Sylvania	30675, 30630
Symphonic	30675
Technica	30713
Technical	32966
Techwood	32966
Telefunken	32966
Teletech	30713
Thomson	30551
Toshiba	32966
United	30713
Universum	30713
Walker	32966
Waltham	30713
Weltstar	30713
Xiron	30713

## ■ DVD

3D LAB	30539
Accurian	30675
Acoustic Solutions	30730, 30713
AEG	30675, 31643, 30770, 31233
Aitro	32095



## Reference Information

Aiwa	30533
Akai	32966, 30770, 31233, 30675
Akura	31233
Alba	32966, 30713, 30539, 30730
Amitech	30770
Amphion MediaWorks	30872
Amstrad	30713, 30770, 32139
AMW	30872
Ansonic	30831
Anthem	32820
Anthem Statement	32820
Aristona	30539, 30646
Arrgo	31023
AS	30730, 30713
ASDA	32213
Audio Authority	32555
Audix	30713
Autovox	30713
Awa	30730, 30872
Axon	30730
Basic Line	30713
Beko	30831
Bel Canto Design	31571
Belson	32139
Berthen	31643
Best Buy	32139
Black Diamond	30713
Blu:sens	31233
Blue Parade	30571
Blue Sky	30713
Brainwave	30770
Brandt	30551, 30503
Bush	30713, 30730, 30831, 32966
Byd:sign	30872
California Audio Labs	30490
Cambridge Audio	32808
CCE	30730

Celcus	32966
Centrum	30713, 30675
Changhong	30627
Cinea	30831
Cineral	30730
Cinetec	30713, 30872
CJ Digital	31643
Classic	30730
Clatronic	30675, 31233
Clayton	30713
CMX	31643
Coby	32494, 30730
Codex	31233
Continental Edison	30831, 30872
Craig	30831
Crown	30713, 30770
Cybercom	30831
CyberHome	31023
Daenyx	30872
Daewoo	30770, 30872, 30490
Dansai	30770
Dantax	30713, 30539, 32966
Datsun	31233
Daytek	30872
Dayton Audio	30872
DCE	30831
Decca	30770
Denon	31634, 32258, 30490, 32748, 33851
Denver	31643
Dewo	31634
Dick Smith Electronics	32095, 30675
Digihome	32966, 30713
DigiLogic	30713
DiK	30831
Dikom	32494
Disney	30675, 30831

DK Digital	30831, 32095, 31643
Donghai	31233
Dragon	30831
DSE	32095, 30675
Dual	30831, 30730, 30713, 32966, 31023
Durabrand	30713, 30675, 31023, 30831
Dynex	32596
E:max	30770, 31233, 31643
ECC	30730
Electrocompaniet	32545
Elfunk	30713
Elin	30770
Elite	32854
Elta	30770, 31643, 31233
Eltax	31233
Emerson	30675, 30591, 32213
Enterprise	30591
Epworth	30533
EuroLine	30675, 31233, 31643
Ferguson	30713, 32966
Finlux	32966, 30770, 30591, 30741
Firstline	30713
Funai	30675
GE	30522
General Electric	30522
GFM	30675
G-Hanz	32213
G-HanzS	32213
Go Video	31044, 30741
GoGen	32139
GoldStar	30741, 30591
Goodmans	30713, 30730, 32966

GoWell	31643
GPX	30741
Gran Prix	30831
Grandin	30713, 31233
Grundig	30539, 30551, 30713, 31643, 32966
Grunkel	30770, 30831
GVG	30770
H & B	30713, 31233
Hanseatic	30741
Harman/Kardon	30582, 33228, 32927
HE	30730
Hello Kitty	30831
Hen°	30713
Hitachi	30573, 32966, 30713, 31664
Hoher	30713, 30831, 31643
Home Electronics	30770, 30730
Home Tech Industries	31643
Humax	30646
HYD	31233
Hyundai	32966
Ingersoll	31023
Inno Hit	30713
Insignia	32095, 32596, 32428, 30675, 30741
Integra	30627, 32147, 31769, 31634, 30571, 30503, 31612
Irradio	31233, 30646
ITT	31233
Jamo	32358
JDB	30730
JMB	32966
JVC	30623, 31602, 32365, 32612, 32855, 32966



## Reference Information

Kansas Technologies	31233
Kendo	30713, 30831
Kennex	30713, 30770
Kenwood	30534, 30490
KeyPlug	31643
Kihiro	30770
KingVision	31643
Kuppersbusch	32966
Leiker	30872
Lenco	30713, 30770
Lenoxx	32213
Lexicon	32545
LG	30741, 32811, 31602, 30591, 31233
Lifetec	30831
Linetech	32966
Linsar	32966
LM	31643
Lodos	30713
Loewe	30741, 30539
Logik	30713
Lumatron	30713, 30741
Lunatron	30741
Luxman	30573
Luxor	32966, 30713
Magnavox	30675, 31354, 30503, 30539, 30646, 31506, 33488, 30713
Manhattan	30713
Marantz	30539, 32481, 32414, 33444
Mark	30713
Marquant	30770
Matsui	30713, 32966
Maxim	30713, 30872
MBO	30730
McIntosh	31273
MDS	30713
Mecotek	30770

Medion	30831, 32966, 30741, 30630
Memorex	30831, 32213, 33153
Metz	30713, 30571
Micromedia	30503, 30539
Micromega	30539
Microsoft	31708, 32083, 32202, 30522
Microstar	30831
Minax	30713
Minoka	30770
Mitsubishi Electric	31521, 34004, 30713
Mizuda	30770
Mustek	30730
Muvid	31643
Mystral	30831
NAD	30741
Naiko	30770
NEC	30741, 31602
Neom	31643
Nevir	30831, 30770
New Acoustic Dimension	30741
Nisato	31233
Noblex	31233
Norcent	30872
Nordmende	30831
Nortek	31643
OK.	32966
OKI	32966
Omni	32139
One For All	32555
Onkyo	30627, 32147, 30503, 31769, 31612, 30571, 31634
Oppo	32545, 30575
Optimus	30571
Orava	30713
Orbit	31643, 30872

Orion	30713, 31233
Ormond	30713
Pacific	30831, 30713
Packard Bell	30831
Palladium	30713
Panasonic	31641, 30490, 33641, 31579, 33580, 33862, 32710, 32859, 32523, 30503
Philco	30675
Philips	32056, 30539, 31354, 32789, 30646, 32434, 31506, 32334, 31340, 30503, 33488, 30675, 32084, 30713
Pioneer	31571, 30571, 30631, 31531, 32442, 32847, 30142, 32854
Play It	31643
Polaroid	32966
Polk Audio	30539
Portland	30770
Powerpoint	30872
Presidian	30675
Prinz	30831
Prism	30831
Pro Vision	30730
ProLine	31643, 32966
Proscan	30522
Proson	30713
Prosonic	32966
Pye	30539, 30646, 30675
Radionette	30741
Radiotone	30713
RCA	30522, 32213, 30571, 31769, 32532

RE-BL	32555
REC	30490
Red	32213
Red Star	30770
Richmond	31233
Roadstar	30713, 30730
Ronin	30872
Rotel	30623
Rowa	30872
Saba	30551, 31643, 32966
Saivod	30831
Salora	32966, 30741
Samsung	30199, 30573, 33195, 32069, 31635, 32942, 32369, 32329, 32489, 31044, 30490, 32107
Sanyo	32966, 30713, 31233
ScanMagic	30730
Schaub Lorenz	30770, 31643
Schneider	30539, 30646, 30831, 30713
Schontech	30713
Scott	31233
Seeltech	31643
SEG	30713, 30872
Semp	30503
Semp Toshiba	30503
Sharp	32250, 30630, 32966, 30675, 33313, 30713
Sherwood	30741, 30770, 32820, 33837
Shinsonic	30533
Sigmatek	32139
Silva Schneider	30831, 30741
SilverCrest	31643
Skantic	30713, 30539
Skymaster	30730



## Reference Information

SM Electronic	30730
Smart	30713
Sonashi	30831
Soniq	30831
Sony	31516, 31633, 30533, 31033, 30864, 31070, 31548, 32861, 31536, 32839, 32180, 30772
Sound Color	31233
Soundwave	30713
Spectra	30872
SR Standard	30831
Sunkai	30770
Sunstech	30831, 32139, 32966
Superior	31643
Supratech	32139
SV2000	30675
Sylvania	30675, 30630
Symphonic	30675
Sytech	30831
Tandberg	30713
Targa	30741
Tascam	31818
Tatung	30770
TBoston	32139
Tchibo	30741
TCM	30741
Teac	30571, 30675, 30741, 31818, 32139, 34004
Technica	30713
Technical	32966
Technics	30490
Technika	30770, 30831
Technosonic	30730
TechnoStar	31643
Techwood	30713, 32966
Telefunken	30551, 32966

Teletch	30713
Tensai	30770
Theta Digital	30571
Thomson	30551, 30522, 30831
Thule Audio	30551
Tokai	31233
Tosaki	32006
Toshiba	30503, 33157, 33857, 32006, 32277, 32705, 31769, 32966, 32551
TRANS-continents	30831, 30872, 31233
Transonic	30730
Trent	31643
Trevi	30831
TruTech	30675
TVE	30713
United	30713, 30675, 30730, 31233, 31643
Universum	30713, 30741, 30591
Urban Concepts	30503
Venturer	31769
Vestel	30713
Vitek	30831
VIZIO	32563
Voxson	30730, 30831
Waitec	30730, 31233
Walker	32966
Waltham	30713
WB Electronics	32555
Welkin	30831
Wellington	30713
Weltstar	30713
Wharfedale	30713
Wilson	31233, 30831

Windsor	30713
Windy Sam	30573
Woxter	32139
Xbox	32083, 31708, 32202, 30522
Xiron	30713
XMS	30770
X-View	31233
Yamada	30872, 32139
Yamaha	30497, 32298, 30539, 30817, 30490, 31354, 33871, 30646, 33837
Yamakawa	30872
YBA	30872
Yukai	30730
Zenith	30741, 30591, 30503

## ■ Blu-ray Disc

Anthem	32820
Anthem Statement	32820
Cambridge Audio	32808
Denon	32258, 32748, 33851
Electrocompaniet	32545
Elite	32854
Funai	30675
Harman/Kardon	33228, 32927
Insignia	32596, 32428, 30675
Integra	32147, 32900, 32910, 33100, 33101, 33500, 33501
JVC	32365, 32612, 32855
Lexicon	32545
LG	31602, 32811, 30741

Magnavox	30675
Marantz	32414, 33444
Mitsubishi Electric	34004
Onkyo	32147, 32900, 33101, 33501, 32910, 33100, 33500
Oppo	32545
Panasonic	31641, 33862, 33580, 33641, 32859, 32523, 32710
Philips	32789, 32434, 32084
Pioneer	32442, 32847, 32854, 30142
RCA	32532
Samsung	30199, 33195
Sharp	32250, 33313
Sherwood	32820, 33837
Sony	31516, 32180, 30772
Sylvania	30675
Tascam	34004
Toshiba	32705, 33157, 33857, 32551
VIZIO	32563
Yamaha	32298, 33871, 33837

## ■ DVD-R

Accurian	30675
AEG	30675
Akai	30675
Aristona	30646
CyberHome	31023
Denon	30490
Dick Smith Electronics	30675
DSE	30675
Emerson	30675
Funai	30675



## Reference Information

Go Video	30741
GPX	30741
Hitachi	31664
Humax	30646
Insignia	32095
Irradio	30646
JVC	30623, 32612
LG	30741
Loewe	30741
Magnavox	30675, 30646, 31506
Medion	30741
NEC	30741
Panasonic	30490, 31579, 33580, 32710, 32859, 32523
Philips	30646, 31340, 31506, 32334, 30539, 32056
Pioneer	30631
Pye	30646, 30675
RCA	30522
Samsung	31635, 32942, 33195, 32107, 30490, 32069, 32489
Schneider	30646
Sharp	33313, 30630, 30675, 30713
Silva Schneider	30741
Sony	31070, 31033, 32861, 31516, 31536, 32839, 32180, 31633
Sylvania	30675
Targa	30741
Tchibo	30741
TCM	30741
Thomson	30551
Toshiba	32277, 32551, 30503
Universum	30741

Yamaha	30646
Zenith	30741

## ■ VCR

DirecTV	20739
Humax	20739
Loewe	21062
Metz	21062
Optimus	21062
Panasonic	21062, 20616
Philips	20739
Quasar	21062
RCN	20739
ReplayTV	20616
Sonic Blue	20616
Sony	20636
TiVo	20739, 20636

## ■ Cable Set Top Box (A to E)

ABN	03322, 02897, 02979, 03340, 03407, 03849
Access Communications	01376, 00476
ACT	02950
Adams Cable TV	01376
ADB	02586, 01920, 01585, 01927, 01481, 01998, 02254, 02302, 02437, 03028
Akado	02043
Aland	02030, 02437
Alands	02030, 02437
Datakommunikation	
Alcom	02030, 02437
Alice	01585
Allegiance Communications	00476, 01376
Allen TV Cable	00476
Altibox	02437, 02030

Amino	01615, 01898, 01481, 02482, 01998, 02302, 03028
Anguang Network	03936
Anhui Network	03936
Arcadyan	02952
Arion	03336
Armstrong	01376, 00476
Arris	02187, 01982, 01998, 02378
Arvig Communication Systems	01376, 01982, 01998, 02345
Astound Broadband	01376, 01877, 00476, 02479, 04079
AT&T	00858
AT&T U-verse	00858
Atlantic Broadband	01877, 01376
ATMC	01376, 01982, 03028
Austar	00276
B tv	02681, 03442
Baja Broadband	00476, 01376
BBTV	02980
Beijing	04010
Belgacom TV	02047, 02132
Bell	01998
Bell Aliant	01998
Bell ExpressVu	01998
Bell Fibe TV	01998
Bend Broadband	01376, 00476, 02187
BesTV	04196
Bevcomm	01898, 00476
BGCTV	03278, 00476
BIG.BOX	03465
Blue Ridge Communications	01877
Bluewin	02271
Bouygues Telecom	03007
Boxer	03607
Bright ClouDigital	03961

Bright House	01877, 01376, 00476
British Telecom	02294
Broadstripe	00476, 01376
BSI	02979
BT	02294
BT Vision	02294
Buckeye Cable System	01376, 00476, 01877, 02187
C&M	03407, 03319, 02962, 02979
Cable America	01376, 01877
Cable Axion Digitel	01376, 00476
Cable HK	01374
Cable One	01376, 00476, 01877
Cablecom	01582
Cablecom Mexico	00476, 01376
Cablemas	01376, 01877
Cablevision	01877, 01376, 03336, 00476
Cabovisao	02436, 02493
Caiway	02015, 03607, 02762, 00660, 02447
Caiyun Digital	03961
CalTel Connections	02254, 02586
Canal Digital	02030
Canby Telcom	01481, 02302
Cass Cable	00476, 01376
CC9	02703, 02752, 03474
CCAP	01877
CCS	03322
Celrun	03442, 02682
CenturyLink	01998
Channel Master	03118
Charter	01877, 01376, 00476, 02187, 03560
Chengde Guangtong	03936
Chengdu Cable	03953
Chengdu Telecom	04196



## Reference Information

China Telecom	04196, 02913, 03937
China Unicom	04366, 04196
Chongqing Cable	03954
Chongqing Cable Networks	03954
CHT	03647, 01917
Chunghwa	03647, 01917
Cincinnati Bell	01877, 01376
Cisco	01877, 00858, 03028, 01982, 02132, 02345, 02589, 01883, 01998, 01582, 02047, 02378, 02563, 02401, 02742, 03265, 02271, 02947, 03452
Citycable	03451, 03477
CJ	03322, 02897, 02979, 03340, 03407, 03849
CJ Digital	02979, 02897, 03322, 03340, 03407, 03849
CJ HelloVision	03322, 02897, 02979, 03340, 03407, 03849
Claro	01376, 00476
ClubInternet	02132
CMA Communications	01376
CMB	03389, 02979, 03498
CMBTV	03498
CNS	02980, 02350
Cogeco	01376, 01982, 00476
Com Hem	00660, 02447, 02832, 02015
Comcast	01982, 01376, 00476, 01877, 03560, 02187

Comporium	01877, 03560, 02187
Consolidated Communications	01877, 01376, 01998, 02302, 03048
Coship	01991, 02950, 03278, 04162, 04408, 04196
Cosmic	02897
Cox	01877, 01376, 00476
CTS	02703, 03474
Daeryung	01877
Darty Box	02436
DASAN	02683
Delta	03607, 02015, 00660, 02447, 02762
DEN	02726
Deutsche Telekom	02132
Digeo	02187
Digi	02762, 03479
Digicable	03382, 02479
DigitAlb	02493
Director	00476
Dmg	03835
DNA	02832, 00660, 02030
Dom.ru TV	02493
Dream Satellite TV	02493
DSD	03340
DST	03389
Du	02401
DV	02979
Eagle Communications	01376, 02187
EastLink	01376, 00476
Echostar	02955, 03452
Elion	03916
Entertain	02132
Entone	02302, 03048
ER Telecom	02493
eTb	04281

Evolution	02479, 02746, 04079
Extra TV	02132
<b>■ Cable Set Top Box (F to J)</b>	
Fastway	03382
FCTV	01782, 02703
Fidelity Communications	01376
Finnet	02030, 02832
First Media	03783
Freebox	01976
Frontier Communications	02378
Fujian Broadcast & TV Network Group	04195
Fujian Broadcast and TV	04195
Gangwon Broadcasting Network	03407
Gansu Cable	04236
GCI	01376
GCS	03322
GDCATV	02980, 03131, 03132
Gehua	03278, 00476
General Communications	01376
General Instrument	00276, 00476
Google	03666
Gospell	04205
Grande Communications	01877, 03560, 01376
Great Plains Communications	01376
Guangdong Cable	02980, 03131, 03132
Guangxi Broadcasting	02897, 03407, 03961
Guangxi Broadcasting Network	02897, 03407, 03961
Guangzhou Cable	02945

Guizhou Broadcasting Network	03946
Hana TV	02681, 03442
Hathw@y	02043, 02726
Hawaiian Telcom	03028
HBC	01376, 01877, 01982, 02979, 03322, 03340, 03849
HCN	02979, 03340
HD+	03607
HDT	03465
Hebei Broadcasting	04026, 03967
Hebei Broadcasting Network	04026, 03967
Hebei Digital TV	04205
Hello TV	03322
HelloD	02979
Henan Cable	04034
HickoryTech	01898, 02302
Hikari TV	03237
Himawari TV	01760
Homecast	02977, 02979, 03389
Hong Kong Cable	01374
Hrvatski Telekom	02132
HSBONG	03965, 03937, 04026
Huashu	04034
Huawei	02994, 03278, 03937, 01991, 02913, 04281, 01982
Humax	03607, 02762, 02043, 02447, 00660, 01981, 01983, 02620, 02832, 03560, 02165, 02683, 02701, 02889, 02715, 02962, 03051, 03053, 03075, 03319, 03849





## Reference Information

Hunan Cable Net	04205
HYA	02989
Hyroad	02979
HyTV	02979, 03340
Hyundai Digital Technology	03465
HZRTV	02960
I-Cable	01374
i-CAN	01585, 02437
I-Digital	03319, 02979
IMBTVN	04106
INESA	03865
Innovative Systems	01898
Inotel	02437
Inter Mountain Cable	01877, 02479, 04079
Invitel	02437
InviTV	02437
iTSCOM	02703
ITV	02979, 03389, 04196, 03498
J:COM	01760, 02703, 03925, 01782, 02701, 02700, 02715, 02752, 03051, 03053
Jambox	02030
JBC	02979, 03322, 03340, 03849
JCN North	02703, 01760, 03474
Jerrold	00276, 00476
Jiangsu Cable Network	04022
Jilin Broadcasting	04009
Jilin Cable	04009
Jinan Radio and Television Network	04206
Jishi Media	04009
Jiuzhou	01991
JP PTT	01615
JXCN	03948

## ■ Cable Set Top Box (K to N)

Kabel Deutschland	03514, 01981, 01983, 02165, 03607, 02620
KabelBW	02889, 01981, 01983
KabelNoord	02015
Kaon	02493, 02889, 02746, 03407, 04409, 02682, 02979, 03389
kbro	02350, 03139
KCN-TV	02703
KCT	01760, 02703, 02752, 03474
KCTV	02979, 03340, 03389, 03849, 03322
KCTV JEJU	02979, 03340, 03389, 03849
KCTV-KJ	02979, 03340, 03389, 03849
KDMC	03319, 02979
Kiryung	03498
Kiss	02132, 02271
KoolConnect	01481
KPN	02952, 02437
Kreatel	02030
KT	02683, 03478
Lattecom	02030
LG	03340, 02682, 03407, 02979, 03389, 03319
LG U+	02682
Linksys	02271
Lishui Huashu	04034
Longyan Broadcasting Cable & Tv	04195
Lumos Networks	01998, 03028
Magio Sat	02132
Magnet	01615
Maige TV	03937
Massillon Cable	00476, 01376
Matanuska Telephone Association	01481, 02254, 02482, 02586

Mediacom	01376, 00476, 01982, 01877
Mediastream	01376, 00476
Mega	02683
Mega TV	02683
Megacable	01376, 00476
Meo	02401
MetroCast Cablevision	01376, 01982, 00476
Mi-Connection	01877
Midcontinent Communications	01376, 00476, 01982
Mid-Hudson Cable	00476, 01376
Minerva Networks	03118
MIO	02275, 02802
mio TV	02275, 02802
Mitsubishi Electric	03274
MOD	03647, 01917
Motorola	01376, 00476, 02378, 02437, 01998, 02030, 00858, 01982, 02952, 00276, 01562, 02275, 03916, 01585, 04034, 02401
Movistar	01585, 03288
Moxi	02187
Moyo	03611
MTS	01998, 03611, 01615, 01481, 01898
MyLGTV	02682
NET	01883
NewWave Communications	00476, 01376, 02187
NIB	03322
Ningde Cable TV	04195
Noos	02436
Northland Communications	01376
Novus	01376, 00476
Now TV	02009, 02014
NTL	01060, 00276

NTT	03237, 03274
NTV Plus	02762
NU Telecom	01998, 03028
Numericable	02436

## ■ Cable Set Top Box (O to S)

O2	02586
OCN	03865
Oi TV	03452, 03454, 04165
Olleh TV	02683, 03478
Olleh-Skylife	02683, 03478
Ono	01562
Open IPTV	01615
Optimum	01877
Optimus Clix	02437
Optus	00276, 01060
Orange	02407
Oriental Cable Networks	03865
Pace	01376, 01060, 02620, 01982, 01877, 01998, 00858, 01582, 01883, 03454, 02294, 02401
Panasonic	02703, 02752, 03474, 01760, 01782, 01982
Parasat	03479
Paul Bunyan Communications	02254, 02586
PCCW	02009, 02057
Philips	01582, 02378, 03560, 02294
Pioneer	01782, 01877, 03925, 02700
Pioneer Telephone	02254, 02302
Portugal Telecom	02401
Premiere	02620
Primacom	02889
Primestar	02030



## Reference Information

PrimeTel	03611, 02030, 02437
PrimeTV	02030
PT	02401
PTCI	01376
PX	03348
Qook TV	02683, 03478
Qook-Skylife	02683, 03478
Qrix	03465, 02979
QuickLine	02493
Qwerty	01898, 01481, 01615
Qwerty.TV	01898
RCN	01376, 00476, 03560
Reach Broadband	01376, 01877, 01982
Reliance	02556
RIO Media	02030
Rogers	01877, 01376
Rostelecom	03611
Sagem	02407, 02436, 03288
Sagemcom	03514, 02407, 02436, 03007, 03288
Samsung	03322, 02979, 03319, 01877, 02407, 02015, 03340, 03407, 03451, 03442, 03477, 02610, 02955, 01060, 02683, 03514, 03783, 02589, 02889, 02962, 03265, 03849, 03928, 01982, 01987
SaskTel	01998
SBN	03965

Scientific Atlanta	01877, 00858, 01982, 02401, 02345, 01987, 02047, 02436, 03028, 02378
SCTV	02493
SCV	02950
Seokyoung	03340
Service Electric	01376, 00476, 01982
SetaBox	01917
Shaanxi Broadcasting	03965
Shanghai	03865
Shanghai OCN	03865
Shanxi Broadcasting Network	03965
Shaw	01376, 01877, 00476, 02187, 01982
Shenzhen Broadcasting	01991, 04162
Shenzhen Digital TV	01991, 04162
Shijiazhuang Broadcasting	04026
Shimanto CATV	02752
Sichuan Broadcasting	03953
SingTel	02275, 01998, 02802
Siti Digital	03664
SK Broadband	03442, 02681
SK Btv	02681, 03442
Sky Austria	02620, 02447, 02832
Sky Deutschland	02620, 02447, 02832
SkyCable	02950, 03521, 03527, 04177
SkyLife	02683, 03478
Skyworth	03298, 02960, 03278, 01991, 03521, 04177, 03946, 04162
Smartlabs	03611
Smile Content	02437

SMT	03527
SMtronics	03319
Sogetel	01998, 02482
Sonaecom	02437
Sonera	00660
Source Cable	01376, 00476
Starcat	02703, 01782
StarHub	01927, 00276
Stipte	01898
Stofa	02015
Suddenlink	01877, 01376, 01982, 03560, 00476
Supercable	00276
Supercanal	01376, 00476
Suwon Cable	03319
Suzhou Cable Network	04022
SVA	03865
Swisscom	02271
SXBCTV	03965

## ■ Cable Set Top Box (T to Z)

TalkTalk	02994
Tbaytel	03028
Tbroad	03319
TCC	04409, 04408
TCN	03340, 02703
T-Com	02132
TDC	02271
TDS Telecom	03028
Technicolor	01982, 02994, 03288
TechniSat	03316
Tele2	00660, 02447
Telecentro	00476, 01376
TeleColumbus	02889
Telefonica	01585, 03028, 03288, 02586
Telekom Deutschland	02132
Telenet	01920, 03451, 03477
Telewest	01987

Telia	02030
Telmex	01376
TELUS	03028
TFN	03127, 03139
T-Home	02132
Thomson	01582, 01981, 01982, 01983, 03007, 02407
T-Hrvatski Telekom	02132
Tianjin Broadcast & TV Network	04010
Tianjin Broadcasting	04010
Time Warner	01877, 01376, 00476, 02187
TiVo	03560, 03265
ToongTV	03322
Top	03766
TopTV	01991
TP	02407
Trans PX	00276
True Visions	03075, 02762
TVB	01615
TVS Cable	01376, 01877, 01982
U+	02682
U+ tvG	02682
UCATV	02703, 01760
Unitymedia	02955, 02610, 03451, 03477
UPC	01582, 03451, 03477, 00660, 01060
UPC Cablecom	01582, 03451, 03477
US Electronics	00276
U-verse	00858
Vector	02030
VeeTV	03231
Verizon	02378
Viasat	02030
Videotron	01877, 02947
Viken Fibernett	02030, 02437



## Reference Information

Virgin Media	01987, 02563, 01060, 03265, 00276
Visionetics	01374
Vivo	03288
Vodafone	02401
Volia	02493
Volia Cable	02493
Voo	02742
VTR	01376
wasu	04034
Wave Broadband	01376, 00476, 02479, 04079
Wavevision	01376, 01877, 01982
Wbox	02832
WEHCO Video	01376
Welho	02832
WellAV	03479
Westman Communications	01376, 00476, 02187
WideOpenWest	01376, 01877, 02187
Windjammer Cable	00476, 01376, 01877
WNC	03118
WOW!	01877, 01376, 00476, 02187, 02479
Xfinity	01376, 01982, 00476, 01877, 03560, 02187
Xuyi Radio & TV	02897
YBN	03322
YCV	02703, 01760
Youview	02994
Yunnan Broadcasting	03961
Yuxing	02014
Zhong Hua Dian Xin	01917

Ziggo	02589, 03607, 02015, 02762, 00660, 02401, 02447
Zinwell	03139
Zito Media	01376, 01982
ZTE	04196

## ■ Satellite Set top Box

@sat	01300
@Sky	01334
1.Sky	03538
Acoustic Solutions	01284
ADB	02553, 00887, 01887
AEG	02738, 02813
Agora	01284
Airis	02813, 03012
Airtel	02248
Akai	02938
Akira	02738
Akta	01986
Akura	01626
Alba	01284, 02034, 02568
Allvision	01334
Altech UEC	02059, 02097, 03517
Amiko	04197
Amstrad	00847, 01662, 01175, 01693, 02467
AMTC	02738, 02813
Ansonic	02418
Aonvision	02279
Apro	01672
Argos	02568
Arion	03374, 04348
Arnion	01300
Arris	00869
AS	01284

ASA	00740
ASCI	01334
ASDA	01284
AssCom	00853
Astrell	01986, 02418
Astro	00173, 01838, 02627, 00658, 03838, 01099, 01100, 02026
Atevio	02928
Atlanta	02418, 03320
Atom	02289
Audiola	03012, 02418
Audioline	01672
Aurora	00879
Austar	00879
Austriasat	01195, 01197, 02957, 03374, 01561, 01631, 02631
Auvisio	02932, 02738, 02813
Avanit	00299, 01631
Awa	02418
Axil	02418, 01413, 01777, 02738, 03424
Axitronic	01626
AZ America	01631
AZBox	02719
B.net	01672
B@ytronic	00740
Beijing	03299
Bell	00775
Bell ExpressVu	00775
Bell Fibe TV	00775
Bell Satellite TV	00775
Belson	02418
BENsat	02957, 02938
Best Buy	02728, 02842
BIG TV	04312
BIOSTEK	02738

BiS Television	01986
Black Diamond	01284
Blaupunkt	00173
Blu:sens	02938
Boca	02026, 02458, 02797, 02308, 02813
Boshmann	01413, 01631
Botech	02738, 03749
Boxer	02443, 01692, 01957, 04024
Brainwave	00658, 01672
BSkyB	01175, 01662, 00847
Bulltech	02738
Bush	01935, 02376, 01284, 02813, 01672, 03346, 03439, 02034, 03652, 01291, 01626, 02418, 02568
Cablecom	01195, 01197
Caiway	02443, 00253
Canal Digitaal	02631, 00853, 02466, 02957
Canal Digital	02553, 01780, 00853, 01334
Canal+	00853, 02657, 01195, 01197, 01986
CanalSat	00853, 02657
Century	03110, 00856
CGV	02034, 01413, 01986
Chess	02026, 01334, 01626
Signal	02289, 02835, 02836
CityCom	00299, 00658, 02957
Clarke-Tech	03320



## Reference Information

Claro	03787, 03790
Classic	01291, 01284, 01672
Clatronic	01413, 02738
Clayton	01626
CME	00173
CMX	02205, 02932
Cobra	02728, 03012
Com Hem	01176, 01915
Comag	02797, 02026, 02458, 02813, 02308, 01413
Comsat	01413
Comwell	01956
Continent	01986
Coship	03787, 03790, 01672, 02525, 03574
Cosmos TV	01545
Croner	02813
Crown	01284
Crypto	03012
Crystal	03012, 01416
Cyfra+	00853, 01409
Cyfrowy Polsat	02262, 02527, 00253, 00853
Dantax	01626
Danystar	02938
DASAN	03321
D-box	01114
DCR	03517
Delta	02443
Denver	02418, 02738
Deutsche Telekabel	01195, 01197
Dgtec	01631, 02418
Dick Smith Electronics	02418, 02813
Dicra	02738, 02842, 03012
Digenius	00299, 00740
Digi	01416, 01195, 01197, 02026
Digi Raum Electronics	02622

Digi Romania	01416
Digitality	01334, 02813
Digihome	02034, 01284, 01935
DigiLogic	01284, 02034
DigiQuest	02278, 02738, 01300, 01631
Digital	02308
DigitAlb	01195, 01197
DigitalBox	02540, 01631, 02289, 01100, 03240
DigitSat-e	02842
Digiturk	03517, 02097
Digiwave	01631
Dikom	02938, 02842
Dilog	01957, 01780
DiPro	02278
DirectTV	01377, 01442, 00099
Dish Mexico	00775
Dish Network	00775
DishHD	04090
Dishpro	00775
DishTV	01300, 02604, 01780
Di-Way	02289
DMT	03321
DMTech	02738
DNA	01780, 01957, 01176, 02144
Donghai	02938
Doro	01672
DragonSat	02928
DRE	02622
Dream	01237
Dream Multimedia	01237, 01652, 01923
Dream Satellite TV	01416, 03374
DSE	02418, 02813
D-Smart	02231

DSTV	00879, 02059, 02060
DTI Electronics	02938
DTK Deutsche	01195, 01197
Telekabel	
DTV	03572
Dual	02034
Durabrand	01284, 02034
Dyon	02738, 02813
Easy-One	03240
Echostar	00775, 02262, 02527, 00853, 01409
Eco-Star	01413
Edision	01631
Ekotech	03422
Elap	01413
Elbe	02418
Electron	01956
Elisa	01322, 02455
Elless	00740
Elta	02738
Embratel	02796, 03787
Energy Sistem	02418, 01631, 02289, 02813
Engel	03749, 01611, 01672
Etisalat	02443
Europhon	00299, 01334
Eurosat	01611, 01413
Eurosky	00740, 00299
Eutra	00740
Evesham Technology	02034
Eycos	03374
F&U	03012
Fagor	01611
FaVal	03422
Ferguson	02638, 01291, 01803, 01935, 02034
Finepass	01780
Finlux	01626, 02034

Finnnet	01780, 01957
FinnSat	00740, 01195, 01197, 01351
FMD	01413
Fortec Star	01631
Foxtel	01356, 00879, 01176
Freesat	01692, 02928, 03266, 01986, 02376
Freesat+	02443, 03266
freeview	02982
Fte Maximal	02289
Fuba	02750, 00173, 00299, 03726
Fuji Onkyo	02728, 01631
Funai United	03012
Galaxis	00853, 00879
Galaxy	01956
Galaxy Innovations	02799, 04197
General Instrument	00869
General Satellite	03064, 02622
Gi	02799, 04197
GigaBlue	03663
GigaTV	02738
Globo	02026, 01334, 00740, 01429, 02957, 01626
GMMZ	03538
Go	01780
GoGen	02738
GOI	00775
Gold Box	00853
Gold Vision	01631
Golden Media	04197
GoldMaster	01334, 02928
Goodmans	01284, 02376, 02034, 03652, 02568, 03346, 03439
Gradiente	00887, 03110, 00856



## Reference Information

Gran Prix	00740
Grandin	01626
Grocos	01409
Grundig	00173, 00847, 02376, 01291, 02034, 00853, 02813, 01284, 01780, 02738, 03424, 00879, 01672, 02568, 03346
GVT	03789
Haier	02418
Hailo	02289
Hallo	01626
Handan	01780, 01957
Hanseatic	01099, 01100
Hauppauge	01672
HD Box	02928
HD+	02797, 02443, 01429, 02569, 03095
HDT	01416, 01255, 03321
Hirschmann	00173, 00299, 02026, 00740
Hitachi	02034, 01284
Homecast	02525
Hornet	01300
HTS	00775
Huawei	03787
Huaxian Radio and Television Network	04041
Hubei Chutian	04041
Hubei Radio & Television Network	04041
Hughes Network Systems	01442, 01377

Humax	01176, 02443, 01427, 01808, 02736, 01882, 01915, 03140, 02231, 02408, 02144, 02616, 02754, 01377, 03517, 01989, 02289, 03321, 01255
Hyundai	01416
Hyundai Digital Technology	01416, 01255, 03321
ibox	01652
IceCrypt	04197, 02838, 02928
ID Digital	01176
ID Sat	02289, 01334, 01631
i-Joy	02938
Illusion	01631
Imagin	01195, 01197
Imperial	01195, 01197, 01334, 01429, 01672
InDigital	01416
Indovision	01989, 00856, 01887, 02108, 00887, 01255
iNETBOX	01652, 01237
Inno Hit	01626, 02728
Innova	00099
Intv	04348
Inverto	03095
inVion	02418
iotronic	01413
IP Vision	02455
IPM	03567
IQ	02813
IQ Prism	02813
ISkyB	00887
ITT	02418

Jaeger	02797, 01334
Jameson	02813
Jerrold	00869
Jiuzhou	03140
JVC	00775, 01284
Kabel Deutschland	01195, 01197, 01672, 01882, 01915
KabelBW	01882, 01915, 01195, 01197, 01429
KabelNoord	00253, 02443
Kamosonic	02738
Kaon	01300, 02231
Kathrein	01561, 02569, 00658, 00173, 03658, 01416, 02263
Kenwood	00853
Konig	02289, 01631, 00173
Koscom	01956
KPN	01986
Kreiling	00658, 01626
Kreismeyer	00173
KT	03321
L&S Electronic	01334
Labgear	03424
LaSAT	00740, 00299
Lava	01631
Lazer	02738
Leiker	02728
Leiko	01626
Lemon	01334
Lenoxx	01611
LG	03321
Lifesat	00299
LinkBox	02957
Linsar	01284, 02842
Listo	01626, 02813
Lodos	01284

Logik	02034, 01284, 01906, 02842, 01803, 03652
LogiSat	02797, 02026, 02813, 02458
Lorenzen	00299
Lowry	02938
Luxor	01935, 02034
M vision	03562
M7	02631
Macab	00853
Magic TV	02982
Majestic	03012, 02738, 02842
Manhattan	01300
Maplin	02034
Marusys	02799, 03543
Mascom	02738
Maspro	00173, 03099
Matsui	01284, 00173, 01626
Maximum	01334, 02813, 01672, 01986
Mediabox	00853
MediaSat	00853
Mediascape	02289, 02835, 02836
Mediaset	02750, 02278, 01427, 02736, 02739
Medion	00299, 00740, 01626, 01334, 02026, 02797
Mega TV	03321
MegaSat	01631, 02034, 02813, 02289, 00740, 02738
Melita	01416
Meo	02466
Mercury	03422



## Reference Information

Metronic	01986, 02418, 02738, 01334, 01631, 01413, 01672, 01935, 02278
Metz	00173
Micro	02797, 02813
Micro electronic	02308, 02813
Micromaxx	00299
Microstar	00299
Miraclebox	02928
Mitsai	02738
Morgan's	02026
Motorola	00869, 03110, 00856, 03469
Movistar	02527, 02262, 02263
MTEX	03539
Multichoice	00879, 02059, 02060
Murphy	02034
Mx Onda	02938
myfreeviewHD	02982
Mysat	02738
MySky Italia	02467
MySky New Zealand	01356, 02211
Nagra	02262
NanoXX	01631
NC+	00853, 01409
NEOTION	01334
NET	02262
Netgem	01322, 02455
Netsat	00099, 00887
Neuf TV	01322
Neuling	02458, 02026
Nevir	02938, 02728
Next	02231
Next Level	00869
Nextvision	01956
NextWave	01956

Nilox	02278
Nokia	00853
Nordmende	01611
Noru	02938
Nova	02475, 00879
NPG	02289, 01413, 01631
NTV Plus	01307, 01692, 02443
Octagon	02928
Olleh TV	03321
Olleh-Skylife	03321
Onn	02034, 01284
Openbox	01956, 02928
Opensat	02957, 01956, 02719
Opentech	02525
Opentel	02525
Optex	01626, 01413, 01611, 03012
Opticum	02957, 02797, 02932
Optus	01356, 00879
Orbis	01334
Orbitech	01195, 01100, 01197, 01099, 01351
Orchid	02289
Orion Express	01986
Orton	02957
P&T Luxembourg	01322, 02455

Pace	00847, 00887, 01356, 02754, 01682, 01175, 01693, 02475, 00853, 02231, 02467, 02631, 02657, 03469, 03790, 01377, 01662, 02097, 02211, 02059, 02060, 02466, 02796, 02160
Pacific	01284
Palcom	01611, 00299, 01409
Palsonic	02813
Panasat	00879
Panasonic	03494, 00847, 03099
Panda	00173
peekTon	02418
Philips	00099, 00853, 02561, 01499, 01442, 02466, 01114, 01672, 02619, 02211, 03110, 03469, 00173, 00856, 00887, 02631
Phoenix	01956, 02418
Phonotrend	01780
Pino	01334
Pioneer	00853
Pixel Magic	02982
PLDT	02835, 02836, 02289
PMB	01611
Polsat	02262, 02527, 00253, 00853
Portugal Telecom	02466
Premiere	01429, 01114, 01195, 01197

PremiumX	03374
Primacom	01176, 01195, 01197
Pro Basic	00853
ProLine	01284
PSI	03539
PT	02466
QooK TV	03321
Qook-Skylife	03321
Quelle	00299
Qwest	01377
RadioShack	00869
Radix	01255
Raduga TV	01986, 02957
RCA	01291, 01442, 02108
RCS	01416
Rebox	02928
RiksTV	01692
Rimax	02938
RIO Media	01780
Roadstar	00853
Rollmaster	01413
Ross	02540
SAB	01956, 01631, 04197, 01300
Saba	00740, 02205
Sagem	01692, 01690, 01114, 02553, 01307
Sagemcom	01692, 04024, 03789
Saivod	02418
Samart DTH	03576, 03574



## Reference Information

Samsung	03063, 00253, 01442, 01377, 02467, 01682, 01989, 03266, 00853, 01662, 02525, 03321, 03784, 03834, 03838, 01255, 01693
Sansui	01545
Sanyo	01626
Sat Control	01300
Sat Industrie	01611
SAT+	01409
SatCatcher	01956
Satforce	03374
Satplus	01100
SatyCon	01631
Schaub Lorenz	02034, 02418
Schneider	02842
Schwaiger	01672, 01429, 02308, 02458, 01631, 02797, 02813, 00740, 01334, 02957
Schwaiger CS	01631
Scott	02738
SCS	00299, 00740
Sede	01626
Sede Electronique	01626
SEG	01626, 01284, 02034
Sencor	02813
Servimat	01611
Set-One	03240, 02728
Shark	01631
Sharp	01935, 02034
Shaw Direct	00869
Sherwood	01409
Shinelco	02738, 02278, 02938

SHOI	02938
Siemens	00173, 01657, 01429, 02418, 01626, 01334, 01672
Sigmathek	02418, 02813, 02738
SignalMAX	01956
Silva	00299
Silva Schneider	00740
SilverCrest	02026, 02308, 02458, 02932
SKY	01662
Sky Austria	02754, 02443, 01429, 01114, 01915, 01195, 01197
Sky Brasil	01377, 03110, 00887, 00856, 00099, 01499, 02619
Sky Deutschland	02754, 02443, 01429, 01114, 01915, 01195, 01197
Sky Ireland	01175, 01662, 00847
Sky Italia	01693, 02467, 00853
Sky Mexico	00856, 02619, 00887, 01377, 03469
Sky New Zealand	02211, 00887, 00856, 01356
SKY PerfecTV!	03099, 02616, 03049
Sky UK	01175, 01662, 00847
SkyCable	01631, 01957
SkyLife	03321, 01255

Skylink	02957, 01545, 02443, 02928, 01195, 01197, 01986
Skymaster	01409, 02205, 01611, 02728, 02932, 01545, 01334
Skymax	01413
Skypex	00740
Skyplus	01334, 02026, 00740, 01175
SkySat	01100
Skytec	02928
Skyvision	02797, 01334
SkyWay	02928
Skyworth	01631, 02835, 02836
SL	00740, 02026, 00299, 01672
SM Electronic	01409
Smart	01631, 01413, 03095, 02289, 00740, 00299
Sogo	02842
Sonera	01780, 01957
Sony	01558, 00847, 00853, 03049
Spiderbox	03562
Star	00887
Star Choice	00869
Starmax	02638
Steinner	02738
Stream System	01300
Strong	01409, 02235, 01626, 02278, 02418, 02813, 00879, 03424, 00853, 01300, 03374, 01284, 01682

Sun Box	03571
Sun Direct	02525
Sunny	01300
Sunstech	02738
Supernova	00887
Supratech	01413
Systec	01334
Sytech	02418, 02842, 03012
S-ZWO	03374
TATA Sky	03575
TBoston	02418
TDS Telecom	00775
Teac	01957, 01322, 02813
Technical	01626
Technicolor	03469, 03790
Technika	01284, 01672, 02034
TechniSat	01197, 01195, 01100, 01099, 01351, 03440, 02813, 01322
Technoit	02278
Technosonic	01672
Technotrend	01429, 01672, 02263
Techwood	01284, 02034, 01626, 01935
Tecsat	01986
TEKCOMM	02738
Telasat	02466
TELE System	02750, 01611, 01409, 02739, 03726, 02813
Tele2	01195, 01197
Telefonica	01692, 02262, 02527, 02263
TeleSAT	02631, 02466



Reference Information

Telestar	01100, 01099, 01334, 01197, 02540, 01195, 01351, 01626, 01672
Televés	01300, 01334
Televisa	00887
TelkomVision	04310
Telsey	02738
TelSKY	02540
Telstra	01356
TELUS	00775
Tesla	01626
Tevion	02205, 01409, 01672, 02026, 02813
Thai	03573, 03539
Thomson	01291, 01935, 01662, 00847, 00853, 01175, 02278, 01307, 02160, 02619, 03110, 03469
Tiny	01672
Titan	02205
Tividi	01429
TiVo	01377, 01442
TivuSat	02750
T-Mobile	02631, 02443, 01545
TNT SAT	01692, 01195, 01197, 01986
Tokai	02938
Tonna	01611, 02458
Topfield	01545, 01986, 01208, 02838
Toshiba	01803, 01284, 01429
TPS	01307
Transparent Video Systems	01780, 01957

TrekStor	02738
Triax	01291, 01626, 00853, 01099, 01611, 01631
Tricolor TV	02622, 03064
True Visions	03140, 01208, 02408, 03784
TT-micro	01429
TV Cabo	02160
TV Star	03012
TV Vlaanderen	02631, 00853, 02466
TVA Digital	02895, 01692, 02262
TVB	01989
TVonics	01906, 01803
Twinner	01611
UEC	00879, 01356
UfaNet	01986
UNE	01692
United	02842, 02278, 03012, 01626, 02418
Unitymedia	01429, 01882, 01915
Universum	00173, 00299, 00740, 01099
Unixbox	01652
UPC	01780, 02443
UPC Cablecom	01195, 01197
UPC Direct	02443
Vantage	02797
Variosat	00173
VEA	02418
Vectra	01195, 01197
Vestel	01626, 01284, 02231, 02034, 03517
VH Sat	00299
Via Embratel	03787, 02796

Viasat	01682, 01197, 01195, 02235, 00253
Videocon	03077
Vietnam Television Corporation	03834
Viola Digital	01672
Vision	01626
VisionNet	01631
Visiosat	01413
Vistron	00740
Vitecom	01413
Viva	00856
Vivax	02418
Vivo	02262, 02895, 01692, 02527
Volcasat	02418
Voom	00869
VTC	03834
Vu+	03458, 02799, 03543
Walker	02034
Wavelength	01413
Wharfedale	01935, 02034, 01284, 01906
Winix	02278
Wintel	00299
Wisi	00740, 00173, 00299, 02957, 01986
Woxter	02418, 02813
Xoro	02813, 02738, 03012, 03422
Xtreme	01300
Xtrend	03320
Yakumo	01413
Yes	00887, 01887
Youview	03140
ZapMaster	00740

Zehnder	01777, 03422, 01334, 01413, 02289, 03424, 02034, 00740, 01631
Zenega	02604
Zenith	00856, 03110, 03469
Ziggo	02443, 01499, 01657, 00253
Zircon	02957
Zodiac	03726
Zon	02160
Zon Optimus	02160

■ Video - Accessory

A.C.Ryan	02709, 03350
ABS	01272
Acer	01272
Alienware	01272
Apple	02615
ASRock	01272
Boxee	03693
Cetion	01272
Claritas	01272
CyberPower	01272
Daily Media	01272
Dell	01272
Digitech	02260
D-Link	03671, 03693, 02186
Elonex	01272
Eminent	03215, 02260
Emtec	02709
Fantec	03350, 02709
Fujitsu Siemens	01272
Funai	03339
Gateway	01272
G-Box Midnight	04440
Hewlett Packard	01272





Reference Information

hFX	01272
Howard Computers	01272
HP	01272
Hush	01272
iBUYPOWER	01272
iconBIT	03350, 02709
ICY Box	03350
iNext	03350
Iomega	02558
ISTAR	02260
JadooTV	02260
Keedox	04442
LG	03373
Linksys	01272
Magnavox	03339
Mede8er	02709
Media Center PC	01272
Micca	03669
Microsoft	01272, 01805, 04000
Mind	01272
Netgear	03324, 04401, 03292
NiveusMedia	01272
Northgate	01272
Omniverse	04421
Packard Bell	01272
Panasonic	03760
Philips	01272
Pivos	04339
PopBox	02260
Popcorn Hour	02260
RCA	03335
Ricavision	01272
Roku	03061, 02371
Seagate	02698
Sony	02713, 01272
Stack 9	01272
Sumvision	04339
Systemax	01272

Tagar Systems	01272
Toshiba	01272
Touch	01272
TrekStor	02723
Trust	01272
VIA Technologies	01272
Viewsonic	01272
VIZIO	03670
Voodoo	01272
Western Digital	02558
Woxter	02709
Xbox	01805, 04000, 01272
Xtreamer	02723
ZT Group	01272

■ CD

A.V.International	70157
ADVANTAGE	70032
AH!	70157
Aiwa	70157
Arcam	70157
Atoll	70157
Atoll Electronique	70157
Audio Research	70157
Audiolab	70157
Audiomeca	70157
Audioton	70157
AVI	70157
Balanced Audio Technology	
BAT	70157
Cairn	70157
California Audio Labs	70029, 70303
Cambridge	70157
Cambridge Audio	70157
Carver	70157
CCE	70157
Curtis Mathes	70029

Cyrus	70157
Denon	70766
DKK	70000
DMX Electronics	70157
Dynaco	70157
Epworth	70157
Genexxa	70032, 70000
Goldmund	70157
Grundig	70157
Harman/Kardon	70157, 73044
HIFIAkademie	70157
Hitachi	70032
JVC	70072
Integra	71817
Kenwood	70036, 70157
Krell	70157
Linn	70157
Loewe	70157
Magnavox	70157
Marantz	70157, 70029
Matsui	70157
MCS	70029
Memorex	70032
Meridian	70157
Micromega	70157
Miro	70000
Mission	70157
Myryad	70157
NAD	70721, 70000
Naim	70157
New Acoustic Dimension	70721, 70000
NSM	70157
Onkyo	71817
Optimus	70032, 70000
Panasonic	70303, 70029
Philips	70157
Pioneer	70032
Polk Audio	70157

Primare	70157
Proton	70157
QED	70157
Quad	70157
Quasar	70029
Radiola	70157
RCA	70032
Restek	70157
Revox	70157
Rotel	70157
SAE	70157
Sansui	70157
SAST	70157
Siemens	70157
Silsonic	70036
Simaudio	70157
Sonic Frontiers	70157
Sony	70000, 70490
Sylvania	70157
TAG McLaren	70157
TAG McLaren Audio	70157
Tandy	70032
Tascam	73095, 73511, 73533
Teac	73095, 73531, 73532, 73551
Technics	70303, 70029, 70207
Thorens	70157
Thule Audio	70157
Universum	70157
Victor	70072
Wards	70032, 70000, 70157
Yamaha	70036, 70032, 70490
Zonda	70157

■ Cassette Deck



Reference Information

Aiwa	40029
Arcam	40076
Audiolab	40029, 40229
Carver	40029
Denon	40076
Epworth	40029
Grundig	40029
Harman/Kardon	40029
Inkel	40070
JVC	40244
Kenwood	40070
Magnavox	40029
Marantz	40029
Myryad	40029
Onkyo	42157
Optimus	40027
Panasonic	40229
Philips	40029, 40229
Pioneer	40027
Polk Audio	40029
Radiola	40029
RCA	40027
Revox	40029
Sansui	40029
Sony	40243, 40170
Tascam	73095
Technics	40229
Thorens	40029
Universum	40029
Victor	40244
Wards	40027, 40029
Yamaha	40097

■ Receiver

Integra	52503
Onkyo	52503

■ Audio - Accessory

Apple	81115
-------	-------

Jamo	82228
Onkyo	81993, 82990, 82351, 82352, 82353
Polk Audio	82228

■ IPTV

ADB	02586, 01585, 01481, 01998, 02254, 02302, 02437, 03028
Aland	02030, 02437
Alands Datakommunikation	02030, 02437
Alcom	02030, 02437
Altibox	02437, 02030
Amino	01615, 01898, 01481, 02482, 01998, 02302, 03028
Arcadyan	02952
Arkwest	02482, 01481, 01998, 02302
Arris	01998, 02378
Arvig Communication Systems	01998, 02345
AT&T	00858
AT&T U-verse	00858
ATMC	03028
B tv	02681, 03442
BBTV	02980
BEK Communications	02254, 02302
Belgacom TV	02047, 02132
Bell	01998
Bell Aliant	01998
Bell ExpressVu	01998
Bell Fibe TV	01998
BesTV	04196
Bluewin	02271
Bouygues Telecom	03007

British Telecom	02294
BT	02294
BT Vision	02294
Cabovisao	02436
CalTel Connections	02586
Canal Digital	02030
Canby Telcom	01481, 02302
Celrun	03442
CenturyLink	01998
Channel Master	03118
China Telecom	04196, 02913, 03937
China Unicom	04366, 04196
CHT	03647, 01917
Chunghwa	03647, 01917
Cisco	00858, 03028, 02132, 02345, 02047, 02378, 01998, 02271, 03452
ClubInternet	02132
CNS	02980
Consolidated Communications	01998, 02302, 03048
Coship	04196
Deutsche Telekom	02132
DNA	02030
Du	02401
Echostar	03452
Elion	03916
Entertain	02132
Entone	02302, 03048
eTb	04281
Everttek	02302
Finnet	02030
Freebox	01976
Frontier Communications	02378
GDCATV	02980
Google	03666

Guangdong Cable	02980
Guangxi Broadcasting	02897
Guangxi Broadcasting Network	02897
Hana TV	02681
Hathw@y	02043
Hikari TV	03237
HSHONG	03937
Huawei	02994, 03937, 02913, 04281
i-CAN	02437
Innovative Systems	01898
Inotel	02437
Invitel	02437
InviTV	02437
ITV	04196
Jambox	02030
JP PTT	01615
Kaon	04409, 02682
kbro	03139
Kiss	02132, 02271
KoolConnect	01481
KPN	02952, 02437
Kreatel	02030
KT	02683
LG	02682
LG U+	02682
Linksys	02271
Lumos Networks	01998, 03028
Magio Sat	02132
Magnet	01615
Maige TV	03937
Matanuska Telephone Association	01481, 02254, 02482, 02586
Mega TV	02683
Meo	02401



## Reference Information

MHTC	01481, 01998, 02254, 02302, 02482
Minerva Networks	03118
MIO	02275, 02802
mio TV	02275, 02802
Mitsubishi Electric	03274
MM&G Enterprises	01481, 01998, 02302, 02482
MOD	03647, 01917
Motorola	02378, 02437, 01998, 02030, 00858, 02952, 02275, 03916, 01585, 02401
Movistar	01585, 03288
Moyo	03611
MTS	01998, 03611, 01615, 01481, 01898
MyLGTV	02682
Now TV	02009, 02014
NTT	03237, 03274
NU Telecom	01998, 03028
Numericable	02436
Oi TV	03452, 03454, 04165
Open IPTV	01615
Optimus Clix	02437
Orange	02407
Pace	01998, 00858, 03454, 02294, 02401
PCCW	02009, 02057
Philips	02378
Pioneer Telephone	02254, 02302
Portugal Telecom	02401
Primestar	02030
PrimeTel	02030, 02437, 03611
PrimeTV	02030

PT	02401
Qwerty	01898, 01481, 01615
Qwerty.TV	01898
Reliance	02556
RIO Media	02030
Rostelecom	03611
Sagem	02407, 03288
Sagemcom	02436, 02407, 03007
Samsung	02407
SaskTel	01998
Scientific Atlanta	00858, 02345, 02047, 02401, 03028, 02378
SetaBox	01917
SingTel	02275, 01998, 02802
SK Broadband	03442, 02681
SK Btv	02681, 03442
Sky Austria	02620
Sky Deutschland	02620
Smartlabs	03611
Smile Content	02437
Sogetel	01998
Sonaecom	02437
SureWest	01998, 01481, 02254, 02482, 02586
Swisscom	02271
TalkTalk	02994
TCC	04409
TDC	02271
Technicolor	02994
Telefonica	01585, 03028, 03288
Telekom Deutschland	02132
Telia	02030
TELUS	03028
TenNeT	01898

T-Home	02132
Thomson	03007, 02407
TVB	01615
U+ tvG	02682
U-verse	00858
Verizon	02378
Viasat	02030
Viken Fibernet	02030, 02437
Vivo	03288
Vodafone	02401
WNC	03118
Youview	02994
Yuxing	02014
Zinwell	03139
ZTE	04196

## ■ IPTV PVR Combination

ADB	01585, 02254, 02437
Altibox	02437
Amino	01615, 01898
Arcadyan	02952
Arris	01998, 02378
AT&T	00858
AT&T U-verse	00858
ATMC	03028
BBTV	02980
Belgacom TV	02047, 02132
Bell	01998
Bell Aliant	01998
Bell ExpressVu	01998
Bell Fibe TV	01998
Bluewin	02271
Bouygues Telecom	03007
British Telecom	02294
BT	02294
BT Vision	02294
Cabovisao	02436
Canal Digital	02030

CenturyLink	01998
CHT	03647
Chunghwa	03647
Cisco	03028, 02132, 00858, 02047, 02345, 02271, 02378, 03452
ClubInternet	02132
CNS	02980
Consolidated Communications	01998
Deutsche Telekom	02132
Du	02401
Echostar	03452
Elion	03916
Entertain	02132
Entone	03048
Freebox	01976
Frontier Communications	02378
GDCATV	02980
Glashart Media	01615, 01898
Google	03666
Guangdong Cable	02980
Hikari TV	03237
Huawei	02994
i-CAN	02437
Innovative Systems	01898
Invitel	02437
InviTV	02437
Kaon	04409
kbro	03139
Kiss	02132, 02271
KPN	02952, 02437
Linksys	02271
Lumos Networks	01998
Magio Sat	02132
Magnet	01615
Meo	02401
MetroNet	01998



## Reference Information

Minerva Networks	03118
Mitsubishi Electric	03274
MOD	03647
Motorola	01998, 02437, 02378, 02952, 00858, 03916, 01585, 02030, 02401
Movistar	01585
MTS	01998, 01615, 01481, 01898
NTT	03237, 03274
Numericable	02436
Oi TV	03452, 03454, 04165
Orange	02407
Pace	00858, 01998, 03454, 02294, 02401
Philips	02378
Portugal Telecom	02401
PrimeTel	02437
PT	02401
Qwerty	01898
Sagem	02407, 03288
Sagemcom	02436, 03007, 02407
Samsung	02407
SaskTel	01998
Scientific Atlanta	00858, 02047, 02401, 02345, 03028, 02378
Sky Austria	02620
Sky Deutschland	02620
SureWest	01998
Swisscom	02271
TalkTalk	02994
TCC	04409
TDC	02271
Telefonica	01585, 03028, 03288

Telekom Deutschland	02132
TELUS	03028
T-Home	02132
Thomson	03007
U-verse	00858
Verizon	02378
Vodafone	02401
WNC	03118
Youview	02994
Zinwell	03139

## ■ SAT\_PVR Combination

@sat	01300
ADB	02553
AEG	02738, 02813
Airtel	02248
Altech UEC	02097, 03517
Amiko	04197
Amstrad	01662, 01175, 02467, 01693
Arion	04348
Astro	03838
Atevio	02928
Atlanta	03320
Austriasat	01195, 01197, 02957, 02631
Auvisio	02932, 02738, 02813
Avanit	00299
Axil	03424
AZ America	01631
AZBox	02719
B@ytronic	00740
Bell	00775
Bell ExpressVu	00775
Bell Fibe TV	00775
Bell Satellite TV	00775
BENsat	02957
Boca	02797, 02308, 02813

Botech	02738, 03749
Boxer	01957
BSkyB	01175, 01662
Bush	02034
Canal Digitaal	02631, 02466, 02957
Canal Digital	02553
Canal+	02657
CanalSat	02657
CityCom	02957
Clarke-Tech	03320
Claro	03790
CMX	02932
Comag	02797, 02813, 02308
Coship	03790
Cyfrowy Polsat	02527
DCR	03517
Deutsche Telekom	01195, 01197
Digenius	00740
Digi	01195, 01197
Digihome	02034
DigiQuest	01300
Digital	02308
DigitAlb	01195, 01197
DigitalBox	02540, 03240
Digiturk	03517, 02097
Dilog	01957
DirecTV	01377, 01442, 00099
Dish Mexico	00775
Dish Network	00775
DishHD	04090
Dishpro	00775
DNA	01957
DragonSat	02928
Dream Multimedia	01237, 01923
D-Smart	02231
DSTV	02059, 02060

DTK Deutsche Telekom	01195, 01197
Dyon	02738, 02813
Easy-One	03240
Echostar	00775, 02527
Edision	01631
Elta	02738
Engel	03749
Etisalat	02443
Eurosky	00740
FaVal	03422
Ferguson	02638
Finnet	01957
Foxtel	01356
Freesat	01692, 02928, 03266
Freesat+	02443, 03266
Fuji Onkyo	01631
Galaxy Innovations	02799, 04197
General Satellite	03064
Gi	02799, 04197
GigaBlue	03663
Globo	02957
Golden Media	04197
GoldMaster	02928
Goodmans	02034
Grundig	02738, 03424
GVT	03789
Handan	01957
HD Box	02928
HD+	02797, 03095
Hirschmann	00740
Hitachi	02034
Hughes Network Systems	01442
Humax	02443, 01176, 01377, 03517, 01427, 01808, 02231, 02408, 02754



## Reference Information

IceCrypt	04197, 02928
ID Sat	01334
Indovision	01989
iNETBOX	01237
Intv	04348
Inverto	03095
Jaeger	02797
JVC	00775
Kamosonic	02738
Kaon	01300
Kathrein	02569, 01561, 03658, 00658
Labgear	03424
LaSAT	00740
LinkBox	02957
LogiSat	02797, 02813
Luxor	01935
M vision	03562
M7	02631
Marusys	02799, 03543
Maspro	03099
Maximum	01334, 02813
Medion	02797, 00740
MegaSat	01631, 02813, 02034, 02738
Meo	02466
Mercury	03422
Micro	02797, 02813
Micro electronic	02308
Miraclebox	02928
Motorola	00869
Movistar	02527
Multichoice	02059, 02060
Mysat	02738
MySky Italia	02467
MySky New Zealand	01356, 02211
NEOTION	01334
Nova	02475
NTV Plus	01307, 01692, 02443

Octagon	02928
Openbox	02928
Opensat	02957, 02719
Opticum	02957, 02797, 02932
Orbitech	01195, 01197
Orton	02957
Pace	01682, 01175, 02754, 02475, 02231, 01356, 02467, 02631, 02657, 03790, 01662, 02097, 02211, 02059, 02060, 02466, 02895
Panasonic	03099
Philips	01442, 02466, 00099, 02631
Polsat	02527
Portugal Telecom	02466
PT	02466
Qwest	01377
Raduga TV	02957
RCA	01442
Rebox	02928
Ross	02540
SAB	04197
Sagem	01692, 02553, 01307
Sagemcom	03789, 01692
Samsung	03063, 01442, 01682, 01989, 02467, 01377, 03266, 01662, 03784, 03838, 01693
Sansui	01545
Sat Control	01300
Schwaiger	02308, 00740, 02957

SEG	02034
Set-One	03240
Sharp	02034, 01935
Shaw Direct	00869
Siemens	01657
SilverCrest	02308, 02932
Sky Austria	02754, 02443
Sky Brasil	01377
Sky Deutschland	02754, 02443
Sky Ireland	01175, 01662
Sky Italia	02467, 01693
Sky New Zealand	02211, 01356
SKY PerfecTV!	03099
Sky UK	01175, 01662
SkyCable	01631, 01957
Skylink	02957, 01545, 02443, 02928, 01195, 01197
Skymaster	02932, 01545
Skypex	00740
Skyplus	00740, 01175, 01334
Skytec	02928
Skyvision	02797
SkyWay	02928
Skyworth	01631
SL	00740
Smart	03095, 01631
Spiderbox	03562
Star Choice	00869
Starmax	02638
Stream System	01300
Strong	03424, 01300, 02813, 01682, 02278
Sunny	01300
TDS Telecom	00775
Teac	01957
Technicolor	03790

TechniSat	01197, 01195, 03440
Technotrend	01429
Techwood	02034
Telasat	02466
Telefonica	01692, 02527
TeleSAT	02631, 02466
Telestar	02540, 01195, 01197
TelkomVision	04310
TelSKY	02540
Telstra	01356
TELUS	00775
Thomson	01662, 01175, 01935, 01307, 02160
TiVo	01377, 01442
T-Mobile	02631, 02443, 01545
TNT SAT	01692
Topfield	01545, 02838
TPS	01307
Tricolor TV	03064
True Visions	03784
TV Cabo	02160
TV Vlaanderen	02631, 02466
TVA Digital	02895
TVonics	01906
UPC	02443
UPC Direct	02443
Vantage	02797
Vestel	02231, 03517
Via Embratel	02796
Viasat	01682, 01197, 01195
Vivo	02895, 01692, 02527
Vu+	03458, 02799, 03543
Wisi	00740, 02957



## Reference Information

Xoro	02738, 02813, 03422
Xtreme	01300
Xtrend	03320
Zehnder	03422, 03424, 01777, 02034, 00740
Ziggo	02443
Zircon	02957

## ■ TV\_DVD Combination

AEG	12197, 12239
Affinity	13870, 13717
Akai	12676, 13067, 12197
Akura	12289, 11983, 12239
Alba	12676, 13005, 13067, 12104
Apollo	12239
Audiosonic	12104, 11983
Audiovox	11769
Azuki	12239
Baier	12239
Bauer	12197
Beko	12239
Black Diamond	11037
Blaupunkt	12426
Blue Sky	11037
BlueDiamond	12426
Bush	13005, 12676, 11983, 12104, 10698, 11037
Celcus	12676
cello	12673
Centrum	11037
Coby	13627, 12315
Crown	11037
Currys Essentials	12486

Curtis	12855, 12466, 13895, 13636, 14035
Dantax	12676
Denver	12197, 13067, 12239
DGM	12239
Digihome	12676
Digimate	12239
Digitrex	13067
diVision	12197, 12239
Dual	12197, 12676, 11037
Durabrand	10171
D-Vision	12197
Dynex	12049
Easy Living	12104
ECG	12197, 12125
Electrohome	11670
Element	12964
Elfunk	11037
Emerson	11886, 11864, 11394, 10171
e-motion	12426
Enox.	12673
Essentials	12486
Favi	13382
Ferguson	13005, 12426, 11037, 12676
Finlux	12676
Funai	11394
Goodmans	11983, 11037, 11687, 12676, 12426
Gran Prix	12197
Grundig	12239, 12125, 12676
Haier	11753, 12309, 13429, 11749, 11983
Hantarex	12197

Hikona	11983
Hisense	13519
Hitachi	12676, 11037, 11667
Hyundai	12676
Ingo Devices	12239
Insignia	12049
iSymphony	13429
Jay-tech	13067
JMB	12676
JTC	13067
JVC	12271, 11670, 11774, 12676, 11601
Kuppersbusch	12676
Lenco	12676, 11983
LG	11860, 11423
Linetech	12676
Linsar	12676
Logik	13432, 13005, 12486, 11037, 11687
Luxor	12676, 11037
Magnavox	12372, 11866, 11454
Marks & Spencer	12673
Mascom	12197
Matsui	12486, 12676, 11037
Medion	12676, 12239, 13067
Memorex	11670
Memory	11983
MTlogic	12104
Murphy	12673
Mx Onda	11983
Naxa	12104, 13382
Neon	12673
Nikkei	12197
Nimbro	12104

Nordmende	13835
OK.	13434, 12676
OKI	12676
Orava	11037
Orion	11037, 12676
Otic	11983
Palsonic	13067
Panasonic	11291, 12170, 11636, 11480
Panavox	13835
Philips	13614, 12800, 10556, 11454, 11394, 12372
PHOENIX Apollo	12239
Polaroid	11769, 11523, 12676
Powerpoint	10698
Prima	11753
Pro Vision	12197
ProLine	12676
Proscan	12256, 13895, 13636
Prosonic	12676, 12197
QuantumFX	12337
RCA	12187, 12746, 12932, 11447, 12247, 13382
RefleXion	12239
Reoc	12197
Saba	12676
Saga	12197
Salora	12197, 12676, 12239
Sandstrom	12197
Sansui	11670, 13564
Sanyo	12676, 13488
Sceptre	12528, 12337
Schaub Lorenz	12197, 12289
Scott	11983
SEG	12673, 11037



Reference Information

Sencor	12197
Sharp	10818, 12676, 12360
Shinelco	12104
Shivaki	12197
Skyworth	12963
Soniq	12493, 13005
Sontech	11983
Sony	12778, 10000
Soundwave	11037, 12673
SOVOS	12239
Supersonic	11753, 12104
Swisstec	12106, 12104
Sylvania	11886, 11864, 11394, 10171
Taurus	12197
Teac	10698, 11983, 13005
Technica	11037, 12426
Technical	12676
Technika	12426, 12197, 12106, 11983, 13005
Techwood	12676
Telefunken	12239, 10698, 12676
Teletech	11037
Tesco	12426
Tevion	12426
Thomson	12675, 10625, 13047
Toshiba	13323, 12676, 11524, 11656
TVE	12239
UMC	12426, 12106
United	11037, 11983
VD-Tech	13067
Venturer	13005
Vestel	11037
Viewsonic	12049

Viore	13429, 12352, 12104, 13382, 13118
VisionPlus	12426
Walker	12676
Waltham	11037
Weltstar	11037
Westinghouse	11712
Wharfedale	11983
Xiahua	11753
Xiron	11983, 11037
Xoceco	11753
Xogego	11753
Xoro	13067
Zenith	10000, 10178
Xogego	11753
Xoro	13067
Zenith	10000, 10178



# ONKYO

## Onkyo Corporation

Kitahama Chuo Bldg, 2-2-22 Kitahama, Chuo-ku, OSAKA 541-0041, JAPAN

<http://www.onkyo.com/>

## The Americas

### Onkyo U.S.A. Corporation

18 Park Way, Upper Saddle River, N.J. 07458, U.S.A.

For Dealer, Service, Order and all other Business Inquiries:

Tel: 201-785-2600 Fax: 201-785-2650

<http://www.us.onkyo.com/>

For Product Support Team Only:

1-800-229-1687

<http://www.us.onkyo.com/>

## Europe

### Onkyo Europe Electronics GmbH

Liegnitzerstrasse 6, 82194 Groebenzell, GERMANY

Tel: +49-8142-4401-0 Fax: +49-8142-4208-213

<http://www.eu.onkyo.com/>

### Onkyo Europe Electronics GmbH (UK Branch)

Meridien House, Ground floor, 69 - 71 Clarendon Road, Watford, Hertfordshire, WD17 1DS, United Kingdom

Tel: +44 (0)8712-00-19-96 Fax: +44 (0)8712-00-19-95

## China

### Onkyo China Limited (Hong Kong)

Unit 1033, 10/F, Star House, No 3, Salisbury Road, Tsim Sha Tsui Kowloon, Hong Kong.

Tel: 852-2429-3118 Fax: 852-2428-9039

<http://www.hk.onkyo.com/>

### Onkyo China PRC (Mainland)

302, Building 1, 20 North Chaling Rd., Xuhui District, Shanghai, China 200032,

Tel: 86-21-52131366 Fax: 86-21-52130396

<http://www.cn.onkyo.com/>

## Asia, Oceania, Middle East, Africa

Please contact an Onkyo distributor referring to Onkyo SUPPORT site.

<http://www.intl.onkyo.com/support/>

The above-mentioned information is subject to change without prior notice.

Visit the Onkyo web site for the latest update.

SN 29402024PDF\_EN

(C) Copyright 2015 Onkyo Corporation Japan. All rights reserved. Onkyo has the Privacy Policy. You can review it at [<http://www.onkyo.com/privacy/>].

F1504-0



\* 2 9 4 0 2 0 2 4 \*





## Free Manuals Download Website

<http://myh66.com>

<http://usermanuals.us>

<http://www.somanuals.com>

<http://www.4manuals.cc>

<http://www.manual-lib.com>

<http://www.404manual.com>

<http://www.luxmanual.com>

<http://aubethermostatmanual.com>

Golf course search by state

<http://golfingnear.com>

Email search by domain

<http://emailbydomain.com>

Auto manuals search

<http://auto.somanuals.com>

TV manuals search

<http://tv.somanuals.com>