

ONKYO®

AV Receiver

TX-SR503

TX-SR503E

TX-SR8350

Instruction Manual

Thank you for purchasing an Onkyo AV Receiver. Please read this manual thoroughly before making connections and plugging in the unit. Following the instructions in this manual will enable you to obtain optimum performance and listening enjoyment from your new AV Receiver. Please retain this manual for future reference.

Contents

Introduction 2

Connection 15

Turning On & First Time Setup..... 30

Basic Operation

Playing your AV components 34

Using the Tuner..... 36

Enjoying the Listening Modes 42

Advanced Operation 46

Troubleshooting 55



WARNING:

TO REDUCE THE RISK OF FIRE OR ELECTRIC SHOCK, DO NOT EXPOSE THIS APPARATUS TO RAIN OR MOISTURE.

CAUTION:

TO REDUCE THE RISK OF ELECTRIC SHOCK, DO NOT REMOVE COVER (OR BACK). NO USER-SERVICEABLE PARTS INSIDE. REFER SERVICING TO QUALIFIED SERVICE PERSONNEL.



WARNING
RISK OF ELECTRIC SHOCK
DO NOT OPEN

AVIS
RISQUE DE CHOC ELECTRIQUE
NE PAS OUVRIR



The lightning flash with arrowhead symbol, within an equilateral triangle, is intended to alert the user to the presence of uninsulated "dangerous voltage" within the product's enclosure that may be of sufficient magnitude to constitute a risk of electric shock to persons.



The exclamation point within an equilateral triangle is intended to alert the user to the presence of important operating and maintenance (servicing) instructions in the literature accompanying the appliance.

Important Safety Instructions

1. Read these instructions.
2. Keep these instructions.
3. Heed all warnings.
4. Follow all instructions.
5. Do not use this apparatus near water.
6. Clean only with dry cloth.
7. Do not block any ventilation openings. Install in accordance with the manufacturer's instructions.
8. Do not install near any heat sources such as radiators, heat registers, stoves, or other apparatus (including amplifiers) that produce heat.
9. Do not defeat the safety purpose of the polarized or grounding-type plug. A polarized plug has two blades with one wider than the other. A grounding type plug has two blades and a third grounding prong. The wide blade or the third prong are provided for your safety. If the provided plug does not fit into your outlet, consult an electrician for replacement of the obsolete outlet.
10. Protect the power cord from being walked on or pinched particularly at plugs, convenience receptacles, and the point where they exit from the apparatus.
11. Only use attachments/accessories specified by the manufacturer.
12. Use only with the cart, stand, tripod, bracket, or table specified by the manufacturer, or sold with the apparatus. When a cart is used, use caution when moving the cart/apparatus combination to avoid injury from tip-over.

PORTABLE CART WARNING
S3125A
13. Unplug this apparatus during lightning storms or when unused for long periods of time.
14. Refer all servicing to qualified service personnel. Servicing is required when the apparatus has been damaged in any way, such as power-supply cord or plug is damaged, liquid has been spilled or objects have fallen into the apparatus, the apparatus has been exposed to rain or moisture, does not operate normally, or has been dropped.
15. Damage Requiring Service
Unplug the apparatus from the wall outlet and refer servicing to qualified service personnel under the following conditions:
 - A. When the power-supply cord or plug is damaged,
 - B. If liquid has been spilled, or objects have fallen into the apparatus,
 - C. If the apparatus has been exposed to rain or water,
 - D. If the apparatus does not operate normally by following the operating instructions. Adjust only those controls that are covered by the operating instructions as an improper adjustment of other controls may result in damage and will often require extensive work by a qualified technician to restore the apparatus to its normal operation,
 - E. If the apparatus has been dropped or damaged in any way, and
 - F. When the apparatus exhibits a distinct change in performance this indicates a need for service.
16. Object and Liquid Entry
Never push objects of any kind into the apparatus through openings as they may touch dangerous voltage points or short-out parts that could result in a fire or electric shock.
The apparatus shall not be exposed to dripping or splashing and no objects filled with liquids, such as vases shall be placed on the apparatus.
Don't put candles or other burning objects on top of this unit.
17. Batteries
Always consider the environmental issues and follow local regulations when disposing of batteries.
18. If you install the apparatus in a built-in installation, such as a bookcase or rack, ensure that there is adequate ventilation.
Leave 20 cm (8") of free space at the top and sides and 10 cm (4") at the rear. The rear edge of the shelf or board above the apparatus shall be set 10 cm (4") away from the rear panel or wall, creating a flue-like gap for warm air to escape.

Precautions

- 1. Recording Copyright**—Unless it's for personal use only, recording copyrighted material is illegal without the permission of the copyright holder.
- 2. AC Fuse**—The AC fuse inside the unit is not user-serviceable. If you cannot turn on the unit, contact your Onkyo dealer.
- 3. Care**—Occasionally you should dust the unit all over with a soft cloth. For stubborn stains, use a soft cloth dampened with a weak solution of mild detergent and water. Dry the unit immediately afterwards with a clean cloth. Don't use abrasive cloths, thinners, alcohol, or other chemical solvents, because they may damage the finish or remove the panel lettering.
- 4. Power**
WARNING
BEFORE PLUGGING IN THE UNIT FOR THE FIRST TIME, READ THE FOLLOWING SECTION CAREFULLY.
AC outlet voltages vary from country to country. Make sure that the voltage in your area meets the voltage requirements printed on the unit's rear panel (e.g., AC 230 V, 50 Hz or AC 120 V, 60 Hz).
Some models have a voltage selector switch for compatibility with power systems around the world. Before you plug in such a model, make sure that the voltage selector is set to the correct voltage for your area.
Setting the [STANDBY/ON] switch to STANDBY does not fully shutdown the unit. If you do not intend to use the unit for an extended period, remove the power cord from the AC outlet.
- 5. Never Touch this Unit with Wet Hands**—Never handle this unit or its power cord while your hands are wet or damp. If water or any other liquid gets inside this unit, have it checked by your Onkyo dealer.
- 6. Handling Notes**
 - If you need to transport this unit, use the original packaging to pack it how it was when you originally bought it.
 - Do not leave rubber or plastic items on this unit for a long time, because they may leave marks on the case.
 - This unit's top and rear panels may get warm after prolonged use. This is normal.
 - If you do not use this unit for a long time, it may not work properly the next time you turn it on, so be sure to use it occasionally.

Memory Backup

The AV receiver uses a battery-less memory backup system in order to retain radio presets and other settings when it's unplugged or in the case of a power failure. Although no batteries are required, the AV receiver must be plugged into an AC outlet in order to charge the backup system. Once it has been charged, the AV receiver will retain the settings for several weeks, although this depends on the environment and will be shorter in humid climates.

For British models

Replacement and mounting of an AC plug on the power supply cord of this unit should be performed only by qualified service personnel.

IMPORTANT

The wires in the mains lead are coloured in accordance with the following code:

Blue: Neutral

Brown: Live

As the colours of the wires in the mains lead of this apparatus may not correspond with the coloured markings identifying the terminals in your plug, proceed as follows:

The wire which is coloured blue must be connected to the terminal which is marked with the letter N or coloured black.

The wire which is coloured brown must be connected to the terminal which is marked with the letter L or coloured red.

IMPORTANT

The plug is fitted with an appropriate fuse. If the fuse needs to be replaced, the replacement fuse must be approved by ASTA or BSI to BS1362 and have the same ampere rating as that indicated on the plug. Check for the ASTA mark or the BSI mark on the body of the fuse. If the power cord's plug is not suitable for your socket outlets, cut it off and fit a suitable plug. Fit a suitable fuse in the plug.

For European Models

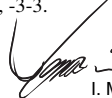
Declaration of Conformity	
We, ONKYO EUROPE ELECTRONICS GmbH LIEGNITZERSTRASSE 6, 82194 GROEBENZELL, GERMANY	
declare in own responsibility, that the ONKYO product described in this instruction manual is in compliance with the corresponding technical standards such as EN60065, EN55013, EN55020 and EN61000-3-2, -3-3.	
GROEBENZELL, GERMANY	 I. MORI
ONKYO EUROPE ELECTRONICS GmbH	

Precautions—Continued

For U.S. models

FCC Information for User

CAUTION:

The user changes or modifications not expressly approved by the party responsible for compliance could void the user's authority to operate the equipment.

NOTE:

This equipment has been tested and found to comply with the limits for a Class B digital device, pursuant to Part 15 of the FCC Rules. These limits are designed to provide reasonable protection against harmful interference in a residential installation.

This equipment generates, uses and can radiate radio frequency energy and, if not installed and used in accordance with the instructions, may cause harmful interference to radio communications. However, there is no guarantee that interference will not occur in a particular installation. If this equipment does cause harmful interference to radio or television reception, which can be determined by turning the equipment off and on, the user is encouraged to try to correct the interference by one or more of the following measures:

- Reorient or relocate the receiving antenna.
- Increase the separation between the equipment and receiver.
- Connect the equipment into an outlet on a circuit different from that to which the receiver is connected.
- Consult the dealer or an experienced radio/TV technician for help.

For Canadian Models

NOTE: THIS CLASS B DIGITAL APPARATUS COMPLIES WITH CANADIAN ICES-003.

For models having a power cord with a polarized plug:

CAUTION: TO PREVENT ELECTRIC SHOCK, MATCH WIDE BLADE OF PLUG TO WIDE SLOT, FULLY INSERT.

Modèle canadien

REMARQUE: CET APPAREIL NUMÉRIQUE DE LA CLASSE B EST CONFORME À LA NORME NMB-003 DU CANADA.

Sur les modèles dont la fiche est polarisée:

ATTENTION: POUR ÉVITER LES CHOCS ÉLECTRIQUES, INTRODUIRE LA LAME LA PLUS LARGE DE LA FICHE DANS LA BORNE CORRESPONDANTE DE LA PRISE ET POUSSER JUSQU'AU FOND.

Supplied Accessories

Make sure you have the following accessories:

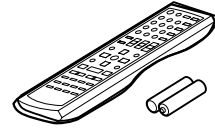

Remote controller & two batteries (AA/R6)

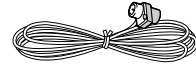

Indoor FM antenna

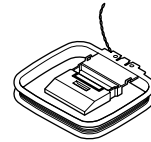

AM loop antenna

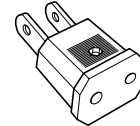

Power-plug adapter

Only supplied in certain countries. Use this adapter if your AC outlet does not match with the plug on the AV receiver's power cord. (Adapter varies from country to country.)

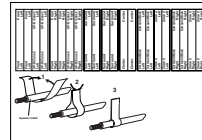

Speaker cable labels

- * In catalogs and on packaging, the letter at the end of the product name indicates the color. Specifications and operation are the same regardless of color.

Features

Amp

- 7-channel amplifier
- 75 watts per channel min. RMS at 8 Ω , 2 channels driven from 20 Hz to 20 kHz with no more than 0.08% total harmonic distortion
- WRAT (Wide Range Amplifier Technology)
- Optimum gain volume circuitry

Processing

- Dolby¹ Digital EX and Dolby Pro Logic IIx
- DTS, DTS-ES Matrix/Discrete, DTS Neo:6, and DTS 96/24 processing²
- Cinema Filter function
- Linear PCM 192 kHz/24-bit D/A converters on all channels
- Pure Audio listening mode (not North American model)
- Powerful and highly accurate 32-bit DSP Processing

Audio/Video

- Adjustable crossover (60, 80, 100, 120, 150 Hz)
- HDTV-capable component video (3 inputs, 1 output)
- 3 S-Video inputs, 2 outputs
- 4 assignable digital inputs (3 optical, 1 coaxial)
- Subwoofer pre out
- Color-coded multichannel input for use with Super Audio CD and DVD-Audio
- A/B speaker drive
- Color-coded speaker terminal posts

FM/AM Tuner

- 30 FM/AM presets
- FM/AM auto tuning
- RDS (Radio Data System) (Europe only)

Remote Controller

- Preprogrammed for use with other AV components

Table of Contents

Introduction

Important Safety Instructions.....	2
Precautions	3
Supplied Accessories	4
Features.....	5
Front & Rear Panels	6
Before Using the AV receiver.....	9
Remote Controller	10

Connection

Connecting Your Speakers.....	15
Connecting Antenna	18
Connecting the AV receiver	20

Turning On & First Time Setup

Turning On	30
First Time Setup	31

Basic Operation

Playing Your AV Components.....	34
Using the Tuner	36
Common Functions.....	40

Enjoying the Listening Modes

Using the Listening Modes.....	42
--------------------------------	----

Advanced Operation

Adjusting the Listening Modes	46
Recording.....	48
Advanced Setup	49
Controlling Other Components.....	52

Troubleshooting

55

Specification.....

58

1. Manufactured under license from Dolby Laboratories. “Dolby”, “Pro Logic” and the double-D symbol are registered trademarks of Dolby Laboratories.
2. “DTS,” “DTS 96/24,” “DTS-ES,” and “Neo:6” are trademarks of Digital Theater Systems, Inc.

Front & Rear Panels

Front Panel

North American Model

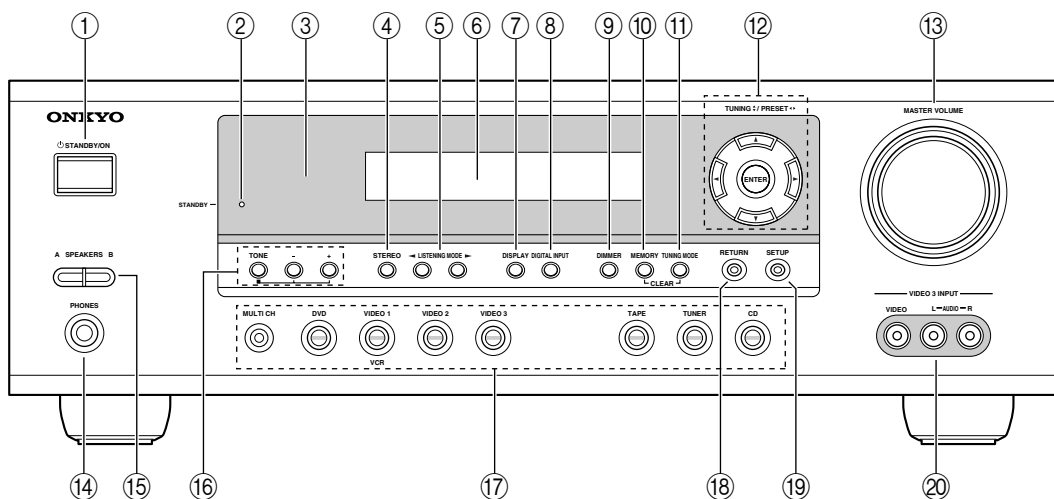

Other Models

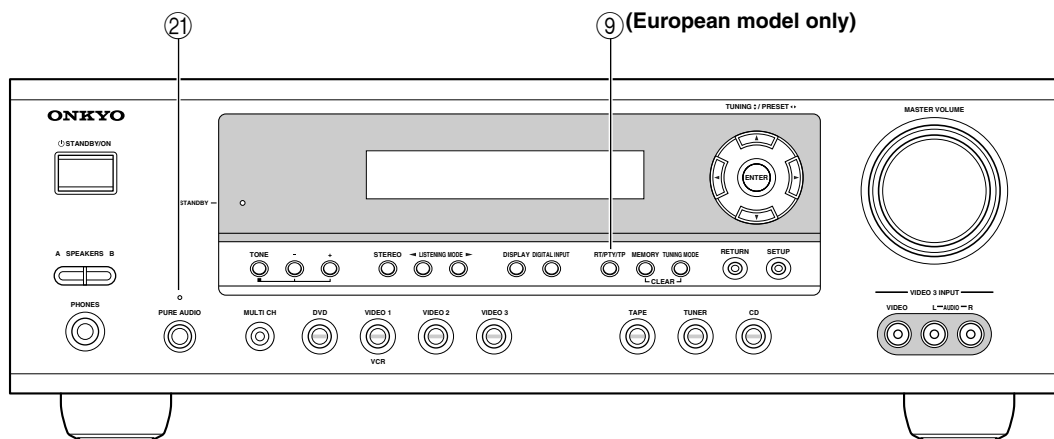

For detailed information, see the pages in parentheses.

- ① **STANDBY/ON button (30)**
This button is used to set the AV receiver to On or Standby.
- ② **STANDBY indicator (30)**
This indicator lights up when the AV receiver is in Standby mode, and it flashes while a signal is being received from the remote controller.
- ③ **Remote-control sensor (9)**
This sensor receives control signals from the remote controller.
- ④ **STEREO button (42)**
This button is used to select the Stereo listening mode.
- ⑤ **LISTENING MODE [◀]/[▶] buttons (42)**
These buttons are used to select the listening modes.
- ⑥ **Display**
See “Display” on page 7.
- ⑦ **DISPLAY button (35)**
This button is used to display various information about the currently selected input source.
- ⑧ **DIGITAL INPUT button (31)**
This button is used to assign the digital inputs and to specify the format of digital input signals.
- ⑨ **DIMMER or RT/PTY/TP button (39, 40)**
This button is used to adjust the display brightness. On the European model, this is the RT/PTY/TP button, and it’s used with RDS (Radio Data System). See “Using RDS (European models only)” on page 38.

Front & Rear Panels—Continued

- ⑩ **MEMORY button (37)**
This button is used when storing or deleting radio presets.
- ⑪ **TUNING MODE button (36)**
This button is used to select the Auto or Manual tuning mode.
- ⑫ **Arrow/TUNING/PRESET & ENTER buttons**
When the AM or FM input source is selected, the TUNING [▲] [▼] buttons are used to tune the tuner, and the PRESET [◀] [▶] buttons are used to select radio presets (see page 37). When the setup menus are used, they work as arrow buttons and are used to select and set items. The ENTER button is also used with the setup menus.
- ⑬ **MASTER VOLUME control (34)**
This control is used to adjust the volume of the AV receiver to MIN, 1 through 79, or MAX.
- ⑭ **PHONES jack (41)**
This 1/4-inch phone jack is for connecting a standard pair of stereo headphones for private listening.
- ⑮ **SPEAKER A & B buttons (34)**
These buttons are used to turn speaker sets A and B on or off.
- ⑯ **TONE, [-] & [+] buttons (40)**
These buttons are used to adjust the bass and treble.
- ⑰ **Input selector buttons (34)**
These buttons are used to select from the following input sources: MULTI CH, DVD, VIDEO 1, VIDEO 2, VIDEO 3, TAPE, TUNER, or CD.
The [MULTI CH] button selects the DVD analog multichannel input.
- ⑱ **RETURN button**
This button is used to return to the previously displayed setup menu.
- ⑲ **SETUP button**
This button is used to access various settings.
- ⑳ **VIDEO 3 INPUT (25, 48)**
This input can be used to connect a camcorder, games console, and so on. There are jacks for composite video and analog audio.
- ㉑ **PURE AUDIO button & indicator (42)**
The North American model doesn't have this button and indicator.
This button is used to select the Pure Audio listening mode. The indicator lights up when that mode is selected.

Display

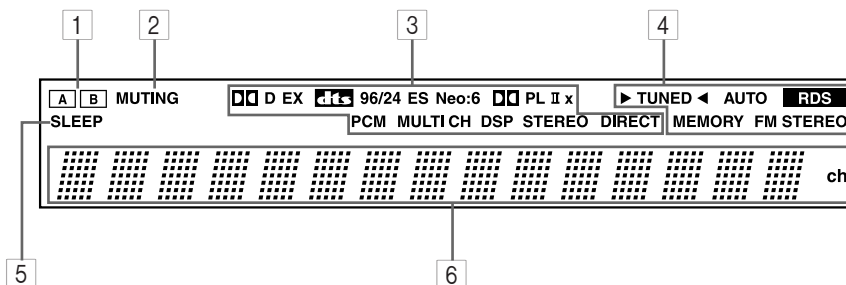

For detailed information, see the pages in parentheses.

- ① **A & B speaker indicators (34)**
Indicator A lights up when speaker set A is on. Indicator B lights up when speaker set B is on.
- ② **MUTING indicator (40)**
This indicator flashes when the AV receiver is muted.
- ③ **Source/listening mode indicators (44)**
These indicators show the currently selected listening mode and digital audio format.
- ④ **Tuning indicators (36)**
TUNED (36): This indicator lights up when the AV receiver is tuned to a radio station.
AUTO (36): This indicator lights up when Auto Tuning is selected and disappears when Manual Tuning is selected.
- RDS (European model only) (38):** This indicator lights up when the AV Receiver is tuned to a radio station that supports RDS (Radio Data System).
- MEMORY (37):** This indicator lights up when pre-setting radio stations.
- FM STEREO (36):** This indicator lights up when the AV receiver is tuned to a stereo FM station.
- ⑤ **SLEEP indicator (41)**
This indicator lights up when the Sleep function has been set.
- ⑥ **Message area**
This area of the display shows various information about the currently selected source.

Rear Panel

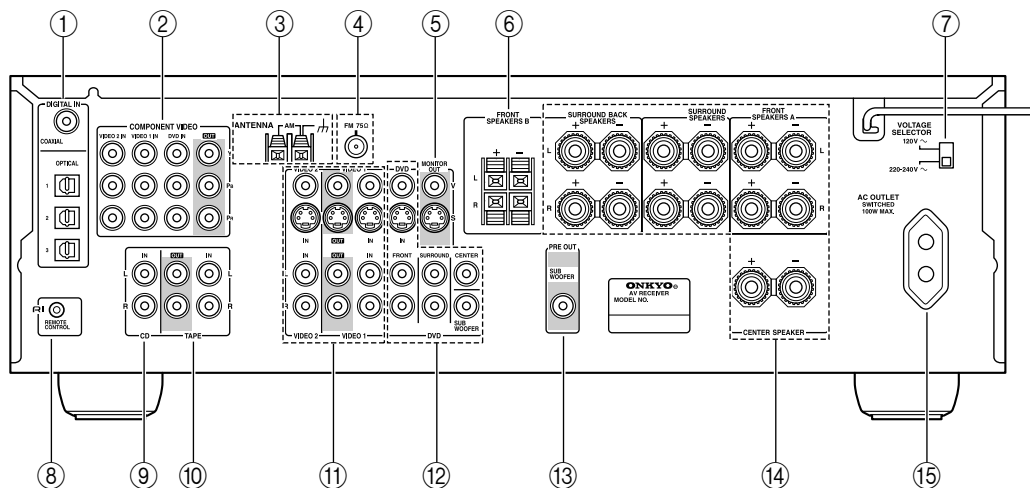

① **DIGITAL IN OPTICAL 1, 2, 3 & COAXIAL**

These optical and coaxial jacks can be used to connect a CD or DVD player and other components with digital audio outputs.

② **COMPONENT VIDEO**

A DVD player, TV, or other component that supports component video can be connected here.

③ **AM ANTENNA**

These push terminals are for connecting an AM antenna.

④ **FM ANTENNA**

This jack is for connecting an FM antenna.

⑤ **MONITOR OUT**

The S-Video or composite video output should be connected to a video input on your TV or projector.

⑥ **FRONT SPEAKERS B**

These push terminals are for connecting speaker set B.

⑦ **VOLTAGE SELECTOR (only some models)**

This voltage selector provides compatibility with power systems around the world.

⑧ **RI**

This **RI** (Remote Interactive) jack can be connected to the **RI** jack on another Onkyo component. The AV receiver's remote controller can then be used to control that component. To use **RI**, you must make an analog audio connection (RCA) between the AV receiver and the other component, even if they are connected digitally.

Note:

RI can only be used with Onkyo components.

⑨ **CD IN**

These analog inputs can be used to connect a CD player with analog outputs.

⑩ **TAPE IN/OUT**

These analog inputs and outputs can be used to connect a cassette recorder, MiniDisc recorder, or other recorder with analog inputs and outputs.

⑪ **VIDEO 1 IN/OUT & VIDEO 2 IN**

The VIDEO 1 S-Video, composite video, and audio inputs and outputs can be used to connect a VCR. The VIDEO 2 S-Video, composite video, and audio inputs can be used to connect another video source (e.g., cable TV, satellite TV, or a set-top box).

⑫ **DVD IN/MULTI CH INPUT**

The FRONT, SURROUND, CENTER, and SUBWOOFER jacks can be used to connect a component with an analog multichannel audio output, such as a DVD player with a 5.1-channel analog output. The S-Video or composite video input should be connected to a video output on the DVD player.

⑬ **SUBWOOFER PRE OUT**

A powered subwoofer can be connected here.

⑭ **FRONT SPEAKERS A, SURROUND SPEAKERS, CENTER SPEAKER & SURROUND BACK SPEAKERS**

These terminal posts are for connecting speaker set A.

⑮ **AC OUTLET**

This switched AC outlet can be used to supply power to another component. The connector type depends on the country in which you purchased your AV receiver.

See pages 15–29 for connection information.

Before Using the AV receiver

Setting the Voltage Selector (on some models)

Some models have a voltage selector switch for compatibility with power systems around the world. Before you plug in this model, make sure that the voltage selector is set to the correct voltage for your area. If it isn't, use a small screwdriver to set it as appropriate. For example, if the voltage in your area is 120 volts, set the selector to "120V." If it's between 220 and 230 volts, set it to "220-230V."

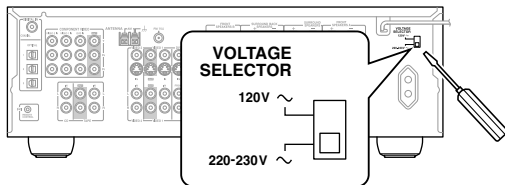

Installing the Batteries

- 1 To open the battery compartment, press the small hollow and slide open the cover.

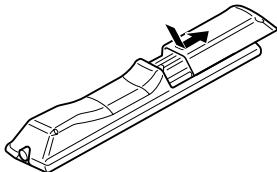

- 2 Insert the two supplied batteries (AA/R6) in accordance with the polarity diagram inside the battery compartment.

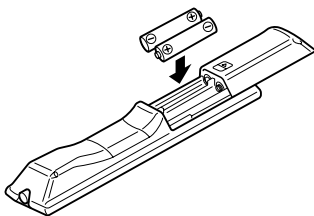

- 3 Slide the cover shut.

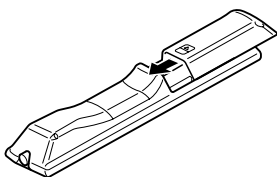

Notes:

- The batteries should last for about six months, although this will vary with usage.
- If the remote controller doesn't work reliably, try replacing the batteries.
- Don't mix new and old batteries or different types of batteries.
- If you intend not to use the remote controller for a long time, remove the batteries to prevent damage from leakage or corrosion.
- Expired batteries should be removed as soon as possible to prevent damage from leakage or corrosion.

Using the Remote Controller

To use the remote controller, point it at the AV receiver's remote control sensor, as shown below.

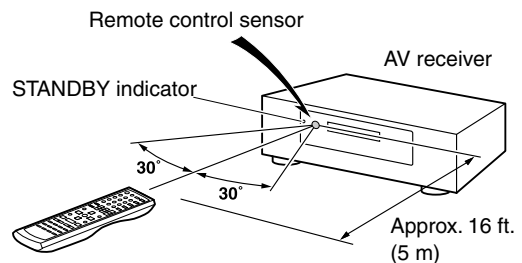

Notes:

- The remote controller may not work reliably if the AV receiver is subjected to bright light, such as direct sunlight or inverter-type fluorescent lights. Keep this in mind when installing.
- If another remote controller of the same type is used in the same room, or the AV receiver is installed close to equipment that uses infrared rays, the remote controller may not work reliably.
- Don't put anything, such as a book, on the remote controller, because the buttons may be pressed inadvertently, thereby draining the batteries.
- The remote controller may not work reliably if the AV receiver is installed in a rack behind colored glass doors. Keep this in mind when installing.
- The remote controller will not work if there's an obstacle between it and the AV receiver's remote control sensor.

Remote Controller

How to Use the Remote Controller

Including the AV receiver, the remote controller can be used to control up to seven different components. The remote controller has a specific operating mode for use with each type of component. Modes are selected by using the six REMOTE MODE buttons.

RECEIVER/TAPE Mode

In RECEIVER/TAPE mode, you can control the AV receiver and an Onkyo cassette recorder connected via **RI**.



DVD & CD/MD/CDR Modes

With these modes, you can control a DVD player and CD/MD/CDR player/recorder. By entering the appropriate remote control code, you can control Onkyo components or components made by other manufacturers (see page 52).



TV, VCR & SAT/CABLE Modes

With these modes, you can control a TV, VCR, and satellite/cable receiver. You must enter the appropriate remote control code first (see page 52).



1 Use the REMOTE MODE buttons to select a mode.

2 Use the buttons supported by that mode to control the component.

- RECEIVER mode: see page 10
- DVD mode: see page 12
- CD/MD/CDR mode: see page 13
- TAPE mode: see page 14
- TV mode: see page 54
- see page 14 for TV control buttons
- VCR, SAT/CABLE mode: see page 54

Note:

Some of the remote controller operations described in this manual may not work as expected with other components.

RECEIVER Mode

RECEIVER mode is used to control the AV receiver. **To set the remote controller to RECEIVER mode, press the [RECEIVER] REMOTE MODE button.**

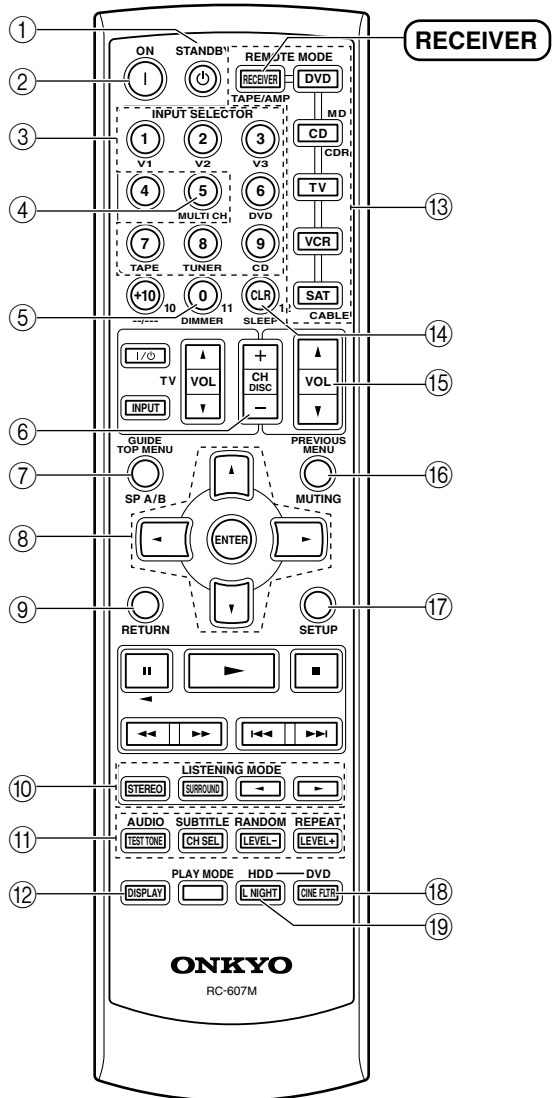

Remote Controller—Continued

For detailed information, see the pages in parentheses.

- ① **STANDBY button (30)**
This button is used to set the AV receiver to Standby.
- ② **ON button (30)**
This button is used to turn on the AV receiver.
- ③ **INPUT SELECTOR buttons (34)**
These buttons are used to select the input sources.
- ④ **MULTI CH button (35)**
This button is used to select the multichannel DVD input.
- ⑤ **DIMMER button (40)**
This button is used to adjust the display brightness.
- ⑥ **CH +/- button (37)**
This button is used to select radio presets.
- ⑦ **SP A/B button (34)**
This button is used to turn speaker sets A and B on or off.
- ⑧ **Arrow [▲]/[▼]/[◀]/[▶] & ENTER buttons**
These buttons are used to select and adjust settings.
- ⑨ **RETURN button**
This button is used to return to the previous display when changing settings.
- ⑩ **LISTENING MODE buttons (42)**
These buttons can be used to select listening modes regardless of the currently selected remote controller mode.
 - STEREO button**
This button selects the Stereo listening mode.
 - SURROUND button**
This button selects the Dolby and DTS listening modes.
 - [◀]/[▶] buttons**
These buttons can be used to select any of the available listening modes.
- ⑪ **TEST TONE, CH SEL, LEVEL- & LEVEL+ buttons (33)**
These buttons are used to adjust the level of each speaker.
- ⑫ **DISPLAY button (35, 52)**
This button is used to display various information about the currently selected input source.
- ⑬ **REMOTE MODE buttons (10)**
These buttons are used to select the remote controller modes. When you press a button on the remote controller, the REMOTE MODE button for the currently selected mode lights up.
- ⑭ **SLEEP button (41)**
This button is used to set the Sleep function.
- ⑮ **VOL [▲]/[▼] button (34)**
This button can be used to adjust the volume of the AV receiver regardless of the currently selected remote controller mode.
- ⑯ **MUTING button (40)**
This button is used to mute the AV receiver.
- ⑰ **SETUP button**
This button is used to access various settings.
- ⑱ **CINE FLTR button (46)**
This button is used to set the CinemaFILTER function.
- ⑲ **L NIGHT button (46)**
This button is used to set the Late Night function.

DVD Mode

To set the remote controller to DVD mode, press the [DVD] REMOTE MODE button.

Before selecting DVD mode and starting playback, you should press the [RECEIVER] mode button followed by the [DVD] INPUT SELECTOR button to select the DVD player as the input source.

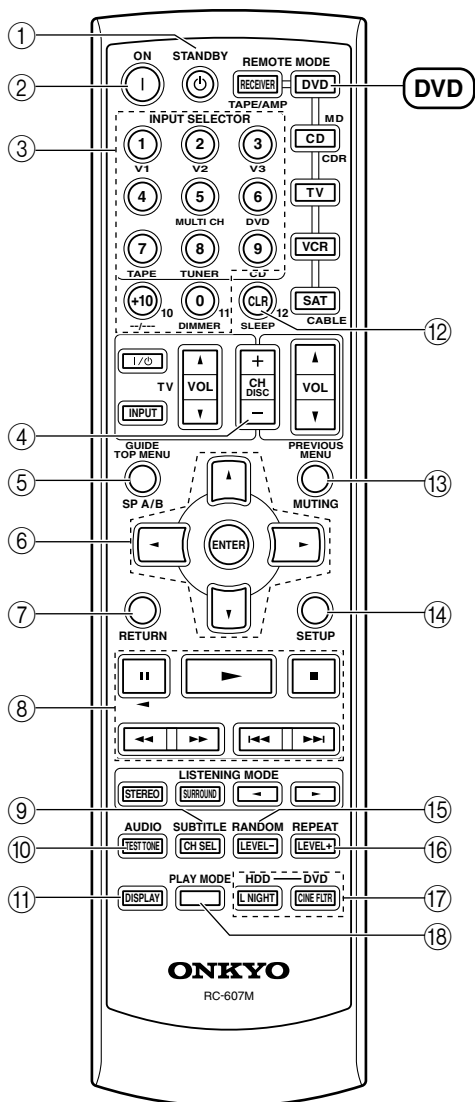

- ① **STANDBY button**
This button sets the DVD player to Standby.
- ② **ON button**
This button is used to turn on the DVD player.
- ③ **Number buttons**
These buttons are used to enter title, chapter, and track numbers and to enter times for locating specific points in time.
- ④ **DISC +/- button**
This button selects discs on a DVD changer.
- ⑤ **TOP MENU button**
This button is used to select a DVD's top menu.
- ⑥ **Arrow [▲]/[▼]/[◀]/[▶] & ENTER buttons**
These buttons are used to navigate DVD menus and the DVD player's onscreen setup menus.
- ⑦ **RETURN button**
This button is used to exit the DVD player's onscreen setup menu and to restart menu playback.
- ⑧ **Playback buttons**
From left to right: Pause, Play, Stop, Fast Reverse, Fast Forward, Previous, and Next.
- ⑨ **SUBTITLE button**
This button is used to select subtitles.
- ⑩ **AUDIO button**
This button selects foreign language soundtracks and audio formats (e.g., Dolby Digital or DTS).
- ⑪ **DISPLAY button**
This button is used to display information about the current disc, title, chapter, or track on the DVD player's display, including the elapsed time, remaining time, total time, and so on.
- ⑫ **CLR button**
This button is used to cancel functions and to clear entered numbers.
- ⑬ **MENU button**
This button is used to display a DVD's menu.
- ⑭ **SETUP button**
This button is used to access the DVD player's onscreen setup menus.
- ⑮ **RANDOM button**
This button is used with the random playback function.
- ⑯ **REPEAT button**
This button is used to set the repeat playback functions.
- ⑰ **HDD & DVD buttons**
These buttons are used to select hard disk (HDD) or DVD playback on a DVD recorder with a built-in hard disk drive.
- ⑱ **PLAY MODE button**
This button is used to select play modes on a component with selectable play modes.

Remote Controller—Continued

CD/MD/CDR Mode

By default, the AV receiver is configured to control an Onkyo CD player.

To set the remote controller to CD/MD/CDR mode, press the [CD] REMOTE MODE button.

Before selecting CD/MD/CDR mode and starting playback, you should press the [RECEIVER] mode button followed by the [CD] or [TAPE] INPUT SELECTOR button to select the CD player, MiniDisc, or CD recorder as the input source.

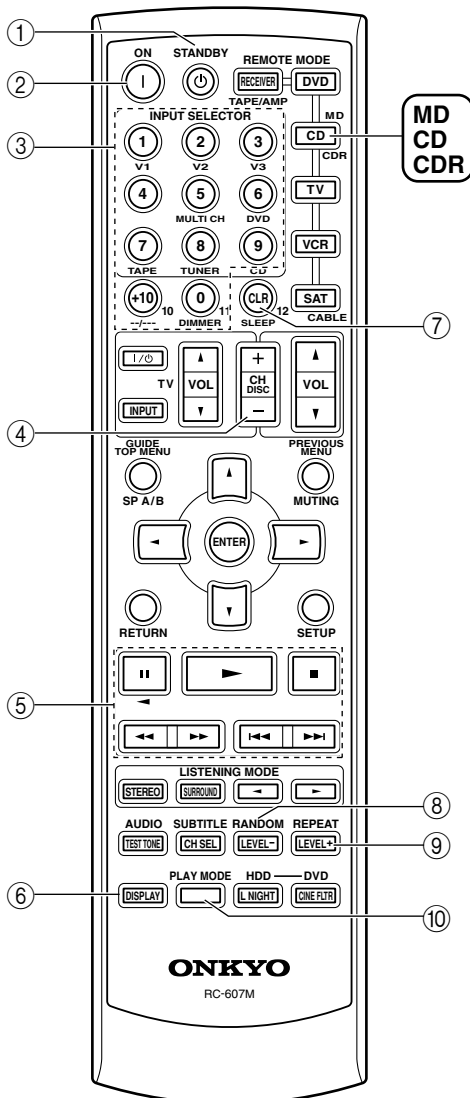

- ① **STANDBY button**
This button sets the CD player or MD/CD recorder to Standby.
- ② **ON button**
This button is used to set the CD player or MD/CD recorder to On or Standby.
- ③ **Number buttons**
These buttons are used to enter track numbers and to enter times for locating specific points in time.
- ④ **DISC +/- button**
This button selects discs on a CD changer.
- ⑤ **Playback buttons**
From left to right: Pause, Play, Stop, Fast Reverse, Fast Forward, Previous and Next.
- ⑥ **DISPLAY button**
This button is used to display information about the current disc or track on the CD player or MD/CD recorder's display, including the elapsed time, remaining time, total time, and so on.
- ⑦ **CLR button**
This button is used to cancel functions and to clear entered numbers.
- ⑧ **RANDOM button**
This button is used with the random playback function.
- ⑨ **REPEAT button**
This button is used to set the repeat playback functions.
- ⑩ **PLAY MODE button**
This button is used to select play modes on a component with selectable play modes.

TAPE Mode

TAPE mode is used to control an Onkyo cassette recorder connected to the AV receiver via **RI**.

To set the remote controller to TAPE mode, press the **[RECEIVER] REMOTE MODE** button.

Before selecting TAPE mode and starting playback, you should press the **[RECEIVER] REMOTE MODE** button followed by the **[TAPE] INPUT SELECTOR** button to select your cassette recorder as the input source.

For twin cassette decks, only deck B can be controlled.

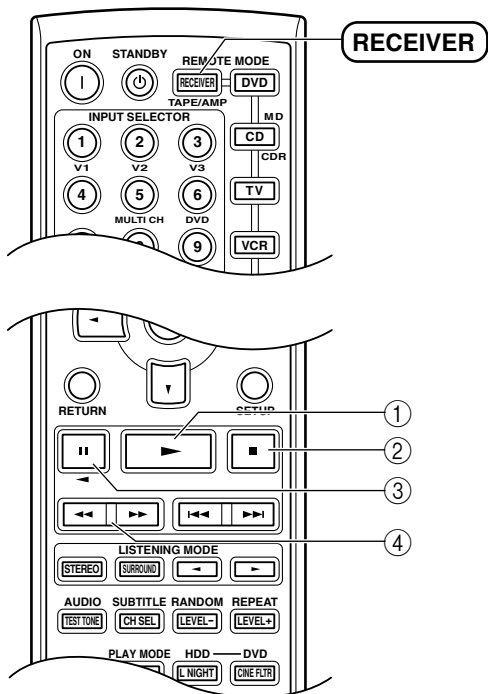

- ① **Play [▶] button**
This button is used to start playback.
- ② **Stop [■] button**
This button is used to stop playback.
- ③ **Reverse Play [◀] button**
This button is used to start reverse playback.
- ④ **Rewind & FF [◀◀]/[▶▶] buttons**
The Rewind [◀◀] button is used to start rewind. The FF [▶▶] button is used to start fast forward.

TV Control Buttons

The remote controller has dedicated buttons for controlling a TV, which can be used regardless of which remote controller mode is currently selected. To use these buttons, you must first program the **[TV]** mode button with the remote control code appropriate for the TV (see page 52).

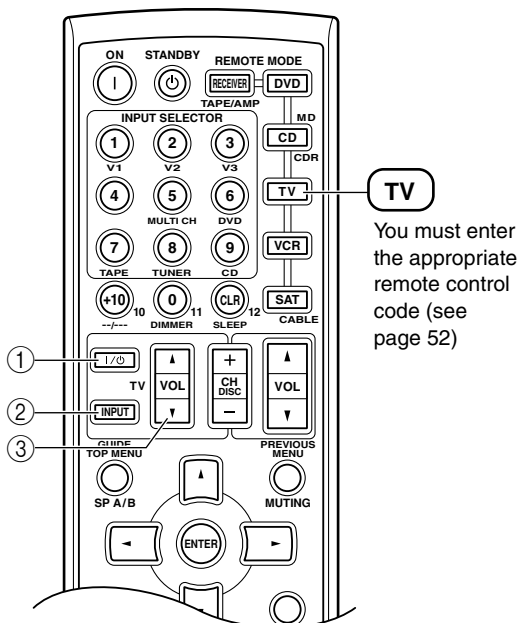

- ① **TV [⏻/⏻]**
This sets the TV to On or Standby.
- ② **[TV INPUT]**
This selects inputs on the TV.
- ③ **TV VOL [▲]/[▼]**
This adjusts the TV's volume.

Connecting Your Speakers

Enjoying Home Theater

You can use two sets of speakers with the AV receiver: speaker set A and speaker set B.

Speaker set A should be installed in your main listening room and can be used with Dolby Digital and DTS surround material. Each speaker must be positioned at a specific location in your listening room to get the best from surround sound material. The following illustration shows the best positions for your surround-sound speakers. When speaker set B is turned on, speaker set A is reduced to 5.1-channel playback.

Speaker set B can be installed in another room. Speakers can be positioned in the standard position for stereo speakers or however you like. Speaker set B outputs only analog input signals.

Front left and right speakers

These output the overall sound. Their role in a home theater is to provide a solid anchor for the sound image. They should be positioned facing the listener at about ear level, and equidistant from the TV. Angle them inward so as to create a triangle, with the listener at the apex.

Center speaker

This speaker enhances the front left and right speakers, making sound movements distinct and providing a full sound image. In movies it's used mainly for dialog. Position it close to your TV (preferably on top) facing forward at about ear level, or at the same height as the front left and right speakers.

Subwoofer

The subwoofer handles the bass sounds of the LFE (Low-Frequency Effects) channel. The volume and quality of the bass output from your subwoofer will depend on its position, the shape of your listening room, and your listening position. In general, a good bass sound can be obtained by installing the subwoofer in a front corner, or at one-third the width of the wall, as shown.

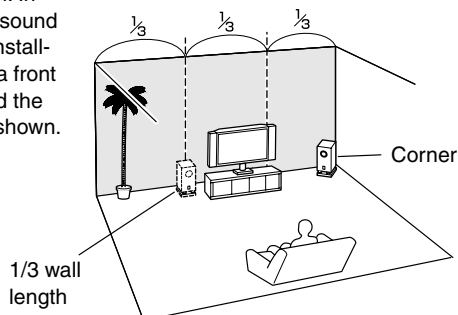

Surround back left and right speakers

These speakers further enhance the realism of surround sound and improve sound localization behind the listener. They are essential to enjoy certain listening modes (i.e., Dolby Digital EX and DTS-ES). Position them behind the listener about 2–3 feet (60–100 cm) above ear level. Make sure that the listening position is within the range of the speaker.

Surround left and right speakers

These speakers are used for precise sound positioning and to add realistic ambience. Position them at the sides of the listener, or slightly behind, about 2–3 feet (60–100 cm) above ear level. Ideally they should be equidistant from the listener.

Connecting Your Speakers—Continued

Speaker Configuration

For the best surround-sound experience, you should connect seven speakers and a powered subwoofer.

The following table shows which channels you should use based on the number of speakers that you have.

Number of speakers:	2	3	4	5	6	7
Front left	✓	✓	✓	✓	✓	✓
Front right	✓	✓	✓	✓	✓	✓
Center		✓		✓	✓	✓
Surround left			✓	✓	✓	✓
Surround right			✓	✓	✓	✓
Surround back*					✓	
Surround back left						✓
Surround back right						✓

*If you're using only one surround back speaker, connect it to the left (L) SURROUND BACK SPEAKERS terminals.

No matter how many speakers you use, a powered subwoofer is recommended for a really powerful and solid bass.

Before using the AV receiver, you must specify which speakers are connected and their sizes (see page 32).

To get the very best from your surround-sound system, you should also specify the distance between the listener and each individual speaker so that the sound from each speaker arrives at the listener's ears at the same time (see page 50). In addition, you should set the level of each individual speaker to achieve an equal balance (see page 50.)

Attaching the Speaker Labels

The AV receiver's positive (+) speaker terminals are color-coded for ease of identification. (The negative (-) speaker terminals are all black.)

Speaker terminal	Color
Front left	White
Front right	Red
Center	Green
Surround left	Blue
Surround right	Gray
Surround back left	Brown
Surround back right	Tan

The supplied speaker labels are also color-coded and you should attach them to the positive (+) side of each speaker cable in accordance with the above table. All you need to do then is to match the color of each label to the corresponding speaker terminal.

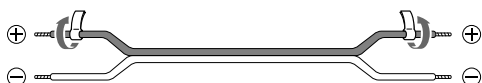

Speaker Connection Precautions

Read the following before connecting your speakers:

- **American model only:** You can connect speakers with an impedance of 6 ohms or higher. If you use speakers with a lower impedance, and use the amplifier at high volume levels for a long period of time, the built-in protection circuit may be activated.
- **Other models:** You can connect speakers with an impedance of between 4 and 16 ohms. If the impedance of any of the connected speakers is 4 ohms or more, but less than 6 ohms, be sure to set the Minimum Speaker Impedance to "4 ohms" (see page 32). If you use speakers with a lower impedance, and use the amplifier at high volume levels for a long period of time, the built-in protection circuit may be activated.
- Disconnect the power cord from the wall outlet before making any connections.
- Read the instructions supplied with your speakers.
- Pay close attention to speaker wiring polarity. In other words, connect positive (+) terminals to only positive (+) terminals, and negative (-) terminals to only negative (-) terminals. If you get them the wrong way around, the sound will be out of phase and will sound unnatural.
- Unnecessarily long, or very thin speaker cables may affect the sound quality and should be avoided.
- Be careful not to short the positive and negative wires. Doing so may damage the AV receiver.
- Don't connect more than one cable to each speaker terminal. Doing so may damage the AV receiver.
- Don't connect one speaker to several terminals.

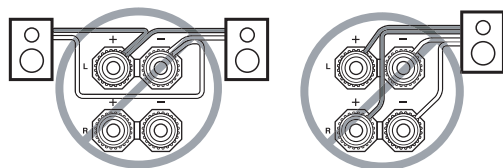
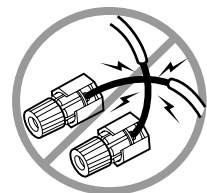

Connecting Your Speakers—Continued

Connecting Speaker Set A

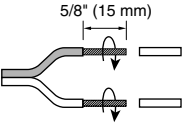
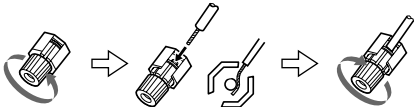
- Strip 5/8" (15 mm) of insulation from the ends of the speaker cables, and twist the bare wires tightly, as shown.
 
- Unscrew the terminal. Fully insert the bare wires. Make sure that the bare wire is touching the inside of the pole. Screw the terminal tight.
 

Connecting Speaker Set B

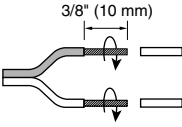
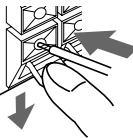
- Strip 3/8" (10 mm) of insulation from the ends of the speaker cables, and twist the bare wires tightly, as shown.
 
- While pressing the lever, insert the wire into the hole, and then release the lever. Make sure that the terminals are gripping the bare wires, not the insulation.
 

Note:

When speaker set B is turned on, speaker set A is reduced to 5.1-channel playback.

Connecting a Powered Subwoofer

Using a suitable cable, connect the AV receiver's SUBWOOFER PRE OUT to an input on your powered subwoofer, as shown. If your subwoofer is unpowered and you're using an external amplifier, connect the SUBWOOFER PRE OUT to an input on the amp.

Note:

Make sure the cable is plugged all the way.

The following illustration shows which speaker should be connected to each pair of terminals.

If you're using only one surround back speaker, connect it to the left (L) SURROUND BACK SPEAKERS terminals.

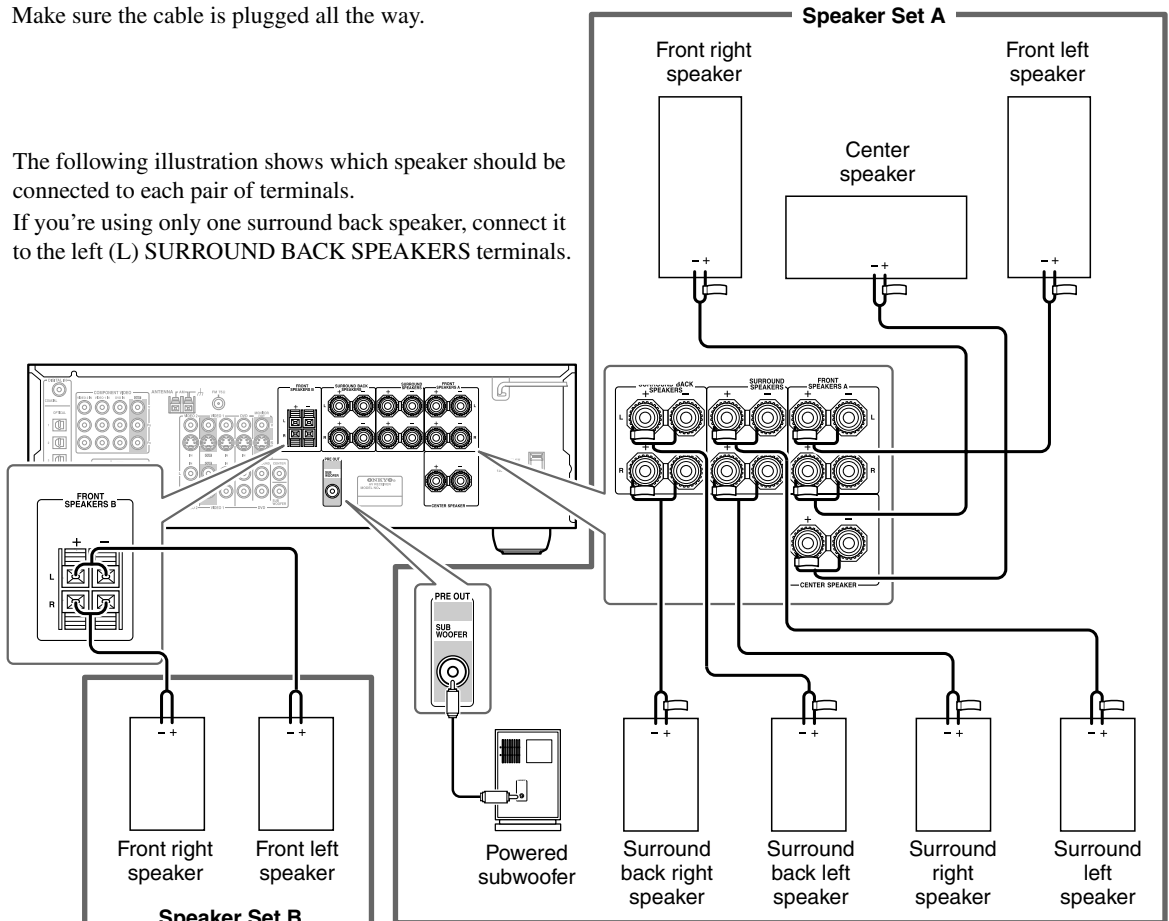

Connecting Antenna

This section explains how to connect the supplied indoor FM antenna and AM loop antenna, and how to connect commercially available outdoor FM and AM antennas. The AV receiver won't pick up any radio signals without any antenna connected, so you must connect the antenna to use the tuner.

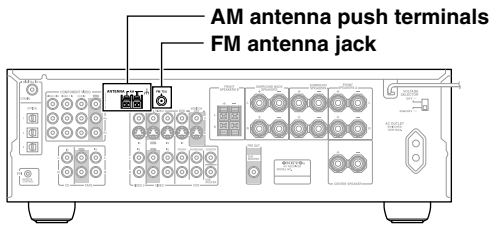

Connecting the Indoor FM Antenna

The supplied indoor FM antenna is for indoor use only.

1 Attach the FM antenna, as shown.

■ American Model

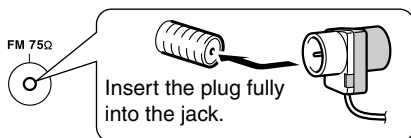

■ Other Models

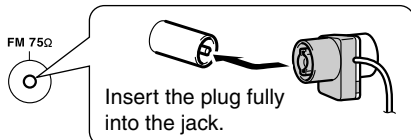

Once your AV receiver is ready for use, you'll need to tune into an FM radio station and adjust the position of the FM antenna to achieve the best possible reception.

2 Use thumbtacks or something similar to fix the FM antenna into position.

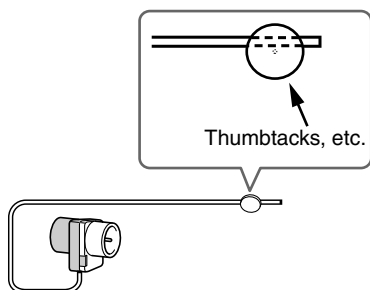

Caution: Be careful that you don't injure yourself when using thumbtacks.

If you cannot achieve good reception with the supplied indoor FM antenna, try a commercially available outdoor FM antenna instead (see page 19).

Connecting the AM Loop Antenna

The supplied indoor AM loop antenna is for indoor use only.

1 Assemble the AM loop antenna, inserting the tabs into the base, as shown.

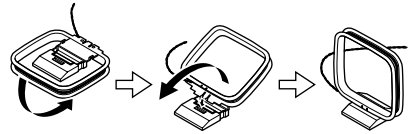

2 Connect both wires of the AM loop antenna to the AM push terminals, as shown.

(The antenna's wires are not polarity sensitive, so they can be connected either way around).

Make sure that the wires are attached securely and that the push terminals are gripping the bare wires, not the insulation.

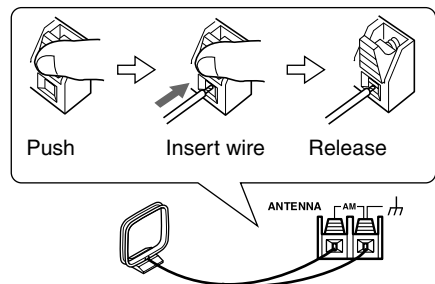

Once your AV receiver is ready for use, you'll need to tune into an AM radio station and adjust the position of the AM antenna to achieve the best possible reception.

Keep the antenna as far away as possible from your AV receiver, TV, speaker cables, and power cords.

If you cannot achieve good reception with the supplied indoor AM loop antenna, try using it with a commercially available outdoor AM antenna (see page 19).

Connecting an Outdoor FM Antenna

If you cannot achieve good reception with the supplied indoor FM antenna, try a commercially available outdoor FM antenna instead.

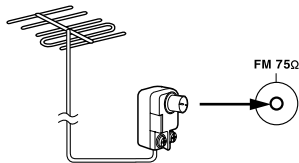

Notes:

- Outdoor FM antennas work best outside, but usable results can sometimes be obtained when installed in an attic or loft.
- For best results, install the outdoor FM antenna well away from tall buildings, preferably with a clear line of sight to your local FM transmitter.
- Outdoor antenna should be located away from possible noise sources, such as neon signs, busy roads, etc.
- For safety reasons, outdoor antenna should be situated well away from power lines and other high-voltage equipment.
- Outdoor antenna must be grounded in accordance with local regulations to prevent electrical shock hazards.

Using a TV/FM Antenna Splitter

It's best not to use the same antenna for both FM and TV reception, as this can cause interference problems. If circumstances demand it, use a TV/FM antenna splitter, as shown.

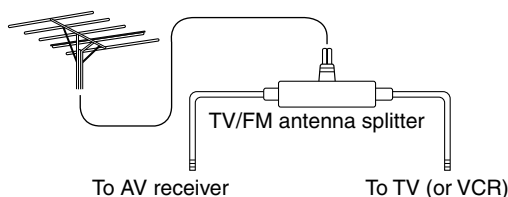

Connecting an Outdoor AM Antenna

If good reception cannot be achieved using the supplied AM loop antenna, an outdoor AM antenna can be used in addition to the loop antenna, as shown.

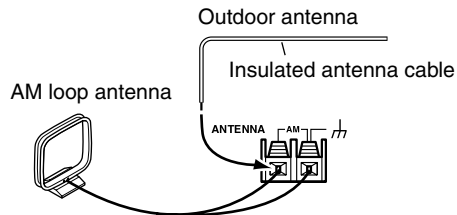

Outdoor AM antennas work best when installed outside horizontally, but good results can sometimes be obtained indoors by mounting horizontally above a window. Note that the AM loop antenna should be left connected. Outdoor antenna must be grounded in accordance with local regulations to prevent electrical shock hazards.

Connecting Your Components

About AV Connections

- Before making any AV connections, read the manuals supplied with your other AV components.
- Don't connect the power cord until you've completed and double-checked all AV connections.

Optical Digital Jacks

The AV receiver's optical digital jacks have shutter-type covers that open when an optical plug is inserted and close when it's removed. Push plugs in all the way.

Caution: To prevent shutter damage, hold the optical plug straight when inserting and removing.

AV Connection Color Coding

RCA-type AV connections are usually color coded: red, white, and yellow. Use red plugs to connect right-channel audio inputs and outputs (typically labeled "R"). Use white plugs to connect left-channel audio inputs and outputs (typically labeled "L"). And use yellow plugs to connect composite video inputs and outputs.

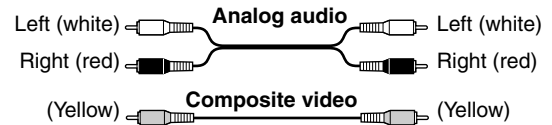

- Push plugs in all the way to make good connections (loose connections can cause noise or malfunctions).
- To prevent interference, keep audio and video cables away from power cords and speaker cables.

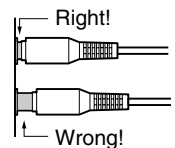

AV Cables & Jacks

Video

	Cable	Jack	Description
Component video cable		 	Component video separates the luminance (Y) and color difference signals (PR, PB), providing the best picture quality. (Some TV manufacturers label their component video jacks slightly differently.)
S-Video cable			S-Video separates the luminance and color signals and provides better picture quality than composite video.
Composite video cable			Composite video is commonly used on TVs, VCRs, and other video equipment. Use only dedicated composite video cables.

Audio

	Cable	Jack	Description
Optical digital audio cable		 	Offers the best sound quality and allows you to enjoy surround sound (e.g., Dolby Digital, DTS). The audio quality is the same as for coaxial.
Coaxial digital audio cable			Offers the best sound quality and allows you to enjoy surround sound (e.g., Dolby Digital, DTS). The audio quality is the same as for optical.
Analog audio cable (RCA)		 	This cable carries analog audio. It's the most common connection format for analog audio and can be found on virtually all AV components.
Multichannel analog audio cable (RCA)		 	This cable carries multichannel analog audio and is typically used to connect DVD players with a 5.1-channel analog audio output. Several standard analog audio cables can be used instead of a multichannel cable.

Note: The AV receiver does not support SCART plugs.

Connecting Both Audio & Video

By connecting both the audio and video outputs of your DVD player and other AV components to the AV receiver, you can select both the audio and video simultaneously simply by selecting the appropriate input source on the AV receiver.

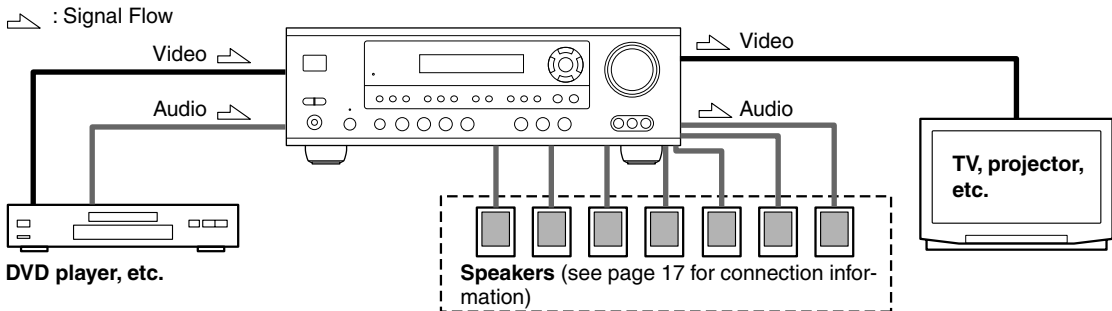

Which Connections Should I Use?

The AV receiver supports several connection formats for compatibility with a wide range of AV equipment. The format you choose will depend on the formats supported by your other components. Use the following sections as a guide.

For video components, such as a DVD player, you must make two connections—one for audio, one for video.

Video Connection Formats

Video equipment can be connected to the AV receiver using one of the following video connection formats: composite video, S-Video, or component video, the latter offering the best picture quality.

When choosing a connection format, bear in mind that the AV receiver doesn't convert between formats, so only outputs of the same format as the input will output the signal.

For example, if you connect your DVD player to the S-VIDEO DVD IN, a video signal will be output by the S-VIDEO MONITOR OUT (for your TV) and the S-VIDEO VIDEO 1 OUT (for your VCR), but not by any composite video or component video outputs.

Video Input/Output Diagram

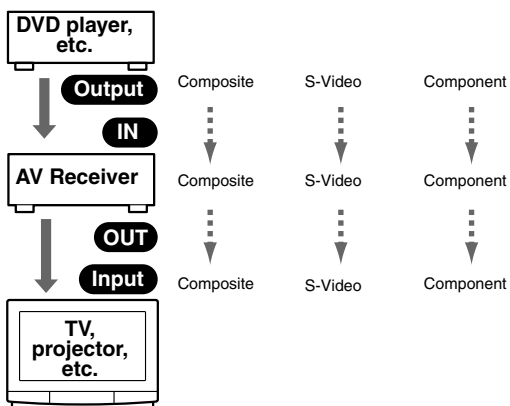

Audio Connection Formats

Audio equipment can be connected to the AV receiver using the following audio connection formats: analog, optical, coaxial, and multichannel.

When choosing a connection format, bear in mind that the AV receiver doesn't convert between formats.

For example, audio signals connected to an OPTICAL or COAXIAL digital input are not output by the analog TAPE OUT, so if you want to record from, for example, your CD player, in addition to connecting it to a digital input, you must also connect it to the analog CD IN.

Audio Input/Output Diagram for Recording

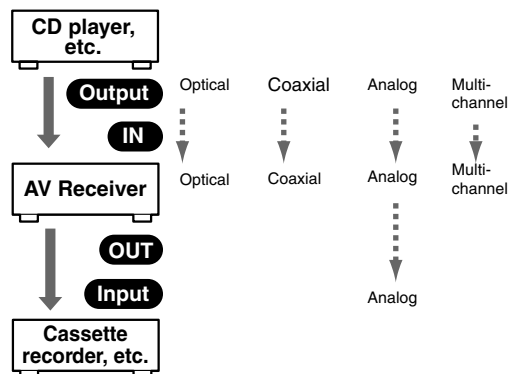

Connecting Your Components—Continued

Connecting a TV or Projector

Step 1: Video Connection

Choose a connection type **A**, **B**, or **C** that matches the TV, and then make the connection.

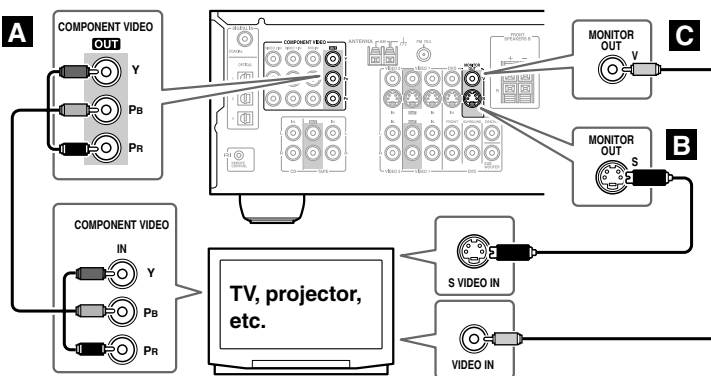

Connection	TX-SR503/503E/8350	Signal flow	TV	Picture quality
A	COMPONENT VIDEO OUT	⇒	Component video input	Best
B	MONITOR OUT S	⇒	S-Video input	Better
C	MONITOR OUT V	⇒	Composite video input	Standard

Step 2: Audio Connection

Choose a connection type **a**, **b**, or **c** that matches the TV, and then make the connection.

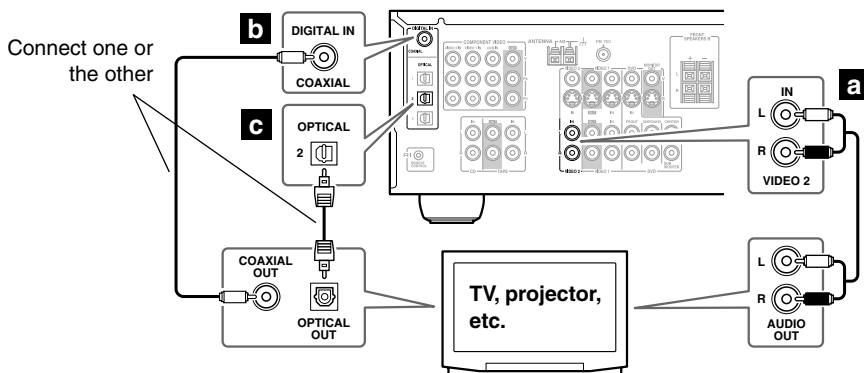

- With the basic **a** connection, you can listen to or record audio from the TV, and listen via speaker set B.
- To enjoy Dolby and DTS listening modes, use connection **b** or **c**. (Use **a** and **b** or **a** and **c** for recording.)

Connection	TX-SR503/503E/8350	Signal flow	TV
a	VIDEO 2 IN L/R	←	Analog audio L/R output
b	DIGITAL IN COAXIAL	←	Digital coaxial output
c	DIGITAL IN OPTICAL 2	←	Digital optical output

Hint!

If your TV has no audio outputs, connect your VCR to the AV receiver and use its tuner.

Connecting Your Components—Continued

Connecting a DVD player

Step 1: Video Connection

Choose a connection type **A**, **B**, or **C** that matches the DVD player, and then make the connection.

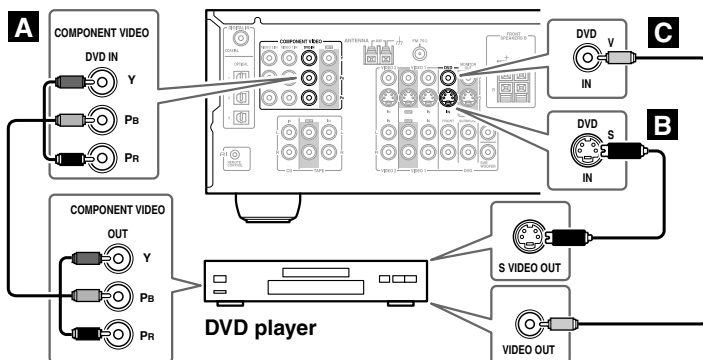

The TV must be connected to the AV receiver with the same type of connection.

Connection	TX-SR503/503E/8350	Signal flow	DVD player	Picture quality
A	COMPONENT VIDEO DVD IN	←	Component video output	Best
B	DVD IN S	←	S-Video output	Better
C	DVD IN V	←	Composite video output	Standard

Step 2: Audio Connection

Choose a connection type **a**, **b**, **c**, or **d** that matches your DVD player, and then make the connection.

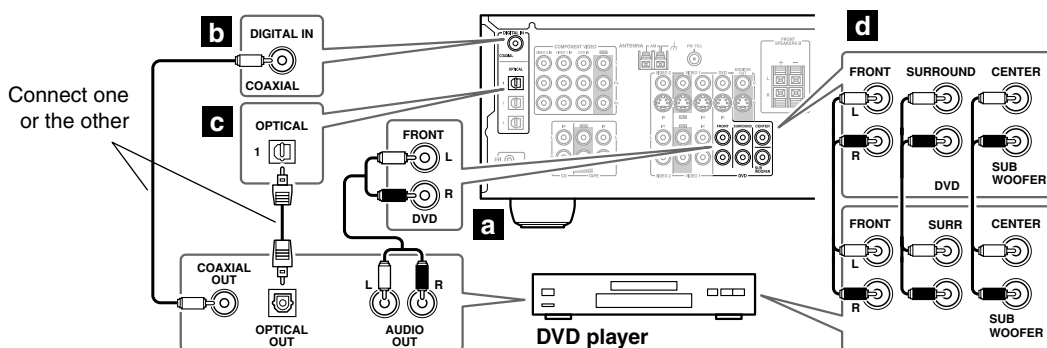

- With the basic **a** connection, you can listen to or record audio from a DVD, and listen via speaker set B.
- To enjoy Dolby and DTS listening modes, use connection **b** or **c**. (Use **a** and **b** or **a** and **c** for recording.)
- To enjoy DVD-Audio or SACD playback from a compatible DVD player with an analog multichannel output, use connection **d**.

Connection	TX-SR503/503E/8350	Signal flow	DVD player
a	DVD IN FRONT	←	Analog audio L/R output
b	DIGITAL IN COAXIAL	←	Digital coaxial output
c	DIGITAL IN OPTICAL 1	←	Digital optical output
d	DVD IN FRONT, SURROUND, CENTER, and SUBWOOFER	←	Analog multichannel output

- If your DVD player has main left and right outputs and multichannel left and right outputs, be sure to use the main left and right outputs for connection **a**.

Connecting a VCR or DVD Recorder for Playback

In addition to video playback, with this hookup example, you can use the VCR's tuner to listen to the sound of your favorite TV programs via the AV receiver. This is useful if the TV has no audio outputs.

Step 1: Video Connection

Choose a connection type **A**, **B**, or **C** that matches the VCR/DVD recorder, and then make the connection. The TV must be connected to the AV receiver with the same type of connection.

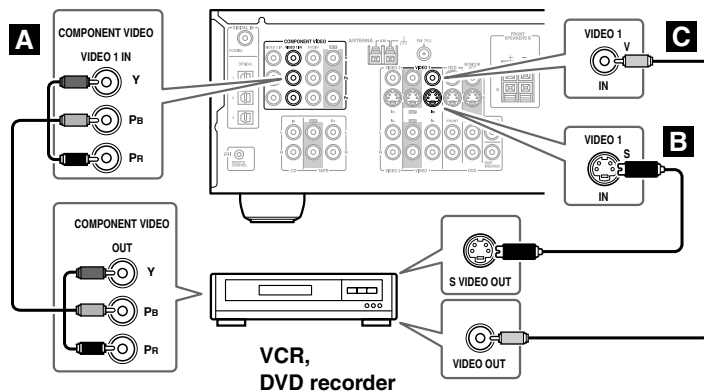

Connection	TX-SR503/503E/8350	Signal flow	VCR/DVD recorder	Picture quality
A	COMPONENT VIDEO VIDEO 1 IN	←	Component video output	Best
B	VIDEO 1 IN S	←	S-Video output	Better
C	VIDEO 1 IN V	←	Composite video output	Standard

Step 2: Audio Connection

Choose a connection type **a**, **b**, or **c**, and then make the connection.

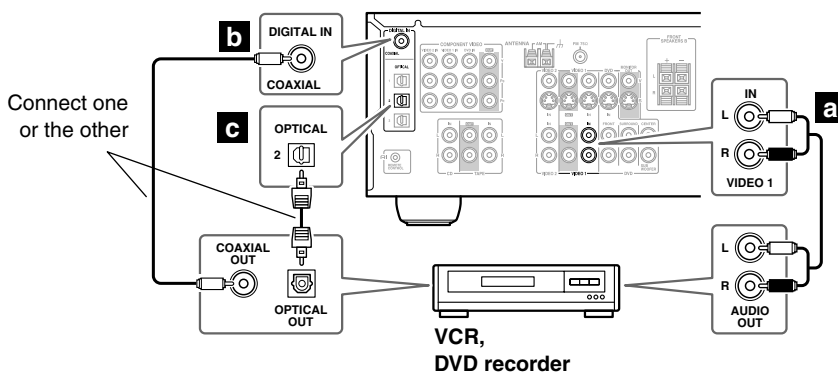

- With the basic **a** connection, you can listen to the VCR/DVD recorder, and listen via speaker set B.
- To enjoy Dolby and DTS listening modes, use connection **b** or **c**. (Use **a** and **b** or **a** and **c** to listen via speaker set B.)

Connection	TX-SR503/503E/8350	Signal flow	VCR/DVD recorder
a	VIDEO 1 IN L/R	←	Analog audio L/R output
b	DIGITAL IN COAXIAL	←	Digital coaxial output
c	DIGITAL IN OPTICAL 2	←	Digital optical output

Connecting Your Components—Continued

Connecting a VCR or DVD Recorder for Recording

Step 1: Choose a video connection type **A** or **B** that matches the VCR/DVD recorder, and make the connection. The video source that you want to record must be connected to the AV receiver with the same type of connection.

Step 2: Make audio connection **a**.

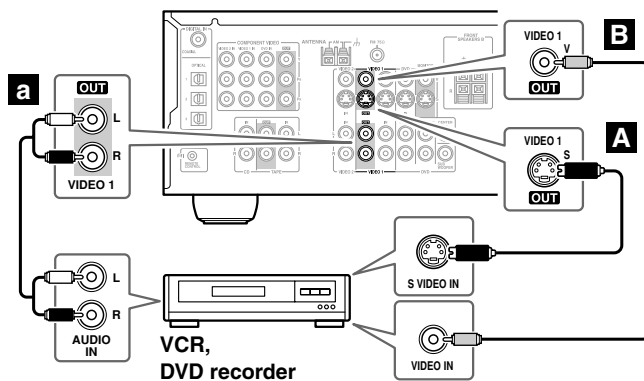

Connection	TX-SR503/503E/8350	Signal flow	VCR/DVD recorder	Picture quality
A	VIDEO 1 OUT S	⇒	S-Video input	Better
B	VIDEO 1 OUT V	⇒	Composite video input	Standard
a	VIDEO 1 OUT L/R	⇒	Audio L/R input	—

Connecting a Camcorder, Games Console, or Other Device

Step 1: Make video connection **A**.

Step 2: Make audio connection **a**.

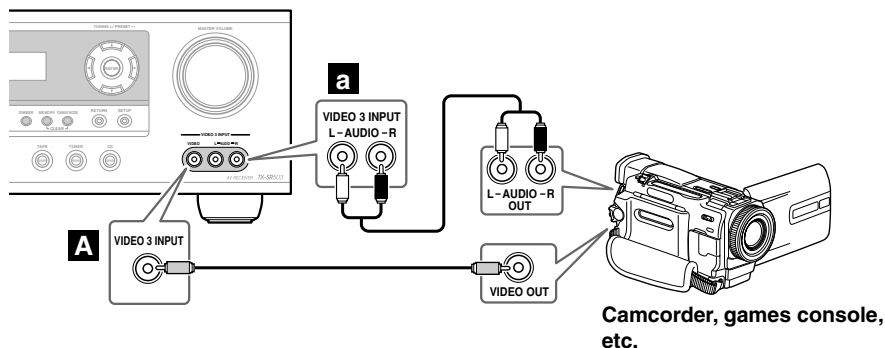

Connection	TX-SR503/503E/8350	Signal flow	Camcorder/console
A	VIDEO 3 INPUT	←	Composite video output
a	VIDEO 3 INPUT L/R	←	Analog audio L/R output

Connecting Your Components—Continued

Connecting a Satellite, Cable, Set-top box, or Other Video Source

Step 1: Video Connection

Choose a connection type **A**, **B**, or **C** that matches the video source, and then make the connection.

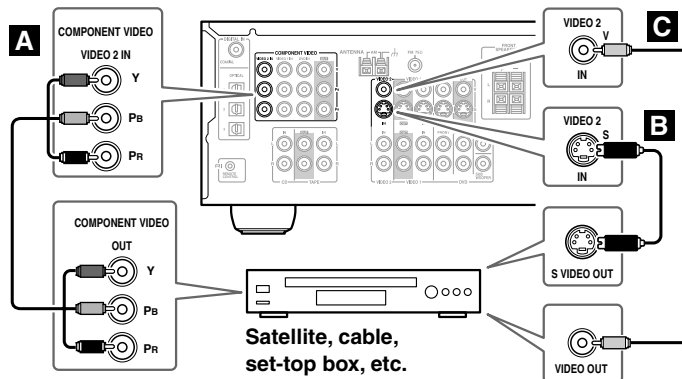

The TV must be connected to the AV receiver with the same type of connection.

Connection	TX-SR503/503E/8350	Signal flow	Video source	Picture quality
A	COMPONENT VIDEO VIDEO 2 IN	←	Component video output	Best
B	VIDEO 2 IN S	←	S-Video output	Better
C	VIDEO 2 IN V	←	Composite video output	Standard

Step 2: Audio Connection

Choose a connection type **a**, **b**, or **c** that matches the video source, and then make the connection.

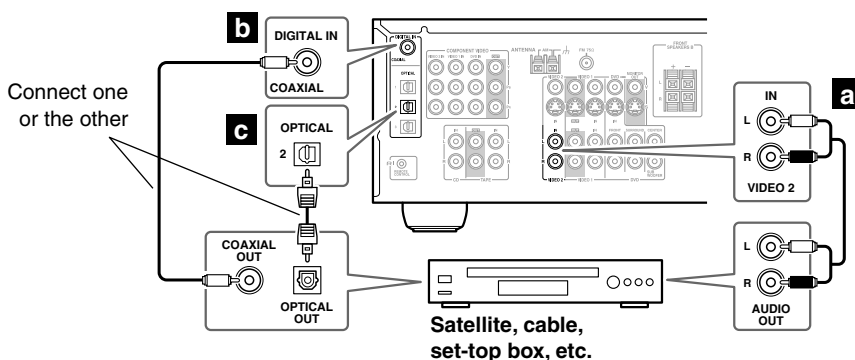

- With the basic **a** connection, you can listen to or record audio from the video source, and listen via speaker set B.
- To enjoy Dolby and DTS listening modes, use connection **b** or **c**. (Use **a** and **b** or **a** and **c** for recording.)

Connection	TX-SR503/503E/8350	Signal flow	Video source
a	VIDEO 2 IN L/R	←	Analog audio L/R output
b	DIGITAL IN COAXIAL	←	Digital coaxial output
c	DIGITAL IN OPTICAL 2	←	Digital optical output

Connecting a CD Player or Turntable

■ CD Player, or Turntable with Built-in Phono Preamp

Step 1:

Choose a connection type (**a**, **b**, or **c**) that matches the CD player, or choose **a** for a turntable with a built-in phono preamp, and then make the connection.

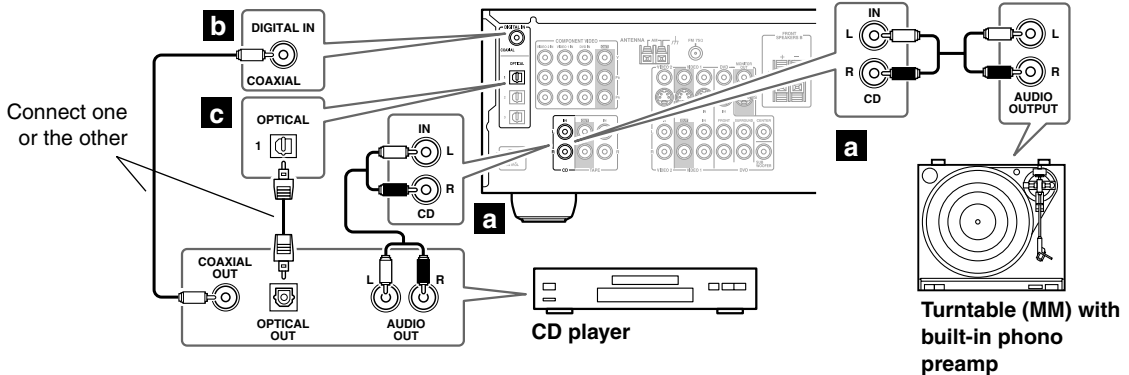

- With the basic **a** connection, you can listen to or record audio from the CD player or turntable, and listen via speaker set B.
- To connect the CD player digitally, use connection **b** or **c**. (Use **a** and **b** or **a** and **c** for recording.)

Connection	TX-SR503/503E/8350	Signal flow	CD or turntable
a	CD IN L/R	←	Analog audio L/R output
b	DIGITAL IN COAXIAL	←	Digital coaxial output
c	DIGITAL IN OPTICAL 1	←	Digital optical output

■ Turntable with no Phono Preamp Built-in

A phono preamp is necessary to connect a turntable that doesn't have a phono preamp built-in.

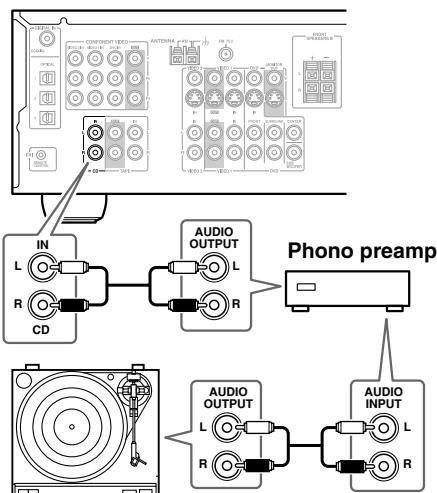

■ Turntable with an MC (Moving Coil) Cartridge

An MC head amp and phono preamp are necessary to connect a turntable with an MC (Moving Coil) cartridge.

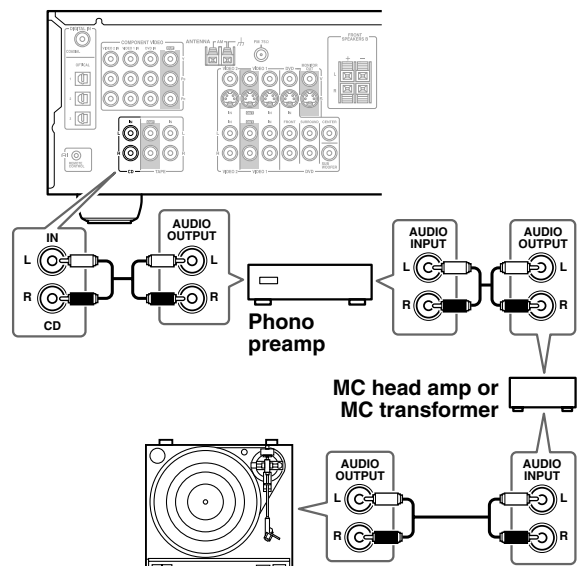

Connecting Your Components—Continued

Connecting a Cassette, CDR, MiniDisc, or DAT Recorder

Step 1:

Choose a connection type **a**, **b**, or **c** that matches the recorder, and then make the connection.

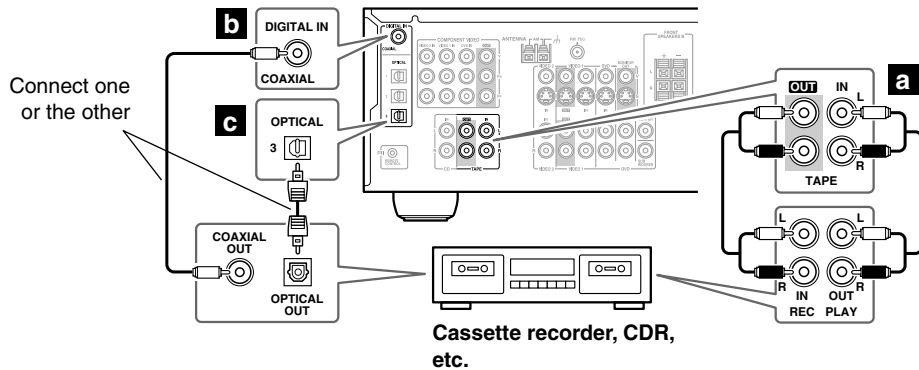

- With the basic **a** connection, you can play and record with the recorder, and listen via speaker set B.
- To connect the recorder digitally for playback purposes, use connections **a** and **b** or **a** and **c**.

Connection	TX-SR503/503E/8350	Signal flow	Cassette/CDR/MD/DAT recorder
a	TAPE IN L/R TAPE OUT L/R	← ⇒	Analog audio L/R output Analog audio L/R input
b	DIGITAL IN COAXIAL	←	Digital coaxial output
c	DIGITAL IN OPTICAL 3	←	Digital optical output

Connecting the Power Cord of Another Component

The AV receiver has an AC outlet on its rear panel for connecting the power cord of another AV component. The other component's power switch can then be left in the ON position so that it turns on or off when the AV receiver is set to On or Standby.

Caution:

- Make sure that the capacity of the component that you connect to the AC OUTLET does not exceed the stated capacity (e.g., 100 W).

Notes:

- Onkyo components with **RI** jacks should be connected directly to wall outlets, not the AV receiver's AC OUTLET.
- The socket type and capacity will depend on the country in which you purchased the AV receiver.

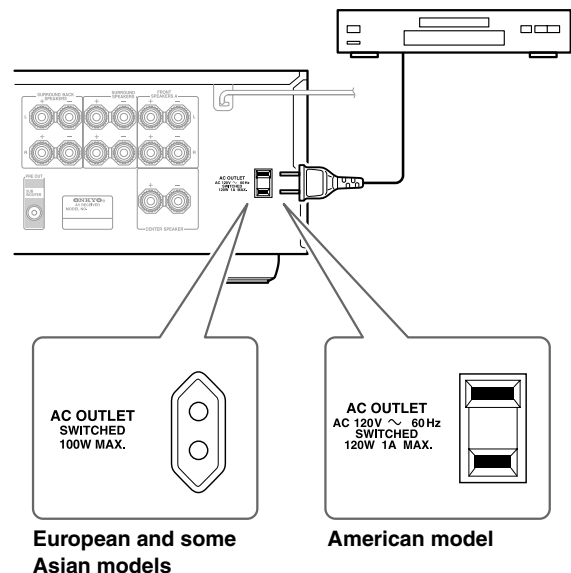

Connecting Onkyo **RI** Components

Step 1: Be sure that the Onkyo component is connected to the AV receiver with an analog audio cable (RCA).

Step 2: Make the **RI** connection.

With **RI** (Remote Interactive) you can use the following special **RI** functions:

Auto Power On/Standby

When you start playback on a component connected via **RI**, if the AV receiver is in Standby, it will turn on and select that component as the input source automatically. Similarly, when the AV receiver is set to Standby, all components connected via **RI** will also enter Standby. This function will not work if a component's power cord is connected to the AV receiver's AC OUTLET.

Direct Change

When playback is started on a component connected via **RI**, the AV receiver automatically selects that component as the input source. If the DVD player is connected to the AV receiver's multichannel input, you must press the [MULTI CH] button (see page 35) to listen to all channels because the Direct Change **RI** function selects only the DVD IN FRONT jacks.

Remote Control

You can control other **RI**-compatible Onkyo components by pointing the remote controller at the AV receiver's remote control sensor. You must enter the appropriate remote control code first (page 53).

Notes:

- Use only **RI** cables for **RI** connections. **RI** cables are supplied with Onkyo players (DVD, CD, etc.).
- Some components have two **RI** jacks, you can connect either one to the AV receiver. The other is for connecting additional **RI**-compatible components.
- Connect the AV receiver's **RI** jack to only Onkyo components. Connecting to other manufacturer's components may cause them to malfunction.
- Some components may not support all **RI** functions. Refer to the manuals supplied with your components.

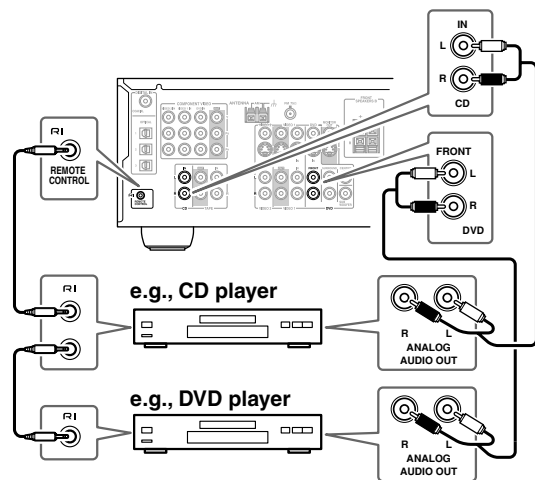

Connecting the Power Cord

Notes:

- **Before connecting the power cord, connect all of your speakers and AV components.**
- Turning on the AV receiver may cause a momentary power surge that might interfere with other electrical equipment on the same circuit. If this is a problem, plug the AV receiver into a different branch circuit.

Turning On

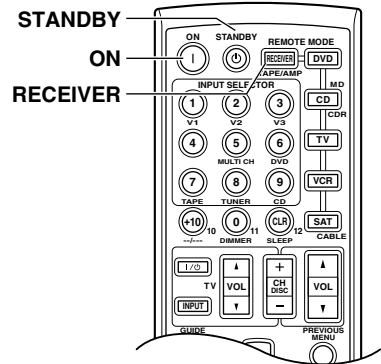
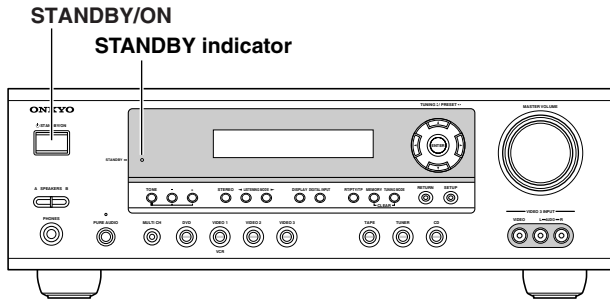

Turning On the AV Receiver

1

AV receiver



or

Remote controller

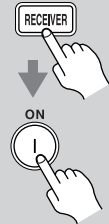

Press the [STANDBY/ON] button.

Alternatively, press the remote controller's [RECEIVER] button followed by the [ON] button.

The AV receiver comes on, the display lights up, and the STANDBY indicator goes off.

To turn the AV receiver off, press the [STANDBY/ON] button, or the remote controller's [STANDBY] button. The AV receiver will enter Standby mode. To prevent any loud surprises the next time you turn on the AV receiver, always turn down the volume before turning it off.

Smooth Operation in a Few Easy Steps

To ensure smooth operation, here's a few easy steps to help you configure the AV receiver before you use it for the very first time. These settings only need to be made once.

■ Have you connected a component to a digital audio input?

If you have, see "Assigning Digital Inputs to Input Sources" on page 31.

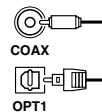

■ Have you connected an Onkyo MD recorder or CD recorder to the TAPE IN/OUT jacks?

If you have, see "Changing the TAPE/MD/CDR Display" on page 31.

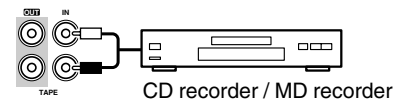

■ Have you connected any speakers with an impedance of between 4 and 6 ohms?

If you have, see "Minimum Speaker Impedance Setup" on page 32. (Not North American models.)

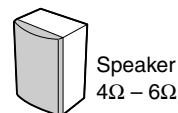

■ Do the speaker configuration—this is essential!

See "Speaker Configuration" on page 32.



First Time Setup

Assigning Digital Inputs to Input Sources

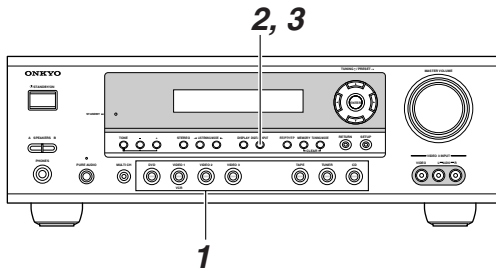

To enjoy Dolby Digital and DTS, you must connect your DVD player to the AV receiver by using a digital audio connection (coaxial or optical).

With this function, you can assign digital inputs to input sources. For example, if you connect your DVD player to DIGITAL IN OPTICAL 1, you'll need to assign that input (OPT1) to the DVD input source.

You can change the assignments as follows.

Note:

Make sure you also set your digital sources to send out a digital signals. Please refer to the digital sources' manual.

<p>1</p>	<p>Press the input selector button for the source that you want to assign. (Digital inputs cannot be assigned to the TUNER input source.)</p>
<p>2</p>	<p>Press the [DIGITAL INPUT] button. The current assignment appears.</p> <div style="border: 1px solid black; padding: 5px; width: fit-content;"> DVD : COAX </div>
<p>3</p>	<p>Press the [DIGITAL INPUT] button repeatedly to select COAX, OPT1, OPT2, OPT3, or "----" (analog).</p> <div style="border: 1px solid black; padding: 5px; width: fit-content;"> DVD : OPT1 </div>

Changing the TAPE/MD/CDR Display

If you connect an **RI**-compatible Onkyo MiniDisc recorder or CD recorder to the TAPE IN/OUT jacks, for **RI** to work properly, you must change this setting. This setting can only be changed on the AV receiver.

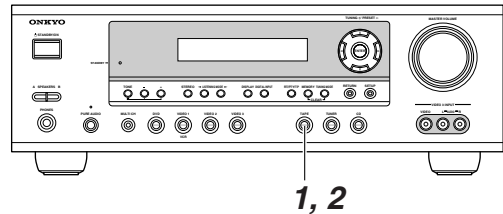

<p>1</p>	<p>Press the [TAPE] input selector button so that "TAPE" appears on the display.</p> <div style="border: 1px solid black; padding: 5px; width: fit-content;"> TAPE </div>
<p>2</p>	<p>Press and hold down the [TAPE] input selector button (about 3 seconds) to set the display. Repeat this step to select TAPE, MD, or CDR.</p> <div style="border: 1px solid black; padding: 5px; width: fit-content; margin-bottom: 5px;"> MD </div> <div style="border: 1px solid black; padding: 5px; width: fit-content;"> CDR </div>

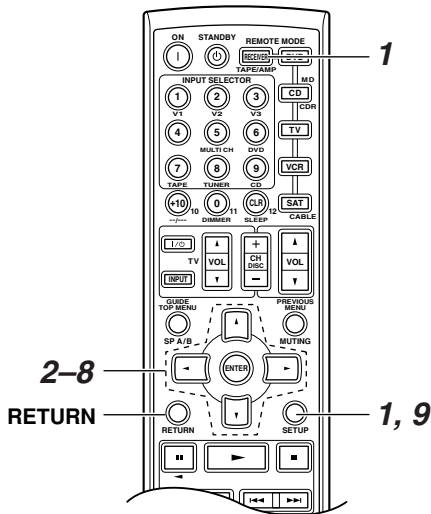

Minimum Speaker Impedance Setup (not North American model)

If the impedance of any of the connected speakers is 4 ohms or more, but less than 6 ohms, set the Minimum Speaker Impedance to “4 ohms.”

Note:

Before you change this setting, turn down the volume.

1	Press the [RECEIVER] button followed by the [SETUP] button.
2	Use the Up and Down [▲]/[▼] buttons to select “0. Hardware Setup,” and then press [ENTER].
3	Use the Left and Right [◀]/[▶] buttons to select the setting for “Impedance.” 4 ohms: Select if the impedance of any connected speaker is 4 ohms or more, but less than 6 ohms. 6 ohms: Select if the impedances of all connected speakers are between 6 and 16 ohms. Press [RETURN] to continue with step 2 in the “Speaker Configuration” setting.

Note:

- This procedure can also be performed on the AV receiver by using its [SETUP] button, arrow buttons, and [ENTER] button.

Speaker Configuration

This section explains how to specify which speakers are connected and their sizes.

For speakers with a cone diameter larger than 6-1/2 inches (16 cm), specify **Large**. For those with a smaller diameter, specify **Small**.

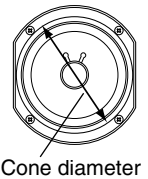

1	Press the [RECEIVER] button followed by the [SETUP] button.
2	Use the Up and Down [▲]/[▼] buttons to select “1. Speaker Config,” and then press the [ENTER] button. <div style="border: 1px solid black; padding: 2px; width: fit-content; margin: 0 auto;">1. SpeakerConfig</div>
3	While the Subwoofer setting is selected, use the Left and Right [◀]/[▶] buttons to select Yes or No . Yes: Select if a subwoofer is connected. No: Select if no subwoofer is connected.
4	Use the Down [▼] button to select “Front,” and then use the Left and Right [◀]/[▶] buttons to select Small or Large . Small: Select if the front speakers are small. Large: Select if the front speakers are large. Note: <ul style="list-style-type: none"> If the Subwoofer setting in step 3 is set to No, this setting is fixed at Large and does not appear.

5

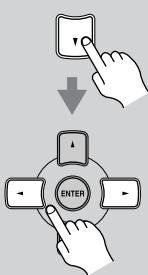

Use the Down [▼] button to select “Center,” and then use the Left and Right [◀]/[▶] buttons to select **Small, Large, or None**.

Small: Select if the center speaker is small.

Large: Select if the center speaker is large.

None: Select if no center speaker is connected.

Note:

- If the Front setting in step 4 is set to Small, the Large option cannot be selected.

6

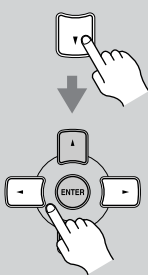

Use the Down [▼] button to select “Surround,” and then use the Left and Right [◀]/[▶] buttons to select **Small, Large, or None**.

Small: Select if the surround speakers are small.

Large: Select if the surround speakers are large.

None: Select if no surround speakers are connected.

Note:

- If the Front setting in step 4 is set to Small, the Large option cannot be selected.

7

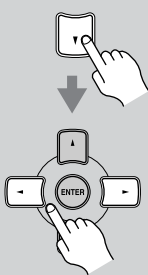

Use the Down [▼] button to select “Surr Back,” and use the Left and Right [◀]/[▶] buttons to select **Small, Large, or None**.

Small: Select if the surround back speakers are small.

Large: Select if the surround back speakers are large.

None: Select if no surround back speakers are connected.

Notes:

- If the Surround setting in step 6 is set to None, this setting does not appear.
- If the Surround setting in step 6 is set to Small, the Large option cannot be selected.

8

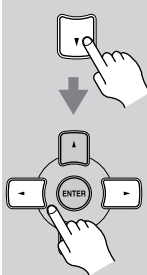

Use the Down [▼] button to select “Surr Back Ch,” and use the Left and Right [◀]/[▶] buttons to select **2ch or 1ch**.

2ch: Select if two (left and right) surround back speakers are connected.

1ch: Select if one surround back speaker is connected.

Note:

- If the Surround and Surr Back settings in steps 6 and 7 are set to None, this setting does not appear.

9



Press the [SETUP] button.
Setup closes.

TESTING THE SPEAKERS

To test that all of the speakers are working properly, press the remote controller’s [TEST TONE] button. The test tone will be output by each speaker in turn and the name of each speaker will appear on the display. To turn off the test tone, press the [TEST TONE] button again.

- If the test tone is not produced by a speaker, or it’s produced by a speaker other than that shown on the display, you may have wired the speakers incorrectly and you should check your connections (see page 17).
- If the test tone is not produced by a speaker and its name does not appear on the display, you may have set the speaker settings incorrectly (see page 32).

Playing Your AV Components

Basic AV Receiver Operation

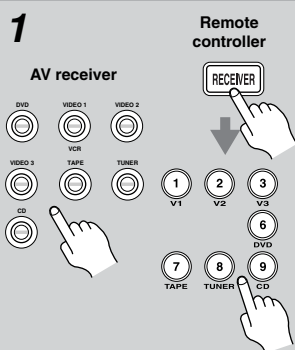
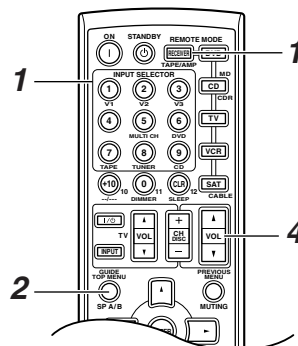
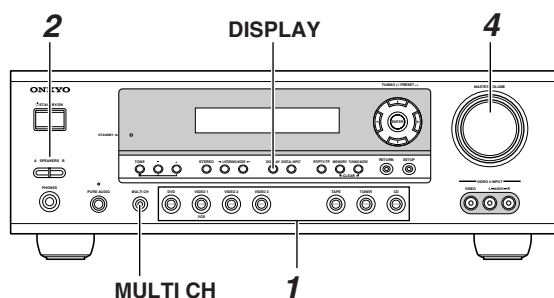

1 Use the AV receiver's input selector buttons to select the input source.

To select the input source with the remote controller, press the [RECEPTOR] button, and then use the INPUT SELECTOR buttons.

On the remote controller, the [V1], [V2], and [V3] buttons select the VIDEO 1, VIDEO 2, and VIDEO 3 input sources respectively.

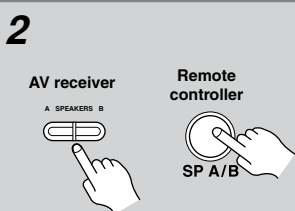

2 Use the SPEAKERS [A] and [B] buttons on the AV receiver or the [SP A/B] button on the remote controller to select the speaker set that you want to use.

Pressing the remote controller's [SP A/B] button cycles through the following settings: Speaker Set A → Speaker Set A&B → Speaker Set B → Off.

The A and B speaker indicators show whether each speaker set is on or off.

Note that when speaker set B is turned on, speaker set A is reduced to 5.1-channel playback.

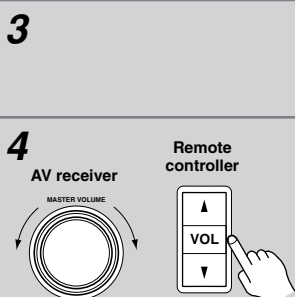
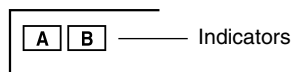

3 Start playback on the source component.

When you select DVD or another video component, on your TV you'll need to select the video input that's connected to the AV receiver's MONITOR OUT.

4 To adjust the volume, use the MASTER VOLUME control, or the remote controller's [VOL] button.

The volume can be set to MIN, 1 through 79, or MAX. The AV receiver is designed for home theater enjoyment and has a wide volume range for precise adjustment.

5

Select a suitable listening mode and enjoy!

See page 42.

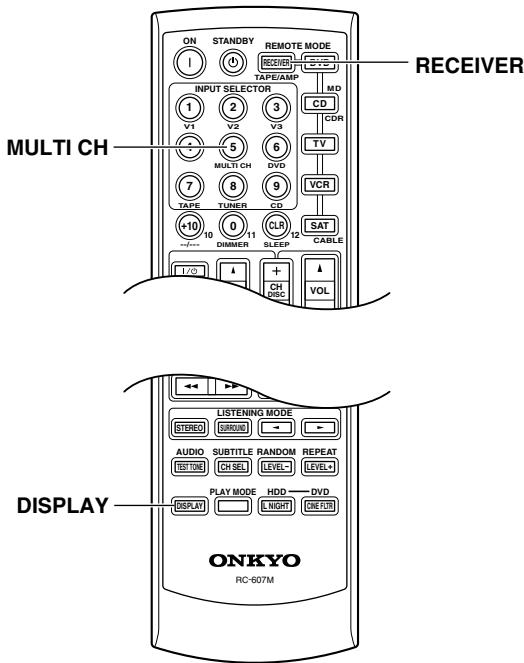

Displaying Source Information

You can display various information about the current input source as follows.

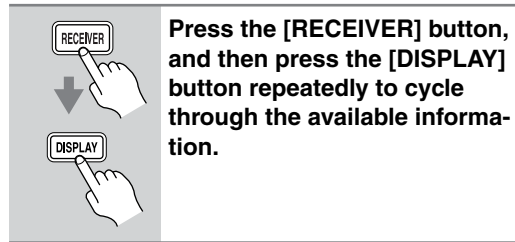

The following information can typically be displayed for input sources.

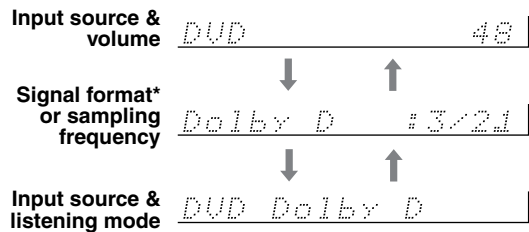

Using the Multichannel Input

The multichannel input is for connecting a component with individual 5.1-channel analog audio output jacks, such as a DVD player or MPEG decoder. See page 23 for hookup information.

Note:

- While the multichannel input is selected, the Speaker Configuration settings on page 32 are ignored, and signals from the multichannel input are fed to the front left, front right, center, surround left, and surround right speakers and subwoofer regardless of those settings.

Interpreting Surround Channel Information

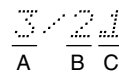

- A: The number of front channels (front left, front right, and center).
- B: The number of surround channels (surround left and surround right). If there's surround back channel information, this number will be 3.
- C: LFE channel for subwoofer (1 means yes).

Using the Tuner

Listening to the Radio

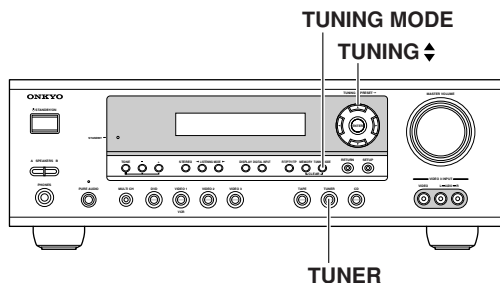

With the built-in tuner, you can enjoy AM and FM radio stations. You can store your favorite stations as presets for quick selection.

1 	<p>Use the [TUNER] input selector button to select either AM or FM. In this example, FM has been selected.</p> <div style="border: 1px solid black; padding: 5px; text-align: center;"> <p>FM 87.5 MHz</p> <p>Band Frequency</p> </div> <p>(Actual display depends on country.)</p>
---	---

AM Frequency Step Setup (not North America and Europe)

Here you can specify the AM frequency step used in your area. When this setting is changed, all radio presets are deleted.



1	<p>Press the [SETUP] button and use the Up and Down [▲]/[▼] buttons to select “0. Hardware Setup,” and then press [ENTER].</p>
2	<p>Use the Up and Down [▲]/[▼] buttons to select “AM Freq.,” and then use the Left and Right [◀]/[▶] buttons to select:</p> <p>10 kHz: Select if 10 kHz steps are used in your area.</p> <p>9 kHz: Select if 9 kHz steps are used in your area.</p>
3	<p>Press the [SETUP] button. Setup closes.</p>

Note:

- This procedure can also be performed on the remote controller by using its [SETUP] button, arrow buttons, and [ENTER] button.

Tuning into Radio Stations

Auto Tuning Mode

1 	<p>Press the [TUNING MODE] button so that the AUTO indicator appears on the display.</p>
2 	<p>Press the TUNING Up or Down [▲]/[▼] button. Searching stops when a station is found.</p>

When tuned into a station, the TUNED indicator appears. When tuned into a stereo FM station, the FM STEREO indicator appears on the display, as shown.

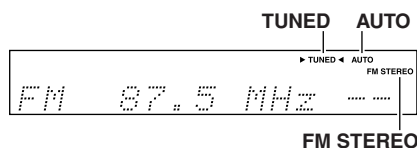

Manual Tuning Mode

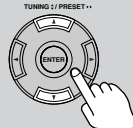
1 	<p>Press the [TUNING MODE] button so that the AUTO indicator disappears from the display.</p>
2 	<p>Press and hold the TUNING Up or Down [▲]/[▼] button. The frequency stops changing when you release the button. Press the buttons repeatedly to change the frequency one step at a time.</p>

The American model changes FM frequency in 0.2 MHz steps, 10 kHz steps for AM. For other models it's 0.05 MHz steps for FM and 9 kHz steps for AM. In Manual Tuning mode, FM stations will be in mono.

Tuning into weak FM stereo stations



If the signal from a stereo FM station is weak, it may be impossible to get good reception. In this case, switch to Manual Tuning mode and listen to the station in mono.

Using the Tuner—Continued

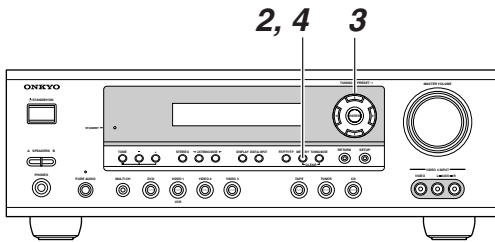
Presetting Radio Stations



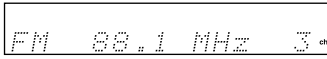
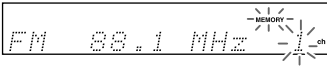

You can store up to 30 of your favorite radio stations as presets.

- | | |
|--|---|
| 1 | Tune into the station that you want to store as a preset. |
| 2
<small>MEMORY</small>
 | Press the [MEMORY] button.
The MEMORY indicator appears and the preset number flashes. |
| 3
<small>TUNING PRESET</small>
 | While the MEMORY indicator is displayed (about 8 seconds), use the PRESET [◀]/[▶] buttons to select a preset from 1 through 30.
In this example, preset #3 is selected. |
| 4
<small>MEMORY</small>
 | Press the [MEMORY] button again to store the station.
The station is stored and the preset number stops flashing. |



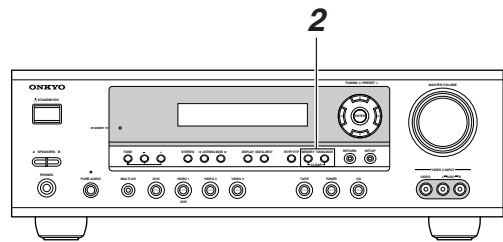

Deleting Presets

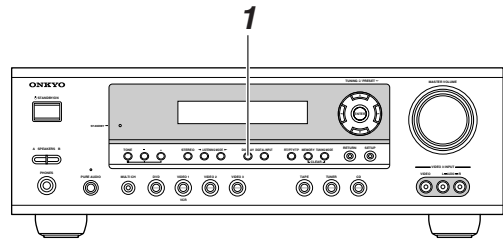

- | | |
|--|--|
| 1 | Select the preset that you want to delete.
See the previous section. |
| 2
<small>MEMORY TUNING MODE</small>
 | While holding down the [MEMORY] button, press the [TUNING MODE] button.
The selected preset is deleted and its number disappears from the display. |

Displaying Radio Information



- | | |
|---|--|
| 1
<small>DISPLAY</small>
 | Press the [DISPLAY] button repeatedly to cycle through the available information. |
|---|--|

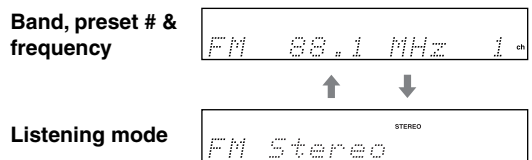

Selecting Preset Stations

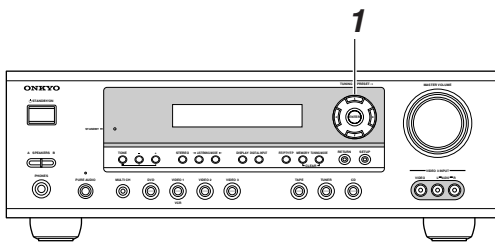

- | | |
|---|---|
| 1
<small>TUNING PRESET</small>
 | Use the PRESET [◀]/[▶] buttons, or the remote controller's CH [+/-] button to select a preset. |
|---|---|

Using RDS (European models only)

RDS only works with European models and only in areas where RDS broadcasts are available. When tuned into an RDS station, the RDS indicator appears.

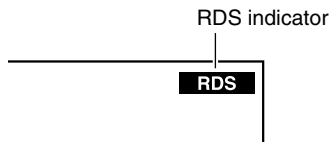

■ What is RDS?

RDS stands for *Radio Data System* and is a method of transmitting data in FM radio signals. It was developed by the European Broadcasting Union (EBU) and is available in most European countries. Many FM stations use it these days. In addition to displaying text information, RDS can also help you find radio stations by type (e.g., news, sport, rock, etc.).

The AV receiver supports four types of RDS information:

PS (Program Service)

When tuned to an RDS station that's broadcasting PS information, the station's name appears. When you press the [DISPLAY] button, the frequency is displayed for three seconds.

RT (Radio Text)

When tuned to an RDS station that's broadcasting RT text information, that information is shown on the display (see page 39).

PTY (Program Type)

You can also search for radio stations by type (see page 39).

TP (Traffic Program)

You can also search for TP radio stations (see page 39).

Notes:

- In some cases, the text characters displayed on the AV receiver may not be identical to those broadcast by the radio station. Also, unexpected characters may be displayed when unsupported characters are received. This is not a malfunction.
- If the signal from an RDS station is weak, RDS data may be displayed intermittently or not at all.

Program Types Used in Europe (PTY)

Type	Display	Description
None	NONE	No program type.
News reports	NEWS	Reports on current events and happenings.
Current affairs	AFFAIRS	Topical reporting of current affairs, often with a wider range of topics than news reports.
Information	INFO	General information such as weather forecasts, consumer affairs, medical help, etc.
Sport	SPORT	Live sports action, sports news, and interviews.
Education	EDUCATE	Formal educational programs.
Drama	DRAMA	Radio plays and serials.
Culture	CULTURE	Cultural programs (including religious affairs).
Science and technology	SCIENCE	Programs about the natural sciences and technology.
Varied	VARIED	Speech-based programs not covered by the above categories (e.g., quizzes, panel games, and comedy).
Pop music	POP M	Popular commercial music, usually from past or present sales charts (e.g., Top 40).
Rock music	ROCK M	Popular music with an alternative appeal, often not appearing on sales charts.
Middle of the road music	M.O.R.M	Easy listening music (as opposed to Pop, Rock, or Classical).
Light classics	LIGHT M	Classical music for general rather than specialist appreciation.
Serious classics	CLASSICS	Performances of major orchestral works, symphonies, chamber music, etc. (including the Grand Opera).
Other music	OTHER M	Music styles not covered by the above categories (e.g., Jazz, Rhythm & Blues, Folk, Country, and Reggae).
Alarm	ALARM	When an RDS station is making an emergency broadcast, ALARM will flash on the display.

Using the Tuner—Continued

Displaying Radio Text (RT)

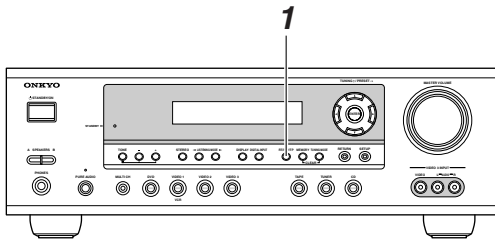

When tuned to an RDS station that's broadcasting RT text information, that information can be displayed.

1

RT/PTY/TP



Press the [RT/PTY/TP] button once.

The RT information scrolls across the display.

Notes:

- The message "Waiting" may appear while the AV receiver waits for RT information.
- If the message "No Text Data" appears on the display, no RT information is available.

Finding Stations by Type (PTY)

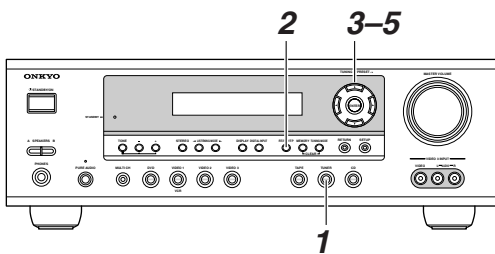

You can search for radio stations by type.

1

TUNER



Use the [TUNER] input selector button to select FM.

2

RT/PTY/TP



Press the [RT/PTY/TP] button twice.

The current program type appears on the display.

3

TUNING / PRESET



Use the PRESET [◀]/[▶] buttons to select the type of program you want.

See the table on page 38.

4



To start the search, press [ENTER].

The AV receiver searches until it finds a station of the type you specified, at which point it stops briefly before continuing with the search.

5



When a station you want to listen to is found, press [ENTER].

If no stations are found, the message "Not Found" appears.

Listening to Traffic News (TP)

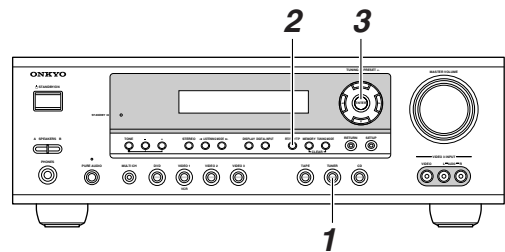

You can search for TP radio stations.

1



Use the [TUNER] input selector button to select FM.

2



Press the [RT/PTY/TP] button three times.

If the current radio station is broadcasting TP (Traffic Program), "[TP]" will appear on the display, and traffic news will be heard as and when it's broadcast. If "TP" without square brackets appears, this means that the station is not broadcasting TP.

3



To locate a station that is broadcasting TP, press [ENTER].

The AV receiver searches until it finds a station that's broadcasting TP. If no stations are found, the message "Not Found" appears.

Common Functions

This chapter explains functions that can be used with any input source.

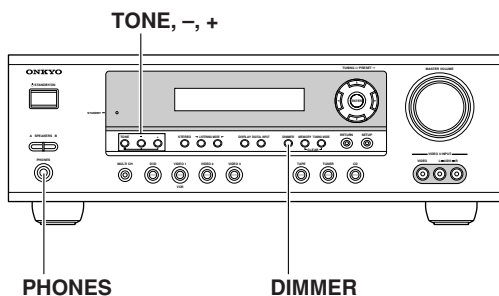
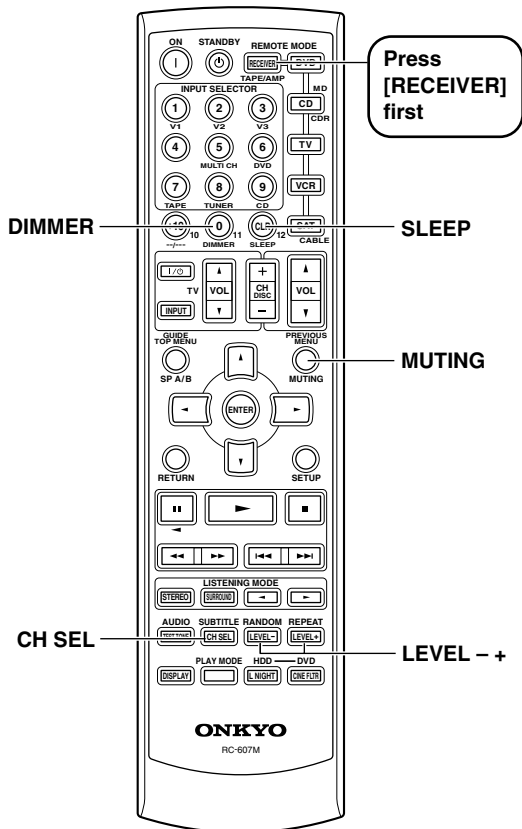

Setting the Display Brightness

With this function, you can adjust the brightness of the display.



Press the remote controller's [DIMMER] button repeatedly to select: dim, dimmer, or normal brightness.

Alternatively, you can use the [DIMMER] button on the AV receiver (not European models).

Adjusting the Bass & Treble

You can adjust the bass or treble for the front speakers except when the Direct or Pure Audio (not North American model) listening mode is selected.



1 Press the AV receiver's [TONE] button repeatedly to select either Bass or Treble.

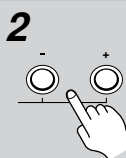

2 Use the TONE [-]/[+] buttons to adjust.

■ Bass

You can boost or cut low-frequency sounds output by the front speakers from -10 dB to +10 dB in 2 dB steps.

■ Treble

You can boost or cut high-frequency sounds output by the front speakers from -10 dB to +10 dB in 2 dB steps.

Note:

- To bypass the bass and treble tone circuits, select the Direct or Pure Audio (not North American model) listening mode.

Muting the AV Receiver

With this function, you can temporarily mute the output of the AV receiver.



Press the remote controller's [MUTING] button.

The output is muted and the MUTING indicator flashes on the display, as shown.



To unmute the AV receiver, press the remote controller's [MUTING] button again, or adjust the volume. The output is unmuted and the MUTING indicator goes off. Muting is cancelled when the AV receiver is set to Standby.

Using the Sleep Timer

With the sleep timer, you can set the AV receiver so that it automatically turns off after a set period.



Press the remote controller's [SLEEP] button repeatedly to select the required sleep time.

You can set the sleep time from 90 to 10 minutes in 10 minute steps.

The SLEEP indicator appears on the display when the sleep timer has been set, as shown. The specified sleep time appears on the display for about five seconds, then the previous display reappears.

SLEEP indicator

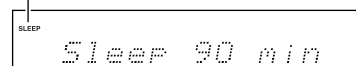

To cancel the sleep timer, press the [SLEEP] button repeatedly until the SLEEP indicator disappears.

To check the remaining sleep time, press the [SLEEP] button. Note that if you press the [SLEEP] button while the sleep time is being displayed, you'll shorten the sleep time by 10 minutes.

Using Headphones

You can connect a pair of stereo headphones (1/4-inch phone plug) to the AV receiver's PHONES jack for private listening, as shown.

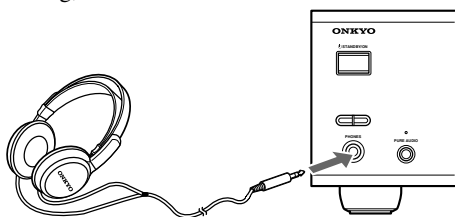

Notes:

- Always turn down the volume before connecting your headphones.
- Speaker sets A and B are turned off while the headphones plug is inserted in the PHONES jack.
- When you connect a pair of headphones, the listening mode is set to Stereo, unless it's already set to Pure Audio, Mono, Stereo, or Direct.
- When the multichannel DVD input is selected, only the front left and front right channels can be heard in the headphones.

Adjusting Speaker Levels

You can adjust the level of each speaker in speaker set A while listening to an input source. These temporary adjustments are cancelled when the AV receiver is set to Standby.

1

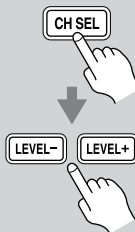

Use the remote controller's [CH SEL] button to select each speaker, and use the [LEVEL-] and [LEVEL+] buttons to adjust the volume.

You can adjust the volume of each speaker from -12 dB to +12 dB (-15 dB to +12 dB for the subwoofer).

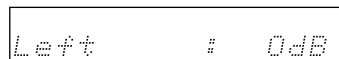

Notes:

- You cannot use this function while the AV receiver is muted.
- Speakers that are set to No or None in the Speaker Configuration cannot be adjusted.

■ Speaker Set B

While speaker set B is on, you can also adjust the levels of the left and right speakers in speaker set B, from -12 dB to +12 dB.

- These settings are stored when the AV receiver is set to Standby.
- While speaker set B is on, you cannot adjust the levels of speaker set A's surround back speakers.

■ Headphones

While a pair of headphones is connected, you can adjust the volume of the left and right channels individually, from -12 dB to +12 dB each.

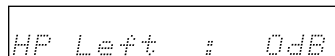

- These settings are stored when the AV receiver is set to Standby.

■ Multichannel DVD Input

While the multichannel DVD input is selected, you can adjust the level of each 5.1 channel input individually, from -12 dB to +12 dB. (-30 to +12 dB for the subwoofer.)

- These settings are stored when the AV receiver is set to Standby.
- Individual speaker levels can also be adjusted in "3. MultiLevel Setup" (see page 51).

Using the Listening Modes

Selecting Listening Modes

See “About the Listening Modes” on page 44 for detailed information about the listening modes.

- The Dolby Digital and DTS listening modes can only be selected if your DVD player is connected to the AV receiver with a digital audio connection (coaxial or optical).
- Listening mode availability depends on the format of the current input signal.
- While a pair of headphones is connected, you can select only the Pure Audio (not North American model), Mono, Direct, or Stereo listening mode.

Selecting on the AV receiver

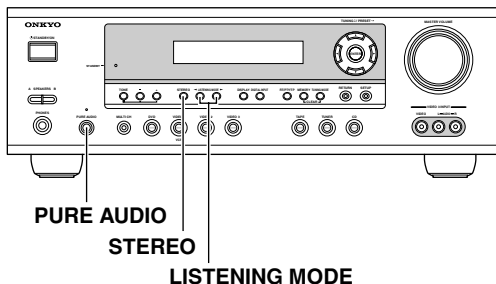

- **[PURE AUDIO] button (not North American model)**
This button selects the Pure Audio listening mode. When this mode is selected, the AV receiver outputs no video signals and its display is turned off.
- **[STEREO] button**
This button selects the Stereo listening mode.
- **LISTENING MODE [◀/▶] buttons**
Pressing these buttons repeatedly cycles through all of the listening modes that can be used with the current input source.

Selecting with the Remote Controller

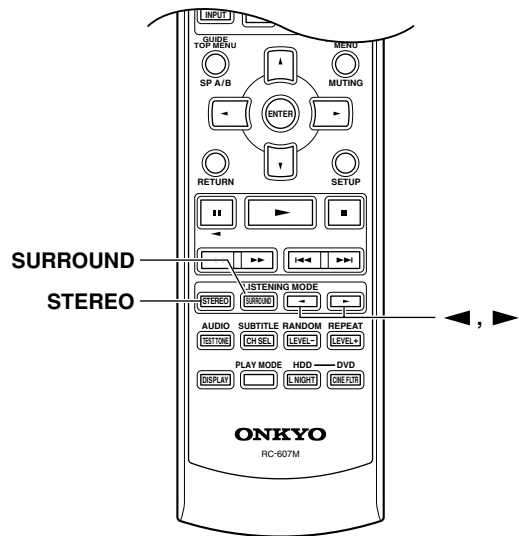

- **[STEREO] button**
This button selects the Stereo listening mode.
- **[SURROUND] button**
This button selects the Dolby Digital and DTS listening modes.
- **LISTENING MODE [◀/▶] buttons**
Pressing these buttons repeatedly cycles through all of the listening modes that can be used with the current input source.

Using the Listening Modes—Continued

The following table lists all the listening modes and shows which modes can be selected for each input signal format.

Input signal format		Analog, PCM ^{*1}	Dolby D				DTS/DTS 96/24 ^{*2}				Multich
			*1/2	2/0 (Stereo)	1/0,1+1	Other	3/2.1	2/0 (Stereo)	DTS-ES		
Listening mode		Source	DVD, DTV, etc.				DVD, CD, etc.				DVD
		CD, TV, VHS, MD, turntable, radio, cassette, DTV, etc.									
Pure Audio (not North American model) Direct		✓	✓	✓	✓	✓	✓	✓	✓	✓	✓
Stereo Mono		✓	✓	✓	✓	✓	✓	✓	✓	✓	
Multich											✓
PLIIx Movie/Music/Game ^{*3} Neo:6 Cinema Neo:6 Music ^{*4}		✓		✓				✓			
Dolby	Dolby D		✓			✓					
	Dolby D EX Dolby D+PLIIx Music		✓								
	Dolby D+PLIIx Movie		✓								
DTS	DTS, DTS 96/24						✓			✓ ^{*5}	
	DTS-ES Discrete								✓		
	DTS-ES Matrix									✓	
	DTS+Neo:6 DTS+Dolby EX DTS+PLIIx Music						✓				
	DTS+PLIIx Movie						✓				
Onkyo Original DSP	Mono Movie Orchestra Unplugged Studio-Mix TV Logic All Ch Stereo Full Mono ^{*4}	✓	✓	✓	✓	✓	✓	✓	✓	✓	

*1. In the Pure Audio and Direct listening modes, PCM signals at 32 kHz, 44.1 kHz, and 48 kHz are processed at 64 kHz, 88.2 kHz, and 96 kHz respectively. 96 kHz signals are processed at 48 kHz for all listening modes other than Pure Audio, Direct, and Stereo.

*2. In the Pure Audio, Direct, Stereo, and DTS 96/24 listening modes, signals are processed as DTS 96/24. Everything else is processed as DTS.

*3. If the Surr Back parameter is set to "None," or speaker set B is on, PLII is used.

*4. Available only when Surround speakers are connected.

*5. If the Surr Back setting is set to "None," or speaker set B is on, DTS is used.

■ : Not available when the Surr Back parameter is set to None, or when speaker set B is on.

■ : Not available when the Surr Back parameter is set to None or 1ch, or when speaker set B is on.

Tip: You can check the format of the digital input signal on page 35, "Displaying Source Information."

About the Listening Modes

With its built-in surround-sound decoders and DSP programs, the AV receiver can transform your home listening room into a movie theater or concert hall.

The AV receiver's surround indicators show which speakers are active in each listening mode.

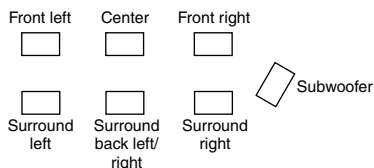

Direct

The selected input source is output directly with minimal processing for a pure sound.

Pure Audio (not North American model)

As an extension of Direct mode, this mode turns off the display, turns off the power to the video circuitry, and minimizes any other possible noise sources, providing a high fidelity sound that's true to the original. (Since the power to the video circuitry is turned off, no video signals are output while this mode is selected.)

Stereo

The selected input source is processed as a stereo signal and output by the front left and right speakers and the subwoofer.

Mono

Use this mode when watching an old movie with a mono soundtrack, or to select multilingual soundtracks recorded in the left and right channels of some movies. It can also be used when playing a DVD or other source with multiplexed audio, such as a karaoke DVD.

Dolby Pro Logic II Movie

Use this mode with DVDs and videos that bear the Dolby Surround logo or TV shows that feature Dolby Surround. You can also use this mode with stereo movies or TV shows and the AV receiver will create a 5.1 surround mix from the 2-channel stereo.

Dolby Pro Logic II Music

Use this mode to add 5.1 surround to stereo sources such as music CDs and DVDs.

Dolby Pro Logic IIx

If you've connected surround back speakers to the AV receiver, Dolby Pro Logic IIx allows you to enjoy 7.1-channel playback from 2-channel or 5.1-channel music or movies. Dolby Pro Logic IIx provides a well defined, natural multichannel surround-sound experience, putting the listener in a seamless envelope of sound. The added drama and natural sound enhance the listening experience with CDs, movies, and games.

Dolby Pro Logic IIx has three modes of operation: Movie mode for movies, Music mode for listening to music, and Game mode for use with games consoles with 2-channel stereo outputs.

Dolby Digital

With this format you can experience the same superb sound that you get at a movie theater or concert hall. Use this mode with DVDs that bear the Dolby Digital logo.

Dolby Digital EX

With an added surround-back channel, this 6.1 channel format offers a heightened sense of space, for added realism with moving sounds, such as those that rotate 360 degrees or pass overhead. Dolby Digital EX material can also be played on conventional 5.1 channel systems, in which case the surround-back channel audio is split between the surround left and right channels. Use this mode with DVDs that have a 5.1-channel soundtrack and bear the Dolby Digital logo.

DTS

This digital surround format offers a surround sound experience with exceptional fidelity. It uses compressed digital audio data, with six discrete channels (5.1), and the ability to handle large amounts of audio data while remaining faithful to the original. DTS provides very high-quality sound. You'll need a DTS compatible DVD player in order to enjoy DTS material. Use this mode with DVDs and CDs that bear the DTS logo.

DTS 96/24

This mode provides higher audio quality. Use it with CDs and DVDs that bear the DTS 96/24 logo.

DTS-ES Discrete

This is DTS with an added surround back channel for 6.1 surround sound. Use it with program material recorded in DTS 6.1 format. With the additional surround back channel, this format offers 6.1 fully independent digital channels, providing a realistic sense of movement and space. Use it with program material recorded in DTS 6.1, such as CDs and DVDs that bear the DTS-ES logo.

DTS-ES Matrix

This is DTS with an added surround back channel for 6.1 surround sound. Use it to provide 6.1 channel surround playback with program material recorded in DTS 5.1 format. Since DTS 5.1 program material contains surround back channel information, all channels can be reconstructed for 6.1-channel playback. Use this mode with CDs and DVDs that bear the DTS-ES or DTS logo.



Neo:6

This mode provides 6.1-channel playback from 2-channel sources. It offers six full-bandwidth channels with excellent separation. There are two modes of operation: Cinema mode for movies, and Music mode for listening to music.

Cinema mode simulates the realistic sense of movement that you get with 6.1-channel surround sound sources. Use this mode with videos, DVDs, and TV shows that feature stereo sound.

Music mode uses the surround channels to simulate a natural sound field that cannot be produced with conventional stereo. Use this mode with stereo material such as music CDs.

Onkyo Original DSP Modes

Mono Movie

This mode is suitable for use with old movies and other mono sound sources. The center speaker outputs the sound as it is, while reverb is applied to the sound output by the other speakers, giving presence to even mono material.

Orchestra

Suitable for classical or operatic music. The surround channels are emphasized in order to widen the stereo image. In addition, it simulates the natural reverberation of a large hall.

Unplugged

Suitable for acoustic instrument sounds, vocals, and jazz music. By emphasizing the front stereo image, it simulates the stage-front experience.

Studio-Mix

Suitable for rock and pop music. Listening to music in this mode creates a lively sound field with a powerful acoustic image, like being at a club or rock concert.

TV Logic

Adds realistic acoustics to TV shows produced in a TV studio. In addition, it adds surround effects to the entire sound and adds clarity to voices.

All Ch Stereo

Ideal for background music. The front, surround, and surround back channels create a stereo image that fills the entire listening area.

Full Mono

In this mode, all speakers output mono audio, so the music sounds the same regardless of where you are.

Adjusting the Listening Modes

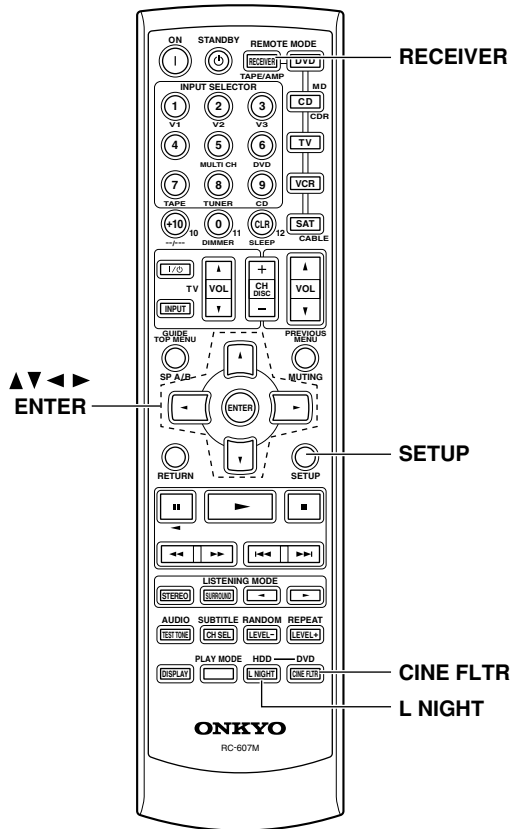

Using the CinemaFILTER

With the CinemaFILTER, you can soften overly bright movie soundtracks, which are typically mixed for reproduction in a movie theater.

CinemaFILTER can be used with the following listening modes: Dolby Digital, Dolby Digital EX, Dolby Pro Logic II Movie, Dolby Pro Logic IIx Movie, DTS, DTS-ES, DTS Neo:6 Cinema, DTS 96/24, DTS+Neo:6, and DTS+Dolby EX.

1



Press the [RECEIVER] button, and then press the [CINE FLTR] button repeatedly to select:

On: CinemaFILTER on.

Off: CinemaFILTER off.

Using the Audio Adjust Functions

These functions only work with speaker set A.

Audio Adjust provides various functions for adjusting the sound.

1



Press the [RECEIVER] button followed by the [SETUP] button.

2

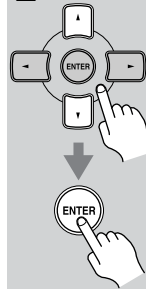

Use the Up and Down [▲]/[▼] buttons to select "4. Audio Adjust," and then press the [ENTER] button.

4. Audio Adjust

Using the Late Night Function (Dolby Digital only)

With the Late Night function, you can reduce the dynamic range of Dolby Digital material so that you can still hear quiet parts even when listening at low volume levels—ideal for watching movies late at night when you don't want to disturb anyone.

1



Press the [RECEIVER] button, and then press the [L NIGHT] button repeatedly to select:

Off: Late Night function off.

Low: Small reduction in dynamic range.

High: Big reduction in dynamic range.

Notes:

- The effect of the Late Night function depends on the Dolby Digital material that you are playing, and with some material there will be little or no effect.
- The Late Night function is set to Off when the AV receiver is set to Standby.

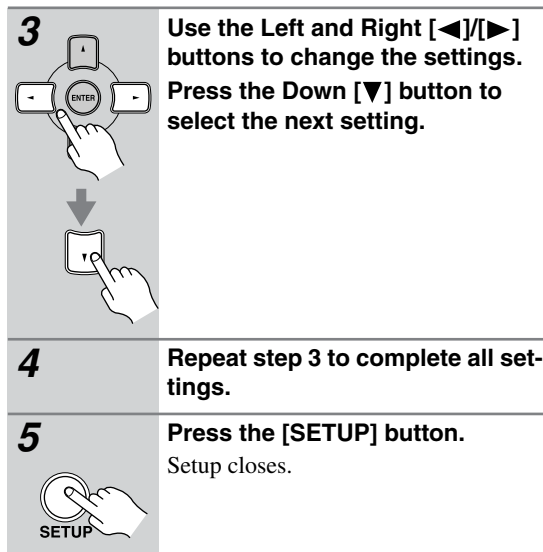

The Audio Adjust functions are explained below.

Input Channel Settings

■ Multiplex

This setting determines which channel is output from a stereo multiplex source. Use it to select audio channels or languages with multiplex sources, multilingual TV broadcasts, and so on.

Main: The main channel is output (default).

Sub: The sub channel is output.

M/S: Both the main and sub channels are output.

■ Mono (2ch)

This setting determines which channel is output when the Mono listening mode is used with a stereo source.

L+R: Both the left and right channels are output (default).

L: Only the left channel is output.

R: Only the right channel is output.

PL II & PL IIX Music Mode Settings

These settings apply to only 2-channel (stereo) sources.

■ Panorama

With this function, you can broaden the width of the front stereo image when using the Pro Logic II Music or Pro Logic IIX Music listening mode.

On: Panorama function on.

Off: Panorama function off (default).

■ Dimension

With this setting, you can move the sound field forward or backward when using the Pro Logic II Music or Pro Logic IIX Music listening mode. The default setting is 3. Higher settings move the sound field forward. Lower settings move it backward.

If the stereo image feels too wide, or there's too much surround sound, move the sound field forward to improve the balance. Conversely, if the stereo image feels like it's in mono, or there's not enough surround sound, move it backward.

■ Center Width

With this function, you can adjust the width of the sound from the center speaker when using the Pro Logic II Music or Pro Logic IIX Music listening mode. Normally if you're using a center speaker, the center channel sound is output by only the center speaker. (If you're not using a center speaker, the center channel sound will be distributed to the front left and right speakers to create a phantom center). This setting controls the front left, right, and center mix, allowing you to adjust the weight of the center channel sound. It can be adjusted from 0 to 7 (default is 3).

DTS Neo:6 Music Mode Setting

■ Center Image

The DTS Neo:6 Music listening mode creates 6-channel surround sound from 2-channel (stereo) sources. With this setting, you can specify by how much the front left and right channel output is attenuated in order to create the center channel. It can be adjusted from 0 to 5 (default is 3). This setting is unavailable if no surround speakers are connected.

When set to 0, the front left and right channel output is attenuated by half (–6 dB), giving the impression that the sound is located centrally. This setting works well when the listening position is considerably off center. When set to 5, the front left and right channels are not attenuated, maintaining the original stereo balance.

Dolby Digital EX Input Signal Setting

■ Dolby D EX

This setting determines how Dolby Digital EX signals are handled. This setting is unavailable if no surround back speakers are connected or speaker B is on.

Auto: If the source signal contains a Dolby Digital EX flag, the Dolby Digital EX listening mode is used (default).

Manual: You can select Pro Logic IIX Movie, Pro Logic IIX Music, Dolby Digital, or Dolby Digital EX.

Recording

This chapter explains how to record the selected input source to an AV component with recording capability, and how to record audio and video from two different sources.

Recording the Input Source

You can record only to AV components that are connected to the TAPE OUT or VIDEO 1 OUT jacks. See pages 20–29 for information on connecting your AV components to the AV receiver.

1

Use the input selector buttons to select the AV component that you want to record.

Audio signals from the selected input source are output by the VIDEO 1 OUT and TAPE OUT jacks.

You can listen to the source while recording. The AV receiver's VOLUME control has no effect on recording.

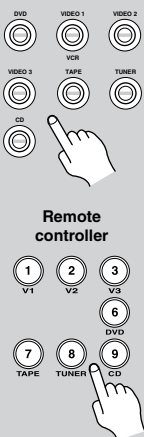

2

Start recording on the AV component connected to the TAPE OUT or VIDEO 1 OUT jacks.

3

Start playback on the source AV component.

Notes:

- You cannot record from AV components that are connected to the digital inputs. You must use analog connections.
- The surround effects produced by the surround and DSP listening modes cannot be recorded.
- You cannot record from an AV component that is connected to the multichannel input.
- If you select another input source while recording, that input source will be recorded instead.
- While the Pure Audio listening mode is selected, the VIDEO 1 OUT V and S jacks don't output video signals, so select another mode when recording.

Recording from Different AV Sources

With this function, you can record audio and video from different sources, allowing you to overdub audio onto your video recordings. This function takes advantage of the fact that when an audio-only input source (i.e., TAPE, TUNER, or CD) is selected, the video input source remains unchanged. For example, if you first select the VIDEO 3 input source, followed by the CD input source, you can watch the video from the VIDEO 3 input and listen to the audio from the CD input.

In the following example, audio from the CD player connected to the CD IN jacks, and video from the camcorder connected to the VIDEO 3 INPUT VIDEO jack are recorded by the VCR, which is connected to the VIDEO 1 OUT jacks.

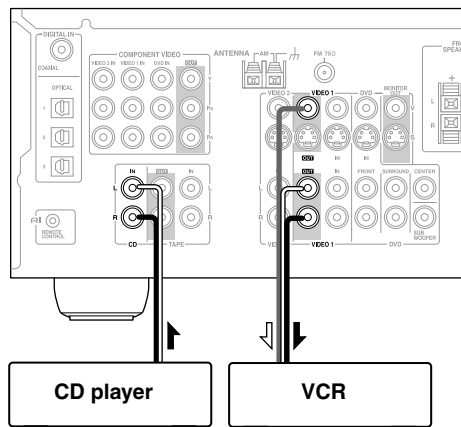
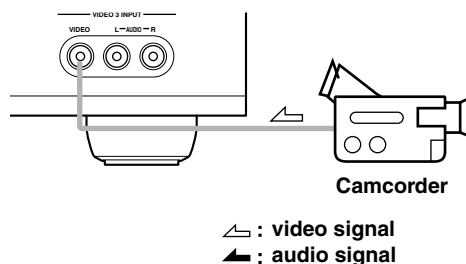

- 1. Prepare the camcorder and CD player for playback.**
- 2. Prepare the VCR for recording.**
- 3. Press the [VIDEO 3] input selector button.**
- 4. Press the [CD] input selector button.**
This selects the CD player as the audio source, but leaves the camcorder as the video source.
- 5. Start recording on the VCR and start playback on the camcorder and CD player.**
The video from the camcorder and the audio from the CD player are recorded by the VCR.

Advanced Setup

Advanced Speaker Settings

The advanced speaker settings cannot be changed while headphones are connected, Speaker set B is on, or the multichannel input is being used.

Crossover Frequency

To get the best bass performance from your speaker system, you need to set the crossover frequency according to the size and frequency response of your subwoofer and other speakers (front, center, and surround).

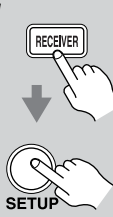
1  Press the [RECEIVER] button followed by the [SETUP] button on the remote controller.

2  Use the Up and Down [▲]/[▼] buttons to select "1. Speaker Config," and then press the [ENTER] button.

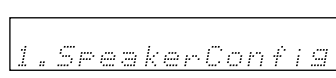

3  Use the Down [▼] button to select "Crossover," and then use the Left and Right [◀]/[▶] buttons to select a crossover frequency.

Choose a crossover frequency suitable for your setup.

If you're using a subwoofer, choose a crossover frequency based on the diameter of your front speakers.

If you're not using a subwoofer, use the diameter of the first speaker that you specified as Small in steps 4 through 7 in the "Speaker configuration" setting (see page 32).

Speaker cone diameter	Crossover frequency
Over 8 in. (20 cm)	60Hz
6-1/2 to 8 in. (16–20 cm)	80Hz
5-1/4 to 6-1/2 in. (13–16 cm)	100Hz (default)
3-1/2 to 5-1/4 in. (9–13 cm)	120Hz
Under 3-1/2 in. (9 cm)	150Hz

Continue with step 4 of the "Double Bass" setting.

Note:

- For a more accurate setting, look up the frequency response in the manuals supplied with your speakers and set accordingly. In addition, listen to some music that you know well and choose a higher crossover frequency if you think there's not enough sound coming from the subwoofer; a lower setting if you think there's too much.

Double Bass

With the Double Bass function, you can boost bass output by feeding bass sounds from the front left and right channels to the subwoofer. This function can be set only if the Subwoofer setting (step 3) is set to Yes, and the Front setting (step 4) is set to Large in the Speaker Configuration on page 32.

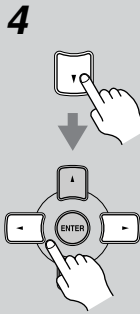
4  Use the Down [▼] button to select "Double Bass," and then use the Left and Right [◀]/[▶] buttons to select:

On: Double Bass function on.
Bass from the front left and right channels is also fed to the subwoofer (default).

Off: Double Bass function off.

5  Press the [SETUP] button.
Setup closes.

Speaker Distance

To get the best from surround sound, it's important that the sound from each speaker reaches the listener at the same time. To achieve this, you need to specify the distance from each speaker to the listening position.

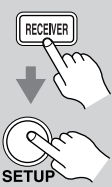
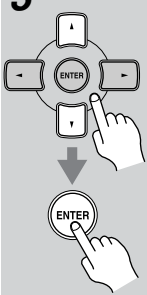
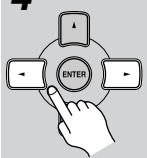
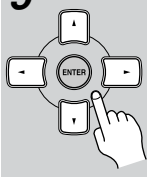
1	Measure and make a note of the distance from each speaker to the listening position.
2	<p>Press the [RECEIVER] button followed by the [SETUP] button on the remote controller.</p> 
3	<p>Use the Up and Down [▲]/[▼] buttons to select "2. Sp Distance," and then press the [ENTER] button.</p>  <div style="border: 1px solid black; padding: 5px; width: fit-content; margin: 10px auto;">2. Sp Distance</div>
4	<p>While "Unit" is displayed, use the Left and Right [◀]/[▶] buttons to select "feet" or "meters".</p> <p>feet: Distances in feet. Can be set from 1 to 30 feet in 1-foot steps.</p> <p>meters: Distances in meters. Can be set from 0.3 to 9 meters in 0.3-meter steps.</p> 
5	<p>Use the Down [▼] button to select "Front," and use the Left and Right [◀]/[▶] buttons to specify the distance for the "front speakers," then press the Down [▼] button to select the next speaker.</p> 
6	<p>Repeat step 5 for all speakers.</p> <p>Note: Speakers that you set to No or None in the Speaker Configuration (page 32) cannot be selected.</p>
7	<p>Press the [SETUP] button. Setup closes.</p>

Notes:

- The Center and Subwoofer distances can be set up to 5 ft. (1.5 m) more or less than the Front distance. For example, if the Front distance is set to 20 ft. (6 m), the Center and Subwoofer distances can be set between 15 and 25 ft. (4.5 and 7.5 m).
- The Surround and Surround Back distances can be set up to 5 ft. (1.5 m) more or 15 ft. (4.5 m) less than the Front distance. For example, if the Front distance is set to 20 ft. (6 m), the SurrRight, Surr Left, Surr Back R, and Surr Back L distances can be set between 5 and 25 ft. (1.5 and 7.5 m).

Speaker Levels

With this function, you can adjust the volume of each speaker so that all speakers can be heard equally at the listening position.

Speaker levels cannot be adjusted while the AV receiver is muted.

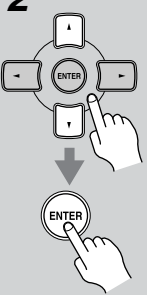
1	<p>Press the [RECEIVER] button followed by the [SETUP] button on the remote controller.</p> 
2	<p>Use the Up and Down [▲]/[▼] buttons to select "3. Level Cal," and then press the [ENTER] button.</p> <p>A pink noise test tone is output by the front left speaker.</p>  <div style="border: 1px solid black; padding: 5px; width: fit-content; margin: 10px auto;">3. Level Cal</div>
3	<p>Turn up the volume so that you can hear the test tone sufficiently.</p> <p>While each speaker outputs the test tone, its name appears on the display, as shown.</p> <div style="border: 1px solid black; padding: 5px; width: fit-content; margin: 10px auto;">Left : 0dB</div>

- 4** Use the Left and Right [◀]/[▶] buttons to adjust the speaker level, and use the Down [▼] button to select the next speaker. The level can be adjusted from -12 to +12 dB in 1 dB steps (-15 to +12 dB for the subwoofer).
- 5** Repeat step 4 so that the level of the test tone from each speaker is the same. Speakers that you set to No or None in the Speaker Configuration (page 32) do not output the test tone.
- 6** Press the [SETUP] button. Setup closes. Don't forget to turn down the volume if you turned it up while setting the levels.

Note:

- A quicker way to adjust the speaker levels is to press the remote controller's [TEST TONE] button to output the test tone, use the [LEVEL-] and [LEVEL+] buttons to adjust the levels, and use the [CH SEL] button to select the speakers.
- If the multichannel input is selected (page 35), in step 2, the "3. MultiLevel" menu appears instead of the "3. Level Cal" menu, and you can adjust the level of each channel of the multichannel input regardless of the Speaker Configuration settings.

Digital Input Signal Formats

The following table shows the display indicators for each supported digital signal format.

Format	Display
Dolby Digital	DD D
DTS	dts
PCM	PCM

Normally, the AV receiver detects the signal format automatically. However, if you experience either of the following issues when playing PCM or DTS material, you can manually set the signal format to PCM or DTS:

- If the beginnings of tracks from a PCM source are cut off, try setting the format to PCM.
- If noise is produced when fast forwarding or reversing a DTS CD, try setting the format to DTS.

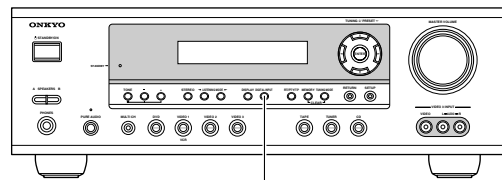

DIGITAL INPUT

- 1** Press and hold the AV receiver's [DIGITAL INPUT] button for about 3 seconds.
- 2** While "Auto" is displayed (about 3 seconds), press the [DIGITAL INPUT] button again to select: **PCM, DTS, or Auto.**
DTS or PCM: The DTS or PCM indicator, depending on which format you have set, flashes, and only signals in that format are output. Digital signals in other formats are ignored.
Auto (default): The format is detected automatically. If no digital input signal is present, the corresponding analog input is used instead.

Controlling Other Components

You can use the AV receiver's remote controller (RC-607M) to control your other components, including those made by other manufacturers. This chapter explains how to enter the necessary remote control code for the component that you want to control (e.g., DVD player, TV, or VCR).

Entering Remote Control Codes

Entering a remote control code for each REMOTE MODE button allows you to control your other components with the remote controller. You'll need to perform this procedure for each component that you want to control.

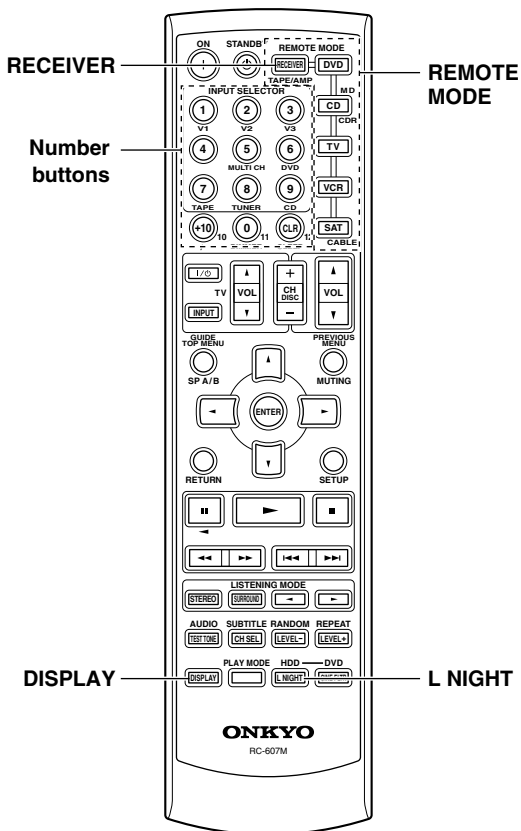

1

Look up the remote control code for the component in the appropriate category.

See the separate Remote Control Codes.

2

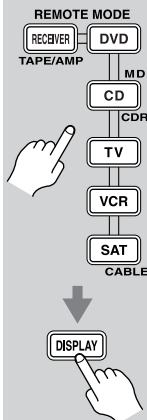

While holding down the REMOTE MODE button that you want to set, press the [DISPLAY] button for 3 seconds.

The REMOTE MODE button lights up.

3

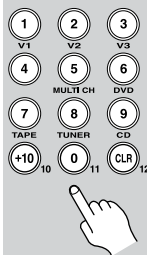

Within 30 seconds, use the number buttons to enter the 4-digit remote control code.

The REMOTE MODE button flashes twice.

4

Press the REMOTE MODE button again to select the remote controller mode, point the remote controller at the component, and check the operation.

If the remote controller works OK, the code has been entered correctly. If not, try again or try another code.

Notes:

- A remote control code cannot be entered for the [RECEIVER] button.
- There are the only codes available at the time that this instruction manual was printed.
- If the codes don't work, try using other manufacture's codes to see if it will help you preprogram your remote controller.

Remote Control Codes for Onkyo Components Connected via RI

Onkyo components that are connected via **RI** can be controlled by pointing the remote controller at the AV receiver. This means that you can control such components even if they are out of sight, for example, installed in a rack.

- 1** Make sure the Onkyo component is connected with an **RI** cable and an analog audio cable (RCA).
See page 29 for details.
- 2** Enter the appropriate remote control code for the [DVD] or [CD] REMOTE MODE button.
[DVD] REMOTE MODE button
 1612: DVD player with **RI**
[CD] REMOTE MODE button
 1327: CD player with **RI**
 1808: MD recorder with **RI**
 1322: CD recorder with **RI**
See the previous page for information on entering remote control codes.
- 3** Press the [DVD] or [CD] REMOTE MODE button, point the remote controller at the AV receiver, and operate the component.

If you want to control an Onkyo component by pointing the remote controller directly at it, or you want to control an Onkyo component that's not connected via **RI**, enter the following remote control codes:

- [DVD] REMOTE MODE button
 0627: DVD player without **RI** (default)
- [CD/MD/CDR] REMOTE MODE button
 1817: CD player without **RI** (default)
 0868: MD recorder without **RI**
 1323: CD recorder without **RI**

Note:

If you connect an **RI**-compatible Onkyo MiniDisc or CD recorder to the TAPE IN/OUT jacks, for remote operation to work properly, you must set the display to MD or CDR (see page 31).

Resetting the REMOTE MODE Buttons

If you've previously entered a code for a REMOTE MODE button but now want to reset it, perform the following procedure.

<p>1</p>	<p>While holding down the REMOTE MODE button that you want to reset, press the [L NIGHT] button for 3 seconds.</p> <p>The REMOTE MODE button lights up.</p>
<p>2</p>	<p>Press the REMOTE MODE button again.</p> <p>The REMOTE MODE button is reset and flashes twice.</p> <p>The [DVD] and [CD] REMOTE MODE buttons are preprogrammed with remote control codes for controlling Onkyo components. When one of these buttons is reset, the preprogrammed code is restored.</p>

Resetting the Remote Controller

You can reset the remote controller to its default settings.

<p>1</p>	<p>While holding down the [RECEIVER] button, press the [L NIGHT] button for 3 seconds.</p> <p>The [RECEIVER] button lights up.</p>
<p>2</p>	<p>Press the [RECEIVER] button again.</p> <p>The remote controller is reset and the [RECEIVER] button flashes twice.</p>

Controlling Other Components—Continued

To control another component, point the remote controller at it and use the buttons explained below. (You must select the appropriate remote control mode first.)

Controlling a TV

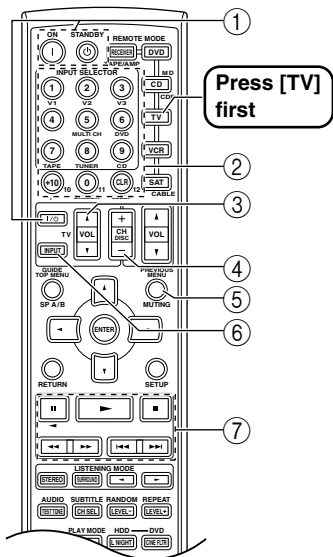

- ① **[ON], [STANDBY], TV [⏻/⏮]**
Sets the TV to On or Standby.
- ② **Number buttons**
Enter numbers.
- ③ **TV VOL [▲]/[▼]**
Adjusts the TV's volume.
- ④ **[CH +/-]**
Selects channels on the TV.
- ⑤ **[PREVIOUS]**
Selects the previous channel.
- ⑥ **[TV INPUT]**
Selects the TV's VCR input.
- ⑦ **[⏮], [▶], [■], [◀], [▶▶]**
Operates the VCR.

Controlling a VCR

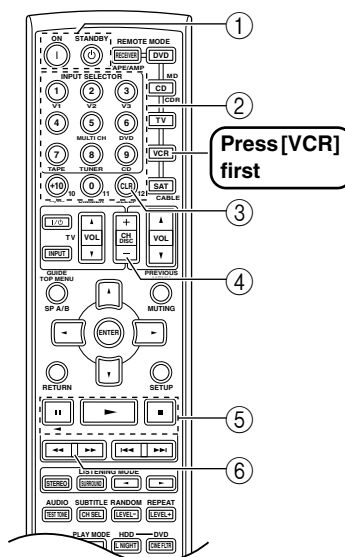

- ① **[ON], [STANDBY]**
Sets the VCR to On or Standby.
- ② **Number buttons**
Selects channels.
- ③ **[CLR]**
Cancels functions.
- ④ **[CH +/-]**
Selects channels on the VCR.
- ⑤ **[⏮], [▶], [■]**
Pause, Play, Stop.
- ⑥ **[◀◀], [▶▶]**
Rewind and Fast forward.

Controlling a Satellite/Cable Receiver

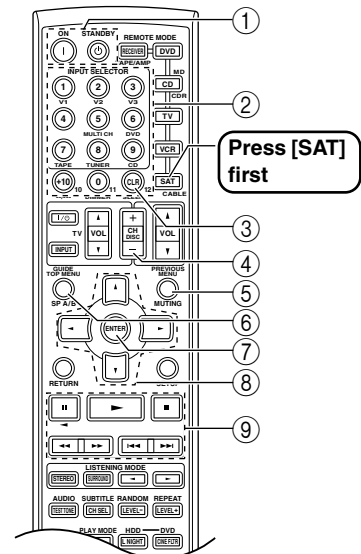

- ① **[ON], [STANDBY]**
Sets the satellite/cable receiver to On or Standby.
- ② **Number buttons**
Enter numbers.
- ③ **[CLR]**
Cancels functions.
- ④ **[CH +/-]**
Select satellite/cable channels.
- ⑤ **[PREVIOUS]**
Selects the previous channel.
- ⑥ **[GUIDE]**
Displays the program guide.
- ⑦ **[ENTER]**
Confirms the selection.
- ⑧ **[▲]/[▼]/[◀]/[▶]**
Selects menu items.
- ⑨ **[⏮], [▶], [■], [◀◀], [▶▶]**
Operates the VCR.

Troubleshooting

If you have any trouble using the AV receiver, look for a solution in this section. If you can't resolve the issue yourself, contact your Onkyo dealer.

Power

Can't turn on the AV receiver?

- Make sure that the power cord is properly plugged into the wall outlet.
- Unplug the power cord from the wall outlet, wait five seconds or more, then plug it in again.

The AV receiver turns off as soon as it's turned on?

- The amp protection circuit has been activated. Remove the power cord from the wall outlet immediately. Disconnect all speaker cables and input sources, and leave the AV receiver with its power cord disconnected for one hour. After that, reconnect the power cord, and then set the volume to maximum. If the AV receiver stays on, set the volume to minimum, disconnect the power cord, and reconnect your speakers and input sources properly. If the AV receiver turns off when you set the volume to maximum, disconnect the power cord, and contact your Onkyo dealer.

Audio

There's no sound or it's very quiet?

- Make sure that the digital input source is selected properly (page 31). Press the [DIGITAL INPUT] button repeatedly.
- Make sure that all audio connecting plugs are pushed in all the way (page 20).
- Make sure that the polarity of the speaker cables is correct, and that the bare wires are in contact with metal part of each speaker terminal (page 17)
- Make sure that the speaker cables are not shorting.
- Check the volume. It can be set to MIN, 1 through 79, or MAX (page 34). The AV receiver is designed for home theater enjoyment and has a wide volume range for precise adjustment.
- If the MUTING indicator is shown on the display, press the remote controller's [MUTING] button to unmute the AV receiver (page 40).
- While a pair of headphones is connected to the PHONES jack, no sound is output by the speakers (page 41).
- Check the digital audio output setting on the connected device. On some games consoles, such as those that can play DVDs, the default setting is off.
- With some DVD-Video discs, you need to select an audio format from a menu.
- If your turntable doesn't have a phono preamp built-in, you must connect one between it and the AV receiver.

If your turntable uses an MC cartridge, you must connect an MC head amp, or an MC transformer and a phono preamp.

- Specify the speaker distances and adjust the individual speaker levels (pages 50, 51).
- The input signal format is set to PCM or DTS. Set it to Auto (page 51).

Only the front speakers produce sound?

- When the Stereo or Mono listening mode is selected, only the front speakers and subwoofer produce sound.
- Make sure the speakers are configured correctly (page 32).

Only the center speaker produces sound?

- If you use the Pro Logic IIx Movie or Pro Logic IIx Music listening mode with a mono source, such as an AM radio station or mono TV program, the sound is concentrated in the center speaker.
- Make sure the speakers are configured correctly (page 32).

The surround speakers produce no sound?

- When the Stereo or Mono listening mode is selected, the surround speakers produce no sound (page 42).
- Depending on the source and current listening mode, not much sound may be produced by the surround speakers. Try selecting another listening mode.
- Make sure the speakers are configured correctly (page 32).

The center speaker produces no sound?

- When the Stereo or Mono listening mode is selected, the center speaker produces no sound (page 42).
- Make sure the speakers are configured correctly (page 32).

The surround back speakers produce no sound?

- The surround back speakers are not used with all listening modes. Select another listening mode (page 42).
- Not much sound may be produced by the surround back speakers with some sources.
- Make sure the speakers are configured correctly (page 32).
- When speaker set B is turned on, speaker set A is reduced to 5.1-channel playback, and the surround back speakers produce no sound.

The subwoofer produces no sound?

- The subwoofer outputs no sound while only speaker set B is on. Turn on speaker set A.
- When you play source material that contains no information in the LFE channel, the subwoofer produces no sound.
- Make sure the speakers are configured correctly (page 32).

Speaker set B produces no sound?

- Speaker set B outputs only analog input signals. Make sure that the analog audio cables are connected properly.

There's no sound with a certain signal format?

- Check the digital audio output setting on the connected device. On some games consoles, such as those that can play DVDs, the default setting is off.
- With some DVD-Video discs, you need to select an audio output format from a menu.

Can't get 6.1 or 7.1-channel playback?

- When speaker B is turned on, speaker set A is reduced to 5.1-channel playback.

The volume cannot be set to 79?

- When the levels of all speakers have been calibrated (pages 41, 50), the maximum volume setting may change.

Noise can be heard?

- Using cable ties to bundle audio cables with power cords, speaker cables, and so on may degrade the audio performance, so don't do it.
- An audio cable may be picking up interference. Try repositioning your cables.

The Late Night function doesn't work?

- Make sure the source material is Dolby Digital (page 46).

The DVD analog multichannel input doesn't work?

- Check the DVD analog multichannel input connections (page 23).
- To select the DVD analog multichannel input, press the [MULTI CH] input selector button.
- Check the audio output settings on your DVD player.

About DTS signals

- When DTS program material ends and the DTS bitstream stops, the AV receiver remains in DTS listening mode and the DTS indicator remains on. This is to prevent noise when you use the pause, fast forward, or fast reverse function on your player. If you switch your player from DTS to PCM, because the AV receiver does not switch formats immediately, you may not hear any sound, in which case you should stop your

player for about three seconds, and then resume playback.

- With some CD players, you won't be able to playback DTS material properly even though your player is connected to a digital input on the AV receiver. This is usually because the DTS bitstream has been processed (e.g., output level, sampling rate, or frequency response changed) and the AV receiver doesn't recognize it as a genuine DTS signal. In such cases, you may hear noise.
- When playing DTS program material, using the pause, fast forward, or fast reverse function on your player may produce a short audible noise. This is not a malfunction.

Video

There's no picture?

- Make sure that all video connecting plugs are pushed in all the way (page 20).
- Make sure that each video component is properly connected.
- The AV receiver does not convert between formats. So if your video component is connected to a component video input, your TV must be connected to the component video output (page 21).
- On your TV, make sure that the video input to which the AV receiver is connected is selected.
- While the Pure Audio listening mode (not North American model) is selected, the video circuits are turned off and the AV receiver outputs no video signals.

Tuner

Reception is noisy, stereo FM reception suffers from hiss, or the FM STEREO indicator doesn't appear?

- Relocate your antenna.
- Move the AV receiver away from your TV or computer.
- Listen to the station in mono (page 36).
- When listening to an AM station, operating the remote controller may cause noise.
- Passing cars and airplanes can cause interference.
- Concrete walls weaken radio signals.
- If nothing improves the reception, install an outdoor antenna.

Remote Controller

The remote controller doesn't work?

- Make sure that the batteries are installed with the correct polarity (page 9).
- Make sure that the remote controller is not too far away from the AV receiver, and that there's no obstruction between the remote controller and the AV receiver's remote control sensor (page 9).
- Make sure you've selected the correct remote controller mode (page 10).
- Make sure you've entered the correct remote control code.

Can't control other components?

- Make sure you've selected the correct remote controller mode (page 10).
- If you've connected an **RI**-compatible Onkyo Mini-Disc or CD recorder to the TAPE IN/OUT jacks, for the remote controller to work properly, you must set the display to MD or CD (see pages 31 and 53).
- The wrong remote control code has been entered.
- The entered remote control code may not be correct. If more than one code is listed, try each one.
- With some AV components, certain buttons may not work as expected, and some may not work at all.
- To control Onkyo components via **RI**, point the remote controller at the AV receiver.
- To control Onkyo components without **RI**, or other manufacturers' components, point the remote controller at that component.

Recording

Can't record?

- On your recorder, make sure the correct input is selected.
- To prevent signal loops and damage to the AV receiver, input signals are not fed through to outputs with the same name (e.g., TAPE IN to TAPE OUT, or VIDEO 1 IN to VIDEO 1 OUT).
- When the Pure Audio listening mode is selected, recording is not possible because no video signals are output. Select another listening mode.

Others

The sound changes when I connect my headphones?

- When a pair of headphones is connected, the listening mode is set to Stereo, unless it's already set to Stereo, Mono, Direct, or Pure Audio (not North American model).

The display doesn't work?

- The display is turned off when the Pure Audio (not North American model) listening mode is selected.

How do I change the language of a multiplex source?

- Use the "Multiplex" setting on the "4. Audio Adjust" menu to select Main or Sub (page 47).

The **RI** functions don't work?

- To use **RI**, you must make an **RI** connection and an analog audio connection (RCA) between the component and AV receiver, even if they are connected digitally (page 29).

The AV receiver contains a microcomputer for signal processing and control functions. In very rare situations, severe interference, noise from an external source, or static electricity may cause it to lockup. In the unlikely event that this happens, unplug the power cord from the wall outlet, wait at least five seconds, and then plug it back in again.

Onkyo is not responsible for damages (such as CD rental fees) due to unsuccessful recordings caused by the unit's malfunction. Before you record important data, make sure that the material will be recorded correctly.

To reset the AV receiver to its factory defaults, turn it on and, while holding down the [VIDEO 1] button, press the [STANDBY/ON] button. "Clear" will appear on the display and the AV receiver will enter Standby mode.

Before disconnecting the power cord from the wall outlet, set the AV receiver to Standby.

Specification

Amplifier Section

Power Output	
2 channel driven:	North American: 75 W + 75 W (8Ω,20Hz–20kHz, FTC) European: 100 W + 100 W (6Ω,1kHz,DIN) Asian, Australian: 130 W + 130 W (6Ω,1kHz,JEITA)
Dynamic Power	180 W + 180 W (3Ω,Front) 140 W + 140 W (4Ω,Front) 95 W + 95 W (8Ω,Front)
THD (Total Harmonic Distortion)	0.08% (Power Rated)
Damping Factor	60 (Front,1kHz,8Ω)
Input Sensitivity and Impedance	200 mV/ 47 kΩ (LINE)
Output Level and Impedance	200 mV/ 470 Ω (REC OUT)
Frequency Response	10 Hz–100 kHz/ +1 dB-3 dB (Direct mode)
Tone Control	±10 dB, 50 Hz (BASS) ±10 dB, 20 kHz (TREBLE)
Signal to Noise Ratio	100 dB (LINE, IHF-A)
Speaker Impedance	North American: 6Ω– Others: 4Ω– or 6Ω–

Video Section

Input Sensitivity/Output Level and Impedance	1 Vp-p /75Ω (Component and S-Video Y) 0.7 Vp-p /75Ω (Component Pb/Cb,Pr/Cr) 0.28 Vp-p /75Ω(S-Video C) 1 Vp-p /75Ω(Composite)
Component Video Frequency Response	5 Hz – 50 MHz

Tuner Section

■ FM

Tuning Frequency Range	North American: 87.5 MHz– 107.9 MHz Other: 87.5 MHz– 108.0 MHz
Usable Sensitivity	Stereo:17.2 dBf 2 μV(75Ω IHF) Mono: 11.2 dBf 1 μV(75Ω IHF)
Signal to Noise Ratio	Stereo: 70 dB (IHF-A) Mono:76 dB (IHF-A)
THD	Stereo: 0.3% (1kHz) Mono:0.2% (1kHz)
Frequency Response	30 Hz–15 kHz / ±1 dB
Stereo Separation	45 dB (1kHz)

■ AM

Tuning Frequency Range	North American: 530 kHz–1710 kHz Others: 522 kHz–1611 kHz
Usable Sensitivity	30 μV
Signal to Noise Ratio	40 dB
THD	0.70%

General

Power Supply	North American: AC 120 V, 60 Hz Australian and European: AC 230-240 V, 50 Hz Others: AC 120/220-240 V, 50/60 Hz AC 230-240 V, 50Hz AC 220-230 V, 50 Hz
Power Consumption	North American: 6.2 A Others: 590 W
Stand-by Power Consumption	North American: 0.1 W Australian and European: 0.2 W Others: 0.5 W
Dimensions (W × H × D)	435 × 150 × 374 mm 17-1/8" × 5-7/8" × 14-3/4"
Weight	North American: 9.4 kg 20.7 lbs. European: 10.1 kg 22.3 lbs. Others: 10.2 kg 22.5 lbs.

■ Video Inputs

Component	DVD,VIDEO1,VIDEO2
S-Video	DVD,VIDEO1,VIDEO2
Composite	DVD,VIDEO1,VIDEO2,VIDEO3

■ Video Outputs

Component	MONITOR
S-Video	MONITOR OUT,VIDEO1
Composite	MONITOR OUT,VIDEO1

■ Audio Inputs

Digital Inputs	Optical: 3 Coaxial: 1
Analog Inputs	DVD(MULTICHANNEL),VIDEO1, VIDEO2,VIDEO3,TAPE,CD
Multichannel Inputs	6

■ Audio Outputs

Analog Outputs	TAPE,VIDEO1
Subwoofer Pre Outputs	1
Speaker Outputs	SP A (L, R, C, SL, SR, SBL, SBR) SP B (L, R)
Phones	1

Specifications and features are subject to change without notice.

Memo

ONKYO CORPORATION

Sales & Product Planning Div. : 2-1, Nisshin-cho, Neyagawa-shi, OSAKA 572-8540, JAPAN
Tel: 072-831-8023 Fax: 072-831-8124

ONKYO U.S.A. CORPORATION

18 Park Way, Upper Saddle River, N.J. 07458, U.S.A.
Tel: 201-785-2600 Fax: 201-785-2650 <http://www.us.onkyo.com/>

ONKYO EUROPE ELECTRONICS GmbH

Liegnitzerstrasse 6, 82194 Groebenzell, GERMANY
Tel: +49-8142-4401-0 Fax: +49-8142-4401-555 <http://www.eu.onkyo.com/>

ONKYO EUROPE UK Office

Suite 1, Gregories Court, Gregories Road, Beaconsfield, Buckinghamshire, HP9 1HQ
UNITED KINGDOM Tel: +44-(0)1494-681515 Fax: +44(0)-1494-680452

ONKYO CHINA LIMITED

Units 2102-2107, Metroplaza Tower I, 223 Hing Fong Road, Kwai Chung,
N.T., HONG KONG Tel: 852-2429-3118 Fax: 852-2428-9039
<http://www.ch.onkyo.com/>



I0502-1

SN 29343932

(C) Copyright 2005 ONKYO CORPORATION Japan. All rights reserved.



* 2 9 3 4 3 9 3 2 *

Download from [Www.Somanuals.com](http://www.Somanuals.com). All Manuals Search And Download.



Remote Control Codes

For RC-607M & RC-608M

When two or more codes are given, try each one in turn, and choose the one that works best.

Depending on the manufacturer and component, the remote controller may not work as expected.

Codes de télécommande

Pour les RC-607M & RC-608M

Si plusieurs codes sont proposés, essayez-les chacun et choisissez celui qui fonctionne le mieux.

Selon le fabricant et l'appareil que vous possédez, la télécommande peut ne pas se comporter de la manière escomptée.

Códigos de control remoto

Para los RC-607M & RC-608M

Si introduce dos o más códigos, pruébelos uno por uno, y elija el que funcione mejor.

Según el fabricante y el componente, es posible que el controlador remoto no funcione de la forma esperada.

Codici del telecomando

Per il RC-607M & RC-608M

Quando vengono dati due o più codici, provateli tutti e scegliete quello che funziona meglio.

Con alcuni dispositivi potrebbe non funzionare correttamente a seconda della tecnologia o del dispositivo.

Fernbedienungs-codes

RC-607M & RC-608M

Wenn mehrere Codes erwähnt werden, probieren Sie alle aus und verwenden schließlich den, bei dem die Fernbedienung am besten funktioniert.

Bei bestimmten Geräten anderer Hersteller funktioniert die Fernbedienung nicht erwartungsgemäß.

Afstandsbedieningscodes

Voor de RC-607M & RC-608M

Wanneer er twee of meer codes zijn, moet u deze om de beurt proberen en kijken welke het beste werkt.

Afhankelijk van de fabrikant en de apparatuur is het mogelijk dat de afstandsbediening niet werkt zoals u verwacht.

Fjärrstyrningskoder

Gäller RC-607M & RC-608M

När fler än en kod anges: prova varje kod i tur och ordning och välj den som fungerar bäst.

Beroende på fabrikatet och komponenten ifråga kan det hända att fjärrkontrollen inte fungerar såsom förväntas.

遙控代碼

對於 RC-607M & RC-608M

當有兩個或兩個以上的代碼時，依次嘗試每一個代碼，然後選擇效果最好的一個。

由於某些制造商或設備特性的原因，代碼可能不能與設備很好地配合使用。

遙控代碼

對於 RC-607M & RC-608M

當有兩個或兩個以上的代碼時，依次嘗試每一個代碼，然後選擇效果最好的一個。

由於某些制造商或設備特性的原因，代碼可能不能與設備很好地配合使用。



DVD Codes

DVD player

3DLAB	0539
Acoustic Solutions	0730
AEG	0770
Aim	0699
Airis	1250
Aiwa	0533
Akai	0690, 0770, 1115
Akira	0699
Alba	0539, 0672, 0695, 0699, 0713, 0730, 0783
Amitech	0770, 0850
Amphion Media Works	0872
Amstrad	0713
AMW	0872
Ansonic	0774, 0831
Apex Digital	0672, 0755, 0794, 0796, 0797, 1004, 1020, 1056, 1100
Aspire Digital	1168
Audiosonic	0690
Awa	0730, 0872
Axion	0730
Baze	0672
Bellagio	1004
Black Diamond	0713
Blue Parade	0571
Blue Sky	0651, 0672, 0695, 0713
Boghe	1004, 1221
Boman	0783
Brainwave	0770, 1115, 1235
Brand Unknown	0490, 0730
Brandt	0503, 0551, 0651
Broksonic	0695
Bush	0672, 0690, 0695, 0699, 0713, 0730, 0831
C-Tech	0768, 0798
Cambridge Soundworks	0690
Cat	0699
CCE	0730
Celestial	1020
Centrex	0672, 1004
Centrum	0713
CGV	1115
Changhong	0627
Cineral	0730
Cinotec	0713, 0872
cineULTRA	0699
Classic	0730
Clatronic	0672
Clayton	0713
Coby	0730, 1086
Compacks	1366
Conia	0672
Continental Edison	0831, 0872
Crown	0690, 0770, 1115
Cybercom	0831
CyberHome	0816, 1023, 1024, 1129, 1294
Cytron	0651, 0774
D-Vision	1115
Daewoo	0770, 0872
Daewoo International	0872
Dansai	0770, 0783, 1115
Daytek	0872
Dayton	0872
DCE	0831
Decca	0770, 1115
Denon	0490
Denver	0672, 0699
Diamond	0651, 0768

DVD player

Dick Smith Electronics	1730
Digihome	0713
Digitor	0651, 0690
Digitrex	0672, 1056, 1100
DiK	0831
Disney	0675
DK digital	0831
DMTECH	0783
Dragon	0831
DSE	1730
DTS	0799
Dual	0651, 0713, 0730, 0783, 0831
Durabrand	0713
DVD2000	0521
DVX	0768
ECC	0730
Elin	0770
Ellion	0850
Elta	0672, 0690, 0770, 0850, 1115
Eltax	1321
Emerson	0591, 0675
Enterprise	0591
ESA	2022
EuroLine	1115
Fenner	0651
Ferguson	0651
Finlux	0591, 0672, 0741, 0770, 0783
Firstline	0713, 0799
Funai	0675, 0695, 1334
Gateway	1073, 1158, 1194
GE	0522
Global Solutions	0768
Global Sphere	0768
Go Video	0741, 0783, 1158, 1304, 1730
GoldStar	0591, 0741
Goodmans	0651, 0690, 0713, 0730, 0783, 1004, 1221
GPX	0699
Gradiente	0651
Gran Prix	0831
Grandin	0713
Grundig	0539, 0551, 0651, 0695, 0713, 1004, 1730
Grunkel	0770
H & B	0850, 1235
H&B	0713, 0850, 1235
Haaz	0768
Hanseatic	0741, 0783
Harman/Kardon	0582, 0702
HE	0730
Hitachi	0573, 0695, 1664
Hiteker	0672
Hoher	0651, 0713, 0831
Home Electronics	0730
Humax	0646
Hyundai	0783, 0850
iLo	1348
Initial	0839
Integra	0627
IRT	0783
ISP	0695
JBL	0702
JDB	0730
Jeken	0699
Jepssen	1250
Jindian	0799
JMB	0695
JVC	0503, 0539, 0558, 0623, 1164, 1275, 1988
Karcher	0783
Kendo	0699, 0713

DVD player

Kennex	0770
Kenwood	0490, 0534
Kiiro	0770
King DHome	0799
KLH	1020
Koss	0651
Lasonic	0798
Lawson	0768
Lenco	0651, 0672, 0699, 0713, 0770, 0774
Lenoxx	0690
Lexia	0699, 0768
LG	0591, 0741
Lifetec	0651, 0831
Limit	0768
Lite-On	1058, 1158
LiteOn	1058, 1158
Loewe	0539, 0885
Logix	0783
Lunatron	0741
Luxman	0573
Luxor	1004
Magnasonic	0651
Magnavox	0503, 0539, 0675
Manhattan	0713
Marantz	0539
Mark	0713
Marquant	0770
Mastec	1221
Matsui	0651, 0672, 0695, 0713, 1004
Maxim	0713
MBO	0690, 0730, 1730
Mecotek	0770
Medion	0630, 0651, 0774, 0783, 0831, 1347
Memorex	0695, 0831
Metronic	0690
Metz	0525, 0571, 0713
MiCO	1221
Micromedia	0503, 0539
Micromega	0539
Microsoft	0522
Microstar	0831
Minato	0752
Minax	0713
Minoka	0770
Mintek	0839
Mirror	0752
Mitsubishi	0521, 0713
Mustek	0730, 1730
Mx Onda	0651
NAD	0741
Naiko	0770, 1004
Nevir	0770, 0831
Norcent	0872
Nordmende	0774, 0831
Noriko	0752
Okano	0752
Olidata	0672
Omni	0690
Optimus	0525
Orion	0695
Oritron	0651
Ormond	0713
Pacific	0713, 0768, 0831
Palladium	0695
Palsonic	0672
Panasonic	0490, 1010, 1011
Philco	0690
Philips	0503, 0539, 0646, 0675, 0885, 1375, 1647, 1812, 1818
Phonotrend	0699
Pioneer	0525, 0571, 0631, 1816
Plu2	0850

DVD player	
Polaroid	1086
Polk Audio	0539
Polkaudio	0539
Portland	0770
Powerpoint	0872
Prinz	0831
Proline	0651, 0672, 1004
Proscan	0522
Prosonic	0699
ProVision	0699
Qwestar	0651
Radionette	0741
RCA	0522, 0571
REC	0490
Red Star	0770
Relisys	1347
Reoc	0752, 0768
Revoy	0699
Roadstar	0672, 0690, 0699, 0713, 0730
Ronin	0710, 0872
Rotel	0558, 0623
Rowa	0872, 1004
Saba	0551, 0651
Sabaki	0798
Saivod	0831
Salora	0741
Sampo	0752
Samsung	0490, 0573
Sansui	0695, 0768
Sanyo	0695
Scan	0850
ScanMagic	0730, 1730
Schaub Lorenz	0770, 1115, 1235
Schneider	0539, 0651, 0774, 0783, 0831
Schwaiger	0752
Scientific Labs	0768
Scott	0651, 0672
Seeltech	1338
SEG	0713, 0768, 0798, 0872
Semp	0503
Sensory Science	1158
Shanghai	0672
Sharp	0630, 0752, 1256
Sherwood	0741, 0770
Shinsonic	0533, 0839
Silva Schneider	0831
Simaudio	0885
Singer	0690, 0768
Sinudyne	1221
Skymaster	0730, 0768
Slim Devices	0533
SM Electronic	0690, 0730, 0768
Smart	0713
Sonai	0755
Sonashi	0831
Sonic Blue	0783
Sony	0533, 0573, 1033, 1069, 1070
Soundmaster	0768
Soundmax	0768
Soundwave	0783
Spectra	0872
Standard	0651, 0768
Sunkai	0770, 0850
Supervision	0768
SVA	0672
Sylvania	0630, 0675
Symphonic	0675
Synn	0768
Tandberg	0713
Tangent	1321
Tatung	0770
Teac	0571, 0741, 0768

DVD player	
Technics	0490
Technika	0770, 0831, 1115
Technisson	1115
Technosonic	0730, 1115
Techwood	0713
Tedelex	0690
Teletech	0713, 0768
Tensai	0651, 0690, 0770
Tevion	0651, 0768, 0798, 1227
Theta Digital	0571
Thomson	0522, 0551, 1380
Tivo	1816
Toshiba	0503, 0695, 1154, 1988
TRANS-continents	0831, 0872
Transonic	0672
Tredex	0799
Umax	0690
United	0672, 0730, 1115
Universum	0591, 0713, 0741, 1227
Urban Concepts	0503
US Logic	0839
Vestel	0713
Voxson	0690, 0730, 0774, 0831
Welkin	0831
Wellington	0713
Wesder	0699
Wharfedale	0752
Wilson	0831
Windy Sam	0573
WIZE	1115
Xbox	0522
XLogic	0768, 0798
XMS	0770
Xoro	1221, 1250, 1379
Yakumo	1004, 1056
Yamada	0872, 1004
Yamaha	0490, 0539, 0545, 0646
Yamakawa	0710, 0872
Yukai	0730, 1730
Zenith	0503, 0591, 0741

TV/DVD

Broksonic	0695
Bush	0713
Grundig	0695
Sansui	0695
Sylvania	0675
Toshiba	0695

DVD Recorder

Apex Digital	1056
Aspire Digital	1168
Boghe	1221
Coby	1086
Compacks	1366
CyberHome	1129, 1294
Dick Smith Electronics	1730
Digitrex	1056
DSE	1730
Eitax	1321
Funai	0675, 1334
Gateway	1073, 1158, 1194
Go Video	0741, 1158, 1304, 1730
H & B	1235
Hitachi	1664
iLo	1348
JVC	1164, 1275
LG	0741
Lite-On	1158
Medion	1347
MiCO	1221
Mitsubishi	1403
Mustek	1730

DVD Recorder

NEC	1404
Panasonic	0490, 1010, 1011
Philips	0646, 1375, 1647, 1812, 1818
Pioneer	0631, 1816
Polaroid	1086
Relisys	1347
Samsung	0490
Seeltech	1338
Sensory Science	1158
Sinudyne	1221
Sony	1033, 1069, 1070
Sylvania	0675
Tangent	1321
Tevion	1227
Thomson	0551, 1380
Toshiba	1988
Xoro	1221, 1379
Zenith	0741

CD/MD/CDR Codes

CD Player

Acoustic Research	0420
Advantage	0032
Aiwa	0157
Arcam	0157
Audio Research	0157
Audiolab	0157
Audiomeca	0157
Audioton	0157
BAT	0157
Burmester	0420
Cairn	0157
California Audio Labs	0029
Cambridge	0157
Cambridge Audio	0157
Carver	0157, 0179
CCE	0157
CDC	0420
CEC	0420
Classic	1297
Curtis	1280
Cyrus	0157
Denon	0003, 0626, 0873
DKK	0000
DMX Electronics	0157
Dual	0003
Dynamic Bass	0179
Electron	1280
Emerson	0305
Fisher	0179, 1325
Garrard	0420
Genexxa	0000, 0032, 0037, 0179, 0305
Goldmund	0157
GoldStar	1208
Goodmans	0305
GPX	1296
Grundig	0157
Harman/Kardon	0157, 0173, 1202
Hitachi	0032
Integra	0101
IR	0000
JVC	0072, 1294
Kenwood	0028, 0036, 0037, 0157, 0190, 0626, 0681, 0826
KLH	1318
Kodak	0287
Koss	1317
Krell	0157
LG	1208

CD Player	
Linn	0157
Loewe	0157
LXI	0305
Magnavox	0157, 0305
Marantz	0029, 0157, 0626
Matsui	0157
McIntosh	0256, 0287, 0290, 0660
MCS	0029
Memorex	0032, 0305
Meridian	0157
Micromega	0157
Miro	0000
Mission	0157
MTC	0420
Myryad	0157
NAD	0000, 1208
Naim	0157
NSM	0157
Oak	0145
Optimus	0000, 0032, 0037, 0087, 0145, 0179, 0305, 0420, 1063, 1075
Panasonic	0029
Parasound	0420
Philips	0157, 0287, 0626
Pioneer	0032, 0101, 0305, 1062, 1063, 1087
Polk Audio	0157
Proton	0157
QED	0157
Quad	0157
Quasar	0029
Radiola	0157
RadioShack	1075
RCA	0032, 0053, 0179, 0305, 0420, 1062
Realistic	0179, 0420
Restek	0157
Revox	0157
Roksan	0420
Rotel	0157, 0420
Royal	0420
SAE	0157
Sansui	0157, 0305
Sanyo	0087, 0179
SAST	0157
Scott	0305
Sears	0305
Sharp	0037, 0861
Sherwood	1067
Siemens	0157
Silsonic	0036, 0888
Simaudio	0157
Sonic Frontiers	0157
Sony	0000, 0100, 0490, 1364
Soundesign	0145
SuperTech	1280
Symphonic	0305
TAG McLaren	0157
Tandy	0032
Tascam	0420
TDK	1208
Teac	0420, 1277, 1280
Technics	0029
Thomson	0053
Thorens	0157
Thule Audio	0157
Tokai	0420
Traxdata	0626
Universum	0053, 0157
Victor	0072
Wards	0000, 0032, 0053, 0087, 0157, 0179
Yamaha	0032, 0036, 0888, 1292
Zonda	0157

CD Recorder	
Classic	1297
Fisher	1325
GPX	1296
Harman/Kardon	1202
JVC	0072, 1294
Kenwood	0626
LG	1208
Marantz	0626
NAD	1208
Philips	0626
Pioneer	1062, 1087
Sony	0000, 0100, 1364
TDK	1208
Teac	0420
Yamaha	0888, 1292

MD Recorder	
Denon	0873
Kenwood	0681, 0826
Optimus	1063
Pioneer	1063
Sharp	0861
Sherwood	1067
Sony	0490
Yamaha	0888

TV Codes

TV	
888	0264
Accent	0009
Acura	0009
Addison	0092, 0108, 0653, 1150
Admiral	0093, 0264, 0463
Advent	0761, 0842
Agashi	0264
AGB	0516
Aiko	0009, 0092, 0264
Aim	0037, 0274, 0706
Aiwa	0701, 1180
Akai	0009, 0030, 0037, 0178, 0208, 0218, 0264, 0480, 0516, 0548, 0556, 0672, 0702, 0714, 0812
Akiba	0037, 0218
Akito	0037
Akura	0009, 0037, 0218, 0264, 0668, 0714
Alba	0009, 0037, 0218, 0443, 0474, 0487, 0668, 0714, 1037
Albatron	0700, 0843
Alfide	0672
Allstar	0037
America Action	0180
Amplivision	0370
Ampro	0751
Amstrad	0009, 0037, 0171, 0218, 0264, 0516, 1037
Anam	0009, 0180, 0250, 0700
Anam National	0250, 0650
Anglo	0009, 0264
Anhua	0051
Anitech	0009, 0037, 0474
Ansonic	0009, 0370, 0668
AOC	0009, 0030, 0060, 0092, 0093, 0108, 0178, 0180, 0451, 0474, 1150
Aolinpike	0264
Apex Digital	0748, 0765, 0879
Arc En Ciel	0333
Ardem	0037, 0714
Aristona	0037, 0556
Arthur Martin	0237

TV	
Asberg	0037
Asora	0009
Astra	0037
Asuka	0218, 0264
ATD	0698
Atlantic	0037
Atori	0009
Audinac	0180
Audiosonic	0009, 0037, 0218, 0264, 0370, 0486, 0714
Audioton	0264, 0370, 0486
Audiovox	0092, 0180, 0451, 0802, 0875
Autovox	0237
Aventura	0171
Awa	0009, 0108, 0264
Axxent	0009
Axxon	0714
Baihe	0009, 0264
Baile	0009, 0661
Baird	0073, 0208, 0557
Bang & Olufsen	0565
Baohuashi	0264
Baosheng	0009
Basic Line	0009, 0037, 0218, 0339, 0556, 0668, 1037
Baur	0009, 0037
Baysonic	0180, 0236, 0463
Beaumarck	0178
Beijing	0009, 0208, 0226, 0264, 0661, 0812
Beko	0037, 0370, 0486, 0714, 1037
Bell & Howell	0154
BenQ	1032, 1756
Beon	0037
Berthen	0668
Bestar	0037, 0370
Black Diamond	1037
Blackway	0218
Blaupunkt	0170, 0185, 0327
Blue Sky	0037, 0218, 0487, 0556, 0668, 0714, 1037
Boots	0009
BPL	0037
Bradford	0180
Brand Unknown	0060
Brandt	0237, 0287, 0299, 0333, 0560, 0625
Brinkmann	0037, 0486, 0668
Broksonic	0236, 0463
BTC	0218
Bush	0009, 0037, 0208, 0218, 0264, 0487, 0556, 0661, 0668, 0698, 0714, 1037
Caihong	0009
Cailing	0748
Candle	0030, 0186
Canton	0218
Capsonic	0264
Carad	0610, 0668, 1037
Carena	0037
Carnivale	0030
Carver	0054, 0170
Cascade	0009, 0037
Casio	0037
Cathay	0037, 0474
CCE	0037
Celebrity	0000
Celera	0765
Centrum	1037
Centurion	0037
CGE	0306, 0370
Changcheng	0009, 0051, 0264, 0661
Changfei	0009
Changfeng	0264

TV	
Changhai	0009
Changhong	0009, 0156, 0264, 0508, 0765
Chengdu	0009
Ching Tai	0009, 0092, 0474
Chun Yun	0000, 0009, 0092, 0180, 0474, 0700, 0843, 1150
Chunfeng	0009, 0264
Chung Hsin	0053, 0108, 0180, 0474, 1150
Chunsun	0009
Cimline	0009, 0218
Cinema	0672
Cineral	0092, 0451
Citizen	0030, 0060, 0092, 0186, 0451
City	0009
Clarion	0180
Clarivox	0037
Clatronic	0009, 0037, 0218, 0264, 0370, 0714
Clayton	1037
Commercial Solutions	0047
Concorde	0009
Condor	0009, 0037, 0264, 0370
Conrac	0808
Conrowa	0009, 0145, 0156, 0264, 0698
Contec	0009, 0037, 0180
Continental Edison	0237, 0267, 0299, 0333, 0487
Cosmel	0009, 0037
Craig	0180
Crosley	0054
Crown	0009, 0037, 0053, 0180, 0208, 0339, 0370, 0486, 0487, 0672, 0714
Crown Mustang	0672
CS Electronics	0218
Curtis Mathes	0030, 0047, 0051, 0054, 0060, 0093, 0145, 0154, 0166, 0451, 0702
CXC	0180
Cybertron	0218
D-Vision	0037, 0556
Daenix	0180, 0672
Daenyk	0672
Daewoo	0009, 0030, 0037, 0092, 0108, 0154, 0170, 0178, 0180, 0218, 0451, 0474, 0556, 0634, 0661, 0672, 0700, 0865, 1150, 1661
Dainichi	0218
Dansai	0009, 0037, 0208
Dantax	0714
Dawa	0009, 0037
Dayton	0009
Daytron	0009, 0037, 0180
Dayu	0661
De Graaf	0208, 0548
Decca	0037, 0516
Dell	1080, 1178, 1264
Denko	0264
Denon	0145, 0511
Denver	0037, 0587
Desmet	0009, 0037
Diamant	0037
Diamond	0009, 0264, 0698, 0706
Dick Smith Electronics	0698
Digatron	0037
Digiline	0668
Digitor	0037, 0698
Dixi	0009, 0037
Domeos	0668
Dongda	0009
Donghai	0009

TV	
Drean	0037
DSE	0698
DTS	0009
Dual	0037
Dumont	0017
Durabrand	0171, 0178, 0180, 0463, 1034, 1463
Dux	0037
Dwin	0720, 0774
Dynatron	0037
E-Elite	0218
Ecco	0706
ECE	0037
Edison-Minerva	0487
Elbe	0516, 0610
Elbe-Sharp	0516
Electroband	0000
Electrograph	1755
Elekta	0009, 0264
Elektra	0017, 1661
ELG	0037
Elin	0009, 0037, 0548
Elite	0218
Elta	0009, 0264, 0474
Emerson	0037, 0154, 0171, 0178, 0180, 0182, 0236, 0370, 0463, 0486, 0714
Envision	0030, 0813
Epson	0833, 0840
Erres	0037
ESA	0171, 0812
ESC	0037, 0474
Ether	0009, 0030
Etron	0009
Eurofeel	0264
Euroman	0037, 0264, 0370
Europa	0037
Europhon	0516
Exquisit	0037
Feliang	0009
Feiliu	0009
Felyan	0264
Felyue	0009
Fenner	0009
Ferguson	0037, 0053, 0073, 0192, 0287, 0548, 0560, 0625
Fidelity	0037, 0171, 0264, 0474
Finlandia	0208, 0548
Finlux	0037, 0480, 0516, 0714
Firstar	0009, 0236
Firstline	0009, 0037, 0208, 0556, 0668, 0714, 1037
Fisher	0047, 0154, 0208, 0370
Flint	0037, 0218, 0264, 0610
Formenti	0037
Fortress	0093
Fraba	0037, 0370
Friac	0009, 0037, 0370, 0610
Frontech	0009, 0264, 0474
Fujitsu	0009, 0095, 0186, 0683, 0809, 0853, 1181
Fujitsu General	0009
Fujitsu Siemens	0809
Funai	0171, 0180, 0264, 0342, 0668
Furi	0145, 0264
Futronic	0264
Futuretech	0180
Galaxi	0037
Galaxis	0037, 0370
Gateway	1755, 1756
GBC	0009, 0218
GE	0030, 0047, 0051, 0092, 0093, 0178, 0180, 0451, 0560, 0625
GEC	0037, 0516, 0557

TV	
Geloso	0009
General	0186
General Electric	0047
General Technic	0009
Genesis	0009, 0037
Genexxa	0009, 0037, 0218
Gericom	0865
Gibratler	0017, 0030
Gintai	0474, 1150
Go Video	0886
Goldfunk	0668
GoldStar	0030, 0037, 0154, 0178, 0467, 0474, 0714, 1150, 1378, 1478
Gooding	0487
Goodmans	0009, 0037, 0218, 0264, 0360, 0480, 0487, 0516, 0556, 0560, 0634, 0661, 0668, 0714, 1037
Gorenje	0370
GPM	0218
Gradiente	0053, 0170
Graetz	0339, 0487, 0557
Granada	0037, 0108, 0208, 0226, 0339, 0516, 0548, 0560
Grandin	0009, 0037, 0610, 0668, 0714, 1037
Grundig	0009, 0037, 0195, 0237, 0443, 0487, 0556, 0587, 0672, 0706
Grunpy	0180
Haaz	0706
Haier	0037, 0508, 0587, 0698, 1034
Haihong	0009
Haiyan	0264
Halifax	0264
Halimark	0178
Hanimex	0218
Hankook	0030, 0178, 0180
Hanseatic	0009, 0037, 0556, 0634, 0661, 0714, 0808
Hantarex	0009, 0037, 0516, 0865
Hantor	0037
Harman/Kardon	0054
Harsper	0865
Harvard	0180
Harwood	0009, 0037, 0487
Hauppauge	0037
Havermy	0093
HCM	0009, 0037, 0218, 0264
Helios	0865
Hello Kitty	0451
Hema	0009
Highline	0037, 0264
Hikona	0218, 0474
Himitsu	0180
Hinari	0009, 0037, 0218, 0264
Hisawa	0218, 0610, 0714
Hisense	0009, 0145, 0156, 0208, 0508, 0556, 0748
Hitachi	0009, 0030, 0037, 0092, 0095, 0108, 0145, 0156, 0178, 0182, 0186, 0306, 0474, 0480, 0481, 0508, 0516, 0548, 0557, 0577, 0634, 1037, 1099, 1150, 1245, 1378
Hitachi Fujian	0108, 0150
Hitsu	0009, 0218, 0610
Hoher	0714
Hongmei	0009, 0093, 0264
Hongyan	0264
Hornophon	0037
Hua Tun	0009, 1150
Huafa	0009, 0145
Huanghaimei	0009
Huanghe	0009

TV	
Huanglong	0009
Huangshan	0009, 0264
Huanyu	0264
Huaqiang	0264
Huari	0145, 0264
Huodateji	0051
Hyper	0009
Hypson	0037, 0264, 0668, 0714, 1037
Hyundai	0849, 0865
Iberia	0037
ICE	0218, 0264
ICeS	0218
Imperial	0037, 0370
Imperial Crown	0009, 0264, 0661
Indesit	0237
Indiana	0037
Infinity	0054
Ingelen	0487, 0557, 0610, 0714
Ingersoll	0009
Inno Hit	0009, 0516
Innova	0037
Innowert	0865
Inteq	0017
Interbuy	0037, 0264
Interfunk	0037, 0327, 0557
Internal	0037
Intervision	0009, 0037, 0218, 0264, 0486, 0487
IR	0037, 0073, 0089, 0093, 0108, 0192, 0195, 0226, 0237, 0274, 0287, 0299, 0306, 0323, 0327, 0370, 0516, 0556, 0557
Irradio	0009, 0037, 0218
IRT	0451, 0698, 1661
Isukai	0037, 0218
ITS	0037, 0218, 0264
ITT	0208, 0339, 0480, 0548, 0557, 0610
ITT Nokia	0180, 0208, 0339, 0480, 0548, 0557, 0610
ITV	0037, 0264
JBL	0054
JCB	0000
Jean	0009, 0051, 0092, 0156, 0236, 0474
Jensen	0761
Jiahua	0051
Jialicai	0009, 0264
Jinfeng	0051, 0208, 0226
Jinque	0009, 0264
Jinta	0009, 0264
Jinxing	0009, 0037, 0054, 0145, 0156, 0264, 0556, 0698
JMB	0443, 0556, 0634
Jubilee	0556
Juhua	0264
JVC	0053, 0093, 0160, 0169, 0182, 0192, 0218, 0463, 0508, 0653, 0683, 0731, 1172
Kaige	0009, 0264
Kaisui	0009, 0037, 0218
Kangli	0009, 0264, 0661
Kangyi	0009, 0264
Kapsch	0557
Karcher	0264, 0610, 0714
Kathrein	0556
KEC	0180
Ken Brown	0236, 0463
Kendo	0037, 0610
Kenia	0030
Kenwood	0030
Kioto	0054, 0556, 0706
Kiton	0037, 0668
KLH	0765

TV	
KLL	0037
Kneissel	0037, 0556, 0610
Kolin	0053, 0108, 0150, 0180, 0474, 1150
Kongque	0009, 0264
Konichi	0009
Konka	0037, 0218, 0587, 0714
Kontakt	0487
Korpel	0037
Koyoda	0009
KTV	0030, 0180
Kuaile	0009, 0264
Kulun	0009
Kunlun	0051, 0208, 0226, 0264, 0661
L&S Electronic	0714, 0808
LaSAT	0486
Leader	0009
Lecson	0037
Legend	0009
Lenco	0037, 0474, 1037
Lenoir	0009
Leyco	0037, 0264
LG	0030, 0037, 0060, 0108, 0178, 0442, 0474, 0556, 0698, 0700, 0714, 0856, 1178, 1378
Liesenk & Tter	0037
Liesenkotter	0037, 0327
Lifetec	0009, 0037, 0218, 0668, 0683, 0714, 1037
Lloyd's	0009
Loewe	0037, 0136, 0516
Logik	0009, 0698, 1217
Logix	0668
Longjiang	0264
Lumatron	0037, 0073, 0264
Lux May	0009, 0037
Luxor	0208, 0237, 0480, 0548, 1037
LXI	0047, 0054, 0154, 0156, 0178
M & S	0054
M Electronic	0009, 0037, 0287, 0480
Madison	0037
Magnadyne	0516
Magnafon	0516
Magnavox	0030, 0054, 0186, 0706
Magnum	0037, 0714
Mandor	0264
Manesth	0037, 0264
Manhattan	0037, 0668, 1037
Marantz	0030, 0037, 0054, 0556, 0704, 0855, 1154
Mark	0009, 0037, 0714
Masuda	0009, 0037, 0218, 0264
Matsui	0009, 0037, 0195, 0208, 0443, 0487, 0516, 0556, 0714, 1037
Matsushita	0051, 0250, 0650
Matsuyama	0587
Maxent	1755
MCE	0009
Mediator	0037
Medion	0037, 0556, 0668, 0698, 0714, 0808, 1037
Megapower	0700
Megas	0610
Megatron	0145, 0178
MEI	1037
Meile	0264
Melectronic	0009, 0037, 0480, 0634, 0661, 0714
Memorex	0009, 0060, 0150, 0154, 0178, 0250, 0463, 1037
Mercury	0009, 0037, 0060
Mermaid	0037

TV	
Metronic	0625
Metz	0037, 0447, 0587, 0668, 0746
MGA	0030, 0150, 0178, 0218
Micromaxx	0037, 0668, 0808, 1037
Microstar	0808
Midland	0017, 0047, 0051
Minato	0037
Minerva	0108, 0237, 0487, 0516
Minoka	0037
Mitsubishi	0030, 0037, 0093, 0108, 0150, 0154, 0178, 0180, 0236, 0237, 0250, 0474, 0556, 0836, 0868, 1015, 1037, 1150, 1171, 1182, 1250
Mivar	0516, 0609
Monaco	0009
Monivision	0700, 0843
Morgan's	0037
Motorola	0093
MTC	0030, 0060, 0370
MTLogic	0714
Mudan	0009, 0051, 0208, 0226, 0264
Multitec	0037, 0486, 0668, 1037
Multitech	0009, 0037, 0180, 0264, 0486
Murphy	0474
Musikland	0218
Myryad	0556
NAD	0156, 0178
Naiko	0037
Nanbao	0009, 0264
Nansheng	0264
NAT	0214, 0226
National	0051, 0208, 0214, 0226, 0237, 0508
NEC	0009, 0030, 0051, 0053, 0154, 0156, 0170, 0178, 0186, 0264, 0474, 0497, 0508, 0603, 0661, 0704, 0882, 1150, 1378, 1456, 1704
Neckermann	0037, 0327, 0370, 0556
NEI	0037
Netsat	0037
NetTV	1755
Neufunk	0009, 0037, 0218, 0556, 0610, 0714
New Tech	0009, 0037, 0556
New World	0218
Newave	0009, 0092, 0093, 0178, 1150
Nikka	0009, 0037, 0218, 0264
Nikko	0030, 0092, 0178
Noblex	0037, 0154, 0264
Nogamatic	0333
Nokia	0180, 0208, 0339, 0480, 0548, 0557, 0610
Norcent	0748, 0824
Nordmende	0037, 0195, 0287, 0299, 0560, 0714
Normerel	0037
Novatron	0037
NTC	0092
NU-TEC	0698
Oceanic	0208, 0548
Odeon	0264
Okano	0009, 0037, 0370
Omega	0264
Omni	0698
Onimax	0714
Onwa	0180, 0218
Opera	0037
Optimus	0154, 0166, 0250, 0650
Optonica	0093
Orbit	0037

TV	
Orion	0037, 0236, 0264, 0443, 0463, 0474, 0516, 0556, 0714, 1463
Orline	0037, 0218
Ormond	0668, 1037
Orsowe	0516
Osaki	0037, 0218, 0264, 0474, 0556
Osio	0037
Osc	0218
Osume	0037, 0218, 0474
Otto Versand	0037, 0093, 0226, 0556
Pacific	0556, 0714, 1037
Palladium	0037, 0370, 0714
Palsonic	0037, 0218, 0264, 0698
Panama	0037, 0264
Panasonic	0037, 0051, 0054, 0108, 0208, 0214, 0226, 0237, 0250, 0274, 0508, 0516, 0548, 0557, 0650, 0853, 1168, 1175, 1177, 1410
Panavision	0037
Panda	0009, 0051, 0208, 0226, 0264, 0508, 0698, 0706
Pathe Marconi	0237, 0299, 0333
Pausa	0009
Penney	0030, 0047, 0051, 0060, 0156, 0178, 1378
Perdio	0037
Perfekt	0037
Philco	0030, 0037, 0054, 0092, 0145, 0178, 0180, 0186, 0302, 0370, 0451, 0463, 0474, 0774, 1661
Philips	0000, 0009, 0017, 0030, 0037, 0051, 0054, 0092, 0108, 0178, 0186, 0293, 0323, 0474, 0556, 0690, 0774, 1154, 1455
Phoenix	0037, 0486
Phonola	0037, 0293
Pilot	0030
Pioneer	0037, 0166, 0170, 0287, 0486, 0679, 0760, 1260
Pionier	0370, 0486
Plantron	0009, 0037, 0264
Playsonic	0037, 0339, 0714
Poppy	0009
Portland	0092
Powerpoint	0037, 0487
Prandoni-Prince	0516
Premier	0009, 0264
Prima	0009, 0264, 0474, 0761
Princeton	0700
Prinston	1037
Prism	0051
Profex	0009
Profi	0009
Profitronic	0037
Proline	0037, 0625, 0634
Proscan	0047
Proscoc	0156
Prosonic	0037, 0214, 0370, 0668, 0714
Protech	0009, 0037, 0264, 0486, 0668, 1037
Proton	0009, 0030, 0178, 0474
ProVision	0037, 0556, 0714
Pulsar	0017
Pye	0037, 0293, 0556
Pymi	0009
Qingdao	0051, 0208, 0226, 0264
Quadral	0218
Quasar	0009, 0051, 0250, 0650
Quelle	0037, 0306, 0327, 0668
R-Line	0037
Radialva	0218
Radiola	0037, 0323, 0556
Radiomarelli	0037, 0516

TV	
RadioShack	0030, 0037, 0047, 0154, 0178, 0180
Radiotone	0009, 0037, 0264, 0668, 1037
RBM	0089
RCA	0000, 0030, 0047, 0051, 0060, 0090, 0092, 0093, 0178, 0560, 0618, 0625, 0679
Realistic	0030, 0154, 0178, 0180
Recor	0037
Rectiligne	0037
Rediffusion	0548
Reflex	0037, 0668, 1037
Relisys	0865
Reoc	0714
Revox	0037
Rex	0264
RFT	0037, 0264
Roadstar	0009, 0037, 0218, 0264, 0668, 1037
Rowa	0009, 0037, 0264, 0587, 0698, 0748
Royal Lux	0370
Runco	0017, 0030, 0497, 0603
Saba	0250, 0287, 0299, 0516, 0548, 0557, 0560, 0625, 0714
Sagem	0610
Saige	0009
Saisho	0009, 0264, 0516
Saivod	0037, 0668, 1037
Salora	0208, 0480, 0516, 0548
Sambers	0516
Sampo	0009, 0030, 0092, 0093, 0154, 0171, 0178, 0474, 0650, 0700, 1755
Samsung	0009, 0030, 0037, 0060, 0090, 0092, 0093, 0154, 0156, 0178, 0208, 0226, 0264, 0370, 0408, 0474, 0556, 0587, 0618, 0702, 0766, 0774, 0812, 0814, 1150
Sanjian	0264
Sansei	0451
Sansui	0037, 0463, 0706
Santon	0009
Sanyo	0088, 0108, 0145, 0154, 0156, 0180, 0208, 0232, 0264, 0339, 0370, 0376, 0424, 0474, 0484, 0508, 0799, 0893, 1150, 1154, 1179
Sanyuan	0009, 0093
SBR	0037, 0556
Sceptre	1217
Schaub Lorenz	0486, 0548, 0557, 0714
Schneider	0037, 0218, 0323, 0556, 0668, 0714, 1037
Scotch	0178
Scott	0178, 0180, 0236
Sears	0047, 0054, 0154, 0156, 0171, 0178
Seaway	0634
Seelver	1037
SEG	0009, 0037, 0218, 0264, 0634, 0668, 1037
SEI	0037, 0516
Sei-Sinudyne	0037, 0516
Seleco	0264
Semivox	0180, 0236, 0463
Semp	0156
Sencora	0009
Serie Dorada	0030, 0156, 0178, 0180
Serino	0093, 0610
Shancha	0264
Shanghai	0009, 0208, 0226, 0264
Shaofeng	0145

TV	
Sharp	0009, 0030, 0053, 0093, 0256, 0398, 0474, 0491, 0516, 0650, 0720, 0787, 0851, 1165, 1193
Shen Ying	0009, 0092, 0474
Shencai	0009, 0145, 0264
Sheng Chia	0009, 0093, 0236, 0474, 1150
Shenyang	0009, 0264
Sherwood	0009
Shintoshi	0037
Shivaki	0037, 0178, 0443
Show	0009
Siam	0037
Siarem	0516
Siemens	0037, 0195, 0327
Siesta	0370
Silva	0037
Silva Schneider	0037
Simpson	0186
Singer	0009, 0037
Sinudyne	0037, 0516
SKY	0037
Skygiant	0180
Skyworth	0009, 0037, 0264, 0698, 0748
SLX	0668
Smaragd	0487
Soemtron	0865
Solavox	0037, 0548
Sonawa	0218
Songba	0009
Soniko	0037
Sonitron	0208, 0339, 0370
Sonneclair	0037
Sonoko	0009, 0037, 0264
Sonorior	0208, 0548
Sontec	0009, 0037, 0370
Sony	0000, 0037, 0053, 0093, 0111, 0145, 0150, 0156, 0170, 0250, 0424, 0650, 0834, 1167, 1300, 1651
Sound & Vision	0218
Soundesign	0178, 0180, 0186
Soundwave	0037
Sowa	0051, 0060, 0092, 0156, 0178, 0226, 0474, 1150
Spectra	0009
Squareview	0171
Ssanyong	0009
SSS	0180
Staksonic	0009
Standard	0009, 0037, 0218, 1037
Starlite	0009, 0037, 0180, 0264
Stenway	0218
Strato	0009, 0037, 0264
Studio Experience	0843
Sunkai	0487, 0610
Sunstar	0009, 0037, 0264
Sunwood	0037
Superla	0516
Superscan	0864
Supersonic	0009, 0208
SuperTech	0009, 0037, 0218, 0556
Supra	0009, 0178
Supreme	0000
Susumu	0218, 0287, 0474
Sutron	0009
SVA	0587, 0748, 0865, 0870, 0871
Sylvania	0030, 0054, 0171
Symphonic	0171, 0180
Synco	0000, 0060, 0092, 0093, 0178, 0451, 0474
Sysline	0037
T + A	0447
T+A	0447

TV	
Tacico	0009, 0092, 0178, 0474, 1150
Tai Yi	0009, 1150
Taishan	0009
Talent	0178
Tandy	0093, 0218
Targa	0702
Tashiko	0092, 0650, 1150
Tatung	0009, 0037, 0051, 0054, 0060, 0154, 0156, 0474, 0516, 1150, 1756
TCL	0698
TCM	0714, 0808
Teac	0009, 0037, 0170, 0171, 0178, 0264, 0668, 0698, 0706, 0714, 1037, 1755
Tec	0009, 0037, 0474
Tech Line	0037, 0668
Techica	0218
Technics	0051, 0250, 0556, 0650
TechniSat	0556
Techview	0847
Techwood	0051
Tecnimagen	0556
Teco	0009, 0051, 0092, 0093, 0178, 0218, 0264, 0474, 0653
Tedelex	0009, 0208
Tek	0009
Teknika	0054, 0060, 0092, 0150, 0180, 0186, 0322
Teleavia	0299, 0333
Telecor	0037, 0218
Telefunken	0037, 0073, 0287, 0306, 0486, 0560, 0587, 0625, 0698, 0702
Telefusion	0037
Telegazi	0037, 0218, 0264
Telesonic	0037
Telestari	0009, 0037, 0556
Teletech	0009, 0037, 0668, 1037
Teleton	0186
Television	0037
Tempest	0009, 0264
Tennessee	0037
Tensai	0009, 0037, 0218
Tenson	0009
Tera	0030, 0474
Tevion	0037, 0668, 0714, 1037
Textet	0009, 0218
Thomson	0037, 0237, 0287, 0299, 0333, 0560, 0574, 0625
Thorn	0037, 0073, 0192
Thorn-Ferguson	0073, 0192
Tiane	0093
TMK	0178
TNCi	0017
Tobishi	0218
Tobo	0009, 0264, 0748
Tokai	0009, 0037, 0668, 1037
Tokaido	1037
Tomashi	0218
Tongguang	0264
Tophouse	0180, 0672
Toshiba	0009, 0060, 0089, 0093, 0145, 0154, 0156, 0195, 0264, 0508, 0509, 0618, 0650, 0714, 0832, 0845, 1150, 1169, 1173, 1456, 1704
Toyoda	0009, 0264
Trakton	0009, 0264
Trans Continen	0037, 0668, 1037
Transonic	0009, 0037, 0264, 0587, 0698
Triad	0556
Trident	0516
Tristar	0218, 0264

TV	
Triumph	0516, 0556
Tuntex	0009, 0030, 0092, 0474
TVS	0463
TVTEXT 95	0556
Uher	0037, 0480, 0486
Ultra	0192
Ultravox	0037
Unic Line	0037
United	0037, 0714
Universal	0037
Universum	0009, 0037, 0170, 0264, 0306, 0327, 0370, 0474, 0480, 0618, 0668, 1037
Univox	0037
V Inc.	0864, 0885, 1756
V7	1755
Vector Research	0030
Vestel	0037, 0556, 0668, 1037
Vexa	0009, 0037
Victor	0053, 0160, 0250, 0376, 0650, 0653
Videocon	0508
Videologic	0218
Videologique	0218
Videomac	0009
VideoSeven	1755
VideoSystem	0037
Vidikron	0054
Vidtech	0178
Viewsonic	0857, 0864, 0885, 1755
Vinc	0864, 0885, 1756
Vision	0037, 0264, 0474
Vortec	0037
Voxson	0178
Waltham	0037, 0668, 1037
Wards	0000, 0017, 0030, 0047, 0051, 0054, 0060, 0111, 0154, 0156, 0166, 0178, 0180, 0186
Warumaia	0661
Watson	0009, 0037, 0218, 0668, 1037
Waycon	0156
Wega	0037
Weipai	0009
Westinghouse	0889
Wharfedale	0037, 0556
White Westinghouse	0037, 0186, 0463
Windsor	0668, 1037
Windy Sam	0556
Wintel	0714
Xenius	0634, 0661
Xiahua	0009, 0264, 0698
Xianghai	0009
Xiangyang	0264
Xiangyu	0009
Xihu	0264
Xingfu	0009
Xinghai	0264
XLogic	0698
XMS	0698
Xoro	1217
Xrypton	0037
Yamaha	0030, 0650, 0769, 0833
Yamishi	0037, 0218
Yapshe	0250
Yingge	0009
Yokan	0037
Yoko	0009, 0037, 0218, 0264, 0339
Yonggu	0009
Yorx	0218
Yousida	0009
Yuhang	0009
Zanussi	0264
Zenith	0017, 0092, 0178, 0463

TV	
Zenor	0339
Zhuhai	0009
Zonda	0698

TV/VCR	
America Action	0180
Audiovox	0180
Emerson	0236
Mitsubishi	1150

TV/DVD	
Bush	0698, 1037
Denver	0587
Sylvania	0171

VCR Codes

VCR	
ABS	1972
Admiral	0048
Adventura	0000
Aiwa	0000, 0037, 0348, 1137, 1291
Akai	0037, 0041, 0240, 0315, 0348, 0642
Alba	0000, 0081, 0315, 0348
Alienware	1972
Allegro	1137
Allorgan	0240
Allstar	0081
American High	0035
Amstrad	0000
Anam	0037, 0162, 0226, 0240
Anam National	0162, 0226, 1562
Ansonic	0000
Aristona	0081
ASA	0037, 0081
Asha	0240
Asuka	0037, 0038
Audiovox	0037
AVP	0000
Awa	0037, 0043, 0642
Baird	0000, 0041, 0104
Basic Line	0046, 0104
Beaumarck	0240
Beko	0104
Bell & Howell	0104
Black Diamond	0642
Blaupunkt	0081, 0162, 0226
Blue Sky	0037, 0348, 0642, 1137
Brand Unknown	0104, 0348
Brandt	0041, 0320
Brandt Electronic	0041
Brandt Electronique	0041
Brinkmann	0348
Broksonic	0121, 0184, 0348
Bush	0000, 0081, 0315, 0348, 0642
Calix	0037
Canon	0035
Carena	0081
Carrefour	0045
Carver	0081
Casio	0000
CGE	0000, 0041
Changhong	0048, 0081
CineVision	1137
Citizen	0037
Clatronic	0000
Craig	0037, 0047, 0240
Crown	0037
Curtis Mathes	0035, 0041, 0060, 0162

VCR	
Cybermex	0240
CyberPower	1972
Cyrus	0081
Daewoo	0045, 0046, 0104, 0642, 1137
De Graaf	0042, 0046, 0048, 0081, 0104
Decca	0000, 0041, 0067, 0081
Denon	0042
Diamant	0037
Diamond	0348
Dick Smith Electronics	0642
Digitor	0642
DirecTV	0739, 0740, 0745, 1239, 1240
DSE	0642
Dual	0000, 0041, 0081, 0348
Dumont	0000, 0081, 0104
Durabrand	0038, 0039
Dynatech	0000
Elbe	0038
Electrohome	0037
Electroponic	0037
Elin	0240
Emerex	0032
Emerson	0000, 0035, 0037, 0043, 0045, 0121, 0184, 0240
ESA	1137
ESC	0240
EverFocus	1346
Ferguson	0000, 0041, 0320
Fidelity	0000, 0240, 0432
Finlandia	0000, 0037, 0042, 0043, 0046, 0048, 0081, 0104, 0226
Finlux	0000, 0042, 0081, 0104
Firstline	0037, 0043, 0045, 0348, 1137
Fisher	0046, 0047, 0104
Flint	0348
Fuji	0033, 0035
Fujitsu	0000, 0045
Fujitsu General	0037
Funai	0000
Galaxi	0000
Garrard	0000
Gateway	1972
GE	0035, 0048, 0060, 0226, 0240, 0320
GEC	0081
General	0045
General Technic	0348
Genexxa	0104
Go Video	0432, 1137
GoldStar	0037, 0038, 0226
Goodmans	0000, 0037, 0081, 0348, 0642
GPX	0037
Gradiente	0000
Graetz	0041, 0104, 0240
Granada	0000, 0037, 0042, 0046, 0048, 0081, 0104, 0226, 0240
Grandin	0000, 0037
Grundig	0081, 0226, 0320, 0347, 0348
Haaz	0348
Hanseatic	0037, 0038, 0081
Haojie	0240
Harley Davidson	0000
Harman/Kardon	0038, 0081
Headquarter	0046
Hewlett Packard	1972
HI-Q	0047
Hinari	0041, 0240
Hischito	0045

VCR	
Hitachi	0000, 0037, 0041, 0042, 0046, 0081, 0240
Hoher	0642
Hornophon	0081
Hughes Network Syst	0042
Hughes Network Systems	0042, 0739, 0740, 0745, 1239, 1240
Humax	0739
Hush	1972
Hypson	0000, 0037
iBUYPOWER	1972
Imperial	0000
Ingersoll	0240
Intel	0847
Interbuy	0037
Interfunk	0081, 0104
International	0037, 0642
Intervision	0000
IR	0041, 0042, 0045, 0047, 0081, 0104, 0226, 0240, 0348
Irradio	0037, 0081
ITT	0041, 0046, 0104, 0240
ITV	0037
Jensen	0041
JMB	0348
Joyce	0000
JVC	0041, 0045, 0067, 0081, 1008
Kambrook	0037
Karcher	0081
KEC	0037
Kendo	0315, 0348, 0642
Kenwood	0038, 0041, 0067
KIC	0000
Kimari	0047
Kioto	0348
Kneissel	0037, 0348
Kodak	0035, 0037
Kolin	0041, 0043
Kuba	0047
Kuba Electronic	0047
Kuwa	0226
LG	0037, 0038, 0042, 0045, 1137, 1237
Lifetec	0348
Linksys	1972
Lloyd's	0000
Loewe	0037, 0081, 0162, 1562
Logik	0240
Lunatron	1137
Luxor	0043, 0046, 0047, 0048, 0104, 0315
LXI	0037
M Electronic	0000, 0038
Magnavox	0000, 0035, 0039, 0081, 0642
Magnin	0240
Magnum	0642
Manesth	0045, 0081
Marantz	0035, 0038, 0081
Mark	0000
Marta	0037
Matsui	0240, 0348
Matsushita	0035, 0162, 0226
Mediator	0081
Medion	0348, 0642
MEI	0035
Melectronic	0000, 0037, 0038
Memorex	0000, 0035, 0037, 0039, 0046, 0047, 0048, 0104, 0162, 0240, 0348
Metronic	0081
Metz	0037, 0081, 0162, 0226, 0347, 1562
MGA	0043, 0240

VCR	
MGN Technology	0240
Micormay	0348
Microsoft	1972
Migros	0000
Mind	1972
Minolta	0042
Mitsubishi	0000, 0041, 0043, 0048, 0067, 0081, 0642, 1343
Motorola	0035, 0048
MTC	0000, 0240
Multitec	0037
Multitech	0000
Murphy	0000
Myryad	0081
NAD	0104
Naiko	0642
National	0226
Nebula Electronics	0033
NEC	0035, 0037, 0038, 0041, 0048, 0067, 0104, 1287
Neckermann	0081
Nesco	0000
Newave	0037
Nikko	0037
Niveus Media	1972
Noblex	0240
Nokia	0041, 0042, 0046, 0048, 0081, 0104, 0240, 0315
Nordmende	0041, 0067, 0320
Northgate	1972
Oceanic	0000, 0041, 0046, 0048, 0081, 0104
Okano	0315, 0348
Olympus	0035, 0226
Onimax	0642
Optimus	0037, 0048, 0104, 0162, 0432, 1062
Orion	0121, 0184, 0348
Orson	0000
Osaki	0000, 0037
Otto Versand	0081
Pacific	0000, 0348, 0642
Packard Bell	1972
Palladium	0037, 0041, 0348
Palsonic	0000, 0642
Panasonic	0035, 0162, 0226, 0614, 0616, 1062, 1244, 1293, 1562
Pathe Cinema	0043
Pathe Marconi	0041
Penney	0035, 0037, 0038, 0042, 0240
Pentax	0042
Perdio	0000
Philco	0000, 0035, 0038, 0226
Philips	0000, 0035, 0081, 0226, 0618, 0739, 0749, 1269, 1340
Phonola	0081
Pilot	0037
Pioneer	0042, 0067, 0081, 0162
Polk Audio	0081
Prinz	0000
Profitronic	0081, 0240
Proline	0000, 0320, 0642
Proscan	0060
Protech	0081
Pulsar	0039
Pye	0000, 0081
Qisheng	0060
Quarter	0046
Quartz	0046
Quasar	0035, 0162
Quelle	0081
Radialva	0037, 0048, 0081
Radiola	0081
Radionette	0037, 1137

VCR	
RadioShack	0000, 0037
Radix	0037
Randex	0037
Rank	0041
Rank Arena	0041
RCA	0000, 0035, 0042, 0048, 0060, 0226, 0240, 0320, 0880
Realistic	0000, 0035, 0037, 0046, 0047, 0048, 0104
Reel Multimedia	1424
Reoc	0348
ReplayTV	0614, 0616, 1615, 1616
Rex	0041
Ricavision	1972
Rio	1137
Roadstar	0037, 0081, 0240
Runco	0039
Saba	0041, 0320
Saisho	0348
Salora	0043, 0046, 0104
Sampo	0037, 0048
Samsung	0045, 0240, 0432, 1014
Sanky	0039, 0048
Sansei	0048
Sansui	0000, 0041, 0067, 0348
Sanyo	0046, 0047, 0048, 0067, 0104, 0240, 0348
Saville	0240
SBR	0081
Schaub Lorenz	0000, 0041, 0104, 0315, 0348
Schneider	0000, 0037, 0042, 0081, 0240, 0348, 0642
Scott	0043, 0045, 0121, 0184
Sears	0000, 0035, 0037, 0042, 0046, 0047, 0104
SEG	0081, 0240, 0642
SEI	0081
Sei-Sinudyne	0081
Seleco	0037, 0041
Semivox	0045
Semp	0045
Sharp	0037, 0048, 0807, 1285
Shinco	0000
Shintom	0104
Shivaki	0037
Shogun	0240
Siemens	0037, 0046, 0081, 0104, 0320, 0347
Siera	0081
Siiva	0037
Singer	0045, 0348
Sinudyne	0081
Smaragd	0348
Sonic Blue	0614, 0616, 1137, 1615, 1616
Sonolor	0046
Sontec	0037
Sony	0000, 0032, 0033, 0035, 0636, 1232, 1437, 1438, 1447, 1448, 1636, 1972
Soundwave	0037, 0348
Stack 9	1972
STS	0042
Sunkai	0348
Sunstar	0000
Suntronic	0000
Supra	0037, 0348
Sylvania	0000, 0035, 0043, 0081
Symphonic	0000
T+A	0162
Tagar Systems	1972
Tandy	0000, 0104
Tashiko	0000, 0037, 0048, 0081, 0240

VCR	
Tatung	0000, 0041, 0043, 0045, 0048, 0067, 0081, 0348
Tchibo	0348
TCM	0348
Teac	0000, 0037, 0041, 0642
Technics	0035, 0081, 0162, 0226
TechniSat	0348
Teco	0035, 0037, 0038, 0041, 0048
Tedelex	0037, 0348
Teknika	0000, 0035, 0037
Teleavia	0041
Telefunken	0041, 0320, 0642
Telestar	0037
Teletech	0000
Tensai	0000
Tevion	0348, 0642
Thomas	0000
Thomson	0041, 0060, 0067, 0320, 0722, 1722, 1723
Thorn	0037, 0041, 0104
Tivo	0618, 0636, 0722, 0739, 0740, 0745, 0749, 1239, 1240, 1437, 1438, 1503, 1722, 1723
TMK	0240
Tokai	0037, 0041, 0104
Topline	0348
Toshiba	0041, 0042, 0043, 0045, 0067, 0081, 0432, 0828, 0845, 1008, 1290, 1503
Totevision	0037, 0240
Touch	1972
Tradex	0081
Uher	0240
Unitech	0240
United	0348
Universum	0000, 0037, 0081, 0104, 0240, 0348, 1137
Vector	0045
Vector Research	0038
Victor	0041, 0067
Video Concepts	0045
Video Technic	0000
Videomagic	0037
Videosonic	0240
Viewsonic	1972
Villain	0000
Voodoo	1972
Wards	0000, 0033, 0035, 0038, 0039, 0042, 0045, 0046, 0047, 0048, 0060, 0081, 0240
Watson	0081, 0642
Weltblick	0037
Wharfedale	0642
World	0348
Xoro	1080
XR-1000	0000, 0035
Yamaha	0038, 0041
Yoko	0037, 0240
Zenith	0000, 0033, 0039, 1137
ZT Group	1972
ZX	0348

TV/VCR	
Aiwa	0000
Broksonic	1479
Citizen	1278
Curtis Mathes	1035
Daewoo	1278
Emerson	1278, 1479
Funai	0000
GE	0240, 0807, 1035
GoldStar	1237
Harley Davidson	0000
Hitachi	0000

TV/VCR	
Lloyd's	0000
Magnasonic	1278
Magnavox	0000, 1781
Magnin	0240
Memorex	0162, 1237
MGA	0240
Mitsubishi	0043, 0807
Orion	1479
Panasonic	0162, 1035
Penney	0240, 1035, 1237
Quasar	0162, 1035
RadioShack	0000
RCA	0240, 0807, 1035
Samsung	0432, 1014
Sansui	0000, 1479
Sanyo	0240, 1330
Sears	0000, 1237
Sharp	0807
Sony	0000, 1232, 1295, 1296
Sylvania	1781
Symphonic	0000
Teac	0000
Thomas	0000
Toshiba	0845, 1145
Zenith	0000, 1479

PVR	
ABS	1972
Alienware	1972
CyberPower	1972
Dell	1972
DirectTV	0739
EverFocus	1346
Gateway	1195, 1196, 1972
Hewlett Packard	1972
Howard Computers	1972
HP	1972
Hughes Network Systems	0739
Humax	0739
Hush	1972
iBUYPOWER	1972
Intel	0847
JVC	1279
Keen	0693
Linksys	1972
Media Center PC	1972
Microsoft	1972
Mind	1972
Niveus Media	1972
Northgate	1972
Panasonic	0616, 1244
Philips	0618, 0739, 0749, 1269, 1340
RCA	0880
Reel Multimedia	1424
ReplayTV	0614, 0616, 1615, 1616
Sonic Blue	0614, 0616, 1615, 1616
Sony	0636, 1437, 1438, 1447, 1448, 1636, 1972
Stack 9	1972
Systemax	1972
Tagar Systems	1972
Thomson	0722, 1722, 1723
Tivo	0618, 0636, 0722, 0739, 0740, 0745, 0749, 1239, 1240, 1437, 1438, 1722, 1723
Toshiba	0828, 1008, 1972
Touch	1972
Viewsonic	1972
Voodoo	1972
ZT Group	1972

SAT/CABLE Codes

Satellite	
@sat	1300
ABsat	0123
ADB	0642, 1259
Aiwa	1514
Akai	0200, 0515
Alba	0515
Allsat	0200
AlphaStar	0772
Ampere	0132
Amstrad	0132, 0338, 0461, 0795, 0847, 0863, 1175
Arnion	1300
Asat	0200
AssCom	0853
Aston	1261
Astro	0173, 1099
Atlantic Telephone	1333
Atsat	1300
Aurora	0642, 0879, 1333
Austar	0497, 0642, 0863, 0879, 1259
Axis	1111
Blaupunkt	0173
Boca	0132
Brand Unknown	0132, 0461
British Sky Broadcasting	0847, 1175, 1847
BskyB	0847, 1175
BT	0515
Cambridge	0515
Canal Digital	0853
Canal Satellite	0853
Canal+	0853
CanalSatellite	0853
Century	0856
Chaparral	0216
Cherokee	0123
CityCom	1176
Colombia	0132
Columbia	0132
Comag	0132
Connexions	0168, 0576
Conrad	0132
Crossdigital	1109
Cryptovision	0795
CX	0168
Cyrus	0200
D-box	0723, 0873
Daewoo	1111
Delfa	0863
Dgtec	1242
DigiQuest	0863
DigitAll World	1227
Digiturk	1076
DirecTV	0099, 0247, 0392, 0566, 0639, 0724, 0749, 0819, 1076, 1108, 1109, 1142, 1392, 1414, 1442, 1597, 1639, 1640, 1749, 1750, 1856
Dish Network System	0775, 1005, 1170, 1505, 1775
Dishpro	0775, 1005, 1505, 1775
Disk Express	0168
Diskxpress	0168
DNT	0200
Dream Multimedia	1237
DREAM multimedia.TV	1237
DStv	0642, 0879
DX Antenna	1530
Echostar	0167, 0610, 0775, 0853, 0871, 1005, 1086, 1170, 1200, 1505, 1775
Einhell	0132

Satellite

Elta	0200
Emme Esse	0871
Europa	0863
Europhon	0132
Eurosky	0132
Exator	0515
Expressvu	0775, 1775
Fidelity	0461
Foxtel	0497, 0720, 0879, 1176, 1356
Fracarro	0871
Freecom	0335
FTEmaximal	0863
Fuba	0173
Funai	0168, 0338, 0576
Galaxis	0853, 0863, 0879, 1111
GE	0566
General Instrument	0869
General Instruments	0869
GOD Digital	0200
GOI	0775, 1775
Gold Box	0853
Goldbox	0853
GoldStar	0335
Gooding	0571
Goodmans	1246
Gradiente	0099, 0856, 0887
Grothusen	0335
Grundig	0173, 0571, 0847, 0853, 0879
Hanseatic	1099
Hirschmann	0173, 1111
Hisense	1535
Hitachi	0819, 1250, 1525
HNE	0132
Hornet	1300
Houston	0461
HSnsel & Gretel	0132
HTS	0775, 1775
Hughes Network Syst	0749
Hughes Network Systems	0749, 1142, 1442, 1597, 1749, 1750
Humax	0863, 1176
Huth	0132, 0335
I-Lo	1535
ID Digital	1176
Indovision	0887
Innova	0099
International	0132
InVideo	0871
IR	0173, 0338, 0461
Irdeto Technology	0879
ISkyB	0887
Italtel	0871
ITT Nokia	0723, 0873
JVC	0492, 0505, 0506, 0515, 0571, 0775, 1170, 1531, 1775
Kaon	1300
KaTelco	1111
Kathrein	0123, 0173, 0200, 0249, 1221
Kenwood	0853
Key West	0132
Kosmos	0335
Kreiling	0249
Kreiselmeier	0173
L&S Electronic	0132
LaSAT	0132
Lenco	0335
Leyco	0515
LG	0335, 0461, 1226, 1414, 1750, 1902
Lifesat	0132
Lorenzen	0132

Satellite

Lorraine	0335
Magnavox	0722, 0724
Manata	0132
Marantz	0200
Maspro	0173, 0571, 1530
Matsui	0173, 0571
Mediacom	1206
MediaSat	0853
Medion	0132
Mega	0200
Memorex	0724
Metz	0173
Minerva	0571
Mitsubishi	0749, 1597
Morgan's	0132, 0200
Motorola	0856, 0869
Multichoice	0642, 0879, 1333
Muratto	0335
Myryad	0200
NEC	1270, 1519
Netsat	0099, 0887
Neuling	0132
Next Level	0869
Nikko	0200
Nokia	0723, 0751, 0853, 0873, 1023
OctalTV	1505
OnDigital	0751
Optus	0879
Orbitech	1099
Origo	0497
Oxford	0515
Pace	0200, 0497, 0720, 0795, 0847, 0853, 0887, 1175, 1356
Packard Bell	1111
Palladium	0571
Panasat	0615, 0879, 1333
Panasonic	0247, 0701, 0847, 1526
Panda	0173
Patriot	0132, 0515
Paysat	0724
Philips	0099, 0173, 0200, 0571, 0722, 0724, 0749, 0853, 0856, 0887, 1076, 1114, 1142, 1442, 1597, 1749
Phonotrend	0863, 1200
Pioneer	0853
Planet	0871
Preisner	0132
Premiere	0853, 0873
Prima	0795
Primacom	1111
Proscan	0392, 0566
Proton	1535
Pye	0571
Radiola	0200
RadioShack	0869
RCA	0143, 0392, 0566, 0855, 1392
RFT	0200
Roadstar	0853
Sagem	0820, 1114, 1307
Samsung	0853, 0863, 1108, 1109, 1206, 1276
Sanyo	1219
SAT	0461
Sat Control	1300
Sat Partner	0335
SatPartner	0335
Schneider	1206
Schwaiger	0132, 0863, 1111
Sedea Electronique	0132, 1206
Seemann	0515
Seleco	0871
Serino	0610

Satellite	
Sharp	1517
Siemens	0173
Silva	0335
SKY	0099, 0847, 0856, 0887, 1014, 1175, 1847, 1856
SKY Italia	1847
Sky Television	1014
SKY+	1175
Skymaster	1200
Skymax	0200
SL	0132
SM Electronic	1200
Smart	0132
Sony	0492, 0639, 0847, 0853, 1524, 1639, 1640
SR	0132
Star	0887
Star Choice	0869
Starlite	0200
Stream	1847
Strong	0132, 0168, 0576, 0853, 0879, 1300
Sunkai	0123
Sunstar	0132, 0642
Supernova	0887
Teac	1227
Tecatel	1200
TechniSat	0200, 0863, 1099
Technosat	1206
Technowelt	0132
Telestar	1099
Televés	0132, 1300
Televisa	0887
Thomson	0392, 0820, 0847, 0853, 1046
Tioko	0132
Tivo	1142, 1442
Tokai	0200
Topfield	1206
Toshiba	0749, 0790, 1285, 1516, 1530, 1597, 1749
TPS	0820, 1307
Triad	0335
Triax	0132, 0200, 0853, 1099, 1227
UEC	0879, 1333
UltimateTV	1392, 1640
Uniden	0722, 0724, 1521
Unisat	0132, 0200
Universum	0173, 0461, 0571, 1099
US Digital	1535
USDTV	1535
Variosat	0173
Ventana	0200
Victor	0492, 0505, 0506
Viva	0856
Voorn	0869
Wisi	0173
Worldsat	0123
XCOM	0123
Xsat	0123, 0847
Xtreme	1300
Yes	0887
Zenith	0856, 1856

Cable	
ABC	0003, 0008, 0014, 0017, 0033, 0237
Americast	0899
Archer	0797
Austar	0012, 0276
Bell & Howell	0014
Bell South	0899
Birmingham Cable Communications	0276
British Telecom	0003
Cable & Wireless	1068
Clearmaster	0883
ClearMax	0883
Coolmax	0883
Daeryung	0008, 0477, 0877, 1877
Digi	0637
Director	0476
Dumont	0637
DX Antenna	1500
Emerson	0797
France Telecom	0817
Fujitsu	1497
Galaxi	0008
GE	0237
Gehua	0476
Gemini	0797
General Instrument	0003, 0014, 0276, 0476, 0810
General Instruments	0003, 0276, 0476
GMI	0797
GoldStar	0144
Goodmind	0797
Hamlin	0009, 0273
Hitachi	0014, 0033
Jerrold	0003, 0012, 0014, 0276, 0476, 0810
Kabelvision	0003
KNC	0008
LG	0144
Macab	0817
Macom	0033
Magnavox	0014
Melita	0003
Memorex	0000
Motorola	0276, 0476, 0810, 1106, 1254, 1376
Mr Zapp	0817
Multitech	0883
MultiVision	0012
NEC	1496
Noos	0817
NTL	0003, 0276, 1060, 1068
Ono	1068
Optimus	0021
Optus	0276, 1060
Pace	0237, 1060, 1068, 1877
Pacific Bell	0843
Panasonic	0000, 0008, 0021, 0107, 1488
Panther	0637
Paragon	0000
Philips	0317, 0817, 1305
Pioneer	0144, 0533, 0877, 1021, 1500, 1877

Cable	
Pulsar	0000
PVP Stereo Visual Matrix	0003
Quasar	0000
RadioShack	0797, 0883
RCA	0021, 0487, 0843, 1256
Regal	0273, 0279
Runco	0000
Sagem	0817
Salora	0000
Samsung	0000, 0144, 1060
Scientific Atlanta	0008, 0017, 0237, 0477, 0877, 1068, 1877
Sony	1006, 1460
Sprucer	0021
Starcom	0003, 0014
Stargate	0797
Sumitomo	1500
Supercable	0276
Supermax	0883
Telewest	1068
Thomson	1256
Time Warner cable	1877
Tocom	0012
Torx	0003
Toshiba	0000, 1509
Trans PX	0276
TransACT	1106
Tristar	0883
TS	0003
United Cable	0003
US Electronics	0276
V2	0883
Viewmaster	0883
Vision	0883
Visiopass	0817
Vortex View	0883
Zenith	0000, 0008, 0525, 0899

SN 29344054

(C) Copyright 2005 ONKYO CORPORATION Japan. All rights reserved.

107960

10502-1



* 2 9 3 4 4 0 5 4 *

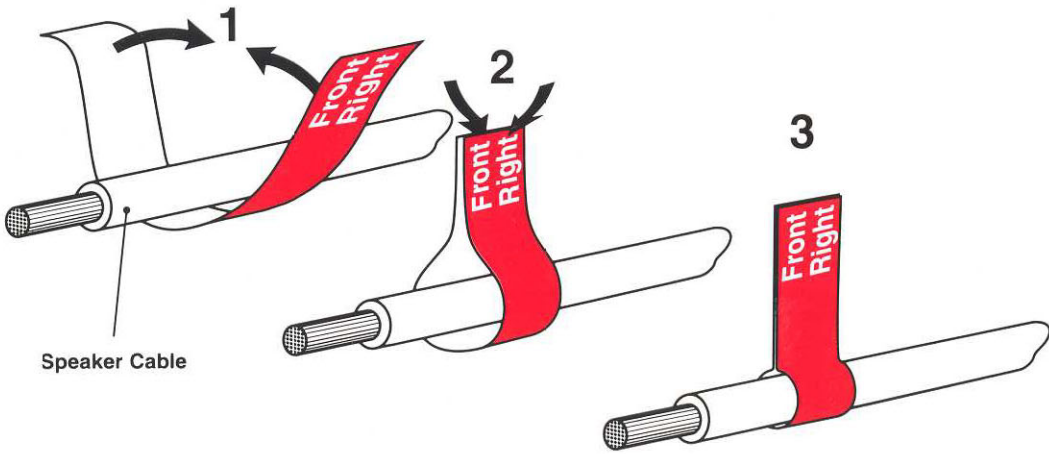

Front Left	Front Left
Front Left	Front Left
SP-B/Zone 2 Left	SP-B/Zone 2 Left
SP-B/Zone 2 Left	SP-B/Zone 2 Left

Front Right	Front Right
Front Right	Front Right
SP-B/Zone 2 Right	SP-B/Zone 2 Right
SP-B/Zone 2 Right	SP-B/Zone 2 Right

Surround Left	Surround Left
Surround Left	Surround Left

Surround Right	Surround Right
Surround Right	Surround Right

Center	Center
Center	Center

Surround Back Left	Surround Back Left
Surround Back Left	Surround Back Left
Zone 2 Left	Zone 2 Left
Zone 2 Left	Zone 2 Left

Surround Back Right	Surround Back Right
Surround Back Right	Surround Back Right
Zone 2 Right	Zone 2 Right
Zone 2 Right	Zone 2 Right

POST OFFICE
WILL NOT
DELIVER
WITHOUT
PROPER POSTAGE

REGISTRATION DEPARTMENT

ONKYO USA CORPORATION

18 PARK WAY
UPPER SADDLE RIVER, NJ 07458 USA

ONKYO®

Tape here

ONKYO Product REGISTRATION CARD

Thank you for purchasing our product. In order to protect your investment and to ensure that you receive information on new products, future updates or new releases, please register your product. You have two ways to do it.

- Quick and Easy -

Please visit our web site for your on-line registration at

<http://www.onkyousa.com>

Or please fill out this registration card and return it to us. Please remember to keep your receipt of your purchase for warranty and the other part of this card for future reference.

 First Name Middle Initial Last Name

 Address Apt/Suite

 City State Zip

 E-mail Address Phone Number

Age: 18 – 24 25 – 31 32 – 40 41- 60 61 + Male Female

Name and location of the Dealer you purchased the product from?

 Date of Purchase Model Serial Number

Would you like to receive a product catalog every new model year?

Yes No

How did you learn about Onkyo Products?

Advertisement Review Salesman Friend Other

Do you own other Onkyo Products? If yes, what is the model number

Yes No

What other brands of stereo products or multi media products have you owned before?

What factors influenced your purchase decision?

Features Sound Quality Design Price Recommendation

What other Audio/Video/multi media Equipment are you looking to purchase in the future?

When do you plan to purchase your next audio or multi media product?

3 Months 6 Months 9 Months 12 Months 24 Months

Other Comments/Suggestions about this product

ONKYO USA CORPORATION

18 Park Way
 Upper Saddle River, NJ 07458 USA
 Phone: 201-785-2600
 Fax : 201-785-2650
<http://www.onkyousa.com>

Onkyo USA Limited Warranty

PLEASE RETAIN YOUR ORIGINAL BILL OF SALE. YOU WILL NEED TO PRESENT IT SHOULD YOU REQUIRE SERVICE UNDER THIS WARRANTY.

Onkyo USA Corporation (hereinafter referred to as Onkyo) hereby warrants all Onkyo products sold by Onkyo or Onkyo authorized dealers in accordance with the following terms and conditions:

WARRANTY PERIOD:

Receivers and Amplifiers	2 years Parts & labor
Home Theater Speakers	2 years Parts & labor
CD, DVD Players & Tape Decks	1 year Parts & labor
CD, DVD Receivers	1 year Parts & labor
Mini Systems	1 year Parts & labor
Multimedia & Audio/Video Accessories	1 year Parts & labor

SCOPE OF WARRANTY:

From the date of original purchase and for the respective periods specified above, Onkyo agrees to repair at its sole expense, all Onkyo products purchased directly from Onkyo or an Onkyo Authorized Dealer, which are defective in material and/or workmanship.

EXCLUSIONS:

This Warranty does not apply with respect to the following:

1. Defects or damage caused by accident, fire, flood, lightning or other acts of nature.
2. Defects or damage caused by abuse, misuse, negligence or failure to observe the instructions contained in the manual furnished at the time of original purchase.
3. Damage caused during shipment or handling.
4. Products purchased from anyone other than Onkyo or an Onkyo Authorized Dealer. If you are uncertain as to whether a dealer is authorized, please contact Onkyo's Customer Service Department or check the Dealer and Service Locator at our web site: <http://www.Onkyousa.com>
5. Products that have had their serial numbers altered or removed.
6. Products purchased in 'AS IS' condition.
7. Products that have been altered or repaired by anyone other than Onkyo or an Onkyo authorized service center in a manner that has affected their performance, stability or reliability.
8. Accessories attached to or to be used with Onkyo products, such as antennas, cables, etc.
9. Packing materials, batteries, antennas & cosmetic items.
10. Parts which have prescribed useful lives dependent upon the degree of their use, such as stylus, cassette heads, idler wheels, etc.
11. Installation & removal of Onkyo products.
12. Maintenance, cleaning or periodic check-ups.
13. Adjustments or alteration required for compatibility with conditions pertaining to foreign countries.
14. Products used continuously or for commercial applications. Onkyo products are intended for consumers' use and are not designed for continuous or commercial use. In the event that the products concerned have been used commercially or continuously, the warranty period is limited to 90 days from the date of purchase.

We offer Product Support/Customer Service 7 days per week

In order to better assist you with your purchase, Onkyo has extended its customer service hours to a seven-day schedule. For questions, assistance, or comments Please call or e-mail us at :

Phone: 1-800-229-1687

E-mail: Onkyo@onkyousa.com

For information concerning product features and hookups, please include your name and daytime phone number along with the model number you are inquiring about for a response from a product specialist.

Hours of Operation:

Mon – Fri 9:00am – 8pm (Eastern Standard Time)

Sat – Sun 10:00am – 4pm (Eastern Standard Time)

OBTAINING WARRANTY SERVICE:

To obtain warranty service, take or ship your Onkyo product to an Onkyo authorized service center, together with a note describing your complaint and your copy of the dated purchase receipt. If you choose to ship your Onkyo product to an Onkyo authorized service center, all shipping arrangement must be made by you and all shipping charges and insurance must be fully prepaid. Any Onkyo product shipped in its entirety must be shipped in its original carton. Onkyo will pay all return shipping charges for Onkyo products that have been serviced under this warranty.

LIMITATIONS:

Onkyo makes this warranty subject to the following limitations:

1. This Warranty is valid only within the territory of the United States of America. To be covered by this warranty the Onkyo product concerned must have been originally purchased and the person seeking warranty service must reside in one of the states of the United States of America or in the District of Columbia.
2. ONKYO SHALL HAVE NO LIABILITY WHATSOEVER FOR INCIDENTAL OR CONSEQUENTIAL DAMAGES. THE RESPONSIBILITY OF ONKYO UNDER THIS WARRANTY SHALL BE LIMITED TO THE REPAIR OF DEFECTIVE ONKYO PRODUCTS BY ONKYO OR ITS AUTHORIZED SERVICE CENTERS.
3. This warranty is valid only with respect to repairs effected by Onkyo or an Onkyo authorized service center.
4. ALL WARRANTIES OTHER THAN THE EXPRESS WARRANTY HEREIN CONTAINED INCLUDING BUT NOT LIMITED TO ANY IMPLIED WARRANTY OF MERCHANTABILITY OR FITNESS FOR A PARTICULAR PURPOSE ARE LIMITED IN DURATION TO THE APPLICABLE WARRANTY PERIOD SET FORTH ABOVE.

Some states do not allow limitations on how long an implied warranty lasts and some states do not allow the exclusion or limitation of incidental or consequential damages, so the above limitations or exclusion may not apply to you. This warranty gives you specific legal rights and you may also have other rights that vary from state to state.

Model _____

Serial No. _____

Customer's Name _____

Dealer's Name _____

Date of Purchase _____

ONKYO USA CORPORATION

18 Park Way
Upper Saddle River, NJ 07458 USA

Phone: 201-785-2600

Fax : 201-785-2650

<http://www.onkyousa.com>

SN. 29365090C

Free Manuals Download Website

<http://myh66.com>

<http://usermanuals.us>

<http://www.somanuals.com>

<http://www.4manuals.cc>

<http://www.manual-lib.com>

<http://www.404manual.com>

<http://www.luxmanual.com>

<http://aubethermostatmanual.com>

Golf course search by state

<http://golfingnear.com>

Email search by domain

<http://emailbydomain.com>

Auto manuals search

<http://auto.somanuals.com>

TV manuals search

<http://tv.somanuals.com>