

ONKYO®

Contents

Before Using Your DVD Changer Receiver

Getting Started

Setup

Basic Operation

Advanced Operation

Other

DVD Changer Receiver

DR-C500

Instruction Manual

Thank you for purchasing the Onkyo DVD Changer Receiver. Please read this manual thoroughly before making connections and plugging in the unit. Following the instructions in this manual will enable you to obtain optimum performance and listening enjoyment from your new DVD Changer Receiver. Please retain this manual for future reference.



WARNING:

TO REDUCE THE RISK OF FIRE OR ELECTRIC SHOCK, DO NOT EXPOSE THIS APPLIANCE TO RAIN OR MOISTURE.

CAUTION:

TO REDUCE THE RISK OF ELECTRIC SHOCK, DO NOT REMOVE COVER (OR BACK). NO USER-SERVICEABLE PARTS INSIDE. REFER SERVICING TO QUALIFIED SERVICE PERSONNEL.



WARNING
RISK OF ELECTRIC SHOCK
DO NOT OPEN

AVIS
RISQUE DE CHOC ELECTRIQUE
NE PAS OUVRIR



The lightning flash with arrowhead symbol, within an equilateral triangle, is intended to alert the user to the presence of uninsulated "dangerous voltage" within the product's enclosure that may be of sufficient magnitude to constitute a risk of electric shock to persons.



The exclamation point within an equilateral triangle is intended to alert the user to the presence of important operating and maintenance (servicing) instructions in the literature accompanying the appliance.

Important Safeguards

1. **Read Instructions** – All the safety and operating instructions should be read before the appliance is operated.
2. **Retain Instructions** – The safety and operating instructions should be retained for future reference.
3. **Heed Warnings** – All warnings on the appliance and in the operating instructions should be adhered to.
4. **Follow Instructions** – All operating and use instructions should be followed.
5. **Cleaning** – Unplug the appliance from the wall outlet before cleaning. The appliance should be cleaned only as recommended by the manufacturer.
6. **Attachments** – Do not use attachments not recommended by the appliance manufacturer as they may cause hazards.
7. **Water and Moisture** – Do not use the appliance near water – for example, near a bath tub, wash bowl, kitchen sink, or laundry tub; in a wet basement; or near a swimming pool; and the like.
8. **Accessories** – Do not place the appliance on an unstable cart, stand, tripod, bracket, or table. The appliance may fall, causing serious injury to a child or adult, and serious damage to the appliance. Use only with a cart, stand, tripod, bracket, or table recommended by the manufacturer, or sold with the appliance. Any mounting of the appliance should follow the manufacturer's instructions, and should use a mounting accessory recommended by the manufacturer.
9. An appliance and cart combination should be moved with care. Quick stops, excessive force, and uneven surfaces may cause the appliance and cart combination to overturn.
10. **Ventilation** – Slots and openings in the cabinet are provided for ventilation and to ensure reliable operation of the appliance and to protect it from overheating, and these openings must not be blocked or covered. The openings should never be blocked by placing the appliance on a bed, sofa, rug, or other similar surface. The appliance should not be placed in a built-in installation such as a bookcase or rack unless proper ventilation is provided. There should be free space of at least 20 cm (8 in.) and an opening behind the appliance.
11. **Power Sources** – The appliance should be operated only from the type of power source indicated on the marking label. If you are not sure of the type of power supply to your home, consult your appliance dealer or local power company.
12. **Grounding or Polarization** – The appliance may be equipped with a polarized alternating current line plug (a plug having one blade wider than the other). This plug will fit into the power outlet only one way. This is a safety feature. If you are unable to insert the plug fully into the outlet, try reversing the plug. If the plug should still fail to fit, contact your electrician to replace your outlet. Do not defeat the safety purpose of the polarized plug.
13. **Power-Cord Protection** – Power-supply cords should be routed so that they are not likely to be walked on or pinched by items placed upon or against them, paying particular attention to cords at plugs, convenience receptacles, and the point where they exit from the appliance.
14. **Outdoor Antenna Grounding** – If an outside antenna or cable system is connected to the appliance, be sure the antenna or cable system is grounded so as to provide some protection against voltage surges and built-up static charges. Article 810 of the National Electrical Code, ANSI/NFPA 70, provides information with regard to proper grounding of the mast and supporting structure, grounding of the lead-in wire to an antenna-discharge unit, size of grounding conductors, location of antenna-discharge unit, connection to grounding electrodes, and requirements for the grounding electrode. See FIGURE 1.
15. **Lightning** – For added protection for the appliance during a lightning storm, or when it is left unattended and unused for long periods of time, unplug it from the wall outlet and disconnect the antenna or cable system. This will prevent damage to the appliance due to lightning and power-line surges.
16. **Power Lines** – An outside antenna system should not be located in the vicinity of overhead power lines or other electric light or power circuits, or where it can fall into such power lines or circuits. When installing an outside antenna system, extreme care should be taken to keep from touching such power lines or circuits as contact with them might be fatal.
17. **Overloading** – Do not overload wall outlets, extension cords, or integral convenience receptacles as this can result in a risk of fire or electric shock.
18. **Object and Liquid Entry** – Never push objects of any kind into the appliance through openings as they may touch dangerous voltage points or short-out parts that could result in a fire or electric shock. Never spill liquid of any kind on the appliance.
19. **Servicing** – Do not attempt to service the appliance yourself as opening or removing covers may expose you to dangerous voltage or other hazards. Refer all servicing to qualified service personnel.
20. **Damage Requiring Service** – Unplug the appliance from the wall outlet and refer servicing to qualified service personnel under the following conditions:
 - A. When the power-supply cord or plug is damaged,
 - B. If liquid has been spilled, or objects have fallen into the appliance,
 - C. If the appliance has been exposed to rain or water,
 - D. If the appliance does not operate normally by following the operating instructions. Adjust only those controls that are covered by the operating instructions as an improper adjustment of other controls may result in damage and will often require extensive work by a qualified technician to restore the appliance to its normal operation,
 - E. If the appliance has been dropped or damaged in any way, and
 - F. When the appliance exhibits a distinct change in performance – this indicates a need for service.

PORTABLE CART WARNING



S3125A

21. **Replacement Parts** – When replacement parts are required, be sure the service technician has used replacement parts specified by the manufacturer or have the same characteristics as the original part. Unauthorized substitutions may result in fire, electric shock, or other hazards.
22. **Safety Check** – Upon completion of any service or repairs to the appliance, ask the service technician to perform safety checks to determine that the appliance is in proper operation condition.
23. **Wall or Ceiling Mounting** – The appliance should be mounted to a wall or ceiling only as recommended by the manufacturer.
24. **Heat** – The appliance should be situated away from heat sources such as radiators, heat registers, stoves, or other appliances (including amplifiers) that produce heat.
25. **Liquid Hazards** – The appliance should not be exposed to dripping or splashing and no objects filled with liquids, such as vases should be placed on the appliance.

FIGURE 1:
EXAMPLE OF ANTENNA GROUNDING AS PER NATIONAL ELECTRICAL CODE, ANSI/NFPA 70

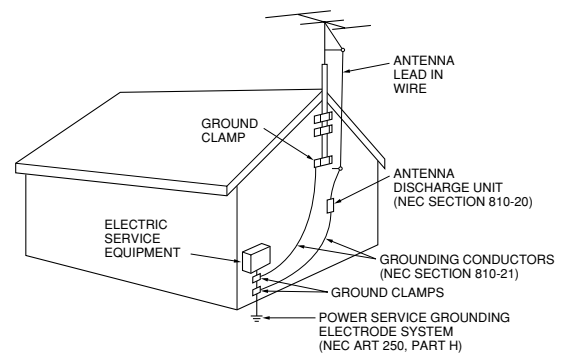

NEC – NATIONAL ELECTRICAL CODE

S2898A

Precautions

The laser is covered by a housing which prevents exposure during operation or maintenance. However, this product is classified as a Laser Product by CDRH (Center for Devices and Radiological Health) which is a department of the Food and Drug Administration. According to their regulations 21 CFR section 1002.30, all manufacturers who sell Laser Products must maintain records of written communications between the manufacturer, dealers and customers concerning radiation safety. If you have any complaints about instructions or explanations affecting the use of this product, please feel free to write to the address on the back page of this manual. When you write us, please include the model number and serial number of your unit.

In compliance with Federal Regulations, the certification, identification and the period of manufacture are indicated on the rear panel.

FCC INFORMATION FOR USER

CAUTION:

The user changes or modifications not expressly approved by the party responsible for compliance could void the user's authority to operate the equipment.

NOTE:

This equipment has been tested and found to comply with the limits for a Class B digital device, pursuant to Part 15 of the FCC Rules. These limits are designed to provide reasonable protection against harmful interference in a residential installation. This equipment generates, uses and can radiate radio frequency energy and, if not installed and used in accordance with the instructions, may cause harmful interference to radio communications. However, there is no guarantee that interference will not occur in a particular installation. If this equipment does cause harmful interference to radio or television reception, which can be determined by turning the equipment off and on, the user is encouraged to try to correct the interference by one or more of the following measures:

- Reorient or relocate the receiving antenna.
- Increase the separation between the equipment and receiver.
- Connect the equipment into an outlet on a circuit different from that to which the receiver is connected.
- Consult the dealer or an experienced radio/TV technician for help.

Note to CATV system installer:

This reminder is provided to call the CATV system installer's attention to Section 820-40 of the NEC which provides guidelines for proper grounding and, in particular, specifies that the cable ground shall be connected to the grounding system of the building, as close to the point of cable entry as practical.

For Canadian model

THIS CLASS B DIGITAL APPARATUS COMPLIES WITH CANADIAN ICES-003.

For models having a power cord with a polarized plug:

CAUTION: TO PREVENT ELECTRIC SHOCK, MATCH WIDE BLADE OF PLUG TO WIDE SLOT, FULLY INSERT.

Modèle pour les Canadien

CET APPAREIL NUMÉRIQUE DE LA CLASSE B EST CONFORME À LA NORME NMB-003 DU CANADA.

Sur les modèles dont la fiche est polarisée:

ATTENTION: POUR ÉVITER LES CHOCS ÉLECTRIQUES, INTRODUIRE LA LAME LA PLUS LARGE DE LA FICHE DANS LA BORNE CORRESPONDANTE DE LA PRISE ET POUSSER JUSQU'AU FOND.

Precautions

This unit contains a semiconductor laser system and is classified as a "CLASS 1 LASER PRODUCT". So, to use this model properly, read this Instruction Manual carefully. In case of any trouble, please contact the store where you purchased the unit. To prevent being exposed to the laser beam, do not try to open the enclosure.

DANGER:

VISIBLE AND INVISIBLE LASER RADIATION WHEN OPEN AND INTERLOCK FAILED OR DEFEATED. DO NOT STARE INTO BEAM.

CAUTION:

THIS PRODUCT UTILIZES A LASER. USE OF CONTROLS OR ADJUSTMENTS OR PERFORMANCE OF PROCEDURES OTHER THAN THOSE SPECIFIED HEREIN MAY RESULT IN HAZARDOUS RADIATION EXPOSURE.



1. This unit is a CLASS 1 LASER PRODUCT and employs a laser inside the cabinet.
2. To prevent the laser from being exposed, do not remove the cover. Refer servicing to qualified personnel.

1. Regional Restriction Codes (Region Number)

Regional restriction codes are built into DVD Changer Receivers and DVD-video media for each sales region. If the regional code of the DVD Changer Receiver does not match one of the regional codes on the DVD-video media, playback is not possible.

The regional number can be found on the rear panel of the DVD Changer Receiver. (e.g.  for Region 1)

2. About This Manual

This manual explains the basic procedures for operating the DVD Changer Receiver. Some DVD-video discs do not support the full potential of the DVD technology. Your DVD Changer Receiver may therefore not respond to all operating commands. Refer to instruction notes on discs. A "⊙" mark may appear on the TV screen during operation. It means that the operation is not permitted by the DVD Changer Receiver or the disc.

3. Recording Copyright

Recording of copyrighted material for other than personal use is illegal without permission of the copyright holder.

4. AC Fuse

The fuse is located inside the chassis and is not user-serviceable. If power does not come on, contact your Onkyo authorized service center.

5. Power

WARNING

BEFORE PLUGGING IN THE UNIT FOR THE FIRST TIME, READ THE FOLLOWING SECTION CAREFULLY.

The voltage of the available power supply differs according to country or region. Be sure that the power supply voltage of the area where the unit will be used meets the required voltage (e.g., AC 120V 60Hz) written on the rear panel.

6. Do not touch the unit with wet hands

Do not handle the unit or power cord when your hands are wet or damp. If water or any other liquid enters the case, take the unit to an authorized service center for inspection.

7. Location of the unit

- Place the unit in a well-ventilated location. Take special care to provide plenty of ventilation on all sides of the unit especially when it is placed in an audio rack. If ventilation is blocked, the unit may overheat and malfunction.
- Do not expose the unit to direct sunlight or heating units as the unit's internal temperature may rise and shorten the life of the pickup.
- Avoid damp and dusty places and places directly affected by vibrations from the speakers. In particular, avoid placing the unit on or above one of the speakers.
- Be sure the unit is placed in a horizontal position. Never place it on its side or on a slanted surface as it may malfunction.
- When you place the unit near a TV, radio, or VCR, the playback picture may become poor and the sound may be distorted. In this case, place the unit away from the TV, radio, or VCR.

8. Care

From time to time you should wipe the front and rear panels and the cabinet with a soft cloth. For heavier dirt, dampen a soft cloth in a weak solution of mild detergent and water, wring it out dry, and wipe off the dirt. Following this, dry immediately with a clean cloth.

Do not use rough material, thinners, alcohol or other chemical solvents or cloths since these could damage the finish or remove the panel lettering.

9. Notes on Handling

- When shipping the unit, use the original shipping carton and packing materials. For maximum protection, repack the unit as it was originally packed at the factory.
- Do not use volatile liquids, such as insect spray, near the unit. Do not leave rubber or plastic products in contact with the unit for a long time. They will leave marks on the finish.
- The top and rear panels of the unit **may become warm after a long period of use. This is not a malfunction.**
- When the unit is not in use, be sure to remove the disc and turn off the power.
- If you do not use the unit for a long period, the unit may not function properly in the future. Turn on and use the unit occasionally.

10. To Obtain a Clear Picture

The unit is a high technology, precision device. If the optical pick-up lens and disc drive parts are dirty or worn down, the picture quality becomes poor. To obtain a clear picture, we recommend regular inspection and maintenance (cleaning or parts replacement) every 1,000 hours of use depending on the operating environment. For details, contact your nearest dealer.

11. Notes on Moisture Condensation

Moisture condensation damages the unit. Please read the following carefully.

- **What is moisture condensation?**
Moisture condensation occurs, for example, when you pour a cold drink into a glass on a warm day. Drops of water form on the outside of the glass. In the same way, moisture may condense on the optical pick-up lens inside the unit, one of the most crucial internal parts of the unit.
- **Moisture condensation occurs in the following cases.**
 - When you bring the unit directly from a cold place to a warm place.
 - When you use the unit in a room where you just turned on the heater, or a place where the cold wind from the air conditioner directly hits the unit.
 - In summer, when you use the unit in a hot and humid place just after you move the unit from an air conditioned room.
 - When you use the unit in a humid place.
- **Do not use the unit when moisture condensation may occur.**
If you use the unit in such a situation, it may damage discs and internal parts. Remove the disc, connect the power cord of the unit to the wall outlet, turn on the unit, and leave it for two or three hours. After a few hours, the unit will have warmed up and evaporated any moisture. Keep the unit connected to the wall outlet and moisture condensation will seldom occur.

Table of Contents

Important Safeguards/Precautions/Table of Contents	2-5
--	-----

Getting Started

Features	6
Supplied Accessories	7
Notes on Discs	8
Index to Parts and Controls	10
Connecting to a TV	15
Connecting Speakers	16
Positioning Speakers	17
Connecting to Audio/Video Equipment	18
Making Antenna Connections	20
Preparing the Remote Controller	22

Setup

Connecting the Power/Turning on the DVD Changer Receiver	23
Speaker Setup	24

Basic Operation

Enjoying the Sound Effects	27
Various Functions Common to all the Sources	31
Basic Playback	33

Advanced Operation

Still Frame/Slow Play	36
Repeat Play	37
Random Play	38
Playing in a Favorite Order	39
Viewing Disc Information	40
Selecting the Audio/Subtitle Language	42
Using the Banner Display	43
MP3 Function	45
Customizing the Settings	47
Listening to the Radio	52
Playing the Connected Source	54
Recording Using the Connected Equipment	55
Controlling other components connected to the DVD Changer Receiver	56

Other

Troubleshooting	63
Specifications	66

Features

■ Receiver Features

- 500 watts into 8 ohms (FTC)
- DTS*, Dolby** & Dolby II Digital Decoders
- Acoustic Control
- 2 Digital Inputs/1 Output
- Subwoofer Preout
- 4 Audio Inputs/2 Outputs
- 2 S-Video Inputs/2 Outputs
- 30 FM/AM Random Presets
- IPM (Intelligent Power Management)
- Surround modes
- Component-video Output for all Video Input systems

■ DVD/CD Changer Features

- 5 DISC Carousel Changer
- DTS, Dolby Digital, and PCM Compatible
- Component-Video Output
- Progressive Scan
- 27 MHz/10-Bit Video DAC
- Plays DVDs, MP3 CDs, CD-Rs, CD-RWs, Video CDs and Audio CDs
- High-Resolution On-screen Display for DVDs
- Program Memory Playback
- 5 Disc Random Playback for CDs
- Auto Last Play
- Dual-Wavelength Optical Pickup

■ Other Features

- Preprogrammed Learning Remote Control

* Manufactured under license from Digital Theater Systems, Inc. US Pat. No.5,451,942 and other worldwide patents issues and pending, "DTS" and "DTS Digital Surround" are trademarks of Digital Theater Systems, Inc. ©1996 Digital Theater Systems, Inc. All Rights reserved.

** Manufactured under license from Dolby Laboratories. "Dolby", "Dolby II", "Pro Logic" and the double-D symbol are trademarks of Dolby Laboratories.

Memory Preservation

This unit does not require memory preservation batteries. A built-in memory power backup system preserves the contents of memory during power failures and even when the power cord is unplugged. The power cord must be plugged in order to charge the backups system. The memory preservation period after the unit has been turned off varies depending on climate and placement of the unit. On average, memory contents are protected over a period of a few weeks after the time the unit has been turned off. This period is shorter when the unit is exposed to a very humid climate.

Supplied Accessories

Make sure your box contains everything listed below.
If any pieces are missing, contact your nearest Onkyo service station.
The number of accessories is indicated in brackets [].

Remote controller (RC-504M) [1]

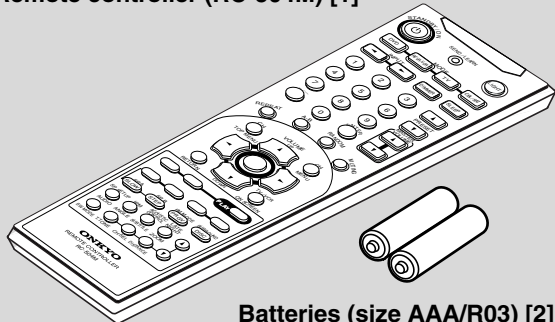

Batteries (size AAA/R03) [2]

RCA 3-pin Audio/Video connection cable [1]

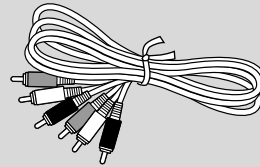

FM antenna [1]

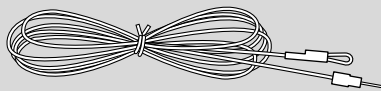

AM loop antenna [1]

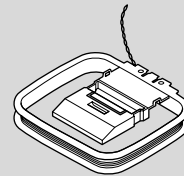

Speaker Label [1]

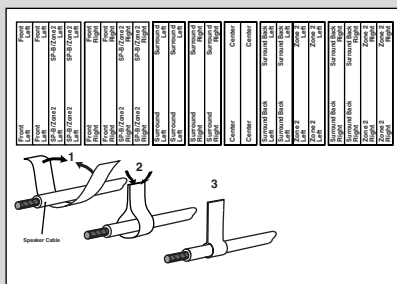



Notes on Discs

This section shows you how to handle, clean, and store discs.

Playable Discs

This DVD Changer Receiver can playback the following discs.

	Disc mark	Contents	Disc size
DVD-Video		Audio + Video (moving pictures)	12 cm
			8 cm
Video CD		Audio + Video (moving pictures)	12 cm
			8 cm
CD CD-R* CD-RW*		Audio	12 cm
			8 cm (CD single)

* The DVD Changer Receiver can play CD-R/RW discs recorded in CD-DA format, or with MP3 audio files. Some CD-R/RW discs may not be able to be played back.

- You cannot play discs such as DVD-Audio, DVD-RAM etc., even if the marks in the above table are labeled on those discs.
- This DVD Changer Receiver uses the NTSC color system, and cannot playback video media recorded in any other color system (SECAM, etc.).
- Avoid using heart-shaped or octagonal discs. Playing irregularly shaped discs may damage the internal mechanism of the DVD Changer Receiver.

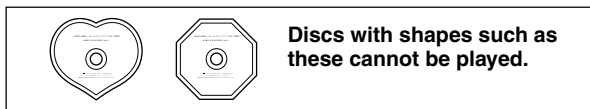

- Do not use discs that have residue from adhesive tape, rental discs that have peeling labels, or discs that have custom labels or stickers. Otherwise, you may not be able to eject the discs or the DVD Changer Receiver may become inoperative.
- Use CD-R or CD-RW media for recording your CD audio files or MP3 files. The disc must be finalized in order to play.

The Structure of the Disc Content

DVD-Video

Normally, the contents of DVD-Video are divided into titles, and the titles are subdivided into chapters.

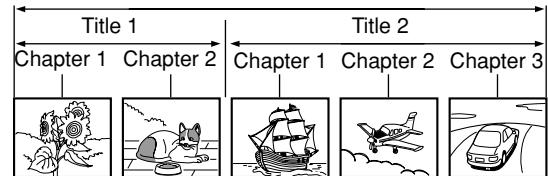

Video CD/CD

Video CD and CD are divided into tracks.



About Video CDs

This DVD Changer Receiver supports Video CDs equipped with the PBC (Version 2.0) function. (PBC is the abbreviation of Playback Control.) You can enjoy two playback variations depending on the type of disc.

- Video CD not equipped with PBC function (Version 1.1)**
Sound and movies can be played on this DVD Changer in the same way as a CD.
- Video CD equipped with PBC function (Version 2.0)**
In addition to operation of the Video CD not equipped with the PBC function, you can enjoy playback with interactive software and search function using the menu displayed on the TV screen (Menu Playback). Some of the functions described in this Instruction Manual may not work with some discs.

MP3 Compatibility Information

- This system is not compatible with multi-session discs. If you try a multi-session disc, only the first session will be played.**
- The CD-R or CD-RW must be ISO 9660 level 1 compatible.
- Files should be MPEG1 Audio Layer 3 format, 32 kHz, 44.1 kHz (recommended) or 48 kHz, 32 kbps - 320 kbps (128 kbps recommended). Incompatible files will not play.
- This system only plays tracks that are named with the file extension ".mp3" or ".MP3".

Handling Discs

- Do not touch the playback side of the disc.

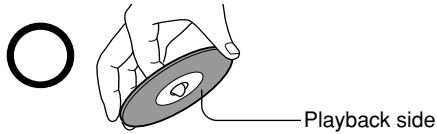

- Do not attach paper or tape to discs.



Cleaning Discs

- Fingerprints and dust on the disc cause picture and sound deterioration. Wipe the disc from the center outwards with a soft cloth. Always keep the disc clean.

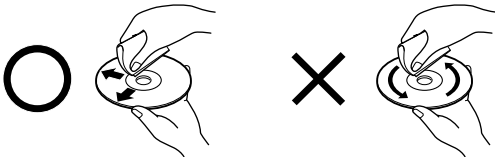

- If you cannot wipe off the dust with a soft cloth, wipe the disc lightly with a slightly moistened soft cloth and finish with a dry cloth.
- Do not use any type of solvent such as thinner, benzene, commercially available cleaners or antistatic spray for vinyl LPs. It may damage the disc.

Storing Discs

- Do not store discs in a place subject to direct sunlight or near heat sources.
- Do not store discs in places subject to moisture and dust such as a bathroom or near a humidifier.
- Store discs vertically in a case. Stacking or placing objects on discs outside of their case may cause warping.

Notes on Copyright

It is forbidden by law to copy, broadcast, show, broadcast on cable, play in public, and rent copyrighted material without permission.

The video recorded on DVD-Video is copy protected, and any recordings made from these discs will be distorted.

This product incorporates copyright protection technology that is protected by method claims of certain U.S. patents and other intellectual property rights owned by Macrovision Corporation and other rights owners. Use of this copyright protection technology must be authorized by Macrovision Corporation, and is intended for home and other limited viewing uses only unless otherwise authorized by Macrovision Corporation. Reverse engineering or disassembly is prohibited.

Index to Parts and Controls

For operational instructions, refer to the page indicated in brackets.

■ Front panel

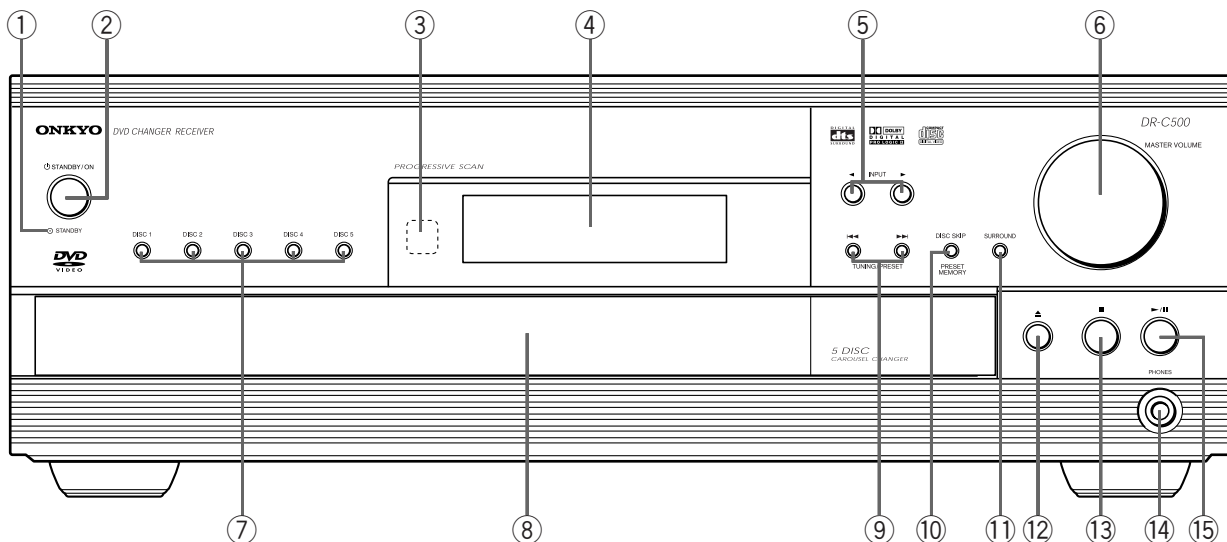

- ① **STANDBY indicator [23]**
- ② **STANDBY/ON button [23]**

When **STANDBY/ON** is pressed to ON, the DVD Changer Receiver turns on. The STANDBY indicator turns off and the display lights up. Pressing the button again returns the DVD Changer Receiver to the standby state. This state turns off the display and disables control functions.
- ③ **Remote control sensor [22]**

Point the remote controller toward the remote control sensor to operate the DVD Changer Receiver.
- ④ **Display [11]**
- ⑤ **INPUT ◀/▶ buttons [52-54]**

Press to select the input source.
- ⑥ **MASTER VOLUME dial [31]**

The MASTER VOLUME dial is used to control the volume level.
- ⑦ **DISC 1, DISC 2, DISC 3, DISC 4, DISC 5 buttons [34]**

Press to select a disc in the changer.
- ⑧ **Disc tray [33]**

When loading a disc, place it on the disc tray with its label facing up.
- ⑨ **TUNING/PRESET ◀◀/▶▶ buttons [35, 52, 53]**

When listening to the radio, press to change the tuner frequency or select preset stations.
When playing discs, press to skip back or forward to consecutive chapters/tracks.
- ⑩ **PRESET MEMORY/DISC SKIP button [34, 52, 53]**

When listening to the radio, press to assign the radio station that is currently tuned in to a preset channel or delete a previously preset station.
When playing discs, press to select a disc. When the DISC SKIP button is pressed while the Disc tray is open, the tray simply rotates.
- ⑪ **SURROUND button [28]**

Press to select a surround mode.
- ⑫ **▲ button [33]**

Press to open and close the disc tray.
- ⑬ **■ button [34]**

Press to stop playback. Pressing once enables playback to resume from a point shortly before the location where it was stopped. Pressing twice causes the disc to return to the beginning of the disc when playback starts again.
- ⑭ **PHONES jack [31]**

This is a standard stereo jack for connecting stereo headphones.
- ⑮ **►/II button [33, 34]**

Press to start or pause playback.

■ Display

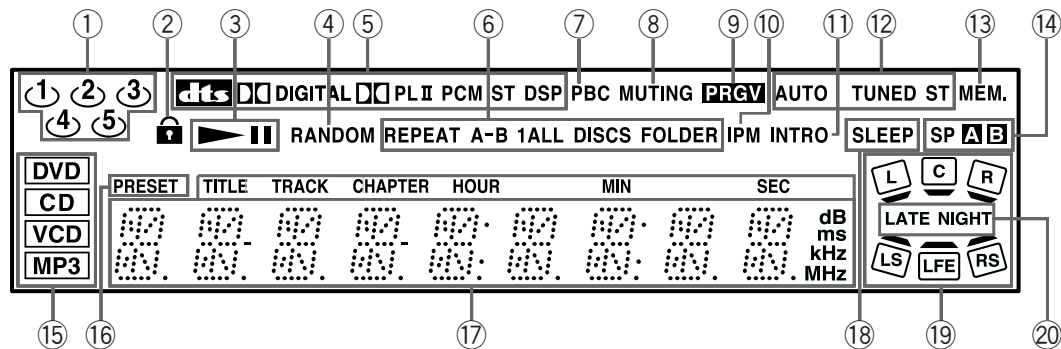

- ① **Disc number indicators [33]**
Indicate the presence of a disc.
- ② **Parental Lock indicator [50]**
Illuminates in parental lock mode.
- ③ **▶, || indicators [33]**
Illuminate in play or pause mode.
- ④ **RANDOM indicator [38]**
Illuminates during random playback.
- ⑤ **Source/Listening mode indicators [28]**
One of the source indicators lights to show the format of the current source. In addition, one of the listening mode indicators lights according to the current listening mode.
- ⑥ **REPEAT indicators [37, 46]**
Illuminate during repeat playback. REPEAT indicator also illuminates during A-B repeat playback.
- ⑦ **PBC indicator [37, 38]**
Illuminates when PBC is on for Video CD.
- ⑧ **MUTING indicator [31]**
Flashes when the mute function is active.
- ⑨ **PRGV indicator [34]**
Illuminates when the DVD Changer Receiver is set to progressive-scan video.
- ⑩ **IPM (Intelligent Power Management) indicator [19]**
Lights up when the IPM function is active.
- ⑪ **INTRO indicator [43]**
Lights up during intro-scan playback.
- ⑫ **AUTO, TUNED, ST indicators [52]**
Illuminate to indicate the reception mode.
- ⑬ **MEM. indicator [39, 46, 52]**
Illuminates when the MEM button is pressed in the radio station preset operation and during DVD memory play.
- ⑭ **Speaker indicators [24, 31]**
Illuminate to indicate the selected speakers.
- ⑮ **Inserted disc indicators [33]**
Illuminate to indicate the type of disc that is playing currently.
- ⑯ **PRESET indicator [52, 53]**
Illuminates when tuned to a preset station.
- ⑰ **Multipurpose display**
Indicates operating status, messages, etc.
- ⑱ **SLEEP indicator [32]**
Lights up when the sleep timer is active.
- ⑲ **Speaker setup indicators [24]**
Indicate the speaker configuration. Light to show speaker positions, input and output signals for each channel.
- ⑳ **LATE NIGHT indicator [30]**
Illuminates when the unit is in Late Night mode.

Index to Parts and Controls

■ Remote controller

Explanations on this page are for controlling the DVD Changer Receiver.

The supplied remote controller is a useful tool to help you operate of your home theater.

To operate other components, see "Controlling other components connected to the DVD Changer Receiver" on pages 56-62.

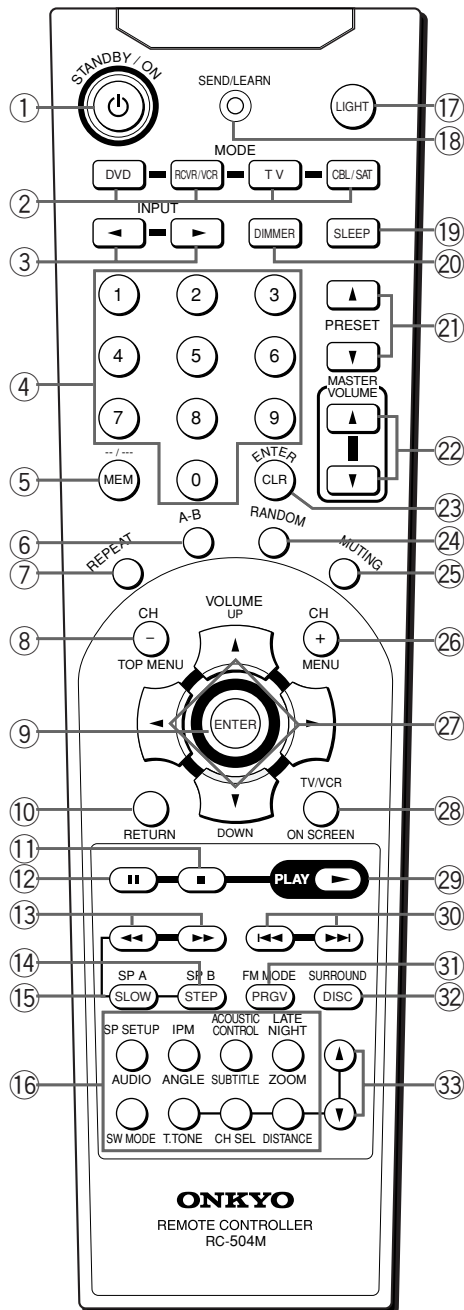

To control the DVD Changer Receiver, press one of the **MODE** buttons first. Functions of the buttons vary depending on the mode.

- ① **STANDBY/ON button [23, 59]**
Turns on the DVD Changer Receiver or puts the DVD Changer Receiver in Standby mode.
- ② **MODE buttons [22, 56, 58-62]**
For selecting the component to be operated by the remote controller. Press one of these buttons first before controlling the DVD Changer Receiver.
- ③ **INPUT SELECTOR ◀▶ buttons [52-54]**
Press to select the input source.
- ④ **Number buttons (1-9, +10, 0) [33, 39, 41, 48, 50, 58, 59]**
Use to perform direct title/folder and chapter/track searches, and to input numerical values.
- ⑤ **MEM (---) [39, 46, 58, 59]**
For programming DVDs, CDs, Video CDs and MP3s. Also for learning a pre-programming code.
- ⑥ **A-B button [37]**
Press at the beginning and end of the section you want to repeat or to mark a location you want to return to.
- ⑦ **REPEAT button [37]**
Press repeatedly to select the repeat mode.
- ⑧ **TOP MENU (CH -) button [37, 38, 48, 59]**
Press to call up the top menu programmed on the DVD. Depending on the DVD, the top menu may be identical to the DVD menu. When controlling your TV, use to select the previous channel.
- ⑨ **ENTER button [33, 39-48, 50, 51, 60, 62]**
Press to enter settings.
- ⑩ **RETURN button [45, 47]**
Use to go one menu back (current settings are maintained). Use RETURN when you do not want to change the option setting in a menu.
- ⑪ **■ button [34, 58]**
Press to stop playback. Pressing once enables playback to resume from a point shortly before the location where it was stopped. Pressing twice causes the disc to return to the beginning of the disc when playback starts again.
- ⑫ **⏸ button [34, 58]**
Press to pause playback of a disc. Press again to resume playback.
- ⑬ **◀◀▶▶ buttons [35, 36]**
During playback of DVD and Video CD, press ▶▶ to perform fast forward scanning or ◀◀ to perform fast reverse scanning of DVD and Video CD. When a CD or MP3 is loaded, audio scanning is performed.
- ⑭ **STEP/SP B button [31, 36]**
In DVD mode, press STEP during playback to view still frames. Then press and hold ◀◀▶▶ to view step playback. Or press ◀◀▶▶ repeatedly to advance playback frame by frame. In RCVR/VCR mode, press to select "Speaker B".

- ⑮ **SLOW/SP A buttons [31, 36]**
In DVD mode, press **SLOW** during playback to view still frame. Then press and hold ◀▶ to view slow playback. In RCVR/VCR mode, press to select "Speaker A".
- ⑯ **Setup buttons**
- AUDIO/SP SETUP button [24, 42]**
In DVD mode, press repeatedly to select one of the audio languages and sound systems programmed on a DVD. In RCVR/VCR mode, press to select the optimum speaker configuration.
- ANGLE/IPM button [19, 43]**
Some DVDs are recorded with various camera angle playback options. In DVD mode, press **ANGLE** repeatedly to display different camera angles. In RCVR/VCR mode, press to activate the IPM (Intelligent Power Management) function.
- SUBTITLE/ACOUSTIC CONTROL button [30, 42]**
In DVD mode, press to turn the subtitles on or off. Press and hold to enter the subtitle selection menu and select a language. In RCVR/VCR mode, press to change the acoustic mode to boost the super bass/high frequency sounds.
- ZOOM/LATE NIGHT button [30]**
In DVD mode, press to zoom in on a section of a paused frame. In RCVR/VCR mode, press to change the late night setting.
- SW MODE button [24]**
Press to select the subwoofer mode.
- T. TONE button [26, 29]**
Outputs a test tone for setting speaker levels.
- CH SEL button [26, 29]**
Selects a speaker for changing the speaker output level.
- DISTANCE button [25]**
For setting the distances for each speaker.
- ⑰ **LIGHT button**
Press to illuminate the buttons. This button is useful when using the remote controller in dark locations.
- ⑱ **SEND/LEARN indicator [56, 60-62]**
Lights red when sending a signal.
- ⑲ **SLEEP button [32]**
Press to set the sleep timer.
- ⑳ **DIMMER button [32]**
Press to adjust the brightness of the front display.
- ㉑ **PRESET ▲/▼ buttons [53]**
Press to select a tuner preset channel.
- ㉒ **MASTER VOLUME ▲/▼ buttons [31]**
Press to adjust the volume.
- ㉓ **CLR (ENTER) button [38, 40, 42-44, 58, 59]**
Press to clear a selected item or display.
- ㉔ **RANDOM button [38]**
Press to play chapters/tracks in random order.
- ㉕ **MUTING button [31, 58, 59]**
Press to activate the mute function.
- ㉖ **MENU (CH +) button [42, 53]**
Press to display or close the DVD menu. When controlling your TV, use to select the next channel.
- ㉗ **Cursor ◀▶/▲/▼ (VOLUME UP▲/DOWN▼) buttons [33, 41-48, 50, 58, 59]**
Use to move through the options on menu screens. Also press to adjust the volume of other components.
- ㉘ **ON SCREEN (TV/VCR) [37, 40-44]**
In DVD mode, press to view menu during playback. When controlling your TV, use to select TV or VCR.
- ㉙ **PLAY ► button [33, 58]**
Press to start or resume playback.
- ㉚ **◀◀▶▶ buttons [35]**
When playing discs, press ◀◀ to go back to the beginning of the current chapter/track and ▶▶ to advance to the next chapter/track.
- ㉛ **PRGV/FM MODE button [34, 52]**
In DVD mode, press to select Progressive scan. In RCVR/VCR mode, press to select FM or FM Stereo.
- ㉜ **DISC/SURROUND button [28]**
In DVD mode, press repeatedly to select a disc. In RCVR/VCR mode, press repeatedly to select a surround mode.
- ㉝ **▲/▼ [25, 26]**
Use to adjust values.

Index to Parts and Controls

■Rear panel

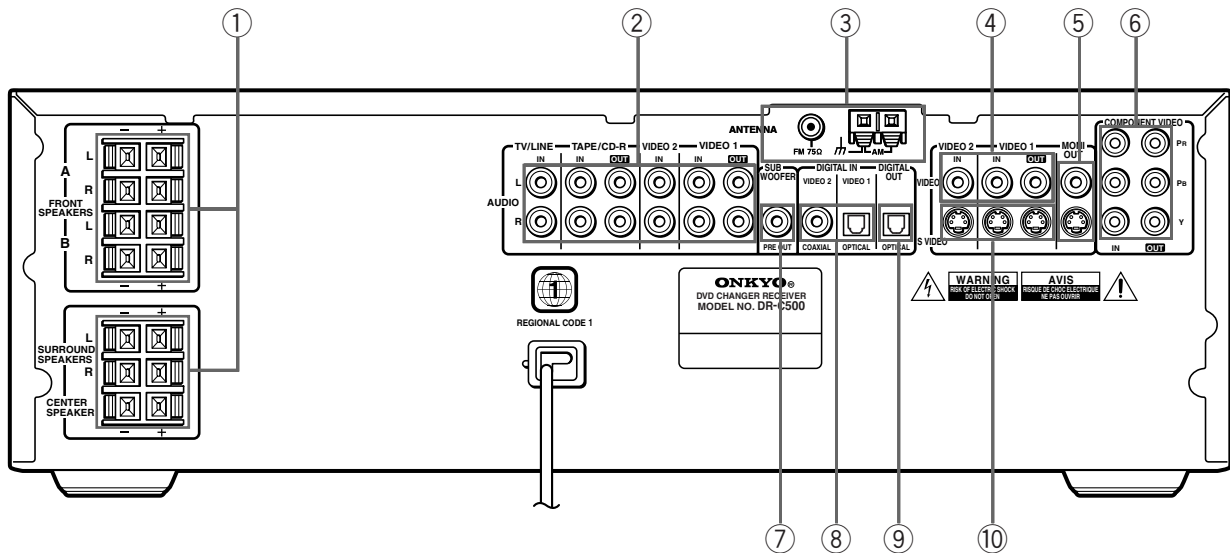

① **FRONT SPEAKERS A/B, SURROUND SPEAKERS and CENTER SPEAKER terminals [16]**

FRONT SPEAKERS A system: To enjoy home theater sound. Speaker terminals are provided for the front left, front right, center, surround left and surround right speakers.
FRONT SPEAKERS B system: To enjoy stereo sound. Speaker terminals are provided for the front left and front right.

② **AUDIO (TV/LINE IN / TAPE/CD-R IN/OUT / VIDEO 1 IN/OUT / VIDEO 2 IN) jacks [15, 18, 19]**

These are the analog audio inputs and outputs. There are 4 audio inputs and 2 audio outputs. The audio inputs and outputs require RCA type connectors. When connecting a VCR or other video component, make sure you connect the audio and video leads to the same set of jacks (i.e., both to VIDEO 1).

③ **ANTENNA terminals [20, 21]**

These terminals are for connecting the FM antenna and AM antenna.

④ **VIDEO (VIDEO 1 IN/OUT / VIDEO 2 IN) jacks [18]**

There are 2 video inputs and 1 output. Connect LD players, VCRs or other video components to the video inputs. The video output channel can be used to be connected to a video tape recorder for making recordings.

⑤ **MONI OUT jacks [15]**

The monitor output includes both RCA type and S video configurations. This output is for connecting a television monitor or projector.

⑥ **COMPONENT VIDEO IN/OUT jacks [15, 18]**

If your TV has component inputs, you can connect a component video cable to the component input of your TV and to the COMPONENT VIDEO OUT jack of your DVD Changer Receiver for ideal video quality.

If a DVD player or other device has component video out jacks, you can directly input a component signal to the COMPONENT VIDEO IN jack.

The component video cable only carries the video signal; remember to connect the left and right audio cables. If you connect a TV that is compatible with a Progressive scan signal, you can enjoy both Interlaced and Progressive scan.

⑦ **SUB WOOFER PRE OUT jack [16]**

This terminal is for connecting an active subwoofer.

⑧ **DIGITAL IN (VIDEO 1 OPTICAL, VIDEO 2 COAXIAL) jacks [18]**

These are the digital audio inputs. There is 1 digital input with an optical jack and 1 with a coaxial jack. The inputs accept digital audio signals from MD players, hard disk recorders, CD players, or other digital source component.

⑨ **DIGITAL OUT (OPTICAL) jack [18, 19]**

This jack is for connecting an MD recorder, CD recorder, hard disk recorder or other component with optical fiber cable.

⑩ **S VIDEO (VIDEO 1 IN/OUT / VIDEO 2 IN) jacks [18]**

There are 2 S Video inputs and 1 output. Connect LD players, VCRs or other video components to the video inputs. The S Video output channel can be used to be connected to video tape recorder for making recordings. The S-Video cable only carries the video signal. Remember to connect the left and right audio cables.

Connecting to a TV

Before connecting

- Refer also to the instruction manual of the TV.
- When you connect the DVD Changer Receiver to the TV, be sure to turn off the power and unplug both the units from the mains before making any connections.
- Connect the DVD Changer Receiver to the TV directly. If you connect the DVD Changer Receiver to a VCR, TV/VCR combination, or video selector, the playback picture may be distorted as DVD videos are copy protected.

- Connect the plugs securely.
- Note that one audio/video connection cable is supplied.

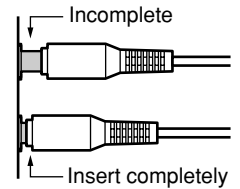

■ Connecting to a TV (or projector)

Using the supplied audio/video connection cable, make audio connections from the AUDIO TV/LINE IN L and R jacks to the corresponding audio output jacks on the TV. In the same manner, make video connections from the VIDEO MONI OUT jack to the corresponding video input jack on the TV. If your TV has a S video input jack and/or component video input jacks, make S video connection to the S VIDEO MONI OUT jack using S video connection cable (not supplied) and/or make component video connection to the COMPONENT VIDEO OUT jacks using component video connection cable (not supplied). These connections allow you to enjoy higher quality picture playback. Be sure not to disconnect VIDEO MONI OUT.

Notes

- Actual labels for component video inputs may vary depending on the TV manufacturer (ex. Y/Cb/Cr, Y/B-Y/R-Y, etc.).
- In some TVs, the color levels of the playback picture may be reduced slightly or the tint may change. In such a case, adjust the TV for optimum performance.

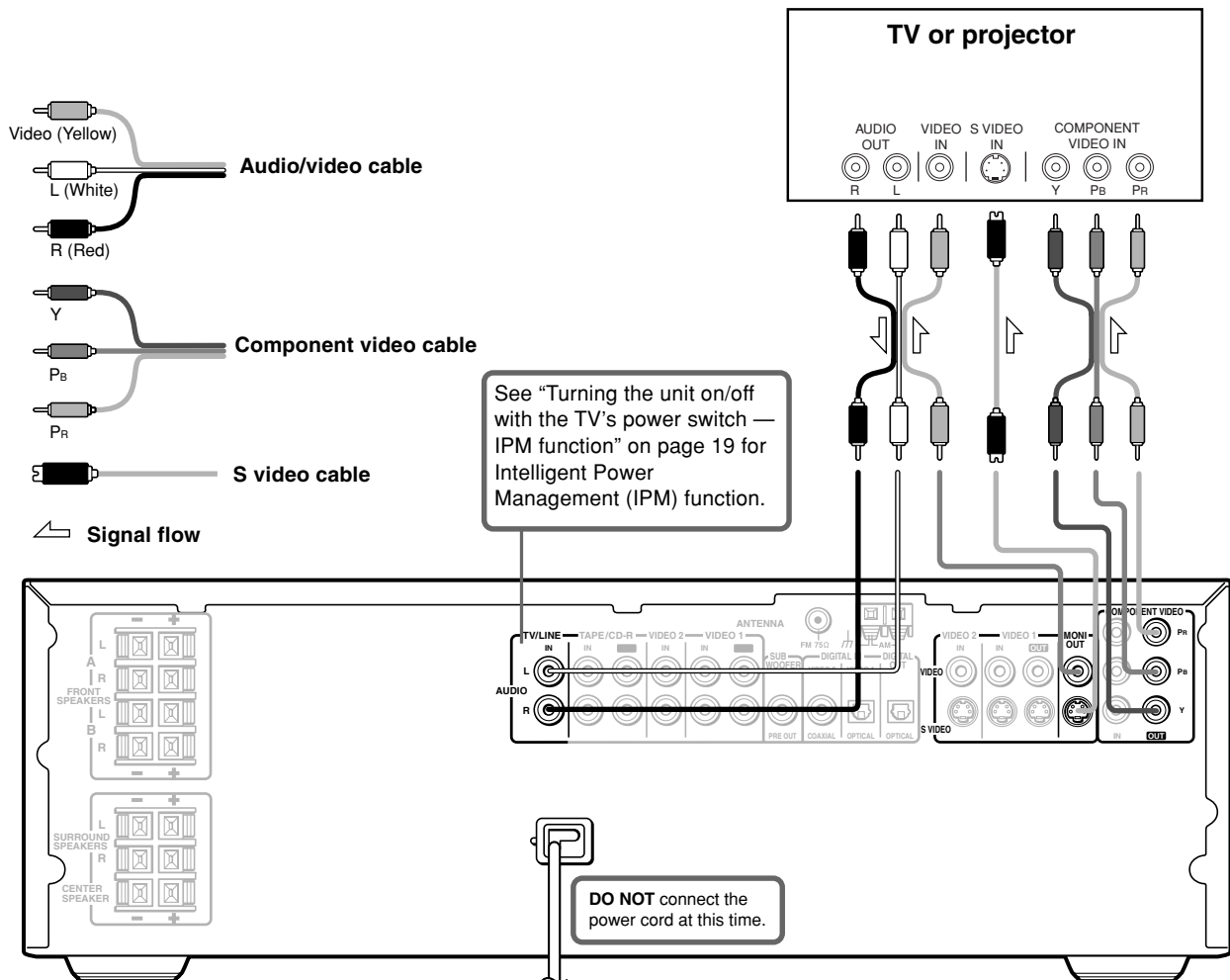

Connecting Speakers

Before connecting

- Refer also to the instruction manuals of the speakers.
- This DVD Changer Receiver is designed to reproduce optimum sound quality when speakers with the impedances specified below are connected. Please check the following information and choose speakers with appropriate impedances for the connections.

Front speakers: 6 ohms min. per speaker

Center speaker: 6 ohms min.

Surround Speakers : 6 ohms min. per speaker

- To prevent damage to circuits, never short-circuit the positive (+) and negative (-) speaker wires.
- Do not connect the speaker cable to the L and R connectors at the same time and do not connect more than one speaker to the same speaker connectors.

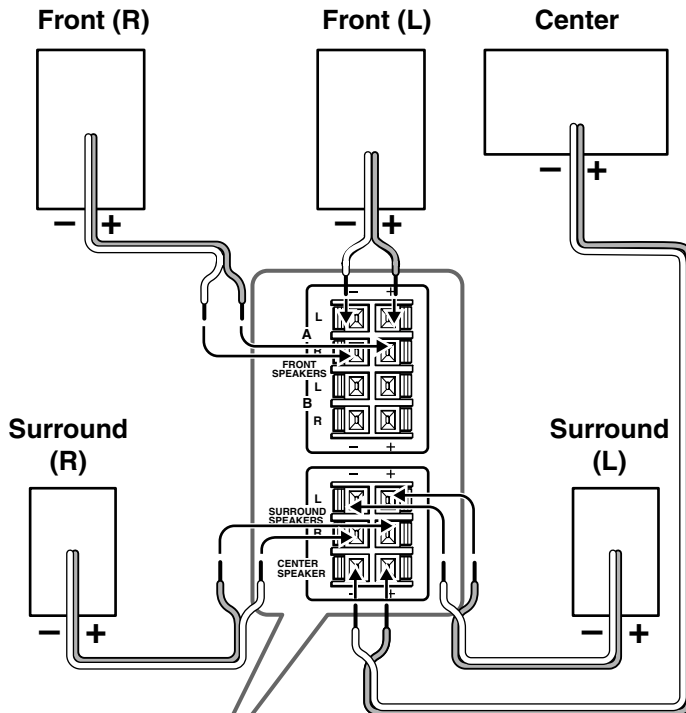
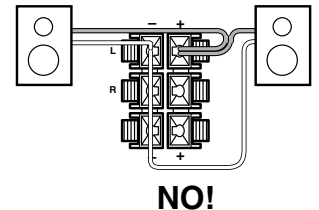
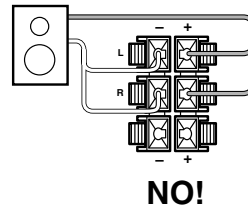
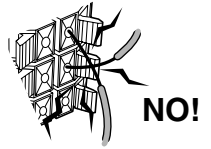

Connecting to SPEAKERS A

The main speaker system is SPEAKERS A. Follow the illustration on the left.

How to connect to the speaker connectors

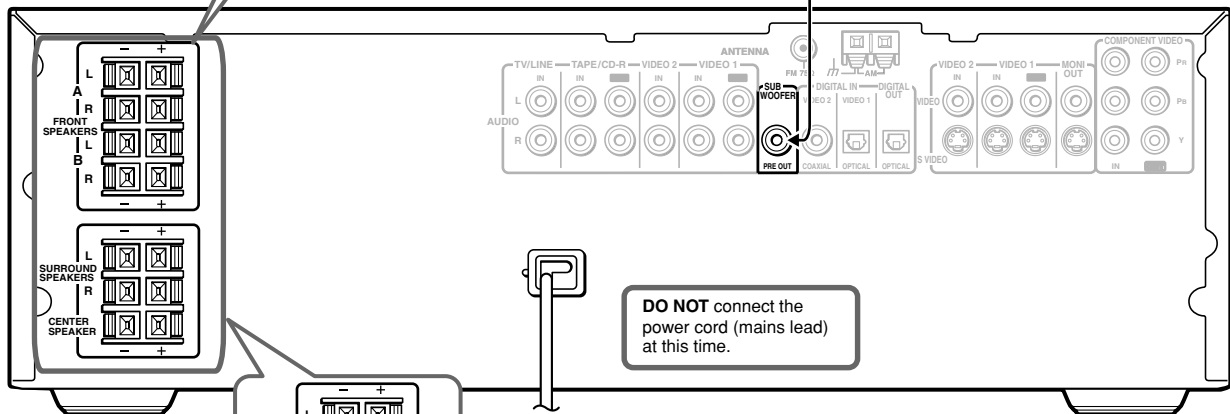
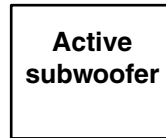
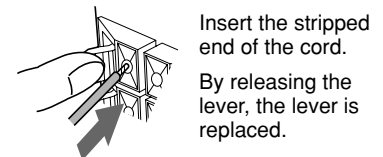
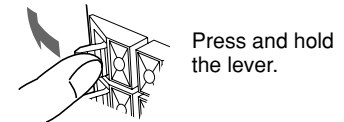
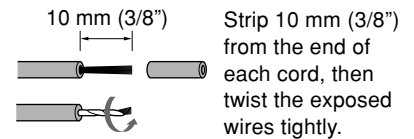

DO NOT connect the power cord (mains lead) at this time.

Connecting to SPEAKERS B

To place the additional speaker system (for the second room), make the SPEAKERS B connection on the left.

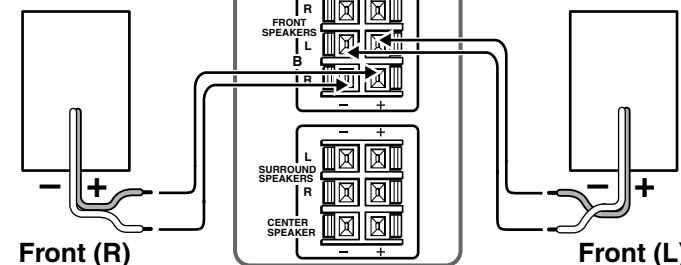

Positioning Speakers

■ Two speaker system

Two speaker systems (FRONT SPEAKERS A and FRONT SPEAKERS B) can be connected to the DVD Changer Receiver. For example, you can place the FRONT SPEAKERS A system in the main room, and the FRONT SPEAKERS B system in a second room.

The configuration of the FRONT SPEAKERS A system

The FRONT SPEAKERS A system consists of the front left, center, and right speakers, surround left and right speakers, and subwoofer.

You can reproduce the sounds such as Dolby surround and DTS surround.

The configuration of the FRONT SPEAKERS B system

The FRONT SPEAKERS B system consists of the front left and right speakers.

You can reproduce only monaural and stereo sounds.

■ Standard speaker placement of the FRONT SPEAKERS A system

Speaker placement plays an important role in the reproduction of Surround sound. The placement of the speakers varies depending on the size of the room and the wall coverings used in the room. The illustration below shows an example of a layout for standard speaker placement. Refer to this example when you position the speakers in order to experience the best of Surround sound.

For ideal Surround effects, all speakers should be installed.

If a center speaker or subwoofer is not connected, the sound from the unused channel is properly distributed to the connected speakers in order to reproduce the best Surround sound possible.

Front

The center speaker reproduces a richer sound image by enhancing the perception of the sound's source and movement.

The left, right, and center speakers should face the seated listener and be placed at ear level.

Surround

The surround speakers reproduce the feel of a moving sound while creating the sensation of being in the middle of the action.

Place the left and right surround speakers 3 feet (1 meter) above the listener's ear level and facing toward the sides of the room, making sure that the listener is within the speakers' dispersion angle.

Subwoofer

Install a subwoofer with a built-in power amplifier for powerful bass sounds.

The placement of the subwoofer does not affect the final quality of the sound image much, therefore, you can install it wherever it is convenient.

Refer to the speakers' instruction manuals for details.

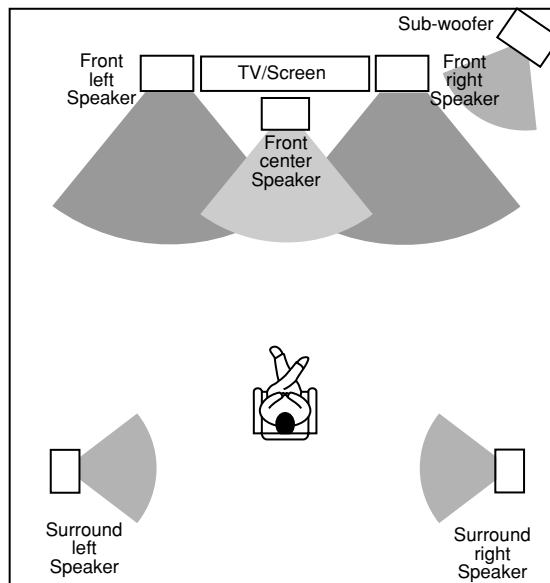

■ Using the provided speaker labels

The speaker terminals (+) of this unit are given different colors for ease of identification. By attaching the provided speaker labels to the speaker cables, the cables to be connected to the terminals can be identified easily.

Attach the speaker label of each color to the speaker cable for the corresponding terminal and connect the speaker cable to the terminal having the same color as the label attached to the cable.

The speaker terminals are colored as follows.

- Front left speaker (+): white
- Front Right speaker (+): red
- Center speaker (+): green
- Surround left speaker (+): blue
- Surround right speaker (+): gray

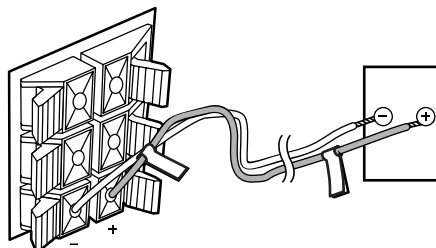

Connecting to Audio/Video Equipment

Before connecting

- Refer also to the instruction manual of each component to be connected.
- When you connect the DVD Changer Receiver to audio/video equipment, be sure to turn off the power and unplug all the units from the mains before making any connections.
- Digital audio playback from this unit or digital audio signals from a component connected to this unit's DIGITAL IN jack are output from the DIGITAL OUT jack. However, analog audio signals from a component connected to the TV/LINE or TAPE/CD-R jack is not output from this unit's DIGITAL OUT.

About the VIDEO 1 and VIDEO 2 jacks/connectors

- The video input/output connections are also necessary even if you make the S video input/output connections.
- Connect the plugs securely.

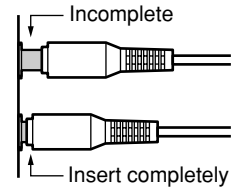

Note

The DIGITAL OPTICAL jacks are provided with protection shutters. The shutter opens when an optical fiber cable is plugged in and closes automatically when the cable is removed.

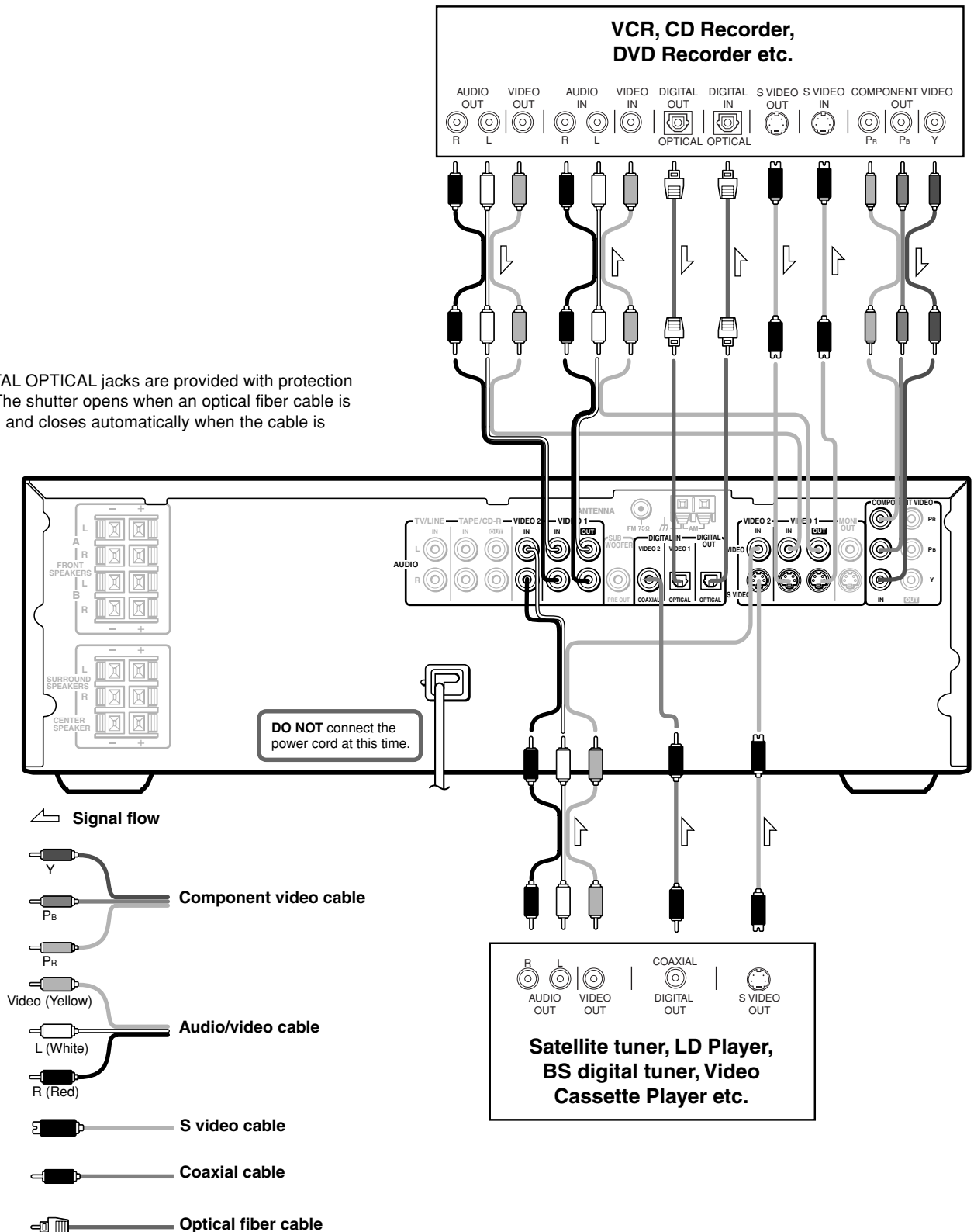

Before connecting

- Refer also to the instruction manual of each component to be connected.
- When you connect the DVD Changer Receiver to audio/video equipment, be sure to turn off the power and unplug all the units from the mains before making any connections.

- Connect the plugs securely.

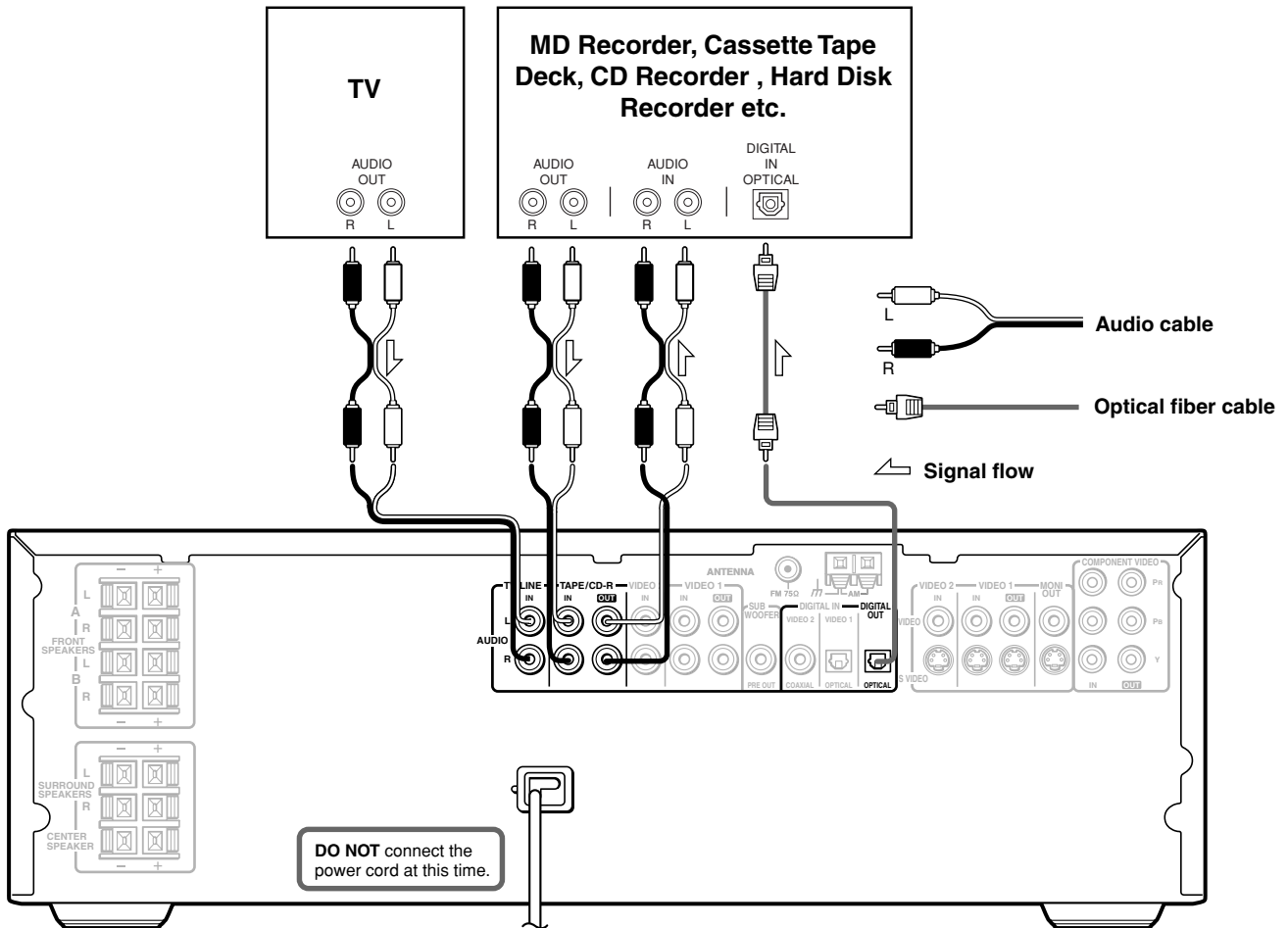
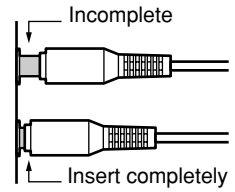

■ Turning the unit on/off with the TV's power switch — IPM function

The DVD Changer Receiver is equipped with the Intelligent Power Management (IPM) system. Just turn on your TV's power switch and, in about 5 seconds, the DVD Changer Receiver turns on automatically. If you turn off the TV's power switch, IPM indicator flashes on the display and the DVD Changer Receiver automatically turns off in about 5 minutes.

To activate the IPM function

- 1 Connect the audio output of your TV's audio output to the DVD Changer Receiver's TV/LINE IN L/R jacks (refer to page 15).
- 2 Press MODE RCVR/VCR on the remote controller.
- 3 Press IPM on the remote controller repeatedly until "IPM ON" appears on the display. The IPM indicator illuminates in the display.

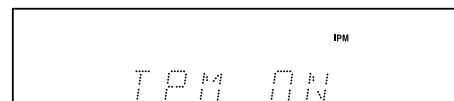

Notes

- The IPM system may not function properly with some TV sets.
- When using monaural TV, connect the audio output of the TV to the DVD Changer Receiver's TV/LINE IN L jack.
- When the TV is turned off while the DVD Changer Receiver selects other input source, the DVD Changer Receiver does not turn off.

Making Antenna Connections

Connecting the Supplied FM and AM Indoor Antennas

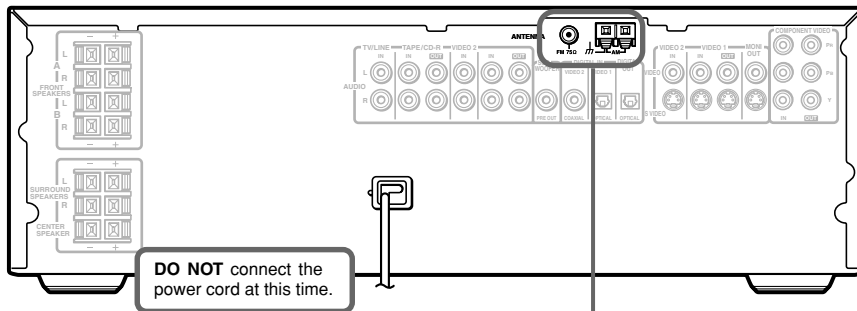

AM indoor antenna

FM indoor antenna

ANTENNA

Insert into the hole.

Press down and hold the lever.

Insert the end of the cord.

Release the lever to secure the connection.

■ **Adjusting the position of the FM indoor antenna**

While listening to an FM program (see page 52), extend the antenna and move it in various directions until the clearest signal is received, then secure the antenna with push pins in the position with the least distortion.

■ **Adjusting the position of the AM indoor antenna**

While listening to an AM program (see page 52), set the antenna in the direction and position where you receive the clearest sound. Put it as far away as possible from the unit, TVs, speaker cables, and power cords.

Note
Insert one end of the AM antenna cord to either of the AM antenna connectors and the other end to the other connector. There is no difference between one end of the AM antenna cord and the other end, unlike the speaker cords which have positive and negative poles.

Connecting an AM Outdoor Antenna

An outdoor antenna will be more effective if it is stretched horizontally above a window or outside. Leave the supplied AM indoor antenna connected.

Note

To avoid the risk of lightning and electrical shock, grounding is necessary. Follow item 14 of the "Important Safeguards" on page 2 when you install an outdoor antenna.

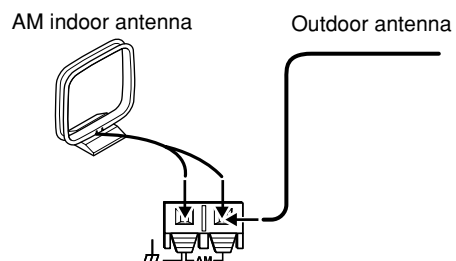

Connecting an FM Outdoor Antenna

If the FM reception is not very clear with the supplied antenna, connect an FM outdoor antenna instead of the indoor FM antenna.

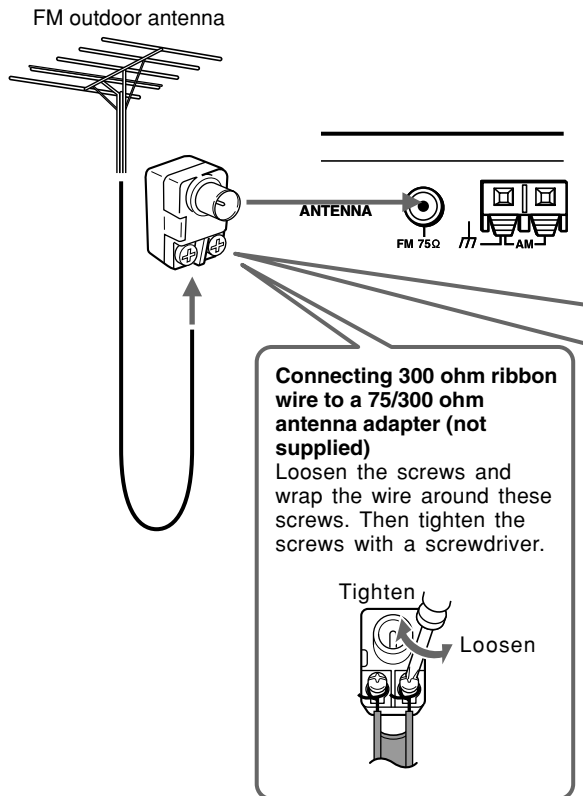

Connecting coaxial cable to a 75/300 ohm antenna adapter (not supplied)

① Strip the end of the coaxial cable.

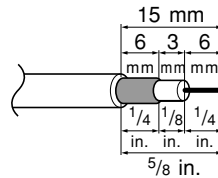

② With your fingernail or a small screwdriver, press the stoppers outward and remove the cover.

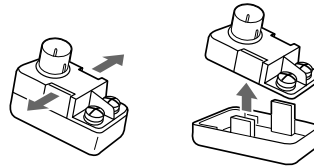

③ Remove the transformer wire A from slit B and insert it into slit C.

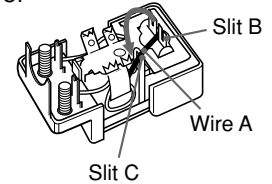

④ Insert the end of the cable.
⑤ Clamp it in place with pliers.

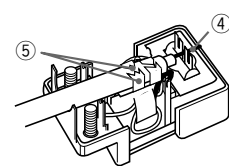

⑥ Reinstall the cover.

Notes

- Install the antenna well away from tall buildings and in an area where FM stations can directly be received.
- Keep the antenna away from noise sources (neon signs, busy roads, etc.).
- It is dangerous to put the antenna close to power lines. Keep it well away from power lines, transformers, etc.
- To avoid the risk of lightning and electrical shock, grounding is necessary. Follow item 14 of the "Important Safeguards" on page 2 when you install the outdoor antenna.

■ Directional linkage

Do not use the same antenna for both FM and TV (or VCR) reception since the FM and TV (or VCR) signals can interfere with each other. If you must use a common FM/TV (or VCR) antenna, use a directional linkage type splitter.

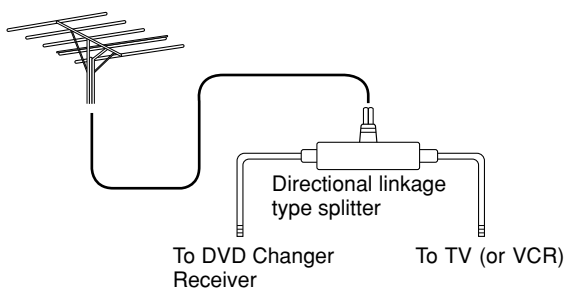

Preparing the Remote Controller

Inserting the Batteries

- 1 Detach the battery cover by pressing the tab and pulling up the cover.
- 2 Insert the two size AAA/R03 batteries.
Be sure to match the + and – ends of the batteries with the diagram inside the battery compartment.
- 3 Attach the battery cover.

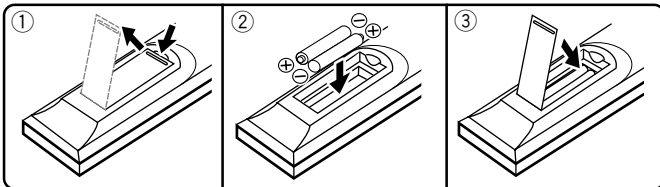

Notes

- Do not mix new batteries with old batteries or different kinds of batteries.
- To avoid corrosion, remove the batteries if the remote controller is not to be used for a long time.
- Remove dead batteries immediately to avoid damage from corrosion. If the remote controller does not operate smoothly, replace both batteries at the same time.
- The life of the supplied batteries is about six months but this varies depending on usage.

Pointing the remote controller in the right direction

Point the remote controller toward the remote control sensor.

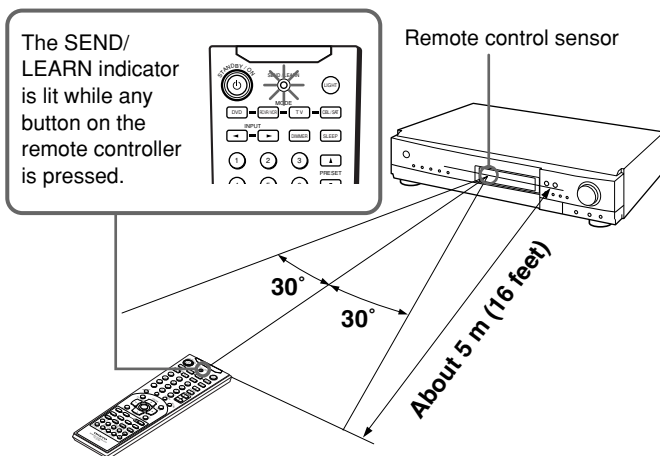

Notes

- Place the unit away from strong light such as direct sunlight or inverted fluorescent light which can prevent proper operation of the remote controller.
- Using another remote controller of the same type in the same room or using the unit near equipment which uses infrared rays may cause operational interference.
- Do not put any object (such as a book) on the remote controller. The buttons of the remote controller may be pressed by mistake and drain the batteries.
- Make sure the audio rack doors do not have colored glass. Placing the unit behind such doors may prevent proper remote controller operation.
- If there is any obstacle between the remote controller and the remote control sensor, the remote controller will not operate.

Switching the remote controller function modes

Some buttons on the remote controller have two or more functions. To set the functionality of these buttons, press one of the four **MODE (DVD, RCVR/VCR, TV, CBL/SAT)** buttons in advance.

The function mode remains the same until another **MODE** button is pressed.

(Details about the functions and the related function modes are explained in each section.)

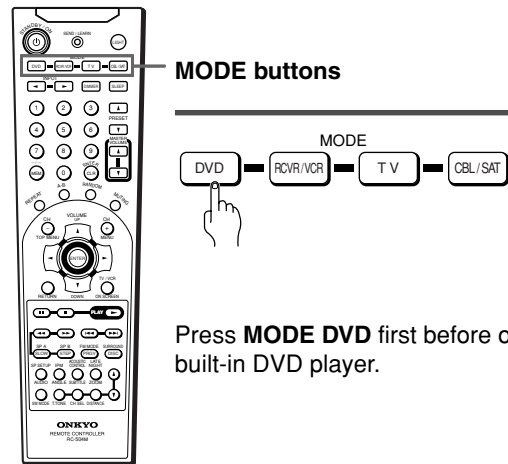

Press **MODE DVD** first before operating the built-in DVD player.

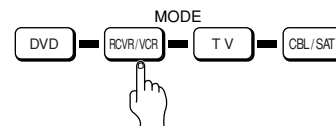

Press **MODE RCVR/VCR** first before operating the speaker setting and sound related operations.

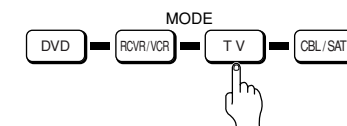

Press **MODE RCVR/VCR**, **MODE TV**, or **MODE CBL/SAT** first before operating your VCR or TV.

To operate the TV with the supplied remote controller, you need to let the remote controller learn the TV remote control signals (see pages 56-59).

Connecting the Power/ Turning on the DVD Changer Receiver

Before connecting

- Make sure that all the connections from pages 15 to 21 are complete (the connection to the TV is required).
- Turning on the DVD Changer Receiver may cause a momentary power surge, which might interfere with other electrical equipment such as computers. If this happens, use a wall outlet on a different circuit.

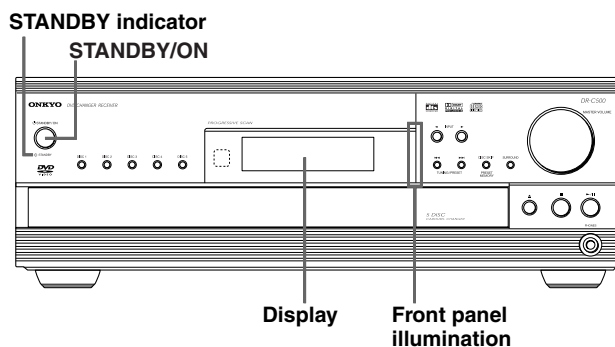

1

Connect the power cord to a wall outlet.

The DVD Changer Receiver enters the standby mode and the STANDBY indicator lights up.

2

STANDBY/ON



Press STANDBY/ON on the DVD Changer Receiver or the remote controller to turn on the DVD Changer Receiver.

The light and display on the DVD Changer Receiver's front panel light. At the same time, the STANDBY indicator goes off.

- To put the DVD Changer Receiver in the standby mode, press **STANDBY/ON** on the unit or the remote controller. Be sure to set the volume to minimum before putting the unit in the standby mode for the next use to avoid sudden loud sound reproduction.
- While in the STANDBY mode, the DVD Changer Receiver can receive signals from the remote controller.
- Setting the **STANDBY/ON** button to standby does not shut off the power completely.

Speaker Setup

You need to set up the speaker configuration for the speaker system connected to the FRONT SPEAKERS A connectors.

Notes

- Speaker setup cannot be done if;
 - Headphones are connected, or
 - The FRONT SPEAKERS B system is On (see page 31).
- It is not necessary to set the parameters again once you have completed the setup unless you change the speaker configuration.

Before operating the remote controller
Press **MODE RCVR/VCR**.



The remote controller remains in the RCVR/VCR mode, until another **MODE** button is pressed.

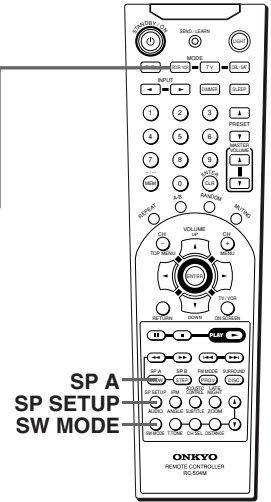

SP A
SP SETUP
SW MODE

Selecting the number of speaker channels

1

Remote controller only



Press **SP A** to select “SP A.”

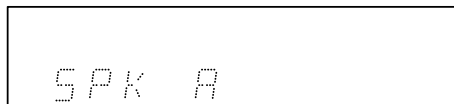

Note

The unit must be set to “SP A” for the following operations.

2

SP SETUP



Press **SP SETUP** repeatedly to select the number of channels for the Speaker A system.

Speaker configuration indicators indicate current speaker configuration.

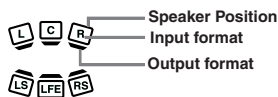
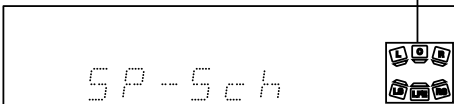

Speaker Position: Indicates the position of a selected channel.

Input format: Lights when a signal is input for that channel.

Output format: Lights when a signal is output for that channel.

Pressing the button repeatedly within three seconds changes the number of channels as follows (the corresponding speaker configuration is described in parentheses):

- **Speaker 5ch**
(Front left, center, and right, plus surround left and right speakers)
- ↓
- Speaker 2ch**
(Front left and right speakers)
- ↓
- Speaker 3ch**
(Front left, center, and right speakers)
- ↓
- Speaker 4ch**
(Front left and right, plus surround left and right speakers)

The normal display resumes in three seconds.
Speaker configuration indicator in the lower right corner shows the current speaker configuration.

Note

- To check the present setting while the normal display is displayed, press **SP SETUP** once. To change the setting, press the button repeatedly within three seconds.

Selecting the Subwoofer mode

Remote controller



Press **SW MODE** on the remote controller.

SW indicator lights up when SW Mode 1, SW Mode 2 or SW Mode 3 is selected.

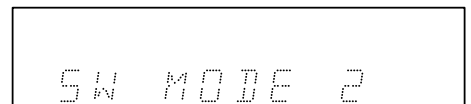

With the first press of the button, you can check the present setting. Then each press of the button changes the subwoofer mode as follows (a tip on how to select the right subwoofer mode is in parentheses):

SW MODE 1

(When small—with limited bass signal handling—front speakers are connected)

SW MODE 2

(When large—wideband—front speakers are connected)

SW MODE 3

(When large—wideband speakers are connected to all channel)

SW Off

(When no subwoofer is connected)





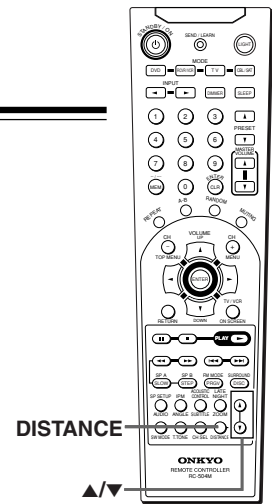

The initial setting is SW MODE 1.

Before starting the procedure below, measure the distances from each speaker to the listening position. For pair speakers such as front left and right speakers, the distance from the listening position to one speaker should be the same as the distance to the other.

In the procedure below, select the values which approximate the actual distances.



Setting the Distance From the Listening Position to Each Speaker

<p>1</p> <p>Remote controller only</p> 	<p>Press DISTANCE.</p> <p>The distance entry display for the front left and right speakers appears.</p>
<p>2</p> 	<p>Press ▲/▼ to select the front left and right speaker distance.</p> <p>You can select a distance between 1 ft. and 30 ft. (0.3 m and 9 m).</p> <p>Note</p> <ul style="list-style-type: none"> Press and hold the DISTANCE button to switch between feet and meters. The initial setting is feet.
<p>3</p>  <p>↓</p> 	<p>Press DISTANCE, then press ▲/▼ repeatedly to select the center speaker distance.</p> <p>You cannot enter the following distances:</p> <ul style="list-style-type: none"> Distances longer than the distance set for the front speakers. Distances shorter than the distance obtained by subtracting "5 ft. (1.5 m)" from the distance entered for the front speakers. <p>Note</p> <ul style="list-style-type: none"> If you selected a speaker configuration with no center speaker on the previous page, this step will be skipped.
<p>4</p>  <p>↓</p> 	<p>Press DISTANCE, then press ▲/▼ repeatedly to select the surround left and right speaker distance.</p> <p>You cannot enter the following distances:</p> <ul style="list-style-type: none"> Distances longer than the distance set for the front speakers. Distances shorter than the distance obtained by subtracting "15 ft. (4.5 m)" from the distance entered for the front speakers. <p>Note</p> <ul style="list-style-type: none"> If you selected a speaker configuration with no surround speakers on the previous page, this step will be skipped.
<p>5</p> 	<p>Press DISTANCE.</p> <p>The normal display resumes.</p>

Speaker Setup

Adjust each speaker's relative volume balance so that the volumes of all speakers' test tones sound equal at the listening position.

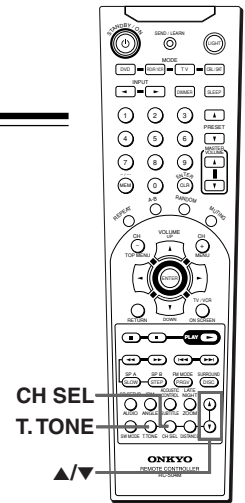

Adjusting Each Speaker's Relative Volume Balance – Test Tone

1
Remote controller only

Press T. TONE.
Each speaker emits the test tone (pink noise) and the display shows the speaker emitting the test tone in the following order:

L ch (Front left ch.)	→	C ch (Center ch.)
↑		↓
SW ch (Subwoofer)		R ch (Front right ch.)
↑		↓
LS ch (Surround left ch.)	←	RS ch (Surround right ch.)

Lch 0 dB

Note
No test tone will be emitted from the speaker which is not included in the speaker configuration on pages 27-29 even if it is actually connected.

3

When you have completed the adjustment by repeating step 2, press T. TONE.
The test tone stops and the normal display resumes.

Note
Even if you don't press T. TONE, the test tone will stop after two minutes.

2

Press CH SEL repeatedly to select the speaker, then press ▲/▼ to adjust the volume level.
The volume level can be adjusted between -10dB and +10dB.

Enjoying the Sound Effects



The surround sound of the DVD Changer Receiver enables you to enjoy the presence of a movie theater or concert hall in your room.

Before using any sound effect, make sure the Speaker Setup configurations have been set (see pages 24-26).

The speaker configuration is very important for the surround sound. See "Connecting Speakers" on page 16 and "Positioning Speakers" on page 17.

Following are the sound systems the DVD Changer Receiver can reproduce.

■ DOLBY DIGITAL Surround and DTS (Digital Theater System) Surround

Recommended speaker setup

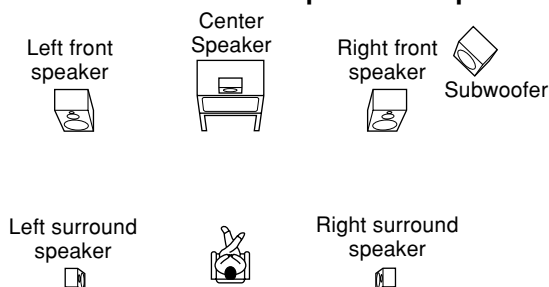

This 5.1 channel digital surround format enables you to individually play five full-range (20Hz–20kHz) channels (left and right front, center, and two surround channels) plus an LFE (Low Frequency Effect) channel for the low-range effect sound. It will create a realistic sound like that heard in theaters and concert halls.

DOLBY DIGITAL Surround

DVD videos that have the mark are recorded using this system.

To playback DOLBY DIGITAL Surround sound from connected equipment, you must make the digital connection in addition to the above speaker configuration.

DTS Surround

DVD videos and audio CDs that have the mark are recorded using this system.

To playback DTS Surround sound from connected equipment such as an LD player, you must make the digital connection in addition to the above speaker configuration.

Notes on DTS Surround

- If you play a DTS Surround encoded disc with the DVD Changer Receiver, or a DTS encoded disc using a digitally connected player, you may hear a noise for a short while until the DTS decoder of the DVD Changer Receiver recognizes the DTS encoded signal and starts operating. This is not a malfunction.
- If you play a DTS Surround source in fast reverse or fast forward, pause, or skip a chapter or track, noise may be heard. This is not a malfunction.
- Even when playback of the DTS Surround source stops and the DTS signal transmission ends, the DVD Changer Receiver remains in DTS mode and the DTS indicator remains lit. This is to prevent noise when you pause, fast forward, fast reverse, or skip a chapter or track of the playback source. Therefore, if the source switches from the DTS signal to a PCM (2 channel digital stereo) signal immediately, the PCM signal may not be played. In such a case, stop playback for about three seconds, then resume playback.

- Some CD players (if connected to the DVD Changer Receiver) and LD players may be unable to play DTS Surround sources correctly even if you connect the player to the DVD Changer Receiver digitally. In such a case, the digital signals (such as the output level, sampling frequency, frequency response, etc.) processed by the DVD Changer Receiver cannot be recognized as DTS data by the DVD Changer Receiver and you may hear noise instead of the proper sound.

■ DOLBY PRO LOGIC II Surround

This is a new generation 5-channel surround system, bridging the gap between the previous 4-channel (Left/Right Front, Center and monaural surround channels) Pro Logic surround and 5.1-channel Dolby Digital surround. Dolby Pro Logic II provides the Movie mode optimized for viewing movies and the Music mode optimized for listening to music. In the Movie mode, the surround channel, which was monaural and based on narrow band, is reproduced in stereo so that the feeling of movement in the played movies is more enhanced. In the Music mode, the surround channel reproduces natural sound field even with 2-channel music sources.

The Movie mode allows you to enjoy VHS and DVD software carrying the marking as well as some of TV broadcast programs. The Music mode allows you to enjoy stereo music from CD, etc.

■ Onkyo's original Digital Signal Processing (DSP) modes

The DVD Changer Receiver offers the following special Onkyo sound effects for sources other than Dolby Digital and DTS sounds.

Orchestra

This mode is suitable for classical and opera music. The center channel is cut and the surround channels are emphasized to widen the stereo image. It simulates a natural reverberation as created in a large hall.

Unplugged

This mode is suitable for acoustic instrumental sounds, vocals, and jazz music. By emphasizing the front stereo image, it simulates the acoustics in front of the stage.

Studio

This mode is suitable for rock and popular music. Lively sounds with a powerful acoustic image will make you feel as if you are in a club.

TV Logic

This mode offers the realistic acoustics of a TV program being aired in the TV studio. It enhances the entire surround sound and clarity of conversation.

All Ch St (All Channel Stereo)

This mode is useful for background music. The front and surround channels will create a stereo image.

Enjoying the Sound Effects

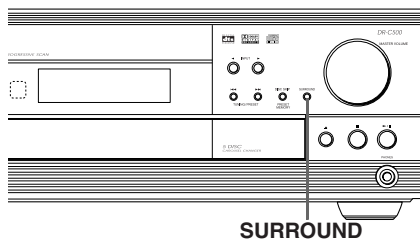

Before operating the remote controller
Press **MODE RCVR/VCR**.

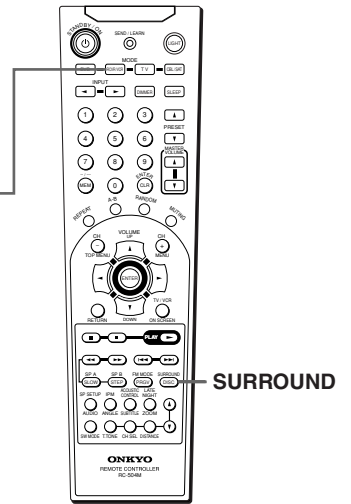

The Input Sources and Available Listening Modes

The available listening modes vary depending on the sound type of the input source. The table below shows the correlation between the input source types and listening modes.
(× marked listening modes can be chosen with a particular type of a source.)

Input Source Signals Possible sources	Analog/PCM		Dolby Digital		DTS
	PCM 96mHz	Other	2/0	Other	
Stereo	×	×	×	×	×
DOLBY DIGITAL				×	
DTS					×
PL II Movie/PL II Music		×	×		
Orchestra		×			
Unplugged		×			
Studio		×			
TV Logic		×			
All Ch Stereo		×			

- Notes**
- The listening mode is set to "Stereo" when the PCM sound whose sampling frequency is higher than 48kHz is played. Such high-resolution sounds are reproduced from sources such as DVD video.
 - When the input source is monaural, such as AM radio or TV, if you set the surround mode to PLII Movie or PLII Music, sound reproduction is concentrated around the center speaker. Surround mode is especially suited for enjoyment of monaural sound.

Checking the Sound System of the Playing Source

The DVD Changer Receiver will automatically detect the sound system when DOLBY DIGITAL Surround (DOLBY DIGITAL), DTS Surround (DTS), or PCM/MP3 DIGITAL (2 channel digital stereo) is played back. The corresponding sound system indicator lights in the DVD Changer Receiver's display.

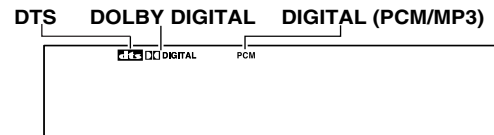

Using Dolby Pro Logic II/ Onkyo's Original DSP Modes

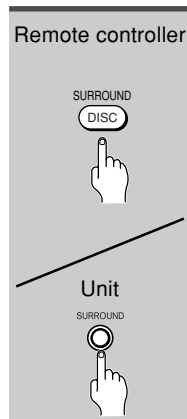

Press SURROUND on the remote controller or the unit to choose "PL II" or the DSP mode.
The current listening mode appears in the display when the button is pressed once, then each press of the button changes the listening mode as follows:

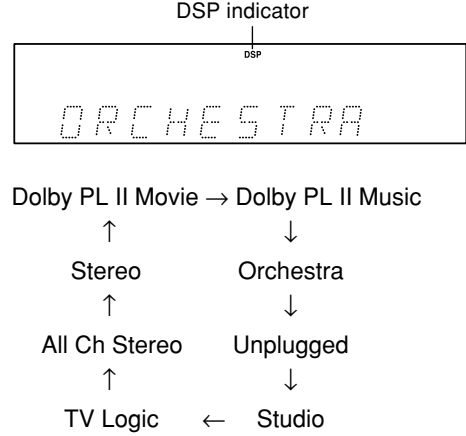

- In the display, "PL II Movie" or "PL II Music" appears and the PRO LOGIC II indicator lights up.
- PL II and DSP mode cannot be selected when "Speaker 2ch" is selected. (Only "Stereo" can be selected.)
- Only "PL II Movie" or "PL II Music" can be selected when "Speaker 3ch" is selected.

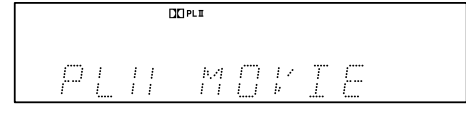

- Note**
- When the input source is monaural, such as AM radio or TV, if you set the surround mode to PLII Movie or PLII Music, sound reproduction is concentrated around the center speaker. Surround mode is especially suited for enjoyment of monaural sound.

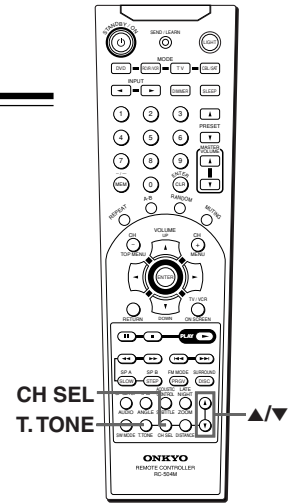

Adjusting Each Speaker's Relative Volume Balance Temporarily

You can readjust each speaker's relative volume balance according to your preference while listening to the sound.

The adjusted values will return to the values set on page 26 when the DVD Changer Receiver enters standby mode.

1

Remote controller only



(Checking each speaker's relative volume balance)

While playing the source, press **CH SEL** repeatedly.

Each press of the button changes the speaker which outputs the sound and the selected speaker appears in the display in the following order:

- L ch (Front left ch.)
- ↓
- C ch (Center ch.)
- ↓
- R ch (Front right ch.)
- ↓
- LS ch (Surround left ch.)
- ↓
- RS ch (Surround right ch.)
- ↓
- SW ch (Subwoofer)

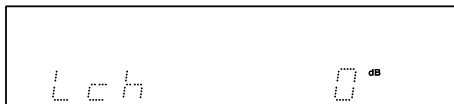

Notes

- Any speaker that is not included in the speaker configuration on pages 24-25 is not selected even if it is actually connected.
- The display returns to normal if no button is pressed for 5 seconds.

2



(Adjusting each speaker's relative volume balance)

Press **CH SEL** repeatedly to select the speaker, then press **▲/▼** to adjust the volume level.

The volume level can be adjusted between -10dB and $+10\text{dB}$.

Repeat this step to change another speaker's volume balance.

■ Saving the adjusted values

Remote controller only

Press **T. TONE**.



Enjoying the Sound Effects

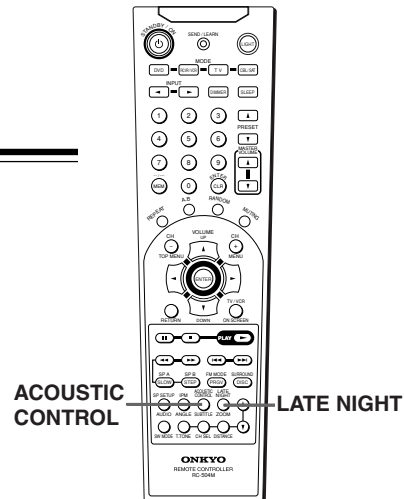

Using the LATE NIGHT Function

- The LATE NIGHT function operates when the sound is DOLBY DIGITAL Surround. If you play a movie at low volume at night, set this function to "Low" or "High" to narrow the dynamic range of the sound and make it easier to hear.

Boosting the Super Bass Sounds/ High Frequency Sounds

You can enjoy more dynamic sounds by boosting the super bass/high frequency sounds, even with decreased volume.

Remote controller only



Press LATE NIGHT.

The current setting appears in the display.

To change the setting, press the button repeatedly while the current setting is displayed.

- When the button is pressed while DOLBY DIGITAL Surround sound is being reproduced "LOW", "HIGH" or "OFF" can be selected.

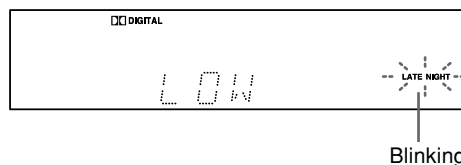

Note

- The LATE NIGHT effect is determined by each DOLBY DIGITAL sound source. Some sources may produce little or no effect.

Remote controller only



Press ACOUSTIC CONTROL on the remote controller.

Each press of the button changes the acoustic mode as follows:

→ "A.CTRL 1" appears in the display. The super bass sounds are boosted.

↓
"A.CTRL 2" appears in the display. The super bass sounds are further reinforced and the high frequency sounds are also reinforced.

↓
"A.CTRL OFF" appears in the display.

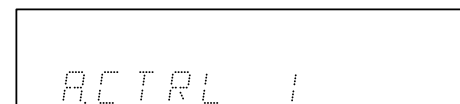

Various Functions Common to all the Sources

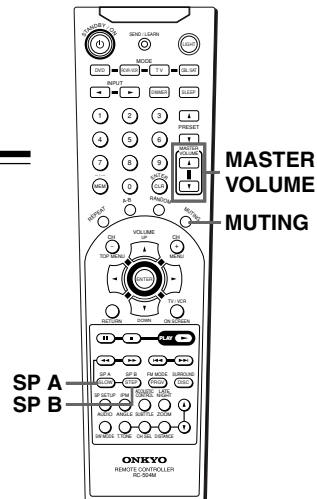
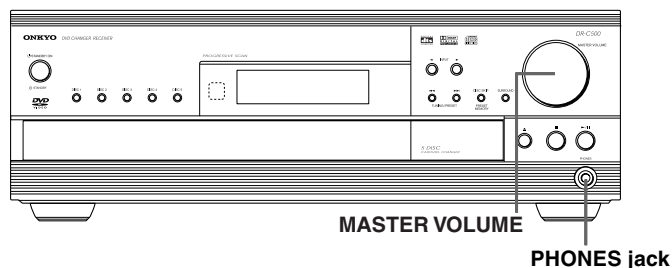

Turning on/off the SPEAKERS A/ SPEAKERS B Systems

You can turn on or off the speaker systems connected to the FRONT SPEAKERS A and B connectors individually.

Note

When you select "SPEAKER A+B", the SPEAKER A system reproduces stereo sound automatically. (The listening mode is set to "Stereo.")

When you select "SPEAKER A", the listening mode returns to the previous mode.

■ Operating with the remote controller



Press SP A or SP B repeatedly to turn the SPEAKERS A or SPEAKERS B system On/Off.

Each press of the button changes the On/Off mode.

Listening Through Headphones

Connect the plug of the stereo headphones to the PHONES jack.

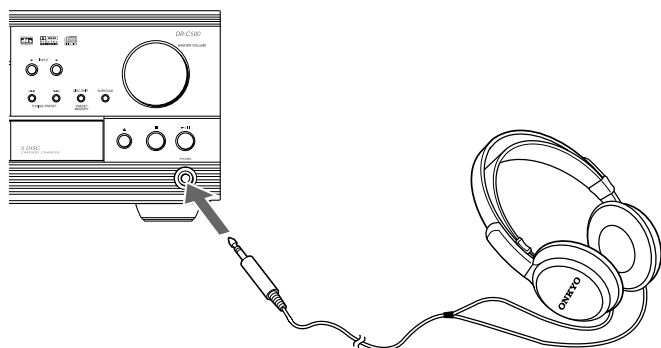

Notes

- The speakers will not reproduce sound while headphones are connected.
- The listening mode is set to "Stereo" after connecting the headphones to the PHONES jack.
- When you disconnect the headphones, the listening mode returns to the previous mode.

Adjusting the Volume

The volume of the front left and right, center, surround left and right, and subwoofer speakers will be adjusted at the same time.

When headphones are connected (see next page), you can adjust the volume of the sound through the headphones.

■ Operating with the remote controller

Press MASTER VOLUME ▲/▼.

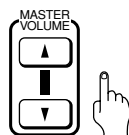

■ Operating with the unit



Turn MASTER VOLUME clockwise to increase the volume, or counterclockwise (anticlockwise) to decrease the volume.

Muting the Sound

Remote controller only



Press MUTING.

"MUTING" appears in the multipurpose display for about three seconds. Also the MUTING indicator flashes in the display during the muting mode.

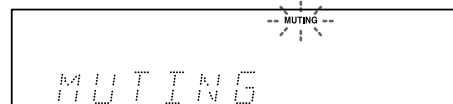

To restore the sound, press MUTING again.

Tip

- If you turn off the unit during muting and turn it on again, the sound will be restored. The sound will also be restored if you adjust the MASTER VOLUME during muting.

Various Functions Common to all the Sources

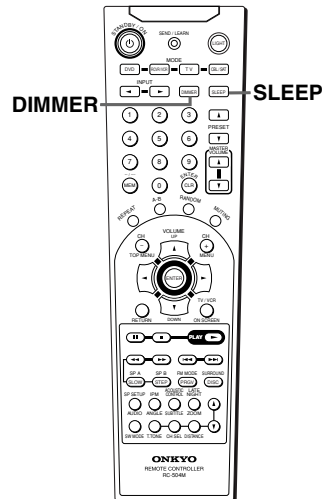

Controlling the Brightness of the Display

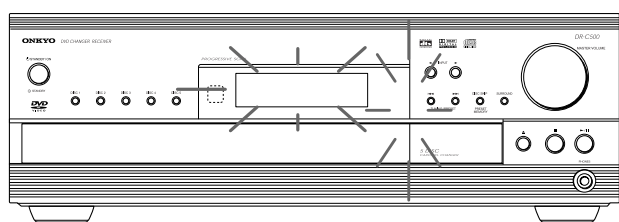

Remote controller only



Press DIMMER.

Each press of the button changes the brightness as follows:

- The display becomes less bright.
- ↓
- The display is dimmed.
- ↓
- The display is dimmed, and the front panel illumination goes off.
- ↓
- The display resumes the original brightness and the front panel illumination turns on.

Using the Sleep Timer

Remote controller only



Press SLEEP.

"SLEEP 90" appears in the multipurpose display for about 3 seconds, which means the DVD Changer Receiver will turn off and enter standby mode in 90 minutes. Also the SLEEP indicator is lit in the display while the sleep timer is On.

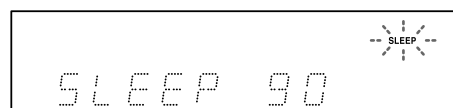

Each press of the button makes the remaining time shorter by 10 minutes.

■ Checking the remaining time

Press SLEEP while the Sleep Timer is On.

If you press **SLEEP** while the remaining time is displayed, the remaining time is reduced by 10 minutes.

■ Canceling the Sleep Timer

Press **SLEEP** repeatedly until the **SLEEP** indicator goes off.

Basic Playback

■ About the DVD, VCD, CD and MP3 marks in the pages related to disc operation

- DVD means the function or title is related to DVD-Video operation.
- VCD means the function or title is related to Video CD operation.
- CD means the function or title is related to audio CD operation.
- MP3 means the function or title is related to MP3 operation.

DVD VCD CD MP3

Playing DVDs, Video CDs, CDs and MP3s

1 Unit



Press ▲.

- The disc tray comes out.
- If the DVD Changer Receiver is in standby mode when ▲ button is pressed, the DVD Changer Receiver turns on and the disc tray opens. In this case, it takes several seconds until the disc tray opens.

2

Place a disc on the disc tray.

- To insert or remove another disc by changing the tray position, press **DISC SKIP**.
- Put the disc in the tray with the label side facing up.
- There are two different disc sizes. Place the disc in the correct guide on the disc tray.

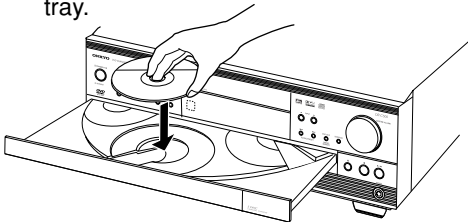

3 Unit



Remote controller

PLAY



Press ►/II on the unit or PLAY ► on the remote controller.

- The disc tray closes, and playback starts.
- If you press ▲ to close the tray after step 2, playback may automatically start.
- MP3 only: It may take a few seconds for the DVD Changer Receiver to locate the track on the disc, depending on the complexity of the file structure.

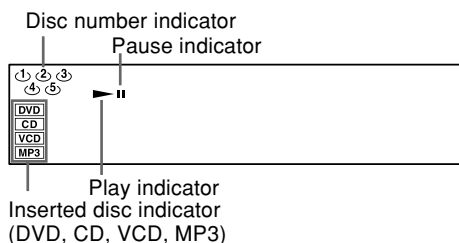

- The appropriate inserted disc, disc number and the play indicators illuminate.

Before operating the remote controller
Press **MODE DVD**.

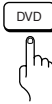

Number buttons

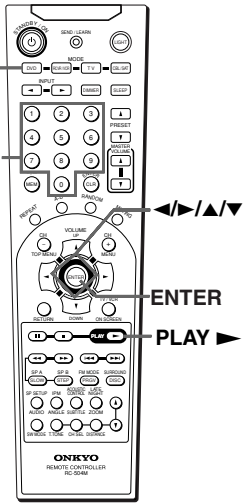

- If the DVD Changer Receiver is in standby mode when ►/II button is pressed, the DVD Changer Receiver turns on and playback starts. In this case it may take several seconds until playback starts.

DVD VCD

When a Menu Screen is Displayed

Menu screens are displayed for DVDs that have menu screens or Video CDs that include Playback Control (PBC).

Remote controller

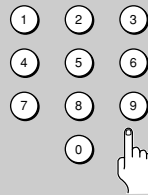
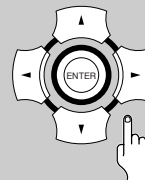

Select the item you want to view.

- When a DVD is loaded:
Select the item with the cursor buttons (◀/▶/▲/▼) or the number buttons then press **ENTER**.
- When a Video CD is loaded:
Use the number buttons to select the item.

Notes

- The TV screen size is factory set to present the standard screen format (4:3 aspect ratio). If you have a wide screen TV (16:9 aspect ratio), this setting can be changed to match your TV screen size (page 51).
- Do not move the DVD Changer Receiver during playback. Doing so may damage the disc.
- Use ▲ on the DVD Changer Receiver to open and close the disc tray. Do not touch the disc tray while it is moving. Doing so may cause the DVD Changer Receiver to malfunction.
- Do not press down on the disc tray or put any objects other than playable discs on the disc tray. Doing so may cause the DVD Changer Receiver to malfunction.
- In many instances, a menu screen appears when playback of a movie is complete. Prolonged display of an on-screen menu may damage your television set, permanently etching that image onto its screen. To avoid this, be sure to press ■ once the movie is complete.
- Do not push on the disc tray to close it.
- Do not turn the disc carousel by hand.
- Do not place a new disc in the tray number of a currently playing disc. This may result in damage to the disc and/or DVD Changer Receiver.

Basic Playback

DVD VCD CD MP3

Stopping Playback

1

Remote controller



Unit



Press ■.

When you press ►/|| on the unit or ► on the remote controller to restart playback, playback starts from the location where you stopped playback because the location index is stored in memory.

Notes

- The location where playback resumes may vary depending on the disc or the scene where you stopped.
- Resume playback is not available for MP3 discs.

Resuming playback from the beginning

Press ■ again after stopping playback to clear the location index memory, then press ►/|| to start playback. Playback starts from the beginning of the disc.

DVD VCD CD MP3

To Pause Playback (Still mode)

Remote controller



Unit



Press || on the remote controller or ►/|| on the unit during playback.

To start playback press ► on the remote controller or ►/|| on the unit.

DVD VCD CD MP3

To Select a Disc

Press one of the **DISC 1** to **DISC 5** buttons or press **DISC SKIP** repeatedly.

DVD VCD

Progressive Scan Function

1

Remote controller only



Press **PRGV** to display **Progressive** or **Interlaced** icon on TV.

2



Press **PRGV** again while displayed to switch between **Progressive** and **Interlaced**.

Progressive

Interlaced

Notes

- When component video is connected, you can use Progressive scan. Progressive scan is not available if S-Video or Composite video is connected.
- If you connect a TV that is not compatible with a progressive scan signal and choose "Progressive", the picture may be distorted. Be sure to choose "Interlaced" if your TV is connected using either the Composite or S-Video terminals.

DVD VCD

When an operation is prohibited

There are times when you are using the DVD Changer Receiver and attempt to perform an operation, but for some reason it cannot be performed. When this occurs, ⊘ appears on the screen.

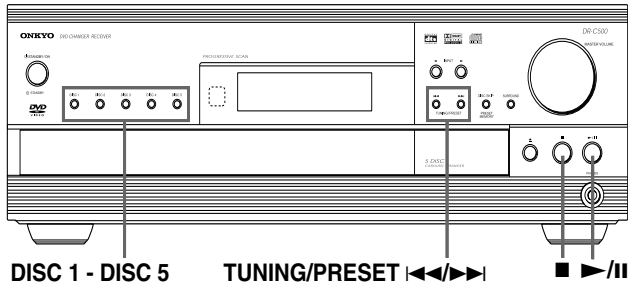



DVD VCD

To Open or Return to the DVD or Video CD Menu Screen

Although this differs depending on the disc, pressing **MENU** during DVD or Video CD playback displays the menu screen. Refer to the DVD or Video CD disc jacket and accompanying documentation for more information.

DVD VCD CD MP3

To Skip Chapters or Tracks

<p>Remote controller</p> 	<p>Advancing to the next chapter (track).</p> <p>Press ►►.</p> <p>Press to skip forward to the next chapter (track).</p>
<p>Unit</p> 	<p>Skipping back to the previous chapter (track).</p> <p>Press ◀◀.</p> <ul style="list-style-type: none"> • Press once to skip back to the start of the chapter (track) currently playing. • Press twice to skip back to the start of the previous chapter (track).

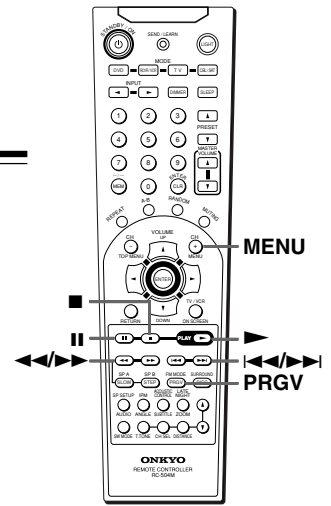

DVD VCD CD

To Play in Fast Reverse or Fast Forward

Remote controller only

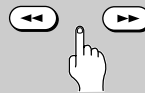

During normal playback, press ◀◀/►►.

Each press of the same button changes the playback speed.

(During DVD playback, press ►►)

F.SEARCH 1 (approx. x2)	→	F.SEARCH 2 (approx. x4)
↑		↓
F.SEARCH 4 (approx. x16)	←	F.SEARCH 3 (approx. x8)

(During Video CD/CD playback, press ►►)

F.SEARCH 1 (approx. x2)	→	F.SEARCH 2 (approx. x4)
↑		↓
F.SEARCH 3 (approx. x8)	←	

When ◀◀ is pressed, R.SEARCH functions in a similar manner.

To resume normal playback, press ►.

Notes

- The DVD Changer Receiver mutes sounds and omits subtitles during fast reverse and fast forward of DVD-Video and Video CD.
- The playback speed may differ depending on the disc.
- Fast reverse and fast forward do not function when playing MP3.

Still Frame/Slow Play

The video images on DVD and Video CD can be viewed as a still frame, played back at slow speeds and even advanced frame by frame.

Before operating the remote controller
Press **MODE DVD**.

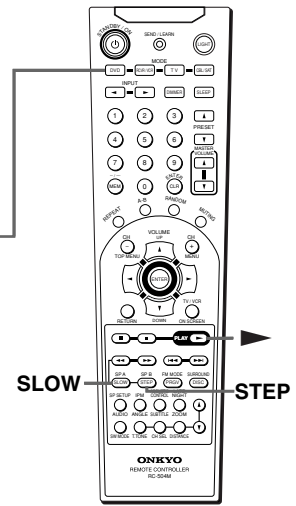
DVD VCD

Playing Frame by Frame

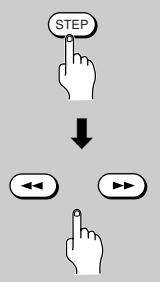

Press the STEP button, then press <</>> repeatedly.
Each time you press the button the picture advances one frame.

▶▶: STEP forward
◀◀: STEP reverse

To resume normal playback, press ▶.

Note

- The sound is muted during still mode and frame by frame playback.
- Video CDs cannot be played frame by frame in reverse.

DVD VCD

To Play in Slow-motion

You can't use slow reverse play with Video CDs.

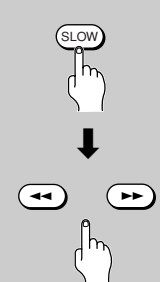

Press the SLOW button, then press <</>> repeatedly.
Each press of the same button changes the playback speed.

▶▶: SLOW forward
◀◀: SLOW reverse

(During DVD Playback, press ▶▶)

F.SLOW 1/16	→	F. SLOW 1/8
	↑	↓
F. SLOW 1/2	←	F. SLOW 1/4

When ◀◀ is pressed, R. SLOW functions in a similar manner.

(During Video CD Playback, press ▶▶)

F. SLOW 1/8	→	F. SLOW 1/4
	↖	↙
	F. SLOW 1/2	

To resume normal playback, press ▶.

Notes

- The sound is muted during slow-motion playback.
- The playback speed may differ depending on the disc.
- Slow reverse is not available for Video CD.

Repeat Play

Desired disc or title can be played back repeatedly. There are five repeat options:

- All Discs Repeat all discs.
- 1 Disc Repeat the disc that is playing.
- Title Repeat the title that is playing.
- Chapter Repeat the chapter that is playing.
- Track Repeat the track that is playing.

DVD VCD CD

Repeat Play



Press **REPEAT** repeatedly during playback.

The Repeat display appears on the screen.



Each time you press **REPEAT**, the repeat option changes.

(During DVD Playback)

- Repeat All Discs Repeats all discs.
- ↓
- Repeat 1 Disc Repeats the entire disc.
- ↓
- Repeat Title Repeats the current title.
- ↓
- Repeat Chapter Repeats the current chapter.
- ↓
- Repeat Off Resumes normal playback.

(During Video CD/CD Playback)

- Repeat All Discs Repeats all discs.
- ↓
- Repeat 1 Disc Repeats the entire disc.
- ↓
- Repeat Track Repeats the current track.
- ↓
- Repeat Off Resumes normal playback.

Notes

- When playing a PBC-compatible Video CD and PBC is on, you cannot play it repeatedly. To use repeat play, press **TOP MENU** and select "PBC off", then press **REPEAT**.
- With some DVDs, repeat playback may not be possible.
- Please see "MP3 Repeat Play" on page 46 for MP3.

■ To turn off the Repeat display

Press **ON SCREEN** or **CLR**.

The menu is switched off when no operation is performed for about 5 seconds.

■ To cancel repeat playback

Press **REPEAT** so that the REPEAT indicator goes off or select "Repeat Off".

Before operating the remote controller Press **MODE DVD**.

DVD



DVD VCD CD

A-B Repeat Play

The A-B repeat function lets you mark a segment to repeat between the beginning "A" and the end "B" of the segment you want to replay.

1



Press **A-B** when you want to choose a scene (sound) as the beginning point.

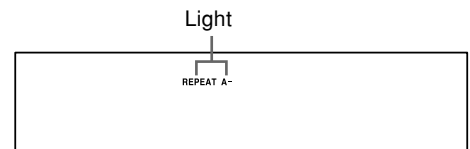

The Repeat A- display appears on the screen.

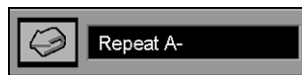

2



Press **A-B** again to choose a scene (sound) as the end point.

The Repeat A-B display lights.

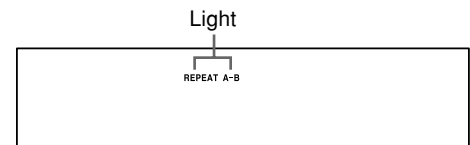

The DVD Changer Receiver automatically returns to point A and starts repeat playback of the selected segment (A-B).

Notes

- Repeat A-B will not function for segments under 3 seconds.
- When playing a PBC-compatible Video CD and PBC is on, you cannot use A-B repeat function. To use A-B repeat function, press **TOP MENU** and select "PBC off", then press **A-B**.

■ To turn off the Repeat A-B display

Press **ON SCREEN** or **CLR**.

The menu is switched off when no operation is performed for about 5 seconds.

■ To cancel A-B Repeat playback

Press **A-B** so that the REPEAT and A-B indicators go off or select "Repeat off".

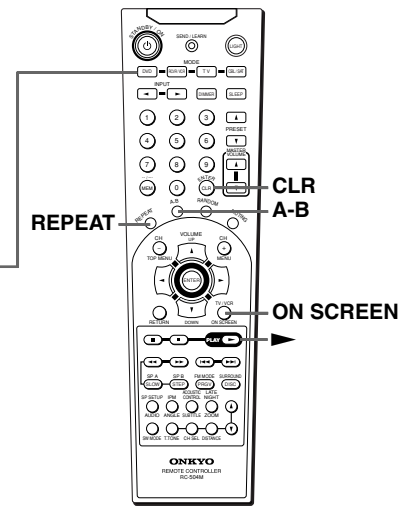

Random Play

Before operating the remote controller
Press **MODE DVD**.

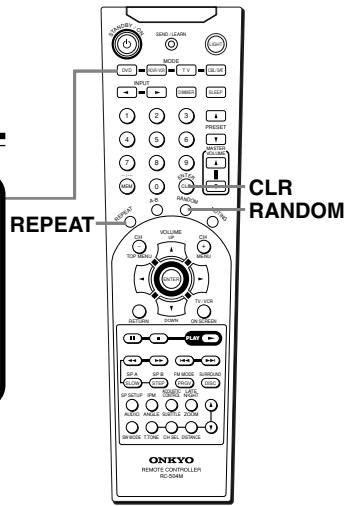

Random Play

The chapters or tracks of the disc are played in random order.

Press RANDOM.
The random playback starts.

Lights



The Random Play display appears on the screen.



■ To cancel random play

Press **RANDOM** so that RANDOM indicator goes off or select "Standard Play".

Each time you press **RANDOM**, random play will turn on and off.

Random Play ↔ Standard Play

The Standard Play display appears when random is off.



Notes

- You cannot play DVDs in random order.
- When playing a PBC-compatible Video CD and PBC is on, you cannot play it in random order. To use random play, press **TOP MENU** and select "PBC off", then press **RANDOM**.

■ To play Discs and Tracks in random order

Press **RANDOM** and **REPEAT** repeatedly to select "Repeat All Discs" during playback.

Discs and Tracks are played in random order repeatedly.

■ To turn off the random play display

Press **ON SCREEN** or **CLR**.

The menu is switched off when no operation is performed for about 5 seconds.

Playing in a Favorite Order

The discs, titles and chapters within a title on a DVD and similarly CD and Video CD tracks can be arranged to play in the order you want.

With this player, it is possible to make a program as you watch a DVD or Video CD or while listening to a CD.

Before operating the remote controller
Press **MODE DVD**.

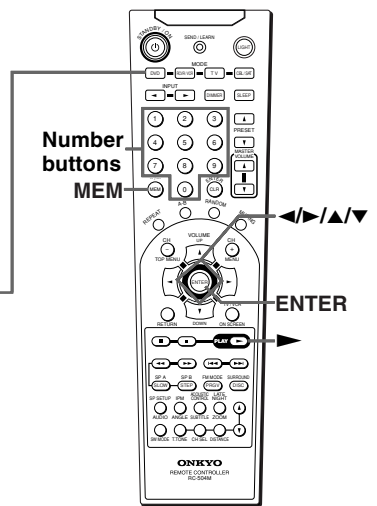

DVD VCD CD

Programming DVDs, CDs, Video CDs

The DVD Changer Receiver automatically plays discs, titles, chapters, or tracks in the order you program.

1



Press MEM during stop mode.

The MEMORY EDIT display appears and the MEM. indicator lights.

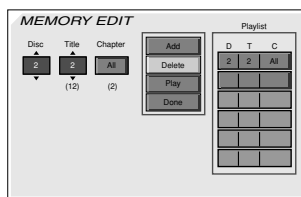

2

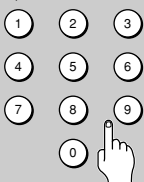

Press ▲/▼ or number buttons to select specific disc, title, chapter or track.

If you use ▲/▼ to select the track, you must press **ENTER** before making the next selection. If you use the number buttons, you don't have to press **ENTER**.

3



Press ▲/▼ to select Add button on the screen to register selected value onto Playlist, then press ENTER.

4

You can select maximum of 32 values by repeating steps 2 and 3.

5



Press PLAY ► or select the Play button on the screen and press ENTER to start playback.

■ To delete memory

- 1 Press **MEMORY** during stop mode.
- 2 Move the cursor with ► to the "Playlist" and press ▲/▼ to select the row to be deleted from the "Playlist". (The color of the row where the cursor is located will change.)
- 3 Press ◀ and press ▲/▼ to move the cursor to the Delete button on the screen, and press **ENTER**.

■ Insert disc, title, chapter or track

- 1 Press **MEMORY** during stop mode. The MEMORY EDIT display appears.

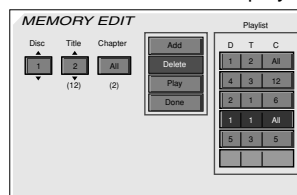

- 2 Press ▲/▼ and **ENTER** or number buttons to select specific disc, title, chapter or track.
- 3 Move the cursor with ► to the "Playlist" and press ▲/▼ to select the place you want to insert. The color of the row where the cursor is located will change.
- 4 Follow the procedure on the left to select the desired disc, title, chapter or track.
- 5 Select the Insert button on the screen and press **ENTER**. The new disc, title, chapter or track will be inserted before (above) the selected row.

■ To cancel memory play

Press **MEM** or ■ twice so that MEM. indicator goes off.

■ To clear memory

The memory is cleared when a disc is removed from the player, when the power is turned off, or when the player enters the standby mode.

Notes

- When you are finished adding values onto Playlist and want to return to play mode, select Done button and press **ENTER** on the remote controller.
- While a disc is playing, press **MEM** on the remote controller to start memory play.

Viewing Disc Information

DVD VCD CD

Using the On-screen Banner Display

The on-screen Banner Display contains many playback features. To see the Banner Display, press **ON SCREEN** on the remote controller while a disc is playing. Use **◀/▶** to move through the different features in the Banner Display. Each feature is illustrated with an icon.

■ To turn off the Banner Display

Press **ON SCREEN** or **CLR**.

Notes

- You can only access the banner display when you're playing a disc.
- The banner display features are only available if the disc was created with that particular feature (i.e., if you select the Subtitle icon, you won't be able to change the subtitle language unless the author of the disc created the disc with subtitles).
- The invalid symbol \otimes appears on the screen when you press a button that doesn't have any function. If one of the icons is "glayed out," the banner feature isn't available for the disc you're playing.
- Depending on the disc, pressing **AUDIO**, **ANGLE** or **SUBTITLE** may display a disc menu. For more details, refer to the instruction notes on the disc.

1

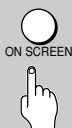

During playback, press **ON SCREEN**.

The Banner Display appears on the screen.

When playing a DVD

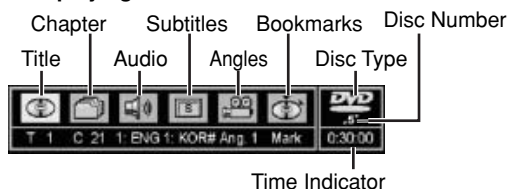

When playing a Video CD/CD

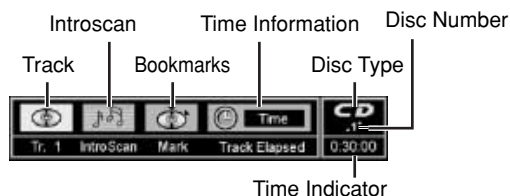

2

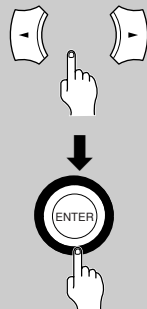

Press **◀/▶** to select a desired item, and press **ENTER**.

Corresponding menu appears on the screen.

Before operating the remote controller
Press **MODE DVD**.

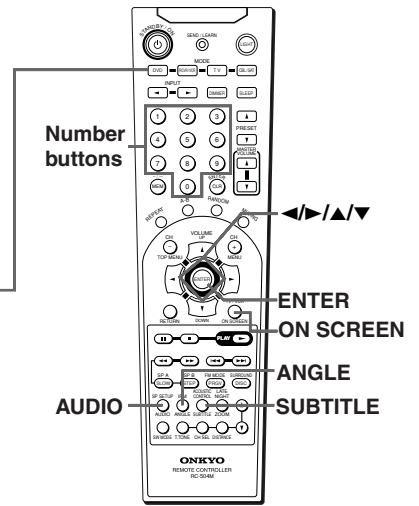





DVD

DVD VCD CD

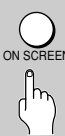
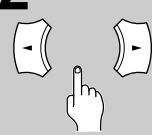
Selecting a Title

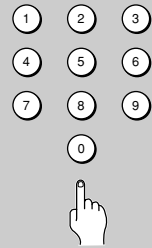
Some discs contain more than one title. For example, there might be four movies on one disc (each movie might be considered a title).



<p>1</p> 	<p>Press ON SCREEN.</p>
<p>2</p> 	<p>Press ◀/▶ until the TITLE icon is highlighted.</p>
<p>3</p> 	<p>Press ENTER. “T – –” appears.</p>
<p>4</p> 	<p>Press the number buttons to enter the title number. When you enter a one-digit title number, you may have to press ENTER on the remote controller after pressing the number (1~9) on the remote controller. Otherwise press 0 first and the other value. Then play starts. This varies depending on number of title within the disc you're playing.</p>

Notes

- Some discs only have one title.
- The invalid symbol ⊗ appears on the screen if the disc doesn't have the function.

Selecting a Chapter or Track

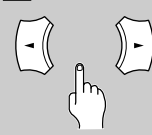
Because DVD discs use digital technology, a title can be divided into individual chapters (similar to tracks on a CD). You can skip a specific chapter by using the Chapter section in the Banner Display.

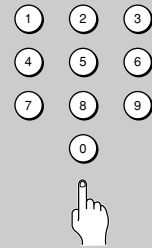
<p>1</p> 	<p>Press ON SCREEN.</p>
<p>2</p> 	<p>Press ◀/▶ until the CHAPTER or TRACK icon is highlighted.</p>
<p>3</p> 	<p>Press ENTER. “C – –” or “Tr. – –” appears.</p>
<p>4</p> 	<p>Press the number buttons to enter the chapter or track number. When you enter a one-digit chapter or track number, you may have to press ENTER on the remote controller after pressing the number (1~9) on the remote controller. Otherwise press 0 first and the other value. Then play starts. This varies depending on number of chapter or track within the disc you're playing.</p>

Notes

- The chapter feature won't work if the disc isn't formatted with separate chapters.
- The invalid symbol ⊗ appears on the screen if the disc doesn't have the function.

Selecting the Audio/ Subtitle Language

You can select the preferred audio language and sound system as a set from those included on the disc. This function lets you temporarily change the audio language and choose the sound system if the disc is recorded in more than one sound format. You can display subtitles on the TV screen and select a subtitle language from those included on the DVD-Video.

Before operating the remote controller
Press **MODE DVD**.

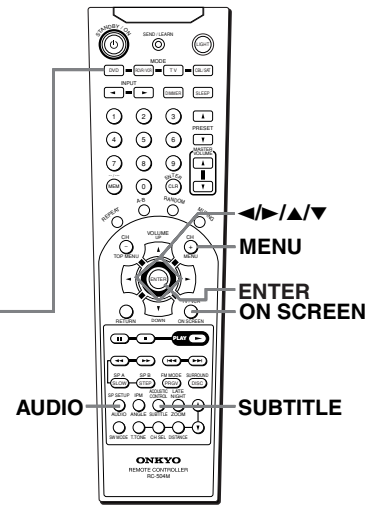

DVD

Selecting a Playback Audio Setting

1		Press ON SCREEN during playback.
2		Press ◀▶ until the AUDIO icon is highlighted.
3		Press ENTER. The audio menu appears.
4		Press ENTER to select the audio. Each time you press ENTER , the audio recording system set changes.

■ To turn off the audio menu

Press **ON SCREEN** or **CLR**.
The menu is switched off when no operation is performed for about 5 seconds.

■ Using AUDIO on the remote controller

- 1 Press **AUDIO** on the remote controller during playback.
- 2 Press **AUDIO** or **ENTER** to select the audio language.

Notes

- Dolby Digital 5.1 Channel sound may be displayed as "6ch. Dolby Digital".
- Before changing the setting, read through the explanation on "Enjoying the Sound Effects" on page 27 and carefully select the setting.
- Depending on the disc, it may be necessary to select the audio sound track using the DVD menu. When this is the case, press **MENU** to open the DVD menu and select the appropriate sound track as indicated on the DVD menu screen.
- When the DVD Changer Receiver is turned on or when the disc is changed, the audio settings are restored to the presets. In some cases, a language recorded on the disc may be given priority and selected automatically when the disc is loaded regardless of the setting.
- The invalid symbol ⊕ appears on the screen if the disc doesn't have the function.

DVD

Changing the Subtitle Language

1		Press ON SCREEN during playback.
2		Press ◀▶ until the SUBTITLE icon is highlighted.
3		Press ENTER. The subtitle menu appears.
4		Press ENTER to select the subtitle language. Each time you press ENTER , the subtitle language changes.
5		Press SUBTITLE to select subtitle on or off. Switching between display of subtitles and no display of subtitle is done each time the button is pressed.

■ To turn off the subtitle menu

Press **ON SCREEN** or **CLR**.
The menu is switched off when no operation is performed for about 5 seconds.

■ Using SUBTITLE on the remote controller

- 1 Press **SUBTITLE** on the remote controller during playback.
- 2 Press **SUBTITLE** to select subtitle on or off.
- 3 Press and hold **SUBTITLE** to enter into subtitle menu.

Notes

- When you turn on the DVD Changer Receiver or replace a disc, the unit returns to the automatic setting in the setting menu (see page 48). When you select a subtitle language which is not included on the disc, the DVD Changer Receiver plays the prior language programmed on the disc.
- During some scenes, the subtitles may not appear immediately after you change the subtitle setting.
- Some DVD-Video are set to display subtitles automatically, and you cannot turn them off even if you set the subtitle function to off.
- The invalid symbol ⊕ appears on the screen if the disc doesn't have the function.

Using the Banner Display



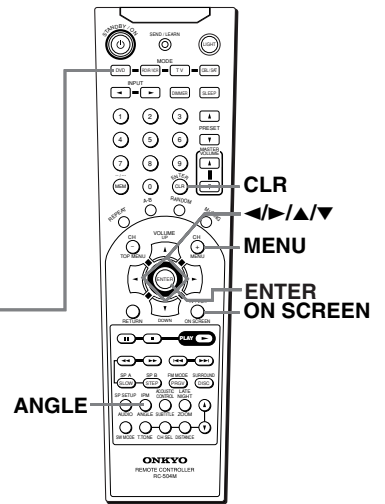

Before operating the remote controller
Press **MODE DVD**.

DVD

Changing the Camera Angle

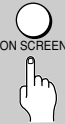
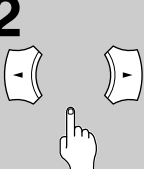

If the scene was recorded from multiple angles, you can easily change the camera angle of the scene you are watching.

<p>1</p> 	<p>Press ON SCREEN during playback.</p>
<p>2</p> 	<p>Press ◀/▶ until the Angle icon is highlighted.</p>
<p>3</p> 	<p>Press ENTER. The angle menu appears.</p> 
<p>4</p> 	<p>Press ENTER to select the angle. Each time you press ENTER, the angle changes.</p>

VCD CD

Using IntroScan Function

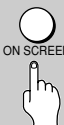
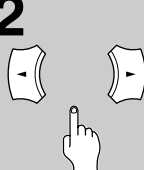
IntroScan plays the first 10 seconds of each track on the Video CD or CD similar to the scan feature that's on many car radios.

<p>1</p> 	<p>When playing a Video CD, press ON SCREEN to display the Banner Display. When playing a CD, the Banner Display appears on the screen automatically.</p>
<p>2</p> 	<p>Press ◀/▶ until the IntroScan icon is highlighted.</p>
<p>3</p> 	<p>Press ENTER. The INTRO indicator lights. The first 10 seconds of each track will be played. Press ▶ to stop IntroScan playback and start playing the current track entirely.</p>

Notes

- After IntroScan goes through all of the tracks, it stops.
- The invalid symbol ⊗ appears on the screen if the disc doesn't have the function.

■ To turn off the angle menu

Press **ON SCREEN** or **CLR**.

The menu is switched off when no operation is performed for about 5 seconds.

■ Using ANGLE on the remote controller

- 1 Press **ANGLE** on the remote controller during playback.
- 2 Press **ANGLE** or **ENTER** to select the camera angle.

Notes

- You can change the camera angle during still playback. The camera angle changes to the new setting when you resume normal playback.
- If you pause a picture immediately after changing the camera angle, the resumed playback picture may not use the new camera angle.
- The invalid symbol ⊗ appears on the screen if the disc doesn't have the function.

Using the Banner Display

Before operating the remote controller
Press **MODE DVD**.

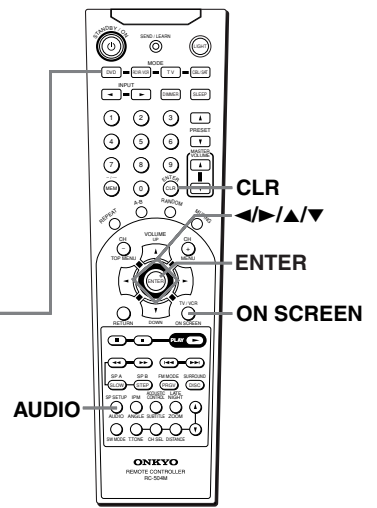







DVD VCD CD

Using a bookmark

The bookmark feature lets you mark a point on the disc that you can go to quickly. You can store up to 9 bookmarks.

■ Marking a scene

<p>1</p> 	<p>Press ON SCREEN during playback.</p>
<p>2</p> 	<p>Press <math>\blacktriangleleft</math> until the bookmark icon is highlighted and press ENTER The bookmark menu appears.</p>  <p>Exit icon</p>
<p>3</p> 	<p>Press <math>\blacktriangleup</math>/<math>\blacktriangledown</math> to move the cursor to the "Mark" parts of the bookmark menu.</p>
<p>4</p> 	<p>Press <math>\blacktriangleleft</math> to select the number you want to mark on.</p>
<p>5</p> 	<p>When you reach the scene you want to mark, press ENTER. The bookmark appears on under square. You can store up to 9 bookmarks by repeating this step.</p>

■ To return to the Banner Display

Press **\blacktriangleleft** to select the exit icon and press **ENTER**.







■ To clear the bookmark

The bookmark is cleared when a disc is removed from the DVD Changer Receiver or when the DVD Changer Receiver enters the standby mode.

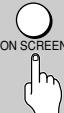
Notes

- If all 9 bookmarks are in use, you can still mark new scenes, but the previous bookmarks will be erased.
- Depending on the disc, the bookmark function may not work.

■ Recalling a bookmarked scene

<p>1</p> 	<p>Press ON SCREEN during playback.</p>
<p>2</p> 	<p>Press <math>\blacktriangleleft</math> until the bookmark icon is highlighted and press ENTER The bookmark menu appears.</p> 
<p>3</p> 	<p>Press <math>\blacktriangleup</math>/<math>\blacktriangledown</math> to move the cursor to the "Go To" parts of the bookmark menu.</p>
<p>4</p> 	<p>Press <math>\blacktriangleleft</math> to select the bookmarked scene you want to activate.</p>
<p>5</p> 	<p>Press ENTER to activate the bookmark.</p>

■ To turn off the bookmark menu

Press **ON SCREEN** or **CLR**.

Note

- The invalid symbol \ominus appears on the screen if the disc doesn't have the function.

MP3 Function

Before operating the remote controller
Press **MODE DVD**.

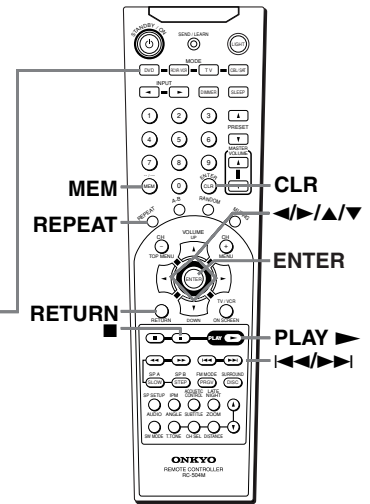

MP3 On-screen Display

■ Folders within a root

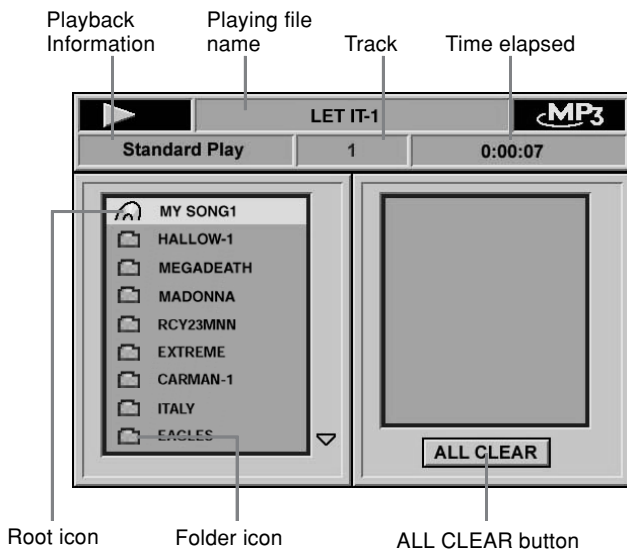

■ To display files within a folder

Press $\blacktriangle/\blacktriangledown$ to select the folder and press **ENTER**. The files within the folder display will appear.

■ Files within a folder and memory window

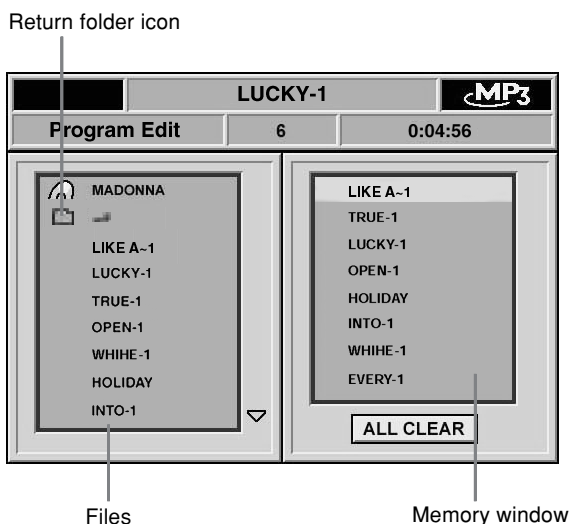

■ To move to the upper layer

Press $\blacktriangle/\blacktriangledown$ to select the return folder icon (📁) or press **RETURN**, then press **ENTER** to return to the upper layer.

Note

- Single-byte characters between A and Z, single-byte numerals between 0 and 9, and the single-byte underscore (_) can be displayed.

Playing Back MP3

The DVD Changer Receiver can play back MP3 files recorded on CD-R or CD-RW.



Press \blacktriangleright .

When you insert MP3 media, playback will start automatically.

MP3 On-screen display appears.



Note

- $\blacktriangle/\blacktriangledown$ indicates the content continues above or below the display.

■ To stop playback

Press \blacksquare .

■ To skip files

Press $\blacktriangleleft/\blacktriangleright$ during playback.

Notes



- It is not possible to play back folders and files that exceed the maximum limitations of the media (up to 223).
- A certain amount of time is required for the changer to confirm the media on which MP3 files have been recorded before playback will commence.
- The files will be played back in the sequence in which they were recorded (written).
- Fast reverse and Fast forward do not function when playing MP3.
- Random function is not available for MP3.

MP3 Function

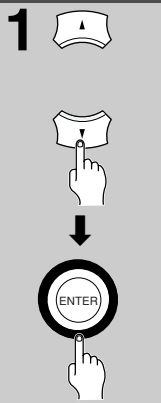

Selecting MP3 Files

You can select the files to be played back directly.

1  Press **▲/▼** to select the folder, then press **ENTER**.

2  Press **▲/▼** to select the file, then press **ENTER**.

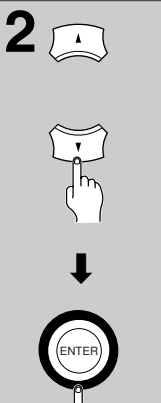
Playback will start from selected file.
Files in the next folder will be played back when no files exist in the selected folder.

■ To select the folders to be played directly

- 1 During stop mode, press **▲/▼** to select the folder, then press **ENTER**.
- 2 Press **▲/▼** to select the upper folder icon, then press **▶**. Playback will start from selected folder. Files in the next folder will be played back when no file exist in the selected folder.

MP3 Repeat Play

You can listen to the desired files repeatedly.



Press **REPEAT** repeatedly during playback.

Each time you press the button, playback information changes.

- Repeat All Disc Repeats all discs.
- ↓
- Repeat 1 Disc Repeats the entire disc.
- ↓
- Repeat 1 Folder Repeats the current folder.
- ↓
- Repeat Track Repeats the current track.
- ↓
- Standard Play Resumes normal playback.

■ To cancel repeat play

Press **REPEAT** or **■** so that the **REPEAT** indicator goes off or select "Standard Play".

Notes



- There is no A-B Repeat play function for MP3.
- You cannot use repeat playback for files programmed into memory.

MP3 Memory Play

You can listen to the files in any desired order.

1  During stop mode, press **MEM**.

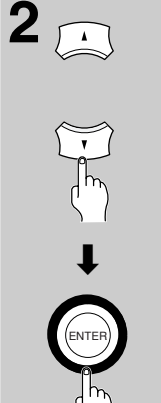
2  Press **▲/▼** to select the file, then press **ENTER**.

The selected file goes to memory window.
You can select maximum 1025.

3  Press **▶**.



■ To cancel memory play

Press **MEM** or **■** so that **MEM.** indicator goes off or select "Standard Play".

■ To delete memory

During stop mode, press **◀▶** to select the **ALL CLEAR** button, then press **ENTER**.
You can delete files one by one, by selecting them and pressing **CLR**.

Note

- The memory is cleared when a disc is removed from the changer or when the changer enters the standby mode.

Customizing the Settings

When you insert a DVD-Video the various functions of the DVD Changer Receiver will be set (reset) according to the setting menu. You can customize this setting menu according to your preferences.

Before operating the remote controller
Press **MODE DVD**.

DVD

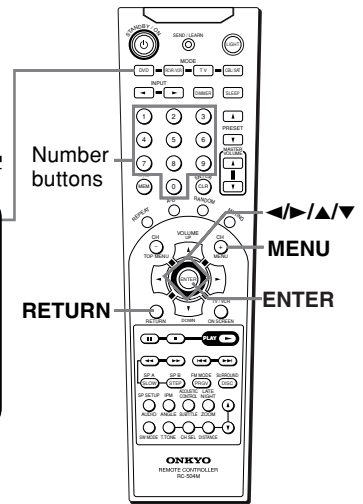

DVD

Making Adjustments to Setting

1



MENU

Press MENU during stop mode.

Current setup menu display appears.

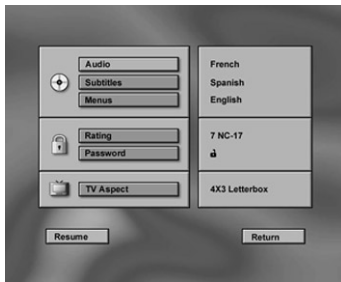

■ How to use RETURN

When **RETURN** is pressed, the display returns to the previous screen (stop mode).

2



Press ▲/▼ to select the item you want to change, then press ENTER.

3



Press ▲/▼ to change the setting, then press ENTER.

Further steps may be needed depending on the item or setting. Follow the steps described in the explanation of each item starting from page 48.

4

Repeat steps 2 to 3 to change the setting of other items.

5



MENU

Press MENU to turn off the setup menu display.

Customizing the Settings

DVD

Language Setting

■ Audio Language

This sets the language to be used when playing a disc. If a disc does not contain the selected language, it is played in the priority language set for each disc.

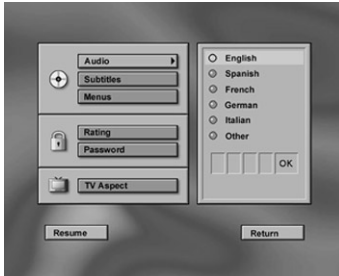

- English:** To play sound tracks in English.
Spanish: To play sound tracks in Spanish.
French: To play sound tracks in French.
German: To play sound tracks in German.
Italian: To play sound tracks in Italian.
Others: To make a further choice, follow steps 1 - 3 below.

- 1 Select "Other" and press **ENTER**.
- 2 Press the number buttons to enter the 4-digit code listed on the next page.
- 3 Select OK button and press **ENTER**.

Note

- Depending on the disc, a language recorded on the disc may be given priority and selected automatically when the disc is loaded regardless of the setting.

■ Subtitle Language

This sets the language to be used when playing a disc. If a disc does not contain the selected language, it is played in the priority language set for each disc.



- English:** To display subtitles in English.
Spanish: To display subtitles in Spanish.
French: To display subtitles in French.
German: To display disc subtitles in German.
Italian: To display subtitles in Italian.
Others: To make a further choice, follow steps 1 - 3 below.

- 1 Select "Other" and press **ENTER**.
- 2 Press the number buttons to enter the 4-digit code listed on the next page.
- 3 Select OK button and press **ENTER**.

Notes

- Some DVD-Video may be set to display subtitles in a different language than you selected. A prior subtitle language may be programmed on the disc.
- Some DVD-Video allow you to change subtitle selections only via the disc menu. If this is the case, press **TOP MENU** or **MENU** and choose the appropriate subtitle language from the selection on the disc menu.
- Instruction notes of discs may refer to the button that displays the top menu as title button.

■ Menu Language

This sets the initial setup of language as well as the language used in on-screen messages such as "PLAY".

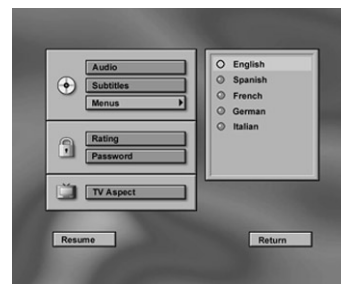

- English:** To display disc menus in English.
Spanish: To display disc menus in Spanish.
French: To display disc menus in French.
German: To display disc menus in German.
Italian: To display disc menus in Italian.

Note

- Some DVD-Video may not include your pre-selected language. In this case, the DVD Changer Receiver automatically displays disc menus consistent with the disc's initial language setting.

Table of Languages and Their Code No.

Code No.	Language
6566	Abkhazian
6565	Afar
6570	Afrikaans
8381	Albanian
6577	Ameharic
6582	Arabic
7289	Armenian
6583	Assamese
6588	Aymara
6590	Azerbaijani
6665	Bashkir
6985	Basque
6678	Bengali; Bangla
6890	Bhutani
6672	Bihari
6673	Bislama
6682	Breton
6671	Bulgarian
7789	Burmese
6669	Byelorussian
7577	Cambodian
6765	Catalan
9072	Chinese
6779	Corsican
7282	Croatian
6783	Czech
6865	Danish
7876	Dutch
6978	English
6979	Esperanto
6984	Estonian
7079	Faroese
7074	Fiji
7073	Finnish
7082	French
7089	Frisian
7176	Galician
7565	Georgian
6869	German
6976	Greek
7576	Greenlandic
7178	Guarani
7185	Gujarati
7265	Hausa
7387	Hebrew
7273	Hindi

Code No.	Language
7285	Hungarian
7383	Icelandic
7378	Indonesian
7365	Interlingua
7369	Interlingue
7375	Iunpiak
7165	Irish
7384	Italian
7465	Japanese
7487	Javanese
7578	Kannada
7583	Kashmiri
7575	Kazakh
8287	Kinyarwanda
7589	Kirghiz
8278	Kirundi
7579	Korean
7585	Kurdish
7679	Laothian
7665	Latin
7686	Latvian, Lettish
7678	Lingala
7684	Lithuanian
7775	Macedonian
7771	Malagsy
7783	Malay
7776	Malayalam
7784	Maltese
7773	Maori
7782	Marathi
7779	Moldavian
7778	Mongolian
7865	Naru
7869	Nepali
7879	Norwegian
7967	Occitan
7982	Oriya
7977	Oromo (Afan)
8065	Panjabi
8083	Pashto, Pushto
7065	Persian
8076	Polish
8084	Portuguese
8185	Quechua
8277	Rhaero-Romance
8279	Romanian

Code No.	Language
8285	Russian
8377	Samoan
8371	Sangho
8365	Sanskrit
7168	Scots Gaelic
8382	Serbian
8372	Servo-Groatian
8384	Sesotho
8478	Setswana
8378	Shona
8368	Sindhi
8373	Singhalese
8383	Siswati
8375	Slovak
8376	Slovenian
8379	Somali
6983	Spanish
8385	Sundanese
8387	Swahili
8386	Swedish
8476	Tagalog
8471	Tajik
8465	Tamil
8484	Tatar
8469	Telugu
8472	Thai
6679	Tibetan
8473	Tigrinya
8479	Tonga
8483	Tsonga
8482	Turkish
8475	Turkmen
8487	Twi
8575	Ukrainian
8582	Urdu
8590	Uzbek
8673	Vietnamese
8679	Volapuk
6789	Welsh
8779	Wolof
8872	Xhosa
7473	Yiddish
8979	Yoruba
9085	Zulu

Customizing the Settings

DVD

Operation Setting

Rating / Parental lock

This can restrict playback of adult-oriented DVD discs that you do not want to be seen by children.

However, even when a DVD disc is marked "Adult-oriented" or otherwise on the label, its viewing cannot be restricted unless the restriction level is recorded in the disc itself.

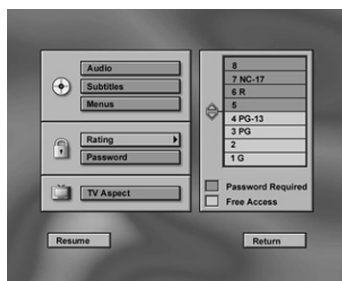

You cannot play DVD Video rated higher than the level you selected unless you cancel the parental lock function.

For example, when you select level 7, discs rated higher than level 7 are locked out and cannot be played.

The Rating level is equivalent to the following U.S. movie ratings.

Level 7: NC-17

Level 6: R

Level 4: PG-13

Level 3: PG

Level 1: G

Notes

- DVD-Video may or may not respond to the parental lock setting. This is not a defect in the DVD Changer Receiver. Make sure this function works with your DVD-Video.
- When the password already has been set, the screen for change of the entered password will be displayed. In that case, enter the password (See "Password" below).

Password

The password for rating setting, change, cancellation, etc. is set.

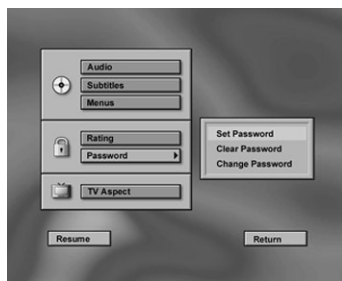

To input password

- 1 Select "Set Password".
- 2 Press the number buttons to enter password.

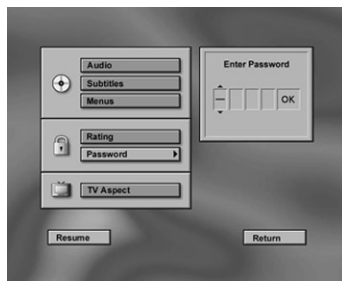

- 3 Select OK button and press **ENTER**. Confirm Password display appears below Enter Password display.

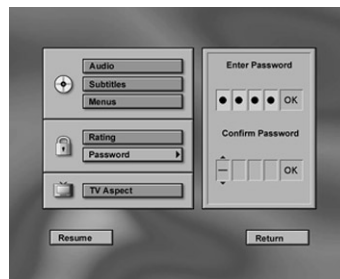

- 4 Press the number buttons to enter password.

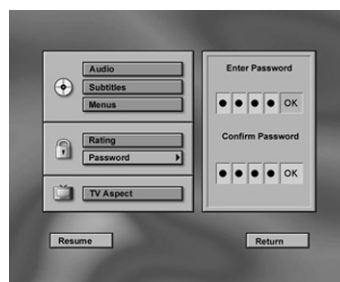

- 5 Select OK button and press **ENTER**.

Note

- Be sure not to forget your password. If you should forget it, remove all discs from the tray and close it. In DVD mode, press **▶**, **◀**, **▼**, **▲** in order on the remote controller, then quickly hold down the **◀◀** button on the unit then press the **STANDBY/ON** button twice for reset.

To change password

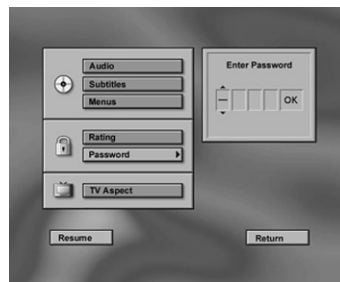

- 1 Press the number buttons to enter password.
- 2 Select OK button and press **ENTER**. Password setup menu appears.

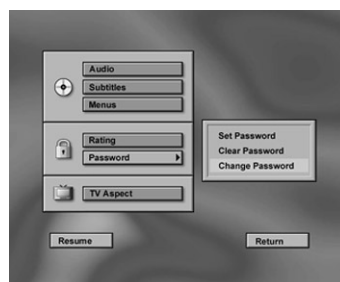

- 3 Select "Change Password". Enter Password menu appears.
- 4 Press the number buttons to enter new password.

Picture Setting

- 5 Select OK button and press **ENTER**.
Confirm Password display appears below Enter Password display.

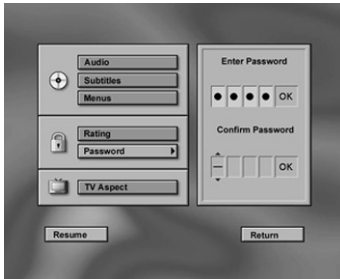

- 6 Press the number buttons to enter new password.

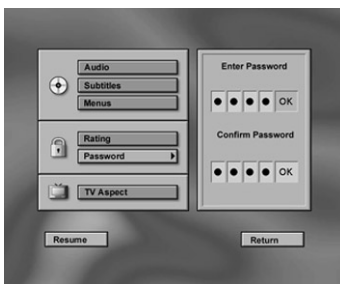

- 7 Select OK button and press **ENTER**.

To clear password

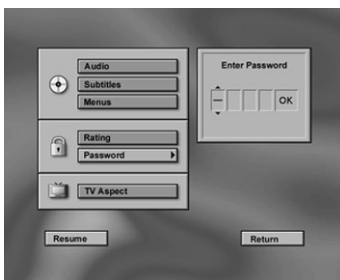

- 1 Press the number buttons to enter password.
2 Select OK button and press **ENTER**.
Password setup menu appears.

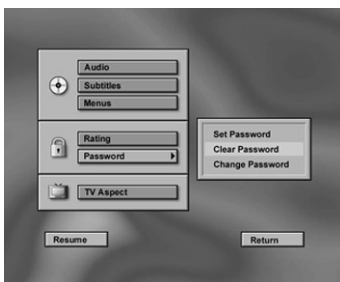

- 3 Select "Clear Password" and press **ENTER**.

■ TV Aspect

This sets the screen size (4:3 or 16:9 aspect ratio) according to the connected TV.

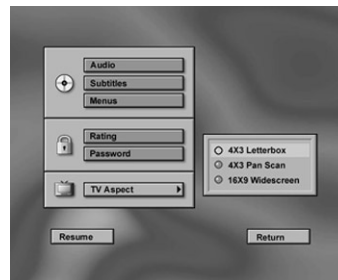

4 x 3 Letterbox:



Choose this setting if you would prefer to see movies in their original aspect ratio. You will see the entire frame of the movie, but it will occupy a smaller portion of the screen. This setting may result in the movie appearing with black bars at the top and bottom of the screen.

4 x 3 Pan Scan:



Choose this setting if you want the movie to fill the entire screen of your TV. You won't see part of the picture (particularly the right and left edge). Some disc produced in a wide screen format can't be cropped in this fashion, which means the black bars would appear at the top and bottom of the screen.

16 x 9 Widescreen:



Choose this setting if your DVD Changer Receiver is connected to a widescreen TV.

Notes

- The displayable picture size is preset on each DVD-Video. Therefore, the playback picture of some DVD-Video may not conform to the picture size you select.
- When you play a DVD-Video recorded in the 4:3 picture size only, the playback picture always appears in the 4:3 picture size regardless of the TV shape setting.
- If you select "16:9 Widescreen" and you own a 4:3 TV set, the DVD playback picture will be horizontally distorted during playback. Images will appear to be horizontally compressed. Make sure the TV Shape conforms to the actual TV in use.

Listening to the Radio

There are two ways to select radio stations:

- Tuning manually
- Presetting radio stations then selecting the preset stations

Note

- 10 AM and FM stations have already been preset. You can change these according to your preference.

Before operating the remote controller
Press **MODE RCVR/VCR**.

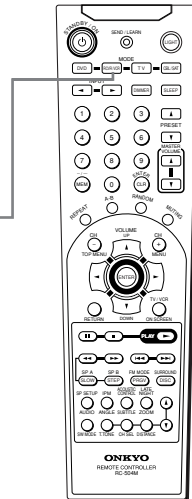



Tuning Manually

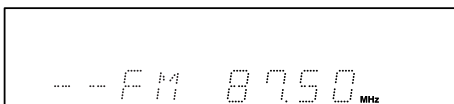

Press **INPUT** ◀▶ repeatedly to select the band (FM or AM).

e.g. When FM is selected.



Note

- You can also select the band with the remote controller. See next page.



Press and hold **TUNING/PRESET** ◀▶▶▶ for about 0.5 seconds.

Auto tuning starts. The tuner frequency changes 0.1 MHz for FM and 10 kHz for AM.

When a broadcast is received, scanning stops and the frequency flashes in the display.

Appears when a broadcast is received.

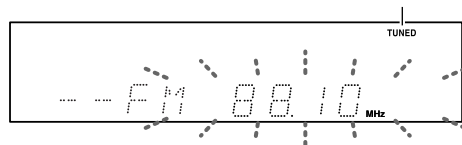

• Manual tuning

The frequency changes until the **TUNING/PRESET** ◀▶▶▶ is pressed repeatedly.



While the frequency is flashing (for about 5 seconds), press **TUNING/PRESET** ◀▶▶▶ to change the frequency.

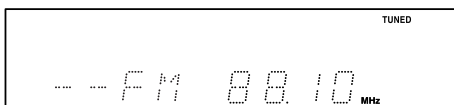

- The frequency changes each time you press **TUNING/PRESET** ◀▶▶▶.
- You can change the frequency as long as the frequency in the display is flashing. Each press of either button causes the frequency to flash for about 5 seconds.

Tuning in a weak frequency (only for FM stations)

When you tune in a stereo FM station, the **ST** indicator lights up if the signal is sufficiently strong.



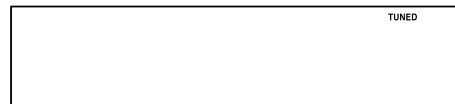

If the signal is weak, you may not be able to tune to the station. In this case, press **FM MODE**. The **ST** indicator and **AUTO** indicator goes off. Then select the station to which you want to listen. (At this time, the station will be monaural and interstation noise will be heard.)

Remote Controller Only

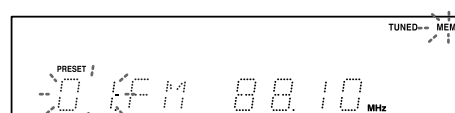

Presetting Radio Stations

You can preset up to 30 stations.

1	<p>Tune in the radio station you wish to preset (see steps in the left column of this page).</p>
2 Unit only	<p>Press PRESET MEMORY.</p> <p>The MEM. indicator lights and the preset number starts flashing in the display.</p>  
3	<p>While the MEM. indicator is lit (for about 8 seconds), press TUNING/PRESET ◀▶▶▶ to select the preset number.</p> 
4	<p>Press PRESET MEMORY.</p> <p>The radio station is registered to the preset channel.</p> <p>To register another preset station, repeat steps 1 to 4.</p> 

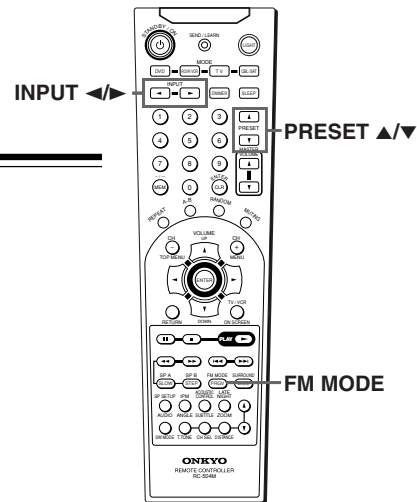
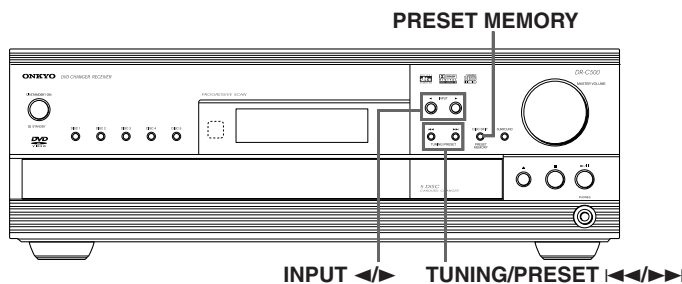

Selecting Preset Stations

Before selecting preset stations, you need to preset the radio stations. See “Presetting Radio Stations” on the previous page.

<p>1 Remote controller</p> <p>Unit</p>	<p>Press INPUT ◀▶ on the remote controller or the unit to switch the input source to the FM or AM. The band selected in this step will not affect the next step.</p>
<p>2 Remote controller</p> <p>Unit</p>	<p>Press PRESET ▲/▼ on the remote controller or TUNING/PRESET ◀▶▶▶ on the unit repeatedly to select the preset number of the desired radio station.</p> <p>Note</p> <ul style="list-style-type: none"> If you press TUNING/PRESET ◀▶▶▶ on the unit for more than 0.5 seconds, the unit enters the manual tuning mode. See step 2 in “Tuning Manually” on the previous page.

Erasing a Preset Station

<p>1</p>	<p>Select the preset channel you wish to erase (see steps in the left column of this page).</p>
<p>2 Unit only</p>	<p>Press PRESET MEMORY. “ERASE” appears in the display.</p>
<p>3</p>	<p>While “ERASE” is displayed (for about 8 seconds), press PRESET MEMORY again. The selected preset channel will be erased.</p>

Playing the Connected Source

This section shows you how to play the sources connected to the DVD Changer Receiver.

You may need to see "Connecting to a TV" on page 15 and "Connecting to Audio/Video Equipment" on page 18 and 19 while following the steps in this section.

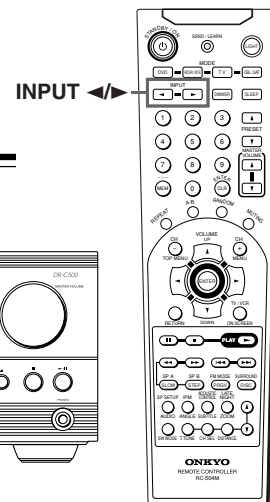
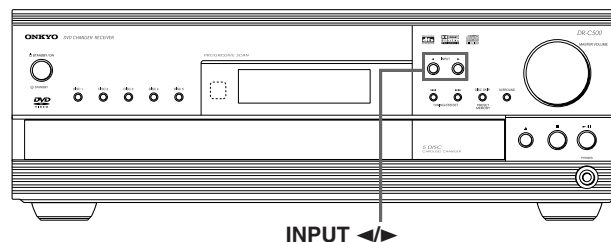

Starting Playback

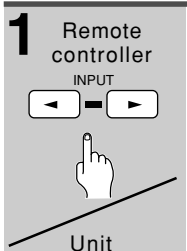

Press **INPUT** ◀▶ on the remote controller or the unit to select one of the following input sources:

- VIDEO 1
- VIDEO 2
- TV/LINE
- TAPE/CD-R

The selected input source appears in the multipurpose display. Also the input source indicator is lit in the display until the DVD Changer Receiver is switched to another input source.

e.g., When VIDEO 1 is selected.

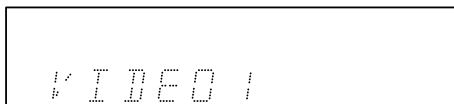

2

Start playing the selected source.

About digital sound

If the equipment is digitally connected to the DVD Changer Receiver, the sound from the digital input will automatically be selected and reproduced instead of the analog sound as explained below.

- When the VIDEO 1 source is selected, the digital sound from the DIGITAL IN VIDEO 1 OPTICAL jack is reproduced.
- When the VIDEO 2 source is selected, the digital sound from the DIGITAL IN VIDEO 2 COAXIAL jack is reproduced.

When the digital sound is reproduced, the DIGITAL indicator lights up in the display. According to the received sound system, the DIGITAL or DTS indicator lights up.

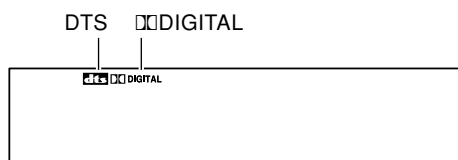

Note

- The DVD Changer Receiver only reproduces DOLBY DIGITAL, DTS, and PCM sound formats from connected equipment.

Enjoying the picture with the sound of another source

Play the VIDEO 2 source and select TV/LINE, TAPE/CD-R, FM or AM. Then you can enjoy the VIDEO 2 picture and the sound from the selected input source at the same time.

Various Functions While Playing the Connected Source

To use the following functions, see pages 31 and 32.

- Turning on/off the SPEAKERS A/SPEAKERS B Systems
- Adjusting the Volume
- Muting the Sound
- Listening Through Headphones
- Controlling the Brightness of the display on the DVD Changer Receiver
- Using the Sleep Timer

Enjoying the Sound Effects While Playing the Connected Source

See page 27.

Recording Using the Connected Equipment

You can record according to the following using the connected recording equipment:

- Sound/picture of discs played back by the DVD Changer Receiver,
- Sound of FM/AM programs, and
- Sound/picture of the connected source.

Note

- Many discs and sources are copy protected. Copy protected sources are impossible to record.

Basic Recording Procedure

1	Set the recording equipment (MD recorder, DAT, Cassette tape deck, VCR, DVD recorder, CD recorder, etc.) to recording pause.
2	Select the input source to be recorded, then set it to play pause. <ul style="list-style-type: none">• To play and pause a DVD video, Video CD, or audio CD, see page 33.• To select an FM/AM program, see page 52.• To select a connected source, see page 54. Refer to the manuals of the connected source equipment for instructions on how to play and pause.
3	Release the recording pause set in step 1 to start recording.
4	Start playback of the selected source in step 2.

Notes

- If you select another input source during recording, the selected source will be recorded.
- Sound effects described on pages 27 to 30 do not affect the recorded sounds.

■ Recording the Picture and Sound from Different Sources at the Same Time

The picture from the playing VIDEO 2 source is output through the VIDEO 1 OUT jacks when you select any audio source (TAPE/CD-R, FM or AM) or TV/LINE.

Play the VIDEO 2 source and select TAPE/CD-R, FM, AM or TV/LINE, then you can record the picture from the VIDEO 2 source and the sound from the selected input source at the same time, using the recording equipment connected to the VIDEO 1 jacks.

■ Digital recording from the source connected to the digital input connectors to the digital recording equipment connected to the digital output connector

The digital input connectors are as follows:

- The DIGITAL IN VIDEO 1 OPTICAL connector, and
- The DIGITAL IN VIDEO 2 COAXIAL connector.

The digital output connector is the DIGITAL OUT OPTICAL connector.

Recording digital sound signals from sources connected to the digital input connectors using digital recording equipment connected to the digital output is possible unless:

- The recording is against SCMS (Serial Copy Management System) rules (for details of SCMS rules, refer to the manual of the digital recording equipment),
- The digital signals are in bitstream format (the recordable digital signal format is PCM — two channel digital stereo sound signals), or
- The sampling frequency is out of the recordable range of the recording equipment (for recordable sampling frequency, refer to the manual of the digital recording equipment). Note that the maximum signal frequency output from the DVD Changer Receiver is 48 kHz.

■ Analog recording from a DVD Video played using the DVD Changer Receiver

The digital sound signals are converted to analog signals and output to the analog output jacks unless the DVD video is recorded in the DTS Surround.

Although the speakers can reproduce DTS Surround sounds, DTS signals are not output to the analog output jacks.

Controlling other components connected to the DVD Changer Receiver



The remote controller has two learning functions. One is entering the signal number for a remote controller of another brand that is pre-programmed. Another is a normal learning function that enables the remote controller to learn the codes from other remote controllers.

Caution

- With some brand's components, some buttons may not work correctly. In this case, program the command separately.

Learning a Pre-programming Code

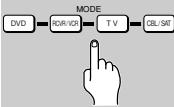
By learning a pre-programming code, you can make the RC-504M remote controller able to operate a product from another brand. The buttons that are used for operation are given on the next page.

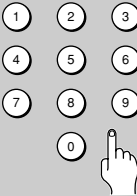
1	<p>Find the 3-digit number for the brand name of the component that you want to operate in the table on the next page.</p>
2	<p>Turn on the component that you want to operate (i.e., satellite tuner, or television).</p>
3	<p>While holding down the MODE button on the RC-504M that you want to program, press the --/-- button, and then release both buttons.</p>  <p>The SEND/LEARN indicator lights when the MODE button is pressed and turns off when the --/-- button is pressed. Wait until the indicator turns off before releasing both buttons. Then the SEND/LEARN indicator lights again.</p> 
4	<p>Within 30 seconds, enter the 3-digit code number.</p>  <p>The SEND/LEARN indicator flashes twice slowly. If the SEND/LEARN indicator quickly flashes three times, then either a mistaken 3-digit code was entered or an incorrect operation was performed. If this occurs, return to step 3.</p>
5	<p>Press the button that you programmed and check if the system operates correctly.</p> <ul style="list-style-type: none"> • If the component does not operate properly, return to step 3 and repeat the steps above. • If it still does not operate properly, then program the commands one by one to the buttons on the RC-504M remote controller.

Pre-programming Codes

VCR

BRAND	SETTING No.	BRAND	SETTING No.
AIWA	302, 329, 333, 424, 440	NOKIA	313
AKAI	303, 304, 305, 306, 307, 357, 383	NORDMENDE	368, 369, 370
BAIRD	308	OKANO	371, 372
BELL & HOWELL	309	ORION	319, 322, 373, 430, 437
BLAUPUNKT	310	PANASONIC	352, 374, 375, 376, 377, 378, 427, 435
CGM	311, 312, 313	PHILIPS	352, 353, 379, 380, 397
COLTINA	314	PHONOLA	311
DAEWOO	315, 316, 394, 425, 439	PIONEER	343, 381
DIGITAL	317	RCA	305, 330, 352, 382, 386, 396, 427, 431
EMERSON	315, 318, 319, 320, 321, 322, 333, 356, 357, 429, 430, 432, 433, 434, 437, 439	REALISTIC	309, 326, 327, 329, 333, 352, 396, 397, 426
FENNER	323	SABA	383
FISHER	309, 324, 325, 326, 327	SAMSUNG	384, 385, 386, 387, 388, 389, 390
FUJITSU GENERAL	328	SANYO	309, 327, 386, 391, 392, 393, 426
FUNAI	329	SCOTT	356, 394, 429, 430, 434
GE	330, 331, 352, 386, 396, 431	SELECO	395
GO VIDEO	332, 336, 337, 438	SHARP	396, 397, 398, 399
GOLDSTAR	365	SHINTOM	400
GOODMANS	335	SIEMENS	401
GRUNDIG	338	SONY	329, 352, 402, 403, 404, 405, 406, 407, 408, 409, 410, 411, 412, 413, 423
HITACHI	329, 331, 339, 340, 341, 382, 383, 428	SYMPHONIC	329, 414
JVC	342, 343, 344, 345, 346, 347, 348, 349, 350, 383	TEKNIKA	329, 333, 352, 414, 415
LOEWE	351, 352	TELEFUNKEN	416, 417
MAGNAVOX	329, 331, 352, 353, 354, 355, 380, 422	TOSHIBA	326, 356, 394, 418, 419, 420, 434
MITSUBISHI	343, 356, 357, 358, 359, 360, 361, 362, 363, 364, 396	WATSON	421
NEC	309, 343, 365, 366, 367, 383	WHITE WESTINGHOUSE	315, 333
		ZENITH	329, 402, 403, 422

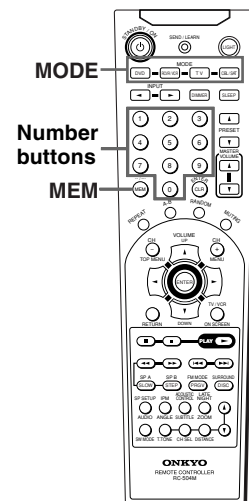

TV

BRAND	SETTING No.	BRAND	SETTING No.
AIWA	100, 101	LG	245
AKAI	102, 103, 104	LUXOR	161
AUDIOSONIC	105	MAGNAVOX	002, 008, 102, 106, 162, 163, 234, 235, 236, 247, 254
BELL & HOWELL	106, 132, 231	MARANTZ	102, 162, 164
BLAUPUNKT	107	MARK	165
BRIONVEGA	108, 109	MATSUI	166, 167, 168, 169
CENTURION	110	mitsubishi	150, 170, 171, 172, 173, 216, 252
CITIZEN	102, 117, 159, 202, 240, 241, 245, 254	MIVAR	174, 175
COLTINA	111, 112, 113	NEC	102, 176, 177, 245
CORONAD	114	NOKIA	178, 179, 180, 181
CROWN	115, 116, 126, 240	NORDMENDE	182, 183
DAEWOO	004, 005, 102, 117, 118, 119, 120, 121, 240	OKANO	152
EMERSON	004, 005, 102, 106, 123, 124, 125, 126, 127, 132, 159, 239, 240, 251, 252, 253	ORION	106, 123, 127, 184, 185, 186
FENNER	128, 129	PANASONIC	139, 187, 188, 189, 190, 244
FERGUSON	130, 131	PENNEY	102, 139, 200, 202, 213, 233, 237, 238, 240, 242, 254, 252
FISHER	132, 250	PHILIPS	152, 162, 191
FUJITSU GENERAL	136, 137, 138	PIONEER	239
FUNAI	126, 133, 134, 135, 224	PROSCAN	194, 242
GE	119, 125, 139, 140, 141, 216, 237, 242, 244, 252	QUASAR	139, 187, 195, 196, 244
GOLDSTAR	102, 142, 143, 238, 245, 252	RADIO SHACK	102, 126, 132, 196, 238, 240, 242, 245, 252
GOODMANS	144	RCA	110, 139, 141, 197, 198, 199, 200, 216, 239, 242, 246
HITACHI	147, 148, 149, 150, 238, 239, 245	SABA	182, 183, 201
HYPHER	151	SAMSUNG	102, 202, 203, 204, 205, 206, 207, 208, 238, 245, 252
INNO HIT	152	SANYO	132, 209, 210, 211, 212, 249, 250
IRRADIO	103		
JVC	153, 154, 155, 156, 157		
KENDO	158		
KTV	102, 126, 159, 160, 240, 253		

TV

BRAND	SETTING No.	BRAND	SETTING No.
SCHNEIDER	103	SYMPHONIC	224, 225
SEARS	106, 132, 162, 213, 224, 242, 245, 249, 250, 252	TELEFUNKEN	201, 226, 227, 245
SELECO	214, 215	TOSHIBA	132, 202, 213, 229
SHARP	002, 196, 216, 217, 240	UNIVERSUM	230
SONY	218, 219, 220, 221, 222, 223	ZENITH	117, 231, 232

CABLE

BRAND	SETTING No.
GENERAL INSTRUMENT	815, 817
HAMLIN	808, 814
JERROLD	802, 804, 815, 817, 822
MACOM	810
OAK	807
PANASONIC	809, 812, 825
PIONEER	813, 820
SAMSUNG	813
SCIENTIFIC ATLANTA	818, 821, 823
TOCOM	804, 805
TOSHIBA	825
ZENITH	819, 824, 825

SATELLITE

BRAND	SETTING No.
ALBA	844, 851, 883, 897, 938, 942, 944, 947
BUSH	851, 875, 880, 883, 897, 904, 933
ECHOSTAR	843, 848, 874, 877, 892, 893, 899, 913
FERGUSON	872, 875, 879, 880, 890, 891, 894, 904, 933, 935, 938
HITACHI	933, 938
KATHREIN	860, 907, 908, 917, 918, 923, 927, 937, 939, 941, 945, 947
PANASONIC	858
PHILIPS	846, 859, 860, 981
SONY	978, 979
TOSHIBA	980

Note

- If more than one code is given in the table, try the code one by one until you reach the code for your component (i.e. if the first code does not work, then try the next).

Controlling other components connected to the DVD Changer Receiver

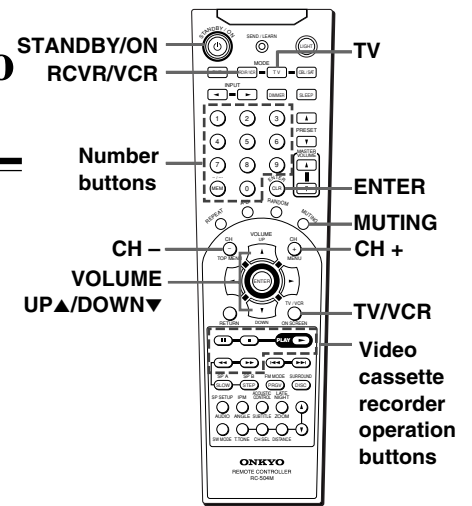

Controlling VCR

- 1**  **Press the MODE RCVR/VCR button.**
The RCVR/VCR button lights green.
- 2** **Press the desired operation button.**
The buttons indicated in the figure to the right are the operation buttons that can be used to control your VCR.

The buttons given below have operations programmed into them.

- STANDBY/ON:** Turns the VCR on and off
- CH +/-:** Moves up and down the preset channel numbers
- ▶:** Play
- :** Stop
- ◀◀:** Rewind
- ▶▶:** Fast Forward
- ||:** Pause
- 0,1 to 9, --/---:** Number buttons
- ENTER:** Enter
- TV/VCR:** Select the input source between TV or VCR

You may also use the rest of the buttons to operate the Receiver in this mode.

Controlling TV

- 1**  **Press the MODE TV button.**
The TV button lights green.
- 2** **Press the desired operation button.**
The buttons indicated in the figure to the right are the operation buttons that can be used to control your television.

The buttons given below have operations programmed into them.

- STANDBY/ON:** Turns the TV on and off
- CH +/-:** Moves up and down the television channels
- 0,1 to 9, --/---:** Number buttons
- ENTER:** Enter
- VOLUME ▲/▼:** Adjusts the volume at the television
- MUTING:** Activates the muting function at the television
- TV/VCR:** Select the input source between TV or VCR

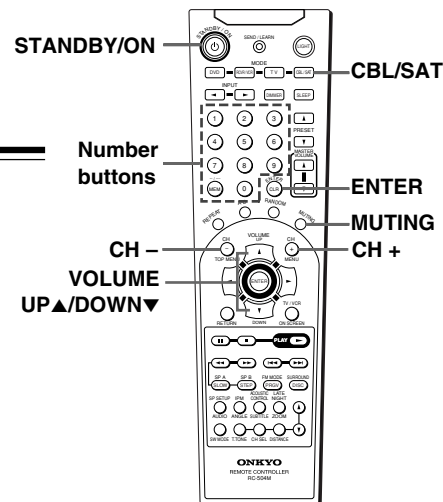

Controlling Cable/Satellite

- 1**  **Press the MODE CBL/SAT button.**
The **CBL/SAT** button lights green.
- 2** **Press the desired operation button.**
The buttons indicated in the figure above are the operation buttons that can be used to control your Cable/Satellite.

The buttons given below have operations programmed into them.

- STANDBY/ON:** Turns the Cable/Satellite on and off
- CH +/-:** Moves up and down the Cable/Satellite channels
- 0,1 to 9, --/---:** Number buttons
- ENTER:** Enter
- VOLUME ▲/▼:** Adjusts the volume at the Cable
- ▲/▼/◀/▶:** Cursor buttons for Satellite
- MUTING:** Activates the muting function for Cable/Satellite

Controlling other components connected to the DVD Changer Receiver

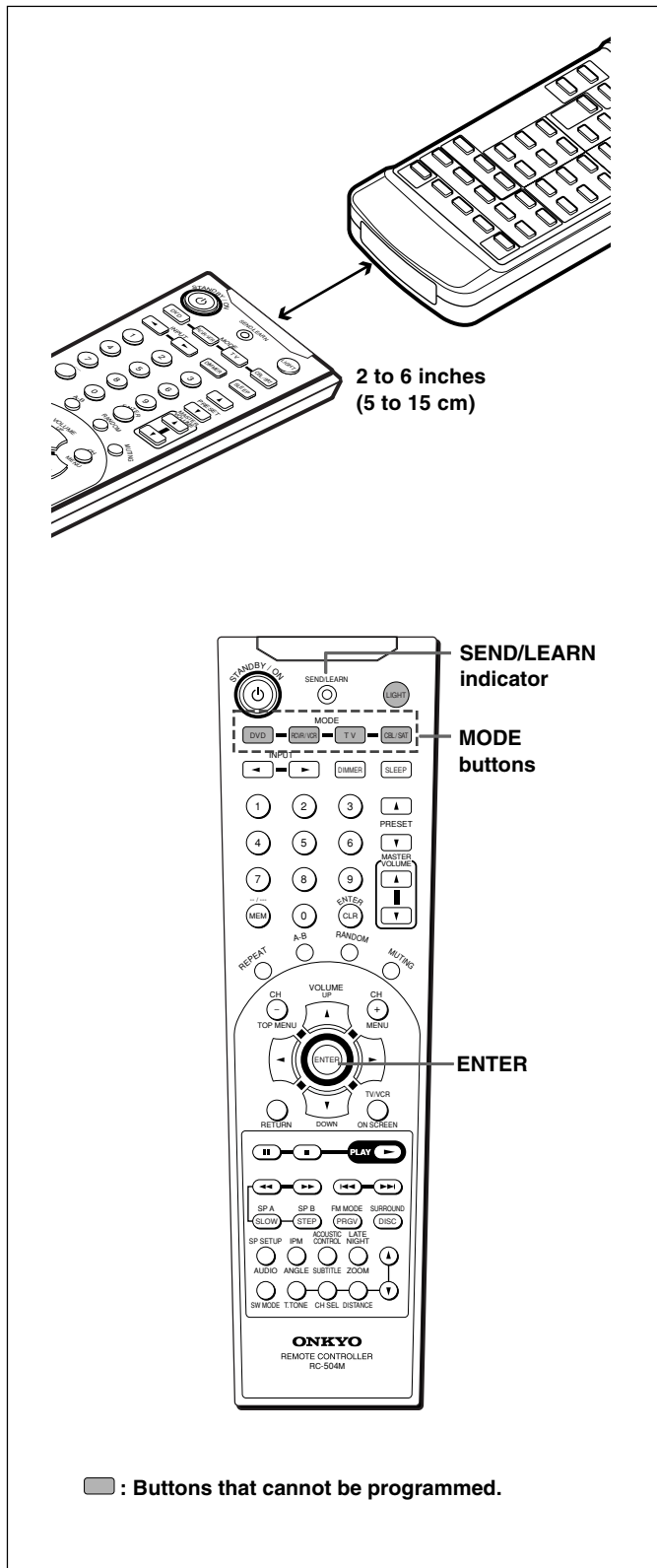

Programming the commands of remote controllers for other devices into the remote controller

When programming the commands of another remote controller to the RC-504M remote controller, you must first decide under which **MODE** button you want the commands to be linked. In general, you will select the **MODE** button that corresponds to the component you are programming. After programming which **MODE** button to use, you will then transfer the separate commands from the other remote controller over to the RC-504M remote controller one at a time. Each command is then programmed to a different button on the RC-504M remote controller. Any button is programmable for this step except for the four **MODE** buttons (**DVD**, **RCVR/VCR**, **TV**, **CBL/SAT**).

Even after the commands have been memorized, keep your old remote controller in a safe place. If for some reason the commands are lost (e.g., when the batteries run down), it will be necessary to memorize them once again.

- 1** Place the remote controller and the remote controller for the other device facing each other at a distance of 2 to 6 inches (5 to 15 cm) apart.
- 2** While pressing and holding down the desired **MODE** button on the remote controller, press the **ENTER** button and then release both buttons.

When you press and hold down the **MODE** button, the SEND/LEARN indicator lights. When you press the ENTER button, the lamp turns off. When you release the buttons, the lamp lights again.
- 3** Press and release the button on the remote controller which you want to be programmed.

You may select any button except the **MODE** buttons. When you press the button, the SEND/LEARN indicator turns off. When you release the button, the indicator lights again.

If you press the wrong button by mistake, press that same button again. The SEND/LEARN indicator flashes twice, and the remote controller exits the programming mode.

4 Press and hold down the button (that corresponds to the command you are programming) on the remote controller of the other device until the SEND/LEARN indicator on the remote controller flashes twice.

After flashing twice, the SEND/LEARN indicator will light again.

5 Repeat Steps 3 and 4 to transfer all the commands you desire from the other remote controller and program them to buttons on the remote controller under the same MODE.

Repeat steps 2 through 4 to program commands to a different MODE (e.g., when programming from a different remote controller).

6 Press the MODE button that you pressed in step 2 to complete the programming.

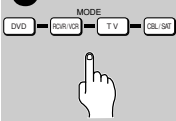

7 Operate the newly programmed buttons to make sure the learning function was performed properly.

Notes:

- The remote controller has 220 memory slots (4 modes x 55 buttons). Some remote controllers may have more commands that can be remembered by the remote controller. In such cases, it will be necessary for you to determine which commands are more important than others. (According to the type of the remote controller, 220 commands cannot be programmed.)
- If no button is pressed for more than 30 seconds during the programming, or if you perform an invalid operation during programming, the remote controller exits the programming mode. Resume from Step 2.
- If a failure occurs during programming, the SEND/LEARN indicator flashes three times quickly. Resume from Step 3.
- If a failure occurs five times in row during programming, the remote controller exits the programming mode. Resume from Step 3.
- If you try to program beyond the learning capacity of the remote controller, the SEND/LEARN indicator flashes three times quickly.
- When you want to program a command to a button to which you have already programmed a command, simply follow the same procedure given and programming for that button will be overwritten.
- The remote controller uses infrared rays to send its commands, as do most other remote controllers. Though most remote controller codes can be memorized by the remote controller, be aware that some remote controllers use a system that is quite different from the remote controller and therefore may not be able to be programmed.
- Some remote controllers have a single button that performs multiple functions (for example, the function may change each time the button is pressed). If this is the case, each function must be programmed to a separate button on the remote controller.
- Once you have transferred the commands from the other remote controller, refer to the instruction manual that came with that product for instructions on how to operate that product.
- Make sure both the remote controller and the other remote controller have new batteries. If either of them has batteries that are low, you may not be able to program the commands of the other remote controller properly into the remote controller.

See page 62 for how to erase the memorized commands from all buttons.

Controlling other components connected to the DVD Changer Receiver

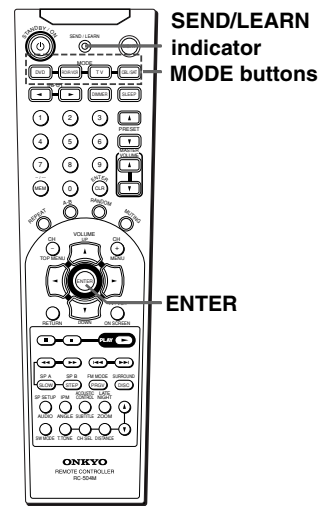

Erasing the programmed command from one button

You can only erase memorized commands and not preset ones.

<p>1</p>	<p>Press and hold down the desired MODE button for the command, press the ENTER button, and then release both buttons.</p> <p>When you press the MODE button, the SEND/LEARN indicator lights. When you press the ENTER button, the lamp turns off. When you release the buttons, the lamp lights again.</p>
<p>2</p>	<p>Press and release the button for the command you wish to erase.</p> <p>When you press the button, the SEND/LEARN indicator turns off. When you release the button, the lamp lights again.</p>
<p>3</p>	<p>Press and release the same button again.</p> <p>The SEND/LEARN indicator flashes twice slowly. The memorized command is erased.</p>

Note

- If no button is pressed for more than 30 seconds during the erasing procedure, the remote controller exits the erasing mode. Resume from Step 1.

Erasing all the commands programmed under a MODE button

<p>1</p>	<p>Press and hold down the desired MODE button, press the ENTER button twice, and then release both buttons.</p> <p>When you press the MODE button, the SEND/LEARN indicator lights. When you press the ENTER button, the lamp turns off. When you release the buttons, the lamp lights again.</p>
<p>2</p>	<p>Press and release the same MODE button again.</p> <p>When you release the button, the SEND/LEARN indicator flashes twice slowly. This erases all the commands memorized to the MODE button.</p>

Notes

- If no button is pressed for more than 30 seconds during the erasing procedure, the remote controller exits the erasing mode. Resume from Step 1.
- If you perform an invalid operation during erasing, the SEND/LEARN indicator flashes three times quickly, and the remote controller exits the erasing mode. Resume from Step 1.
- If many commands have been programmed to the **MODE** button, then the SEND/LEARN indicator may remain lit for up to 20 seconds during Step 2. This is not a malfunction.

Troubleshooting

Check the following guide for the possible cause of a problem before contacting service. Refer also to the respective instruction manuals of the connected components and TV.

	Symptoms	Causes	Remedies	Pages
Amplifier	The DVD Changer Receiver doesn't switch on.	<ul style="list-style-type: none"> The power cord is disconnected. There is external noise interfering with the computer circuits of the DVD Changer Receiver. The AC fuse is blown. 	<ul style="list-style-type: none"> Check the connection of the power cord. Disconnect the power cord, then connect it again. Contact your nearest Onkyo service center. 	23 23 —
	No sound is reproduced.	<ul style="list-style-type: none"> The muting function is activated. The DVD Changer Receiver is not properly connected. The amplifier protection circuitry has activated. (The STANDBY indicator flashes.) Headphones are connected. 	<ul style="list-style-type: none"> Deactivate the muting function. Check the connections to the DVD Changer Receiver. Contact your nearest Onkyo service center. Decrease the volume, then disconnect the headphones. 	31 15-21 — 31
	No sound or very little sound is reproduced from the center speaker.	<ul style="list-style-type: none"> The speakers are not properly connected. The listening mode is set to "Stereo" or "Orchestra." The volume level of the center speaker ("C ch") is set to minimum. A speaker configuration without the center speaker is selected. 	<ul style="list-style-type: none"> Check the speaker connections. No sound is reproduced from the center speaker when the listening mode is "Stereo" or "Orchestra." Adjust the volume level of the center speaker. Check that the selected speaker configuration includes the center speaker. 	16 27, 28 29 24
	No picture appears on the TV screen.	<ul style="list-style-type: none"> The TV is not set to receive the output signals from the DVD Changer Receiver. The video connection cable is not connected securely. Only the S video connection is made. 	<ul style="list-style-type: none"> Set the TV to the DVD Changer Receiver's input. Refer to the instruction manual of TV. Check the connections between the DVD Changer Receiver and TV set. Also make video connection. 	— 15 15
	The sound of the playback source is not heard.	<ul style="list-style-type: none"> Another input source is selected. 	<ul style="list-style-type: none"> Select the appropriate input source. 	54
	The buttons on the remote controller and DVD Changer Receiver do not operate.	<ul style="list-style-type: none"> Power supply fluctuations or other abnormalities such as static electricity may interrupt correct operation. 	<ul style="list-style-type: none"> Disconnect the power cord, then connect it again. 	23

Troubleshooting

	Symptoms	Causes	Remedies	Pages
DVD	The DVD Changer Receiver does not start playback.	<ul style="list-style-type: none"> No disc is inserted. The region number of the disc does not match that of the DVD Changer Receiver. An unplayable disc is inserted. The disc is placed upside down. The disc is not placed within the disc tray guide. The disc is dirty. The parental lock function is activated. 	<ul style="list-style-type: none"> Insert a disc. (Check that "DVD," "VCD," or "CD" is lit in the DVD Changer Receiver's display). See "1. Regional Restriction Codes (Region Number)" on page 4. Check the playable discs. Place the disc with the playback side down. Place the disc within the proper guide on the disc tray. Eject the disc and clean it. Deactivate the parental lock function or change the parental lock level. 	33 4 8 33 33 9 50
	Brightness is unstable or noise is visible on the playback picture.	<ul style="list-style-type: none"> Copy protection is activated. The TV is not compatible with progressive scan signal. 	<ul style="list-style-type: none"> Connect the DVD Changer directly to the TV. Avoid connecting the DVD Changer to the TV through a VCR. Press PRGV on the remote controller and select Interlaced icon. 	15 34
	The playback picture is occasionally distorted.	<ul style="list-style-type: none"> The disc is dirty. It is in fast forward or fast reverse playback. 	<ul style="list-style-type: none"> Eject the disc and clean it. Sometimes a small amount of picture distortion may appear. This is not a malfunction. 	9 –
	Playback doesn't follow the course of the disc's programs.	<ul style="list-style-type: none"> The DVD Changer Receiver is in repeat playback mode, memory playback mode, or random playback mode, etc. 	<ul style="list-style-type: none"> Resume normal playback. 	33
	The picture from the DVD Changer Receiver doesn't appear on the TV screen.	<ul style="list-style-type: none"> The TV is not set to receive the output signals from the DVD Changer Receiver. The DVD Changer Receiver is not properly connected. 	<ul style="list-style-type: none"> Set the TV to the DVD Changer Receiver's input. Check the connections to the DVD Changer Receiver. 	– 15, 18, 19
	No sound or inaccurate sound is reproduced.	<ul style="list-style-type: none"> The TV is not set to receive the output signals from the DVD Changer Receiver. The DVD Changer Receiver is not properly connected. 	<ul style="list-style-type: none"> Set the TV to the DVD Changer Receiver's input. Check the connections to the DVD Changer Receiver. 	– 15-19

	Symptoms	Causes	Remedies	Pages
Tuner	Too much noise is heard or sound is interrupted occasionally. (The ST indicator does not light steadily.)	<ul style="list-style-type: none"> FM stereo waves may produce a hiss noise when a certain level is reached. The position or direction of the FM antenna is incorrect. The station is too weak. 	<ul style="list-style-type: none"> Switch the frequency receiving mode to mono. Adjust the position, height, and direction of the FM antenna. Connect an FM outdoor antenna. Try to use an antenna with more elements. (For installation of the outdoor antenna, consult your nearest dealer as it requires special skills and experience.) 	52 20, 21 20, 21
	Sound is distorted or sound volume decreases.	<ul style="list-style-type: none"> The radio wave is distorted. Cars are running or airplanes are flying near the house. 	— —	— —
	Sound is excessively distorted.	<ul style="list-style-type: none"> There is a tall building or a mountain nearby. (The waves transmitted from the transmission center (direct waves) and the waves reflected by buildings or mountains (diffraction waves) interfere with each other causing multi pass distortion.) 	—	—
	No preset channels are selected.	<ul style="list-style-type: none"> The power cord is unplugged for a long time. 	<ul style="list-style-type: none"> The preset data in memory is lost. Preset the radio stations again. 	52
Recording	Sound is reproduced from the speakers but not recorded.	<ul style="list-style-type: none"> The sound system you are trying to record is DTS Surround. 	<ul style="list-style-type: none"> DTS Surround sound is unable to be recorded. 	—
Remote controller	The buttons on the DVD Changer Receiver operate but the buttons on the remote controller do not operate.	<ul style="list-style-type: none"> No batteries are inserted in the remote controller. 	<ul style="list-style-type: none"> Insert new batteries. 	22
		<ul style="list-style-type: none"> The batteries are worn out. 	<ul style="list-style-type: none"> Replace with new batteries. 	22
		<ul style="list-style-type: none"> The remote controller is not pointed at the remote sensor of the DVD Changer Receiver. 	<ul style="list-style-type: none"> Point the remote controller at the remote sensor of the DVD Changer Receiver. 	22
		<ul style="list-style-type: none"> The remote controller is too far from the DVD Changer Receiver. 	<ul style="list-style-type: none"> Operate the remote controller within 16 feet (5 m). 	22
		<ul style="list-style-type: none"> Any wrong MODE button is pressed. 	<ul style="list-style-type: none"> Press the appropriate MODE button. 	22

This unit contains a sensitive microcomputer, which under certain circumstances might fail to operate due to excessive noise interference. If this happens, in Standby mode, press ►►, ◄◄, ■ in order on the unit. All the custom settings for the receiver section of the DVD Changer Receiver will be erased. Please repeat the custom settings from the beginning.

Specifications

AMPLIFIER SECTION

Power Output (FTC)	All channels 100 watts per channel min. RMS. into 8 ohms two channel driven, 1,000 Hz with no more than 0.1 % total harmonic distortion.
Dynamic Power	6 ohms: 121 W (L/R) 8 ohms: 104 W (L/R)
Total Harmonic Distortion	0.2 % at rated power 0.8 % at 1 watt output
IM Distortion	0.2 % at rated power 0.7 % at 1 watt output
Damping Factor	89 at 8 ohms
Input Sensitivity and Impedance	
DIGITAL IN VIDEO 1 OPTICAL	-21 to -15 dBm
DIGITAL IN VIDEO 2 COAXIAL	0.5 Vp-p, 75 ohms
TV/LINE, TAPE/CD-R, VIDEO 1/2	200 mV/50 kohms
Composite (VIDEO 1, VIDEO 2)	1 Vp-p, 75 ohms
S-VIDEO (VIDEO 1, VIDEO 2)	Y: 1 Vp-p, 75 ohms C: 0.28 Vp-p, 75 ohms
COMPONENT VIDEO	Y: 1.0 Vp-p, 75 ohms PB/PR: 0.7 Vp-p, 75 ohms

Output Level and Impedance

DIGITAL OUT OPTICAL	-21 to -15 dBm
TAPE/CD-R, VIDEO 1	200 mV, 2.2 kohms
SUBWOOFER PRE OUT	1 V, 470 ohms
Composite (MONI OUT, VIDEO 1)	1 Vp-p, 75 ohms
S-VIDEO (MONI OUT, VIDEO 1)	Y: 1 Vp-p, 75 ohms C: 0.28 Vp-p, 75 ohms
COMPONENT VIDEO	Y: 1.0 Vp-p, 75 ohms PB/PR: 0.7 Vp-p, 75 ohms

Frequency Response

20 to 30,000 Hz (+/- 0.8 dB)

Acoustic Control

1: +9 dB at 100 Hz
2: +9 dB at 100 Hz
+6 dB at 10,000 Hz

Signal-to-noise Ratio

100 dB (0.5 V INPUT LINE)

Muting

-50 dB

DVD SECTION

Signal readout system	Optical non-contact
Linear velocity	3.49 m/s (Single Layer) 3.84 m/s (Dual Layer)
Error correction system	Reed Solomon Product Code
Signal system	NTSC
Regional restriction code	1

Laser

Semiconductor laser, wavelength 650 nm

Frequency response

10 Hz to 44 kHz (96 kHz)

Wow and flutter

Below threshold of measurability

Operating conditions

Temperature: 5°C to 35°C (41°F to 95°F),
Operation status: Horizontal

TUNER SECTION

Tuning Range	FM: 87.50 to 108.00 MHz (0.1 MHz steps) AM: 530 to 1710 kHz (10 kHz steps)	
Usable Sensitivity	FM: Mono 11.2 dBf, 1.0 µV (75 ohms IHF) Stereo 17.2 dBf, 2.0 µV (75 ohms IHF) AM: 30 µV	
50 dB Quieting Sensitivity	FM: Mono 17.2 dBf, 2.0 µV (75 ohms) Stereo 37.2 dBf, 20.0 µV (75 ohms)	
Capture Ratio	FM: 2.0 dB	
Image Rejection Ratio	FM: 40 dB AM: 40 dB	
IF Rejection Ratio	FM: 90 dB AM: 40 dB	
Signal-to-noise Ratio	FM: Mono 73 dB, IHF Stereo 67 dB, IHF AM: 40 dB	
Alternate Channel Att. (+/- 400 kHz)	FM: Mono 55 dB, IHF	Frequency response FM: 30 to 15,000 Hz (+/- 1.0 dB)
Selectivity	FM: 55dB, IHF	Stereo Separation FM: 45 dB at 1,000 Hz 30 dB at 100 to 10,000 Hz
AM Suppression Ratio	FM: 50 dB	Stereo Threshold FM: 17.2 dBf, 20 µV (75 ohms)
Harmonic Distortion	FM: Mono 0.2 % Stereo 0.3 % AM: 0.7 %	

GENERAL

Power Supply	AC 120 V, 60 Hz	Dimensions (W x H x D)	435 x 148 x 455 mm (17 ¹ / ₈ x 5 ¹³ / ₁₆ x 17 ¹⁵ / ₁₆ ins.)
Power Consumption	2.0 A	Weight	12.5 kg (27.6 lbs.)

Specifications and features are subject to change without notice.

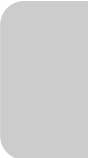

ONKYO CORPORATION

Sales & Product Planning Div. : 2-1, Nisshin-cho, Neyagawa-shi, OSAKA 572-8540, JAPAN
Tel: 072-831-8111 Fax: 072-833-5222

ONKYO U.S.A. CORPORATION

18 Park Way, Upper Saddle River, N.J. 07458, U.S.A.
Tel: 201-785-2600 Fax: 201-785-2650 <http://www.onkyousa.com>

ONKYO EUROPE ELECTRONICS GmbH

Liegnitzerstrasse 6, 82194 Groebenzell, GERMANY
Tel: +49-8142-4401-0 Fax: +49-8142-4401-555 E-mail: info@onkyo.de

ONKYO CHINA LIMITED

Units 2102-2107, Metroplaza Tower I, 223 Hing Fong Road, Kwai Chung,
N.T., HONG KONG Tel: 852-2429-3118 Fax: 852-2428-9039



Free Manuals Download Website

<http://myh66.com>

<http://usermanuals.us>

<http://www.somanuals.com>

<http://www.4manuals.cc>

<http://www.manual-lib.com>

<http://www.404manual.com>

<http://www.luxmanual.com>

<http://aubethermostatmanual.com>

Golf course search by state

<http://golfingnear.com>

Email search by domain

<http://emailbydomain.com>

Auto manuals search

<http://auto.somanuals.com>

TV manuals search

<http://tv.somanuals.com>