



5.1ch Home Theater System

HT-S580

AV Receiver (HT-R330)

Front Speakers (SKF-330F L/R)

Center Speaker (SKC-330C)

Surround Speakers (SKM-330S L/R)

Subwoofer (SKW-330)

Instruction Manual

Thank you for purchasing an Onkyo 5.1ch Home Theater System. Please read this manual thoroughly before making connections and plugging in the unit. Following the instructions in this manual will enable you to obtain optimum performance and listening enjoyment from your new 5.1ch Home Theater System.

Please retain this manual for future reference.

Contents

Introduction 2

Connection 17

Turning On & First Time Setup..... 32

Basic Operation

Playing your AV components 36

Using the Tuner..... 38

Enjoying the Listening Modes 44

Advanced Operation 47

Troubleshooting 53

Specification..... 56



WARNING:

TO REDUCE THE RISK OF FIRE OR ELECTRIC SHOCK, DO NOT EXPOSE THIS APPARATUS TO RAIN OR MOISTURE.

CAUTION:

TO REDUCE THE RISK OF ELECTRIC SHOCK, DO NOT REMOVE COVER (OR BACK). NO USER-SERVICEABLE PARTS INSIDE. REFER SERVICING TO QUALIFIED SERVICE PERSONNEL.



WARNING
RISK OF ELECTRIC SHOCK
DO NOT OPEN

AVIS
RISQUE DE CHOC ELECTRIQUE
NE PAS OUVRIR



The lightning flash with arrowhead symbol, within an equilateral triangle, is intended to alert the user to the presence of uninsulated "dangerous voltage" within the product's enclosure that may be of sufficient magnitude to constitute a risk of electric shock to persons.



The exclamation point within an equilateral triangle is intended to alert the user to the presence of important operating and maintenance (servicing) instructions in the literature accompanying the appliance.

Important Safety Instructions

1. Read these instructions.
2. Keep these instructions.
3. Heed all warnings.
4. Follow all instructions.
5. Do not use this apparatus near water.
6. Clean only with dry cloth.
7. Do not block any ventilation openings. Install in accordance with the manufacturer's instructions.
8. Do not install near any heat sources such as radiators, heat registers, stoves, or other apparatus (including amplifiers) that produce heat.
9. Do not defeat the safety purpose of the polarized or grounding-type plug. A polarized plug has two blades with one wider than the other. A grounding type plug has two blades and a third grounding prong. The wide blade or the third prong are provided for your safety. If the provided plug does not fit into your outlet, consult an electrician for replacement of the obsolete outlet.
10. Protect the power cord from being walked on or pinched particularly at plugs, convenience receptacles, and the point where they exit from the apparatus.
11. Only use attachments/accessories specified by the manufacturer.
12. Use only with the cart, stand, tripod, bracket, or table specified by the manufacturer, or sold with the apparatus. When a cart is used, use caution when moving the cart/apparatus combination to avoid injury from tip-over.

PORTABLE CART WARNING
S3125A
13. Unplug this apparatus during lightning storms or when unused for long periods of time.
14. Refer all servicing to qualified service personnel. Servicing is required when the apparatus has been damaged in any way, such as power-supply cord or plug is damaged, liquid has been spilled or objects have fallen into the apparatus, the apparatus has been exposed to rain or moisture, does not operate normally, or has been dropped.
15. Damage Requiring Service
Unplug the apparatus from the wall outlet and refer servicing to qualified service personnel under the following conditions:
 - A. When the power-supply cord or plug is damaged,
 - B. If liquid has been spilled, or objects have fallen into the apparatus,
 - C. If the apparatus has been exposed to rain or water,
 - D. If the apparatus does not operate normally by following the operating instructions. Adjust only those controls that are covered by the operating instructions as an improper adjustment of other controls may result in damage and will often require extensive work by a qualified technician to restore the apparatus to its normal operation,
 - E. If the apparatus has been dropped or damaged in any way, and
 - F. When the apparatus exhibits a distinct change in performance this indicates a need for service.
16. Object and Liquid Entry
Never push objects of any kind into the apparatus through openings as they may touch dangerous voltage points or short-out parts that could result in a fire or electric shock.
The apparatus shall not be exposed to dripping or splashing and no objects filled with liquids, such as vases shall be placed on the apparatus.
Don't put candles or other burning objects on top of this unit.
17. Batteries
Always consider the environmental issues and follow local regulations when disposing of batteries.
18. If you install the apparatus in a built-in installation, such as a bookcase or rack, ensure that there is adequate ventilation.
Leave 20 cm (8") of free space at the top and sides and 10 cm (4") at the rear. The rear edge of the shelf or board above the apparatus shall be set 10 cm (4") away from the rear panel or wall, creating a flue-like gap for warm air to escape.

Precautions

1. **Recording Copyright**—Unless it's for personal use only, recording copyrighted material is illegal without the permission of the copyright holder.
2. **AC Fuse**—The AC fuse inside the unit is not user-serviceable. If you cannot turn on the unit, contact your Onkyo dealer.
3. **Care**—Occasionally you should dust the unit all over with a soft cloth. For stubborn stains, use a soft cloth dampened with a weak solution of mild detergent and water. Dry the unit immediately afterwards with a clean cloth. Don't use abrasive cloths, thinners, alcohol, or other chemical solvents, because they may damage the finish or remove the panel lettering.

4. Power WARNING

BEFORE PLUGGING IN THE UNIT FOR THE FIRST TIME, READ THE FOLLOWING SECTION CAREFULLY.

AC outlet voltages vary from country to country. Make sure that the voltage in your area meets the voltage requirements printed on the unit's rear panel (e.g., AC 230 V, 50 Hz or AC 120 V, 60 Hz).

Some models have a voltage selector switch for compatibility with power systems around the world. Before you plug in such a model, make sure that the voltage selector is set to the correct voltage for your area.

Setting the [STANDBY/ON] switch to STANDBY does not fully shutdown the unit. If you do not intend to use the unit for an extended period, remove the power cord from the AC outlet.

5. **Never Touch this Unit with Wet Hands**—Never handle this unit or its power cord while your hands are wet or damp. If water or any other liquid gets inside this unit, have it checked by your Onkyo dealer.
6. **Handling Notes**
 - If you need to transport this unit, use the original packaging to pack it how it was when you originally bought it.
 - Do not leave rubber or plastic items on this unit for a long time, because they may leave marks on the case.
 - This unit's top and rear panels may get warm after prolonged use. This is normal.
 - If you do not use this unit for a long time, it may not work properly the next time you turn it on, so be sure to use it occasionally.

Memory Backup

The AV receiver uses a battery-less memory backup system in order to retain radio presets and other settings when it's unplugged or in the case of a power failure. Although no batteries are required, the AV receiver must be plugged into an AC outlet in order to charge the backup system. Once it has been charged, the AV receiver will retain the settings for several weeks, although this depends on the environment and will be shorter in humid climates.

For British models

Replacement and mounting of an AC plug on the power supply cord of this unit should be performed only by qualified service personnel.

IMPORTANT

The wires in the mains lead are coloured in accordance with the following code:

Blue: Neutral

Brown: Live

As the colours of the wires in the mains lead of this apparatus may not correspond with the coloured markings identifying the terminals in your plug, proceed as follows:



The wire which is coloured blue must be connected to the terminal which is marked with the letter N or coloured black.

The wire which is coloured brown must be connected to the terminal which is marked with the letter L or coloured red.

IMPORTANT

The plug is fitted with an appropriate fuse. If the fuse needs to be replaced, the replacement fuse must be approved by ASTA or BSI to BS1362 and have the same ampere rating as that indicated on the plug. Check for the ASTA mark or the BSI mark on the body of the fuse. If the power cord's plug is not suitable for your socket outlets, cut it off and fit a suitable plug. Fit a suitable fuse in the plug.

For European Models

Declaration of Conformity	
We, ONKYO EUROPE ELECTRONICS GmbH LIEGNITZERSTRASSE 6, 82194 GROEBENZELL, GERMANY	
declare in own responsibility, that the ONKYO product described in this instruction manual is in compliance with the corresponding technical standards such as EN60065, EN55013, EN55020 and EN61000-3-2, -3-3.	
GROEBENZELL, GERMANY	 I. MORI
ONKYO EUROPE ELECTRONICS GmbH	

For U.S. models

FCC Information for User

CAUTION:

The user changes or modifications not expressly approved by the party responsible for compliance could void the user's authority to operate the equipment.

NOTE:

This equipment has been tested and found to comply with the limits for a Class B digital device, pursuant to Part 15 of the FCC Rules. These limits are designed to provide reasonable protection against harmful interference in a residential installation.

This equipment generates, uses and can radiate radio frequency energy and, if not installed and used in accordance with the instructions, may cause harmful interference to radio communications. However, there is no guarantee that interference will not occur in a particular installation. If this equipment does cause harmful interference to radio or television reception, which can be determined by turning the equipment off and on, the user is encouraged to try to correct the interference by one or more of the following measures:

- Reorient or relocate the receiving antenna.
- Increase the separation between the equipment and receiver.
- Connect the equipment into an outlet on a circuit different from that to which the receiver is connected.
- Consult the dealer or an experienced radio/TV technician for help.

For Canadian Models

NOTE: THIS CLASS B DIGITAL APPARATUS COMPLIES WITH CANADIAN ICES-003.

For models having a power cord with a polarized plug:

CAUTION: TO PREVENT ELECTRIC SHOCK, MATCH WIDE BLADE OF PLUG TO WIDE SLOT, FULLY INSERT.

Modèle canadien

REMARQUE: CET APPAREIL NUMÉRIQUE DE LA CLASSE B EST CONFORME À LA NORME NMB-003 DU CANADA.

Sur les modèles dont la fiche est polarisée:

ATTENTION: POUR ÉVITER LES CHOCS ÉLECTRIQUES, INTRODUIRE LA LAME LA PLUS LARGE DE LA FICHE DANS LA BORNE CORRESPONDANTE DE LA PRISE ET POUSSER JUSQU'AU FOND.

Speaker Precautions

Placement

- The subwoofer cabinet is made out of wood and is therefore sensitive to extreme temperatures and humidity, do not put it in locations subject to direct sunlight or in humid places, such as near an air conditioner, humidifier, bathroom, or kitchen.
- Do not put water or other liquids close to the speakers. If liquid is spilled over the speakers, the drive units may be damaged.
- Speakers should only be placed on sturdy, flat surfaces that are free from vibration. Putting them on uneven or unstable surfaces, where they may fall and cause damage, will affect the sound quality.
- Subwoofer is designed to be used in the upright vertical position only. Do not use it in the horizontal or tilted position.
- If the unit is used near a turntable or CD player, howling or slipping of sound may occur. To prevent this, move the unit away from the turntable or CD player otherwise lower the unit's output level.

Using Close to a TV or Computer

TVs and computer monitors are magnetically sensitive devices and as such are likely to suffer discoloration or picture distortion when conventional speakers are placed nearby. To prevent this, the SKF-330F and SKC-330C feature internal magnetic shielding. In some situations, however, discoloration may still be an issue, in which case you should turn off your TV or monitor, wait 15 to 30 minutes, and then turn it back on again. This normally activates the degaussing function, which neutralizes the magnetic field, thereby removing any discoloration effects. If discoloration problems persist, try moving the speakers away from your TV or monitor. Note that discoloration can also be caused by a magnet or demagnetizing tool that's too close to your TV or monitor.

Do not place SKM-330 close to TV or a computer monitor because they have no magnetic shield.

Input Signal Warning

The speakers can handle the specified input power when used for normal music reproduction. If any of the following signals are fed to them, even if the input power is within the specified rating, excessive current may flow in the speaker coils, causing burning or wire breakage:

1. Interstation noise from an untuned FM radio.
2. Sound from fast-forwarding a cassette tape.
3. High-pitched sounds generated by an oscillator, electronic musical instrument, and so on.
4. Amplifier oscillation.
5. Special test tones from audio test CDs and so on.
6. Thumps and clicks caused by connecting or disconnecting audio cables (Always turn off your amplifier before connecting or disconnecting cables.)
7. Microphone feedback.

Features

Amp

- 6-channel amplifier
- 100 watts per channel min. RMS at 8 Ω , 2 channels driven from 1 kHz with no more than 0.9% total harmonic distortion
- WRAT (Wide Range Amplifier Technology)
- Optimum gain volume circuitry
- OptiResponse™ Equalizer (OR-EQ™)*1 function

Processing

- Dolby^{*2} Digital and Dolby Pro Logic II
- DTS and DTS Neo:6 processing^{*3}
- Cinema Filter function
- Linear PCM 192 kHz/24-bit D/A converters on all channels
- Powerful and highly accurate 32-bit DSP Processing

Audio/Video

- Adjustable crossover (60, 80, 100, 120, 150 Hz)
- 2 assignable digital inputs (1 optical, 1 coaxial)
- Color-coded multichannel input for use with Super Audio CD and DVD-Audio
- A/B speaker drive
- Color-coded speaker terminal

FM/AM Tuner

- 30 FM/AM presets
- FM/AM auto tuning
- RDS (Radio Data System) (Europe only)

Remote Controller

- Remote controller can be used to control Onkyo CD, CDR, MD components, and cassette tape deck

Front / Center / Surround Speakers

- Color-coded speaker terminals and speaker cables
- 3-1/8" (8 cm) cone woofer
- Ceramic tweeter

Subwoofer

- Down-Firing Subwoofer
- Heavy-Duty Long-Throw woofer
- Color-coded speaker terminals and speaker cables

*1. OptiResponse and OR-EQ are trademarks of Onkyo Corporation.

*2. Manufactured under license from Dolby Laboratories. "Dolby", "Pro Logic" and the double-D symbol are registered trademarks of Dolby Laboratories.

*3. "DTS" and "Neo:6" are trademarks of Digital Theater Systems, Inc.

Table of Contents

Introduction

Important Safety Instructions.....	2
Precautions	3
Speaker Precautions	4
Features.....	5
Supplied Accessories	6
Before Using the AV receiver.....	7
Front & Rear Panels	8
Speaker Package	11
Remote Controller	12

Connection

Connecting Your Speakers.....	17
Connecting Antenna	20
Connecting Your Components	22

Turning On & First Time Setup

Turning On	32
First Time Setup	33

Basic Operation

Playing Your AV Components.....	36
Using the Tuner	38
Common Functions.....	42

Enjoying the Listening Modes

Using the Listening Modes.....	44
--------------------------------	----

Advanced Operation

Adjusting the Listening Modes	47
Recording.....	49
Advanced Setup	50

Troubleshooting

Specification.....

Supplied Accessories

Make sure you have the following accessories:

HT-R330

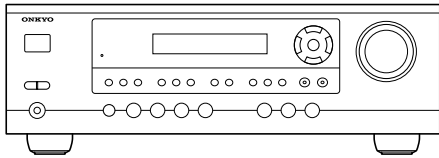

HT-R330

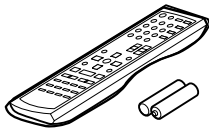

Remote controller & two batteries (AA/R6)



Indoor FM antenna (Connector type varies from country to country.)



AM loop antenna

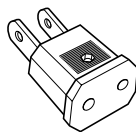

Power-plug adapter

Only supplied in certain countries. Use this adapter if your AC outlet does not match with the plug on the AV receiver's power cord. (Adapter varies from country to country.)

* In catalogs and on packaging, the letter at the end of the product name indicates the color. Specifications and operation are the same regardless of color.

HTP-330

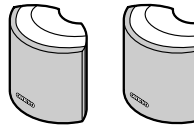

Front speakers (SKF-330F L/R)

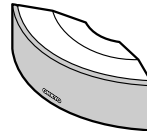

Center speaker (SKC-330C)

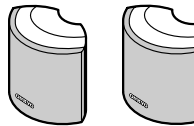

Surround speakers (SKM-330S)

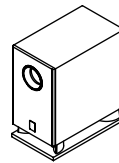

Subwoofer (SKW-330)

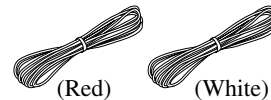

Speaker cable for front speakers 15 ft. (4.5 m)



Speaker cable for center speaker 10 ft. (3 m)

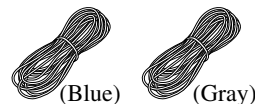

Speaker cables for surround speakers 30 ft. (9 m)

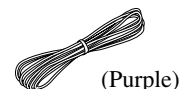

Speaker cables for subwoofer 15 ft. (4.5 m)

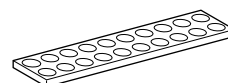

Rubber stoppers [20]

Before Using the AV receiver

Setting the Voltage Selector (on some models)

Some models have a voltage selector switch for compatibility with power systems around the world. Before you plug in this model, make sure that the voltage selector is set to the correct voltage for your area. If it isn't, use a small screwdriver to set it as appropriate. For example, if the voltage in your area is 120 volts, set the selector to "120V." If it's between 220 and 230 volts, set it to "220-230V."

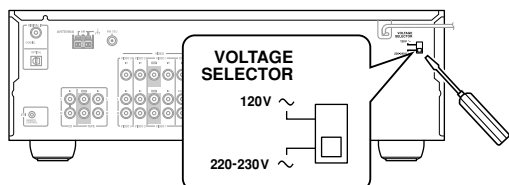

Installing the Batteries

- 1 To open the battery compartment, press the small hollow and slide open the cover.

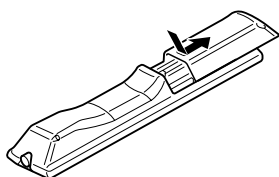

- 2 Insert the two supplied batteries (AA/R6) in accordance with the polarity diagram inside the battery compartment.

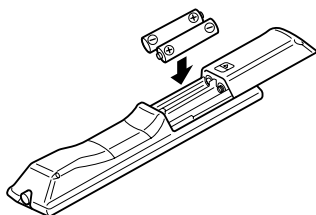

- 3 Slide the cover shut.

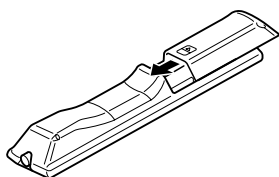

Notes:

- The batteries should last for about six months, although this will vary with usage.
- If the remote controller doesn't work reliably, try replacing the batteries.
- Don't mix new and old batteries or different types of batteries.
- If you intend not to use the remote controller for a long time, remove the batteries to prevent damage from leakage or corrosion.
- Expired batteries should be removed as soon as possible to prevent damage from leakage or corrosion.

Using the Remote Controller

To use the remote controller, point it at the AV receiver's remote control sensor, as shown below.

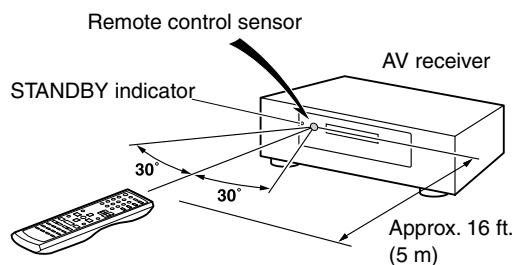

Notes:

- The remote controller may not work reliably if the AV receiver is subjected to bright light, such as direct sunlight or inverter-type fluorescent lights. Keep this in mind when installing.
- If another remote controller of the same type is used in the same room, or the AV receiver is installed close to equipment that uses infrared rays, the remote controller may not work reliably.
- Don't put anything, such as a book, on the remote controller, because the buttons may be pressed inadvertently, thereby draining the batteries.
- The remote controller may not work reliably if the AV receiver is installed in a rack behind colored glass doors. Keep this in mind when installing.
- The remote controller will not work if there's an obstacle between it and the AV receiver's remote control sensor.

Front & Rear Panels

Front Panel

North American and Asian Models

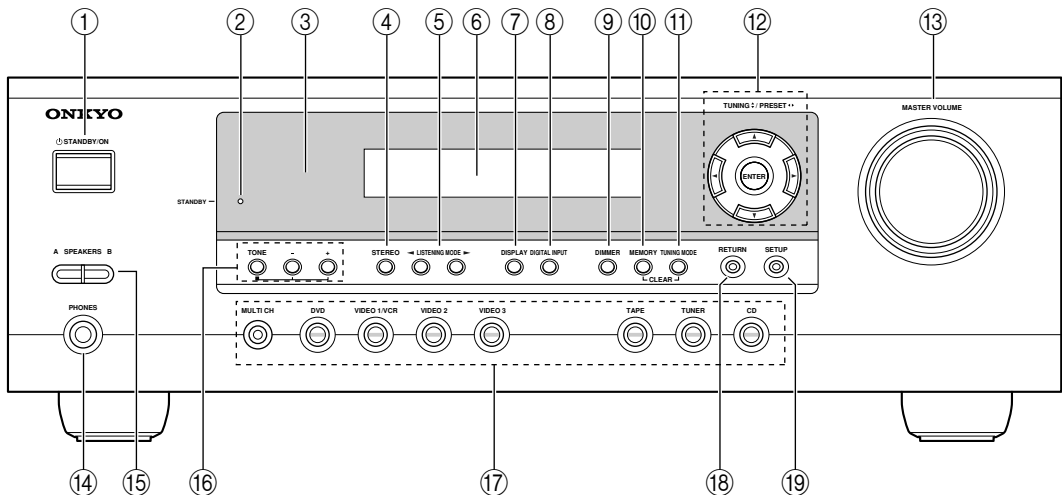

European Models

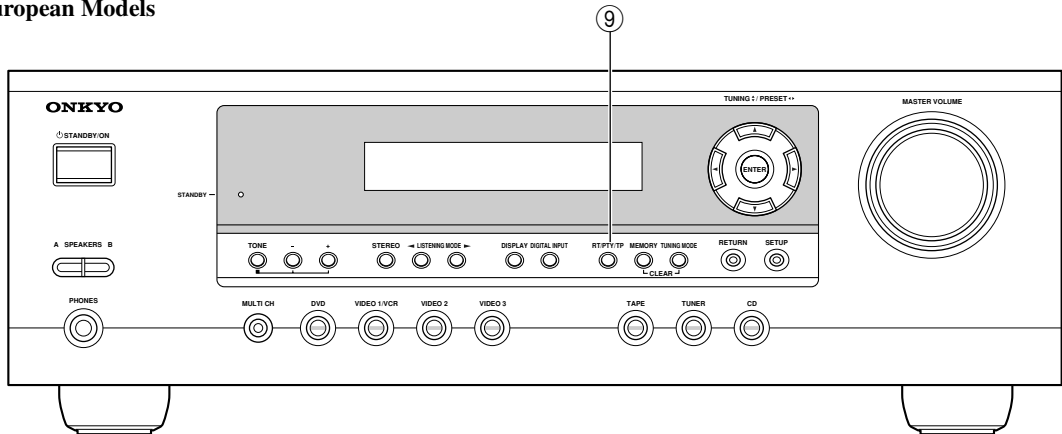

For detailed information, see the pages in parentheses.

① **STANDBY/ON button (32)**

This button is used to set the AV receiver to On or Standby.

② **STANDBY indicator (32)**

This indicator lights up when the AV receiver is in Standby mode, and it flashes while a signal is being received from the remote controller.

③ **Remote-control sensor (7)**

This sensor receives control signals from the remote controller.

④ **STEREO button (44)**

This button is used to select the Stereo listening mode.

⑤ **LISTENING MODE [◀]/[▶] buttons (44)**

These buttons are used to select the listening modes.

⑥ **Display**

See “Display” on page 9.

⑦ **DISPLAY button (37)**

This button is used to display various information about the currently selected input source.

⑧ **DIGITAL INPUT button (33)**

This button is used to assign the digital inputs and to specify the format of digital input signals.

⑨ **DIMMER or RT/PTY/TP button (41, 42)**

This button is used to adjust the display brightness. On the European model, this is the RT/PTY/TP button, and it's used with RDS (Radio Data System). See “Using RDS (European models only)” on page 40.

Front & Rear Panels—Continued

- ⑩ **MEMORY button (39)**
This button is used when storing or deleting radio presets.
- ⑪ **TUNING MODE button (38)**
This button is used to select the Auto or Manual tuning mode.
- ⑫ **Arrow/TUNING/PRESET & ENTER buttons**
When the AM or FM input source is selected, the TUNING [▲] [▼] buttons are used to tune the tuner, and the PRESET [◀] [▶] buttons are used to select radio presets (see page 39). When the setup menus are used, they work as arrow buttons and are used to select and set items. The ENTER button is also used with the setup menus.
- ⑬ **MASTER VOLUME control (36)**
This control is used to adjust the volume of the AV receiver to MIN, 1 through 79, or MAX
- ⑭ **PHONES jack (43)**
This 1/4-inch phone jack is for connecting a standard pair of stereo headphones for private listening.
- ⑮ **SPEAKER A & B buttons (36)**
These buttons are used to turn speaker sets A and B on or off.
- ⑯ **TONE, [-] & [+] buttons (42)**
These buttons are used to adjust the bass and treble.
- ⑰ **Input selector buttons (36)**
These buttons are used to select from the following input sources: MULTI CH, DVD, VIDEO 1/VCR, VIDEO 2, VIDEO 3, TAPE, TUNER, or CD.
The [MULTI CH] button selects the DVD analog multichannel input.
- ⑱ **RETURN button**
This button is used to return to the previously displayed setup menu.
- ⑲ **SETUP button**
This button is used to access various settings.

Display

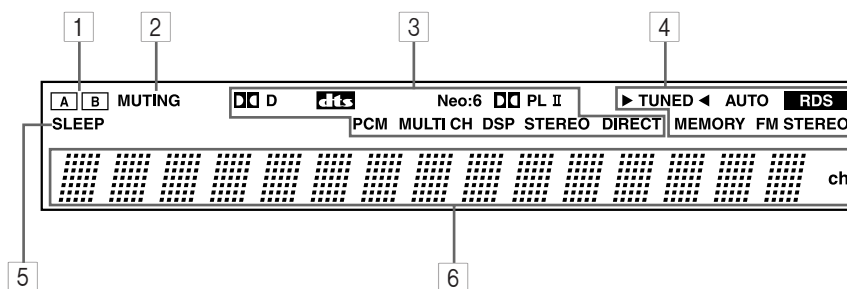

For detailed information, see the pages in parentheses.

- ① **A & B speaker indicators (36)**
Indicator A lights up when speaker set A is on. Indicator B lights up when speaker set B is on.
- ② **MUTING indicator (42)**
This indicator flashes when the AV receiver is muted.
- ③ **Source/listening mode indicators (46)**
These indicators show the currently selected listening mode and digital audio format.
- ④ **Tuning indicators (38)**
TUNED (38): This indicator lights up when the AV receiver is tuned to a radio station.
AUTO (38): This indicator lights up when Auto Tuning is selected and disappears when Manual Tuning is selected.
- RDS (European model only) (40):** This indicator lights up when the AV Receiver is tuned to a radio station that supports RDS (Radio Data System).
- MEMORY (39):** This indicator lights up when pre-setting radio stations.
- FM STEREO (38):** This indicator lights up when the AV receiver is tuned to a stereo FM station.
- ⑤ **SLEEP indicator (43)**
This indicator lights up when the Sleep function has been set.
- ⑥ **Message area**
This area of the display shows various information about the currently selected source.

Rear Panel

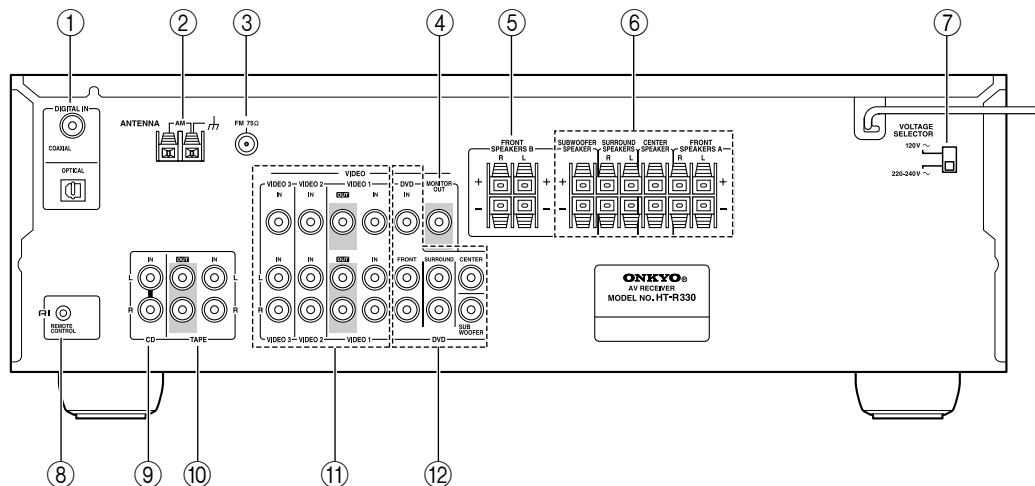

① DIGITAL IN OPTICAL & COAXIAL

These optical and coaxial jacks can be used to connect a CD or DVD player and other components with digital audio outputs.

② AM ANTENNA

These push terminals are for connecting an AM antenna.

③ FM ANTENNA

This jack is for connecting an FM antenna.

④ MONITOR OUT

The composite video output should be connected to a video input on your TV or projector.

⑤ FRONT SPEAKERS B

These push terminals are for connecting speaker set B.

⑥ FRONT SPEAKERS A, SURROUND SPEAKERS & CENTER SPEAKER

These push terminals are for connecting speaker set A.

⑦ VOLTAGE SELECTOR (only some models)

This voltage selector provides compatibility with power systems around the world.

⑧ RI

This **RI** (Remote Interactive) jack can be connected to the **RI** jack on another Onkyo component. The AV receiver's remote controller can then be used to control that component. To use **RI**, you must make an analog audio connection (RCA) between the AV receiver and the other component, even if they are connected digitally.

Note:

RI can only be used with Onkyo components.

⑨ CD IN

These analog inputs can be used to connect a CD player with analog outputs.

⑩ TAPE IN/OUT

These analog inputs and outputs can be used to connect a cassette recorder, MiniDisc recorder, or other recorder with analog inputs and outputs.

⑪ VIDEO 1 IN/OUT, VIDEO 2 IN & VIDEO 3 IN

The VIDEO 1, composite video, and audio inputs and outputs can be used to connect a VCR. The VIDEO 2, VIDEO 3, composite video, and audio inputs can be used to connect another video source (e.g., cable TV, satellite TV, or a set-top box).

⑫ DVD IN/MULTI CH INPUT

The FRONT, SURROUND, CENTER, and SUBWOOFER jacks can be used to connect a component with an analog multichannel audio output, such as a DVD player with a 5.1-channel analog output. The composite video input should be connected to a video output on the DVD player.

See pages 17–31 for connection information.

Speaker Package

Front, Center, Surround, & Subwoofer speakers (SKF-330F, SKC-330C, SKM-330S, SKW-330)

■ Rear

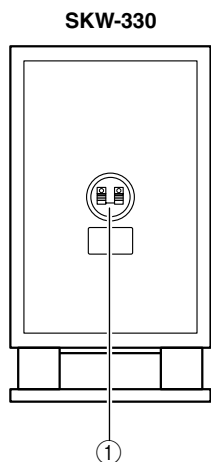
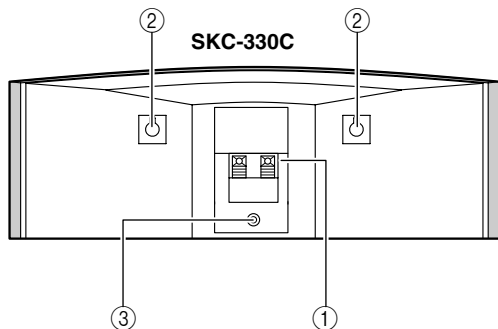
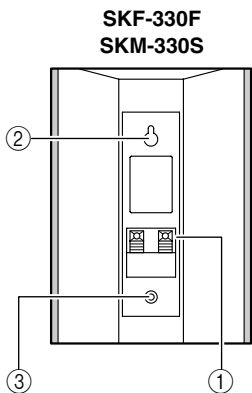

① Speaker terminals

These push terminals are for connecting the speaker to the HT-R330 with the supplied speaker cables. The supplied speaker cables are color-coded for easy identification. Simply connect each cable to the same-colored positive speaker terminal.

② Keyhole slots

These keyhole slots can be used to wall-mount the speaker. See page 19 for mounting instructions.

③ Speaker mount/bracket inserts

These threaded inserts can be used to attach the speaker to a speaker mount or bracket. See page 19 for mounting instructions.

Note:

Use commercially available machine screws to attach the speaker to a speaker mount or bracket. North American models require 1/4-inch screws. Other models require M5 (5 mm) screws.

Remote Controller

How to Use the Remote Controller

Including the AV receiver, the remote controller can be used to control up to six different components. The remote controller has a specific operating mode for use with each type of component. Modes are selected by using the five REMOTE MODE buttons.

RECEIVER/TAPE Mode

In RECEIVER/TAPE mode, you can control the AV receiver and an Onkyo cassette recorder connected via **RI**.



DVD, CD, MD, & CDR Modes

With these modes, you can control an Onkyo DVD player and CD/MD/CDR player/recorder.



1 Use the REMOTE MODE buttons to select a mode.

2 Use the buttons supported by that mode to control the component.

- RECEIVER mode: see page 12
- DVD mode: see page 14
- CD/MD/CDR mode: see page 15
- TAPE mode: see page 16

Note:

Some of the remote controller operations described in this manual may not work as expected with other components.

RECEIVER Mode

RECEIVER mode is used to control the AV receiver.

To set the remote controller to RECEIVER mode, press the [RECEIVER] REMOTE MODE button.

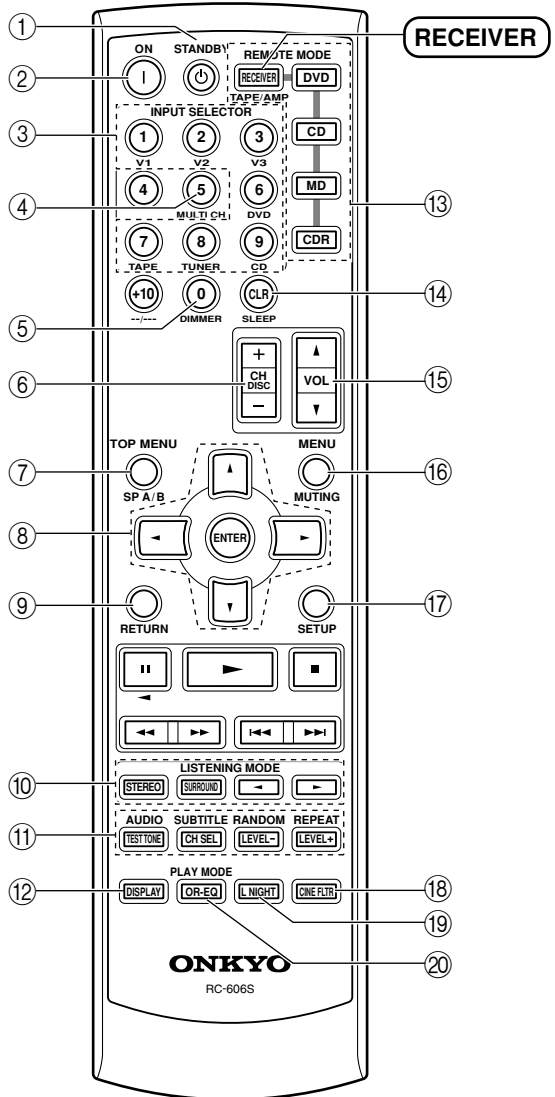

For detailed information, see the pages in parentheses.

- ① **STANDBY button (32)**
This button is used to set the AV receiver to Standby.
- ② **ON button (32)**
This button is used to turn on the AV receiver.
- ③ **INPUT SELECTOR buttons (36)**
These buttons are used to select the input sources.
- ④ **MULTI CH button (37)**
This button is used to select the multichannel DVD input.
- ⑤ **DIMMER button (42)**
This button is used to adjust the display brightness.
- ⑥ **CH +/- button (39)**
This button is used to select radio presets.
- ⑦ **SP A/B button (36)**
This button is used to turn speaker sets A and B on or off.
- ⑧ **Arrow [▲]/[▼]/[◀]/[▶] & ENTER buttons**
These buttons are used to select and adjust settings.
- ⑨ **RETURN button**
This button is used to return to the previous display when changing settings.
- ⑩ **LISTENING MODE buttons (44)**
These buttons can be used to select listening modes regardless of the currently selected remote controller mode.
STEREO button
This button selects the Stereo listening mode.
SURROUND button
This button selects the Dolby and DTS listening modes.
[◀]/[▶] buttons
These buttons can be used to select any of the available listening modes.
- ⑪ **TEST TONE, CH SEL, LEVEL- & LEVEL+ buttons (35)**
These buttons are used to adjust the level of each speaker.
- ⑫ **DISPLAY button (37)**
This button is used to display various information about the currently selected input source.
- ⑬ **REMOTE MODE buttons (12)**
These buttons are used to select the remote controller modes. When you press a button on the remote controller, the REMOTE MODE button for the currently selected mode lights up.
- ⑭ **SLEEP button (43)**
This button is used to set the Sleep function.

- ⑮ **VOL [▲]/[▼] button (36)**
This button can be used to adjust the volume of the AV receiver regardless of the currently selected remote controller mode.
- ⑯ **MUTING button (42)**
This button is used to mute the AV receiver.
- ⑰ **SETUP button**
This button is used to access various settings.
- ⑱ **CINE FLTR button (48)**
This button is used to set the CinemaFILTER function.
- ⑲ **L NIGHT button (48)**
This button is used to set the Late Night function.
- ⑳ **OR-EQ button (42)**
This button is used to turn on the OptiResponse equalizer, which optimizes performance when the HT-R330 is used with the speakers included in the HTP-330 Home Theater Speaker Package. When the OptiResponse equalizer is on, you can enjoy a powerful sound with movies or music with small volume.

DVD Mode

To set the remote controller to DVD mode, press the [DVD] REMOTE MODE button.

Before selecting DVD mode and starting playback, you should press the [RECEIVER] mode button followed by the [DVD] INPUT SELECTOR button to select the DVD player as the input source.

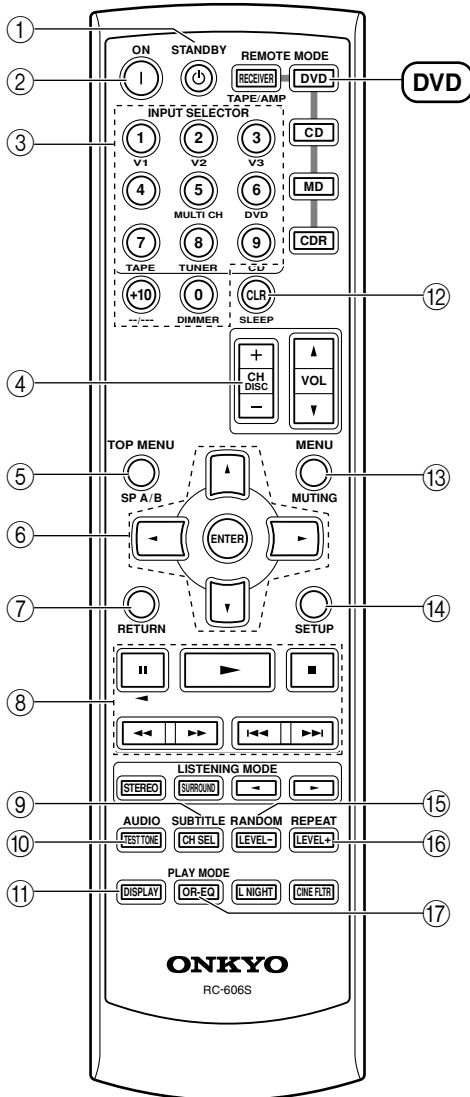

- ① **STANDBY button**
This button sets the DVD player to Standby.
- ② **ON button**
This button is used to turn on the DVD player.
- ③ **Number buttons**
These buttons are used to enter title, chapter, and track numbers and to enter times for locating specific points in time.
- ④ **DISC +/- button**
This button selects discs on a DVD changer.
- ⑤ **TOP MENU button**
This button is used to select a DVD's top menu.
- ⑥ **Arrow [▲]/[▼]/[◀]/[▶] & ENTER buttons**
These buttons are used to navigate DVD menus and the DVD player's onscreen setup menus.
- ⑦ **RETURN button**
This button is used to exit the DVD player's onscreen setup menu and to restart menu playback.
- ⑧ **Playback buttons**
From left to right: Pause, Play, Stop, Fast Reverse, Fast Forward, Previous, and Next.
- ⑨ **SUBTITLE button**
This button is used to select subtitles.
- ⑩ **AUDIO button**
This button selects foreign language soundtracks and audio formats (e.g., Dolby Digital or DTS).
- ⑪ **DISPLAY button**
This button is used to display information about the current disc, title, chapter, or track on the DVD player's display, including the elapsed time, remaining time, total time, and so on.
- ⑫ **CLR button**
This button is used to cancel functions and to clear entered numbers.
- ⑬ **MENU button**
This button is used to display a DVD's menu.
- ⑭ **SETUP button**
This button is used to access the DVD player's onscreen setup menus.
- ⑮ **RANDOM button**
This button is used with the random playback function.
- ⑯ **REPEAT button**
This button is used to set the repeat playback functions.
- ⑰ **PLAY MODE button**
This button is used to select play modes on a component with selectable play modes.

CD, MD, & CDR Mode

To set the remote controller to CD, MD, or CDR mode, press the [CD], [MD], or [CDR] REMOTE MODE button.

Before selecting a mode and starting playback, you should press the [RECEIVER] mode button followed by the [CD] or [TAPE] INPUT SELECTOR button to select the CD player, MiniDisc, or CD recorder as the input source.

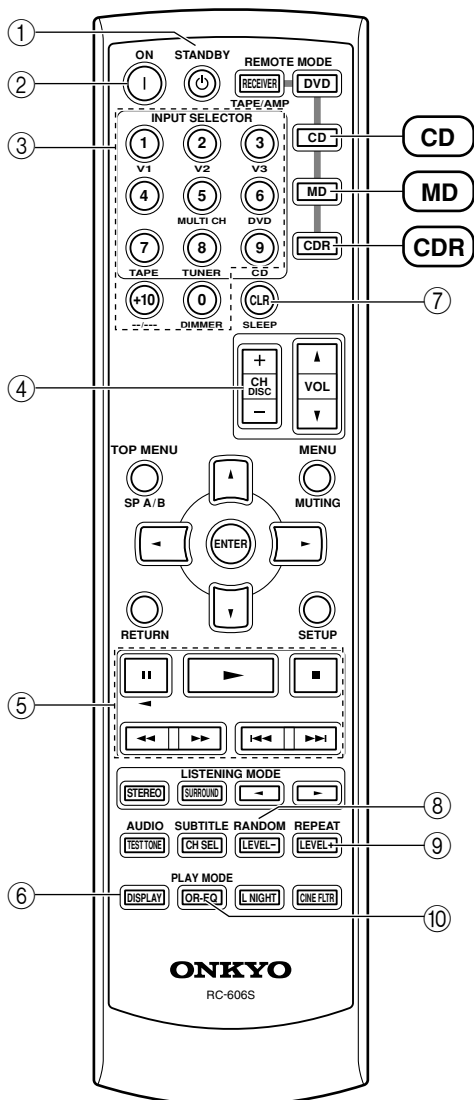

- ① **STANDBY button**
This button sets the CD player or MD/CD recorder to Standby.
- ② **ON button**
This button is used to set the CD player or MD/CD recorder to On or Standby.
- ③ **Number buttons**
These buttons are used to enter track numbers and to enter times for locating specific points in time.
- ④ **DISC +/- button**
This button selects discs on a CD changer.
- ⑤ **Playback buttons**
From left to right: Pause, Play, Stop, Fast Reverse, Fast Forward, Previous and Next.
- ⑥ **DISPLAY button**
This button is used to display information about the current disc or track on the CD player or MD/CD recorder's display, including the elapsed time, remaining time, total time, and so on.
- ⑦ **CLR button**
This button is used to cancel functions and to clear entered numbers.
- ⑧ **RANDOM button**
This button is used with the random playback function.
- ⑨ **REPEAT button**
This button is used to set the repeat playback functions.
- ⑩ **PLAY MODE button**
This button is used to select play modes on a component with selectable play modes.

TAPE Mode

TAPE mode is used to control an Onkyo cassette recorder connected to the AV receiver via **RI**.

To set the remote controller to TAPE mode, press the **[RECEIVER] REMOTE MODE** button.

Before selecting TAPE mode and starting playback, you should press the **[RECEIVER] REMOTE MODE** button followed by the **[TAPE] INPUT SELECTOR** button to select your cassette recorder as the input source.

For twin cassette decks, only deck B can be controlled.

- ① **Play [▶] button**
This button is used to start playback.
- ② **Stop [■] button**
This button is used to stop playback.
- ③ **Reverse Play [◀] button**
This button is used to start reverse playback.
- ④ **Rewind & FF [◀◀]/[▶▶] buttons**
The Rewind [◀◀] button is used to start rewind. The FF [▶▶] button is used to start fast forward.

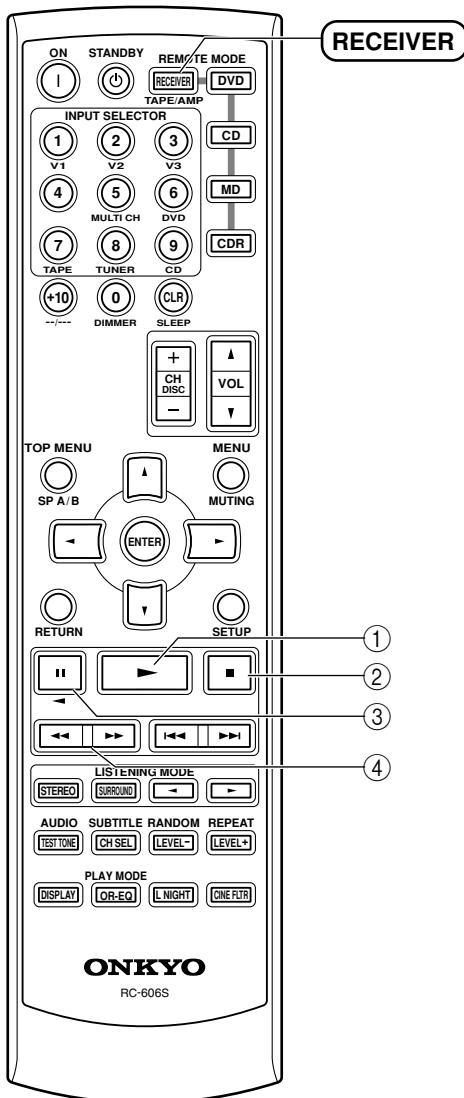

Connecting Your Speakers

Enjoying Home Theater

You can use two sets of speakers with the AV receiver: speaker set A and speaker set B.

Speaker set A should be installed in your main listening room and can be used with Dolby Digital and DTS surround material. Each speaker must be positioned at a specific location in your listening room to get the best from surround sound material. The following illustration shows the best positions for your surround-sound speakers. When speaker set B is turned on, speaker set A is reduced to 2.1-channel playback. If the multichannel DVD input is selected, and speaker set B is turned on, speaker set A is reduced to 2-channel playback.

Speaker set B can be installed in another room. Speakers can be positioned in the standard position for stereo speakers or however you like.

Front left and right speakers (SKF-330F L/R)

These output the overall sound. Their role in a home theater is to provide a solid anchor for the sound image. They should be positioned facing the listener at about ear level, and equidistant from the TV. Angle them inward so as to create a triangle, with the listener at the apex.

Center speaker (SKC-330C)

This speaker enhances the front left and right speakers, making sound movements distinct and providing a full sound image. In movies it's used mainly for dialog.

Position it close to your TV (preferably on top) facing forward at about ear level, or at the same height as the front left and right speakers.

Subwoofer (SKW-330)

The subwoofer handles the bass sounds of the LFE (Low-Frequency Effects) channel. The volume and quality of the bass output from your subwoofer will depend on its position, the shape of your listening room, and your listening position. In general, a good bass sound can be obtained by installing the subwoofer in a front corner, or at one-third the width of the wall, as shown.

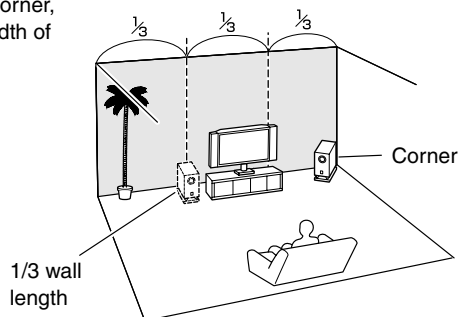

Surround left and right speakers (SKM-330S L/R)

These speakers are used for precise sound positioning and to add realistic ambience. Position them at the sides of the listener, or slightly behind, about 2–3 feet (60–100 cm) above ear level. Ideally they should be equidistant from the listener.

To get the very best from your surround-sound system, you should also specify the distance between the listener and each individual speaker so that the sound from each speaker arrives at the listener's ears at the same time (see page 51). In addition, you should set the level of each individual speaker to achieve an equal balance (see page 51).

Speaker Connection Precautions

Read the following before connecting your speakers:

- You can connect speakers with an impedance of **8 ohms or higher**. If you use speakers with a lower impedance, and use the amplifier at high volume levels for a long period of time, the built-in protection circuit may be activated.
- Disconnect the power cord from the wall outlet before making any connections.
- Pay close attention to speaker polarity. In other words, connect positive (+) terminals to only positive (+) terminals, and negative (–) terminals to only negative (–) terminals. If you get them the wrong way around, the sound will be out of phase and will sound unnatural.
- Unnecessarily long, or very thin speaker cables may affect the sound quality and should be avoided.
- Be careful not to short the positive and negative wires. Doing so may damage the AV receiver.
- Don't connect more than one cable to each speaker terminal. Doing so may damage the AV receiver.
- Don't connect one speaker to several terminals.

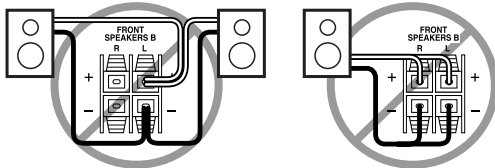
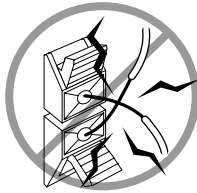

Connecting Speaker

The AV receiver's positive (+) speaker terminals are color-coded for ease of identification. (The negative (–) speaker terminals are all black.)

Speaker terminal	Color
Front left	White
Front right	Red
Center	Green
Surround left	Blue
Surround right	Gray
Subwoofer	Purple

- 1 Strip 3/8" (10 mm) of insulation from the ends of the speaker cables. (Supplied speaker cables are already stripped.)

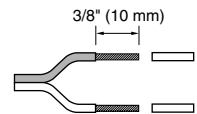

- 2 While pressing the lever, insert the wire into the hole, and then release the lever. Make sure that the terminals are gripping the bare wires, not the insulation.

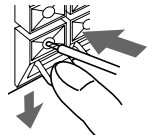

Note:

When speaker set B is turned on, speaker set A is reduced to 2.1-channel playback.

The following illustration shows which speaker should be connected to each pair of terminals.

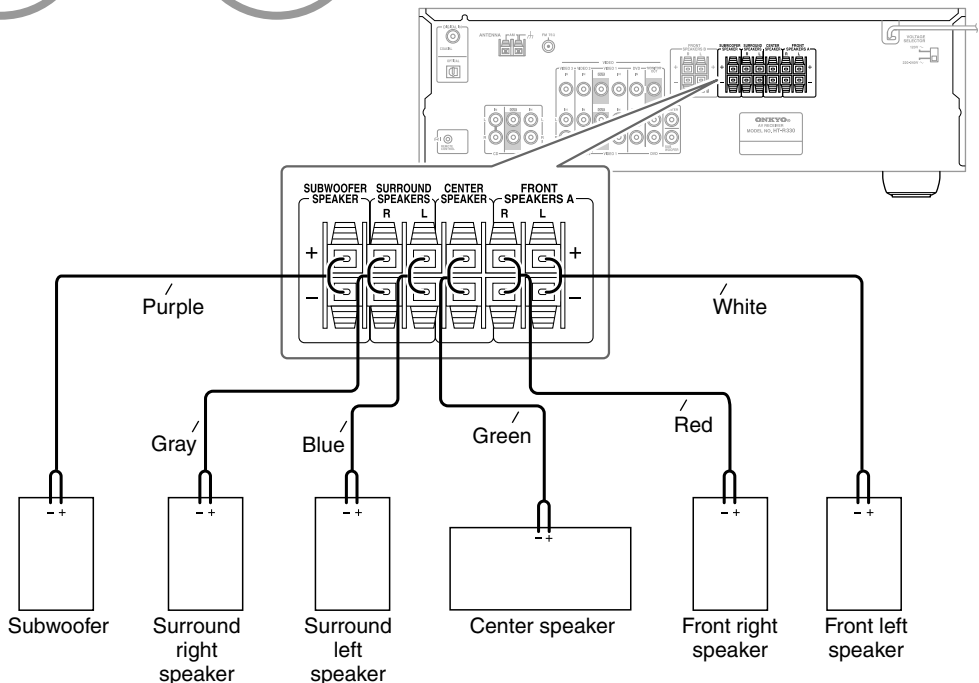

Connecting Your Speakers—Continued

Wall Mounting

The speakers can easily be wall mounted by using the keyhole slots. To prevent the speaker from vibrating against the wall, attach four of the supplied spacers to the keyhole fins on the rear of each speaker.

To mount the front or surround speakers vertically, use the keyhole slot shown to hang each speaker on a screw that's securely screwed into the wall.

Front speaker (SKF-330F)
Surround speaker (SKM-330S)

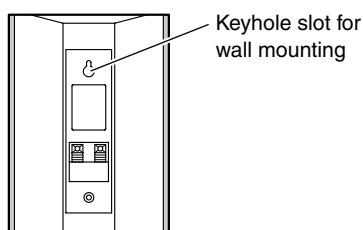

To mount the center speaker horizontally, use the two keyhole slots shown to hang each speaker on two screws that are securely screwed into the wall.

Center speaker (SKC-330C)

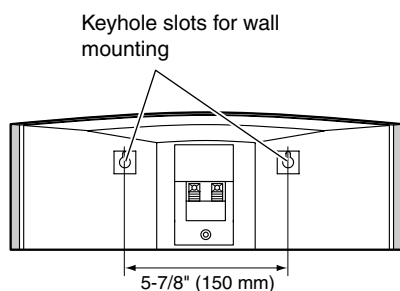

Caution:

A mounting screw's ability to support a speaker depends on how well it's anchored to the wall. If you have hollow walls, screw each mounting screw into a stud. If there are no studs, or the walls are solid, use suitable wall anchors. Use screws with a head diameter of 5/16" (9 mm) or less and a shank diameter of 1/8" (4 mm) or less. With hollow walls, use a cable/pipe detector to check for any power cables or water pipes before making any holes.

Leave a gap of between 5/16" (7 mm) and 7/16" (10 mm) between the wall and the base of the screw head, as shown.

(We recommend that you consult a home installation professional.)

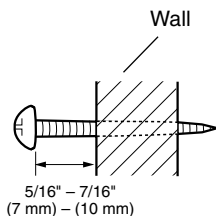

Using Speaker Mounts/Brackets

Threaded inserts for machine screws are provided on the rear of each speaker for wall-mounting with commercially available speaker mounts or brackets. North American models require 1/4-inch screws. Other models require M5 (5 mm) screws. Refer to the manual supplied with your mounts or brackets for installation details.

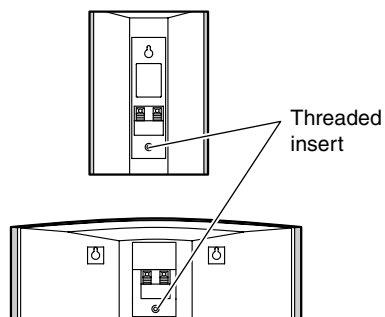

Note:

The portion of the screw that goes into the speaker's threaded insert should be between 1/4" - 5/16" (5 mm - 8 mm) long.

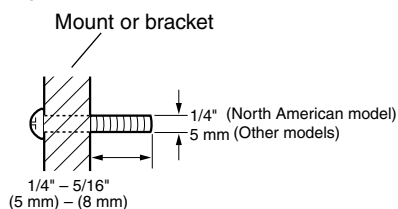

Using Rubber Stoppers with the Speakers

We recommend using the provided rubber stoppers to achieve the best possible sound from your speakers. The rubber stoppers prevent the speakers from moving, providing a more stable setup.

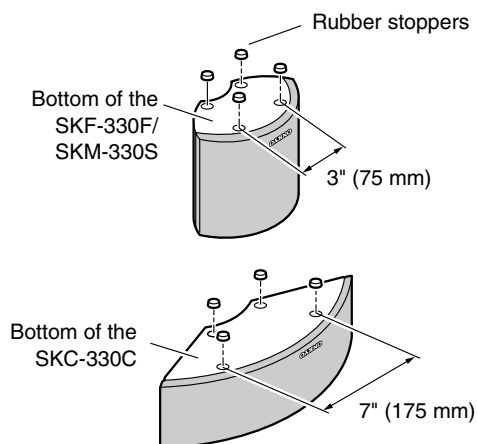

Connecting Antenna

This section explains how to connect the supplied indoor FM antenna and AM loop antenna, and how to connect commercially available outdoor FM and AM antennas. The AV receiver won't pick up any radio signals without any antenna connected, so you must connect the antenna to use the tuner.

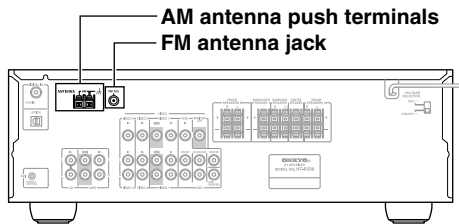

Connecting the Indoor FM Antenna

The supplied indoor FM antenna is for indoor use only.

1 Attach the FM antenna, as shown.

■ American Model

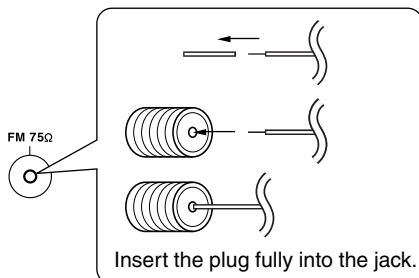

■ Other Models

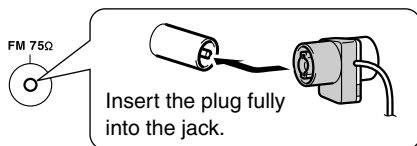

Once your AV receiver is ready for use, you'll need to tune into an FM radio station and adjust the position of the FM antenna to achieve the best possible reception.

2 Fully extend the antenna and point it in various directions to find the best reception. Secure it in that position with thumbtacks or something similar.

If you cannot achieve good reception with the supplied indoor FM antenna, try a commercially available outdoor FM antenna instead (see page 21).

Connecting the AM Loop Antenna

The supplied indoor AM loop antenna is for indoor use only.

1 Assemble the AM loop antenna, inserting the tabs into the base, as shown.

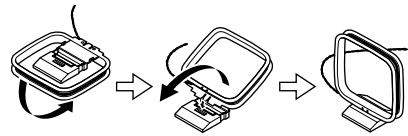

2 Connect both wires of the AM loop antenna to the AM push terminals, as shown.

(The antenna's wires are not polarity sensitive, so they can be connected either way around).

Make sure that the wires are attached securely and that the push terminals are gripping the bare wires, not the insulation.

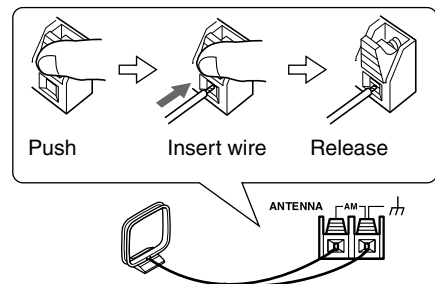

Once your AV receiver is ready for use, you'll need to tune into an AM radio station and adjust the position of the AM antenna to achieve the best possible reception.

Keep the antenna as far away as possible from your AV receiver, TV, speaker cables, and power cords.

If you cannot achieve good reception with the supplied indoor AM loop antenna, try using it with a commercially available outdoor AM antenna (see page 21).

Connecting Antenna—Continued

Connecting an Outdoor FM Antenna

If you cannot achieve good reception with the supplied indoor FM antenna, try a commercially available outdoor FM antenna instead.

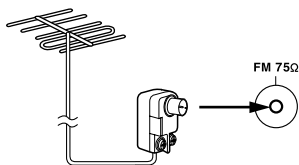

Notes:

- Outdoor FM antennas work best outside, but usable results can sometimes be obtained when installed in an attic or loft.
- For best results, install the outdoor FM antenna well away from tall buildings, preferably with a clear line of sight to your local FM transmitter.
- Outdoor antenna should be located away from possible noise sources, such as neon signs, busy roads, etc.
- For safety reasons, outdoor antenna should be situated well away from power lines and other high-voltage equipment.
- Outdoor antenna must be grounded in accordance with local regulations to prevent electrical shock hazards.

■ Using a TV/FM Antenna Splitter

It's best not to use the same antenna for both FM and TV reception, as this can cause interference problems. If circumstances demand it, use a TV/FM antenna splitter, as shown.

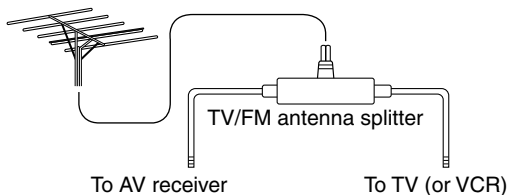

Connecting an Outdoor AM Antenna

If good reception cannot be achieved using the supplied AM loop antenna, an outdoor AM antenna can be used in addition to the loop antenna, as shown.

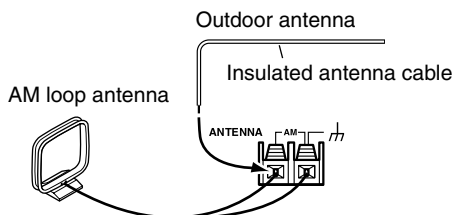

Outdoor AM antennas work best when installed outside horizontally, but good results can sometimes be obtained indoors by mounting horizontally above a window. Note that the AM loop antenna should be left connected. Outdoor antenna must be grounded in accordance with local regulations to prevent electrical shock hazards.

Connecting Your Components

About AV Connections

- Before making any AV connections, read the manuals supplied with your other AV components.
- Don't connect the power cord until you've completed and double-checked all AV connections.

Optical Digital Jacks

The AV receiver's optical digital jack has shutter-type cover that open when an optical plug is inserted and close when it's removed. Push plugs in all the way.

Caution: To prevent shutter damage, hold the optical plug straight when inserting and removing.

AV Connection Color Coding

RCA-type AV connections are usually color coded: red, white, and yellow. Use red plugs to connect right-channel audio inputs and outputs (typically labeled "R"). Use white plugs to connect left-channel audio inputs and outputs (typically labeled "L"). And use yellow plugs to connect composite video inputs and outputs.

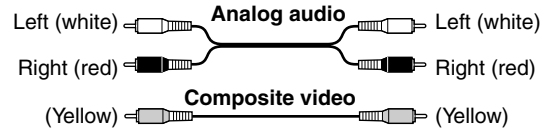

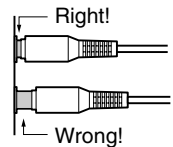

- Push plugs in all the way to make good connections (loose connections can cause noise or malfunctions).
- To prevent interference, keep audio and video cables away from power cords and speaker cables.





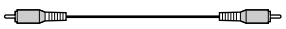



AV Cables & Jacks

Video

Cable	Jack	Description
		Composite video is commonly used on TVs, VCRs, and other video equipment. Use only dedicated composite video cables.

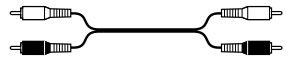
Audio

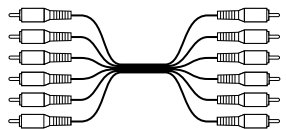
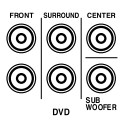
Cable	Jack	Description
		Offers the best sound quality and allows you to enjoy surround sound (e.g., Dolby Digital, DTS). The audio quality is the same as for coaxial.
		Offers the best sound quality and allows you to enjoy surround sound (e.g., Dolby Digital, DTS). The audio quality is the same as for optical.
		This cable carries analog audio. It's the most common connection format for analog audio and can be found on virtually all AV components.
		This cable carries multichannel analog audio and is typically used to connect DVD players with a 5.1-channel analog audio output. Several standard analog audio cables can be used instead of a multichannel cable.

Note: The AV receiver does not support SCART plugs.

Connecting Both Audio & Video

By connecting both the audio and video outputs of your DVD player and other AV components to the AV receiver, you can select both the audio and video simultaneously simply by selecting the appropriate input source on the AV receiver.

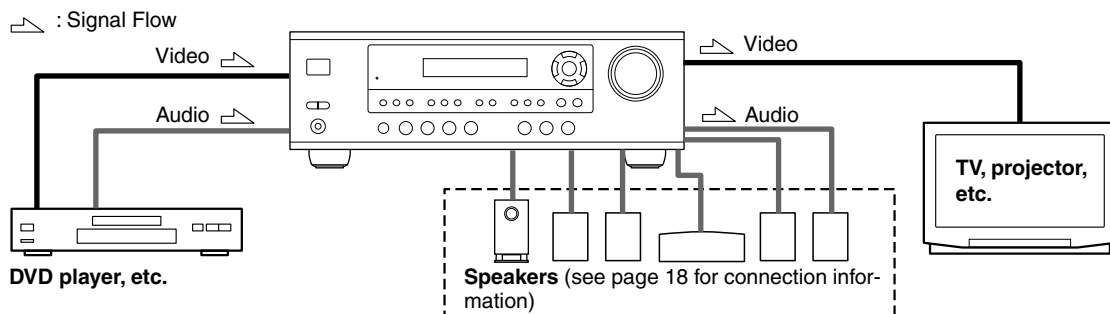

Which Connections Should I Use?

The AV receiver supports several connection formats for compatibility with a wide range of AV equipment. The format you choose will depend on the formats supported by your other components. Use the following sections as a guide. For video components, such as a DVD player, you must make two connections—one for audio, one for video.

Audio Connection Formats

Audio equipment can be connected to the AV receiver using the following audio connection formats: analog, optical, coaxial, and multichannel.

When choosing a connection format, bear in mind that the AV receiver doesn't convert between formats.

For example, audio signals connected to an OPTICAL or COAXIAL digital input are not output by the analog TAPE OUT, so if you want to record from, for example, your CD player, in addition to connecting it to a digital input, you must also connect it to the analog CD IN.

Audio Input/Output Diagram for Recording

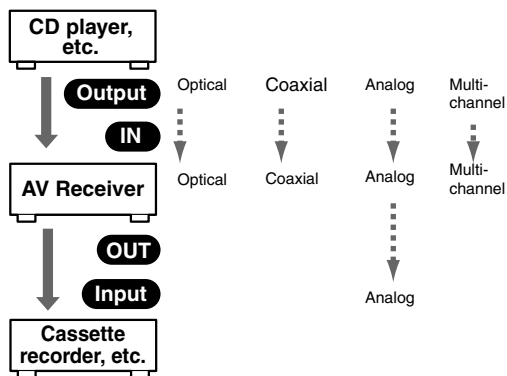

Connecting Your Components—Continued

Connecting a TV or Projector

Step 1: Video Connection

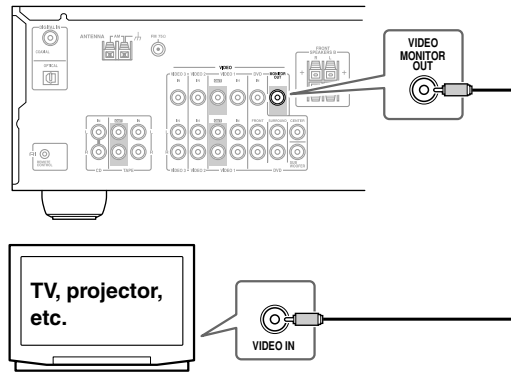

Connection	HT-R330	Signal flow	TV
	MONITOR OUT VIDEO	⇒	Composite video input

Step 2: Audio Connection

Choose a connection type **a**, **b**, or **c** that matches the TV, and then make the connection.

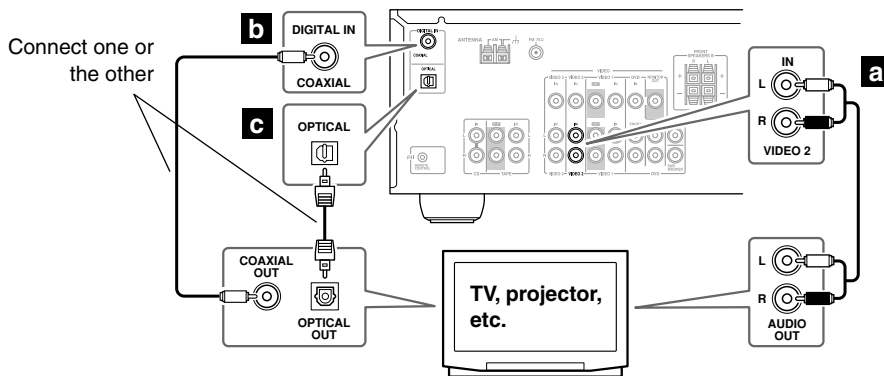

- With the basic **a** connection, you can listen to or record audio from the TV.
- To enjoy Dolby and DTS listening modes, use connection **b** or **c**. (Use **a** and **b** or **a** and **c** for recording.)

Connection	HT-R330	Signal flow	TV
a	VIDEO 2 IN L/R	←	Analog audio L/R output
b	DIGITAL IN COAXIAL	←	Digital coaxial output
c	DIGITAL IN OPTICAL	←	Digital optical output

Hint!

If your TV has no audio outputs, connect your VCR to the AV receiver and use its tuner.

Connecting Your Components—Continued

Connecting a DVD player

Step 1: Video Connection

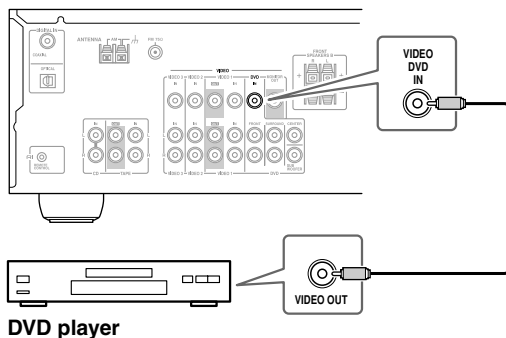

Connection	HT-R330	Signal flow	DVD player
	DVD IN VIDEO	←	Composite video output

Step 2: Audio Connection

Choose a connection type **(a, b, c, or d)** that matches your DVD player, and then make the connection.

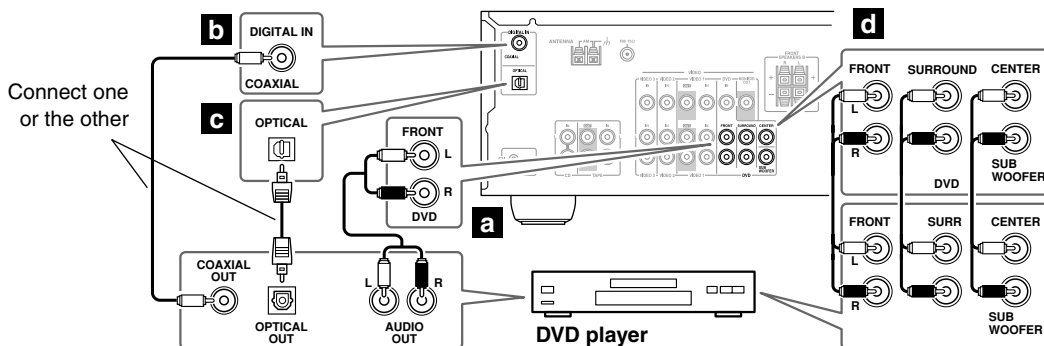

- With the basic **a** connection, you can listen to or record audio from a DVD.
- To enjoy Dolby and DTS listening modes, use connection **b** or **c**. (Use **a** and **b** or **a** and **c** for recording.)
- To enjoy DVD-Audio or SACD playback from a compatible DVD player with an analog multichannel output, use connection **d**.

Connection	HT-R330	Signal flow	DVD player
a	DVD IN FRONT	←	Analog audio L/R output
b	DIGITAL IN COAXIAL	←	Digital coaxial output
c	DIGITAL IN OPTICAL	←	Digital optical output
d	DVD IN FRONT, SURROUND, CENTER, and SUBWOOFER	←	Analog multichannel output

- If your DVD player has main left and right outputs and multichannel left and right outputs, be sure to use the main left and right outputs for connection **a**.

Connecting Your Components—Continued

Connecting a VCR or DVD Recorder for Playback

In addition to video playback, with this hookup example, you can use the VCR's tuner to listen to the sound of your favorite TV programs via the AV receiver. This is useful if the TV has no audio outputs.

Step 1: Video Connection

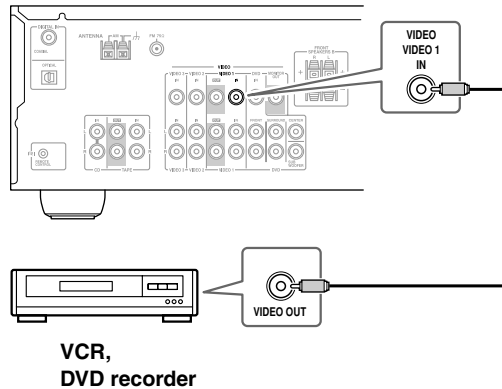

Connection	HT-R330	Signal flow	VCR/DVD recorder
	VIDEO 1 IN VIDEO	←	Composite video output

Step 2: Audio Connection

Choose a connection type **a**, **b**, or **c**, and then make the connection.

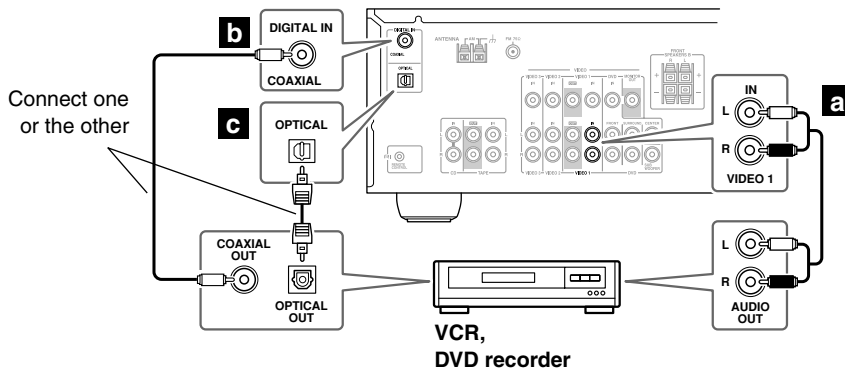

- With the basic **a** connection, you can listen to the VCR/DVD recorder.
- To enjoy Dolby and DTS listening modes, use connection **b** or **c**. (Use **a** and **b** or **a** and **c** to listen via speaker set B.)

Connection	HT-R330	Signal flow	VCR/DVD recorder
a	VIDEO 1 IN L/R	←	Analog audio L/R output
b	DIGITAL IN COAXIAL	←	Digital coaxial output
c	DIGITAL IN OPTICAL	←	Digital optical output

Connecting Your Components—Continued

Connecting a VCR or DVD Recorder for Recording

Step 1: Make video connection **A**.

Step 2: Make audio connection **a**.

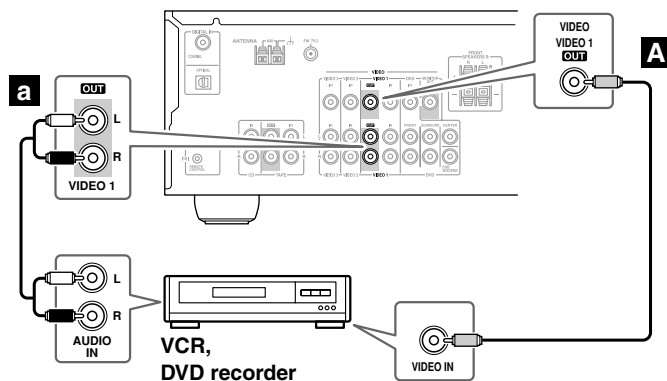

Connection	HT-R330	Signal flow	VCR/DVD recorder
A	VIDEO 1 OUT VIDEO	⇒	Composite video input
a	VIDEO 1 OUT L/R	⇒	Audio L/R input

Connecting a Camcorder, Games Console, or Other Device

Step 1: Make video connection **A**.

Step 2: Make audio connection **a**.

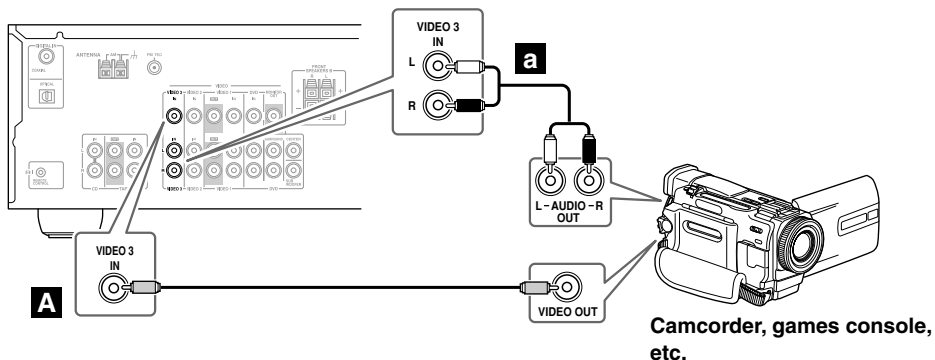

Connection	HT-R330	Signal flow	Camcorder/console
A	VIDEO 3 IN	←	Composite video output
a	VIDEO 3 IN L/R	←	Analog audio L/R output

Connecting Your Components—Continued

Connecting a Satellite, Cable, Set-top box, or Other Video Source

Step 1: Video Connection

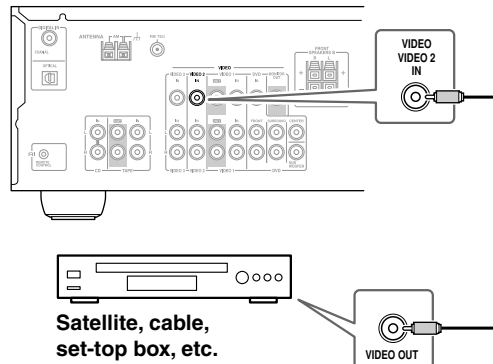

Connection	HT-R330	Signal flow	Video source
	VIDEO 2 IN VIDEO	←	Composite video output

Step 2: Audio Connection

Choose a connection type **a**, **b**, or **c** that matches the video source, and then make the connection.

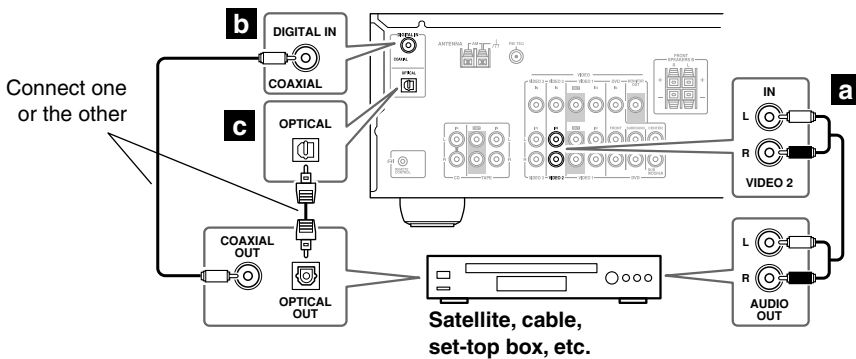

- With the basic **a** connection, you can listen to or record audio from the video source.
- To enjoy Dolby and DTS listening modes, use connection **b** or **c**. (Use **a** and **b** or **a** and **c** for recording.)

Connection	HT-R330	Signal flow	Video source
a	VIDEO 2 IN L/R	←	Analog audio L/R output
b	DIGITAL IN COAXIAL	←	Digital coaxial output
c	DIGITAL IN OPTICAL	←	Digital optical output

Connecting a CD Player or Turntable

■ CD Player, or Turntable with Built-in Phono Preamp

Step 1:

Choose a connection type (**a**, **b**, or **c**) that matches the CD player, or choose **a** for a turntable with a built-in phono preamp, and then make the connection.

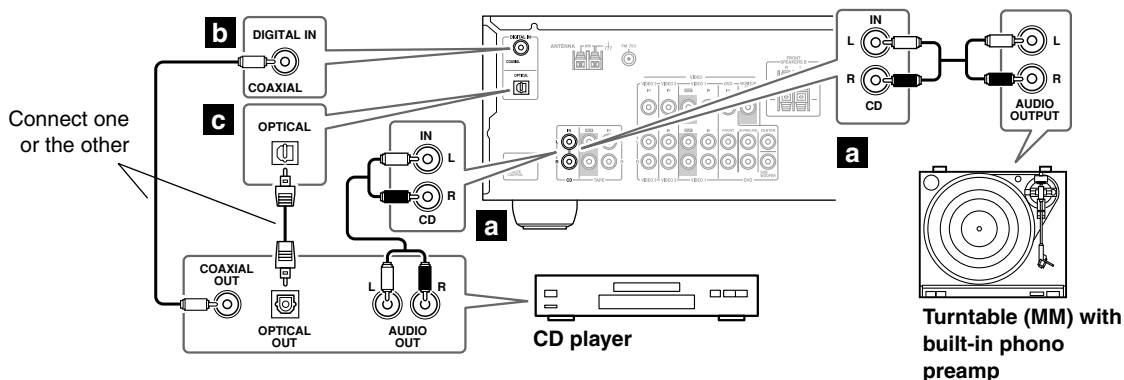

- With the basic **a** connection, you can listen to or record audio from the CD player or turntable.
- To connect the CD player digitally, use connection **b** or **c**. (Use **a** and **b** or **a** and **c** for recording.)

Connection	HT-R330	Signal flow	CD or turntable
a	CD IN L/R	←	Analog audio L/R output
b	DIGITAL IN COAXIAL	←	Digital coaxial output
c	DIGITAL IN OPTICAL	←	Digital optical output

■ Turntable with no Phono Preamp Built-in

A phono preamp is necessary to connect a turntable that doesn't have a phono preamp built-in.

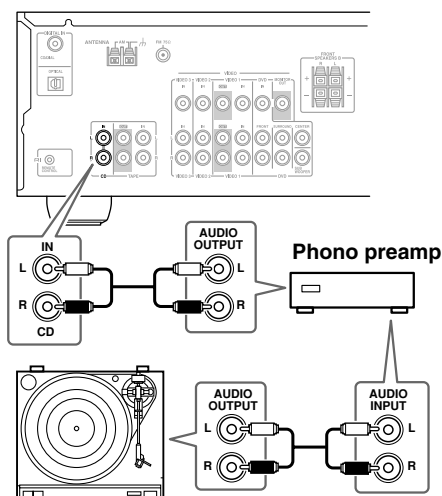

■ Turntable with an MC (Moving Coil) Cartridge

An MC head amp and phono preamp are necessary to connect a turntable with an MC (Moving Coil) cartridge.

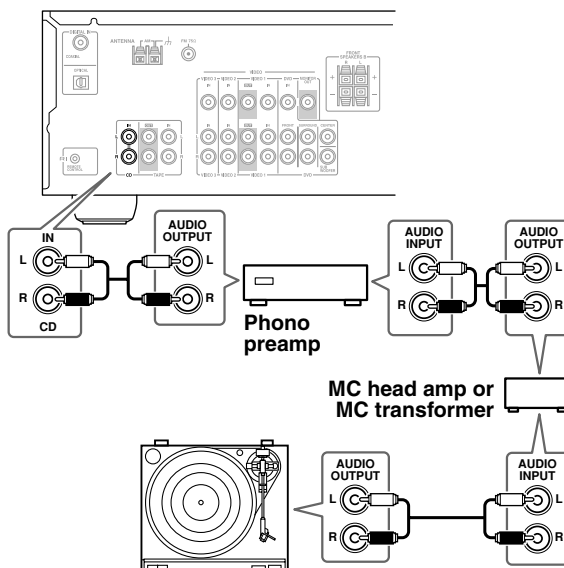

Connecting a Cassette, CDR, MiniDisc, or DAT Recorder

Step 1:

Choose a connection type (**a**, **b**, or **c**) that matches the recorder, and then make the connection.

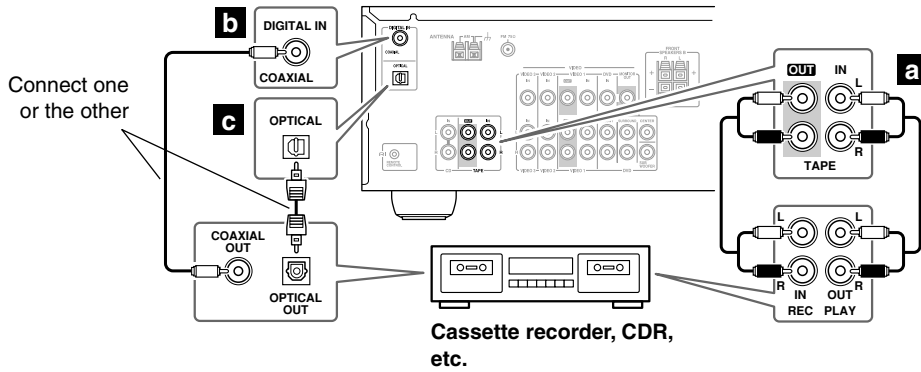

- With the basic **a** connection, you can play and record with the recorder.
- To connect the recorder digitally for playback purposes, use connections **a** and **b** or **a** and **c**.

Connection	HT-R330	Signal flow	Cassette/CDR/MD/DAT recorder
a	TAPE IN L/R TAPE OUT L/R	← ⇒	Analog audio L/R output Analog audio L/R input
b	DIGITAL IN COAXIAL	←	Digital coaxial output
c	DIGITAL IN OPTICAL	←	Digital optical output

Connecting Onkyo **RI** Components

Step 1: Be sure that the Onkyo component is connected to the AV receiver with an analog audio cable (RCA).

Step 2: Make the **RI** connection.

With **RI** (Remote Interactive) you can use the following special **RI** functions:

Auto Power On/Standby

When you start playback on a component connected via **RI**, if the AV receiver is in Standby, it will turn on and select that component as the input source automatically. Similarly, when the AV receiver is set to Standby, all components connected via **RI** will also enter Standby. This function will not work if a component's power cord is connected to the AV receiver's AC OUTLET.

Direct Change

When playback is started on a component connected via **RI**, the AV receiver automatically selects that component as the input source. If the DVD player is connected to the AV receiver's multichannel input, you must press the [MULTI CH] button (see page 37) to listen to all channels because the Direct Change **RI** function selects only the DVD IN FRONT jacks.

Notes:

- Use only **RI** cables for **RI** connections. **RI** cables are supplied with Onkyo players (DVD, CD, etc.).
- Some components have two **RI** jacks, you can connect either one to the AV receiver. The other is for connecting additional **RI**-compatible components.
- Connect the AV receiver's **RI** jack to only Onkyo components. Connecting to other manufacturer's components may cause them to malfunction.
- Some components may not support all **RI** functions. Refer to the manuals supplied with your components.

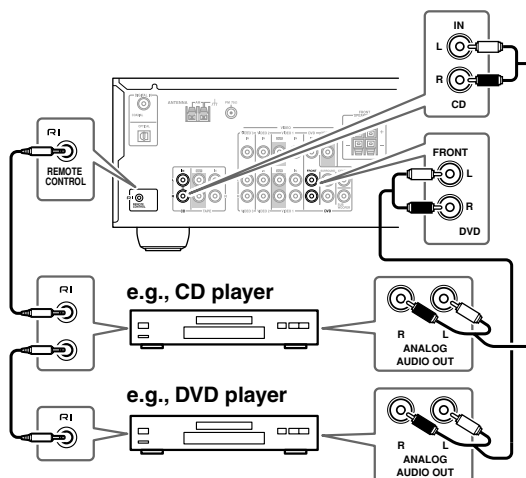

Connecting the Power Cord

Notes:

- **Before connecting the power cord, connect all of your speakers and AV components.**
- Turning on the AV receiver may cause a momentary power surge that might interfere with other electrical equipment on the same circuit. If this is a problem, plug the AV receiver into a different branch circuit.

Turning On

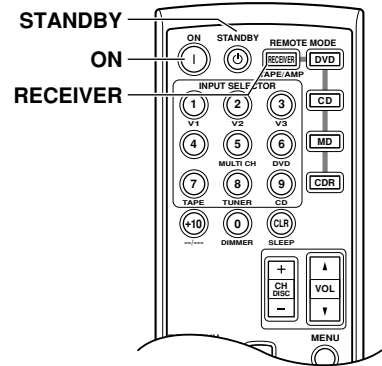
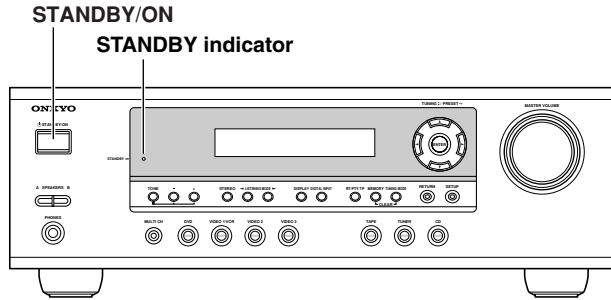

Turning On the AV Receiver

1

AV receiver



or

Remote controller

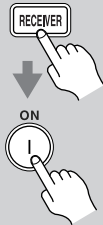

Press the [STANDBY/ON] button.

Alternatively, press the remote controller's [RECEIVER] button followed by the [ON] button.

The AV receiver comes on, the display lights up, and the STANDBY indicator goes off.

To turn the AV receiver off, press the [STANDBY/ON] button, or the remote controller's [STANDBY] button. The AV receiver will enter Standby mode. To prevent any loud surprises the next time you turn on the AV receiver, always turn down the volume before turning it off.

Smooth Operation in a Few Easy Steps

To ensure smooth operation, here's a few easy steps to help you configure the AV receiver before you use it for the very first time. These settings only need to be made once.

■ **Have you connected a component to a digital audio input?**

If you have, see "Assigning Digital Inputs to Input Sources" on page 33.

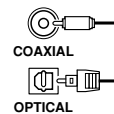

■ **Have you connected an Onkyo MD recorder or CD recorder to the TAPE IN/OUT jacks?**

If you have, see "Changing the TAPE/MD/CDR Display" on page 33.

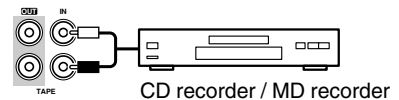

■ **Do the speaker configuration—this is essential!**

See "Speaker Configuration" on page 34.



First Time Setup

Assigning Digital Inputs to Input Sources

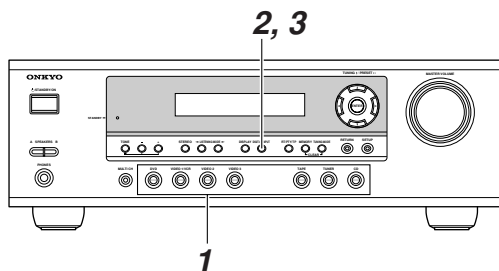

To enjoy Dolby Digital and DTS, you must connect your DVD player to the AV receiver by using a digital audio connection (coaxial or optical).

With this function, you can assign digital inputs to input sources. For example, if you connect your DVD player to DIGITAL IN OPTICAL, you'll need to assign that input (OPT) to the DVD input source.

You can change the assignments as follows.

Note:

Make sure you also set your digital sources to send out a digital signals. Please refer to the digital sources' manual.

<p>1</p>	<p>Press the input selector button for the source that you want to assign. (Digital inputs cannot be assigned to the TUNER input source.)</p>
<p>2</p>	<p>Press the [DIGITAL INPUT] button. The current assignment appears.</p> <div style="border: 1px solid black; padding: 2px; width: fit-content; margin: 5px auto;">DVD # COAX</div>
<p>3</p>	<p>Press the [DIGITAL INPUT] button repeatedly to select COAX, OPT or "----" (analog).</p> <div style="border: 1px solid black; padding: 2px; width: fit-content; margin: 5px auto;">DVD # OPT</div>

Changing the TAPE/MD/CDR Display

If you connect an **RI**-compatible Onkyo MiniDisc recorder or CD recorder to the TAPE IN/OUT jacks, for **RI** to work properly, you must change this setting. This setting can only be changed on the AV receiver.

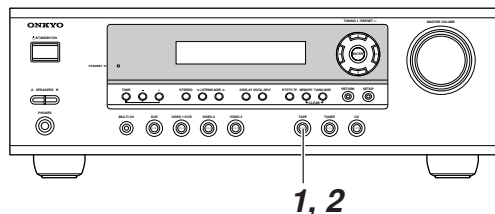

<p>1</p>	<p>Press the [TAPE] input selector button so that "TAPE" appears on the display.</p> <div style="border: 1px solid black; padding: 2px; width: fit-content; margin: 5px auto;">TAPE</div>
<p>2</p>	<p>Press and hold down the [TAPE] input selector button (about 3 seconds) to set the display. Repeat this step to select TAPE, MD, or CDR.</p> <div style="border: 1px solid black; padding: 2px; width: fit-content; margin: 5px auto; margin-bottom: 5px;">MD</div> <div style="border: 1px solid black; padding: 2px; width: fit-content; margin: 5px auto;">CDR</div>

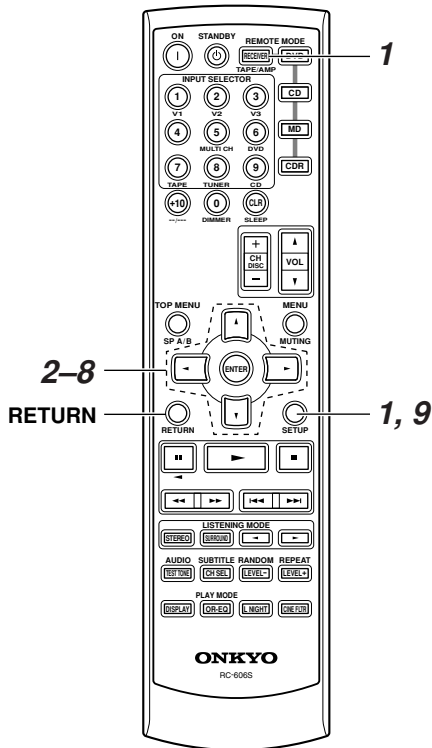

Speaker Configuration

This section explains how to specify which speakers are connected and their sizes.

For speakers with a cone diameter larger than 6-1/2 inches (16 cm), specify **Large**. For those with a smaller diameter, specify **Small**.

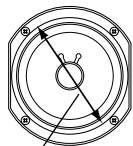

Cone diameter

1 Press the [RECEIVER] button followed by the [SETUP] button.

2 Use the Up and Down [▲]/[▼] buttons to select "1. Speaker Config," and then press the [ENTER] button.

1. Speaker Config

3 While the Subwoofer setting is selected, use the Left and Right [◀]/[▶] buttons to select **Yes** or **No**.

Yes: Select if a subwoofer is connected.
No: Select if no subwoofer is connected.

4 Use the Down [▼] button to select "Front," and then use the Left and Right [◀]/[▶] buttons to select **Small** or **Large**.

Small: Select if the front speakers are small.
Large: Select if the front speakers are large.

Note:

- If the Subwoofer setting in step 3 is set to No, this setting is fixed at Large and does not appear.

5 Use the Down [▼] button to select "Center," and then use the Left and Right [◀]/[▶] buttons to select **Small**, **Large**, or **None**.

Small: Select if the center speaker is small.
Large: Select if the center speaker is large.
None: Select if no center speaker is connected.

Note:

- If the Front setting in step 4 is set to Small, the Large option cannot be selected.

6

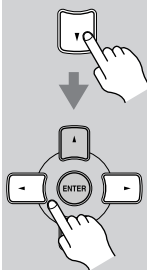

Use the Down [▼] button to select “Surround,” and then use the Left and Right [◀]/[▶] buttons to select **Small, Large, or None**.

Small: Select if the surround speakers are small.

Large: Select if the surround speakers are large.

None: Select if no surround speakers are connected.

Note:

- If the Front setting in step 4 is set to Small, the Large option cannot be selected.

7



Press the [SETUP] button.

Setup closes.

TESTING THE SPEAKERS

To test that all of the speakers are working properly, **press the remote controller’s [TEST TONE] button**. The test tone will be output by each speaker in turn and the name of each speaker will appear on the display. To turn off the test tone, press the [TEST TONE] button again.

- If the test tone is not produced by a speaker, or it’s produced by a speaker other than that shown on the display, you may have wired the speakers incorrectly and you should check your connections (see page 18).
- If the test tone is not produced by a speaker and its name does not appear on the display, you may have set the speaker settings incorrectly (see page 34).

Playing Your AV Components

Basic AV Receiver Operation

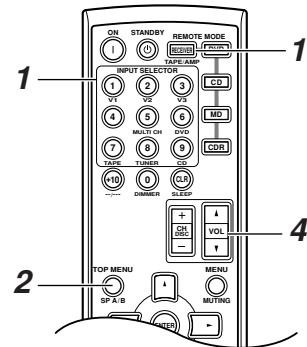
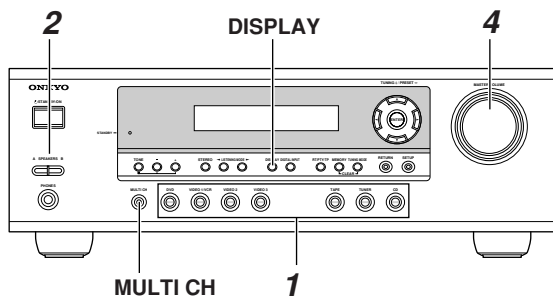

- 1**

Remote controller

Use the AV receiver's input selector buttons to select the input source.

To select the input source with the remote controller, press the [RECEIVER] button, and then use the INPUT SELECTOR buttons.

On the remote controller, the [V1], [V2], and [V3] buttons select the VIDEO 1/VCR, VIDEO 2, and VIDEO 3 input sources respectively.
- 2**

AV receiver

Remote controller

Use the SPEAKERS [A] and [B] buttons on the AV receiver or the [SP A/B] button on the remote controller to select the speaker set that you want to use.

Pressing the remote controller's [SP A/B] button cycles through the following settings: Speaker Set A → Speaker Set A&B → Speaker Set B → Off.

The A and B speaker indicators show whether each speaker set is on or off.

Note that when speaker set B is turned on, speaker set A is reduced to 2.1-channel playback.

A B — Indicators
- 3**

Start playback on the source component.

When you select DVD or another video component, on your TV you'll need to select the video input that's connected to the AV receiver's MONITOR OUT.
- 4**

AV receiver

Remote controller

To adjust the volume, use the MASTER VOLUME control, or the remote controller's [VOL] button.

The volume can be set to MIN, 1 through 79, or MAX. The AV receiver is designed for home theater enjoyment and has a wide volume range for precise adjustment.
- 5**

Select a suitable listening mode and enjoy!

See page 44.

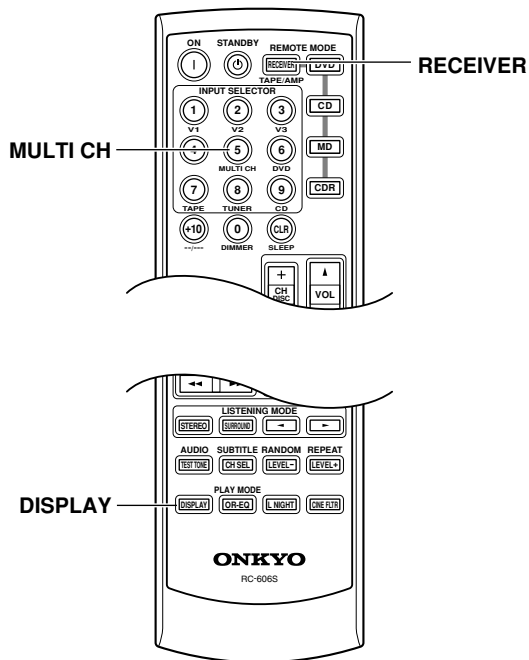

Using the Multichannel Input

The multichannel input is for connecting a component with individual 5.1-channel analog audio output jacks, such as a DVD player or MPEG decoder. See page 25 for hookup information.

Press the [RECEIVER] button followed by the [MULTI CH] button so that MULTI CH indicator appears on the display.

Audio from the multichannel input will now be used for the DVD input source.

MULTI CH indicator

DVD

Note:

- While the multichannel input is selected, the Speaker Configuration settings on page 34 are ignored, and signals from the multichannel input are fed to the front left, front right, center, surround left, and surround right speakers and subwoofer regardless of those settings.

Displaying Source Information

You can display various information about the current input source as follows.

Press the [RECEIVER] button, and then press the [DISPLAY] button repeatedly to cycle through the available information.

The following information can typically be displayed for input sources.

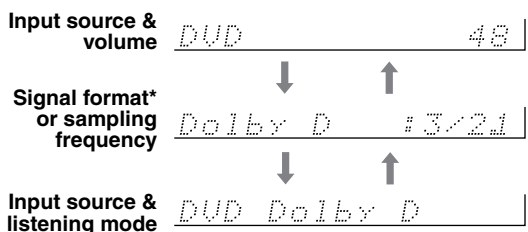

*If the input signal is analog, no format information is displayed. If the input signal is PCM, the sampling frequency is displayed. If the input signal is digital but not PCM, the signal format is displayed. Information is displayed for about three seconds, then the previously displayed information reappears.

Interpreting Surround Channel Information

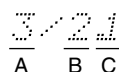

- A: The number of front channels (front left, front right, and center).
- B: The number of surround channels (surround left and surround right). If there's surround back channel information, this number will be 3.
- C: LFE channel for subwoofer (1 means yes).

Using the Tuner

Listening to the Radio

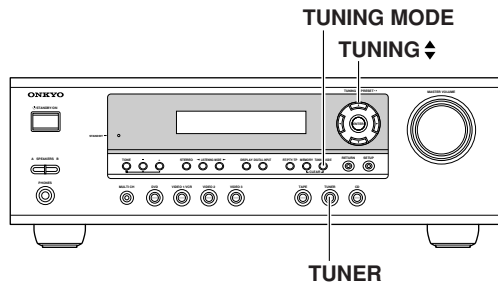

With the built-in tuner, you can enjoy AM and FM radio stations. You can store your favorite stations as presets for quick selection.

1		<p>Use the [TUNER] input selector button to select either AM or FM. In this example, FM has been selected.</p>
<p>(Actual display depends on country.)</p>		

AM Frequency Step Setup (not North America and Europe)

Here you can specify the AM frequency step used in your area. When this setting is changed, all radio presets are deleted.

1	<p>Press the [SETUP] button and use the Up and Down [▲]/[▼] buttons to select “0. Hardware Setup,” and then press [ENTER].</p>
2	<p>Use the Up and Down [▲]/[▼] buttons to select “AM Freq,” and then use the Left and Right [◀]/[▶] buttons to select:</p> <p>10 kHz: Select if 10 kHz steps are used in your area.</p> <p>9 kHz: Select if 9 kHz steps are used in your area.</p>
3	<p>Press the [SETUP] button. Setup closes.</p>

Note:

- This procedure can also be performed on the remote controller by using its [SETUP] button, arrow buttons, and [ENTER] button.

Tuning into Radio Stations

Auto Tuning Mode

1		<p>Press the [TUNING MODE] button so that the AUTO indicator appears on the display.</p>
2		<p>Press the TUNING Up or Down [▲]/[▼] button. Searching stops when a station is found.</p>

When tuned into a station, the TUNED indicator appears. When tuned into a stereo FM station, the FM STEREO indicator appears on the display, as shown.

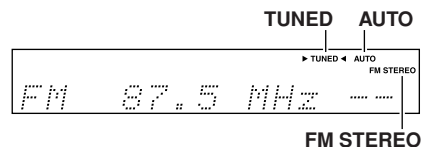

Manual Tuning Mode

1		<p>Press the [TUNING MODE] button so that the AUTO indicator disappears from the display.</p>
2		<p>Press and hold the TUNING Up or Down [▲]/[▼] button. The frequency stops changing when you release the button. Press the buttons repeatedly to change the frequency one step at a time.</p>

The American model changes FM frequency in 0.2 MHz steps, 10 kHz steps for AM. For other models it's 0.05 MHz steps for FM and 9 kHz steps for AM.

In Manual Tuning mode, FM stations will be in mono.

Tuning into weak FM stereo stations

If the signal from a stereo FM station is weak, it may be impossible to get good reception. In this case, switch to Manual Tuning mode and listen to the station in mono.

Using the Tuner—Continued

Presetting Radio Stations

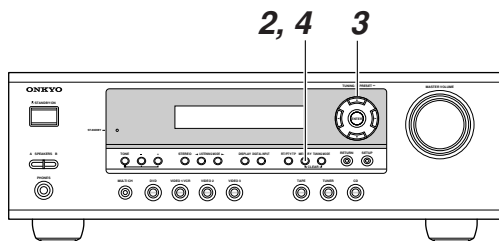

You can store up to 30 of your favorite radio stations as presets.

- 1** Tune into the station that you want to store as a preset.
- 2** Press the [MEMORY] button. The MEMORY indicator appears and the preset number flashes.
- 3** While the MEMORY indicator is displayed (about 8 seconds), use the PRESET [◀]/[▶] buttons to select a preset from 1 through 30. In this example, preset #3 is selected.
- 4** Press the [MEMORY] button again to store the station. The station is stored and the preset number stops flashing. Repeat this procedure for all your favorite radio stations.

Selecting Preset Stations

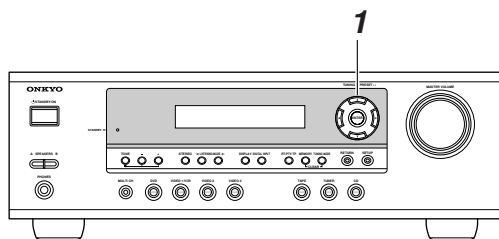

- 1** Use the PRESET [◀]/[▶] buttons, or the remote controller's CH [+/-] button to select a preset.

Deleting Presets

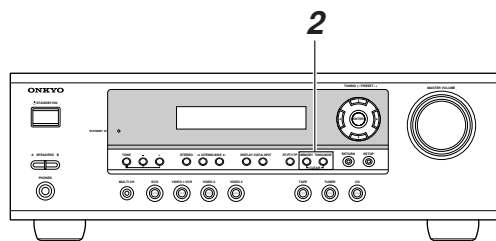

- 1** Select the preset that you want to delete. See the previous section.
- 2** While holding down the [MEMORY] button, press the [TUNING MODE] button. The selected preset is deleted and its number disappears from the display.

Displaying Radio Information

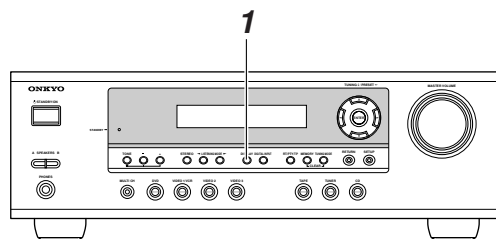

- 1** Press the [DISPLAY] button repeatedly to cycle through the available information.

Band, preset # & frequency
 FM 88.1 MHz 1 ch

↑ ↓

Listening mode
 FM Stereo

Using RDS (European models only)

RDS only works with European models and only in areas where RDS broadcasts are available. When tuned into an RDS station, the RDS indicator appears.

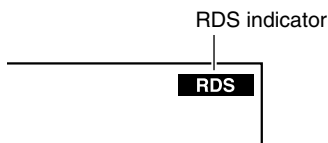

■ What is RDS?

RDS stands for *Radio Data System* and is a method of transmitting data in FM radio signals. It was developed by the European Broadcasting Union (EBU) and is available in most European countries. Many FM stations use it these days. In addition to displaying text information, RDS can also help you find radio stations by type (e.g., news, sport, rock, etc.).

The AV receiver supports four types of RDS information:

PS (Program Service)

When tuned to an RDS station that's broadcasting PS information, the station's name appears. When you press the [DISPLAY] button, the frequency is displayed for three seconds.

RT (Radio Text)

When tuned to an RDS station that's broadcasting RT text information, that information is shown on the display (see page 41).

PTY (Program Type)

You can also search for radio stations by type (see page 41).

TP (Traffic Program)

You can also search for TP radio stations (see page 41).

Notes:

- In some cases, the text characters displayed on the AV receiver may not be identical to those broadcast by the radio station. Also, unexpected characters may be displayed when unsupported characters are received. This is not a malfunction.
- If the signal from an RDS station is weak, RDS data may be displayed intermittently or not at all.

Program Types Used in Europe (PTY)

Type	Display	Description
None	NONE	No program type.
News reports	NEWS	Reports on current events and happenings.
Current affairs	AFFAIRS	Topical reporting of current affairs, often with a wider range of topics than news reports.
Information	INFO	General information such as weather forecasts, consumer affairs, medical help, etc.
Sport	SPORT	Live sports action, sports news, and interviews.
Education	EDUCATE	Formal educational programs.
Drama	DRAMA	Radio plays and serials.
Culture	CULTURE	Cultural programs (including religious affairs).
Science and technology	SCIENCE	Programs about the natural sciences and technology.
Varied	VARIED	Speech-based programs not covered by the above categories (e.g., quizzes, panel games, and comedy).
Pop music	POP M	Popular commercial music, usually from past or present sales charts (e.g., Top 40).
Rock music	ROCK M	Popular music with an alternative appeal, often not appearing on sales charts.
Middle of the road music	M.O.R.M	Easy listening music (as opposed to Pop, Rock, or Classical).
Light classics	LIGHT M	Classical music for general rather than specialist appreciation.
Serious classics	CLASSICS	Performances of major orchestral works, symphonies, chamber music, etc. (including the Grand Opera).
Other music	OTHER M	Music styles not covered by the above categories (e.g., Jazz, Rhythm & Blues, Folk, Country, and Reggae).
Alarm	ALARM	When an RDS station is making an emergency broadcast, ALARM will flash on the display.

Using the Tuner—Continued

Displaying Radio Text (RT)

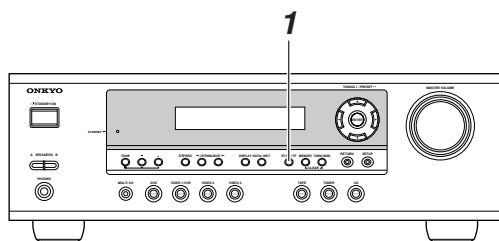

When tuned to an RDS station that's broadcasting RT text information, that information can be displayed.

1

RT/PTY/TP



Press the [RT/PTY/TP] button once.

The RT information scrolls across the display.

Notes:

- The message "Waiting" may appear while the AV receiver waits for RT information.
- If the message "No Text Data" appears on the display, no RT information is available.

Finding Stations by Type (PTY)

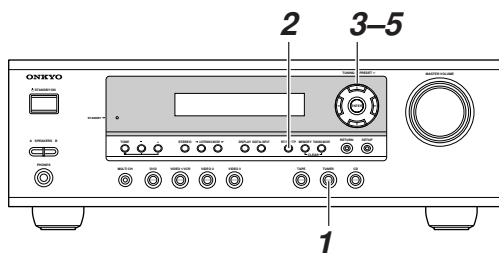

You can search for radio stations by type.

1

TUNER



Use the [TUNER] input selector button to select FM.

2

RT/PTY/TP



Press the [RT/PTY/TP] button twice.

The current program type appears on the display.

3

TUNING ◀ / PRESET ▶



Use the PRESET [◀]/[▶] buttons to select the type of program you want.

See the table on page 40.

4



To start the search, press [ENTER].

The AV receiver searches until it finds a station of the type you specified, at which point it stops briefly before continuing with the search.

5



When a station you want to listen to is found, press [ENTER].

If no stations are found, the message "Not Found" appears.

Listening to Traffic News (TP)

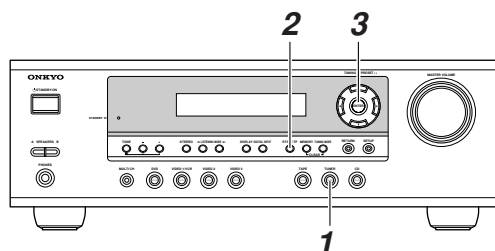

You can search for TP radio stations.

1



Use the [TUNER] input selector button to select FM.

2



Press the [RT/PTY/TP] button three times.

If the current radio station is broadcasting TP (Traffic Program), "[TP]" will appear on the display, and traffic news will be heard as and when it's broadcast. If "TP" without square brackets appears, this means that the station is not broadcasting TP.

3



To locate a station that is broadcasting TP, press [ENTER].

The AV receiver searches until it finds a station that's broadcasting TP. If no stations are found, the message "Not Found" appears.

Common Functions

This chapter explains functions that can be used with any input source.

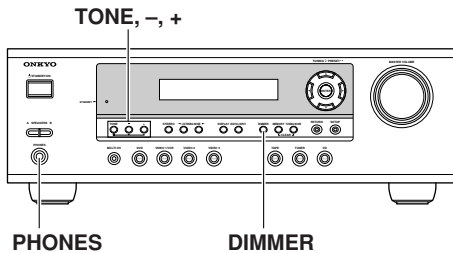
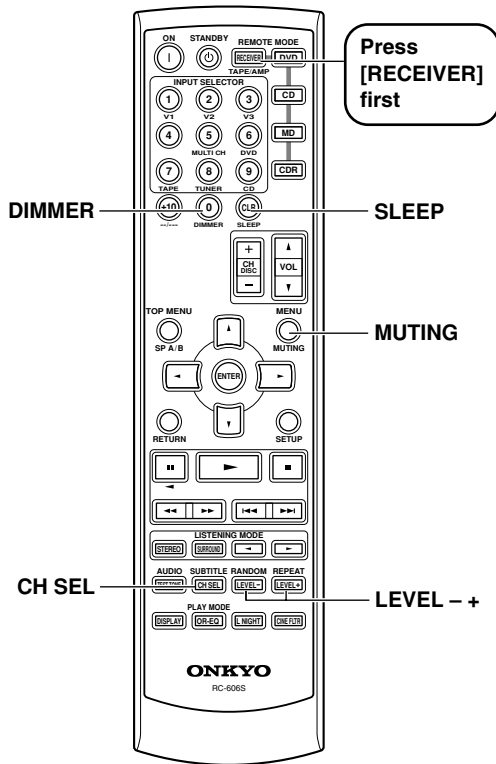

Using the OptiResponse Equalizer

When using the HT-R330 with the speakers included in the HTP-330 Home Theater Speaker Package, by turning on the OptiResponse equalizer, you can enjoy a powerful sound with movies or music.



Press the [OR-EQ] button to turn the OptiResponse equalizer on or off.

Setting the Display Brightness

With this function, you can adjust the brightness of the display.



Press the remote controller's [DIMMER] button repeatedly to select: dim, dimmer, or normal brightness.

Alternatively, you can use the [DIMMER] button on the AV receiver (not European models).

Adjusting the Bass & Treble

You can adjust the bass or treble for the front speakers except when the Direct listening mode is selected.



1 Press the AV receiver's [TONE] button repeatedly to select either Bass or Treble.

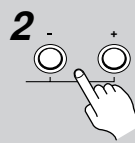

2 Use the TONE [-]/[+] buttons to adjust.

■ Bass

You can boost or cut low-frequency sounds output by the front speakers from -10 dB to +10 dB in 2 dB steps.

■ Treble

You can boost or cut high-frequency sounds output by the front speakers from -10 dB to +10 dB in 2 dB steps.

Note:

- To bypass the bass and treble tone circuits, select the Direct listening mode.

Muting the AV Receiver

With this function, you can temporarily mute the output of the AV receiver.



Press the remote controller's [MUTING] button.

The output is muted and the MUTING indicator flashes on the display, as shown.



To unmute the AV receiver, press the remote controller's [MUTING] button again, or adjust the volume. The output is unmuted and the MUTING indicator goes off. Muting is cancelled when the AV receiver is set to Standby.

Using the Sleep Timer

With the sleep timer, you can set the AV receiver so that it automatically turns off after a set period.



Press the remote controller's [SLEEP] button repeatedly to select the required sleep time.

You can set the sleep time from 90 to 10 minutes in 10 minute steps.

The SLEEP indicator appears on the display when the sleep timer has been set, as shown. The specified sleep time appears on the display for about five seconds, then the previous display reappears.

SLEEP indicator

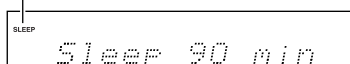

To cancel the sleep timer, press the [SLEEP] button repeatedly until the SLEEP indicator disappears.

To check the remaining sleep time, press the [SLEEP] button. Note that if you press the [SLEEP] button while the sleep time is being displayed, you'll shorten the sleep time by 10 minutes.

Using Headphones

You can connect a pair of stereo headphones (1/4-inch phone plug) to the AV receiver's PHONES jack for private listening, as shown.

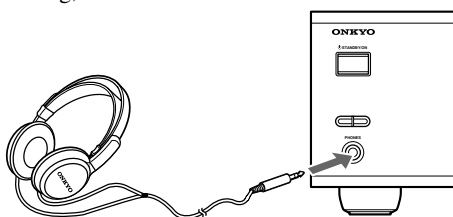

Notes:

- Always turn down the volume before connecting your headphones.
- Speaker sets A and B are turned off while the headphones plug is inserted in the PHONES jack.
- When you connect a pair of headphones, the listening mode is set to Stereo, unless it's already set to Mono, Stereo, or Direct.
- When the multichannel DVD input is selected, only the front left and front right channels can be heard in the headphones.

Adjusting Speaker Levels

You can adjust the level of each speaker in speaker set A while listening to an input source. These temporary adjustments are cancelled when the AV receiver is set to Standby.

1

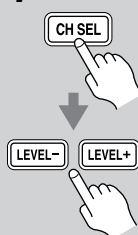

Use the remote controller's [CH SEL] button to select each speaker, and use the [LEVEL-] and [LEVEL+] buttons to adjust the volume.

You can adjust the volume of each speaker from -12 dB to +12 dB (-15 dB to +12 dB for the subwoofer).

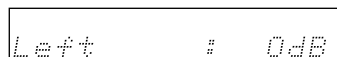

Notes:

- You cannot use this function while the AV receiver is muted.
- Speakers that are set to No or None in the Speaker Configuration cannot be adjusted.

■ Speaker Set B

While speaker set B is on, you can also adjust the levels of the left and right speakers in speaker set B, from -12 dB to +12 dB.

- These settings are stored when the AV receiver is set to Standby.
- While speaker set B is on, you can adjust the levels of the left and right speakers in speaker set A's and the subwoofer.

■ Headphones

While a pair of headphones is connected, you can adjust the volume of the left and right channels individually, from -12 dB to +12 dB each.

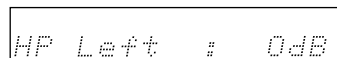

- These settings are stored when the AV receiver is set to Standby.

■ Multichannel DVD Input

While the multichannel DVD input is selected, you can adjust the level of each 5.1 channel input individually, from -12 dB to +12 dB. (-30 to +12 dB for the subwoofer.)

- These settings are stored when the AV receiver is set to Standby.
- Individual speaker levels can also be adjusted in "3. MultiLevel Setup" (see page 52).

Using the Listening Modes

Selecting Listening Modes

See “About the Listening Modes” on page 46 for detailed information about the listening modes.

- The Dolby Digital and DTS listening modes can only be selected if your DVD player is connected to the AV receiver with a digital audio connection (coaxial or optical).
- Listening mode availability depends on the format of the current input signal.
- While a pair of headphones is connected, or speaker B is on, you can select only the Mono, Direct, or Stereo listening mode.

Selecting on the AV receiver

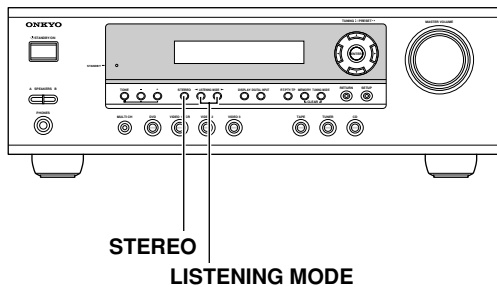

■ [STEREO] button

This button selects the Stereo listening mode.

■ LISTENING MODE [◀/▶] buttons

Pressing these buttons repeatedly cycles through all of the listening modes that can be used with the current input source.

Selecting with the Remote Controller

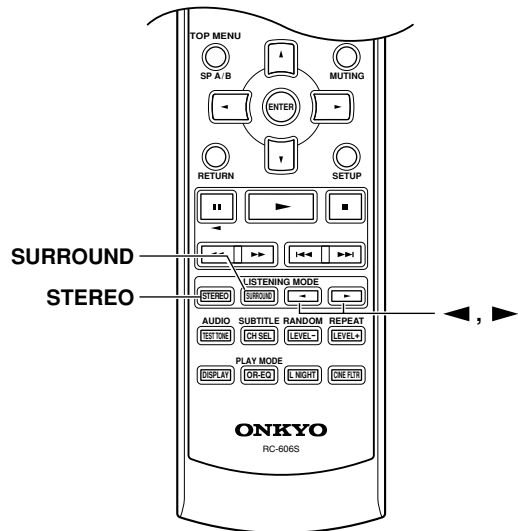

■ [STEREO] button

This button selects the Stereo listening mode.

■ [SURROUND] button

This button selects the Dolby Digital and DTS listening modes.

■ LISTENING MODE [◀/▶] buttons

Pressing these buttons repeatedly cycles through all of the listening modes that can be used with the current input source.

Using the Listening Modes—Continued

The following table lists all the listening modes and shows which modes can be selected for each input signal format.

Input signal format		Analog, PCM ^{*1}	Dolby D				DTS/DTS 96/24 ^{*2}				Multich
			*/2	2/0 (Stereo)	1/0,1+1	Other	3/2.1	2/0 (Stereo)	DTS-ES		
									Discrete	Matrix	
Source		CD, TV, VHS, MD, turntable, radio, cassette, DTV, etc.	DVD, DTV, etc.				DVD, CD, etc.				DVD
Listening mode											
Direct		✓	✓	✓	✓	✓	✓	✓	✓	✓	
Stereo		✓	✓	✓	✓	✓	✓	✓	✓		
Mono											
Multich										✓	
PLII Movie/Music/Game		✓		✓				✓			
Neo:6 Cinema											
Neo:6 Music ^{*3}											
Dolby D			✓								
DTS						✓			✓		
Onkyo Original DSP	<div style="border: 1px solid black; padding: 2px;"> Mono Movie Orchestra Unplugged Studio-Mix TV Logic All Ch Stereo Full Mono </div> ^{*3}	✓	✓	✓	✓	✓	✓	✓	✓		

*1. In the Direct listening modes, PCM signals at 32 kHz, 44.1 kHz, and 48 kHz are processed at 64 kHz, 88.2 kHz, and 96 kHz respectively. 96 kHz signals are processed at 48 kHz for all listening modes other than Direct, and Stereo.

*2. DTS 96/24 is always processed as DTS.

*3. Available only when Surround speakers are connected.

Tip: You can check the format of the digital input signal on page 37, “Displaying Source Information.”

About the Listening Modes

With its built-in surround-sound decoders and DSP programs, the AV receiver can transform your home listening room into a movie theater or concert hall.

The AV receiver's surround indicators show which speakers are active in each listening mode.

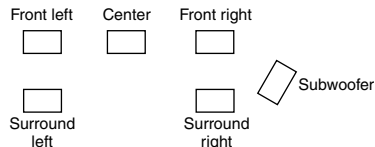

Direct

The selected input source is output directly with minimal processing for a pure sound.

Stereo

The selected input source is processed as a stereo signal and output by the front left and right speakers and the subwoofer.

Mono

Use this mode when watching an old movie with a mono soundtrack, or to select multilingual soundtracks recorded in the left and right channels of some movies. It can also be used when playing a DVD or other source with multiplexed audio, such as a karaoke DVD.

Dolby Pro Logic II Movie

Use this mode with DVDs and videos that bear the Dolby Surround logo or TV shows that feature Dolby Surround. You can also use this mode with stereo movies or TV shows and the AV receiver will create a 5.1 surround mix from the 2-channel stereo.

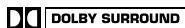

Dolby Pro Logic II Music

Use this mode to add 5.1 surround to stereo sources such as music CDs and DVDs.

Dolby Pro Logic II Game

Use this mode when playing game discs.

Dolby Digital

With this format you can experience the same superb sound that you get at a movie theater or concert hall. Use this mode with DVDs that bear the Dolby Digital logo.



DTS

This digital surround format offers a surround sound experience with exceptional fidelity. It uses compressed digital audio data, with six discrete channels (5.1), and the ability to handle large amounts of audio data while remaining faithful to the original. DTS provides very high-quality sound. You'll need a DTS compatible DVD



player in order to enjoy DTS material. Use this mode with DVDs and CDs that bear the DTS logo.

Neo:6

This mode provides 5.1-channel playback from 2-channel sources. It offers five full-bandwidth channels with excellent separation. There are two modes of operation: Cinema mode for movies, and Music mode for listening to music.

Cinema mode simulates the realistic sense of movement that you get with 5.1-channel surround sound sources. Use this mode with videos, DVDs, and TV shows that feature stereo sound.

Music mode uses the surround channels to simulate a natural sound field that cannot be produced with conventional stereo. Use this mode with stereo material such as music CDs.

Onkyo Original DSP Modes

Mono Movie

This mode is suitable for use with old movies and other mono sound sources. The center speaker outputs the sound as it is, while reverb is applied to the sound output by the other speakers, giving presence to even mono material.

Orchestra

Suitable for classical or operatic music. The surround channels are emphasized in order to widen the stereo image. In addition, it simulates the natural reverberation of a large hall.

Unplugged

Suitable for acoustic instrument sounds, vocals, and jazz music. By emphasizing the front stereo image, it simulates the stage-front experience.

Studio-Mix

Suitable for rock and pop music. Listening to music in this mode creates a lively sound field with a powerful acoustic image, like being at a club or rock concert.

TV Logic

Adds realistic acoustics to TV shows produced in a TV studio. In addition, it adds surround effects to the entire sound and adds clarity to voices.

All Ch Stereo

Ideal for background music. The front, surround, and surround back channels create a stereo image that fills the entire listening area.

Full Mono

In this mode, all speakers output mono audio, so the music sounds the same regardless of where you are.

Adjusting the Listening Modes

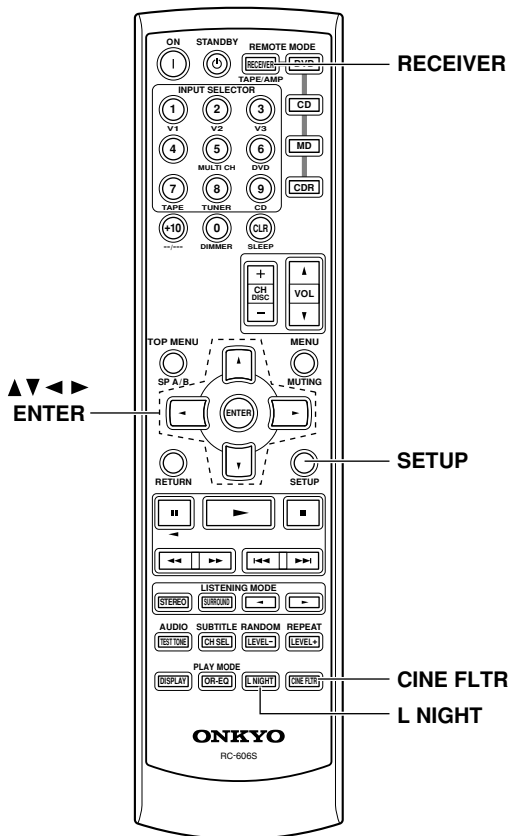

Using the Audio Adjust Functions

These functions only work with speaker set A. Audio Adjust provides various functions for adjusting the sound.

1 Press the [RECEIVER] button followed by the [SETUP] button.

2 Use the Up and Down [▲]/[▼] buttons to select "4. Audio Adjust," and then press the [ENTER] button.

4. Audio Adjust

3 Use the Left and Right [◀]/[▶] buttons to change the settings. Press the Down [▼] button to select the next setting.

4 Repeat step 3 to complete all settings.

5 Press the [SETUP] button. Setup closes.

The Audio Adjust functions are explained below.

Input Channel Settings

■ Multiplex

This setting determines which channel is output from a stereo multiplex source. Use it to select audio channels or languages with multiplex sources, multilingual TV broadcasts, and so on.

Main: The main channel is output (default).

Sub: The sub channel is output.

M/S: Both the main and sub channels are output.

■ Mono (2ch)

This setting determines which channel is output when the Mono listening mode is used with a stereo source.

L+R: Both the left and right channels are output (default).

L: Only the left channel is output.

R: Only the right channel is output.

Adjusting the Listening Modes—Continued

PL II Music Mode Settings

These settings apply to only 2-channel (stereo) sources.

■ Panorama

With this function, you can broaden the width of the front stereo image when using the Pro Logic II Music listening mode.

On: Panorama function on.

Off: Panorama function off (default).

■ Dimension

With this setting, you can move the sound field forward or backward when using the Pro Logic II Music listening mode. The default setting is 3. Higher settings move the sound field forward. Lower settings move it backward. If the stereo image feels too wide, or there's too much surround sound, move the sound field forward to improve the balance. Conversely, if the stereo image feels like it's in mono, or there's not enough surround sound, move it backward.

■ Center Width

With this function, you can adjust the width of the sound from the center speaker when using the Pro Logic II Music listening mode normally. If you're using a center speaker, the center channel sound is output by only the center speaker. (If you're not using a center speaker, the center channel sound will be distributed to the front left and right speakers to create a phantom center). This setting controls the front left, right, and center mix, allowing you to adjust the weight of the center channel sound. It can be adjusted from 0 to 7 (default is 3).

DTS Neo:6 Music Mode Setting

■ Center Image

The DTS Neo:6 Music listening mode creates 5-channel surround sound from 2-channel (stereo) sources. With this setting, you can specify by how much the front left and right channel output is attenuated in order to create the center channel. It can be adjusted from 0 to 5 (default is 3). This setting is unavailable if no surround speakers are connected.

When set to 0, the front left and right channel output is attenuated by half (–6 dB), giving the impression that the sound is located centrally. This setting works well when the listening position is considerably off center. When set to 5, the front left and right channels are not attenuated, maintaining the original stereo balance.

Using the Late Night Function (Dolby Digital only)

With the Late Night function, you can reduce the dynamic range of Dolby Digital material so that you can still hear quiet parts even when listening at low volume levels—ideal for watching movies late at night when you don't want to disturb anyone.

1



Press the [RECEIVER] button, and then press the [L NIGHT] button repeatedly to select:

Off: Late Night function off.

Low: Small reduction in dynamic range.

High: Big reduction in dynamic range.

Notes:

- The effect of the Late Night function depends on the Dolby Digital material that you are playing, and with some material there will be little or no effect.
- The Late Night function is set to Off when the AV receiver is set to Standby.

Using the CinemaFILTER

With the CinemaFILTER, you can soften overly bright movie soundtracks, which are typically mixed for reproduction in a movie theater.

CinemaFILTER can be used with the following listening modes: Dolby Digital, Dolby Pro Logic II Movie, DTS, and DTS Neo:6 Cinema.

1



Press the [RECEIVER] button, and then press the [CINE FLTR] button repeatedly to select:

On: CinemaFILTER on.

Off: CinemaFILTER off.

Recording

This chapter explains how to record the selected input source to an AV component with recording capability, and how to record audio and video from two different sources.

Recording the Input Source

You can record only to AV components that are connected to the TAPE OUT or VIDEO 1 OUT jacks. See pages 22–31 for information on connecting your AV components to the AV receiver.

1	<p>Use the input selector buttons to select the AV component that you want to record.</p> <p>Audio signals from the selected input source are output by the VIDEO 1 OUT and TAPE OUT jacks.</p> <p>You can listen to the source while recording. The AV receiver's VOLUME control has no effect on recording.</p>
2	<p>Start recording on the AV component connected to the TAPE OUT or VIDEO 1 OUT jacks.</p>
3	<p>Start playback on the source AV component.</p>

Notes:

- You cannot record from AV components that are connected to the digital inputs. You must use analog connections.
- The surround effects produced by the surround and DSP listening modes cannot be recorded.
- You cannot record from an AV component that is connected to the multichannel input.
- If you select another input source while recording, that input source will be recorded instead.

Recording from Different AV Sources

With this function, you can record audio and video from different sources, allowing you to overdub audio onto your video recordings. This function takes advantage of the fact that when an audio-only input source (i.e., TAPE, TUNER, or CD) is selected, the video input source remains unchanged. For example, if you first select the VIDEO 3 input source, followed by the CD input source, you can watch the video from the VIDEO 3 input and listen to the audio from the CD input.

In the following example, audio from the CD player connected to the CD IN jacks, and video from the camcorder connected to the VIDEO 3 IN jack are recorded by the VCR, which is connected to the VIDEO 1 OUT jacks.

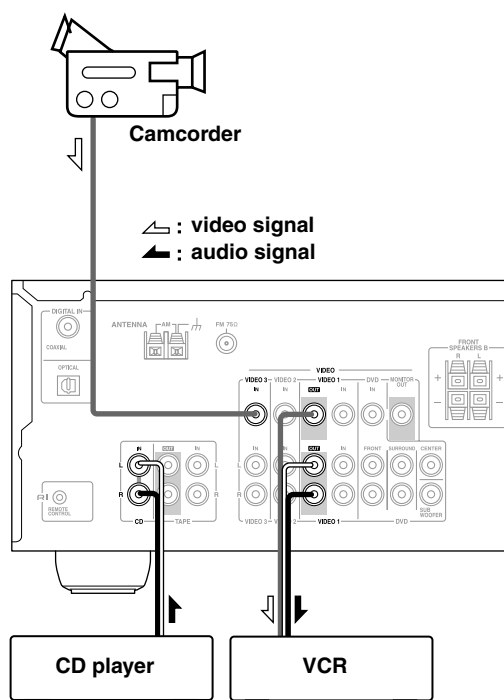

- 1. Prepare the camcorder and CD player for playback.**
- 2. Prepare the VCR for recording.**
- 3. Press the [VIDEO 3] input selector button.**
- 4. Press the [CD] input selector button.**

This selects the CD player as the audio source, but leaves the camcorder as the video source.
- 5. Start recording on the VCR and start playback on the camcorder and CD player.**

The video from the camcorder and the audio from the CD player are recorded by the VCR.

Advanced Setup

Advanced Speaker Settings

The advanced speaker settings cannot be changed while headphones are connected, Speaker set B is on, or the multichannel input is being used.

Crossover Frequency

To get the best bass performance from your speaker system, you need to set the crossover frequency according to the size and frequency response of your subwoofer and other speakers (front, center, and surround).

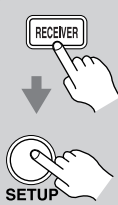
- 

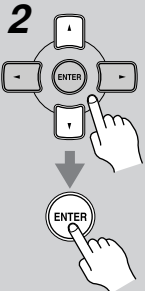
1 Press the [RECEIVER] button followed by the [SETUP] button on the remote controller.
- 

2 Use the Up and Down [▲]/[▼] buttons to select “1. Speaker Config,” and then press the [ENTER] button.

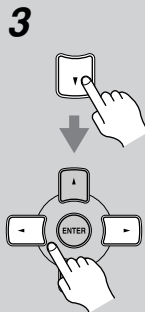
1. Speaker Config
- 

3 Use the Down [▼] button to select “Crossover,” and then use the Left and Right [◀]/[▶] buttons to select a crossover frequency.

Choose a crossover frequency suitable for your setup.

If you’re using a subwoofer, choose a crossover frequency based on the diameter of your front speakers.

If you’re not using a subwoofer, use the diameter of the first speaker that you specified as Small in steps 4 through 7 in the “Speaker configuration” setting (see page 34).

Speaker cone diameter	Crossover frequency
Over 8 in. (20 cm)	60Hz
6-1/2 to 8 in. (16–20 cm)	80Hz
5-1/4 to 6-1/2 in. (13–16 cm)	100Hz
3-1/2 to 5-1/4 in. (9–13 cm)	120Hz
Under 3-1/2 in. (9 cm)	150Hz

Continue with step 4 of the “Double Bass” setting.

Note:

- For a more accurate setting, listen to some music that you know well and choose a higher crossover frequency if you think there’s not enough sound coming from the subwoofer; a lower setting if you think there’s too much.

Double Bass

With the Double Bass function, you can boost bass output by feeding bass sounds from the front left and right channels to the subwoofer. This function can be set only if the Subwoofer setting (step 3) is set to Yes, and the Front setting (step 4) is set to Large in the Speaker Configuration on page 34.

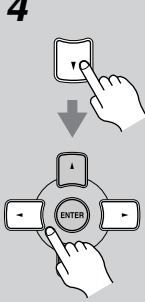
- 

4 Use the Down [▼] button to select “Double Bass,” and then use the Left and Right [◀]/[▶] buttons to select:

On: Double Bass function on. Bass from the front left and right channels is also fed to the subwoofer (default).

Off: Double Bass function off.
- 

5 Press the [SETUP] button. Setup closes.

Speaker Distance

To get the best from surround sound, it's important that the sound from each speaker reaches the listener at the same time. To achieve this, you need to specify the distance from each speaker to the listening position.

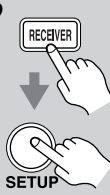
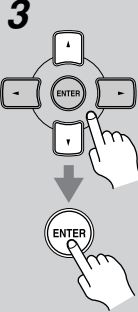
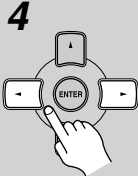
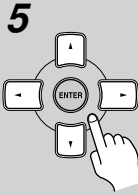
1	Measure and make a note of the distance from each speaker to the listening position.
2	 <p>Press the [RECEIVER] button followed by the [SETUP] button on the remote controller.</p>
3	 <p>Use the Up and Down [▲]/[▼] buttons to select "2. Sp Distance," and then press the [ENTER] button.</p> <div style="border: 1px solid black; padding: 5px; width: fit-content; margin: 10px auto;">2. Sp Distance</div>
4	 <p>While "Unit" is displayed, use the Left and Right [◀]/[▶] buttons to select "feet" or "meters".</p> <p>feet: Distances in feet. Can be set from 1 to 30 feet in 1-foot steps.</p> <p>meters: Distances in meters. Can be set from 0.3 to 9 meters in 0.3-meter steps.</p>
5	 <p>Use the Down [▼] button to select "Front," and use the Left and Right [◀]/[▶] buttons to specify the distance for the "front speakers," then press the Down [▼] button to select the next speaker.</p>
6	<p>Repeat step 5 for all speakers.</p> <p>Note: Speakers that you set to No or None in the Speaker Configuration (page 34) cannot be selected.</p>
7	<p>Press the [SETUP] button. Setup closes.</p>

Notes:

- The Center and Subwoofer distances can be set up to 5 ft. (1.5 m) more or less than the Front distance. For example, if the Front distance is set to 20 ft. (6 m), the Center and Subwoofer distances can be set between 15 and 25 ft. (4.5 and 7.5 m).
- The Surround distances can be set up to 5 ft. (1.5 m) more or 15 ft. (4.5 m) less than the Front distance. For example, if the Front distance is set to 20 ft. (6 m), the SurrRight and Surr Left distances can be set between 5 and 25 ft. (1.5 and 7.5 m).

Speaker Levels

With this function, you can adjust the volume of each speaker so that all speakers can be heard equally at the listening position.

Speaker levels cannot be adjusted while the AV receiver is muted.

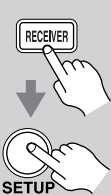
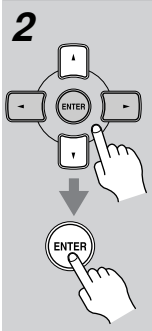
1	 <p>Press the [RECEIVER] button followed by the [SETUP] button on the remote controller.</p>
2	 <p>Use the Up and Down [▲]/[▼] buttons to select "3. Level Cal," and then press the [ENTER] button.</p> <p>A pink noise test tone is output by the front left speaker.</p> <div style="border: 1px solid black; padding: 5px; width: fit-content; margin: 10px auto;">3. Level Cal</div>
3	<p>Turn up the volume so that you can hear the test tone sufficiently.</p> <p>While each speaker outputs the test tone, its name appears on the display, as shown.</p> <div style="border: 1px solid black; padding: 5px; width: fit-content; margin: 10px auto;">Left : 0dB</div>



- 4** Use the Left and Right [◀]/[▶] buttons to adjust the speaker level, and use the Down [▼] button to select the next speaker.
- The level can be adjusted from -12 to +12 dB in 1 dB steps (-15 to +12 dB for the subwoofer).
- 5** Repeat step 4 so that the level of the test tone from each speaker is the same.
- Speakers that you set to No or None in the Speaker Configuration (page 34) do not output the test tone.
- 6** Press the [SETUP] button.
- Setup closes.
- Don't forget to turn down the volume if you turned it up while setting the levels.

Note:

- A quicker way to adjust the speaker levels is to press the remote controller's [TEST TONE] button to output the test tone, use the [LEVEL-] and [LEVEL+] buttons to adjust the levels, and use the [CH SEL] button to select the speakers.
- If the multichannel input is selected (page 37), in step 2, the "3. MultiLevel" menu appears instead of the "3. Level Cal" menu, and you can adjust the level of each channel of the multichannel input regardless of the Speaker Configuration settings.

Digital Input Signal Formats

The following table shows the display indicators for each supported digital signal format.

Format	Display
Dolby Digital	 D
DTS	
PCM	PCM

Normally, the AV receiver detects the signal format automatically. However, if you experience either of the following issues when playing PCM or DTS material, you can manually set the signal format to PCM or DTS:

- If the beginnings of tracks from a PCM source are cut off, try setting the format to PCM.
- If noise is produced when fast forwarding or reversing a DTS CD, try setting the format to DTS.

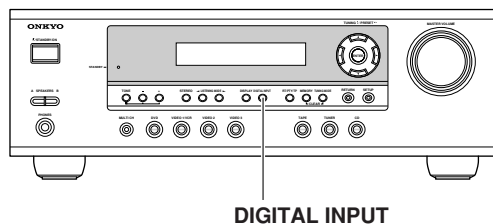

- 1** Press and hold the AV receiver's [DIGITAL INPUT] button for about 3 seconds.
- 2** While "Auto" is displayed (about 3 seconds), press the [DIGITAL INPUT] button again to select: PCM, DTS, or Auto.

DTS or PCM: The DTS or PCM indicator, depending on which format you have set, flashes, and only signals in that format are output. Digital signals in other formats are ignored.

Auto (default): The format is detected automatically. If no digital input signal is present, the corresponding analog input is used instead.

Troubleshooting

If you have any trouble using the AV receiver, look for a solution in this section. If you can't resolve the issue yourself, contact your Onkyo dealer.

Power

Can't turn on the AV receiver?

- Make sure that the power cord is properly plugged into the wall outlet.
- Unplug the power cord from the wall outlet, wait five seconds or more, then plug it in again.

The AV receiver turns off as soon as it's turned on?

- The amp protection circuit has been activated. Remove the power cord from the wall outlet immediately. Disconnect all speaker cables and input sources, and leave the AV receiver with its power cord disconnected for one hour. After that, reconnect the power cord, and then set the volume to maximum. If the AV receiver stays on, set the volume to minimum, disconnect the power cord, and reconnect your speakers and input sources properly. If the AV receiver turns off when you set the volume to maximum, disconnect the power cord, and contact your Onkyo dealer.

Audio

There's no sound or it's very quiet?

- Make sure that the digital input source is selected properly (page 33). Press the [DIGITAL INPUT] button repeatedly.
- Make sure that all audio connecting plugs are pushed in all the way (page 22).
- Make sure that the polarity of the speaker cables is correct, and that the bare wires are in contact with metal part of each speaker terminal (page 18)
- Make sure that the speaker cables are not shorting.
- Check the volume. It can be set to MIN, 1 through 79, or MAX (page 36). The AV receiver is designed for home theater enjoyment and has a wide volume range for precise adjustment.
- If the MUTING indicator is shown on the display, press the remote controller's [MUTING] button to unmute the AV receiver (page 42).
- While a pair of headphones is connected to the PHONES jack, no sound is output by the speakers (page 43).
- Check the digital audio output setting on the connected device. On some games consoles, such as those that can play DVDs, the default setting is off.
- With some DVD-Video discs, you need to select an audio format from a menu.
- If your turntable doesn't have a phono preamp built-in, you must connect one between it and the AV receiver.

If your turntable uses an MC cartridge, you must connect an MC head amp, or an MC transformer and a phono preamp.

- Specify the speaker distances and adjust the individual speaker levels (pages 51, 52).
- The input signal format is set to PCM or DTS. Set it to Auto (page 52).

Only the front speakers produce sound?

- When the Stereo or Mono listening mode is selected, only the front speakers and subwoofer produce sound.
- Make sure the speakers are configured correctly (page 34).

Only the center speaker produces sound?

- If you use the Pro Logic II Movie or Pro Logic II Music listening mode with a mono source, such as an AM radio station or mono TV program, the sound is concentrated in the center speaker.
- Make sure the speakers are configured correctly (page 34).

The surround speakers produce no sound?

- When the Stereo or Mono listening mode is selected, the surround speakers produce no sound (page 44).
- Depending on the source and current listening mode, not much sound may be produced by the surround speakers. Try selecting another listening mode.
- Make sure the speakers are configured correctly (page 34).

The center speaker produces no sound?

- When the Stereo or Mono listening mode is selected, the center speaker produces no sound (page 44).
- Make sure the speakers are configured correctly (page 34).

The subwoofer produces no sound?

- The subwoofer outputs no sound while only speaker set B is on. Turn on speaker set A.
- When you play source material that contains no information in the LFE channel, the subwoofer produces no sound.
- Make sure the speakers are configured correctly (page 34).
- If the multichannel DVD input is selected and speaker set B is on, speaker set A is reduced to 2-channel playback, so the subwoofer outputs no sound.
- On the AV receiver, the subwoofer setting in the speaker configuration is set to No. Set the subwoofer setting to Yes.

There's no sound with a certain signal format?

- Check the digital audio output setting on the connected device. On some games consoles, such as those that can play DVDs, the default setting is off.
- With some DVD-Video discs, you need to select an audio output format from a menu.

Can't get 5.1-channel playback?

- When speaker B is turned on, speaker set A is reduced to 2.1-channel playback.

The volume cannot be set to 79?

- When the levels of all speakers have been calibrated (pages 43, 51), the maximum volume setting may change.

Noise can be heard?

- Using cable ties to bundle audio cables with power cords, speaker cables, and so on may degrade the audio performance, so don't do it.
- An audio cable may be picking up interference. Try repositioning your cables.

The Late Night function doesn't work?

- Make sure the source material is Dolby Digital (page 48).

The DVD analog multichannel input doesn't work?

- Check the DVD analog multichannel input connections (page 25).
- To select the DVD analog multichannel input, press the [MULTI CH] input selector button.
- Check the audio output settings on your DVD player.

About DTS signals

- When DTS program material ends and the DTS bitstream stops, the AV receiver remains in DTS listening mode and the DTS indicator remains on. This is to prevent noise when you use the pause, fast forward, or fast reverse function on your player. If you switch your player from DTS to PCM, because the AV receiver does not switch formats immediately, you may not hear any sound, in which case you should stop your player for about three seconds, and then resume playback.
- With some CD players, you won't be able to playback DTS material properly even though your player is connected to a digital input on the AV receiver. This is usually because the DTS bitstream has been processed (e.g., output level, sampling rate, or frequency response changed) and the AV receiver doesn't recognize it as a genuine DTS signal. In such cases, you may hear noise.
- When playing DTS program material, using the pause, fast forward, or fast reverse function on your player may produce a short audible noise. This is not a malfunction.

Video

There's no picture?

- Make sure that all video connecting plugs are pushed in all the way (page 22).
- Make sure that each video component is properly connected.
- On your TV, make sure that the video input to which the AV receiver is connected is selected.

Tuner

Reception is noisy, stereo FM reception suffers from hiss, or the FM STEREO indicator doesn't appear?

- Relocate your antenna.
- Move the AV receiver away from your TV or computer.
- Listen to the station in mono (page 38).
- When listening to an AM station, operating the remote controller may cause noise.
- Passing cars and airplanes can cause interference.
- Concrete walls weaken radio signals.
- If nothing improves the reception, install an outdoor antenna.

Remote Controller

The remote controller doesn't work?

- Make sure that the batteries are installed with the correct polarity (page 7).
- Make sure that the remote controller is not too far away from the AV receiver, and that there's no obstruction between the remote controller and the AV receiver's remote control sensor (page 7).
- Make sure you've selected the correct remote controller mode (page 12).
- Make sure you've entered the correct remote control code.

Can't control other components?

- Make sure you've selected the correct remote controller mode (page 12).
- To control cassette tape deck, point the remote controller at the AV receiver.
- To control Onkyo CD player or MD/CD recorder, point the remote controller at that component.

Recording

Can't record?

- On your recorder, make sure the correct input is selected.
- To prevent signal loops and damage to the AV receiver, input signals are not fed through to outputs with the same name (e.g., TAPE IN to TAPE OUT, or VIDEO 1 IN to VIDEO 1 OUT).

Others

The sound changes when I connect my headphones?

- When a pair of headphones is connected, the listening mode is set to Stereo, unless it's already set to Stereo, Mono, Direct.

How do I change the language of a multiplex source?

- Use the "Multiplex" setting on the "4. Audio Adjust" menu to select Main or Sub (page 47).

The **RI** functions don't work?

- To use **RI**, you must make an **RI** connection and an analog audio connection (RCA) between the component and AV receiver, even if they are connected digitally (page 31).

The AV receiver contains a microcomputer for signal processing and control functions. In very rare situations, severe interference, noise from an external source, or static electricity may cause it to lockup. In the unlikely event that this happens, unplug the power cord from the wall outlet, wait at least five seconds, and then plug it back in again.

Onkyo is not responsible for damages (such as CD rental fees) due to unsuccessful recordings caused by the unit's malfunction. Before you record important data, make sure that the material will be recorded correctly.

To reset the AV receiver to its factory defaults, turn it on and, while holding down the [VIDEO 1/CR] button, press the [STANDBY/ON] button. "Clear" will appear on the display and the AV receiver will enter Standby mode.

Before disconnecting the power cord from the wall outlet, set the AV receiver to Standby.

Specification

Amplifier Section

Power Output 2 channel driven:	North American: 100 W + 100 W (8Ω, 1 kHz, FTC) European: 100 W + 100 W (8Ω, 1 kHz, DIN) Asian: 120 W + 120 W (8Ω, 1kHz, JEITA)
Dynamic Power	230 W + 230 W (3Ω, Front) 170 W + 170 W (4Ω, Front) 115 W + 115 W (8Ω, Front)
THD (Total Harmonic Distortion)	0.08% (Power Rated)
Damping Factor	60 (Front, 1kHz, 8Ω)
Input Sensitivity and Impedance	200 mV/ 47 kΩ (LINE)
Output Level and Impedance	200 mV/ 470 Ω (REC OUT)
Frequency Response	10 Hz–100 kHz/ +1 dB-3 dB (Direct mode)
Tone Control	±10 dB, 50 Hz (BASS) ±10 dB, 20 kHz (TREBLE)
Signal to Noise Ratio	100 dB (LINE, IHF-A)
Speaker Impedance	8Ω– 16Ω

Video Section

Input Sensitivity/Output Level and Impedance	1 Vp-p /75Ω(Composite)
--	------------------------

Tuner Section

■ FM

Tuning Frequency Range	North American: 87.5 MHz– 107.9 MHz European: 87.5 MHz– 108.0 MHz Asian: 87.5 MHz– 108.0 MHz
Usable Sensitivity	Stereo: 17.2 dBf 2 μV(75Ω IHF) Mono: 11.2 dBf 1 μV(75Ω IHF)
Signal to Noise Ratio	Stereo: 70 dB (IHF-A) Mono: 76 dB (IHF-A)
THD	Stereo: 0.3% (1kHz) Mono: 0.2% (1kHz)
Frequency Response Stereo Separation	30 Hz–15 kHz / ±1 dB 45 dB (1kHz)

■ AM

Tuning Frequency Range	North American: 530 kHz–1710 kHz European: 522 kHz–1611 kHz Asian: 530/522 kHz–1710/1611 kHz
Usable Sensitivity	30 μV
Signal to Noise Ratio	40 dB
THD	0.70%

General

Power Supply	North American: AC 120 V, 60 Hz Australian and European: AC 230-240 V, 50 Hz Others: AC 120/220-240 V, 50/60 Hz
Power Consumption	North American: 5.5 A Others: 380 W
Stand-by Power Consumption	North American: 0.1 W European: 0.2 W Others: 0.5 W
Dimensions (W × H × D)	435 × 150 × 369 mm 17-1/8" × 5-7/8" × 14-1/2"
Weight	North American and European: 8.8 kg 19.4 lbs. Others: 9.6 kg, 19.0 lbs.

■ Video Inputs

Composite	DVD, VIDEO1, VIDEO2, VIDEO3
-----------	-----------------------------

■ Video Outputs

Composite	MONITOR, VIDEO1
-----------	-----------------

■ Audio Inputs

Digital Inputs	Optical: 1 Coaxial: 1
Analog Inputs	DVD(MULTICHANNEL), VIDEO1, VIDEO2, VIDEO3, TAPE, CD
Multichannel Inputs	6

■ Audio Outputs

Analog Outputs	TAPE, VIDEO1
Speaker Outputs	SP-A (L, R, C, SL, SR, SW) + SP-B (L, R)
Phones	1

5.1ch Home Theater Speaker Package

■ Passive Subwoofer (SKW-330)

Type: Bass-reflex type
Impedance: 8 Ω
Maximum input power: 100 W
Output sound pressure level: 84 dB/m/w
Frequency response: 30 Hz–150 Hz
Cabinet capacity: 0.91 cubic feet (26 L)
Dimensions (W × H × D): 9-1/16" × 17-1/8" × 15-7/16"
(230 × 435 × 392 mm)
Weight: 17.2 lbs. (7.8 kg)
Drivers unit: 8" (20 cm) Cone
Terminal: Spring type color coded

■ Front Speaker (SKF-330F)

Type: 2 Way Bass-reflex
Impedance: 8 Ω
Maximum input power: 100 W
Output sound pressure level: 83 dB/W/m
Frequency response: 80 Hz–22 kHz
Crossover frequency: 10 kHz
Cabinet capacity: 0.042 cubic feet (1.2 L)
Dimensions (W × H × D): 5-13/16" × 7-15/16" × 4"
(148 × 202 × 101 mm)
Weight: 2.0 lbs. (0.9 kg)
Drivers unit: 3-1/8" (8 cm) Cone (Woofer)
3/4" (2 cm) Ceramic (Tweeter)
Terminal: Spring type color coded
Key hole slot: 1
Threaded insert: North American model:
1/4" screw, Depth 5/16"
Other models:
5 mm screw, Depth 8 mm
Grille: Fixed
Other: Magnetic shielding

■ Center Speaker (SKC-330C)

Type: 2 Way Bass-reflex
Impedance: 8 Ω
Maximum input power: 100 W
Output sound pressure level: 86 dB/W/m
Frequency response: 80 Hz–22 kHz
Crossover frequency: 10 kHz
Cabinet capacity: 0.081 cubic feet (2.3 L)
Dimensions (W × H × D): 14-3/16" × 5" × 5-3/16"
(360 × 127 × 131 mm)
Weight: 3.5 lbs. (1.6 kg)
Drivers unit: 3-1/8" (8 cm) Cone (Woofer) × 2
3/4" (2 cm) Ceramic (Tweeter)
Terminal: Spring type color coded
Key hole slot: 2
Threaded insert: North American model:
1/4" screw, Depth 5/16"
Other models:
5 mm screw, Depth 8 mm
Grille: Fixed
Other: Magnetic shielding

■ Surround Speaker (SKM-330S)

Type: 2 Way Bass Reflex
Impedance: 8 Ω
Maximum input power: 100 W
Output sound pressure level: 82 dB/W/m
Frequency response: 80 Hz–22 kHz
Crossover frequency: 10 kHz
Cabinet capacity: 0.042 cubic feet (1.2 L)
Dimensions (W × H × D): 5-13/16" × 7-15/16" × 4"
(148 × 202 × 101 mm)
Weight: 1.5 lbs. (0.7 kg)
Drivers unit: 3-1/8" (8 cm) Cone (Woofer)
3/4" (2 cm) Ceramic (Tweeter)
Terminal: Spring type color coded
Key hole slot: 1
Threaded insert: North American model:
1/4" screw, Depth 5/16"
Other models:
5 mm screw, Depth 8 mm
Grille: Fixed

Specifications and features are subject to change without notice.

Memo

Memo

ONKYO CORPORATION

Sales & Product Planning Div. : 2-1, Nisshin-cho, Neyagawa-shi, OSAKA 572-8540, JAPAN
Tel: 072-831-8023 Fax: 072-831-8124

ONKYO U.S.A. CORPORATION

18 Park Way, Upper Saddle River, N.J. 07458, U.S.A.
Tel: 201-785-2600 Fax: 201-785-2650 <http://www.us.onkyo.com/>

ONKYO EUROPE ELECTRONICS GmbH

Liegnitzerstrasse 6, 82194 Groebenzell, GERMANY
Tel: +49-8142-4401-0 Fax: +49-8142-4401-555 <http://www.eu.onkyo.com/>

ONKYO EUROPE UK Office

Suite 1, Gregories Court, Gregories Road, Beaconsfield, Buckinghamshire, HP9 1HQ
UNITED KINGDOM Tel: +44-(0)1494-681515 Fax: +44(0)-1494-680452

ONKYO CHINA LIMITED

Units 2102-2107, Metroplaza Tower I, 223 Hing Fong Road, Kwai Chung,
N.T., HONG KONG Tel: 852-2429-3118 Fax: 852-2428-9039
<http://www.ch.onkyo.com/>



I0503-2

SN 29343977A

(C) Copyright 2005 ONKYO CORPORATION Japan. All rights reserved.

Download from www.Somanuals.com. All Manuals Search And Download.



* 2 9 3 4 3 9 7 7 A *

Free Manuals Download Website

<http://myh66.com>

<http://usermanuals.us>

<http://www.somanuals.com>

<http://www.4manuals.cc>

<http://www.manual-lib.com>

<http://www.404manual.com>

<http://www.luxmanual.com>

<http://aubethermostatmanual.com>

Golf course search by state

<http://golfingnear.com>

Email search by domain

<http://emailbydomain.com>

Auto manuals search

<http://auto.somanuals.com>

TV manuals search

<http://tv.somanuals.com>