

ONKYO®

AV Receiver

TX-DS575X

Instruction Manual

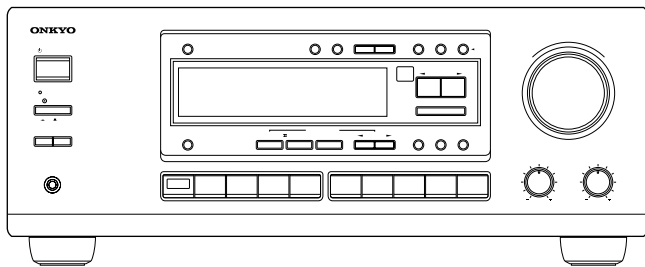

Thank you for purchasing the Onkyo AV Receiver. Please read this manual thoroughly before making connections and turning on the power. Following the instructions in this manual will enable you to obtain optimum performance and listening enjoyment from your new AV Receiver. Please retain this manual for future reference.

Contents

Before using

Important Safeguards.....	2
Precautions	3
Features.....	4
Supplied accessories.....	4
Before operating this unit.....	5

Preparation

Audio equipment connections	6
Video equipment connections	7
Connecting other devices	8
Connecting speakers.....	10
Positioning speakers.....	11
Connecting the power.....	11
Making antenna connections	12

Operation

Speaker setup.....	14
Selecting a sound source	17
Using Listening Mode	21
Tuning in a radio station.....	24
Using preset radio stations.....	25
Receiving RDS broadcasts (European models only).....	27
Recording a source	29
Using the remote controller.....	31
Programming the remote controller codes of other devices into the RC-392M.....	34
Using a Macro function.....	36

Appendix

Troubleshooting guide.....	40
Specifications	41

Control guide

Control positions and names	42
-----------------------------------	----

WARNING:

TO REDUCE THE RISK OF FIRE OR ELECTRIC SHOCK, DO NOT EXPOSE THIS APPLIANCE TO RAIN OR MOISTURE.

CAUTION:

TO REDUCE THE RISK OF ELECTRIC SHOCK, DO NOT REMOVE COVER (OR BACK). NO USER-SERVICEABLE PARTS INSIDE. REFER SERVICING TO QUALIFIED SERVICE PERSONNEL.



WARNING
RISK OF ELECTRIC SHOCK
DO NOT OPEN

AVIS
RISQUE DE CHOC ELECTRIQUE
NE PAS OUVRIR



The lightning flash with arrowhead symbol, within an equilateral triangle, is intended to alert the user to the presence of uninsulated "dangerous voltage" within the product's enclosure that may be of sufficient magnitude to constitute a risk of electric shock to persons.



The exclamation point within an equilateral triangle is intended to alert the user to the presence of important operating and maintenance (servicing) instructions in the literature accompanying the appliance.

Important Safeguards

- 1. Read Instructions** – All the safety and operating instructions should be read before the appliance is operated.
- 2. Retain Instructions** – The safety and operating instructions should be retained for future reference.
- 3. Heed Warnings** – All warnings on the appliance and in the operating instructions should be adhered to.
- 4. Follow Instructions** – All operating and use instructions should be followed.
- 5. Water and Moisture** – The appliance should not be used near water – for example, near a bathtub, washbowl, kitchen sink, laundry tub, in a wet basement, or near a swimming pool, and the like.
- 6. Carts and Stands** – The appliance should be used only with a cart or stand that is recommended by the manufacturer.

PORTABLE CART WARNING



S3125A
- 6A. An appliance and cart combination** should be moved with care. Quick stops, excessive force, and uneven surfaces may cause the appliance and cart combination to overturn.
- 7. Wall or Ceiling Mounting** – The appliance should be mounted to a wall or ceiling only as recommended by the manufacturer.
- 8. Ventilation** – The appliance should be situated so that its location or position does not interfere with its proper ventilation. For example, the appliance should not be situated on a bed, sofa, rug, or similar surface that may block the ventilation openings; or if placed in a built-in installation, such as a bookcase or cabinet that may impede the flow of air through the ventilation openings, there should be free space of at least 20 cm (8 in.) and an opening behind the appliance.
- 9. Heat** – The appliance should be situated away from heat sources such as radiators, heat registers, stoves, or other appliances (including amplifiers) that produce heat.
- 10. Power Sources** – The appliance should be connected to a power supply only of the type described in the operating instructions or as marked on the appliance.
- 11. Polarization** – If the appliance is provided with a polarized plug having one blade wider than the other, please read the following information:
The polarization of the plug is a safety feature. The polarized plug will only fit the outlet one way. If the plug does not fit fully into the outlet, try reversing it. If there is still trouble, the user should seek the services of a qualified electrician. Under no circumstances should the user attempt to defeat the polarization of the plug.
- 12. Power-Cord Protection** – Power-supply cords should be routed so that they are not likely to be walked on or pinched by items placed upon or against them, especially near plugs, convenience receptacles, and the point where they exit from the appliance.
- 13. Cleaning** – The appliance should be cleaned only as recommended by the manufacturer.
- 14. Power Lines** – An outdoor antenna should be located away from power lines.
- 15. Nonuse Periods** – The power cord of the appliance should be unplugged from the outlet when left unused for a long period of time.
- 16. Object and Liquid Entry** – Care should be taken so that objects do not fall and liquids are not spilled into the enclosure through openings.
- 17. Damage Requiring Service** – The appliance should be serviced by qualified service personnel when:
 - A. The power-supply cord or the plug has been damaged; or
 - B. Objects have fallen, or liquid has been spilled into the appliance; or
 - C. The appliance has been exposed to rain; or
 - D. The appliance does not appear to operate normally or exhibits a marked change in performance; or
 - E. The appliance has been dropped, or the enclosure damaged.
- 18. Servicing** – The user should not attempt to service the appliance beyond that described in the operating instructions. All other servicing should be referred to qualified service personnel.
- 19. Outdoor Antenna Grounding** – If an outside antenna is connected to the receiver, be sure the antenna system is grounded so as to provide some protection against voltage surges and built up static charges. Article 810 of the National Electrical Code, ANSI/NFPA 70, provides information with regard to proper grounding of the mast and supporting structure, grounding of the lead-in wire to an antenna-discharge unit, size of grounding conductors, location of antenna-discharge unit, connection to grounding electrodes, and requirements for the grounding electrode. See Figure 1.

FIGURE 1:
EXAMPLE OF ANTENNA GROUNDING AS PER NATIONAL ELECTRICAL CODE

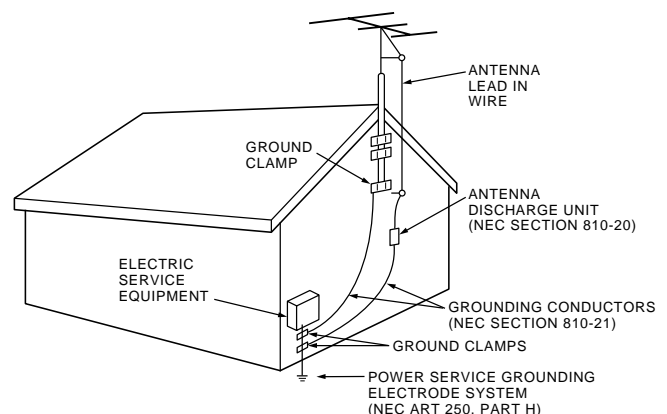

NEC – NATIONAL ELECTRICAL CODE

S2898A

Precautions

1. Warranty Claim

You can find the serial number on the rear panel of this unit. In case of warranty claim, please report this number.

2. Recording Copyright

Recording of copyrighted material for other than personal use is illegal without permission of the copyright holder.

3. AC Fuse

The fuse is located inside the chassis and is not user-serviceable. If power does not come on, contact your Onkyo authorized service station.

4. Care

From time to time you should wipe the front and rear panels and the cabinet with a soft cloth. For heavier dirt, dampen a soft cloth in a weak solution of mild detergent and water, wring it out dry, and wipe off the dirt. Following this, dry immediately with a clean cloth. Do not use rough material, thinners, alcohol or other chemical solvents or cloths since these could damage the finish or remove the panel lettering.

5. Power

WARNING

BEFORE PLUGGING IN THE UNIT FOR THE FIRST TIME, READ THE FOLLOWING SECTION CAREFULLY.

The voltage of the available power supply differs according to country or region. Be sure that the power supply voltage of the area where this unit will be used meets the required voltage (e.g., AC 230 V, 50 Hz or AC 120 V, 60 Hz) written on the rear panel.

Worldwide models are equipped with a voltage selector to conform to local power supplies. Be sure to set this switch to match the voltage of the power supply in your area before plugging in the unit.

For British model

Replacement and mounting of an AC plug on the power supply cord of this unit should be performed only by qualified service personnel.

IMPORTANT

The wires in the mains lead are coloured in accordance with the following code:

Blue : Neutral

Brown : Live

As the colours of the wires in the mains lead of this apparatus may not correspond with the coloured markings identifying the terminals in your plug, proceed as follows:

The wire which is coloured blue must be connected to the terminal which is marked with the letter N or coloured black.

The wire which is coloured brown must be connected to the terminal which is marked with the letter L or coloured red.

IMPORTANT

A 5 amp fuse is fitted in this plug. Should the fuse need to be replaced, please ensure that the replacement fuse has a rating of 5 amps and that it is approved by ASTA or BSI to BS1362. Check for the ASTA mark or the BSI mark on the body of the fuse.

IF THE FITTED MOULDED PLUG IS UNSUITABLE FOR THE SOCKET OUTLET IN YOUR HOME THEN THE FUSE SHOULD BE REMOVED AND THE PLUG CUT OFF AND DISPOSED OF SAFELY. THERE IS A DANGER OF SEVERE ELECTRICAL SHOCK IF THE CUT OFF PLUG IS INSERTED INTO ANY 13 AMP SOCKET.

If in any doubt, please consult a qualified electrician.

For U.S. model

Note to CATV system installer:

This reminder is provided to call the CATV system installer's attention to Article 820-40 of the NEC, ANSI/NFPA 70, which provides guidelines for proper grounding and, in particular, specifies that the cable ground shall be connected to the grounding system of the building, as close to the point of cable entry as practical.

FCC Information for User

CAUTION:

The user changes or modifications not expressly approved by the party responsible for compliance could void the user's authority to operate the equipment.

NOTE:

This equipment has been tested and found to comply with the limits for a Class B digital device, pursuant to Part 15 of the FCC Rules. These limits are designed to provide reasonable protection against harmful interference in a residential installation. This equipment generates, uses and can radiate radio frequency energy and, if not installed and used in accordance with the instructions, may cause harmful interference to radio communications. However, there is no guarantee that interference will not occur in a particular installation. If this equipment does cause harmful interference to radio or television reception, which can be determined by turning the equipment off and on, the user is encouraged to try to correct the interference by one or more of the following measures:

- Reorient or relocate the receiving antenna.
- Increase the separation between the equipment and receiver.
- Connect the equipment into an outlet on a circuit different from that to which the receiver is connected.
- Consult the dealer or an experienced radio/TV technician for help.

For Canadian model

NOTE:

THIS CLASS B DIGITAL APPARATUS COMPLIES WITH CANADIAN ICES-003.

For models having a power cord with a polarized plug:

CAUTION: TO PREVENT ELECTRIC SHOCK, MATCH WIDE BLADE OF PLUG TO WIDE SLOT, FULLY INSERT.

Modele pour les Canadiens

REMARQUE:

CET APPAREIL NUMÉRIQUE DE LA CLASSE B EST CONFORME À LA NORME NMB-003 DU CANADA.

Sur les modèles dont la fiche est polarisée:

ATTENTION: POUR ÉVITER LES CHOCS ÉLECTRIQUES, INTRODUIRE LA LAME LA PLUS LARGE DE LA FICHE DANS LA BORNE CORRESPONDANTE DE LA PRISE ET POUSSER JUSQU'AU FOND.

Declaration of Conformity

We, ONKYO EUROPE
ELECTRONICS GmbH
INDUSTRIESTRASSE 20
82110 GERMERING,
GERMANY



declare in own responsibility, that the ONKYO product described in this instruction manual is in compliance with the corresponding technical standards such as EN60065, EN55013, EN55020 and EN61000-3-2, -3-3 (or EN60555-2, -3)

GERMERING, GERMANY

A. HORIUCHI

ONKYO EUROPE ELECTRONICS GmbH

Features

- 70 WATTS MINIMUM of continuous RMS power to each of the five channels into 8Ω from 20 Hz to 20 kHz with no more than 0.08 % THD (USA models, FTC rating)
- 100 WATTS MINIMUM of continuous RMS power to each of the five channels into 6Ω at 1 kHz (European models, DIN)
- 130 WATTS MINIMUM to each of the five channels into 6Ω at 1 kHz (Asian models, EIAJ)
- WRAT — WIDE RANGE AMPLIFIER TECHNOLOGY
- DTS®*, DOLBY®** DIGITAL AND DOLBY® PRO LOGIC DECODERS
- 5.1 CHANNEL EXTERNAL INPUTS
- 8 DSP LISTENING MODES
- CINEMA Re-EQ™*** CIRCUITRY
- STATE-OF-THE-ART 96 kHz/24-BIT D/A CONVERTER
- 4 ASSIGNABLE DIGITAL INPUT (2 coaxial and 2 optical)
- HEAVY-DUTY MULTIWAY SPEAKER BINDING POSTS FOR ALL CHANNELS; ALL DUAL BANANA-PLUG COMPATIBLE
- 3 AUDIO INPUTS AND 4 A/V INPUTS
- 4 S-VIDEO INPUTS, 2 S-VIDEO OUTPUTS
- AUTO DIGITAL/ANALOG SIGNAL DETECTION & SWITCHING
- “POWER ON” VOLUME FUNCTION
- POWERFUL BACKLIT LEARNING REMOTE WITH MACRO FUNCTIONS

*Manufactured under license from Digital Theater Systems, Inc. US Pat. No.5,451,942 and other worldwide patents issues and pending. “DTS” and “DTS Digital Surround” are trademarks of Digital Theater Systems, Inc.© 1996 Digital Theater Systems, Inc. All rights reserved.

** Manufactured under license from Dolby Laboratories. “Dolby”, “Pro Logic” and the double-D symbol  are trademarks of Dolby Laboratories. Confidential Unpublished Works. ©1992-1997 Dolby Laboratories, Inc. All rights reserved.

*** Re-Equalization and the “Re-EQ” logo are trademarks of Lucasfilm Ltd. Manufactured under license of Lucasfilm Ltd..

Supplied accessories

Check that the following accessories are supplied with this unit.

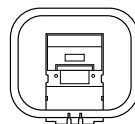

AM loop antenna × 1

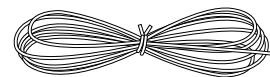

FM antenna × 1

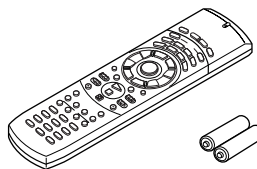

Remote controller (RC-392M) × 1
Batteries (size AA or UM-3) × 2

Available on the models other than U.S., Canadian, and European models.

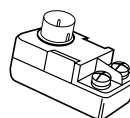

75/300 ohm antenna adapter × 1

Available for worldwide models.

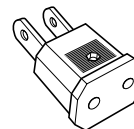

Conversion plug × 1
Use this plug if the power cord plug of the TX-DS575X does not fit your AC outlet.
(Shape may vary depending on the area which it was purchased.)

Memory Preservation

This unit does not require memory preservation batteries. A built-in memory power back-up system preserves the contents of the memory during power failures and even when the POWER switch is set to off. The POWER switch must be set to on in order to charge the back-up system.

The memory preservation period after the unit has been turned off varies depending on climate and placement of the unit. On the average, memory contents are protected over a period of a few weeks after the last time the unit has been turned off. This period is shorter when the unit is exposed to a very humid climate.

Before operating this unit

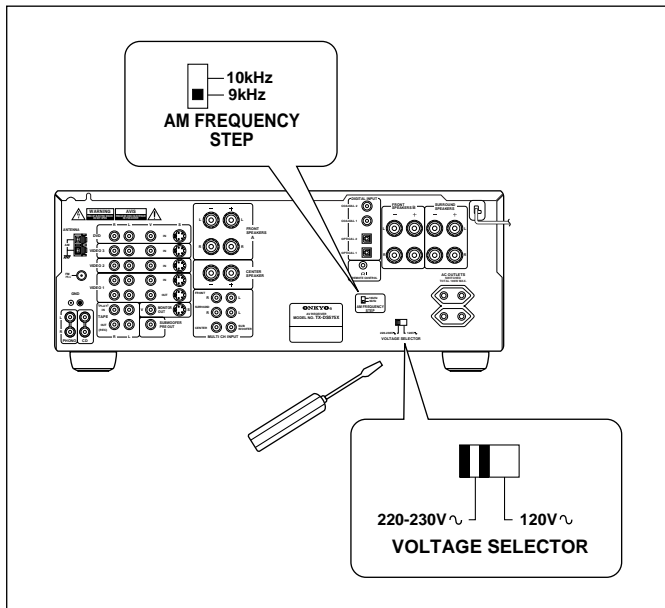

Setting the AM tuning step frequency (Worldwide models only)

Worldwide models are equipped with a switch that controls the AM band tuning steps. Please set this switch to match the AM band tuning step frequency in your area.

U.S.A. and Canada : 10 kHz
Other areas : 9 kHz

Setting the Voltage selector (Worldwide models only)

Worldwide models are equipped with a voltage selector to conform with local power supplies. Be sure to set this switch to match the voltage of the power supply in your area before plugging in the unit.

1. Determine the proper voltage for your area: 220-230 V or 120 V.
2. If the preset voltage is not correct for your area, insert a screwdriver into the groove in the switch. Slide the switch all the way to the right (120 V) or to the left (220-230 V), whichever is appropriate.

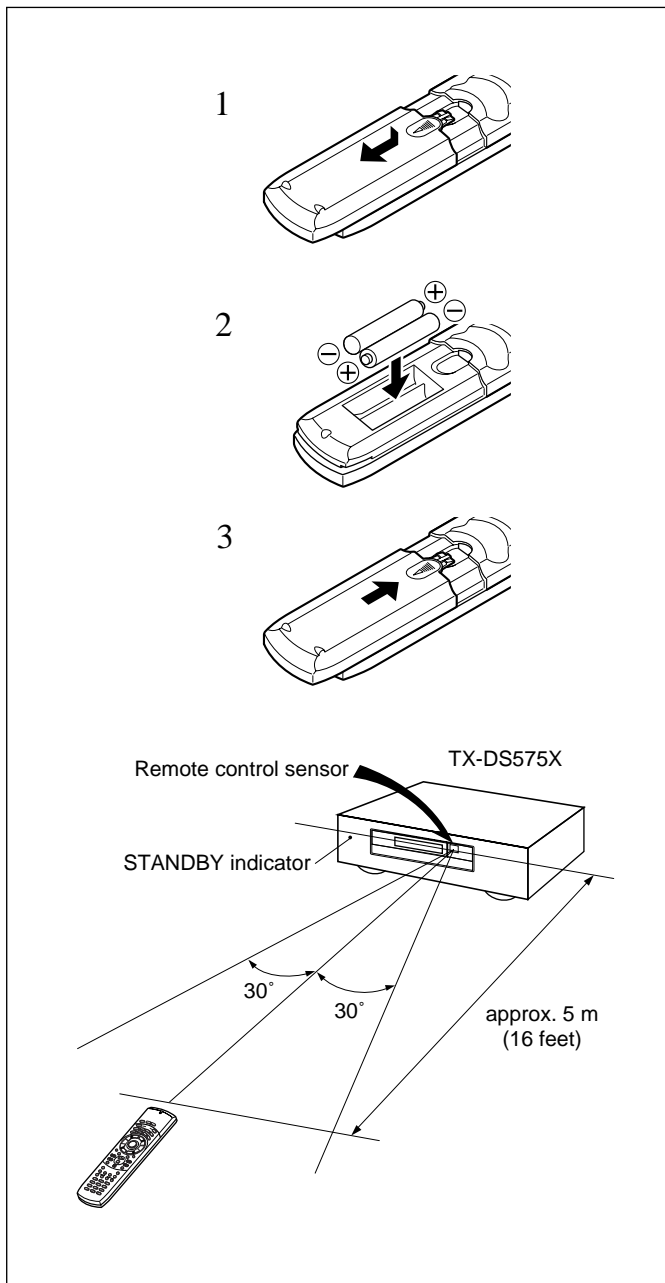

Installing the remote controller batteries

1. Remove the battery compartment cover by pressing and sliding it out.
2. Insert two AA (R6- or UM-3-) size batteries into the battery compartment. Carefully follow the polarity diagram (positive (+) and negative (-) symbols) inside the battery compartment.
3. After batteries are installed and seated correctly, replace the compartment cover.

Notes

- Do not mix new batteries with old batteries or different kinds of batteries.
- To avoid corrosion, remove the batteries if the remote controller is not to be used for a long time.
- Remove dead batteries immediately to avoid damage from corrosion. If the remote controller doesn't operate smoothly, replace both the batteries at the same time.
- The life of the batteries supplied is about six months but this will vary depending on usage.

Using the remote controller

Point the remote controller toward the remote control sensor. The STANDBY indicator lights up when the unit receives a signal from the remote controller.

Notes

- Place the unit away from strong light such as direct sunlight or inverted fluorescent light which can prevent proper operation of the remote controller.
- Using another remote controller of the same type in the same room or using the unit near equipment which uses infrared rays may cause operational interference.
- Do not put any object such as a book on the remote controller. The buttons of the remote controller may be pressed by mistake and drain the batteries.
- Make sure the audio rack doors do not have colored glass. Placing the unit behind such doors may prevent proper remote controller operation.
- If there is any obstacle between the remote controller and the remote control sensor, the remote controller will not operate.

Audio equipment connections

- On each pair of input jacks, a red connector (marked R) corresponds to the right channel, and a white connector (marked L) to the left channel.
- Please refer to the instruction manual of each component when making any connections.
- This receiver is designed for use with turntables using moving magnet cartridges.
- Insert the plugs and connectors securely. Remember that improper connection can result in noise, poor performance, or damage to the equipment.

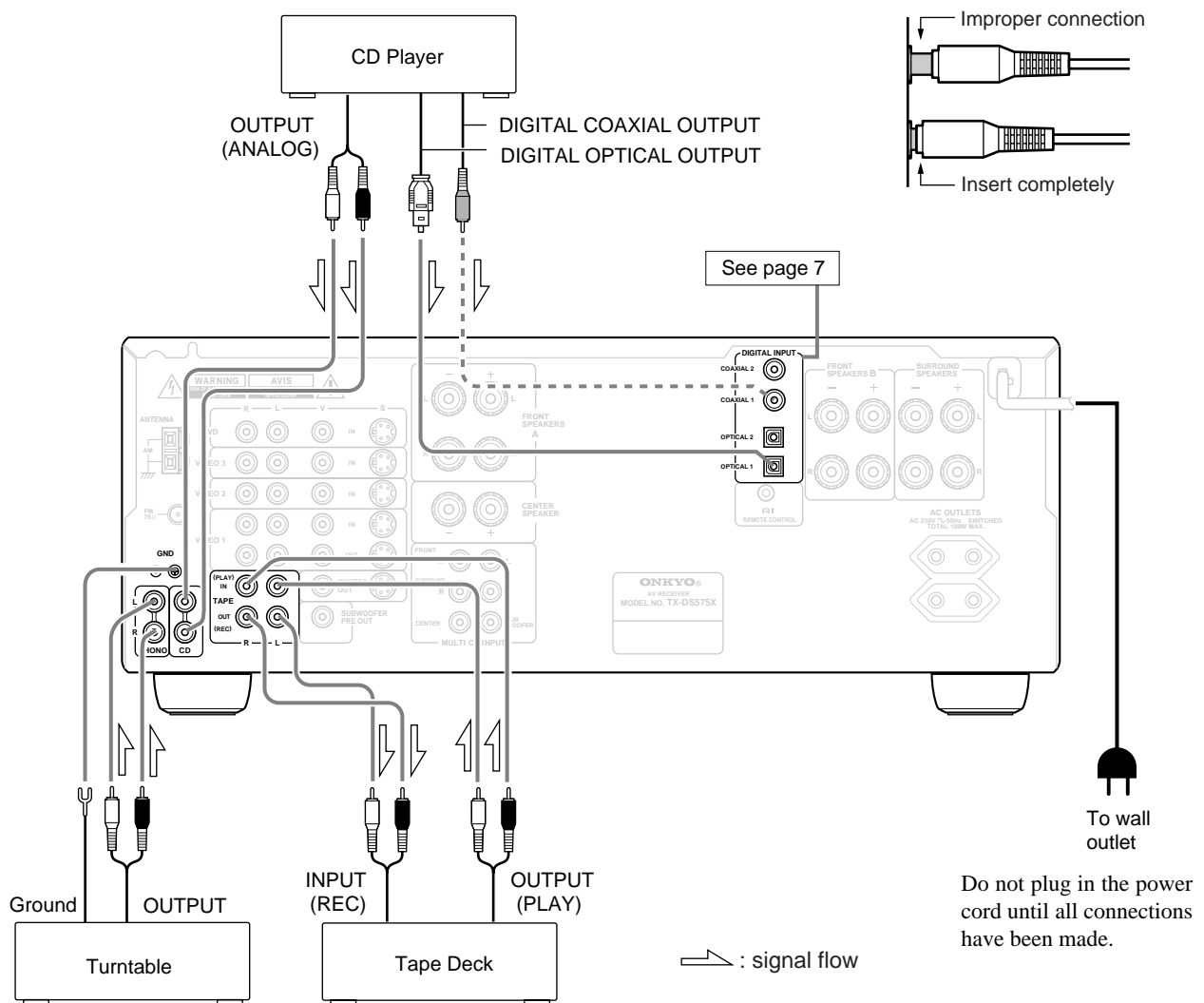
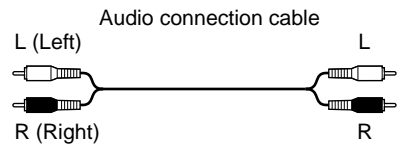

- A DVD or other component equipped with a digital output can be connected to this receiver. The digital connection must be used in conjunction with an analog connection, because if the analog cable is disconnected, the audio output from TAPE OUT (REC) and VIDEO 1 OUT will not work.
- Remove the protective cap attached to the DIGITAL INPUT OPTICAL jack before making the connection. When this jack is not used, replace the protective cap.

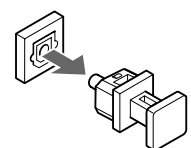

Video equipment connections

- On each pair of input jacks, a red connector (marked R) corresponds to the right channel, and a white connector (marked L) to the left channel.
- A yellow connector (marked V) is used for video connection.
- Please refer to the instruction manual of each component when making any connections.

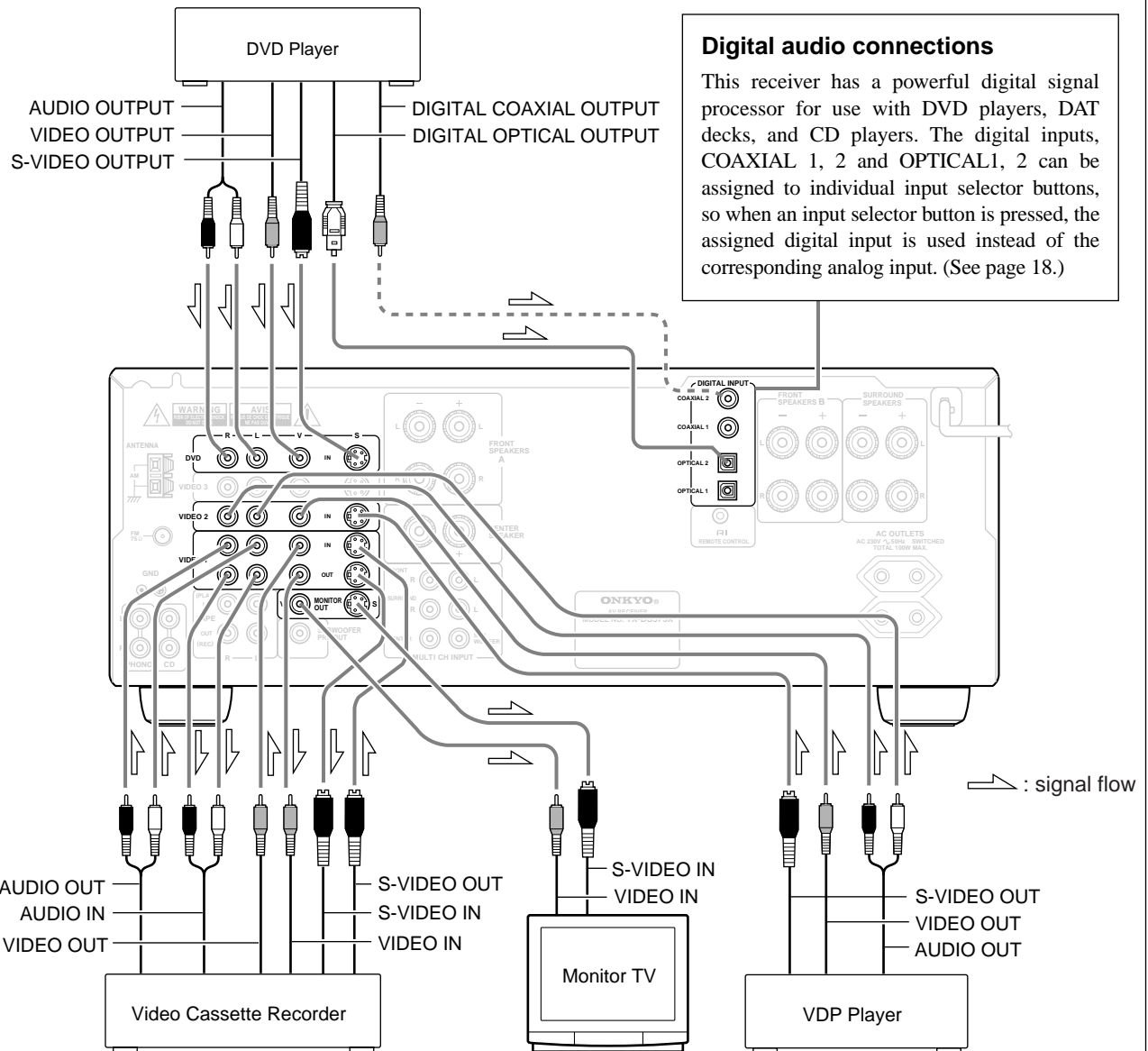
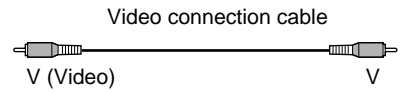
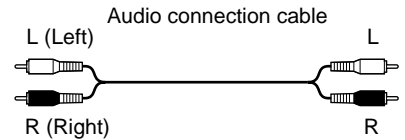

Digital audio connections

This receiver has a powerful digital signal processor for use with DVD players, DAT decks, and CD players. The digital inputs, COAXIAL 1, 2 and OPTICAL1, 2 can be assigned to individual input selector buttons, so when an input selector button is pressed, the assigned digital input is used instead of the corresponding analog input. (See page 18.)

Notes:

- When using a playback-only VCR, connect it to VIDEO 2 or VIDEO 3. If you connect it to VIDEO 1, you need to make only the output connections.
- This receiver can be used with only a monitor TV equipped with a video input jack.
- Interference can be caused between the TV and this receiver. If this interference occurs, place the receiver and the TV as far apart as possible. We do not recommend the use of a common TV/FM antenna (see antenna section).
- A DVD or other component equipped with a digital output can be connected to this receiver. The digital connection must be used in conjunction with an analog connection, because if the analog cable is disconnected, the audio output from TAPE OUT (REC) and VIDEO 1 OUT will not work.
- A signal input from the S-video connector will be routed to the S-video out, and the signal input from the video connector will be routed to the video out.
- Refer to the instruction manual for the devices you wish to connect for information on whether you need to connect only the S-video connector, or both S-video connector and video connector.
- Remove the protective cap attached to the DIGITAL INPUT (OPTICAL) jack before making the connection. When this jack is not used, replace the protective cap.

Connecting other devices

- On each pair of input jacks, a red connector (marked R) corresponds to the right channel, and a white connector (marked L) to the left channel.
- A yellow connector (marked V) is used for video connection.
- Please refer to the instruction manual of each component when making any connections.

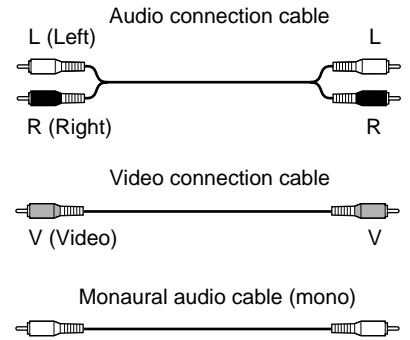

Decoder with 5.1 channel output

You may connect the 5.1 channel outputs of an external decoder (such as MPEG decoder) to the MULTI CHANNEL INPUTs of this unit.

Use the DVD player or decoder controls to adjust the speaker settings for multi-channel input.

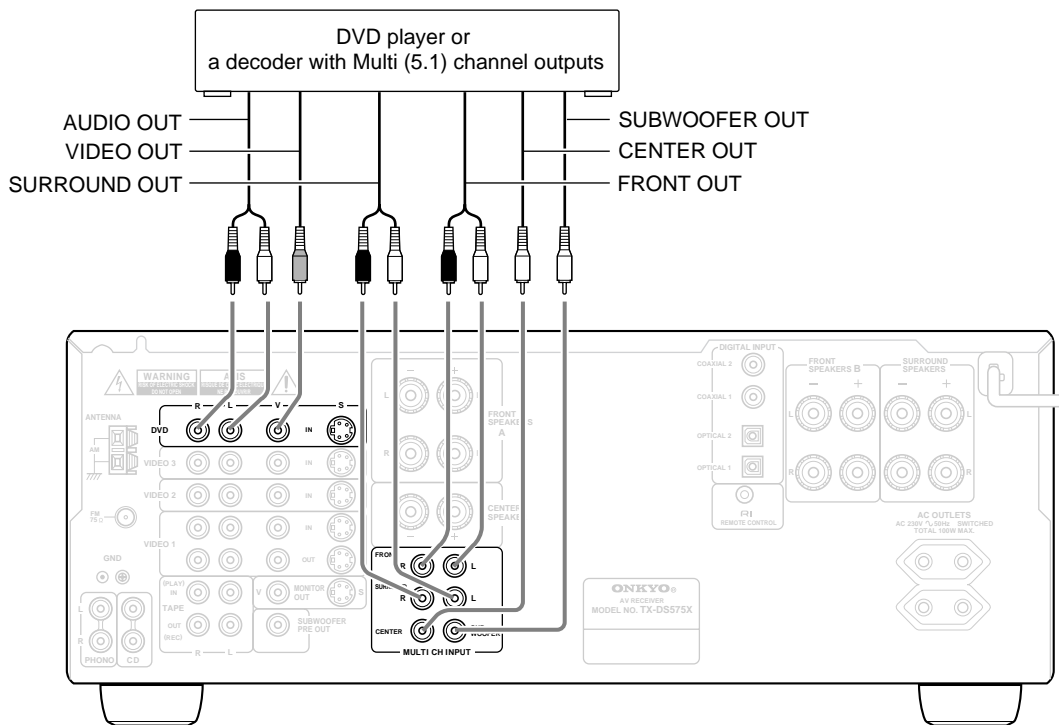

Connecting other devices

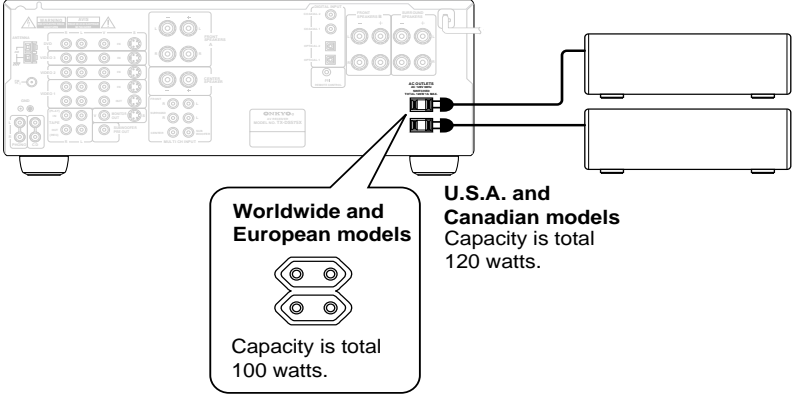

Worldwide and European models
Capacity is total 100 watts.

U.S.A. and Canadian models
Capacity is total 120 watts.

AC outlet connection

You can connect the power cord from another audio device to the rear of this receiver. Since the AC outlets on the unit are a SWITCHED type outlet, you can use the STANDBY/ON button, or the POWER ON button on the remote controller to turn on/off the power to both this receiver and the connected audio devices.

First turn the POWER switch ON ( ON).

The shape, number, and total capacity of the AC outlets may differ depending on the area of purchase. Make sure that the total capacity of other components connected to this unit does not exceed the capacity that is printed on the rear panel.

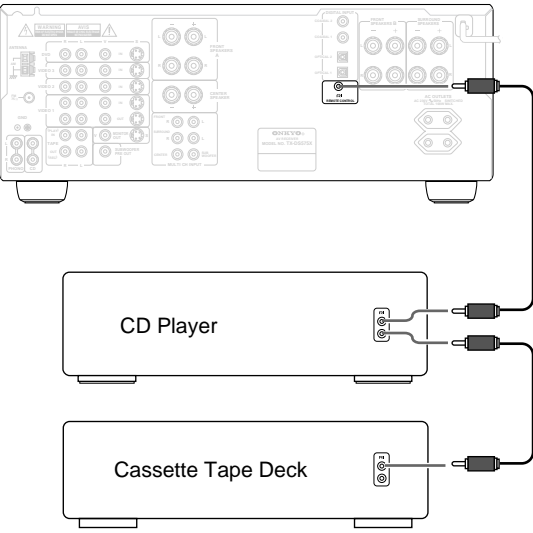

TX-DS575X

CD Player

Cassette Tape Deck

Connections for remote control (RI)

You can use the remote controller of this receiver to operate cassette tape decks and compact disc players that have Onkyo **RI** connectors.

Connect a remote control cable to the connector with the **RI** mark.

- An **RI** remote control cable equipped with a 3.5mm (1/8 in.)-diameter miniature two-conductor phone plug comes with every compact disc player or cassette tape deck that has an **RI** connector.
- Remote control operation is not possible if only the remote control cable is connected – the audio connection cables must also be connected.
- This receiver's remote controller does not support control of Onkyo turntables.
- If the connecting device has two **RI** connectors lined-up vertically or horizontally, you can use either of them. They both offer the same functionality.
- You can use the remote controller for the TX-DS575X to control a Onkyo DVD player or MD recorder that is not connected via an **RI** cable. When you control such a DVD player or MD recorder, point the remote controller toward the sensor area of the DVD player or MD recorder.

Connecting speakers

- If you want to use the surround effects, connect surround speakers. For the best results, connect a center speaker.
- Use FRONT SPEAKERS B terminals to connect a second pair of front speakers.
- This receiver is designed to produce optimum sound quality when speakers with impedances within the specified ranges are connected. Please check the following information and choose speakers with appropriate impedances for the connections.

FRONT SPEAKERS: A or B: 6 ohms min./speaker
SURROUND SPEAKERS: 6 ohms min./speaker
CENTER SPEAKER: 6 ohms min.

Connecting the speaker cable

1. Twist wire ends very tight.

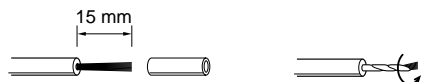

2. Unscrew.



3. Insert wire.

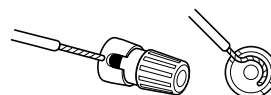

4. Screw.

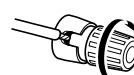

NOTE:

To prevent damage to circuitry, never short-circuit the positive (+) and negative (-) speaker wire.

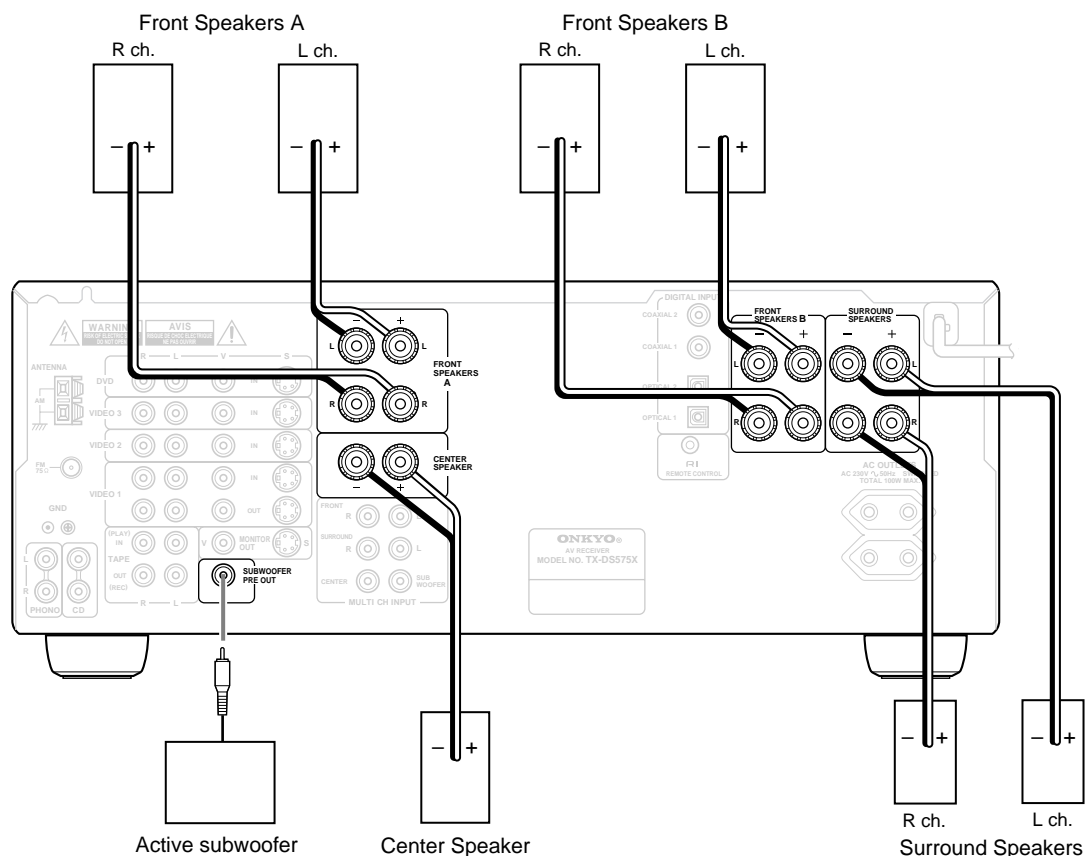

- When you use only one speaker or wish to listen to monaural (mono) sound, a single speaker should never be connected in parallel to both the right and left channel terminals simultaneously.

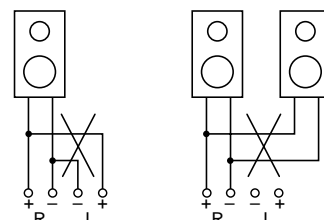

Positioning speakers

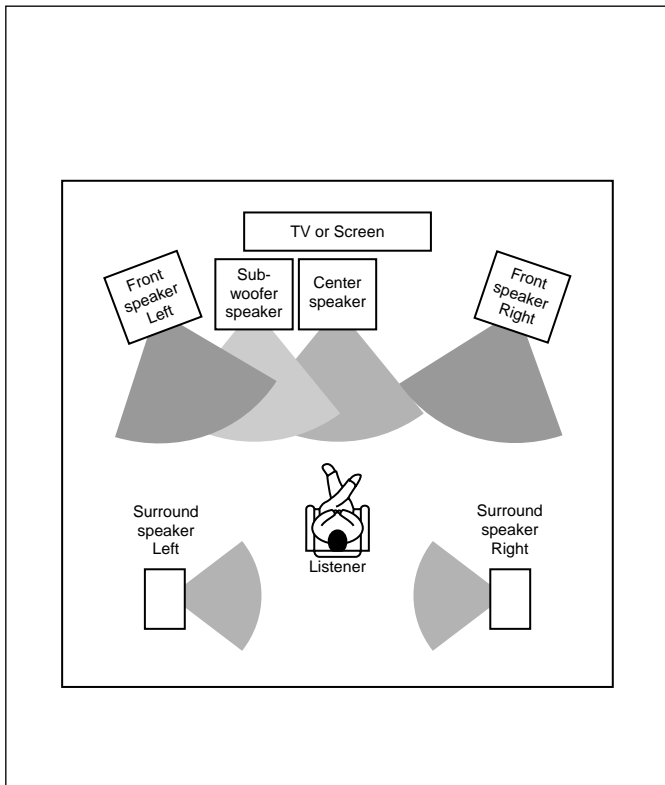

Positioning speakers

Speaker placement plays an important role in the reproduction of Surround sound. The placement of the speakers varies depending on the size of the room and the wall coverings used in the room. The illustration shows an example of a layout for standard speaker placement. Refer to this example when you position the speakers in order to experience the best of Surround sound.

Standard speaker placement

For ideal Surround effects, all speakers should be installed. If a center speaker or subwoofer is not connected, the sound from the unused channel is properly distributed to the connected speakers in order to produce the best Surround sound possible.

Front: The left, right, and center speakers should face the seated listener and be placed at ear level. The center speaker produces a richer sound image by enhancing the perception of the sound's source and movement.

Surround: Place the left and right Surround speakers 1 meter (3 feet) above the listener's ear level and facing toward the sides of the room, making sure that the listener is within the speakers' dispersion angle. These speakers produce the feel of a moving sound while creating the sensation of being in the middle of the action.

Subwoofer: Install a subwoofer with a built-in power amplifier for powerful bass sounds. The placement of the subwoofer does not affect the final quality of the sound image too much, so you can install it with the room layout in mind.

Refer to the speaker's instruction manual for more details.

Connecting the power

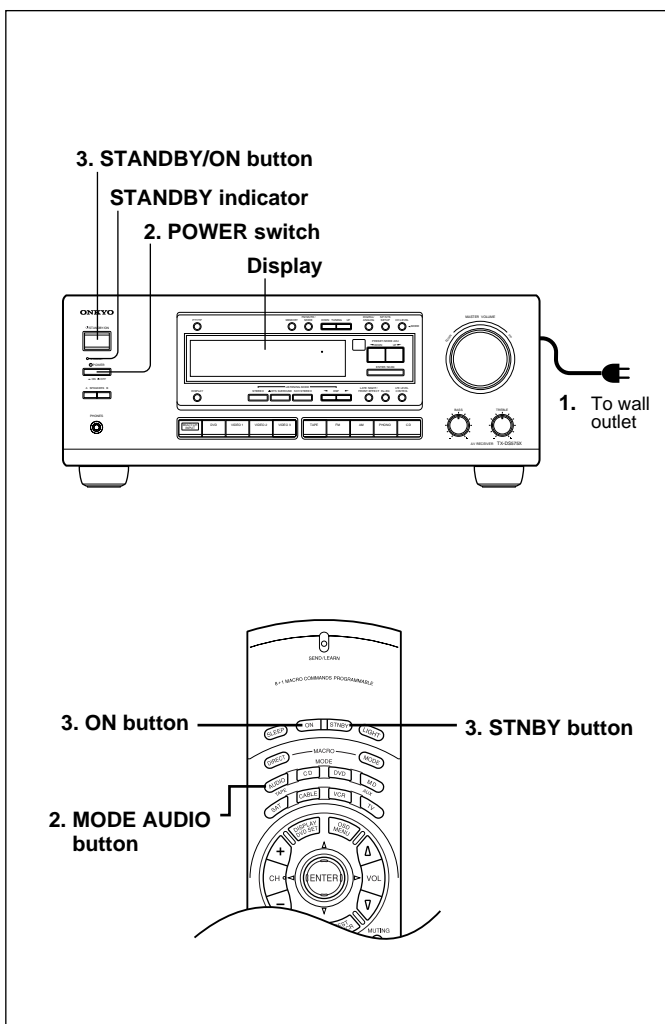

Connecting the power

- Before you plug in the receiver, confirm that all connections have been made properly.
- Turning on this receiver's power may cause a momentary power surge, which might interfere with other electrical equipment, such as computers. If this happens, use a wall outlet on a different circuit.

1. Plug the power cord into an AC wall outlet.

NOTE:

When you use the TX-DS575X for the first time:

When the TX-DS575X is shipped from the factory, the POWER switch is set to ON (■). Therefore, when you plug in the power cord to the AC outlet, the Standby indicator lights up and the unit enters Standby mode as described in Step 2.

2. Press the POWER switch to set it to the ON (■) position to place the receiver in Standby mode.

The STANDBY indicator will light up.

Press the POWER switch again to set it to the OFF (■) position to turn off the power to the receiver.

3. Press the STANDBY/ON button to turn on the receiver. The display will light up and the STANDBY indicator will be turned off.

If you press the STANDBY/ON button, the receiver returns to Standby mode.

Turning the power on from the remote controller:

1. Press the POWER switch of the TX-DS575X to turn on the power to the unit.
2. Press the MODE AUDIO button.
3. Press the ON button to turn on the power to the TX-DS575X, or press the STNBY button to set the receiver in standby mode.

- You cannot use the remote controller if the POWER switch on the receiver is set to OFF.
- Set the volume level to minimum before you turn off the power to the receiver.

Making antenna connections

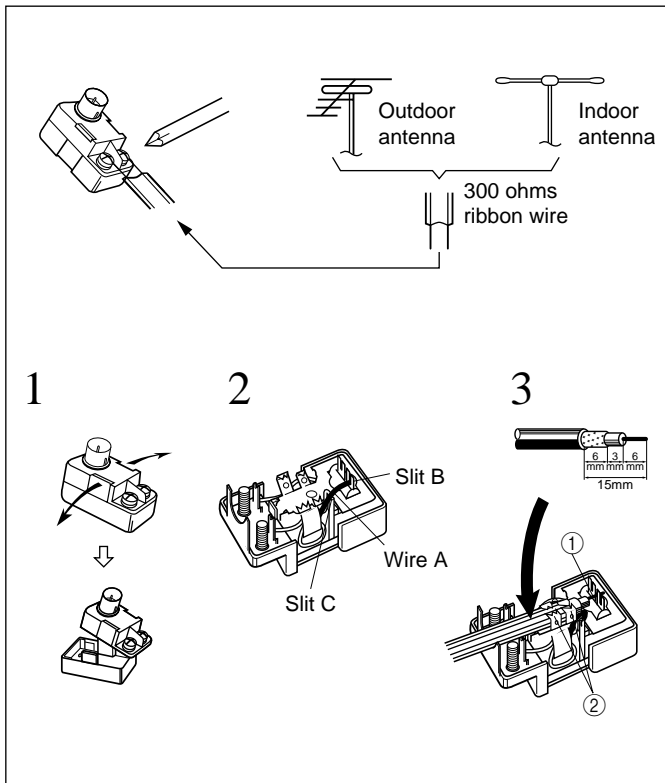

Connecting the antenna cable to the 75/300 ohm antenna adapter (Non-U.S., Canadian and European models)

Connecting the 300 ohm ribbon wire:

Loosen the screws and wrap the wire around these screws. Then tighten the screws with a screwdriver.

Connecting the coaxial cable:

1. With your fingernail or a small screwdriver, press the stoppers outward and remove the cover.
2. Remove the transformer wire A from slit B and insert it into slit C.
3. Prepare the coaxial cable as shown in the diagram. Connect the 75/300 ohm antenna adapter to the coaxial cable.
 - ① Insert the end of the cable.
 - ② Clamp it in place with pliers.
4. Re-install the cover.

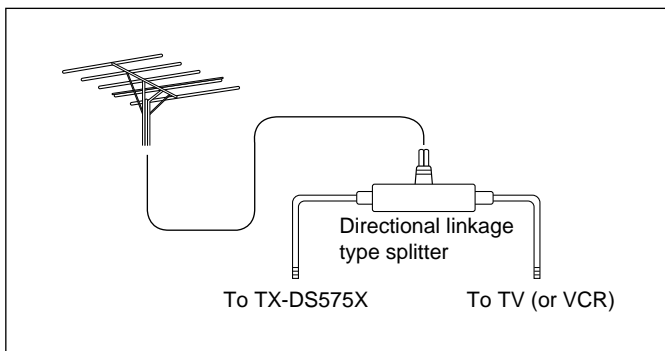

Directional linkage

Do not use the same antenna for both FM and TV (or VCR) reception since the FM and TV (or VCR) signals can interfere with each other. If you must use a common FM/TV (or VCR) antenna, use a directional linkage type splitter.

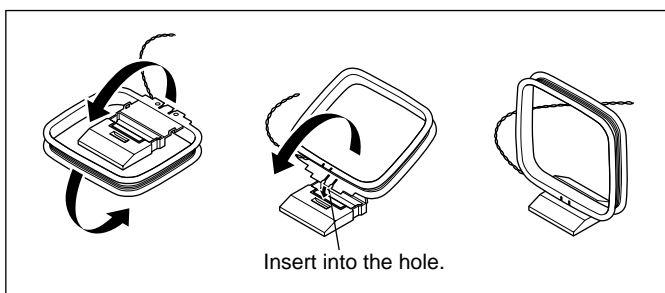

Assembling the AM loop antenna

Assemble the loop antenna as shown in the illustration.

- Refer to the next page for details on connecting the AM loop antenna.

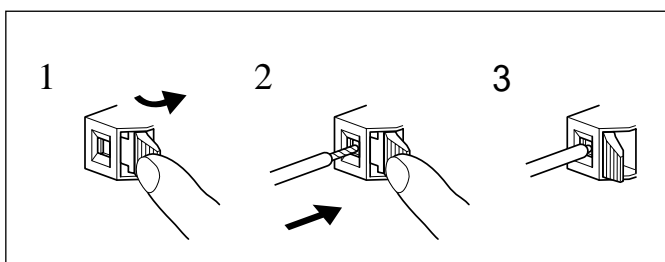

Connecting the antenna cable

1. Press down the lever.
2. Insert the wire into the hole.
3. Release the lever to replace it.

Making antenna connections

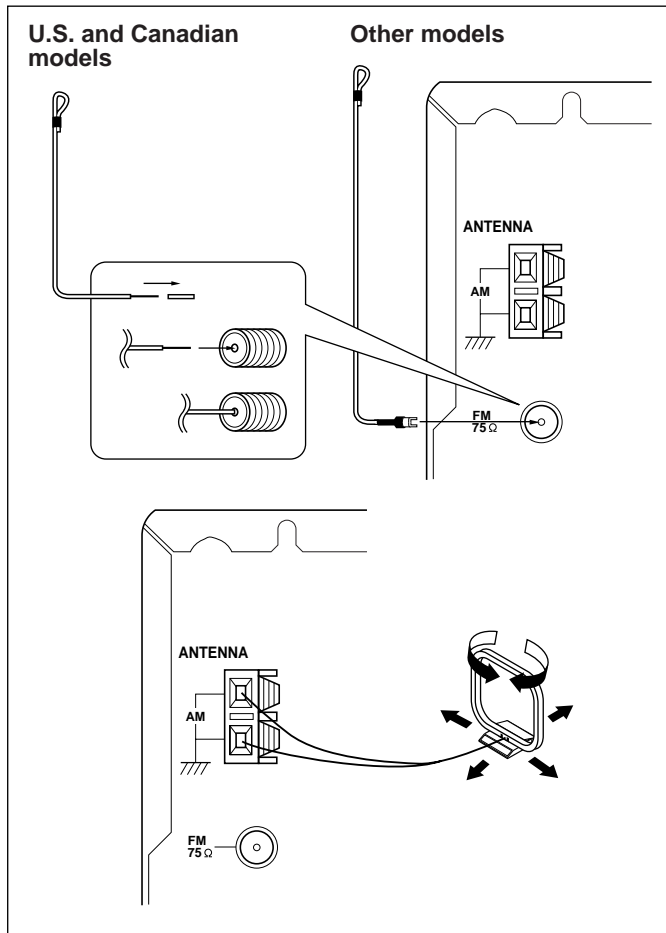

Connecting the included antennas

Connecting the FM indoor antenna:

The FM indoor antenna is for indoor use only. Extend the antenna and move it in various directions until the clearest signal is received. Fix it with push pins or similar implements in the position that will cause the least amount of distortion.

If the reception is not very clear with the attached FM indoor antenna, the use of an outdoor antenna is recommended.

U.S. and Canadian models

Remove the insulation at the tip of the cable, and insert the cable securely, fully to the end of the exposed tip.

Connecting the AM loop antenna:

The AM loop antenna is for indoor use only. Set it in the direction and position where you receive the clearest sound. Put it as far away as possible from the unit, TVs, speaker cables, and power cords.

When reception is not satisfactory with the attached AM loop antenna alone, connection of an outdoor antenna is recommended.

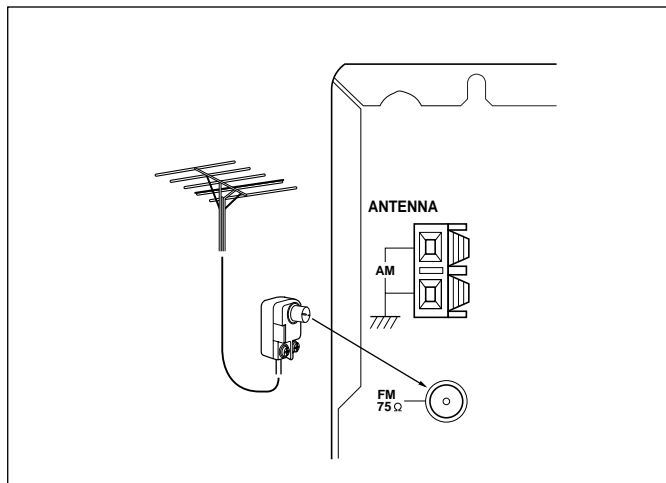

Connecting an FM outdoor antenna

Please make sure that you follow the considerations below regarding the location.

Keep the antenna away from noise sources (neon signs, busy roads, etc.).

It is dangerous to put the antenna close to power lines. Keep it well away from power lines, transformers, etc.

- To avoid the risk of lightning and electrical shock, grounding is necessary. Follow item 19 of the "Important Safeguards" on page 2 when you install the outdoor antenna.

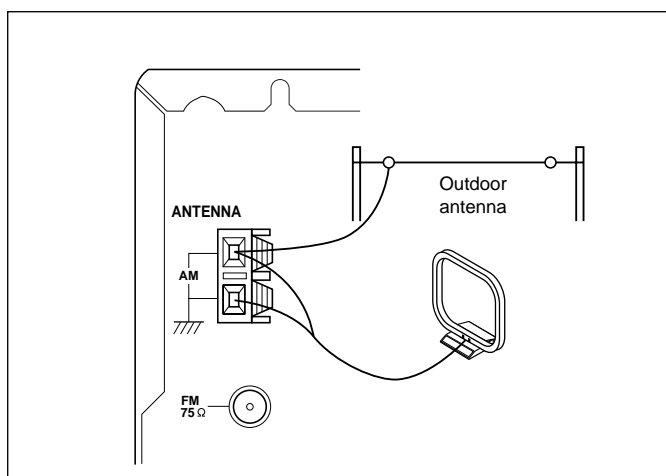

Connecting an AM outdoor antenna





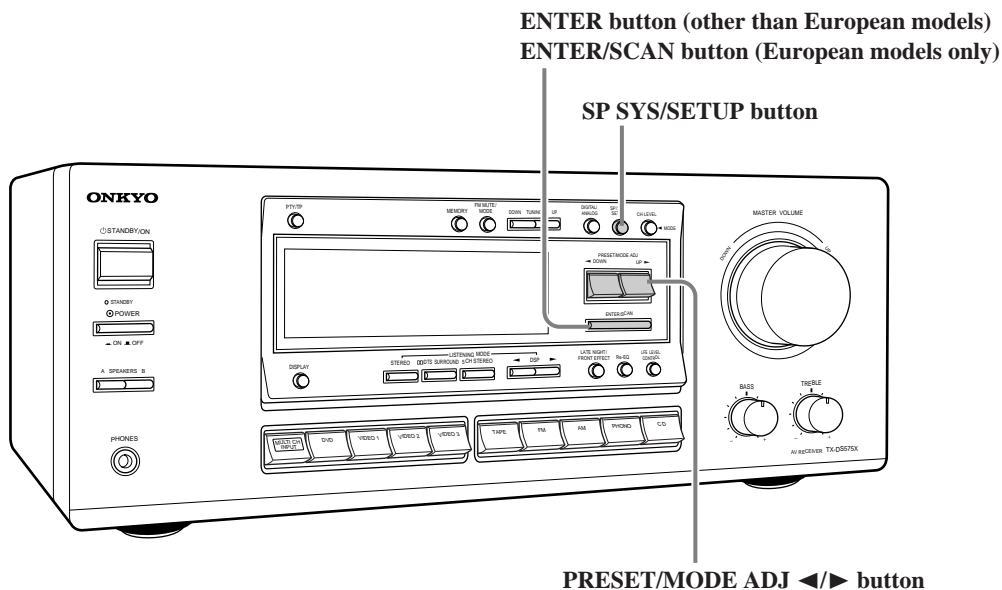

The outdoor antenna will be more effective if it is stretched horizontally above a window or outside.

- Do not remove the AM loop antenna.
- To avoid the risk of lightning and electrical shock, grounding is necessary. Follow item 19 of the "Important Safeguards" on page 2 when you install the outdoor antenna.

Speaker setup

Follow the steps below before you start operating the unit.



<p>1</p>  <p>SP/SYS SETUP</p> <p>ENTER</p> <p>or</p> <p>ENTER/SCAN</p> 	<p>SPEAKER SETUP</p> <p>↓</p> <p>CONFIG SETUP</p>	
<p>2</p> <p>ENTER</p> <p>or</p> <p>ENTER/SCAN</p>  <p>PRESET/MODE ADJ</p> <p>DOWN UP</p> 	<p>SUBWOOFER= YES</p> <p>↓</p> <p>SUBWOOFER= NO</p>	<p>ENTER</p> <p>or</p> <p>ENTER/SCAN</p> 
<p>3</p> <p>PRESET/MODE ADJ</p> <p>DOWN UP</p> 	<p>FRONT =LARGE</p> <p>or</p> <p>FRONT =SMALL</p>	<p>ENTER</p> <p>or</p> <p>ENTER/SCAN</p> 

Setting the CONFIG parameters

Set whether a speaker is used or not, and set the size of the connected speakers.

1. Press the buttons in the following sequence to display "CONFIG SETUP?"

2. Set whether a subwoofer is used or not.

When you press the ENTER/SCAN or ENTER button while "CONFIG SETUP" is displayed, the current setting ("SUBWOOFER YES" or "NO") appears. Press the PRESET/MODE ADJ ◀/▶ buttons to select "YES" or "NO."

YES: When the subwoofer is connected.

NO: When the subwoofer is not connected.

Select whichever appropriate and press the ENTER/SCAN or ENTER button.

3. Select the size of the front speakers.

If you have set the subwoofer parameter to "NO" in step 2, proceed to step 4. (At this time, the front speaker parameter automatically sets to LARGE.)

Pressing the PRESET/MODE ADJ ◀/▶ buttons toggles between "LARGE" and "SMALL."

LARGE: When large speakers are used as the front speakers.

SMALL: When small speakers are used as the front speakers.

Select whichever appropriate and press the ENTER/SCAN or ENTER button.

Speaker setup

4

PRESET/MODE ADJ
DOWN UP

CENTER =LARGE

or

CENTER =SMALL

or

CENTER =NONE

ENTER

or

ENTER/SCAN

5

PRESET/MODE ADJ
DOWN UP

SURROUND =LARGE

or

SURROUND =SMALL

or

SURROUND =NONE

ENTER

or

ENTER/SCAN

4. Select the size of the center speaker.

Pressing the PRESET/MODE ADJ ◀/▶ buttons switches among "LARGE," "SMALL," and "NONE."

Note:

If you have selected "SMALL" for the front speakers, you can select only "SMALL" or "NONE" for the center speaker.

LARGE: When a large speaker is used as the center speaker.

SMALL: When a small speaker is used as the center speaker.

NONE: A center speaker is not connected.

Select whichever appropriate and press the ENTER/SCAN or ENTER button.

5. Select the size of the surround speakers.

Note:

If you have selected "SMALL" for the front speaker, you can select only "SMALL" or "NONE" for the surround speakers.

LARGE: When large speakers are used as the surround speaker.

SMALL: When small speakers are used as the surround speaker.

NONE: Surround speakers are not connected.

Select whichever appropriate and press the ENTER/SCAN or ENTER button.

This completes the CONFIG SETUP settings.

1

SP/SYS SETUP

SPEAKER SETUP

ENTER

or

ENTER/SCAN

CONFIG SETUP

SP/SYS SETUP

DISTANCE SETUP

2

(ENTER) ENTER/SCAN

FRONT =3.6m / 12"

meter feet

PRESET/MODE ADJ
DOWN UP

FRONT =3.9m / 13"

ENTER

or

ENTER/SCAN

3

PRESET/MODE ADJ
DOWN UP

CENTER =3.6m / 12"

or

CENTER =3.9m / 13"

ENTER

or

ENTER/SCAN

4

PRESET/MODE ADJ
DOWN UP

SRND =2.1m / 7"

or

SRND =2.4m / 8"

ENTER

or

ENTER/SCAN

Setting the DISTANCE parameters

Set the distance from the listening position to each speaker.

1. Press the buttons in the following sequence to display "DISTANCE SETUP."

2. Set the distance to the front speakers.

Pressing the ENTER/SCAN or ENTER button while "DISTANCE SETUP" is displayed will cause the "FRONT" distance parameter to appear.

Press the PRESET/MODE ADJ ◀/▶ buttons to set the closest distance value. You can set the distance in the range of 1feet (0.3m) – 30feet (9m) in 1feet (0.3m) steps.

Press the ENTER/SCAN or ENTER button to confirm the value.

3. Set the distance to the center speaker.

Press the PRESET/MODE ADJ ◀/▶ buttons to set the closest distance value.

Press the ENTER/SCAN or ENTER button to confirm the value.

Note:

If you have selected "NONE" for the center speaker of the CONFIG parameter, skip this note.

You cannot set a larger value than the front speaker distance. You cannot set a smaller value than the front speaker distance deducted by 5feet (1.5m).

4. Set the distance to the surround speakers.

Press the PRESET/MODE ADJ ◀/▶ buttons to set the closest distance value and press the ENTER/SCAN or ENTER button.

Note:

If you have selected "NONE" for the surround speaker of the CONFIG parameter, skip this note.

You cannot set a larger value than the front speaker distance. You cannot set a smaller value than the front speaker distance deducted by 15feet (4.5m).

This completes the DISTANCE settings.

Speaker setup

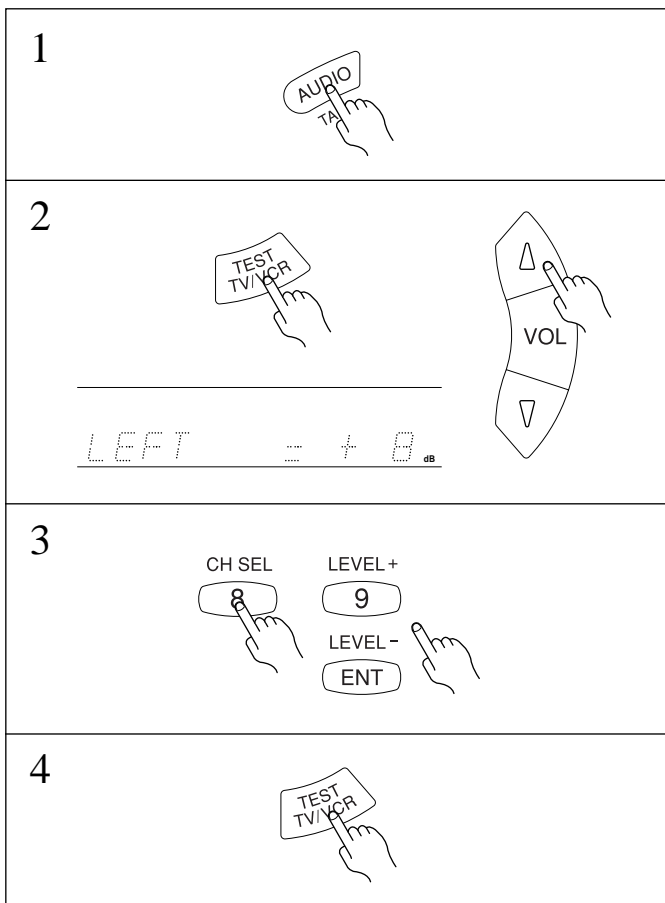
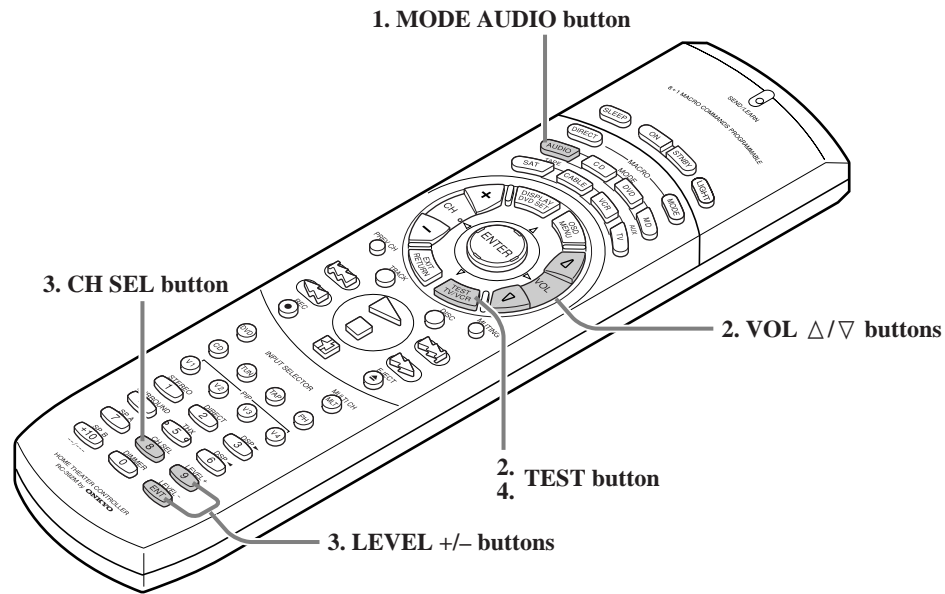

Test Tone

Use the remote controller and produce the test tone to adjust the level of the connected speakers.

1. Press the MODE AUDIO button.

2. Press the TEST button.

Press the VOL Δ button repeatedly to gradually raise the volume to an appropriate level.

Each speaker produces the test tone (pink noise) in the following order:

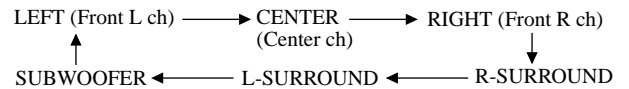

No sound will be output from the speakers for which the CONFIG parameters is set to NO or NONE.

3. To adjust the level of each speaker, press the CH SEL button to select a speaker and press the LEVEL +/- buttons to raise or lower the level.

The test tone should sound at the same level when you hear it in your listening position. You can adjust the level in the range between -12dB and +12dB.

If the speaker level is set to +1dB or higher, the maximum level indicated on the display will change if you raise the volume level. Refer to "About volume (VOLUME)" on page 20 for more information.

4. Press the TEST button to complete adjustment.

Note

- The Test Tone function is not available when SPEAKERS B is selected, when the headphones are connected, or when MULTI-CH INPUT is selected.

Using the Test Tone function on the main unit

- Press the SP/SYS SETUP button.
- Press the ENTER/SCAN or ENTER button while "SPEAKER SETUP" appears on the display.
- Press the SP/SYS SETUP button twice while "CONFIG SETUP" appears on the display.
- Press the ENTER/SCAN or ENTER button while "LEVEL SETUP" appears on the display.
Each speaker produces the test tone in the order described above.
- Use the PRESET MODE ADJ ◀/▶ buttons to adjust the level.
- Press the SP/SYS SETUP to complete adjustment.

Selecting a sound source

Follow the steps below to select a device to play the sound source.

- 2. Make sure that the SPEAKERS A indicator is lit on the display. If it is not lit, press the SPEAKERS A button.** (Refer to the "Speakers selector" section on the page 20 for more details.)

PTY/TP button (European models only) (Refer to page 27)

DIMMER button (other than European models)
Use this button to change the brightness of the display (normal or dim).

- 5. Adjust the volume to an appropriate level.**
These controls allow you to adjust the volume of the Front, Center, Surround speakers and subwoofer simultaneously. Turning the control clockwise increases the volume level. Turning the control counter-clockwise decreases the volume level. (Refer to page 20 for more details.)

- 4. LISTENING MODE**
Select a Listening mode. (Refer to page 21)

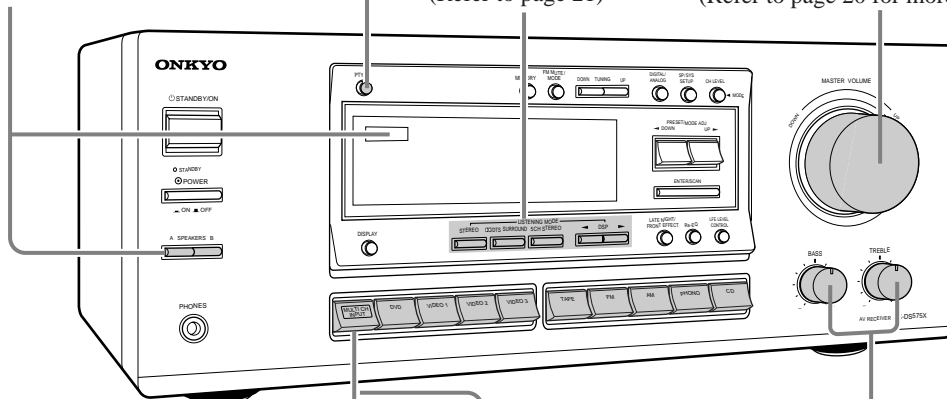

- 1. Press the desired input selector button or MULTI CH INPUT button.**
The selected source name appears on the display. If you have selected DVD, CD, VIDEO 1, VIDEO 2, VIDEO 3, or TAPE, see page 18. Refer to page 19 for more information on MULTI CH INPUT.

- 3. Start playing the selected input source.**
Follow the operating instructions for the source device.

- 6. Use the bass, treble controls to adjust the tone.** (Refer to page 20 for more details.)

- 1. Press the MODE AUDIO button**
- 5. VOLUME button (Δ up/∇ down)**
Use this button to adjust the volume level.
- 2. SP A button**
Use this button to select Speaker A.
- DIMMER button**
Use this button to change the brightness of the display (normal or dim).
- 3. INPUT SELECTOR button**
Use this button to select a desired sound source. (V4 button is not used for this TX-DS575X.)
- 4. Select a Listening mode.** (Refer to page 21)
- MUTING button**
This button mutes the sound temporarily. (Refer to page 20 for more details.)
- SLEEP button**
This button allows you to set the sleep timer. (Refer to page 20 for more details.)

Warning:

- Do not play CD-ROM discs that contain computer data as they may damage the speakers when the sound is amplified by the receiver.

Note:

If you hear no sound from the speakers, check the following items:

- Make sure that all devices and speakers are connected correctly and securely.
- The sound is muted when the "MUTING" is on the display. Press the MUTING button on the remote controller to cancel the mute function.
- When you select a source that is connected to the DIGITAL INPUT jacks on the rear panel. Check to see if the audio (digital or analog) selection is correct (when DVD, CD, VIDEO 1-3, or TAPE is selected) (refer to page 18.).
- If you have selected MULTI CH INPUT, you need to adjust the level of each speaker (refer to page 19).

Selecting a sound source

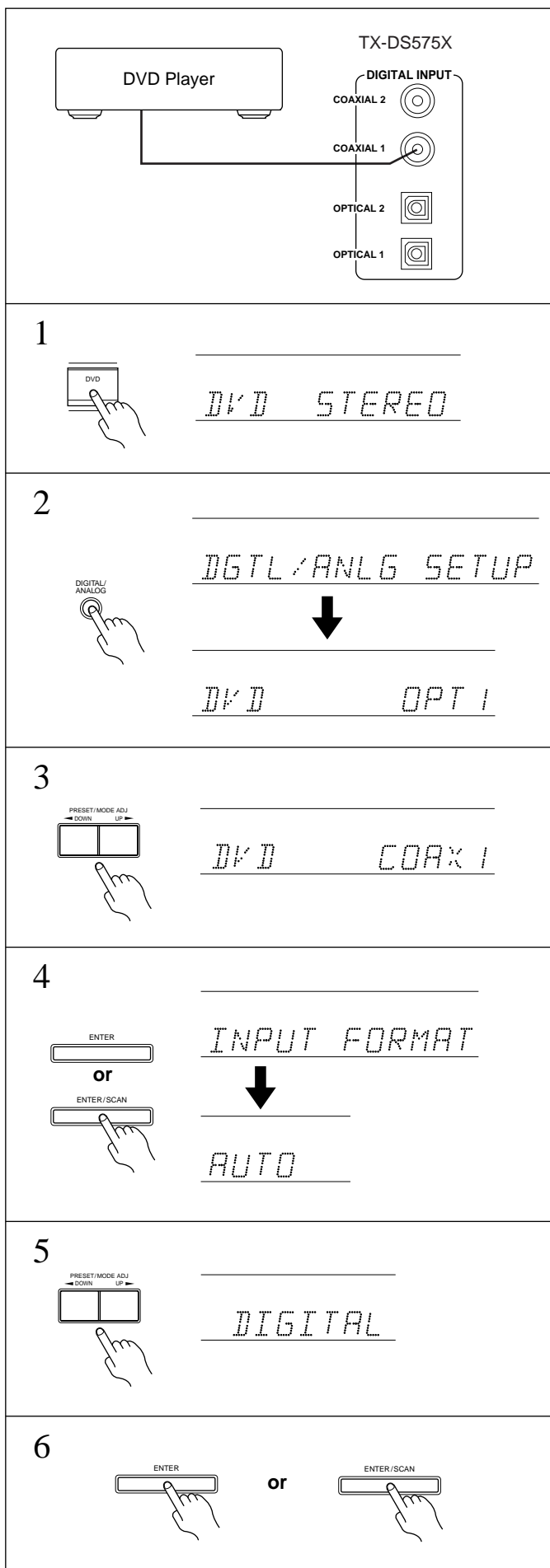

Assigning the digital input/Selecting the input signal format

Assigning the digital input

If another device is connected to the digital input jack of the TX-DS575X, assign the digital input to DVD, CD, VIDEO 1, VIDEO 2, VIDEO 3, or TAPE depending on the type of connected device. Follow the steps (1–4) below.

Note:

The default setting is "ANALOG." In this case, you cannot play any digital signals from the digital input jacks (Dolby digital, DTS, etc.).

OPT1 — The TX-DS575X plays back a digital signal input from the OPTICAL 1 jack.

OPT2 — The TX-DS575X plays back a digital signal input from the OPTICAL 2 jack.

COAX1 — The TX-DS575X plays back a digital signal input from the COAX 1 jack.

COAX2 — The TX-DS575X plays back a digital signal input from the COAX 2 jack.

ANALOG — The TX-DS575X plays back an analog signal input from the ANALOG input jack. (Digital signals input from the digital input jacks will not be played.)

Selecting the input signal format

Normally, select AUTO for this parameter. You can also select DIGITAL or ANALOG depending on the source. Follow the steps (4–6) below to change the setting.

AUTO (digital signal/analog signal playback mode)

Digital signals have priority for playback. If no digital signals are input, the TX-DS575X plays back analog signals.

When the TX-DS575X plays back digital signals, it automatically detects the signal format (Dolby Digital, DTS, or PCM) and performs the necessary decoding process.

DIGITAL (digital signal playback mode)

The TX-DS575X plays back digital signals. (Input analog signals will be ignored.)

The TX-DS575X automatically detects the signal format (Dolby Digital, DTS, or PCM) and performs the necessary decoding process.

ANALOG (analog signal playback mode)

The TX-DS575X plays back analog signals. (Input digital signals will be ignored.)

Assume that you have connected a DVD player to the COAXIAL 1 connector.

1. Use the **INPUT** button to select "DVD."
2. Press the **DIGITAL/ANALOG** button to set digital input. "DGTL/ANLG SETUP" appears, followed by the current setting ("DVD =" OPT1, OPT2, COAX1, COAX2, or ANALOG).
3. Press "**PRESET/MODE ADJ** ◀/▶" to select COAX1.
4. Press the **ENTER/SCAN** or **ENTER** button. The unit displays "INPUT FORMAT" in a few seconds, followed by the current setting (AUTO, DIGITAL, or ANALOG).
5. Press "**PRESET/MODE ADJ** ◀/▶" to select AUTO, DIGITAL or ANALOG.
6. Press the **ENTER/SCAN** or **ENTER** button.

Tip:

You may play analog audio while digital input is selected if you select "ANALOG" in Step 5.

Note:

- You cannot select "INPUT FORMAT" as described in Step 4 if you select "ANALOG" in Step 3.
- You can assign digital input to DVD, VIDEO 1, VIDEO 2, VIDEO 3, TAPE, and CD.

Selecting a sound source

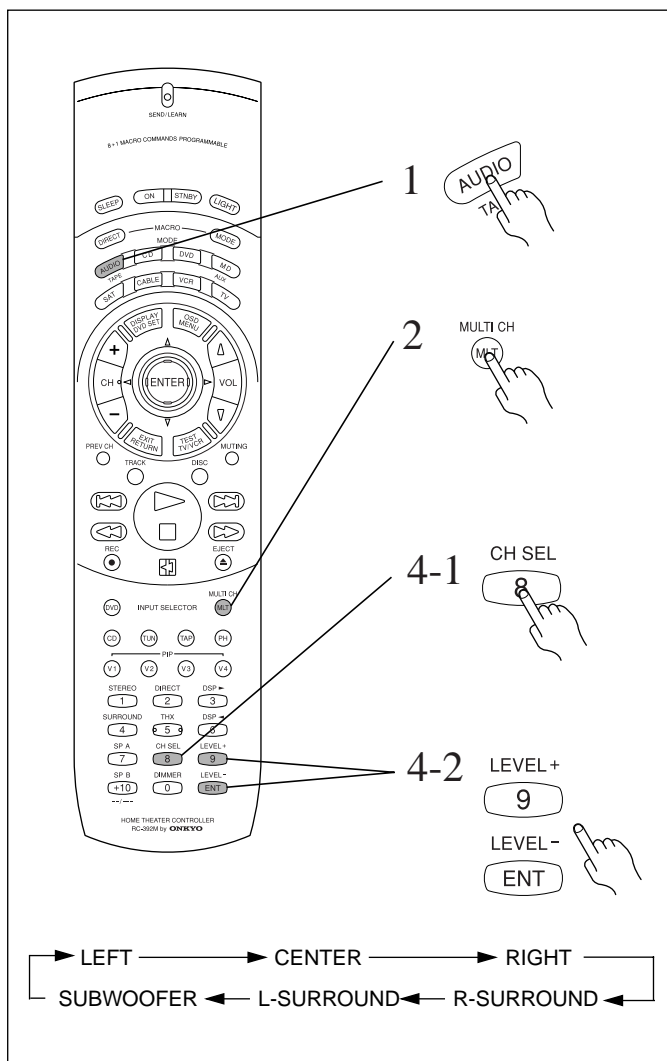

When Multi channel input is selected as a source

Follow the steps below to adjust the level of each speaker if you have selected MULTI CH INPUT.

1. Press **MODE AUDIO** button on the remote controller.
2. Press **MULTI CH** button on the remote controller.
You cannot select any listening mode.
3. Play the device connected to the **MULTI CHANNEL INPUT** jack.
4. Adjust the volume level of each speaker.

4-1. Press the CH SEL button to select the desired speakers.

4-2. Use the LEVEL +/- button to change the volume level of the speakers.

You can adjust the volume level of each speaker individually. Adjust the level while listening to the sound in the listening position.

You can adjust the level of the front, center, and surround speakers in the range between -12dB and $+12\text{dB}$.

You can adjust the subwoofer level in the range between -30dB and $+12\text{dB}$.

Note

- Adjusting the volume level of each speaker for the MULTI CH INPUT source does not affect the speaker level adjusted by the Test Tone function, and vice versa.
- If the speaker level is set to $+1\text{dB}$ or higher, the maximum level indicated on the display will change if you raise the volume level. Refer to "About volume (VOLUME)" on page 20 for more information.

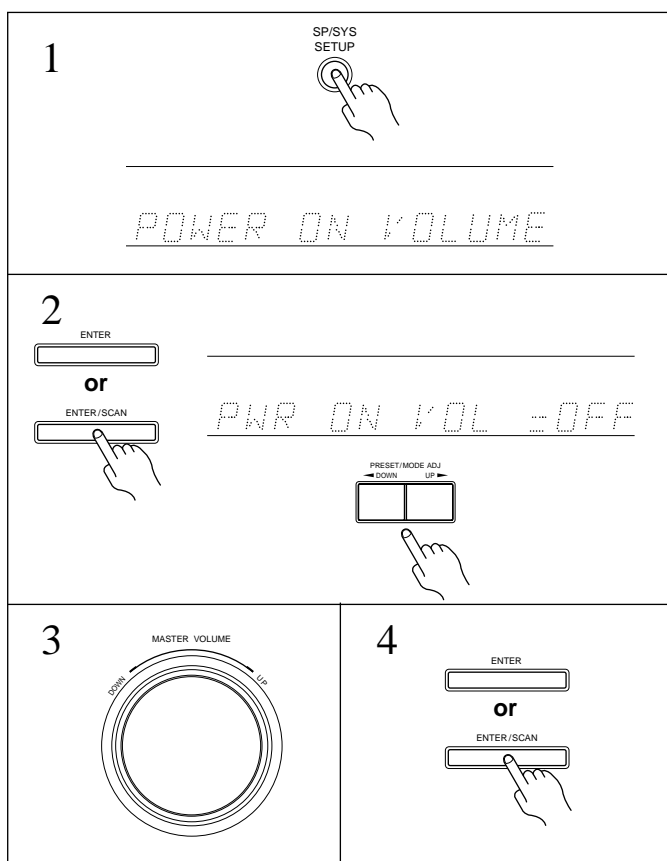

Using the Power On Volume function

This function automatically selects the volume level you set last time.

Follow the steps below:

How to set the Power On Volume function:

1. Press the **SP/SYS SETUP** button repeatedly to select "POWER ON VOLUME."
2. Press the **ENTER/SCAN** or **ENTER** button.
The unit displays "PWR ON VOL=OFF" or the current volume level.
If "PWR ON VOL=OFF" appears, press the **PRESET/MODE ADJ** button to display the current level (PWR ON VOL=XX).
3. Use the **MASTER VOLUME** control to set the desired level.
4. Press the **ENTER/SCAN** or **ENTER** button to complete the setting.

Note:

If the PWR ON VOL parameter is set to OFF, the Power On Volume function is disabled. In this case, when you turn on the power to the unit next time, it will use the volume level that was set when you turned off the power.

Selecting a sound source

Speakers selector (SPEAKERS A, B)

SPEAKERS A: This button turns on or off the speakers connected to the FRONT SPEAKERS A, CENTER SPEAKER, SURROUND SPEAKERS and SUBWOOFER terminals.

When you listen to surround audio or select Multi CH INPUT, be sure to turn on SPEAKERS A.

When the speakers are turned on, the SPEAKERS A indicator lights up.

SPEAKERS B: This button turns on or off the speakers connected to the FRONT SPEAKERS B terminals.

When the speakers are turned on, the SPEAKERS B indicator lights up.

Note:

You cannot select Surround sound when you are using SPEAKERS B. If you select SPEAKERS B while Surround sound is selected, Surround mode will be automatically canceled.

Adjusting the tone (BASS, TREBLE)

Treble and bass adjustment is effective only for the Front speakers and headphones.

BASS: Boosts or cuts the bass response.

TREBLE: Boosts or cuts the treble response.

Listening through headphones (PHONES)

You can connect stereo headphones to the PHONES jack using a standard stereo plug.

If you connect headphones, the unit will enter STEREO mode automatically, and no sound will be produced from the speakers. If you have selected MULTI CH INPUT, you will hear sound only from the FRONT L and R channels.

About volume (VOLUME)

You have the option of displaying your volume settings either of two ways:

- **ABSOLUTE** — on a scale of MIN (0: no sound) to MAX (80: extremely sound);

or

- **RELATIVE** — on a scale which is measured “plus or minus,” relative to the calibrated reference volume.

With either settings, the volume level changes in the same increment.

ABSOLUTE: MIN, 1, 2, 3, 4,, 77, 78, 79, MAX

RELATIVE: $-\infty$, -61, -60, -59,, +16, +17, +18 (dB)

1. Press the **SP/SYS SETUP** button twice.
“VOLUME DISPLAY” appears.
2. Press the **ENTER/SCAN** or **ENTER** button.
“VOLUME=ABSOLUTE or RELATIVE” appears.
3. Press “**PRESET/MODE ADJ** ◀/▶” to select the desired display.
4. Press the **ENTER/SCAN** or **ENTER** button.
 - If the speaker level is set to +1dB or higher, the maximum level indicated on the display will change if you raise the volume level. Refer to the following sections for more information on adjusting the speaker level:
 - “Test Tone (Remote controller only)” on page 16.
 - “When Multi channel input is selected as a source” on page 19.

Sleep function (Remote controller only)

The sleep timer can turn off the power to the system after a specified time period.

To set up this function, use the remote controller supplied with this receiver.

1. Start playing the source you would like to listen to (CD, tape, or radio broadcast).
2. Press the **MODE AUDIO** button.
3. Press the **SLEEP** button repeatedly to set the duration of time after which you want the system to turn off.

The longest timer value you can set is 90 minutes. Pressing the SLEEP button each time reduces the time value in 10-minute increments.

When the specified time comes, the power will be switched off automatically.

Disabling the Sleep function

Press the SLEEP button until it returns to the selected input source name.

or

The timer setting will be cancelled if you turn off the power to the unit.

Temporary muting (MUTING) (Remote controller only)

Press the **MUTING** button.

The “MUTING” appears on the display and the sound from the speakers or headphones will be switched off by the receiver’s audio muting circuits.

To cancel,

- press the **MUTING** button again, *or*
- set the unit to stand-by mode, then turn the power on.

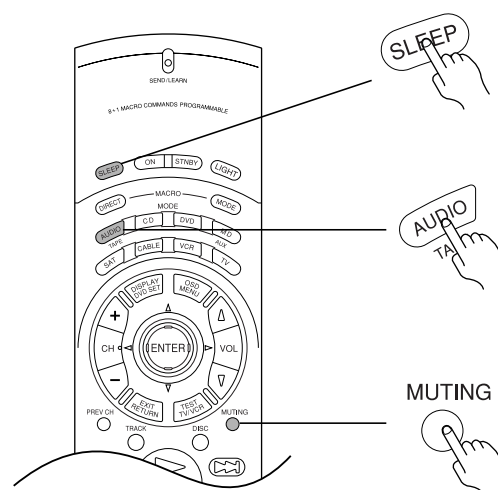

Using Listening Mode

Before Using Listening Mode

Listening Modes

The TX-DS575X's surround sound enables you to enjoy the presence of a movie theater or concert hall in your room.

Before using a listening mode, make sure the Speaker Setup parameters have been set (refer to page 14). Once the parameters have been set, it is not necessary to set them again.

The configuration of the speakers are very important for the surround sound. Refer to "connecting speakers" on page 10.

DOLBY DIGITAL Surround, DTS (Digital Theater System) Surround

This 5.1-channel digital surround format enables you to individually record and play five full-range (20Hz–20kHz) channels (left and right front, center, two surround channels) plus an LFE channel (Low Frequency Effect) for the low-range effect sound. It will create a realistic sound that could be heard in the theaters and concert halls.

DOLBY DIGITAL: Select this option when you play a DVD video that has a  mark.

DTS: Select this option when you play a DVD player, laser disc, or CD that has a  mark.

DOLBY PRO LOGIC

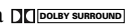
This surround format consists of four channels (left and right front, center, and monaural surround channels) and emphasizes the center channel. This format is very effective for panning music, conversation, and three-dimensional sound movement output from three front channels. It also simulates the atmosphere and surround effects of the sound reflected from the side and rear walls of the theater. Select this option when you play a VHS, VHS Hi-Fi, laser disc, or DVD video that has a  mark.

Onkyo's listening modes

The TX-DS575X offers the following special Onkyo listening modes for the sources other than Dolby Digital and DTS sounds.

ORCHESTRA: This mode is suitable for classics and opera music. The center channel is cut and the surround channels are emphasized to widen the stereo image. It will simulate a natural reverberation that can be created in a large hall.

UNPLUGGED: This mode is suitable for acoustic instrumental sounds, vocals, and jazz music. By emphasizing the front stereo image, it will simulate the acoustics in front of the stage.

STUDIO-MIX: This mode is suitable for rock and popular music. Lively sounds with a powerful acoustic image will make you feel as if you are in a club.

TV LOGIC: This mode offers a realistic acoustics of a TV program being aired in the TV studio. It enhances the entire surround sound and clarity of conversation.

5CH STEREO: This mode is useful for background music. The front and surround channels will create a stereo image.

STEREO

Select this mode when you do not wish to use the surround mode. All input sound is output from the front speakers.

• A system with L/R front and center speakers

The following modes are available:

DOLBY 3 STEREO

The surround channel sound is output from the left and right front speakers.

STEREO

This is a normal stereo mode. Surround mode is cancelled.

• A system with L/R front speakers

The following mode is available:

STEREO

This is a normal stereo mode.

Notes on DTS

1. If you play a CD or LD that supports DTS when the "ANALOG" setting is selected on the TX-DS575X, the DTS encoded signal will not be decoded and noise will be output. This noise could damage the amplifier and speakers. Therefore, be sure to select "DIGITAL" and use the digital input jacks (OPTICAL/COAXIAL) to connect the DTS source. (Refer to "Assigning the digital input/Selecting the input signal format" on page 18.)
2. If you play a CD or LD that supports DTS when the "DIGITAL" setting is selected, you may hear a noise for a short while until the DTS decoder recognizes the DTS encoded signal and starts operating. This is not a malfunction.
3. If you press the PAUSE or SKIP button on the player while playing a DTS source, a short noise may be heard. This is not a malfunction.
4. The DTS indicator on the TX-DS575X lights up while it plays the DTS source. When playback concludes and the DTS signal transmission stops, the TX-DS575X remains in DTS mode and the DTS indicator remains lit. This prevents noise when you operate the PAUSE or SKIP button on the player. Therefore, if the source switches from the DTS signal to the PCM signal immediately, the PCM signal may not be played. In this case, stop the playback of the source on the player for about three seconds, then resume playback.
5. Some CD players and LD players may be unable to play DTS sources correctly even if you connect the player to the TX-DS575X digitally. This is because the digital signal has been processed (such as the output level, sampling frequency, frequency response, etc.), and the TX-DS575X cannot recognize the signal as DTS data. Therefore, you may hear noise when you play a DTS source while processing the signal.
6. The Rec Out jacks of the TX-DS575X output analog audio. Do not record CDs or LDs that support DTS using these jacks. Otherwise, you will record a DTS encoded signal as noise.

Using Listening Mode

3. Use these buttons to set the Listening mode parameters. (Refer to page 23).

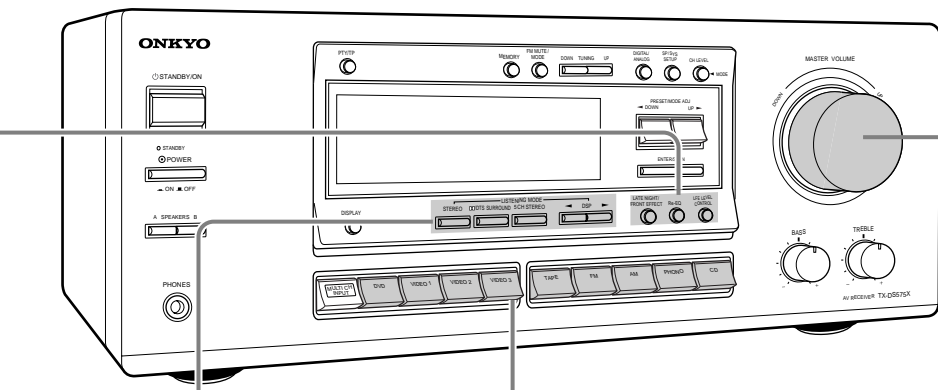

2. LISTENING MODE buttons
These buttons allow you to select a listening mode.

1. Input selector buttons
Select the desired input source.

VOLUME knob
Use this knob to adjust the volume level.

VOL button (Δ up/▽ down)
Use this button to adjust the volume level.

CH SEL/LEVEL +/- buttons

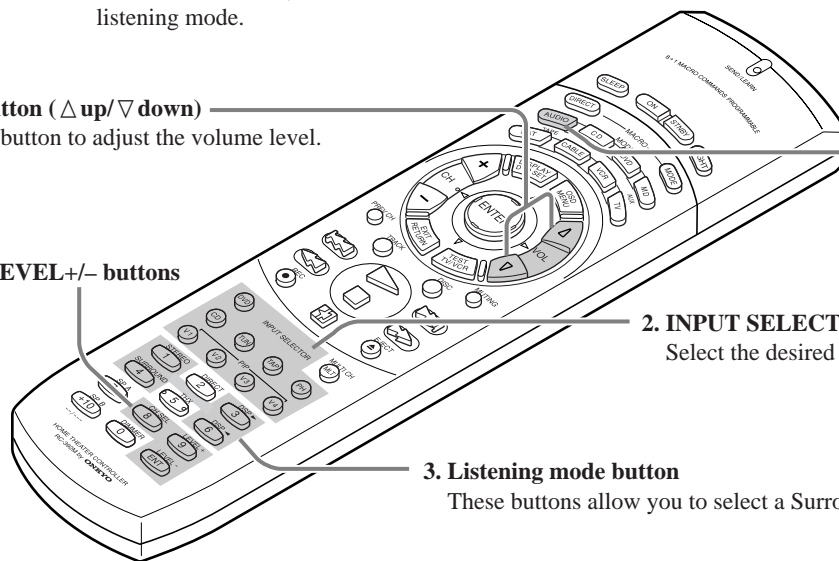

1. Press the MODE AUDIO button

2. INPUT SELECTOR buttons
Select the desired input source.

3. Listening mode button
These buttons allow you to select a Surround mode.

1

2

STEREO ↔ PRO LOGIC (Dolby Pro Logic) ↔ ORCHESTRA

5ch STEREO ↔ TV LOGIC ↔ STUDIO-MIX ↔ UNPLUGGED

Playing the DOLBY DIGITAL source
Dolby Digital ↔ Dolby Digital (stereo)

Playing the DTS source
DTS ↔ DTS (stereo)

Using Listening Mode

1. Press one of the **INPUT SELECTOR** buttons to select the desired sound source.
2. Use the **LISTENING MODE** buttons to select the desired Listening mode.
STEREO: Press this button to listen to a normal stereo audio.
DOTS/DTS SURROUND: Press this button when you wish to play Dolby ProLogic, Dolby Digital, or DTS Surround sound.
5CH STEREO: Press this button to play 5-ch stereo sound (see page 21).
DSP ◀▶: Press this button repeatedly to select the desired Listening mode. Each option appears as shown at left.
3. Play the selected source.

Notes:

- Select a digital input to play Dolby digital or DTS sound sources. (See page 18.)
- You cannot select Orchestra, Unplugged, Studio-Mix, TV Logic, or 5ch Stereo if you have selected a Dolby digital or DTS surround source.
- To play a Dolby digital or DTS Surround source, you need to connect the sound source using the digital input connector.
- When you play the Dolby Digital or DTS Surround source, the TX-DS575X automatically enters Dolby Digital Surround (stereo) or DTS Surround (stereo) mode respectively.

Follow the steps below to make adjustment to the speaker level set by the Test Tone.

1. Press the **MODE AUDIO** button.
2. Press the **CH SEL** button to select a speaker.
3. Press the **LEVEL +/-** buttons to adjust the level.

Using Listening Mode

Main unit operation:

1. Press the CH LEVEL button.
2. Press the PRESET/MODE ADJ ◀/▶ buttons to adjust the level.
3. Press the ENTER/SCAN or ENTER button to select a speaker.

- You can adjust the level in the range of -12dB to +12dB.
- You cannot select a speaker if the CONFIG parameter of the speaker is set to NO or NONE.
- If the speaker level is set to +1dB or higher, the maximum level indicated on the display will change if you raise the volume level. Refer to "About volume (VOLUME)" on page 20 for more information.
- When you turn off the power, the level will be reset to the original level (the value you set using the test tone).
- When you press the TEST button after you set the level, the current level will be used as the value set via the test tone.

Setting the Listening mode parameters

The following parameters are available for each Listening mode.

	Dolby Digital	DTS Surround	Dolby Pro Logic	Orchestra, Unplugged, Studio-Mix, TV Logic
LATE NIGHT	○	—	—	—
FRONT EFFECT	—	—	—	○
Re-EQ	○	○	○	—
LFE level control	○	○	—	—

LATE NIGHT

If you play a movie at a low volume at night, set this parameter to "ON" to narrow the dynamic range of the sound to make it easier to hear.

The Late Night function works only with source material that contains necessary Dolby Digital information.

Note:

- The Late Night effect is determined by each Dolby Digital sound. Some sounds may produce no or little effect.
- The Late Night function is effective only on the Dolby Digital sound.

While the Dolby Digital sound is playing, press the LATE NIGHT/FRONT EFFECT button. The current setting appears on the display. (LATE NIGHT=ON or OFF)

Pressing the LATE NIGHT/FRONT EFFECT button repeatedly will toggle between ON and OFF.

FRONT EFFECT

Some live recordings contain acoustic reverberation. When you play these sources, more reverberation will be applied by the DSP, creating too much reverb effects and the sound loses its frame or presence. In this case, set FRONT EFFECT to OFF. No reverberation from the DSP will be applied to the sound output from three front channels, and the sound source will be played as it is without any further reverberation.

Note:

The Front Effect function is effective only on the ORCHESTRA, UNPLUGGED, STUDIO-MIX, and TV LOGIC sound.

While ORCHESTRA, UNPLUGGED, STUDIO-MIX, or TV LOGIC is selected for Listening mode, press the LATE NIGHT/FRONT EFFECT button. The current setting appears on the display. (FRONT EFFECT=ON or OFF)

Pressing the LATE NIGHT/FRONT EFFECT button repeatedly will toggle between ON and OFF.

Re-EQ

Cinema Re-Equalization

Re-Equalization takes the edginess or "brightness" out of your home cinema sound, compensating for the fact that sound mixed for theaters will sound too bright when played back through speakers in the home environment.

To enable Re-Equalization, set the Re-EQ to ON.

While the Dolby ProLogic Surround, Dolby Digital Surround, or DTS Surround sound is playing, press the Re-EQ button. The current setting appears on the display. (RE-EQ=ON or OFF)

Pressing the Re-EQ button repeatedly will toggle between ON and OFF.

Note:

The Re-EQ function is effective on the Dolby ProLogic Surround, Dolby Digital Surround, and DTS Surround sound.

LFE (Low Frequency Effect) Level Control

This control function enables you to adjust the level of LFE in the Dolby Digital/DTS Surround sound.

Notes:

- The LFE Level Control function is effective only on the Dolby Digital/DTS Surround sound.
- The LFE function may not be effective on some Dolby Digital or DTS Surround sources.

Dolby Digital sound:

Press the LFE LEVEL CONTROL button repeatedly to select 0dB, -10dB, or -∞dB. "0dB" is recommended. If the low range sounds too loud for your taste, select -10dB or -∞dB.

DTS sound:

Press the LFE LEVEL CONTROL button repeatedly to select +10dB, 0dB, or -∞dB. "+10dB" is recommended for cinema sound sources. If the low range sounds too loud for your taste, select 0dB or -∞dB. "0dB" is recommended for music sound source. If the low range sounds too loud for your taste, select -∞dB.

Tuning in a radio station

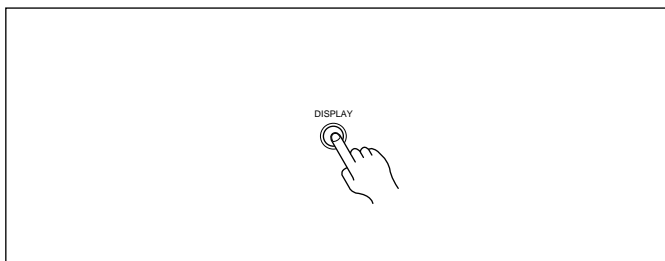
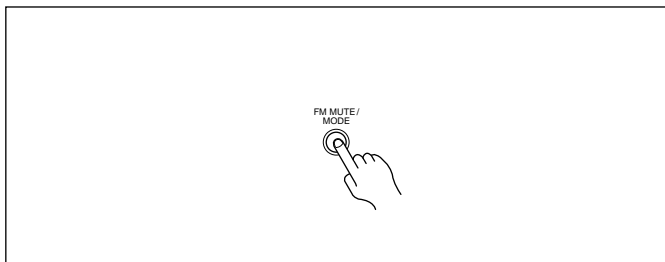
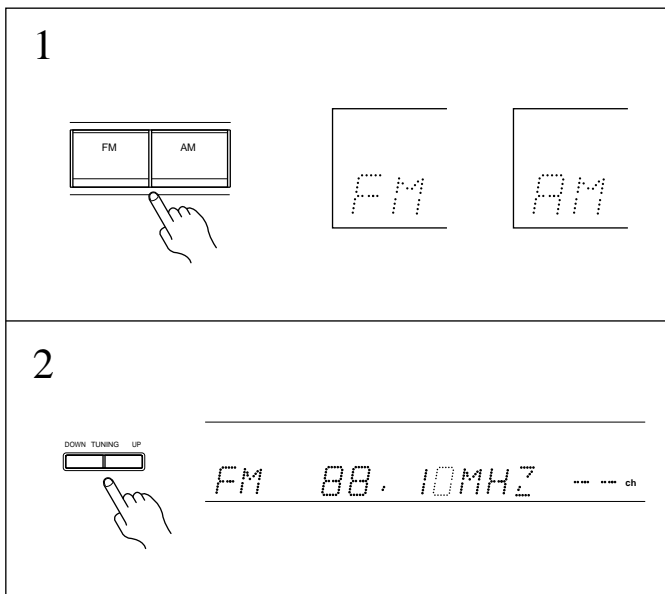
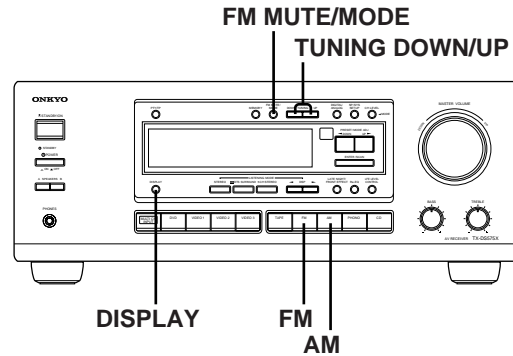

Manual tuning

1. Press the FM or AM button.
 2. Use the TUNING UP/DOWN buttons to change the frequency.
 UP the frequency increases.
 DOWN the frequency decreases.
- The frequency changes in 50 kHz steps in FM and 10 kHz (or 9 kHz) in AM each time you press the TUNING UP/DOWN button.
 - In FM, if this button is held continuously for more than 0.5 seconds, the frequencies are scanned automatically (FM auto tuning mode). When a broadcast is received, scanning stops.

Listening to a stereo radio station (FM mode)

When you tune in a stereo FM station, the FM STEREO indicator lights up if the signal is sufficiently strong. If the signal is weak, it may be impossible to tune in to the desired station. In this case, tune in as follows. Press the FM MUTE/MODE button. The FM MUTE indicator turns off. At this time, the station will be in mono and interstation noise will be heard. Select the station to which you want to listen.

DISPLAY button

Pressing the DISPLAY button each time will change the indication as follows:
 Frequency (preset No.) ↔ Listening mode

Using preset radio stations

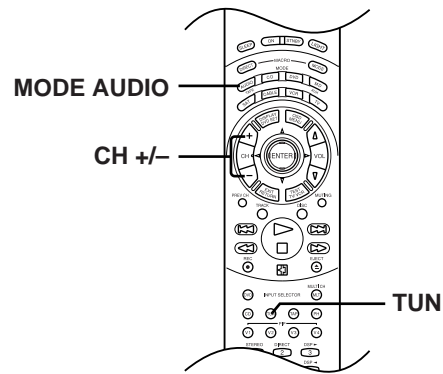
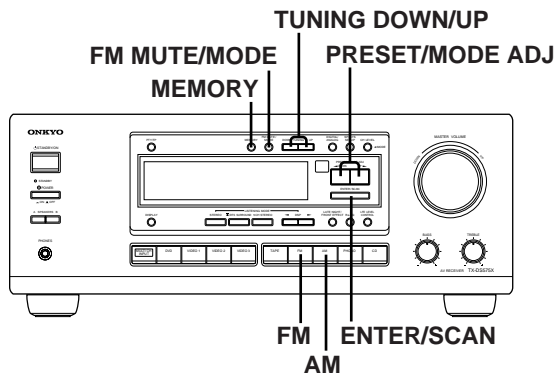

2

3

4

5

Programming radio stations

1. Select the frequency that you want to store in the memory. (See Tuning in a radio station on page 24.)
 2. Press the **MEMORY** button. "PRESET IN" appears.
 3. Press the **ENTER/SCAN** or **ENTER** button while the **PRESET IN** indicator is illuminated. The "MEMORY" indicator lights up on the display.
 4. Select the desired memory number using **PRESET/MODE ADJ** ◀/▶ button.
 5. Press the **ENTER/SCAN (ENTER)** or **MEMORY** button. The received station will be stored in the specified preset number.
- A total of 30 stations can be stored in the memory.

Using preset radio stations

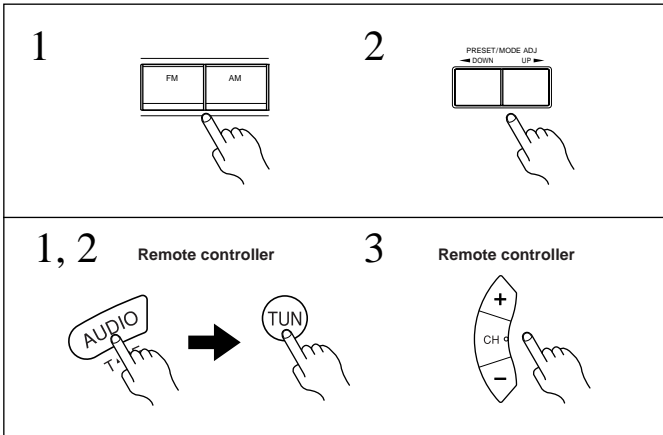

Selecting a preset station

1. Select the tuner as the source by pressing the AM or FM input selector button on the main unit.
2. Enter the desired preset number using the PRESET/MODE ADJ ◀/▶ button.

Remote controller operation

1. Press the MODE AUDIO button.
2. Select the tuner as the source by pressing the TUN input selector button on the remote controller.
3. Press the CH (- or +) button.

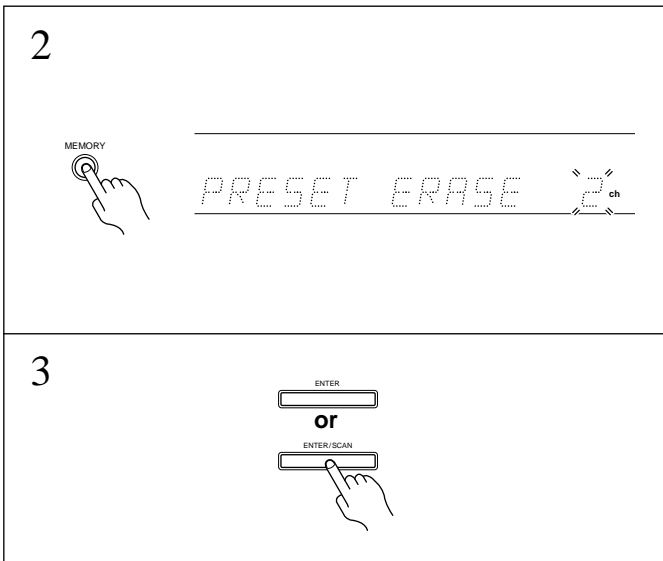

Cancelling preset stations

1. Select the preset station you wish to remove as explained in the previous section.
 2. Press the MEMORY button twice.
“PRESET ERASE” appears on the display.
 3. While “PRESET ERASE” is displayed, press the ENTER/SCAN or ENTER button.
- Once the preset station has been cancelled, the memory location can be used to store another station.

Receiving RDS broadcasts (European models only)

RDS reception is available only on the European model, and only in areas where RDS broadcasts are available.

What is RDS?

Many FM broadcasting stations now transmit RDS signals, which provide additional information. RDS provides you with various services so that, for example, you can choose a station broadcasting your favorite categories of music or other information. (Refer to the right column for details.)

PS: Program Service Name

When an RDS station broadcasting PS information is selected, the station's name is displayed instead of the frequency.

PTY: Program Type

When an RDS station broadcasting PTY information is selected, the station type (classification) is displayed.

TP: Traffic Program

When an RDS station broadcasting TP information is selected, the traffic information is displayed.

RT: Radio Text

When an RDS station broadcasting RT information is selected, the information received from the station is displayed.

NOTE:

In some cases, the characters displayed on the TX-DS575X's display may not be exactly the same as the ones broadcast by the radio station. Unusual characters may appear on the display if the TX-DS575X receives characters that cannot be displayed correctly. This is not a malfunction.

PTY Classifications in Europe

None	No program type.
News reports	Reports on current events and happenings.
Current affairs Information	Topical reporting of current affairs, often with a wider range of topics than news reports. General information such as whether forecasts, consumer affairs, medical help, etc.
Sport	Live sports action, sports news, and interviews.
Education	Formal educational programs.
Drama	Radio plays and serials.
Culture	Cultural programs (including religious affairs).
Science and technology	Programs about the natural sciences and technology.
Varied	Speech-based programs not covered by the above categories (e.g., quizzes, panel games, comedy, etc.).
Pop music	Popular commercial music, usually from past or present sales charts (e.g., Top 40).
Rock music	Popular music with an alternative appeal, often not appearing on sales charts.
Middle of the road music	Easy listening music (as opposed to Pop, Rock or Classical).
Light classics	Classical music for general rather than specialist appreciation.
Serious classics	Performances of major orchestral works, symphonies, chamber music etc., including Grand Opera.
Other music	Music styles not covered by the above categories, e.g. Jazz, Rhythm & Blues, Folk, Country, Reggae.
Alarm	When an RDS station is making an emergency broadcast, this ALARM will flash on the display.

Receiving RDS broadcasts (European models only)

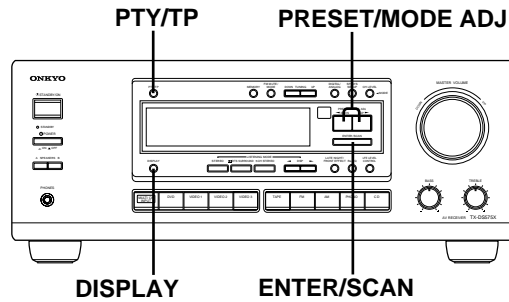

1		FM
2		PTY-SCAN
3		ROCK M
4~6		

Searching for a station of your favorite program type (PTY scan)

1. Select FM as the input.
2. Press the PTY/TP button repeatedly until "Not RDS" or the program type appears on the display.
3. Press the PRESET/MODE ADJ ◀/▶ button to select the program type (PTY), for example "ROCK M". Refer to the explanation of PTY on the previous page.
4. Press the ENTER/SCAN button to start searching for stations of the desired program type.
If you press the ENTER/SCAN button without selecting any program type, "Type?" will appear on the display. Return to Step 2.
When a station of the desired program type is tuned in, scanning stops for approximately three seconds, then resumes.
5. When the desired station is located, press the ENTER/SCAN button again to stop scanning.
6. Press the ENTER/SCAN button.

1		TP-SCAN
2		

Searching for traffic information (TP scan)

1. Press the PTY/TP button twice to select "TP-SCAN."
2. Press the ENTER/SCAN button to start searching for other TP stations.
When a station broadcasting traffic information is located, scanning stops. If "Not find" appears on the display, a TP station cannot be located.

1		<p>Frequency (preset No.)</p> <p>↓</p> <p>Program Service Name (Preset No.)</p> <p>↓</p> <p>Listening mode</p> <p>↓</p> <p>Radio Text</p> <p>↓</p> <p>Program Type</p>
<p>When an AM station is selected:</p> <p style="text-align: center;">Frequency (preset No.) ← → Listening mode</p>		

Displaying Radio Text (RT)

If the selected station is not broadcasting RT signals, this function cannot be used.

1. Each time you press the DISPLAY button, the displayed RDS information changes as shown at left.
 - If the current station you are listening to is not an RDS station, only the frequency appear.
 - When RT signals are received, it takes about 15 seconds for the Radio Text to appear on the display.
 - If "Wait" appears on the display, more time is required to receive the RT information. When the information is received, the characters will scroll across the display.
 - If "No text" appears on the display for 3 seconds, RT information is not available.

Recording a source

- You can record analog Audio, but not digital audio. Make sure that you have made a correct analog connection.
- You cannot record the source connected to MULTI CHANNEL INPUT jack.
- If you select another device as the input source during recording, the input signal from that device will be recorded.
- You cannot record audio source along with the surround effects.

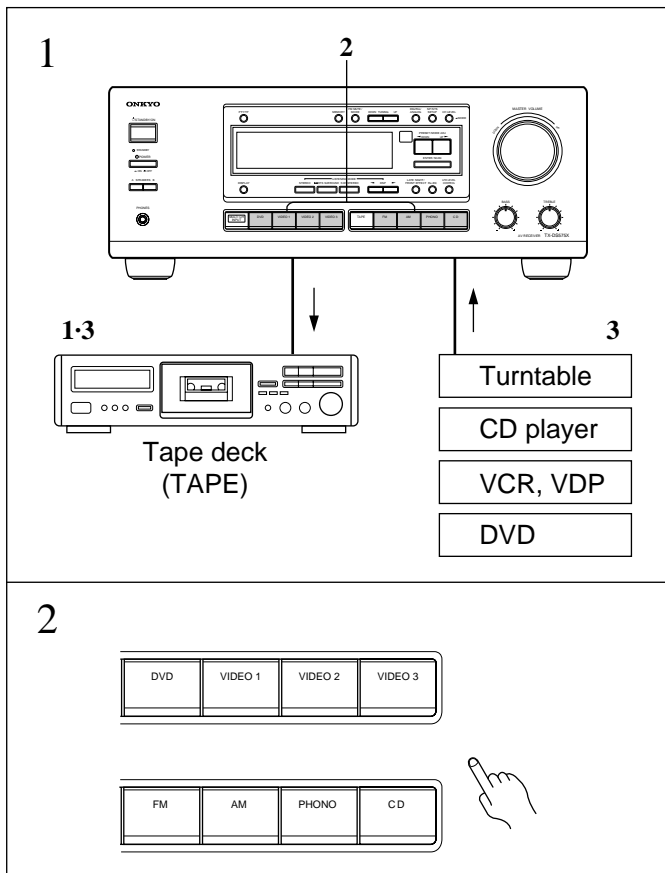

Recording an audio source

Make all connections between the tape deck and the receiver as shown in the "Audio equipment connections" diagram (page 6).

1. **Insert a blank tape into the tape deck.**
2. **Press the input selector button for the source you want to record.**
 - If you select DVD, VIDEO 1, VIDEO 2 or VIDEO 3, only the audio will be recorded.
 - If you select FM or AM, set the tuner to the station you want to record.
3. **Set the tape deck in recording mode. Start playing the source.**

Set the proper recording level using the controls on the tape deck.

 - Please read the corresponding instruction manuals for more information on how to operate the corresponding equipment.

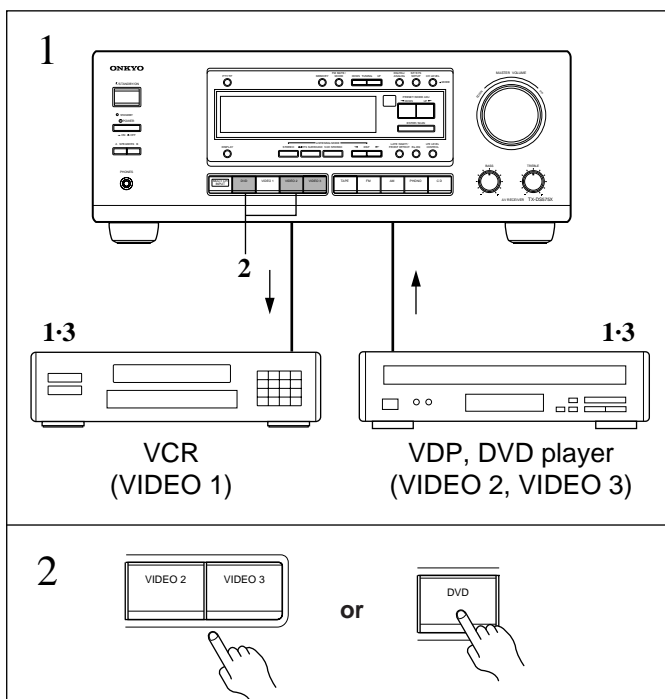

Recording data from a video disc player (or a video camcorder) to VCR

Video disc programs can be recorded onto a VCR (VIDEO 1).

1. **Load a disc in the video disc player or DVD player, and insert a blank tape in the VCR (VIDEO 1).**
2. **Press the VIDEO 2, VIDEO 3 or DVD button.**
3. **Start playing the video disc player and recording on the VCR.**
 - Refer to the Video equipment connections section on the page 7.

Recording a source

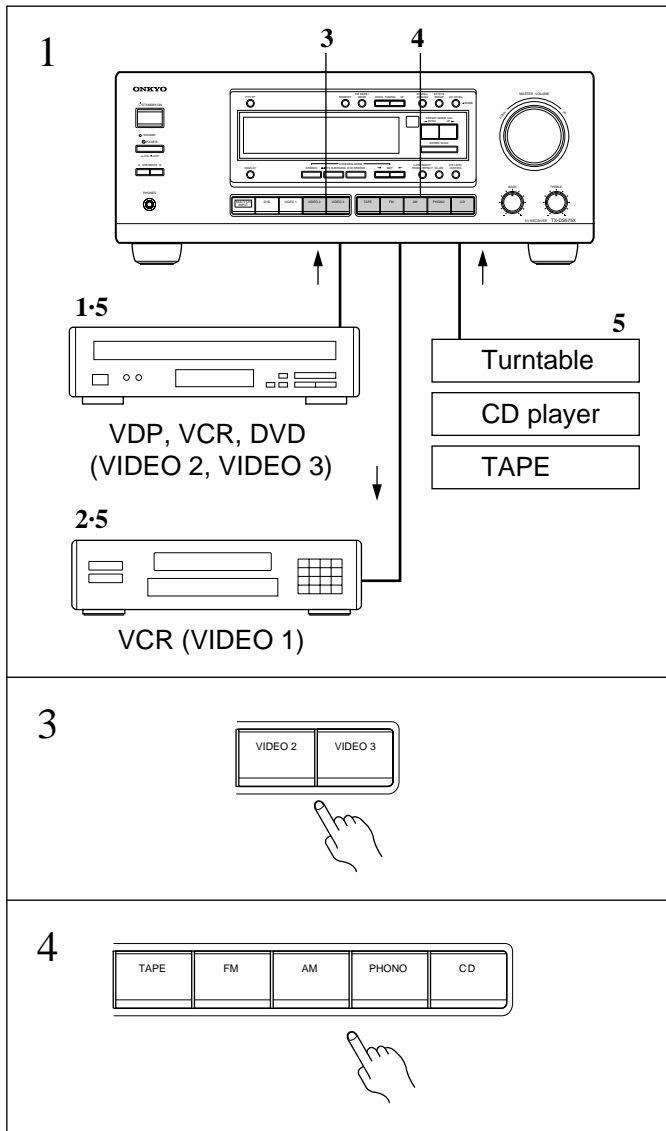

Adding new sound to a video tape during video editing

During video tape editing, you can add sound to the recording VCR from various audio program sources.

1. Insert the disc or tape that you want to record into the player connected to VIDEO 2 or VIDEO 3.
 2. Insert a blank video tape in the VCR connected to VIDEO 1.
 3. Press the VIDEO 2 or 3 button.
 4. Select the audio program source (TAPE, FM, AM, PHONO, CD).
 5. Start playing the video connected to the VIDEO 2 or VIDEO 3 terminal and start playing the sound source. Then, start recording on the VCR that is connected to the VIDEO 1 terminal.
- Refer to the video disc player, video camcorder, DVD or VCR instruction manuals for additional information.

Using the remote controller

Overview

When you use a remote controller, typically you press one of the MODE buttons that corresponds to the device you wish to control, then press the operation buttons. For example, if you wish to control the TX-DS575X from a remote controller, first press the MODE AUDIO button, then press an appropriate operation button. To control a CD player, press the MODE CD button, then press an appropriate operation button.

First, press the desired MODE button to make sure that the TX-DS575X is set to a correct mode.

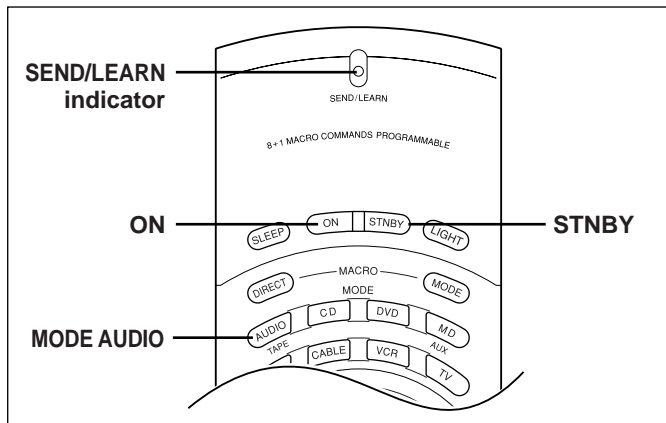

Using the RC-392M to control each device

Turning the power on and off to the TX-DS575X

Note:

Before operating the RC-392M, turn on the POWER switch on the TX-DS575X so that the unit enters standby mode.

1. Press the **MODE AUDIO** button.
2. Pressing the **ON** button will power on.
Pressing the **STNBY** button will power standby.

SEND/LEARN indicator

This indicator acts as a guide when commands are programmed into or sent by the remote controller. It also warns the user when an error is made or battery power is low.

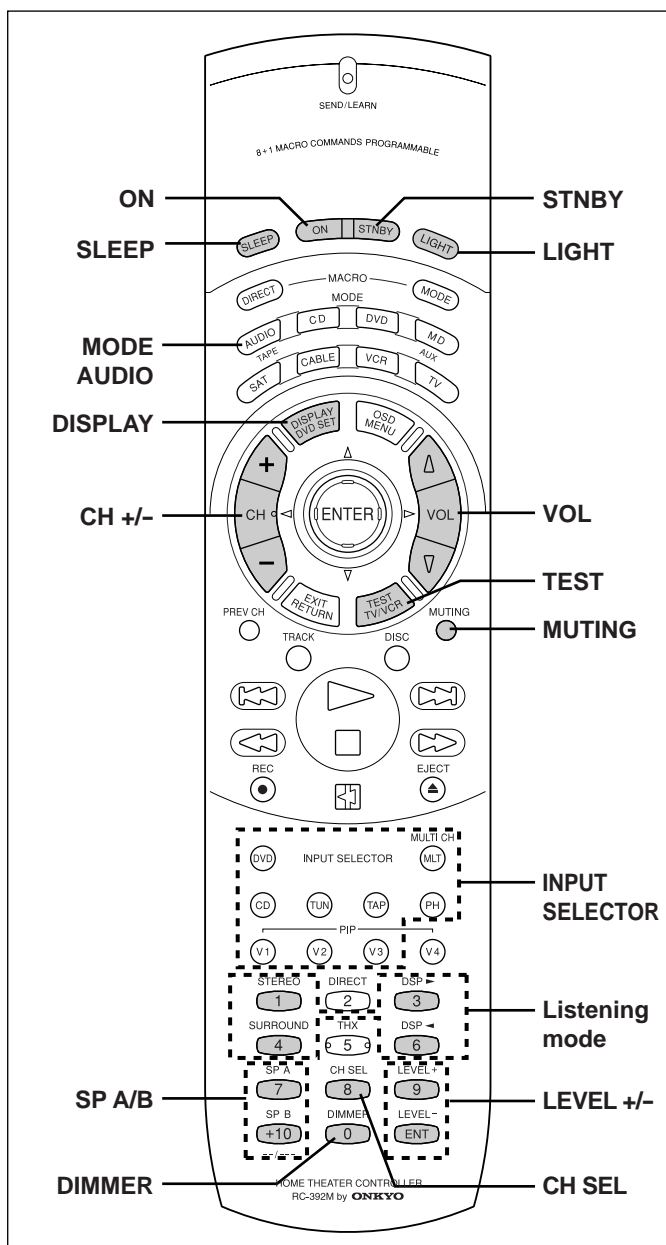

Controlling the TX-DS575X

1. Press the **MODE AUDIO** button.
2. Press the **desired operation button**.
Shaded buttons in the figure are the operation buttons used to control the TX-DS575X.

- SLEEP** : Sleep function
- ON/STNBY** : Power on/standby
- DISPLAY** : Changing the display
- VOL Δ/∇** : Adjusting the volume
- CH +/-** : Tuner preset number increment/decrement
- INPUT SELECTOR**
Listening mode (**STEREO/DSP◀/DSP▶/SURROUND**)
: Changing Listening mode
- SP A/SP B** : Switching between Speakers A and B
- CH SEL** : Selecting a speaker
- DIMMER** : Adjusting the brightness of the display
- LEVEL +/-** : Adjusting the speaker levels
- TEST** : Test tone
- MUTING** : Muting
- LIGHT** : Illuminating the buttons.

Using the remote controller

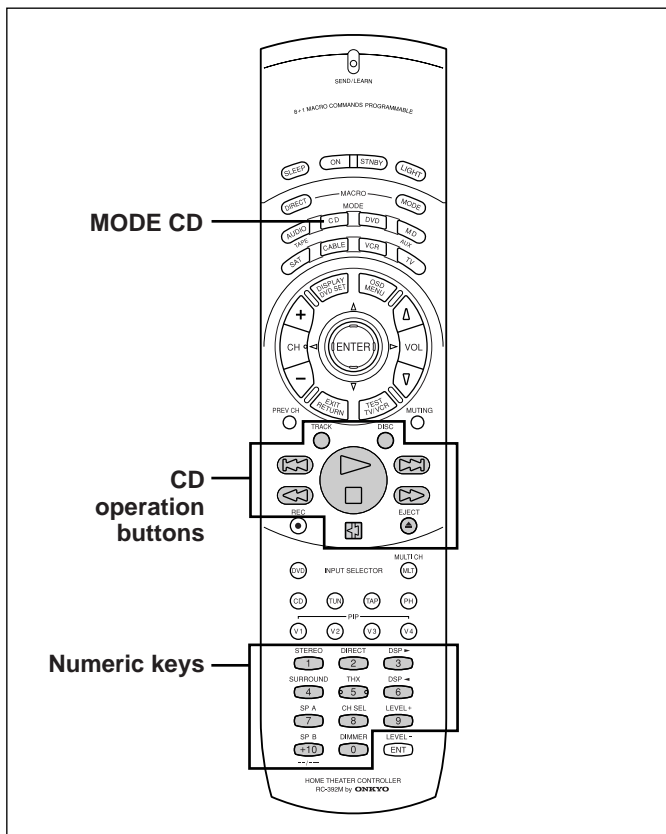

Controlling an Onkyo CD player

Note:

First connect an Onkyo CD player using the **RI** connection.

1. Press the **MODE CD** button.
2. Press the desired **CD operation button**.

CD operation buttons

TRACK	: Selecting a track
DISC	: Selecting a disk in the CD changer
	: Track Down
	: Track Up
	: Playback
	: Stop
	: Fast reverse
	: Fast forward
	: Pause
EJECT	: Eject
0, 1-9, +10	: Numeric keys

You may also use the following buttons:

VOL	: Adjusting the volume level of the TX-DS575X
MUTING	: Muting the sound from the TX-DS575X

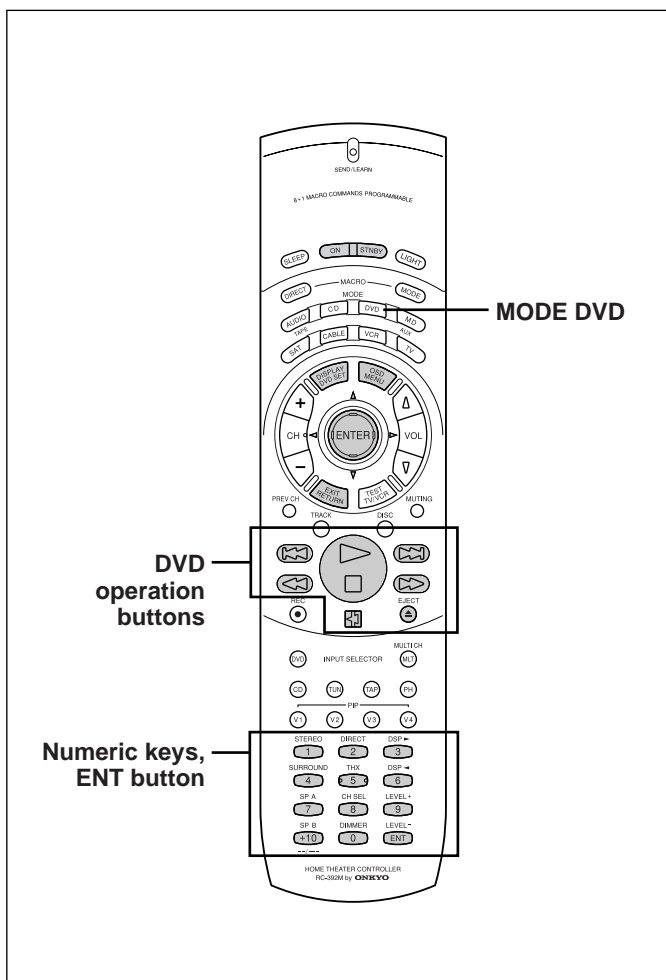

Controlling an Onkyo DVD player

Note:

Make sure that you point the transmission part on the remote controller toward the sensor area on the DVD player.

1. Press the **MODE DVD** button.
2. Press the desired **DVD operation button**.

ON/STNBY	: Turning the power on and off to the DVD player
DVD SET	: DVD setup

DVD player on-screen button

MENU	: Displaying the menu
	: Moving the cursor
ENTER	: Confirming the selection
RETURN	: Return

DVD operation buttons

	: Track/Chapter Down
	: Track/Chapter Up
	: Playback
	: Stop
	: Fast reverse
	: Fast forward
	: Pause
EJECT	: Eject
0, 1-9, +10	: Numeric keys
ENT	: Confirm

You may also use the following buttons:

VOL	: Adjusting the volume level of the TX-DS575X
MUTING	: Muting the sound from the TX-DS575X

Note:

The ENT button on the right below the numeric keys has the same function as "ENTER" of the ENTER/cursor button.

Using the remote controller

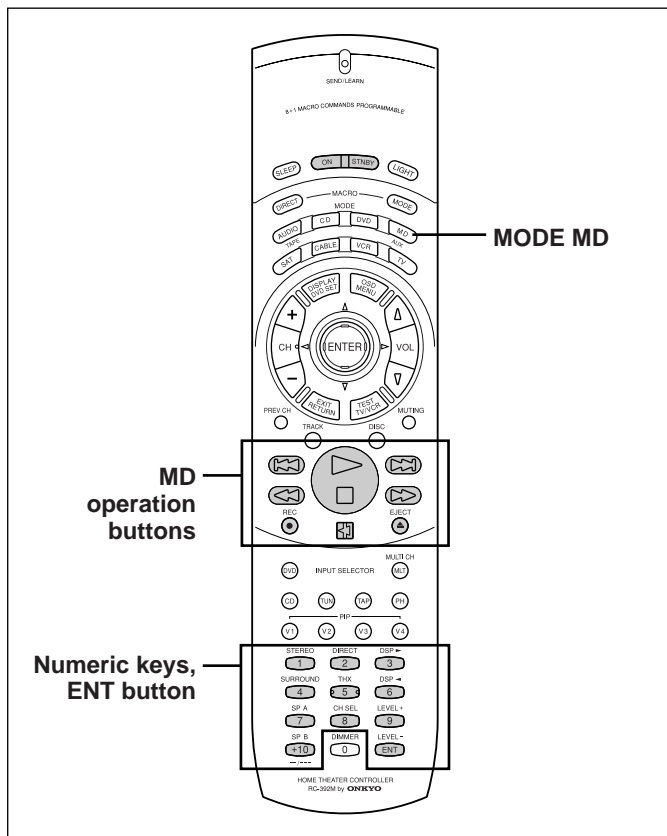

Controlling an Onkyo MD recorder

Note:

Make sure that you point the transmission part on the remote controller toward the sensor area on the MD recorder.

1. Press the **MODE MD/AUX** button.
2. Press the desired **MD operation** button.

Turning the power on and off to the MD recorder

ON/STNBY : Turning on or standby the power to the MD recorder

MD operation buttons

- : Track Down
- : Track Up
- : Playback
- : Stop
- : Fast reverse
- : Fast forward
- REC ●** : Record
- : Pause
- EJECT ▲** : Eject
- 1~9, +10** : Numeric keys
- ENT** : Confirm

You may also use the following buttons:

- VOL Δ/∇** : Adjusting the volume level of the TX-DS575X
- MUTING** : Muting the sound from the TX-DS575X

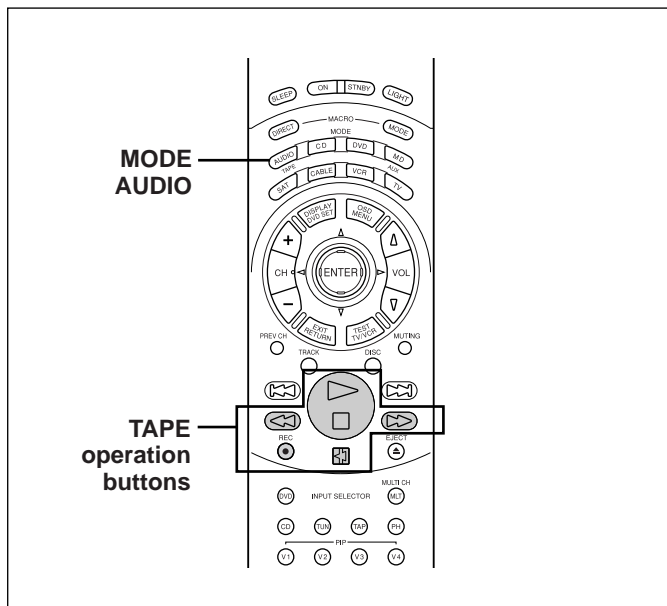

Controlling an Onkyo tape deck

Note:

First connect an Onkyo tape deck using the **RI** connection. (See page 9.)

1. Press the **MODE AUDIO/TAPE** button.
2. Press the desired **tape deck operation** button.

TAPE operation buttons

- : Playback
- : Stop
- : Fast rewind
- : Fast forward
- REC ●** : Recording/pause
- : Reverse play

You may also use the following buttons:

- VOL Δ/∇** : Adjusting the volume level of the TX-DS575X
- MUTING** : Muting the sound from the TX-DS575X

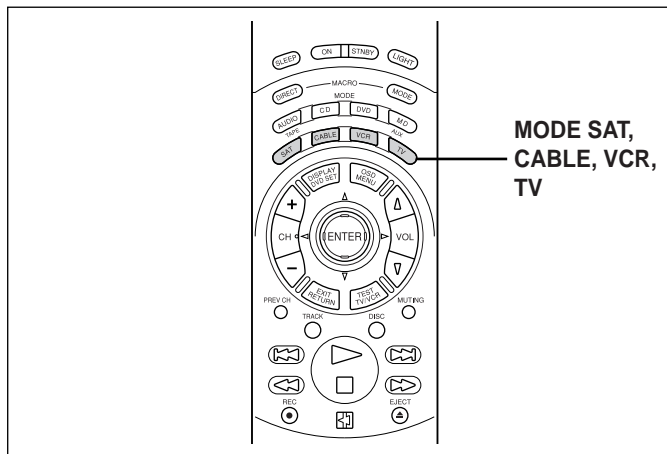

MODE SAT, CABLE, VCR, and TV buttons

No preset codes are programmed into the MODE SAT, CABLE, VCR, and TV buttons. You can use these buttons to program remote controller signals of other devices. (See page 34.)

You may use the following buttons:

- VOL Δ/∇** : Adjusting the volume level of the TX-DS575X
- MUTING** : Muting the sound from the TX-DS575X

Programming the remote controller codes of other devices into the RC-392M

The RC-392M has two learning functions. One is a normal learning function that enables the RC-392M to learn other remote controllers' codes. The other is a macro learning function, which enables the RC-392M to learn a series of codes already memorized in the remote controller into one MACRO button.

Programming procedure

Program the codes for each mode (AUDIO, CD, DVD, MD, SAT, CABLE, VCR, and TV).

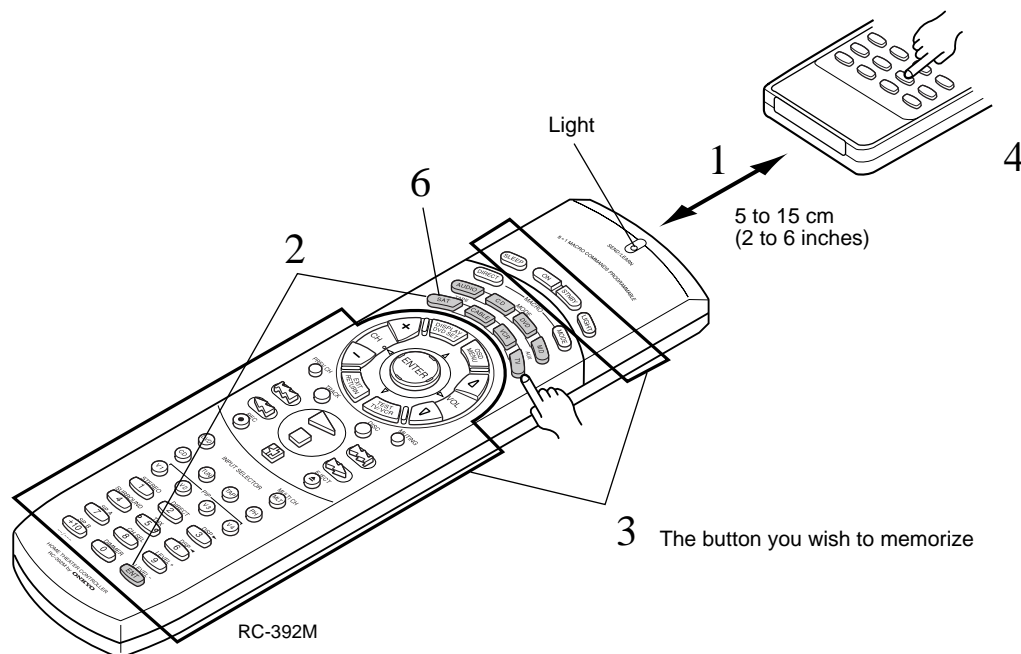

1. Place the RC-392M and the remote controller for another device, with 5–15cm (2–6 inches) apart and the light-emitting parts facing each other.

2. While pressing and holding down the desired MODE button on the RC-392M (AUDIO, CD, DVD, MD, SAT, CABLE, VCR, or TV), press the ENT button, then release the buttons.

When you press and hold down one of the MODE button, the SEND/LEARN indicator lights up. When you press the ENT button, the indicator turns off. When you release the buttons, the SEND/LEARN indicator lights up again.

3. Press and release the desired operation button on the RC-392M.

You may select any button within the rectangle shown in the figure. When you press the button, the SEND/LEARN indicator turns off. When you release the button, the indicator lights up again.

4. Press and hold down the desired button on the remote controller of the other device until the SEND/LEARN indicator on the RC-392M flashes twice.

The SEND/LEARN indicator flashes twice slowly, then lights up.

5. Repeat Steps 3–4 to program other buttons in the same MODE.

Repeat Steps 2–4 to program other buttons in a different MODE.

6. Press the MODE button to complete programming.

7. Operate the programmed button to make sure the learning function works.

Note:

The remote controller codes for the Onkyo CD player, tape deck, DVD player, and MD recorder have already been programmed into the buttons on the RC-392M. You may program other remote controller codes into these buttons. If you wish to restore the Onkyo preset codes after you program new codes, erase the new codes. (See page 35.)

Note:

- The remote controller has 408 memory slots (51 buttons × 8 modes), although this number varies significantly depending on the manufacturers and types of the remote controller you wish to program into the RC-392M. It is recommended that you determine which button functions have priority for programming.
- If you do not press any button for more than 30 seconds during the procedure, the SEND/LEARN indicator flashes three times quickly, then the RC-392M exits Learning mode. Resume Step 2.
- If you make a mistake during programming, the SEND/LEARN indicator flashes three times quickly, then the RC-392M exits Learning mode.
- If you try to program beyond the learning capacity of the RC-392M, the SEND/LEARN indicator flashes six times quickly, then the RC-392M exits Learning function. Try programming in a button of other MODE.
- Follow the same procedure when you wish to program new codes into the already-programmed buttons.
- This remote controller uses infrared rays. Most remote controller codes can be memorized using the infrared system; however, depending on the degree to which the system differs, there may be some rare occasions when memorization is not possible.
- Some remote controllers use a single button to perform different functions, with the function code changing each time the button is pressed. If you are using this kind of controller, please perform the “learn” operations for each function individually to store each function to a button on the RC-392M.
- For instructions regarding the operation of “learned” units, please refer to the instruction manual for each product.
- Even after codes have been memorized, please keep your old remote controller in a safe place. If the memorized codes are lost when the batteries run down, it will be necessary to memorize them once again using the old remote controller.
- Make sure both the RC-392M and the product's own remote controller have fresh batteries. If either of them has batteries that are wearing down, it may be impossible to store the remote controller codes into the RC-392M or the product may not respond properly to the buttons on the RC-392M for which the remote controller codes were stored into memory.

Programming the remote controller codes of other devices into the RC-392M

See page 39 for information on how to erase the learned codes from all buttons.

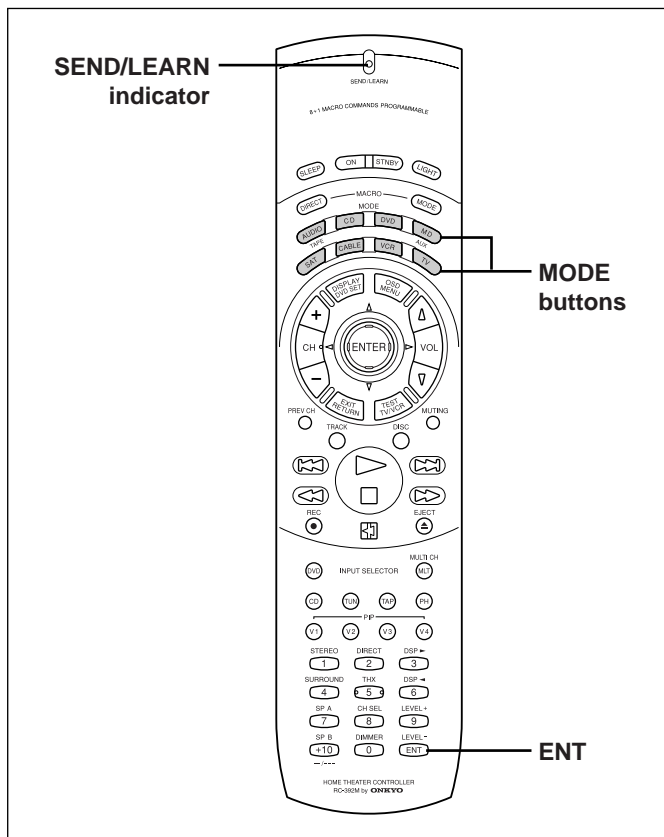

Erasing a learned code

You can erase a learned code. You cannot erase preset codes.

Erasing a code programmed in a button

1. Press and hold down the corresponding **MODE** button and press the **ENT** button, then release the buttons.

When you press the MODE button, the SEND/LEARN indicator lights up. When you press the ENT button, the indicator turns off. When you release the buttons, the indicator lights up again.

2. Press and release the button from which you wish to erase the learned code.

When you press the button, the SEND/LEARN indicator turns off. When you release the button, the indicator lights up again.

3. Press and release the same button again.

The SEND/LEARN indicator flashes twice slowly. The learned code is erased.

Note:

- If you do not press the button in step 2 or 3 for more than 30 seconds, the SEND/LEARN indicator flashes three times quickly, then the RC-392M exits Learning mode. Resume Step 1.

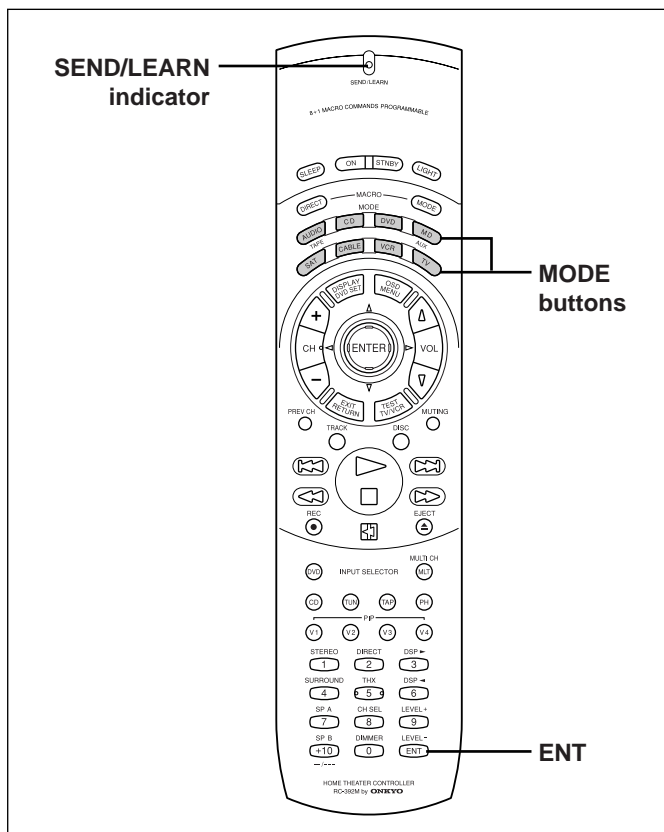

Erasing a learned code from a MODE button

1. Press and hold down the **MODE** button from which you wish to erase the learned code, and press the **ENT** button twice. Then release the buttons.

When you press the MODE button, the SEND/LEARN indicator lights up. When you press the ENT button, the indicator turns off. When you release the buttons, the indicator flashes twice slowly, then lights up again.

2. Press and release the same **MODE** button again.

When you release the button, the SEND/LEARN indicator flashes twice slowly. The learned code is erased.

Note:

- If you do not press any button for more than 30 seconds, the SEND/LEARN indicator flashes three times quickly, then the RC-392M exits Learning mode. Resume Step 1.
- If you make a mistake during programming, the SEND/LEARN indicator flashes three times quickly, the RC-392M exits Learning mode. Resume Step 1.
- If you have programmed many button operations to a single MODE button, the SEND/LEARN indicator may remain illuminated continuously in Step 2. This is not malfunction.

Using a Macro function

What is a Macro function?

A Macro function enables you to program a series of button operations on the remote controller into a single button. For example, you need to follow the steps below to play a CD player connected to the TX-DS575X without using the Macro function:

1: Press the MODE AUDIO button. → 2: Press the ON button. → 3: Press the CD (INPUT SELECTOR) button. → 4: Press the MODE CD button. → 5: Use the numeric keys to select the desired song.

This operation will be two button presses away if you program these steps into a macro button.

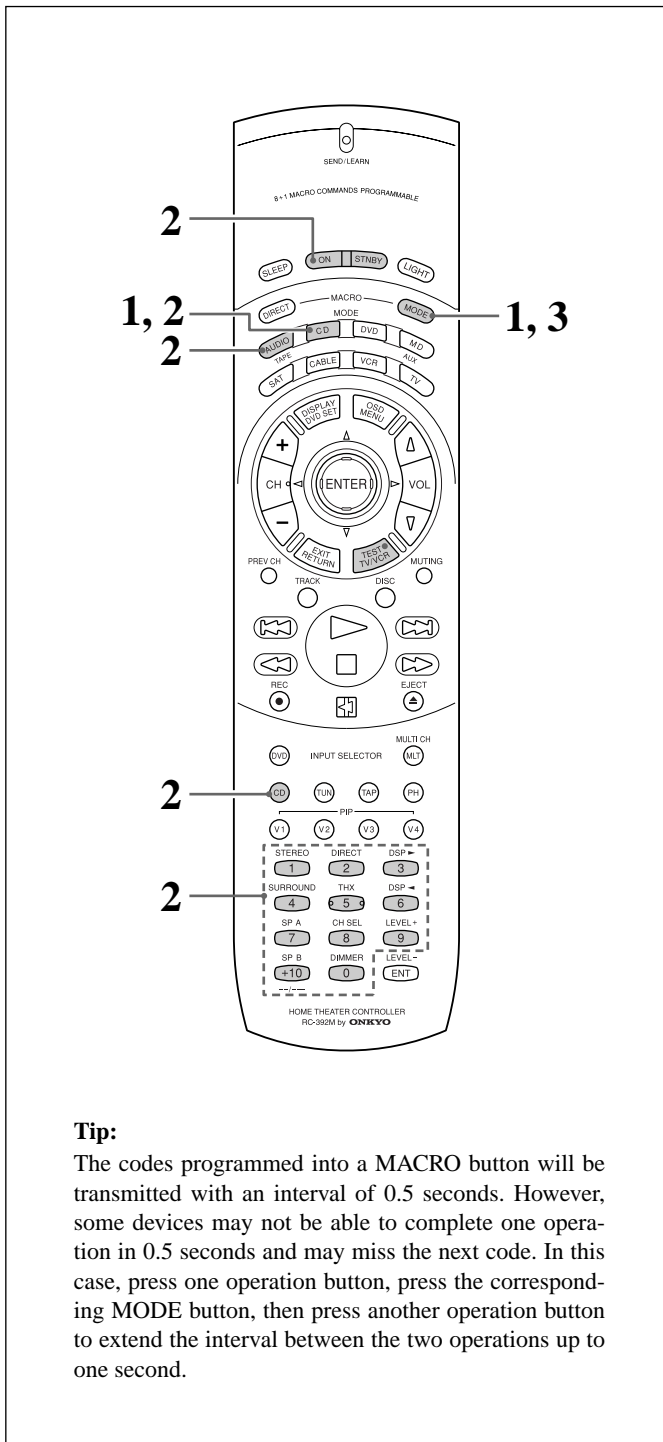

Tip:

The codes programmed into a MACRO button will be transmitted with an interval of 0.5 seconds. However, some devices may not be able to complete one operation in 0.5 seconds and may miss the next code. In this case, press one operation button, press the corresponding MODE button, then press another operation button to extend the interval between the two operations up to one second.

Programming Macro mode

You may program the desired steps into each of eight MODE buttons. The following example explains how to program Steps 1–5 (described above) into the MACRO MODE button under the MODE CD button (CD mode).

1. Press and hold down the desired MODE button you wish to program (in this case, MODE CD button), and press the MACRO MODE button. Then release the buttons.

When you press the MODE CD button, the SEND/LEARN indicator lights up. When you press the MACRO MODE button, the indicator turns off.

When you release the buttons, the indicator flashes briefly, then lights up again.

2. Press the operation buttons in series you wish to program into the MACRO MODE button.

Press the MODE AUDIO, ON, CD (INPUT SELECTOR), MODE CD buttons, and a numeric key. When you press the button, the SEND/LEARN indicator turns off. When you release the button, the indicator lights up.

3. Press the MACRO MODE button to complete programming.

The SEND/LEARN indicator flashes twice slowly.

Repeat Steps 1–3 to program other series of button operations into another MODE button.

4. Check to see if the series of button operation has been correctly learned.

Point the remote controller toward the TX-DS575X, press the MODE CD button, and press the MACRO MODE button to see if the unit responds as programmed.

Transmitting the codes in Macro mode takes a while. During transmission, point the remote controller toward the device to be controlled.

Note:

- You may program up to 16 button operations into each MACRO button. If you try to program the 17th step, it will be ignored.
- If you do not press any button for more than 30 seconds during the procedure, the SEND/LEARN indicator flashes three times quickly, then the RC-392M exits Learning mode. Resume Step 1.
- If you make a mistake during programming, the SEND/LEARN indicator flashes three times quickly, then the RC-392M exits Learning mode. Resume Step 1.
- If you erase one of the operation buttons already programmed in the MACRO MODE button, or if you program a different code into such a button, the operation button will no longer work. In this case, program the buttons again to avoid malfunction.

Using a Macro function

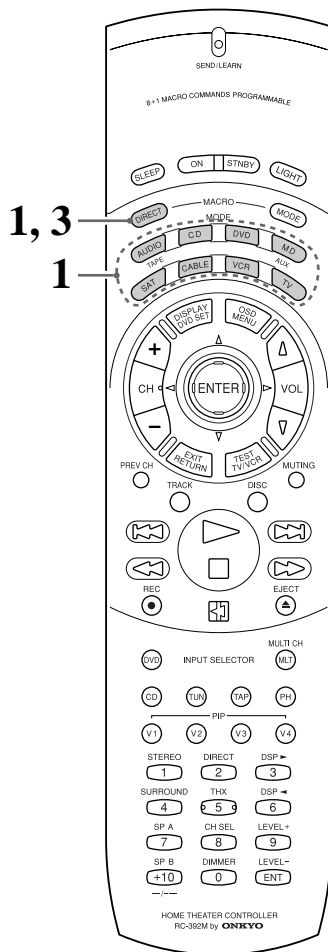

Tip:

The codes programmed into a MACRO button will be transmitted with an interval of 0.5 seconds. However, some devices may not be able to complete one operation in 0.5 seconds and may miss the next code. In this case, press one operation button, press the corresponding MODE button, then press another operation button to extend the interval between the two operations up to one second.

Macro Direct Learning function

A series of remote controller button operations can be memorized into the MACRO DIRECT button for one-touch control.

Note:

You can program only one series of button operations into the MACRO DIRECT button.

1. Press and hold down any one of the eight MODE buttons and press the MACRO DIRECT button. Then, release the buttons.

When you press the MODE button, the SEND/LEARN indicator lights up. When you press the MACRO DIRECT button, the indicator turns off. When you release the buttons, the indicator flashes briefly, then lights up again.

2. Follow Steps 2 in the “Programming Macro Mode” on page 36.

3. Press the MACRO DIRECT button to complete the procedure.

The SEND/LEARN indicator flashes twice slowly.

4. Check to see if the button has been programmed correctly.

Point the RC-392M toward the TX-DS575X and press the MACRO DIRECT button, and make sure that the device responds as programmed.

Transmitting the codes in Macro mode takes a while. During transmission, point the remote controller toward the device to be controlled.

Note:

- You may program up to 16 button operations into the MACRO DIRECT button. If you try to program the 17th step, it will be ignored.
- If you do not press any button for more than 30 seconds during the procedure, the SEND/LEARN indicator flashes three times quickly, then the RC-392M exits Learning mode. Resume Step 1.
- If you make a mistake during programming, the SEND/LEARN indicator flashes three times quickly, then the RC-392M exits Learning mode. Resume Step 1.
- If you erase one of the operation buttons already programmed in the MACRO DIRECT button, or if you program a different code into such a button, the operation button will no longer work. In this case, program the buttons again to avoid malfunction.

Using a Macro function

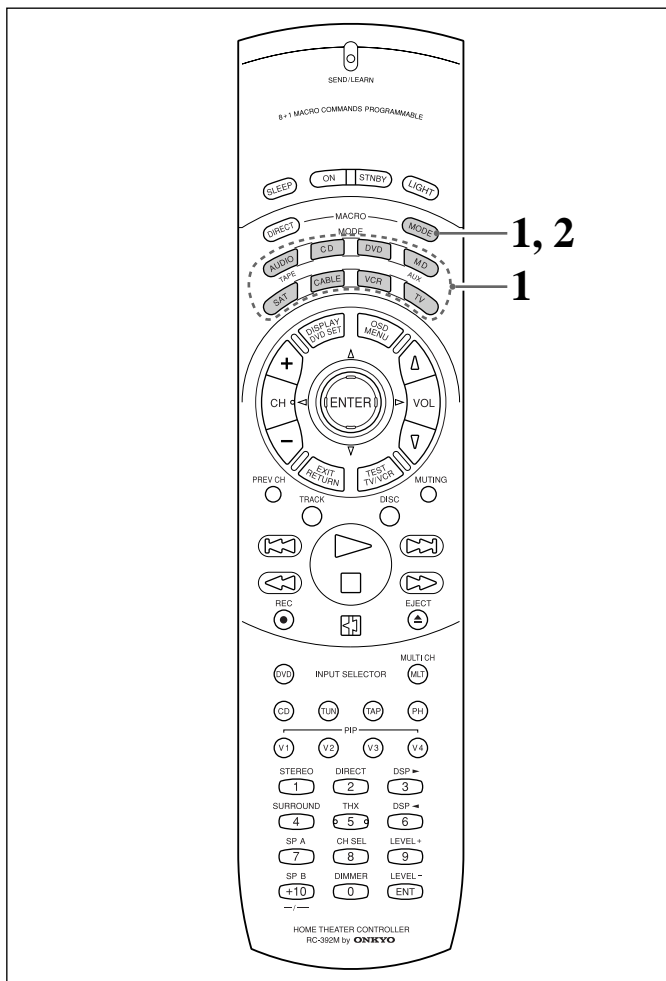

Erasing a learned remote controller button operation from the MACRO MODE buttons

1. Press and hold down the corresponding **MODE** button and press the **MACRO MODE** button, then release the buttons. When you press the MODE button, the SEND/LEARN indicator lights up. When you press the MACRO MODE button, the indicator turns off. When you release the buttons, the indicator flashes once.
2. Press the **MACRO MODE** button again. The SEND/LEARN indicator flashes twice slowly. The learned operation is erased.

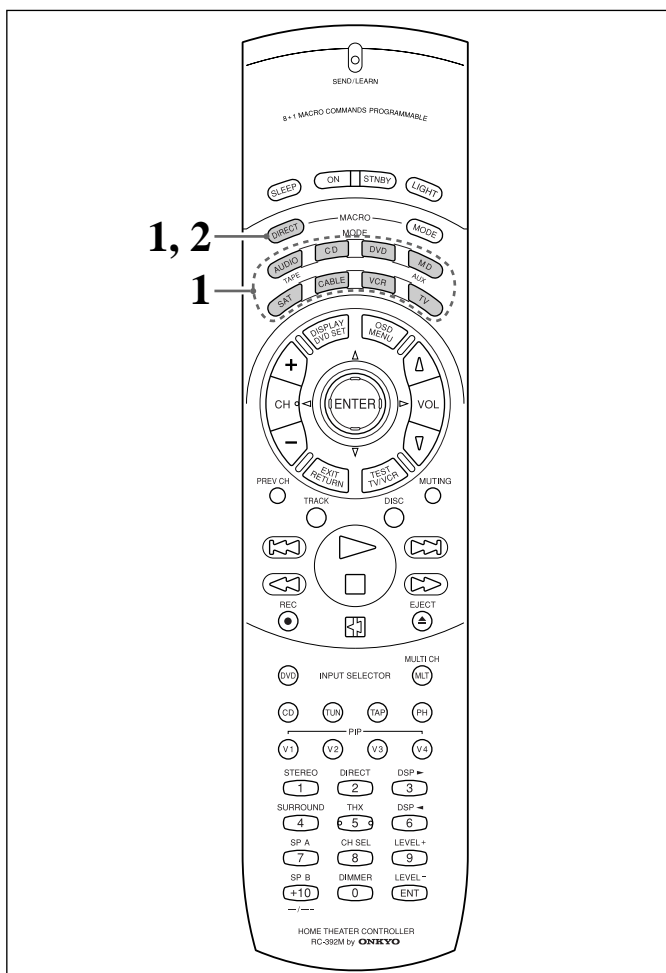

Erasing a learned remote controller button operation from the MACRO DIRECT button

1. Press and hold down any one of the **MODE** buttons and press the **MACRO DIRECT** button. Then release the buttons. When you press the MODE button, the SEND/LEARN indicator lights up. When you press the MACRO DIRECT button, the indicator turns off. When you release the buttons, the indicator flashes once.
2. Press the **MACRO DIRECT** button again. The SEND/LEARN indicator flashes twice slowly. The learned operation is erased.

Note:

- If you do not press any button for more than 30 seconds, the SEND/LEARN indicator flashes three times quickly, then the RC-392M exits Learning mode. Resume Step 1.
- If you press a wrong button in Step 2, you may have overwritten the memory of the button you pressed.

Using a Macro function

1

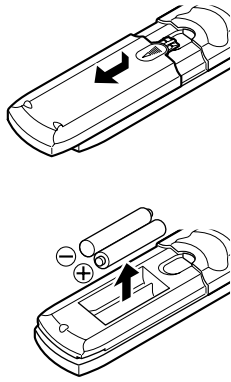

2

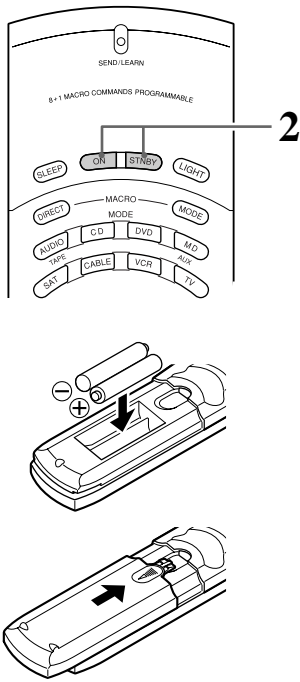

3

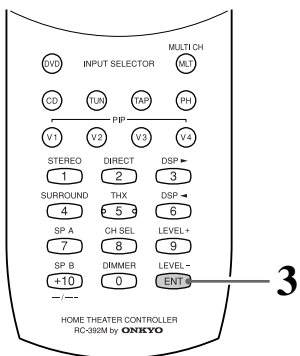

Erasing all codes and operations programmed in the buttons

This procedure will erase all remote controller codes for the other devices and all macro operations that have been programmed in the RC-392M (see pages 34, 36 and 37).

1. **Open the battery cover and remove the batteries.**
2. **While pressing and holding down the ON button and the STNBY button, insert the batteries in the correct direction.**
After inserting the batteries, release the buttons. The SEND/LEARN indicator flashes slowly.
3. **Press the ENT button.**
The SEND/LEARN indicator lights up for about ten seconds, then turns off. All programmed codes are erased and the button memories return to the factory presets.

Note:

- Proceed to Step 3 immediately after Step 2. Otherwise, the batteries will be consumed quickly.
- If you press any button other than the ENT button in Step 3, no codes will be erased. In this case, repeat the steps from the beginning.

Troubleshooting guide

If a problem occurs while you are using the remote controller, first try to operate the front panel controls on the main unit to make sure that it is not due to a malfunction (or worn out batteries) in the remote controller.

Trouble	Cause	Remedy	See page
No power.	<ul style="list-style-type: none"> Power cord is disconnected. There is external noise in the microcomputer circuits of this unit. AC fuse blown. 	<ul style="list-style-type: none"> Connect power cord. Turn the power button off and then on again or remove the AC plug from the outlet and then plug it again. Contact your Onkyo Service Center. 	11 11 –
Power on but no sound.	<ul style="list-style-type: none"> MUTING indicator is lit. The digital/analog input setting is incorrect. Bad connections. Amplifier protection circuitry has been activated. (STANDBY indicator flashes.) 	<ul style="list-style-type: none"> Press the MUTING button on the remote controller to turn it off. Select the correct input. Check connections, speaker leads, etc. Contact your Onkyo Service Center. 	20 18 10 –
No sound from the center speaker, or very minimal sound.	<ul style="list-style-type: none"> Speaker cable is not corrected. Listening mode is set to ORCHESTRA or STEREO. CENTER level is set to minimum. CENTER SPEAKER is set to NONE. 	<ul style="list-style-type: none"> Check the connection between the amplifier and the speaker. Set the Listening mode to any mode other than ORCHESTRA or STEREO. Set the CENTER level to the appropriate volume. Set CENTER SPEAKER to LARGE or SMALL. 	10 22 16 15
Pressing the ON button on the remote controller does not turn on the power to the main unit.	<ul style="list-style-type: none"> You have not pressed MODE AUDIO button. 	<ul style="list-style-type: none"> Press the MODE AUDIO button, then press the ON button. 	31
The unit or connected device does not respond to the operation.	<ul style="list-style-type: none"> You have not pressed any MODE button. 	<ul style="list-style-type: none"> Press an appropriate MODE button, then press the operation button. 	31–33
Hum, low-frequency noise.	<ul style="list-style-type: none"> Poor or no input ground. Poor or no phono motor ground. The placement of the audio connection cables on the rear panel is incorrect. 	<ul style="list-style-type: none"> Check outer conductor of input plugs. Check for proper ground connection. Adjust the placement of the cable to reduce hum. 	6 6 –
Howling when the volume is turned up.	<ul style="list-style-type: none"> Turntable and speakers are too close together. 	<ul style="list-style-type: none"> Move them farther apart. 	–
Rough or scratchy sound. High range is not clear.	<ul style="list-style-type: none"> Stylus of turntable pick-up is worn. Turntable stylus tip is dirty. Treble control too high. 	<ul style="list-style-type: none"> Replace. Clean. Turn treble control down. 	– – 20
AM stations cannot be received.	<ul style="list-style-type: none"> AM loop antenna is not attached. 	<ul style="list-style-type: none"> Connect the included AM loop antenna to the AM antenna terminals. 	12
Buzzing noise on AM (particularly conspicuous at night or with weak stations).	<ul style="list-style-type: none"> Noise from electrical apparatus such as fluorescent lamp. 	<ul style="list-style-type: none"> Move the AM loop antenna to different position. Set up an outdoor AM antenna. 	13 13
High-pitched noise or buzzing noise on AM.	<ul style="list-style-type: none"> Noise from TV set. 	<ul style="list-style-type: none"> Place the AM loop antenna as far as possible from the TV. Move unit away from TV set. 	13 –
Crackling noise on AM, FM.	<ul style="list-style-type: none"> Noise caused by turning fluorescent lamp on and off. Noise from automobile ignition. 	<ul style="list-style-type: none"> Move antenna as far as possible from the fluorescent lamp. Install an FM outdoor antenna as far as possible from the road. Change the position or direction of the outdoor antenna. 	13
TUNED and STEREO indicators light but sound is distorted and stereo separation is bad.	<ul style="list-style-type: none"> Station is too strong. Multiple reflection of the radio waves because of tall buildings or mountains. 	<ul style="list-style-type: none"> Change to FM indoor antenna. Use antenna which has better directivity and select a point where the distortion is least. 	12 13
TUNED and STEREO indicators flicker and hiss is heard on FM.	<ul style="list-style-type: none"> Station is too weak. Stereo FM broadcasts cover only about half the distance of an ordinary broadcast. 	<ul style="list-style-type: none"> Install an outdoor FM antenna. Change the position or direction of the outdoor antenna. 	13
No station is recalled.	<ul style="list-style-type: none"> The power cord has been unplugged or the POWER switch has been turned off for a long time. 	<ul style="list-style-type: none"> The memory contents are lost. Store all stations again. 	25
Front panel controls function but remote controller does not.	<ul style="list-style-type: none"> No batteries in remote controller. Batteries have worn out. 	<ul style="list-style-type: none"> Insert batteries. Replace batteries. 	5 5
The sound of the playback source is not heard.	<ul style="list-style-type: none"> The input selector is not set properly. 	<ul style="list-style-type: none"> Set it to the playback source. 	17

Also refer to the respective instruction manuals of the video disc player, video cassette recorder, TV monitor, etc., that compose your entertainment system.

Because the unit contains a microcomputer to provide advanced functions, it may malfunction due to external noise or static electricity. If this happens, press the POWER switch on the unit and then press it in again after about five seconds.

Specifications

AMPLIFIER SECTION

Continuous Average Power output (FTC)

All channels: 70 watts per channel min. RMS at 8 ohms, 2 channels driven from 20 Hz to 20 kHz with no more than 0.08% total harmonic distortion. 90 watts min. RMS at 6 ohms, 2 channels driven from 1 kHz with no more than 0.1% total harmonic distortion.

Continuous Power output (DIN) 100 watts × 5 at 6 ohms
Maximum Power output (EIAJ) 130 watts × 5 at 6 ohms
Total Harmonic Distortion: 0.08% at rated power (Front)
IM Distortion: 0.08% at rated power (Front)
Damping Factor: 60 at 8 ohms (Front)

Input Sensitivity and Impedance

PHONO: 2.5 mV, 50 kohms
LINE (CD, TAPE, DVD, VIDEO 1, 2, 3): 300 mV, 50 kohms
MULTICHANNEL INPUT (FRONT L/R, SURROUND L/R, CENTER): 300 mV, 50 kohms
(SUBWOOFER): 53 mV, 50 kohms
COAXIAL 1, 2 (DIGITAL): 0.5 Vp-p, 75 ohms

Output Level and Impedance

Rec out (TAPE, VIDEO 1): 300 mV, 2.2 kohms
Pre out (SUBWOOFER): 1 V, 2.2 kohms
Phono Overload: 70 mV RMS at 1 kHz, 0.5% T.H.D.
Frequency Response: 5 Hz to 100 kHz, +1dB, -3dB
RIAA Deviation: 20 Hz to 20 kHz, ±0.8 dB

Tone Control

Bass: ±10 dB at 100 Hz
Treble: ±10 dB at 10 kHz

Signal-to-Noise Ratio

Phono: 80 dB (IHF A, 5 mV input)
CD/Tape: 100 dB (IHF A)

VIDEO SECTION

Input sensitivity/Impedance

(DVD, VIDEO 1, 2, 3)
VIDEO (Composite): 1 Vp-p, 75 ohms
S-VIDEO (Y signal): 1 Vp-p/75 ohms

Output Level/Impedance

(VIDEO 1, MONITOR)
VIDEO (Composite): 1 Vp-p, 75 ohms
S-VIDEO (Y signal): 0.28 Vp-p/75 ohms

TUNER SECTION

FM

Tuning Range: 87.5 — 108.0 MHz
Usable Sensitivity
Mono: 11.2 dBf, 1.0 μV (75 ohms)
Stereo: 17.2 dBf, 2.0 μV (75 ohms)
50 dB Quieting Sensitivity
Mono: 17.2 dBf, 2.0 μV (75 ohms)
Stereo: 37.2 dBf, 20 μV (75 ohms)
Capture Ratio: 2.0 dB
Image Rejection Ratio
U.S.A. & Canadian models: 40 dB
Other area models: 85 dB

IF Rejection Ratio: 90 dB
Signal-to-Noise Ratio
Mono: 76 dB
Stereo: 70 dB
Alternate Channel Attenuation: 55 dB
Selectivity: 50 dB (DIN)
AM Suppression Ratio: 50 dB
Total Harmonic Distortion
Mono: 0.2%
Stereo: 0.3%
Frequency Response: 30 Hz — 15 kHz, ±1.0 dB
Stereo Separation: 45 dB at 1 kHz
30 dB at 100 Hz — 10 kHz

AM

Tuning Range

U.S.A. & Canadian models: 530—1,710 kHz (10 kHz steps)
European & Australian models: 522—1,611 kHz (9 kHz steps)
Worldwide models: 531—1,602 kHz (9 kHz steps), 530—1,710 kHz (10 kHz steps)

Usable Sensitivity: 30 μV
Image Rejection Ratio: 40 dB
IF Rejection Ratio: 40 dB
Signal-to-Noise Ratio: 40 dB
Total Harmonic Distortion: 0.7%

GENERAL

Power Supply: AC 120 V, 60 Hz
AC 230 V, 50 Hz
AC 220-230 V and 120 V switchable, 50/60 Hz
AC 220 V, 50/60 Hz
Power Consumption: 3.9 A
325 W
Dimensions (W × H × D): 435 × 175 × 390 mm
17-1/8" × 6-7/8" × 15-3/8"
Weight: 12.5 kg, 27.6 lbs. (AC 120 V, 60 Hz model)
13.2 kg, 29.1 lbs. (other models)

REMOTE CONTROL

Transmitter: Infrared
Signal range: Approx. 5 meters, 16 ft.
Power supply: Two "AA" batteries (1.5 V × 2)

Specifications and features are subject to change without notice.

Power supply and voltage vary depending on the area in which the unit is purchased.

Control positions and names

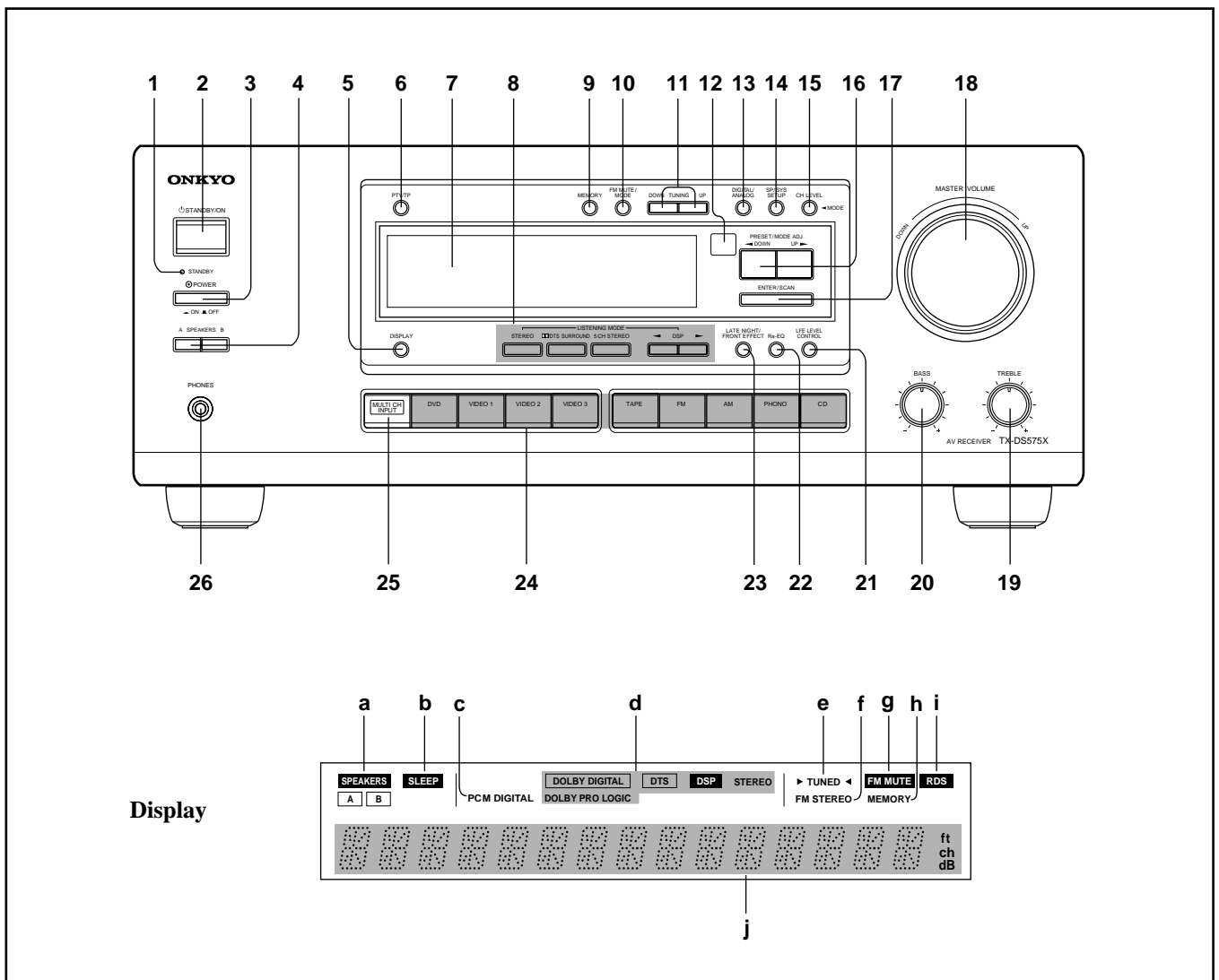

Front panel

For more information about buttons or knobs, refer to the pages listed in the brackets ([]) below.

1. STANDBY indicator [5, 11]
2. STANDBY/ON button [9, 11]
3. POWER switch [9, 11]
4. SPEAKERS A/B button [17, 20]
5. DISPLAY button [24]
6. DIMMER button [17] *or*
PTY/TP button (European model only) [28]
7. Display (Refer to the "Display" illustration.)
8. LISTENING MODE buttons
STEREO button [22]
□□/DTS SURROUND button [22]
5 CH STEREO button [22]
DSP ◀/▶ (DOWN/UP) button [22]
9. MEMORY button [25]
10. FM MUTE/MODE button [24]
11. TUNING UP/DOWN buttons [24]
12. Remote control sensor [5]
13. DIGITAL/ANALOG button [18]
14. SP/SYS SETUP button [14, 15]
15. CH LEVEL button [23]
16. PRESET/MODE ADJ ◀/▶ button [14, 15, 18, 25, 28]
17. ENTER button (other than European model) *or*
ENTER/SCAN button (European model only) [14, 15, 18, 25, 26, 28]
18. MASTER VOLUME control knob [17, 20]

19. TREBLE control knob [17, 20]
20. BASS control knob [17, 20]
21. LEF LEVEL CONTROL button [23]
22. Re-EQ button [23]
23. LATE NIGHT/FRONT EFFECT button [23]
24. Input selector buttons [17, 22, 29]
25. MULTI CHANNEL INPUT button [17, 19]
26. PHONES jack [20]

Display

If a protective film on the surface of the screen making it difficult to read the display, remove the film.

- a. Speakers A/B indicators
- b. Sleep indicator
- c. PCM digital indicator
- d. Listening mode indicators
- e. Tuned indicators
- f. FM Stereo indicator
- g. FM Mute On/Off indicator
- h. Memory indicator
- i. RDS station received indicator (European model only)
- j. Multi function display (Frequency and Preset station/Input selector/Sleep time/Volume level/Listening mode)

Control positions and names

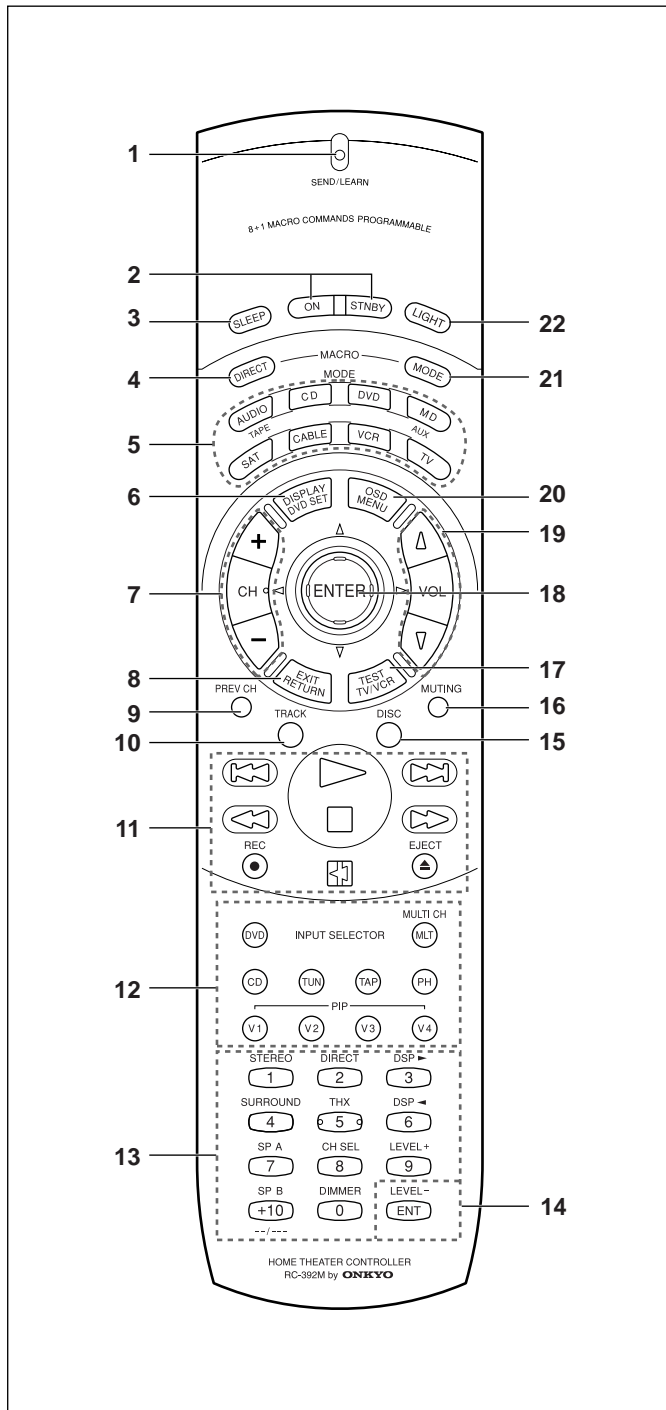

Remote controller

Using the remote controller, you can control a CD player or cassette tape deck connected to the **RI** connector of the TX-DS575X. (See page 9 for more information.)

1. **SEND/LEARN indicator** [31]
2. **ON/STNBY button** [31]
Power on/Standby on
3. **SLEEP button** [20]
Sleep function button
4. **MACRO DIRECT button** [37]
Macro Direct function
5. **MODE buttons** [31~39]
6. **DISPLAY/DVD SET button** [32]
7. **CH +/- buttons** [31]
8. **EXIT/RETURN button** [32]
9. **PREV CH button** [This button is not used for the TX-DS575X.]
10. **TRACK button** [32]
11. **CD/TAPE/DVD/MD operation buttons** [31~33]
12. **Input Selector buttons** [17]
The V4 button is not used for the TX-DS575X.
13. **Numeric key/STEREO/DSP ◀, ▶/SURROUND/SP A, B/CH SEL/LEVEL+,-/DIMMER buttons** [31~33]
[The DIRECT button and THX* button are not used for the TX-DS575X.]
14. **ENT button** [34, 35, 39]
15. **DISC button** [32]
16. **MUTING button** [20]
Mute button
17. **TEST/TV/VCR button** [16]
18. **ENTER/cursor buttons** [32]
19. **VOL Δ/∇ button** [17]
Volume adjustment
20. **OSD/MENU button** [32]
21. **MACRO MODE button** [36]
22. **LIGHT button** [31]

*The THX[®] button activates the THX mode on products certified by Lucasfilm.

This control will not function on products which are not THX-certified. THX is a registered trademark of Lucasfilm, Ltd.

ONKYO CORPORATION

Sales & Product Planning Div. : 2-1, Nisshin-cho, Neyagawa-shi, OSAKA 572-8540, JAPAN
Tel: 072-831-8111 Fax: 072-833-5222 <http://www.onkyo-intl.com>

ONKYO U.S.A. CORPORATION

18 Park Way, Upper Saddle River, N.J. 07458, U.S.A.
Tel: 201-785-2600 Fax: 201-785-2650 <http://www.onkyousa.com>

ONKYO EUROPE ELECTRONICS GmbH

Liegnitzerstrasse 6, 82194 Groebenzell, GERMANY
Tel: 089-849-320+49-8142-4401-0 Fax: +49-8142-4401-555 <http://www.onkyo.net>

ONKYO CHINA LIMITED

Units 2102-2107, Metroplaza Tower I, 223 Hing Fong Road, Kwai Chung,
N.T., HONG KONG Tel: 852-2429-3118 Fax: 852-2428-9039 <http://www.onkyochina.com>



Free Manuals Download Website

<http://myh66.com>

<http://usermanuals.us>

<http://www.somanuals.com>

<http://www.4manuals.cc>

<http://www.manual-lib.com>

<http://www.404manual.com>

<http://www.luxmanual.com>

<http://aubethermostatmanual.com>

Golf course search by state

<http://golfingnear.com>

Email search by domain

<http://emailbydomain.com>

Auto manuals search

<http://auto.somanuals.com>

TV manuals search

<http://tv.somanuals.com>