

ONKYO®

AV Receiver

TX-DS696

Instruction Manual

Thank you for purchasing the Onkyo AV Receiver. Please read this manual thoroughly before making connections and plugging in the unit. Following the instructions in this manual will enable you to obtain optimum performance and listening enjoyment from your new AV Receiver. Please retain this manual for future reference.

Contents

Before using	2
---------------------	----------

Facilities and connections	8
-----------------------------------	----------

Setup and operation	22
----------------------------	-----------

Remote controller	46
--------------------------	-----------

Appendix	61
-----------------	-----------

WARNING:

TO REDUCE THE RISK OF FIRE OR ELECTRIC SHOCK, DO NOT EXPOSE THIS APPLIANCE TO RAIN OR MOISTURE.

CAUTION:

TO REDUCE THE RISK OF ELECTRIC SHOCK, DO NOT REMOVE COVER (OR BACK). NO USER-SERVICEABLE PARTS INSIDE. REFER SERVICING TO QUALIFIED SERVICE PERSONNEL.



WARNING
RISK OF ELECTRIC SHOCK
DO NOT OPEN

AVIS
RISQUE DE CHOC ELECTRIQUE
NE PAS OUVRIR



The lightning flash with arrowhead symbol, within an equilateral triangle, is intended to alert the user to the presence of uninsulated "dangerous voltage" within the product's enclosure that may be of sufficient magnitude to constitute a risk of electric shock to persons.



The exclamation point within an equilateral triangle is intended to alert the user to the presence of important operating and maintenance (servicing) instructions in the literature accompanying the appliance.

Important Safeguards

- 1. Read Instructions** – All the safety and operating instructions should be read before the appliance is operated.
- 2. Retain Instructions** – The safety and operating instructions should be retained for future reference.
- 3. Heed Warnings** – All warnings on the appliance and in the operating instructions should be adhered to.
- 4. Follow Instructions** – All operating and use instructions should be followed.
- 5. Cleaning** – Unplug the appliance from the wall outlet before cleaning. The appliance should be cleaned only as recommended by the manufacturer.
- 6. Attachments** – Do not use attachments not recommended by the appliance manufacturer as they may cause hazards.
- 7. Water and Moisture** – Do not use the appliance near water –for example, near a bath tub, wash bowl, kitchen sink, or laundry tub; in a wet basement; or near a swimming pool; and the like.
- 8. Accessories** – Do not place the appliance on an unstable cart, stand, tripod, bracket, or table. The appliance may fall, causing serious injury to a child or adult, and serious damage to the appliance. Use only with a cart, stand, tripod, bracket, or table recommended by the manufacturer, or sold with the appliance. Any mounting of the appliance should follow the manufacturer's instructions, and should use a mounting accessory recommended by the manufacturer.
- 9. An appliance and cart combination should be moved with care.** Quick stops, excessive force, and uneven surfaces may cause the appliance and cart combination to overturn.

PORTABLE CART WARNING

S3125A

- 10. Ventilation** – Slots and openings in the cabinet are provided for ventilation and to ensure reliable operation of the appliance and to protect it from overheating, and these openings must not be blocked or covered. The openings should never be blocked by placing the appliance on a bed, sofa, rug, or other similar surface. The appliance should not be placed in a built-in installation such as a bookcase or rack unless proper ventilation is provided. There should be free space of at least 20 cm (8 in.) and an opening behind the appliance.
- 11. Power Sources** – The appliance should be operated only from the type of power source indicated on the marking label. If you are not sure of the type of power supply to your home, consult your appliance dealer or local power company.
- 12. Grounding or Polarization** – The appliance may be equipped with a polarized alternating current line plug (a plug having one blade wider than the other). This plug will fit into the power outlet only one way. This is a safety feature. If you are unable to insert the plug fully into the outlet, try reversing the plug. If the plug should still fail to fit, contact your electrician to replace your obsolete outlet. Do not defeat the safety purpose of the polarized plug.
- 13. Power-Cord Protection** – Power-supply cords should be routed so that they are not likely to be walked on or pinched by items placed upon or against them, paying particular attention to cords at plugs, convenience receptacles, and the point where they exit from the appliance.
- 14. Outdoor Antenna Grounding** – If an outside antenna or cable system is connected to the appliance, be sure the antenna or cable system is grounded so as to provide some protection against voltage surges and built-up static charges. Article 810 of the National Electrical Code, ANSI/NFPA 70, provides information with regard to proper grounding of the mast and supporting structure, grounding of the lead-in wire to an antenna-discharge unit, size of grounding conductors, location of antenna-discharge unit, connection to grounding electrodes, and requirements for the grounding electrode. See Figure 1.
- 15. Lightning** – For added protection for the appliance during a lightning storm, or when it is left unattended and unused for long periods of time, unplug it from the wall outlet and disconnect the antenna or cable system. This will prevent damage to the appliance due to lightning and power-line surges.
- 16. Power Lines** – An outside antenna system should not be located in the vicinity of overhead power lines or other electric light or power circuits, or where it can fall into such power lines or circuits. When installing an outside antenna system, extreme care should be taken to keep from touching such power lines or circuits as contact with them might be fatal.
- 17. Overloading** – Do not overload wall outlets, extension cords, or integral convenience receptacles as this can result in a risk of fire or electric shock.
- 18. Object and Liquid Entry** – Never push objects of any kind into the appliance through openings as they may touch dangerous voltage points or short-out parts that could result in a fire or electric shock. Never spill liquid of any kind on the appliance.
- 19. Servicing** – Do not attempt to service the appliance yourself as opening or removing covers may expose you to dangerous voltage or other hazards. Refer all servicing to qualified service personnel.
- 20. Damage Requiring Service** – Unplug the appliance from the wall outlet and refer servicing to qualified service personnel under the following conditions:
 - When the power-supply cord or plug is damaged,
 - If liquid has been spilled, or objects have fallen into the appliance,
 - If the appliance has been exposed to rain or water,
 - If the appliance does not operate normally by following the operating instructions. Adjust only those controls that are covered by the operating instructions as an improper adjustment of other controls may result in damage and will often require extensive work by a qualified technician to restore the appliance to its normal operation,
 - If the appliance has been dropped or damaged in any way, and
 - When the appliance exhibits a distinct change in performance – this indicates a need for service.

21. **Replacement Parts** – When replacement parts are required, be sure the service technician has used replacement parts specified by the manufacturer or have the same characteristics as the original part. Unauthorized substitutions may result in fire, electric shock, or other hazards.
22. **Safety Check** – Upon completion of any service or repairs to the appliance, ask the service technician to perform safety checks to determine that the appliance is in proper operation condition.
23. **Wall or Ceiling Mounting** – The appliance should be mounted to a wall or ceiling only as recommended by the manufacturer.
24. **Heat** – The appliance should be situated away from heat sources such as radiators, heat registers, stoves, or other appliances (including amplifiers) that produce heat.

Precautions

1. Warranty Claim

You can find the serial number on the rear panel of this unit. In case of warranty claim, please report this number.

2. Recording Copyright

Recording of copyrighted material for other than personal use is illegal without permission of the copyright holder.

3. AC Fuse

The fuse is located inside the chassis and is not user-serviceable. If power does not come on, contact your Onkyo authorized service station.

4. Care

From time to time you should wipe the front and rear panels and the cabinet with a soft cloth. For heavier dirt, dampen a soft cloth in a weak solution of mild detergent and water, wring it out dry, and wipe off the dirt. Following this, dry immediately with a clean cloth. Do not use rough material, thinners, alcohol or other chemical solvents or cloths since these could damage the finish or remove the panel lettering.

5. Power

WARNING

BEFORE PLUGGING IN THE UNIT FOR THE FIRST TIME, READ THE FOLLOWING SECTION CAREFULLY.

The voltage of the available power supply differs according to country or region. Be sure that the power supply voltage of the area where this unit will be used meets the required voltage (e.g., AC 230 V, 50 Hz or AC 120 V, 60 Hz) written on the rear panel.

Worldwide models are equipped with a voltage selector to conform to local power supplies. Be sure to set this switch to match the voltage of the power supply in your area before plugging in the unit.

For British models

Replacement and mounting of an AC plug on the power supply cord of this unit should be performed only by qualified service personnel.

IMPORTANT

The wires in the mains lead are coloured in accordance with the following code:

Blue : Neutral

Brown : Live

As the colours of the wires in the mains lead of this apparatus may not correspond with the coloured markings identifying the terminals in your plug, proceed as follows:

The wire which is coloured blue must be connected to the terminal which is marked with the letter N or coloured black.

The wire which is coloured brown must be connected to the terminal which is marked with the letter L or coloured red.

IMPORTANT

A 5 ampere fuse is fitted in this plug. Should the fuse need to be replaced, please ensure that the replacement fuse has a rating of 5 amperes and that it is approved by ASTA or BSI to BS1362. Check for the ASTA mark or the BSI mark on the body of the fuse.

IF THE FITTED MOULDED PLUG IS UNSUITABLE FOR THE SOCKET OUTLET IN YOUR HOME THEN THE FUSE SHOULD BE REMOVED AND THE PLUG CUT OFF AND DISPOSED OF SAFELY. THERE IS A DANGER OF SEVERE ELECTRICAL SHOCK IF THE CUT OFF PLUG IS INSERTED INTO ANY 13 AMPERE SOCKET.

If in any doubt, consult a qualified electrician.

FIGURE 1:
EXAMPLE OF ANTENNA GROUNDING AS PER NATIONAL ELECTRICAL CODE, ANSI/NFPA 70

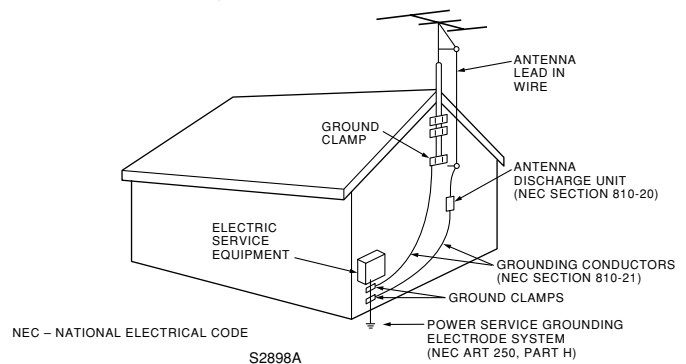

For U.S. models

Note to CATV system installer:

This reminder is provided to call the CATV system installer's attention to Section 820-40 of the NEC which provides guidelines for proper grounding and, in particular, specifies that the cable ground shall be connected to the grounding system of the building, as close to the point of cable entry as practical.

FCC Information for User

CAUTION:

The user changes or modifications not expressly approved by the party responsible for compliance could void the user's authority to operate the equipment.

NOTE:

This equipment has been tested and found to comply with the limits for a Class B digital device, pursuant to Part 15 of the FCC Rules. These limits are designed to provide reasonable protection against harmful interference in a residential installation. This equipment generates, uses and can radiate radio frequency energy and, if not installed and used in accordance with the instructions, may cause harmful interference to radio communications. However, there is no guarantee that interference will not occur in a particular installation. If this equipment does cause harmful interference to radio or television reception, which can be determined by turning the equipment off and on, the user is encouraged to try to correct the interference by one or more of the following measures:

- Reorient or relocate the receiving antenna.
- Increase the separation between the equipment and receiver.
- Connect the equipment into an outlet on a circuit different from that to which the receiver is connected.
- Consult the dealer or an experienced radio/TV technician for help.

For Canadian models

NOTE:

THIS CLASS B DIGITAL APPARATUS COMPLIES WITH CANADIAN ICES-003.

For models having a power cord with a polarized plug:

CAUTION: TO PREVENT ELECTRIC SHOCK, MATCH WIDE BLADE OF PLUG TO WIDE SLOT, FULLY INSERT.

Modele pour les Canadien

REMARQUE:

CET APPAREIL NUMÉRIQUE DE LA CLASSE B EST CONFORME À LA NORME NMB-003 DU CANADA.

Sur les modèles dont la fiche est polarisée:

ATTENTION: POUR ÉVITER LES CHOCS ÉLECTRIQUES, INTRODUIRE LA LAME LA PLUS LARGE DE LA FICHE DANS LA BORNE CORRESPONDANTE DE LA PRISE ET POUSSER JUSQU'AU FOND.

Contents

Before using

Important Safeguards	2
Precautions	3
Contents	4
Features	6
Supplied accessories	6
Before using this unit	7
Setting the Voltage selector	7
Installing the remote controller batteries	7
Using the remote controller	7

Facilities and connections

Front panel facilities	8
Remote controller	10
Connections	12
Connecting your audio components	13
Connecting your video components	14
Connect to devices with RI terminals	16
Cautions regarding the AC OUTLETS connectors	16
Connecting power amplifiers	16
Connect to devices with multichannel output	17
Connecting speakers	17
Positioning speakers	17
Connecting speakers	17
Connecting the speaker cable	18
Connecting a subwoofer	18
Connecting the remote zone speakers	18
Connecting the power	19
Connecting antennas	20
Assembling the AM loop antenna	20
Connecting the AM antenna cable	20
Connecting the included antennas	20
Connecting an FM outdoor antenna	21
Connecting an AM outdoor antenna	21
Directional linkage	21
Connecting the antenna cable to the 75/300 Ω antenna adapter	21

Setup and operation

Speaker setup	22
Speaker Configuration submenu	22
Speaker Distance submenu	23
Level Calibration submenu	24
About the other settings	24
Listening to Radio Broadcasts	25
Tuning into a radio station	25
Listening to a stereo radio station (FM mode)	25
Presetting a radio station	26
Selecting a preset radio station	26
Erasing a preset radio station	26
Listening to RDS broadcasts	27
Listening to RDS broadcasts	27
PTY program types in Europe	27
Displaying Radio Text (RT)	28
Performing a PTY scan	28
Performing a TP scan	28
Enjoying music or videos with the TX-DS696 ...	29
Basic operation	29
Temporarily turning off the sound	29
Adjusting the bass and treble	29
Listening with headphones	29
Switching the display	30
Adjusting the brightness of the front display	30
Using the sleep time (remote controller only)	30
Temporarily changing the speaker output levels	30
Changing the audio mode	31
Enjoying the multichannel output	31
Using listening mode	32
Listening modes	32
Changing the listening mode	33
Using Cinema Re-Equalization	33
Setup menus	34
Navigating through the Setup menu	35
1. Speaker Setup menu	36
1-1. Speaker Config sub-menu	37
1-2. Speaker Distance sub-menu	37
1-3. Level Calibration sub-menu	37

Contents

2. Input Setup menu	38
2-1. Audio Setup sub-menu	39
2-2. Video Setup sub-menu	39
2-3. Listening Mode Preset sub-menu	40
2-4. IntelliVolume sub-menu	40
3. Listening Mode Setup menu	41
Description listening mode parameters	41
4. Preference menu	42
4-1. Volume Setup sub-menu	42
4-2. Headphones Level sub-menu	42
4-3. Late Night Setup sub-menu	42
4-4. AM Freq Step Setup sub-menu	42
5. OSD Setup menu	43
5-1. OSD Setup sub-menu	43
5-2. OSD Position sub-menu	43
5-3. OSD Config sub-menu	43
Recording	44
Recording the input source (REC OUT selector)	44
Recording both the audio and video	44
Enjoying music in the remote zone	45
Selecting an input source and adjusting the volume on the TX-DS696	45
Selecting an input source and adjusting the volume using the remote controller	45

Operationing your programmed remote controller	52
DVD MODE (DVD Player Mode)	52
SAT MODE (Satellite Tuner Mode)	52
CABLE MODE (Cable Tuner Mode)	52
VCR MODE (VCR Mode)	53
TV MODE (TV Mode)	53
Programming the commands of remote controllers for other devices into the remote controller	54
Programming procedure	54
Erasing the programmed command from one button ...	56
Erasing all the commands programmed under a MODE button	56
Using a Macro function	57
What is a Macro function?	57
Programming a Macro function	57
Running a Macro function	57
Programming the Direct Macro function	58
Running a Direct Macro function	58
Erasing a macro from the MODE MACRO button	59
Erasing a direct macro from the DIRECT MACRO button	59
Erasing all commands and macros that have been programmed	60
(Macro mode programming memo	60)

Remote controller

Using remote controller	46
Overview	46
Calling up a preset radio station	46
Controlling an Onkyo cassette tape deck	46
Controlling an Onkyo CD player	47
Controlling an Onkyo DVD player	48
Controlling an Onkyo MD recorder	49
SAT, CABLE, VCR, and TV MODE buttons	49
Learning a pre-programming code	50
Learning a pre-programming code	50
Pre-programming codes	51

Appendix

Specifications	61
Troubleshooting guide	62
POWER	62
SPEAKERS	62
FM/AM TUNER	62
VIDEO and AUDIO	63
REMOTE CONTROLLER	63
OTHER	63
If one of the messages shown below appears	63

Declaration of Conformity

We, ONKYO EUROPE
ELECTRONICS GmbH
INDUSTRIESTRASSE 20
82110 GERMERING,
GERMANY



declare in own responsibility, that the ONKYO product described in this instruction manual is in compliance with the corresponding technical standards such as EN60065, EN55013, EN55020 and EN61000-3-2, -3-3 (or EN60555-2, -3)

GERMERING, GERMANY

A. HORIUCHI

ONKYO EUROPE ELECTRONICS GmbH

Features

Amplifier Features

- 100 Watts minimum of continuous RMS power to each of the five channels into 8 Ω from 20 Hz to 20 kHz with no more than 0.08% THD (North American models, FTC rated)
- 130 Watts minimum of continuous RMS power to each of the five channels into 6 Ω at 1 kHz (European models, DIN)
- Wide Range Amplifier Technology (WRAT)
- DVD-Audio Capability
- Zone-2 Capability
- State-of-the-art linear PCM 96 kHz/24-bit DACs for all channels
- Fully discrete output stages for all five channels
- Tone control (bass, treble) for front L/R speakers

Audio/Video Features

- Dolby®* Digital, DTS®, Dolby Pro Logic II decoding
- Non-Scaling Configuration
- 2 Component-Video Inputs/1 Output
- Y/C Composite signal separation
- Cinema Re-EQ™
- Onscreen graphical displays in 7 colors and a superimpose mode
- Smart Scan Navigator with LEDs

- 5.1-Channel input
- 4 Assignable digital inputs (2 coaxial, 2 optical)
- 5 S-video inputs and 5 A/V inputs
- Rec out selector (sound)
- 7 Sets of heavy-duty multiway speaker binding posts (dual banana-plug compatible)

FM/AM Tuner Features

- 40 FM/AM random presets
- FM auto tuning
- RDS (European models only) with PS, PTY, RT, TP

Other Performance Features

- IntelliVolume
- 3-Mode display dimmer
- Battery-free memory backup
- Powerful backlit/ programmed learning remote with macro and mode-key LEDs

- * Manufactured under license from Dolby Laboratories. "Dolby", "Pro Logic" and the double-D symbol are trademarks of Dolby Laboratories. Confidential Unpublished Works. ©1992-1997 Dolby Laboratories, Inc. All rights reserved.
- Re-Equalization and the "Re-EQ" logo are trademarks of Lucasfilm Ltd. Manufactured under license of Lucasfilm Ltd.
 - Manufactured under license from Digital Theater Systems, Inc. US Pat. No.5,451,942 and other worldwide patents issues and pending. "DTS" and "DTS Digital Surround" are trademarks of Digital Theater Systems, Inc.© 1996 Digital Theater Systems, Inc. All rights reserved.

Supplied accessories

Check that the following accessories are supplied with the TX-DS696.

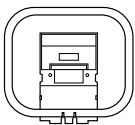

AM loop antenna × 1

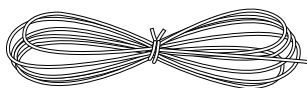

FM indoor antenna × 1
(connector will vary depending on model specifications)

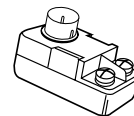

75/300 Ω antenna adapter × 1
(For all models other than USA, Canadian and European models)

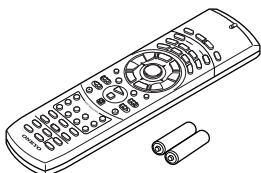

Remote controller × 1
Batteries (AA, R6 or UM-3) × 2

Before using this unit

Setting the Voltage selector (Worldwide models only)

Worldwide models are equipped with a voltage selector to conform with local power supplies. Be sure to set this switch to match the voltage of the power supply in your area before plugging in the unit. Determine the proper voltage for your area: 220-230 V or 120 V. If the preset voltage is not correct for your area, insert a screwdriver into the groove in the switch. Slide the switch all the way to the upper (120 V) or to the lower (220-230 V), whichever is appropriate.

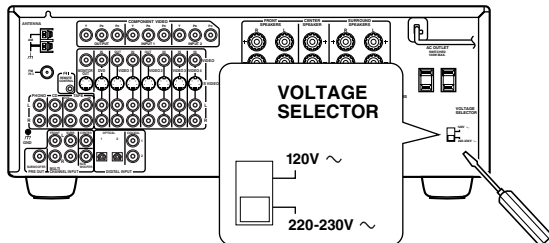

Installing the remote controller batteries

1. Remove the battery compartment cover by pressing and sliding the cover.
2. Insert two AA (R6 or UM-3) batteries into the battery compartment. Carefully follow the polarity diagram (positive (+) and negative (-) symbols) inside the battery compartment.
3. After batteries are installed and seated correctly, replace the compartment cover.

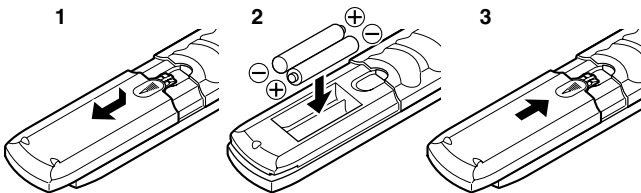

Notes:

- Do not mix new batteries with old batteries or different kinds of batteries.
- To avoid corrosion, remove the batteries if the remote controller is not to be used for a long time.
- Remove dead batteries immediately to avoid damage from corrosion. If the remote controller does not operate smoothly, replace both the batteries at the same time.
- The life of the batteries supplied is about six months but this will vary depending on usage.

Using the remote controller

Point the remote controller toward the remote control sensor. The STANDBY indicator lights up when the unit receives a signal from the remote controller.

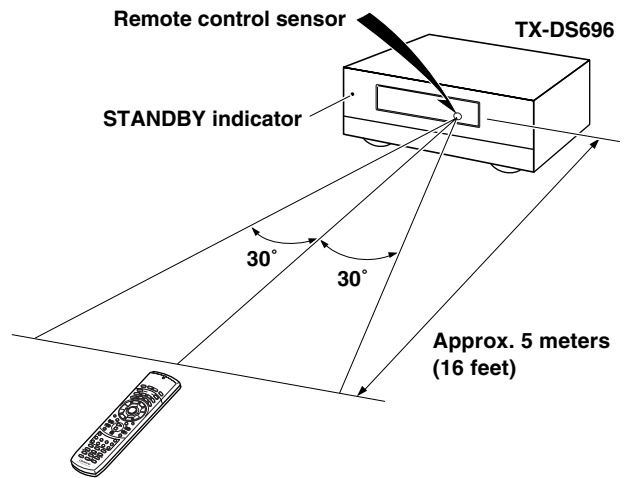

Notes:

- Place the unit away from strong light such as direct sunlight or inverted fluorescent light which can prevent proper operation of the remote controller.
- Using another remote controller of the same type in the same room or using the unit near equipment which uses infrared rays may cause operational interference.
- Do not put objects on the remote controller. Its buttons may be pressed by mistake and drain the batteries.
- Make sure the audio rack doors do not have colored glass. Placing the unit behind such doors may prevent proper remote controller operation.
- If there is any obstacle between the remote controller and the remote control sensor, the remote controller will not operate.

Front panel facilities

Here is an explanation of the controls and displays on the front panel of the TX-DS696.

Front panel

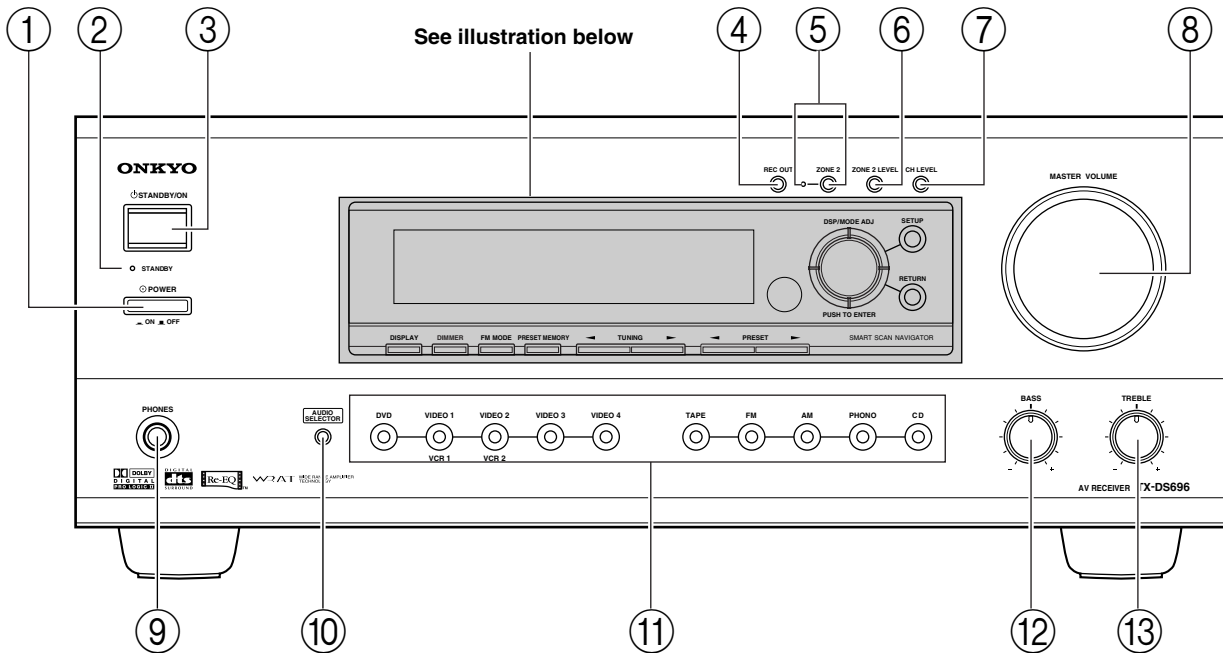

For European model

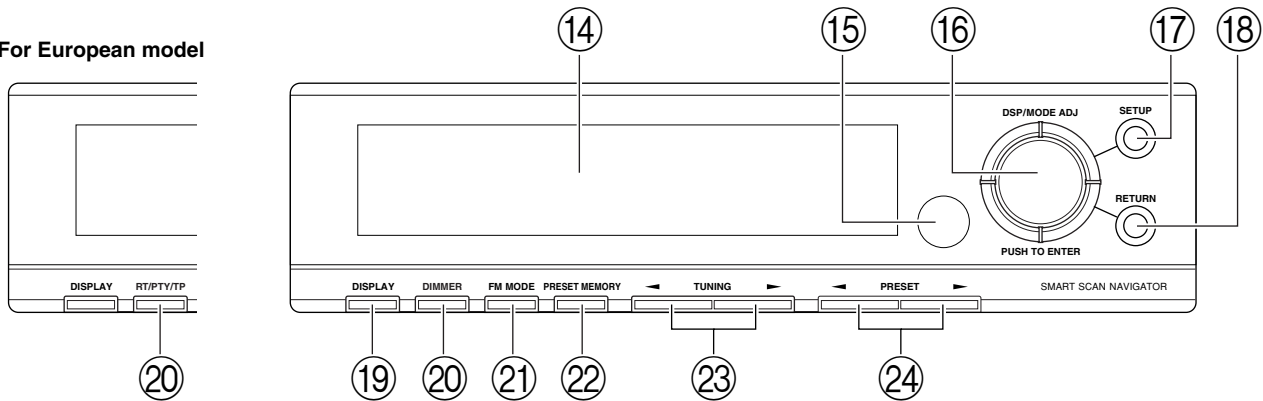

Front panel display

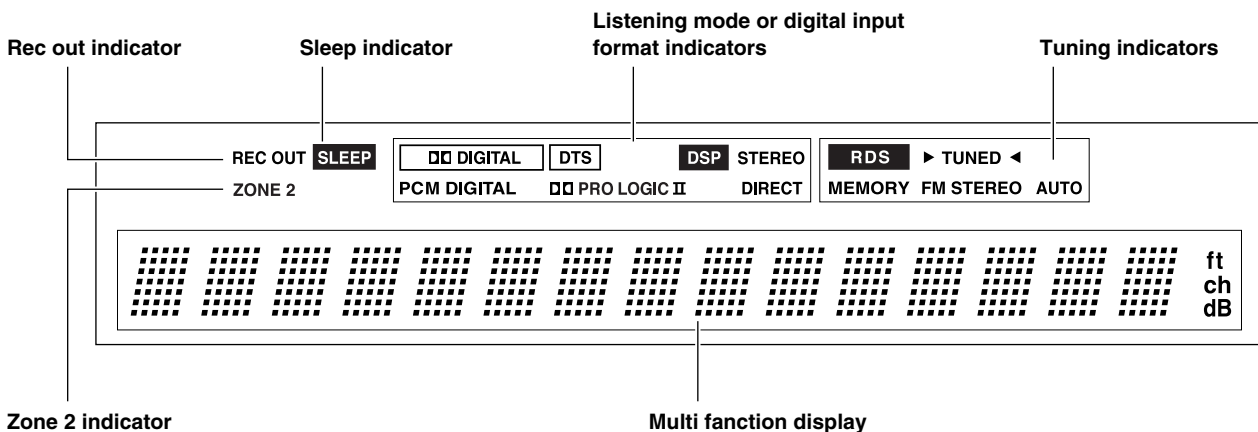

Front panel facilities

For operational instructions, see page indicated in brackets [].

- ① **POWER switch [19]**
Turns on and off the main power supply for the TX-DS696.
- ② **STANDBY indicator [7, 19]**
Lights when the TX-DS696 is in the standby state and flashes when a signal is received from the remote controller.
- ③ **STANDBY/ON button [19]**
Press to turn on the TX-DS696 when in the standby state. Press again to return the TX-DS696 to the standby state.
- ④ **REC OUT button [44]**
Press the REC OUT button to output the audio signals to a recording component for recording purposes.
- ⑤ **ZONE 2 button [45] and indicator**
Press the ZONE 2 button to enjoy the output from the TX-DS696 in a different room, which is referred to as a remote zone (Zone 2).
ZONE 2 indicator lights when a signal is output to the remote zone (Zone 2). When the ZONE 2 indicator is off, then either output to the remote zone is turned off or Rec Out is selected.
- ⑥ **ZONE 2 LEVEL button [45]**
Press to enter the mode for adjusting the volume in the remote zone (Zone 2).
- ⑦ **CH LEVEL button [30]**
Press to select the channel whose level is to be adjusted.
- ⑧ **MASTER VOLUME dial [29, 31]**
The MASTER VOLUME dial is used to control the volume for the main zone. The volume for the remote zone (Zone 2) is independent.
- ⑨ **PHONES jack [29]**
This is a standard stereo jack for connecting stereo headphones.
- ⑩ **AUDIO SELECTOR button [31]**
This button is used to select the type of audio input signal. Each time pressed, the setting cycles from "AUTO" → "Multich" → "Analog" and back.
- ⑪ **Input source buttons (DVD, VIDEO 1–4, TAPE, FM, AM, PHONO, and CD) [25, 26, 28, 29, 44, 45]**
These buttons are used to select the input source for the main zone. To select the input source for the remote zone (Zone 2) or recording out (Rec Out), first press the Zone 2 or Rec Out button, and then the desired input source button.
- ⑫ **BASS dial [31]**
Boosts or cuts the bass response. Bass adjustment is effective only for the front speakers and headphones.
- ⑬ **TREBLE dial [31]**
Boosts or cuts the treble response. Treble adjustment is effective only for the front speakers and headphones.
- ⑭ **Front display**

- ⑮ **Remote control sensor [7]**
- ⑯ **SMART SCAN NAVIGATOR jog dial and indicators [22-24, 26, 28, 30, 31, 33, 35, 45]**
Used to make settings in the Setup menu, change listening mode settings, and more.
- ⑰ **SETUP button [22-24, 35]**
Press to bring up the Setup menu. The OSD menu will appear on the TV monitor as well as the front display on the TX-DS696.
- ⑱ **RETURN button [22-24, 35]**
Press to exit the Main menu level or go back one level up.
- ⑲ **DISPLAY button [30]**
The DISPLAY button is used to display information about the current input source signal. Each time you press the display button, the screen changes to show you different information concerning the input signal.
- ⑳ **RT/PTY/TP (European models only) button [28]**
This button is only available on European models. Use this button to help tune into the Radio Data System (RDS) for FM broadcasting. RDS was developed within the European Broadcasting Union (EBU) and is available in most European countries. Each time the button is pressed, the display changes from RT (radio text) to PTY (program type) to TP (traffic program) and then back to RT again.
- ㉑ **DIMMER (other than European models) button [30]**
Press to set the brightness of the front display. There are 3 settings available: normal, dark, and very dark.
- ㉒ **FM MODE button [25]**
If you are listening to an FM radio station in stereo and the sound cuts out or there is a great deal of noise, switch from STEREO to MONO. Each time this button is pressed, the AUTO indication flashes and the stereo mode changes from AUTO to MONO and vice versa. This button also turns on and off the FM MUTE.
- ㉓ **PRESET MEMORY button [26]**
This button is used to assign the radio station that is currently tuned in to a preset channel or delete a previously preset station.
- ㉔ **TUNING ◀/▶ buttons [25]**
Use these buttons to change the tuner frequency. The tuner frequency is displayed in the front display and it can be changed in 50 kHz increments for FM and 10 kHz (or 9 kHz) increments for AM.
When FM is selected, you can hold down one of the tuning buttons and then release it to activate the auto-search feature. It will search for a station in the direction of the button you pressed and stop when it tunes into one.
- ㉕ **PRESET ◀/▶ buttons [26]**
When AM or FM is selected as the input source, press one of these buttons to jump to a radio station that you preset using the PRESET MEMORY button. Pressing the right button moves from the most recently preset station to older ones, and pressing the left button moves in the reverse order.

Remote controller

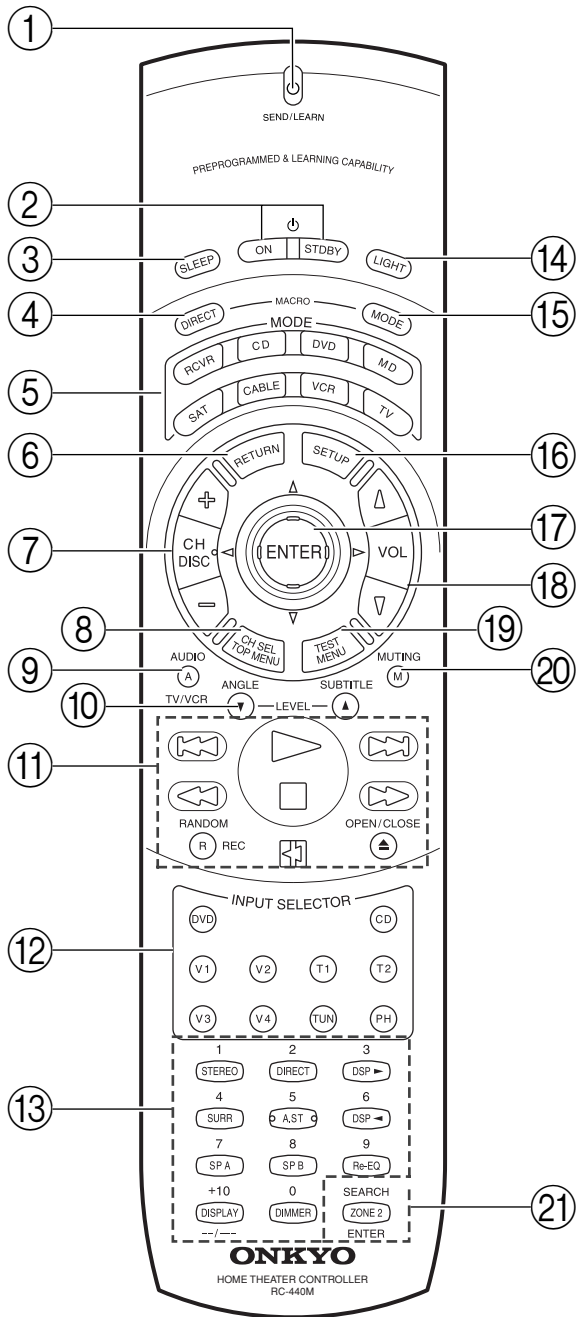

① SEND/LEARN indicator [50, 54, 56]

This indicator acts as a guide when commands are programmed into or sent by the remote controller. It also warns the user when an error is made or battery power is low.

② ON/STDBY button [19, 47-50, 52, 53, 60]

ON: Turns on the TX-DS696.

STDBY: Places the TX-DS696 in the standby state.

Be aware that pressing the STDBY button only places the TX-DS696 in standby and does not turn the power completely off.

③ SLEEP button [30]

Sets the sleep function.

The SLEEP button enables you to set the TX-DS696 to turn off automatically after a specified time period.

④ DIRECT MACRO button [58, 59]

For executing and programming the Direct Macro function.

⑤ MODE buttons and indicators [19, 26, 46-59]

For selecting the component to be operated by the remote controller. When a MODE button is pressed, it will light green for 8 seconds. The selected MODE button will also light whenever any other operation button is pressed to tell you which mode the remote controller is in.

⑥ RETURN button [35, 48]

For entering the selected setting and returning to the previous menu.

⑦ CH/DISC +/- button [26, 46-48, 52, 53]

When in the RCVR mode, for selecting a tuner preset channel.

For selecting the disc to be played back for components with disc changers when in the DVD or CD modes.

⑧ CH SEL/TOP MENU button

CH SEL: For selecting the speaker for level adjustment when in the RCVR mode. Used together with the LEVEL ▲/▼ buttons. [30]

TOP MENU: When in the DVD mode, for displaying the menu screen(s) recorded on DVD media. [48]

⑨ AUDIO/A/TV/VCR button

AUDIO/A: For selecting the audio input signal. The setting changes from "AUTO" to "Multich" to "Analog" and back each time this button is pressed. [31, 48]

TV/VCR: Must be preprogrammed for use in the TV and VCR modes. [53]

⑩ LEVEL ▼/ANGLE and LEVEL ▲/SUBTITLE buttons

LEVEL ▼/▲: Select the speaker whose volume is to be adjusted using the CH SEL button and adjust the volume using the LEVEL ▲/▼ buttons in the RCVR mode. [30]

ANGLE: When in the DVD mode, for selecting a camera angle when a DVD-Video is recorded with multiple angle playback. [48]

SUBTITLE: When in the DVD mode, for selecting one of the subtitle languages recorded on a DVD-Video. [48]

⑪ CD/TAPE/DVD/MD operation buttons [46-48, 53]

For operating Onkyo components connected to the TX-DS696.

Remote controller

⑫ INPUT SELECTOR buttons [26, 29, 45, 46, 49]

Selects an input source.

Same as the input selector buttons on front panel of the TX-DS696. The input source for each buttons is given here. DVD:DVD, CD:CD, V1:VIDEO1, V2:VIDEO2, V3:VIDEO3, V4:VIDEO4, T1:TAPE, T2:Not used with the TX-DS696, TUN:FM/AM, PH:PHONO.

⑬ Numeric key/Listening mode selector/SP A, B/ Re-EQ/DISPLAY/DIMMER buttons

1 to 9, +10, --/--, 0: For entering the number of a track. [47-50, 52, 53]

STEREO, DIRECT, DSP ◀▶, SURR, A.ST: You can select a listening mode. [33]

Re-EQ: Depending on the listening mode, you can turn the cinema re-equalization function on or off. [33]

SP A, SP B: Not used with the TX-DS696.

DISPLAY: For changing the display in the front display. [30, 50]

DIMMER: Adjusts the display brightness.

There are three settings available: normal, dark and very dark. [30]

⑭ LIGHT button

For illuminating the buttons of the remote controller.

This is button is useful when using the remote controller in dark locations. When pressed, the buttons on the remote controller light green.

The button for the mode currently selected lights brighter than the rest.

⑮ MODE MACRO button [57, 59]

For executing and programming the Macro function.

⑯ SETUP button [35]

For displaying and quitting the Setup menu.

⑰ ENTER/cursor button [35, 48]

When selecting items in the Setup menu, press the upper and lower portions to select item, press the right and left portions to select parameter values or modes, and press ENTER to select item.

⑱ VOL ▲/▼ button [29, 31, 46-49, 52, 53]

For adjusting the volume.

⑲ TEST/MENU button

TEST: Outputs a test tone for setting speaker levels.

Use this button in conjunction with the LEVEL ▲/▼ and CH SEL buttons to calibrate the speakers levels without entering the Setup menu. When TEST button is pressed, the test noise (pink noise) is output. Use the LEVEL ▲/▼ buttons to increase or decrease the sound level. Use the CH SEL button to change from speaker to speaker. For a more detailed explanation of how to calibrate the speaker levels, see page 24.

MENU: When in the DVD mode, this button displays the DVD menu. [48, 52]

⑳ MUTING/M button [29, 46-49, 52, 53]

Activates the mute function.

㉑ ZONE 2/SEARCH/ENTER button

ZONE 2: When in the RCVR mode, press this button to perform operations on the remote zone (Zone 2). [45]

SEARCH: When in the DVD mode, for finding the specific section on a disc where you want to start playback. [48]

ENTER: When in the MD mode, for confirming the selection. [49, 52-54, 56, 60]

Connections

Here is explanation of how to connect the main components to the TX-DS696 in the standard manner. There are many ways that any one component can be connected, and it is up to you to decide which method best fits your situation. The directions given here are only one option and should only be thought of as such. It is best to fully understand the nature of each connector and terminal as well as each of your components and their features to ascertain which method of connection is best.

- Be sure to always refer to the instructions that came with the component that you are connecting.
- Do not plug in the power cord until all connections have been made.
- For input jacks, red connectors (marked R) are used for the right channel, white connectors (marked L) are used for the left channel, and yellow connectors (marked V) are used for video connection.
- Do not bind audio/video connection cables with power cords and speaker cables. Doing so may adversely affect the picture and sound quality.
- When using the digital inputs, make sure to also connect the analog connections whenever possible.

- Insert all plugs and connectors securely. Improper connections can result in noise, poor performance, or damage to the equipment.

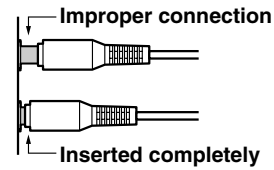

- When using one of the optical input jacks, remove the protective cap and keep it safely. When the jack is not used, replace the protective cap.
- When using an optical input jack, always use an optical fiber cable.

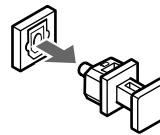

Optical digital input terminal

An optical digital input terminal is equipped with a protection cap. When connecting, remove this cap. When not using, put the cap back on the terminal.

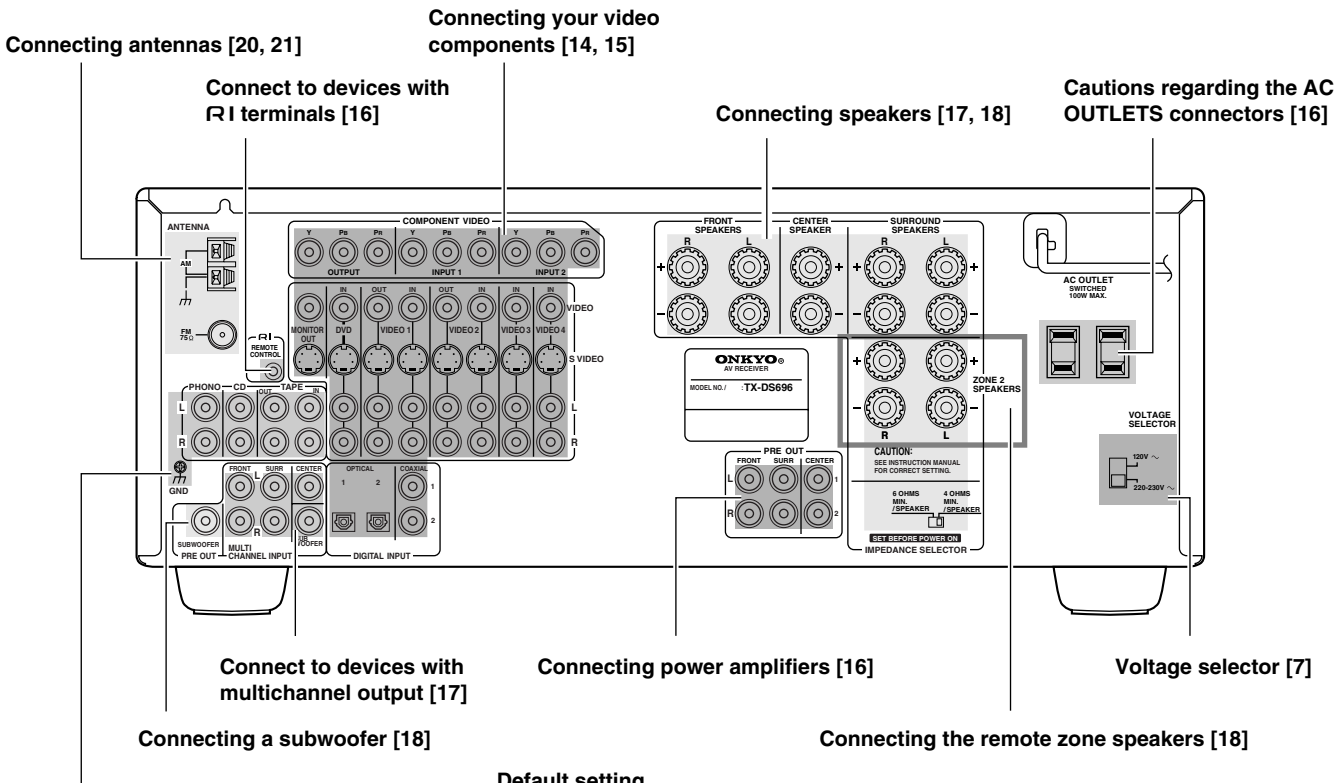

Connecting your audio components [13]

Default setting

Input source	Digital input	Component video	Multichannel
DVD	COAX 1	INPUT 1	Yes
VIDEO 1	COAX 2	INPUT 2	No
VIDEO 2	----	INPUT 1	No
VIDEO 3	OPT 2	INPUT 1	No
VIDEO 4	----	INPUT 1	No
TAPE	----		No
FM			
AM			
PHONO	----		No
CD	OPT 1		No

COAX: Coaxial OPT: Optical ----: No setting : Not applicable

Connections

 : Signal flow

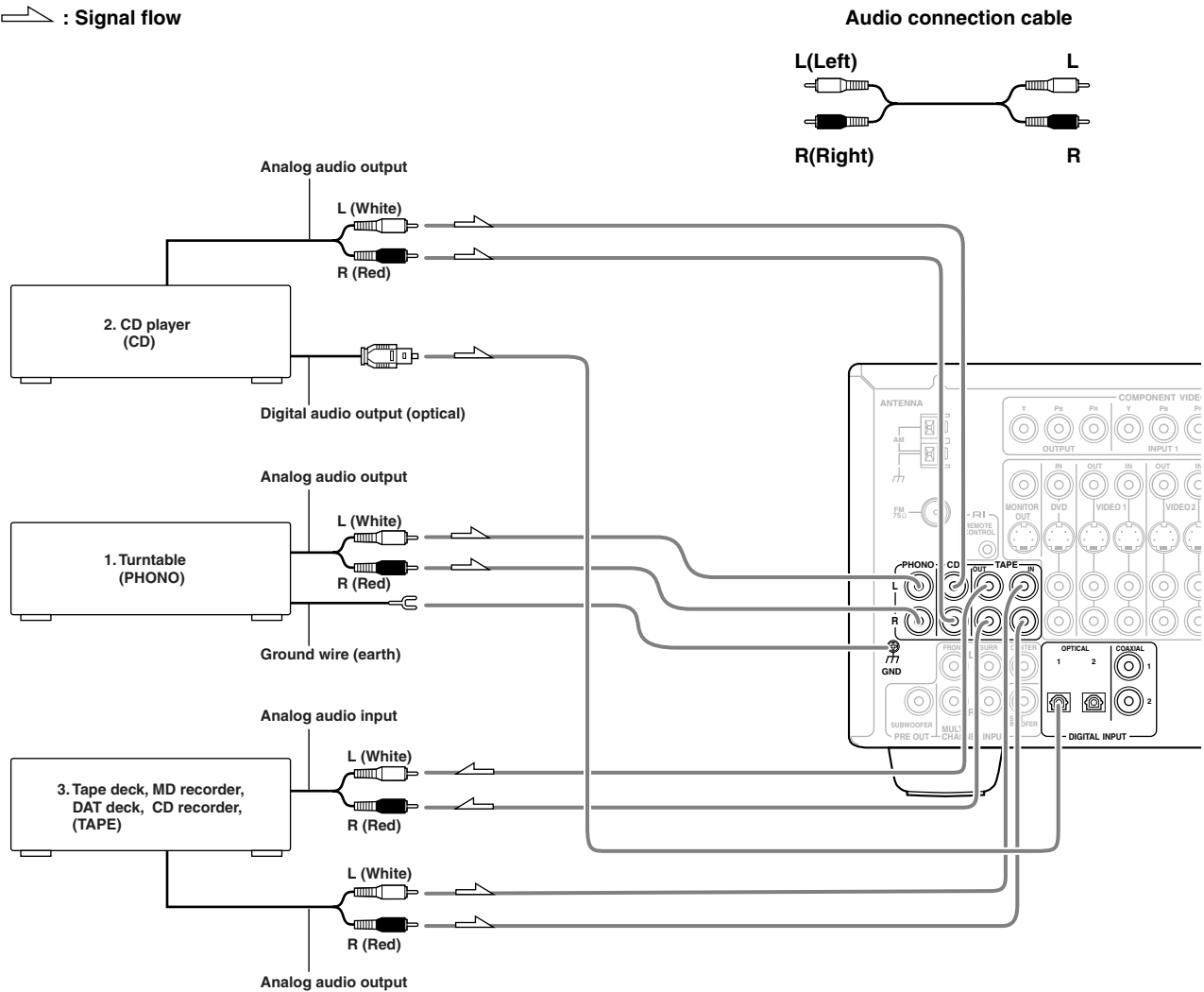

Connecting your audio components

Below is an example of how you can connect your audio components to the TX-DS696. Refer to the diagram above for the following connection examples.

1. Connecting a turntable (PHONO)

Using an RCA-type audio connection cable, connect the output terminal on the turntable to the PHONO input jacks on the TX-DS696. Make sure that you properly connect the left channel to the L jack and the right channel to the R jack.

Note:

The TX-DS696 is designed for use with moving magnet cartridges. For proper operation, connect a ground (or earth) wire to the GND terminal. For some turntables, however, connecting the ground wire may cause increased noise, and in such a case, a ground wire is not necessary and should not be connected.

2. Connecting a compact disc player (CD)

Using an RCA-type audio connection cable, connect the output terminal on the compact disc player to the CD input jacks on the TX-DS696. Make sure that you properly connect the left channel to the L jack and the right channel to the R jack.

If the compact disc player has a digital output jack as well, be sure to also connect it to either a DIGITAL INPUT (COAXIAL) or DIGITAL INPUT (OPTICAL) jack on the TX-DS696 depending on the type of connector on the compact disc player.

With the initial settings of the TX-DS696, the CD input source is set for digital input at the OPTICAL 1 jack.

If the digital connection is made at a different jack, this must be changed at the Setup menu: Input Setup → Audio Setup → Digital Input (see pages 24, 39).

3. Connecting a cassette tape deck, MD recorder, DAT deck, or CD recorder (TAPE)

Using an RCA-type audio connection cable, connect the output terminals (PLAY) of the device to the TAPE IN jacks on the TX-DS696 and the input terminals (REC) to the TAPE OUT jacks. Make sure that you properly connect the left channel to the L jack and the right channel to the R jack.

If the device has a digital output jack as well, be sure to also connect it to either a DIGITAL INPUT (COAXIAL) or DIGITAL INPUT (OPTICAL) jack on the TX-DS696 depending on the type of connector on the device.

With the initial settings of the TX-DS696, the TAPE input source is set for no digital input.

If you connect the device to the DIGITAL INPUT terminal, then this input source must be set for digital input at the Setup menu: Input Setup → Audio Setup → Digital Input (see pages 24, 39).

Connections

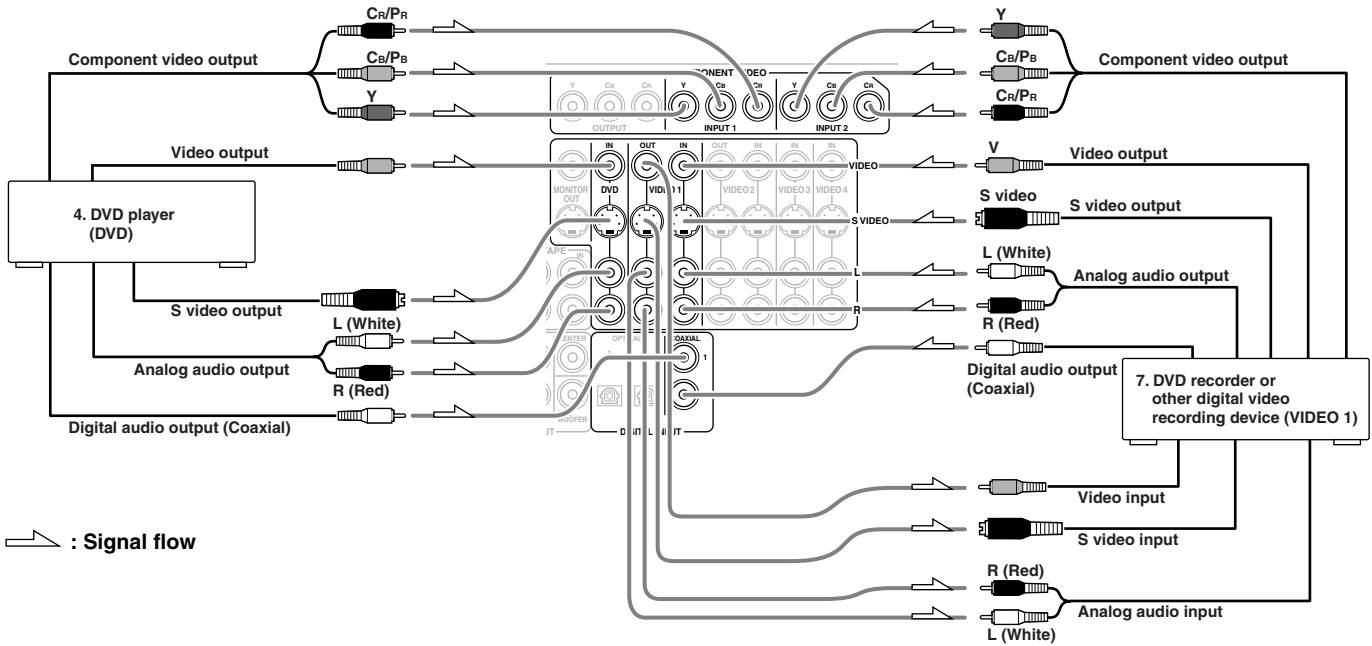

➔ : Signal flow

Audio connection cable

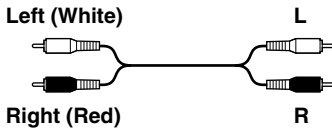

Video connection cable

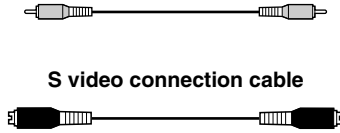

Component video connection cable

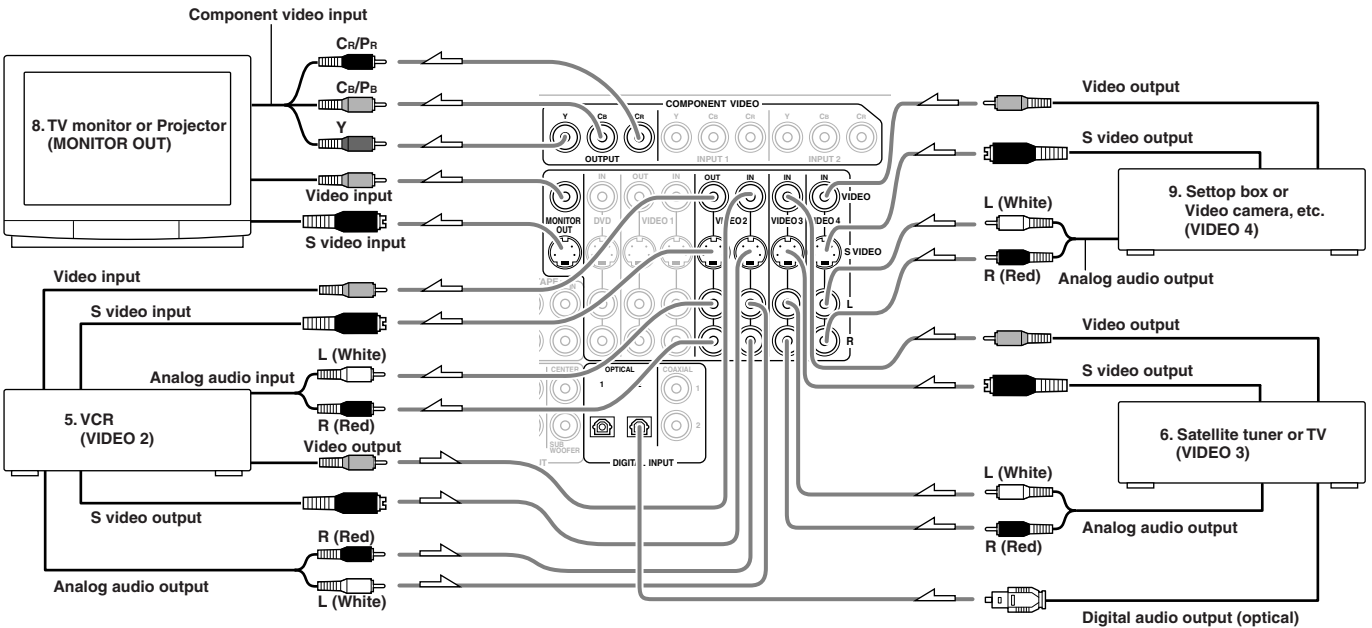
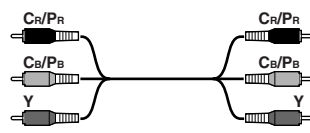

Connecting your video components

Below is an example of how you can connect your video components to the TX-DS696. Refer to the diagram above for the following connection examples.

The flow of the video signals is as follows:

- The signal that comes in from VIDEO IN is sent to VIDEO OUT and S VIDEO OUT.
- The signal that comes in from S VIDEO IN is sent to S VIDEO OUT and VIDEO OUT.
- The signal that comes in from COMPONENT VIDEO IN is only sent to COMPONENT VIDEO OUT.

4. Connecting a DVD player (DVD)

If the device is equipped with an S video output terminal, connect it to the DVD S VIDEO IN terminal with an S video cable. If it does not have an S video output terminal, connect its video output terminal to the DVD VIDEO IN terminal using an RCA-type video connection cable. You do not need to connect to both the DVD S VIDEO IN and DVD VIDEO IN terminals. If the device has component video outputs, connect them to one of the COMPONENT VIDEO INPUT jacks.

With the initial settings of the TX-DS696, the DVD input source is set for the COMPONENT VIDEO INPUT 1 jack.

Connections

If the video connection is made at COMPONENT VIDEO INPUT 2, this must be changed at the Setup menu: Input Setup → Video Setup → Component Video (see pages 24, 39).

Using an RCA-type audio connection cable, connect the audio output terminal on the device to the audio DVD IN jacks on the TX-DS696. Make sure that you properly connect the left channel to the L jack and the right channel to the R jack.

If the device has a digital output jack as well, be sure to also connect it to either a DIGITAL INPUT (COAXIAL) or DIGITAL INPUT (OPTICAL) jack on the TX-DS696 depending on the type of connector on the DVD player.

With the initial settings of the TX-DS696, the DVD input source is set for digital input at the COAXIAL 1 jack.

If the digital connection is made at a different jack, this must be changed at the Setup menu: Input Setup → Audio Setup → Digital Input (see pages 24, 39).

5. Connecting a video cassette recorder (VIDEO 2)

If the video cassette recorder is equipped with an S video output terminal, connect it to the S VIDEO 2 IN terminal with an S video cable. If it does not have an S video output terminal, connect its video output terminal to the VIDEO 2 IN terminal using an RCA-type video connection cable. You do not need to connect to both the S VIDEO 2 IN and VIDEO 2 IN terminals. If the video cassette recorder has component video outputs, connect them to one of the COMPONENT VIDEO INPUT jacks.

With the initial settings of the TX-DS696, the VIDEO 2 input source is set for the COMPONENT VIDEO INPUT 1 jack.

If the video connection is made at COMPONENT VIDEO INPUT 2, this must be changed at the Setup menu: Input Setup → Video Setup → Component Video (see pages 24, 39).

Using an RCA-type audio connection cable, connect the audio output terminal on the video cassette recorder to the same VIDEO 2 IN audio jacks on the TX-DS696 and audio input terminal to the VIDEO 2 OUT audio jacks. Make sure that you properly connect the left channel to the L jack and the right channel to the R jack.

6. Connecting a satellite tuner or television (VIDEO 3)

If the satellite tuner or television is equipped with an S video output terminal, connect it to the S VIDEO 3 IN terminal with an S video cable. If it does not have an S video output terminal, connect its video output terminal to the VIDEO 3 IN terminal using an RCA-type video connection cable. You do not need to connect to both the S VIDEO 3 IN and VIDEO 3 IN terminals. If the satellite tuner or television has component video outputs, connect them to one of the COMPONENT VIDEO INPUT jacks.

With the initial settings of the TX-DS696, the VIDEO 3 input source is set for the COMPONENT VIDEO INPUT 1 jack.

If the video connection is made at COMPONENT VIDEO INPUT 2, this must be changed at the Setup menu: Input Setup → Video Setup → Component Video (see pages 24, 39).

Using an RCA-type audio connection cable, connect the audio output terminal on the satellite tuner or television to the same VIDEO 3 IN audio jacks on the TX-DS696. Make sure that you properly connect the left channel to the L jack and the right channel to the R jack.

If the satellite tuner or television has a digital output jack as well, be sure to also connect it to either a DIGITAL INPUT (COAXIAL) or DIGITAL INPUT (OPTICAL) jack on the TX-DS696 depending on the type of connector on the set top box or television.

With the initial settings of the TX-DS696, the VIDEO 3 input source is set for digital input at the OPTICAL 2 jack.

If the digital connection is made at a different jack, this must be changed at the Setup menu: Input Setup → Audio Setup → Digital Input (see pages 24, 39).

7. Connecting a DVD recorder or other digital video recording device (VIDEO 1)

If the device is equipped with an S video output terminal, connect it to the S VIDEO 1 IN terminal with an S video cable. If it does not have an S video output terminal, connect its video output terminal to the VIDEO 1 IN terminal using an RCA-type video connection cable. You do not need to connect to both the S VIDEO 1 IN and VIDEO 1 IN terminals. If the device has component video outputs, connect them to one of the COMPONENT VIDEO INPUT jacks.

With the initial settings of the TX-DS696, the VIDEO 1 input source is set for the COMPONENT VIDEO INPUT 2 jack.

If the video connection is made at COMPONENT VIDEO INPUT 1, this must be changed at the Setup menu: Input Setup → Video Setup → Component Video (see pages 24, 39).

Using an RCA-type audio connection cable, connect the audio output terminal on the device to the same VIDEO 1 IN audio jacks on the TX-DS696 and audio input terminal to the VIDEO 1 OUT audio jacks. Make sure that you properly connect the left channel to the L jack and the right channel to the R jack.

If the device has a digital output jack as well, be sure to also connect it to either a DIGITAL INPUT (COAXIAL) or DIGITAL INPUT (OPTICAL) jack on the TX-DS696 depending on the type of connector on the device.

With the initial settings of the TX-DS696, the VIDEO 1 input source is set for digital input at the COAXIAL 2 jack.

If the digital connection is made at a different jack, this must be changed at the Setup menu: Input Setup → Audio Setup → Digital Input (see pages 24, 39).

8. Connecting a television monitor or projector (MONITOR OUT)

The TX-DS696 is equipped with a simple Y/C separate circuit and simple Y/C mixed circuit. Since both the signal from the S VIDEO and VIDEO inputs are output to the MONITOR OUT S VIDEO output, if the television or projector is equipped with an S video input, it is unnecessary to connect the video connectors. If it is equipped with only a video input, connect it to the MONITOR OUT VIDEO output.

If the monitor or projector is equipped with an S video output terminal, connect it to the MONITOR OUT S VIDEO terminal with an S video cable. If it does not have an S video output terminal, connect its video output terminal to the MONITOR OUT VIDEO terminal using an RCA-type video connection cable. You do not need to connect to both the MONITOR OUT S VIDEO and MONITOR OUT VIDEO terminals. If the device has component video inputs, connect them to the COMPONENT VIDEO OUTPUT jacks.

Caution:

Note that the Setup menu will only be displayed on the monitor connected to MONITOR OUT and not those connected to the COMPONENT VIDEO OUTPUT jacks.

9. Connecting setup box or video camera, etc. (VIDEO 4)

If the device is equipped with an S video output terminal, connect it to the S VIDEO 4 IN terminal with an S video cable. If it does not have an S video output terminal, connect its video output terminal to the VIDEO 4 IN terminal using an RCA-type video connection cable. You do not need to connect to both the S VIDEO 4 IN and VIDEO 4 IN terminals.

Connections

Connect to devices with **RI** terminals

The **RI** terminal on the TX-DS696 is for connecting other Onkyo components equipped with the same **RI** terminal. When a component are **RI**-connected, you can point the remote controller supplied with the TX-DS696 at the sensor on the TX-DS696 and operate that component without having to switch remote controllers. In addition, by connecting components to the **RI** terminal, you can also perform the system operations given below.

Power on/ready function

When the TX-DS696 is in the standby state, if an **RI**-connected component is turned on, then the TX-DS696 also turns on and the input source selected at the TX-DS696 automatically switches to that component.

If the power cord for an **RI**-connected component is connected to the AC OUTLET on the TX-DS696, or if the TX-DS696 is turned on, this function will not work. Also, if you are using the TX-DS696 for the remote zone (Zone 2), this function will not work.

Direct change function

When the play button is pressed at an **RI**-connected component, the input source selected at the TX-DS696 automatically changes to that component. However, if you are using the TX-DS696 for the remote zone (Zone 2), this function will not work.

Power off function

When the TX-DS696 is placed in the standby state, all **RI**-connected components are also automatically put into the standby state.

CAUTION

If an MD recorder is connected to the TAPE jack on the TX-DS696, switch the Input Selector from TAPE to MD (see page 19).

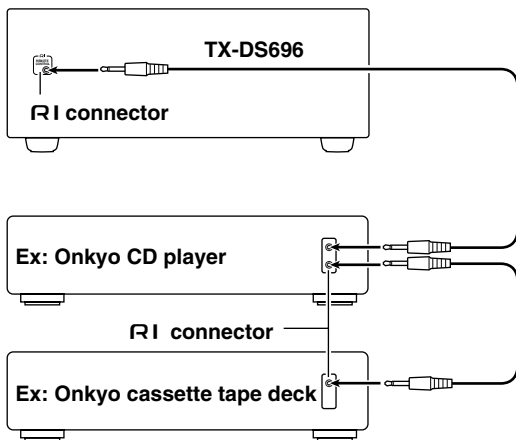

To connect components using the **RI** terminal, simply connect a remote control cable from this **RI** terminal to the **RI** terminal of the other component. An **RI** remote control cable with a 1/8-inch (3.5-mm) miniature two-conductor plug comes with every cassette tape deck, compact disc player, MD recorder, and DVD player that has an **RI** terminal.

- For remote control operation, the audio connection cables must also be connected.
- The RC-440M remote controller does not support turntables.
- If a component has two **RI** terminals, you can use either one to connect to the TX-DS696. The other one can be used to daisy chain with another component.
- With Onkyo DVD players, you can enter the pre-program code so that you can operate the DVD player directly with the remote controller without connecting the **RI** terminals (see page 50).

Cautions regarding the AC OUTLETS connectors

The TX-DS696 is supplied with AC mains outlets for connecting the power cords from other devices so that their power is supplied through the TX-DS696. By doing this, you can use the STANDBY/ON button on the TX-DS696 to turn on and off the connected devices as well.

The shape, number, and total capacity of the AC outlets may differ depending on the area of purchase.

Caution:

Make sure that the total capacity of the other components connected to this unit does not exceed the capacity that is printed on the rear panel (e.g., 120 watts).

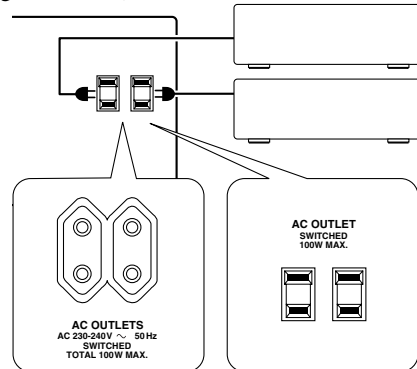

ex. European and some Asian models

ex. USA and Canadian models

Connecting power amplifiers

Using auxiliary power amplifiers allows you to listen at louder volumes than with the TX-DS696 alone. If power amplifiers are used, connect each speaker to the corresponding power amplifier.

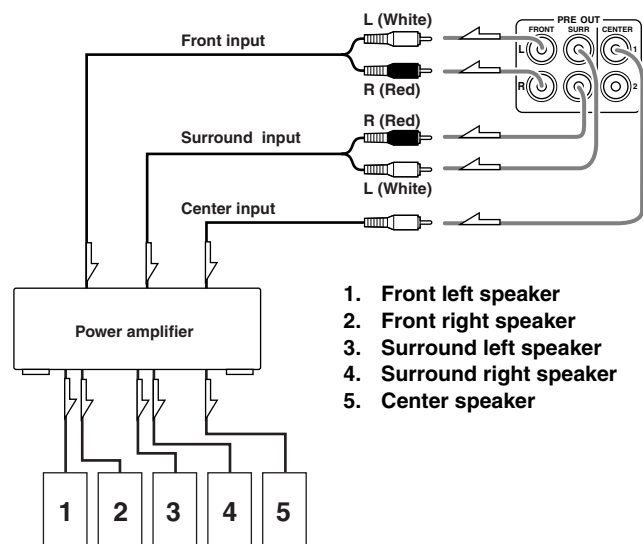

1. Front left speaker
2. Front right speaker
3. Surround left speaker
4. Surround right speaker
5. Center speaker

Connections

Connect to devices with multichannel output

By connecting a DVD player, MPEG decoder, or other component that has a multi channel port, you can playback the audio with 5.1 channel output. So, be sure to prepare a cable that can properly connect the TX-DS696 to the peripheral device.

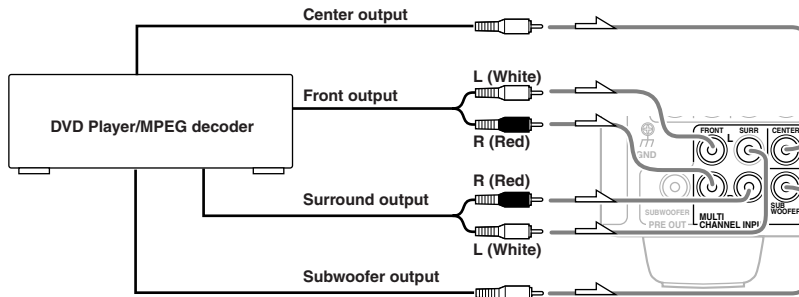

Connecting speakers

Positioning speakers

Speaker placement plays an important role in the reproduction of Surround sound. The placement of the speakers varies depending on the size of the room and the wall coverings used in the room. The illustration shows an example of a layout for standard speaker placement. Refer to this example when you position the speakers in order to experience the best of Surround sound.

Standard speaker placement

For ideal Surround effects, all speakers should be installed. If a center speaker or subwoofer is not connected, the sound from the unused channel is properly distributed to the connected speakers in order to produce the best Surround sound possible.

Front: The left, right, and center speakers should face the seated listener and be placed at ear level. The center speaker produces a richer sound image by enhancing the perception of the sound's source and movement.

Surround: Place the left and right Surround speakers 3 feet (1 meter) above the listener's ear level and facing toward the sides of the room, making sure that the listener is within the speakers' dispersion angle. These speakers produce the feel of a moving sound while creating the sensation of being in the middle of the action.

Subwoofer: Install a subwoofer with a built-in power amplifier for powerful bass sounds. The placement of the subwoofer does not affect the final quality of the sound image too much, so you can install it with the room layout in mind.

Refer to the speaker's instruction manual for more details.

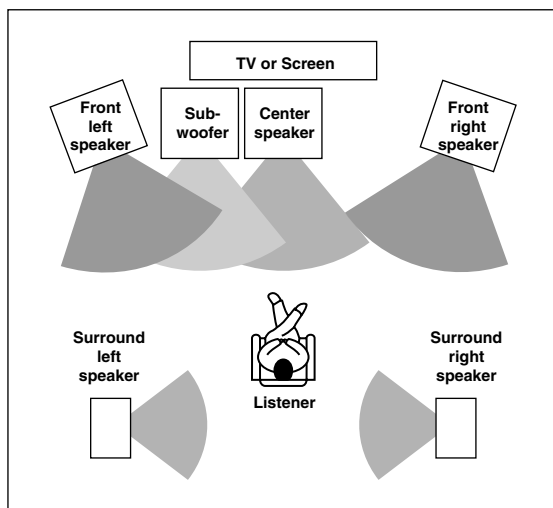

Connecting speakers

Make the connections while referring to the explanations on the next page.

1. Check the impedance of the speakers you are connecting.

The TX-DS696 requires speakers with an impedance of 4 or greater. Connecting speakers with an impedance of less than 4 may damage the TX-DS696.

2. Set the IMPEDANCE SELECTOR switch according to the impedance of the speakers being connected.

If all speakers have an impedance of 6 or greater, slide the IMPEDANCE SELECTOR switch to the left (6 OHMS MIN./SPEAKER). If one or more speakers have an impedance of less than 6, slide the IMPEDANCE SELECTOR switch to the right (4 OHMS MIN./SPEAKER).

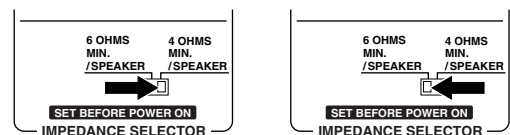

4 or above/speaker

6 or above/speaker

Notes:

- The power to the TX-DS696 must not be turned on when changing the IMPEDANCE SELECTOR setting.

- When you are using only one speaker or when you wish to listen to monaural (mono) sound, a single speaker should never be connected in parallel to both the right and left-channel terminals simultaneously.

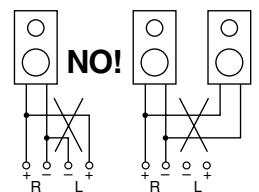

- To prevent damage to circuitry, never short-circuit the positive (+) and negative (-) speaker wire.



- Be sure to connect the positive and negative cables for the speakers properly. If they are mixed up, the left and right signals will be reversed and the audio will sound unnatural.
- Do not connect more than one speaker cable to one speaker terminal. Doing so may damage the TX-DS696.

Connecting speakers

Connecting the speaker cable

1. Strip away 5/8 inch (15 mm) of wire insulation.
2. Twist wire ends very tight.
3. Unscrew
4. Insert wire
5. Screw

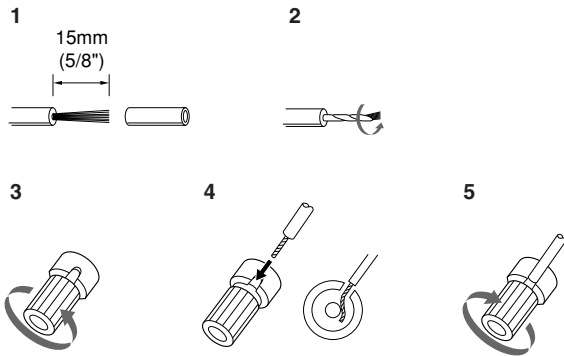

Connecting a subwoofer

Use the PRE OUT SUBWOOFER jack to connect a subwoofer with a built-in power amplifier. If your subwoofer does not have a built-in amplifier, connect an amplifier to the PRE OUT SUBWOOFER jack and the subwoofer to the amplifier.

Connecting the remote zone speakers

The TX-DS696 allows you to connect another set of speakers and place them in a different room or separated area for listening to music. This other room or area is referred to as the remote zone (Zone 2), while the room where the TX-DS696 is located is the main zone. The diagram below shows how to make the proper connections for the remote zone.

Note:

It is important to be aware of the speaker impedance.

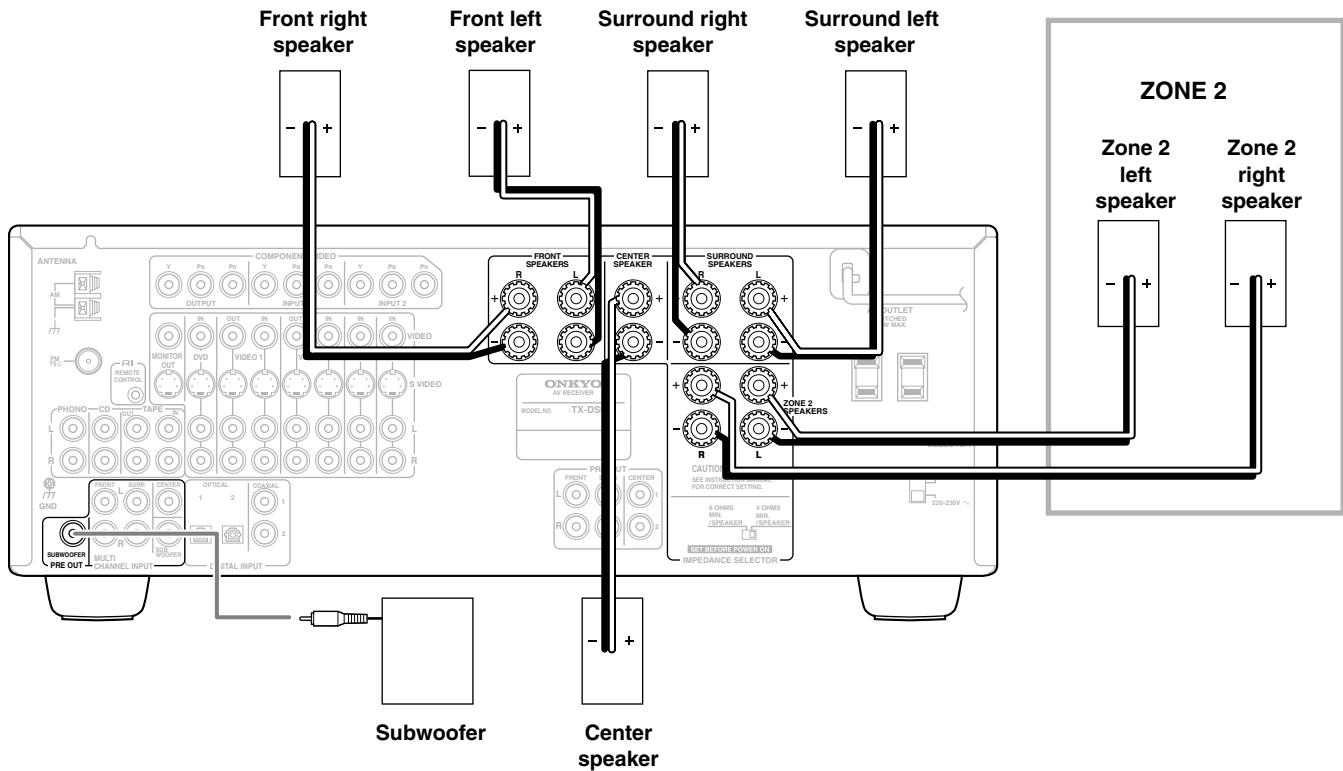

Connecting the power

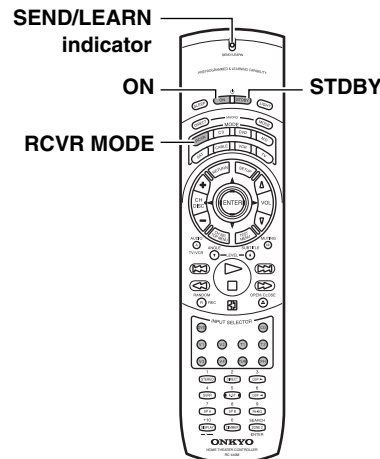
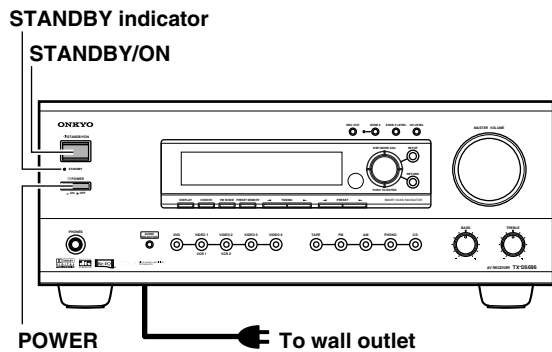

- The TX-DS696 is shipped with the main power (POWER) switch in the on position (ON). When the power cord is plugged in for the first time, the TX-DS696 will automatically enter the standby state and the STANDBY indicator will light (same condition after step 2 below).
- Before you plug in the TX-DS696, confirm that all connections have been made properly.
- Turning on the power may cause a momentary power surge, which might interfere with other electrical equipment on the same circuit, such as computers. If this happens, use a wall outlet on a different circuit.

1. Plug the power cord into an AC wall outlet.

2. Press the POWER switch to set the TX-DS696 to standby state.

The STANDBY indicator will light up.

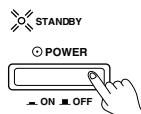

3. Press the STANDBY/ON button to turn on the TX-DS696. The display and four jog dial indicators will light up and the STANDBY indicator will turn off.

If you press the STANDBY/ON button again, the receiver returns to Standby mode.

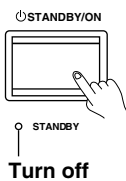

Turning the power on from the remote controller:

Before you can use the remote controller, you must perform steps 1 and 2 above and place the TX-DS696 in the standby state.

1. Press the RCVR MODE button.

The RCVR MODE button lights green.

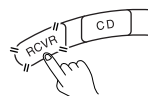

2. Press the ON button to turn on the TX-DS696 (take it out of the standby state).

To return the TX-DS696 to the standby state, press the STDBY button.

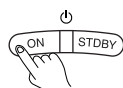

To change the display of the input source from TAPE to MD:

If you connected an MD recorder to the TAPE jack on the TX-DS696, you can have "MD" appear when the TAPE source button is pressed. By changing the display, if an Onkyo MD recorder is connected, the RI system functions will become enabled.

Changing the display:

Press and hold down the TAPE source button until the display changes from TAPE to MD (approx. 3 seconds).

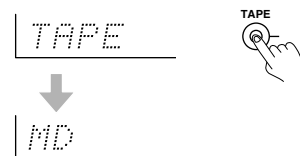

To return the display to its original setting, perform the same procedure. This setting is necessary to allow RI system functions for the connected cassette tape or MD recorder.

Memory preservation

This unit does not require memory preservation batteries. A built-in memory power backup system preserves the contents of the memory during power failures and even when the POWER switch is set to off. The POWER switch must be set to on in order to charge the backup system.

The memory preservation period after the unit has been turned off varies depending on climate and placement of the unit. On the average, memory contents are protected over a period of a few weeks after the last time the unit has been turned off. This period is shorter when the unit is exposed to a highly humid climate.

Connecting antennas

To use the tuner of TX-DS696, it is necessary to prepare the supplied FM and AM antennas.

- Adjustment and placement of the FM and AM antennas for better reception must be done while listening to a station broadcast.
- If better reception cannot be obtained, then placement of an outside antenna is recommended.

Assembling the AM loop antenna

Assemble the loop antenna as shown in the illustration.

- Refer to "Connecting the AM loop antenna" below for details on connecting the loop antenna.



Connecting the AM antenna cable

1. Press down the lever.
2. Insert the wire into the hole.
3. Release the lever.

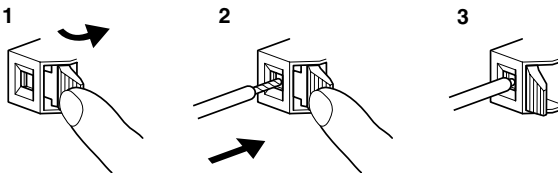

Connecting the included antennas

Connecting the FM indoor antenna:

The FM indoor antenna is for indoor use only. During use, extend the antenna and move it in various directions until the clearest signal is received. Fix it with push pins or similar implements in the position that will cause the least amount of distortion.

If the reception is not very clear with the attached FM indoor antenna, the use of an outdoor antenna is recommended.

Connecting the AM loop antenna:

The AM loop antenna is for indoor use only. Set it in the direction and position where you receive the clearest sound. Put it as far away as possible from the TX-DS696, televisions, speaker cables, and power cords.

When reception is not satisfactory with the attached AM loop antenna alone, connection of an outdoor antenna is recommended.

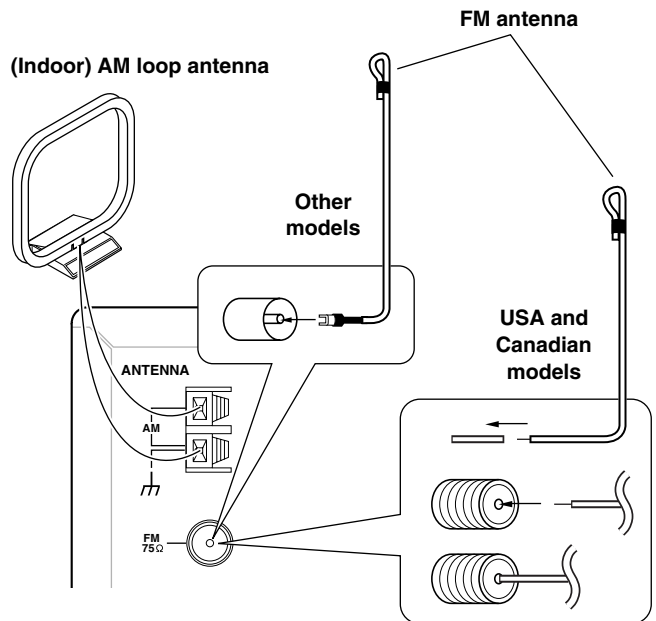

Strip away the insulation from the end of the cable, then fully insert the stripped end of the cable.

Hint:

Either of the split ends of the AM antenna can be connected to either terminal. Unlike speaker cabling, there is no polarity for AM broadcast signals.

Connecting antennas

Connecting an FM outdoor antenna

Please make sure that you follow the considerations:

- Keep the antenna away from noise sources (neon signs, busy roads, etc.).
- It is dangerous to put the antenna close to power lines. Keep it well away from power lines, transformers, etc.
- To avoid the risk of lightning and electrical shock, grounding is necessary. Follow item 14 of the “Important Safeguards” on page 2 when you install the outdoor antenna.

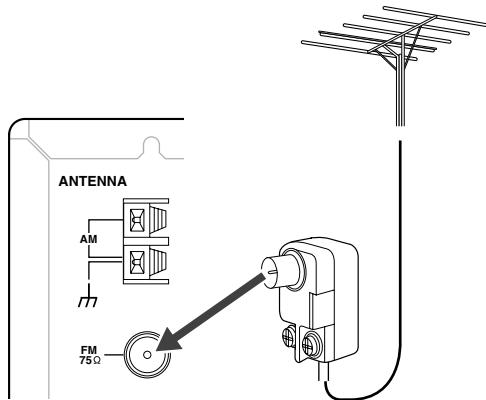

Connecting an AM outdoor antenna

An outdoor antenna will be more effective if it is stretched horizontally above a window or outside.

- Do not remove the AM loop antenna.
- To avoid the risk of lightning and electrical shock, grounding is necessary. Follow item 14 of the “Important Safeguards” on page 2 when you install the outdoor antenna.

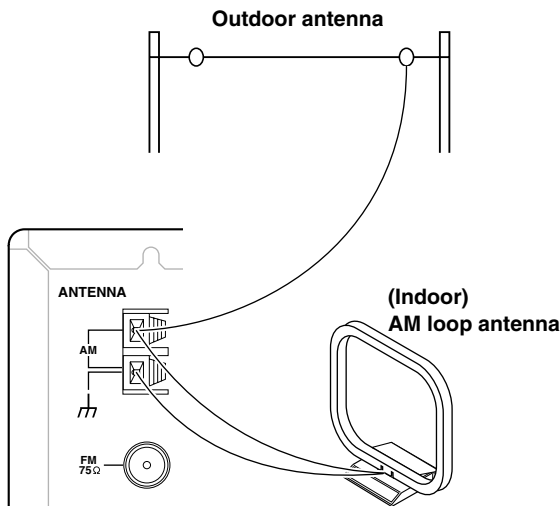

Note:

If you are using the TX-DS696 worldwide model in a region where AM frequencies are delineated by 10-kHz steps, be sure to set the AM Freq Step Setup setting accordingly (see page 42).

Directional linkage

Do not use the same antenna for both FM and TV (or VCR) reception since the FM and TV (or VCR) signals can interfere with each other. If you must use a common FM/TV (or VCR) antenna, use a directional linkage type splitter.

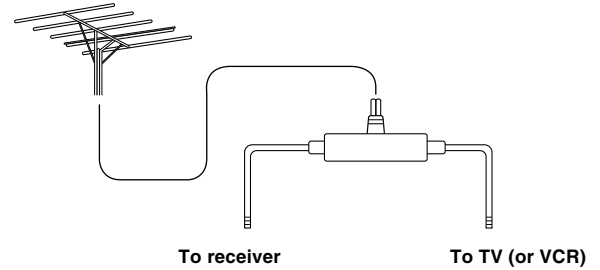

Connecting the antenna cable to the 75/300 Ω antenna adapter (For all models other than USA, Canadian and European models)

Connecting the 300 Ω ribbon wire:

Loosen the screws and wrap the wire around these screws. Then tighten the screws with a screwdriver.

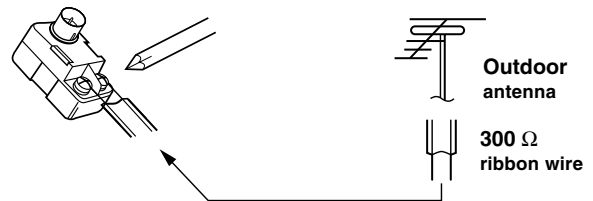

Connecting the coaxial cable:

1. With your fingernail, or a small screwdriver, press the stoppers of the 75/300 Ω antenna adapter outward and remove the cover.
2. Remove the transformer wire A from slit B and insert it into slit C.
3. Prepare the coaxial cable as shown in the diagram.
4. Connect the 75/300 Ω antenna adapter to the coaxial cable.
 1. Insert the end of the cable.
 2. Clamp it in place with pliers.
5. Reinstall the cover.

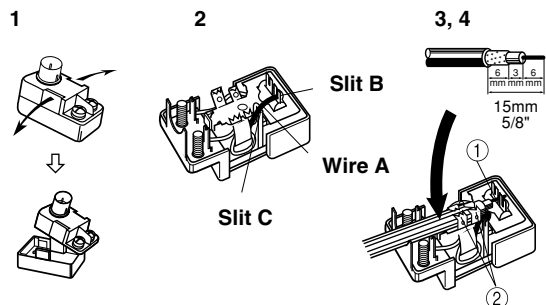

Speaker setup

After you have installed the TX-DS696, connected all the components, and determined the speaker layout, it is now time to perform the settings in the Speaker Setup menu for the optimum sound acoustics for your environment and speaker layout.

Before you perform the following settings, it is important that you first determine the following characteristics:

- The types and sizes of the speakers that are connected.
- The distance from each speaker to your normal listening position.

Before performing the settings, write down your speaker settings in the diagram below for future reference.

Your speaker settings:

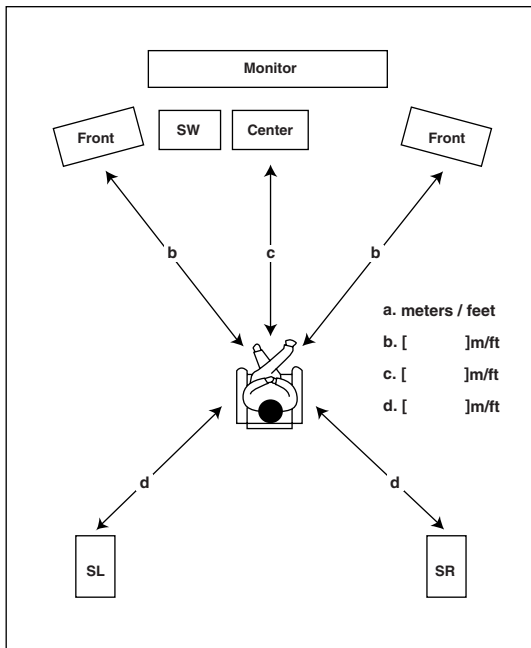

Use the buttons on the TX-DS696 to navigate through the menus and set the various settings and parameters according to your system setup and layout.

Buttons to be used

	Setup button: Press to enter the main menu level and put the TX-DS696 in the mode for setting the various parameters. If currently in the setting mode, press to exit.
	Jog dial: If the indicators directly above and below the jog dial are lit, turning the jog dial selects a submenu and pushing the jog dial enters the selected submenu (i.e. takes you one level down).
	If the indicators directly to the left and right of the jog dial are lit, turning the jog dial changes the setting of the currently selected parameter and pushing the jog dial displays the next parameter.
	RETURN button: Press to go back one level up.

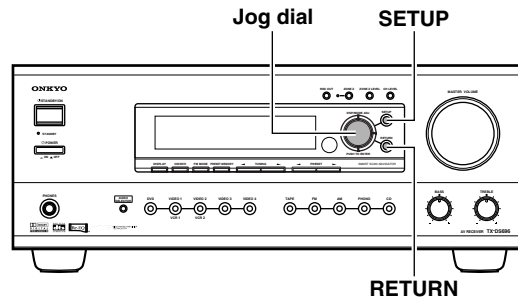

The normal order for performing the settings for speaker setup in your TX-DS696 is to set the speaker configuration settings first, set the speaker distances second, and then calibrate the speaker levels third. Below is an explanation of how to perform these settings using the controls on the TX-DS696.

You can also perform these settings using the On-Screen Display (OSD) menu (see page 34).

The settings are in a hierarchical configuration as shown below.

Level 1 Main menu level

The level consisting of the menus contained in the Setup menu.

Level 2 Menu level

The level consisting of the submenus contained in each menu.

Level 3 Submenu level

The level consisting of the parameters contained in each submenu.

Speaker Configuration submenu

This submenu provides settings that tell the TX-DS696 which speakers you have connected and what size they are.

1. Press the SETUP button.

If a menu other than "1. Speaker Setup" appears, turn the jog dial until "1. Speaker Setup" does appear.



1. Speaker Setup

2. Press the jog dial.



Speaker Config?

3. Press the jog dial.

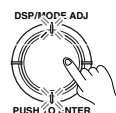

Subwoofer Yes

4. Turn the jog dial to set whether or not a subwoofer is connected.

Yes: Select when a subwoofer is connected.
No: Select when a subwoofer is not connected.

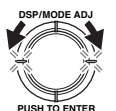

Speaker setup

5. Press the jog once and then turn it to set the size of your front speakers.

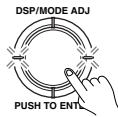

Front # Large

Large: Select if the front speakers are large sized.

Small: Select if the front speakers are small sized.

- If “No” is selected for the Subwoofer setting, then this setting is fixed to “Large”.



6. Press the jog once and then turn it to set whether or not a center speaker is connected and, if one is connected, its size.

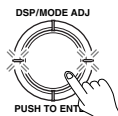

Center # Large

None: Select if no center speaker is connected.

Large: Select if the center speaker is large sized.

Small: Select if the center speaker is small sized.

- If “small” is selected for the Front setting, then “Large” cannot be selected for this setting.



7. Press the jog once and then turn it to set whether or not surround speakers are connected and, if they are connected, their size.

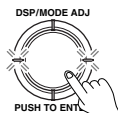

Surround # Small

None: Select if no surround left and right speakers are connected.

Large: Select if the surround left and right speakers are large sized.

Small: Select if the surround left and right speakers are small sized.

- If “small” is selected for the Front setting, then “Large” cannot be selected for this setting.

Pressing the jog dial again returns you to the subwoofer setting.



8. Press the RETURN button.

You return to the “Speaker Config?” display.



Speaker Config?

Notes:

- If you press the RETURN button again, you go back up one more level.
- To exit the setting mode immediately, press the SETUP button.

Speaker Distance submenu

This submenu provides settings that tell the TX-DS696 how far away your speakers are located from the listening position so that it can provide the optimum sound space. If you are continuing from setting the speaker configuration and are still in the setting mode, skip directly to step 2.

1. Press the SETUP button.

If a menu other than “1. Speaker Setup” appears, turn the jog dial until “1. Speaker Setup” does appear.



1. Speaker Setup

2. Press the jog dial and then turn it to display the “Speaker Distance.”

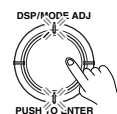

Sp Distance?

3. Press the jog dial and then turn it to select the unit of measurement.

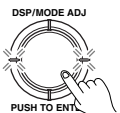

Unit # feet

feet: Select if you will enter the distances in feet.

meters: Select if you will enter the distances in meters.



4. Press the jog dial and then turn it to set the distance from the front speakers to the listening position.

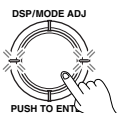

Front L/R # 12"



5. Repeat the procedure in step 4 to set the distance from the center speaker and the surround speakers to the listening position.

6. Press the RETURN button.

You return to the “Sp Distance?” display.



Sp Distance?

Notes:

- If you press the RETURN button again, you go back up one more level.
- To exit the setting mode immediately, press the SETUP button.

Speaker setup

Level Calibration submenu

This submenu allows you to set the volume levels of each speaker individually so that they all sound at the same level when heard from the listening position. If you are continuing from setting the speaker distances and are still in the setting mode, skip directly to step 2.

1. Press the SETUP button.

If a menu other than “1. Speaker Setup” appears, turn the jog dial until “1. Speaker Setup” does appear.



1. Speaker Setup

2. Press the jog dial and then turn it to display the “Level Cal?”



Level Cal?

3. Press the jog dial.

A test sound (pink noise) will be heard from the left front speaker. At this point, it is not necessary to adjust the volume of the test sound.

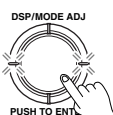

Left # 0

4. Press the jog dial again.

The test sound will now be heard from a different speaker.

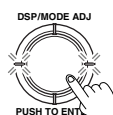

5. Turn the jog dial to adjust the volume of the test sound from this speaker to the same level that you heard from the previous speaker.



6. Repeat the procedure in step 4 and 5 until the volume of the test sound from all speakers is the same level.

Each time you press the jog dial, the test sound will be heard from a different speaker. The speaker order for calibration is front left → center → front right → surround right → surround left → subwoofer.

7. Press the RETURN button.

You return to the “Level Cal?” display.

Notes:

- If you press the RETURN button again, you go back up one more level.
- To exit the setting mode immediately, press the SETUP button.

About the other settings

The factory settings for your TX-DS696 are given in the table on page 12. If you connect your system in accordance with these factory settings, there is no need to change them. However, if you do not, you will need to change the settings that do not match. If you do not, signals may not be properly received resulting in poor sound or image quality, no digital output, or no output at all.

Changing a digital input setting:

1. Press the input selector button for the source that you want to change.
2. Press the SETUP button.
3. Turn the jog dial to display “2. Input Setup.”
4. Press the jog dial.
“Audio Setup?” appears.
5. Press the jog dial again.
“D.Input: xxx” appears.
6. Turn the jog dial and select the connector to which the digital source is connected.
7. Press RETURN repeatedly or press SETUP to exit the setting mode.

Changing the multichannel setting:

1. Press the input selector button for the source that you want to change.
2. Press the SETUP button.
3. Turn the jog dial to display “2. Input Setup.”
4. Press the jog dial.
“Audio Setup?” appears.
5. Press the jog dial twice.
“Multich: xxx” appears.
6. Turn the jog dial to select “Yes” or “No.”
7. Press RETURN repeatedly or press SETUP to exit the setting mode.

Changing the Component Video Input setting:

1. Press the input selector button for the source that you want to change.
2. Press the SETUP button.
3. Turn the jog dial to display “2. Input Setup.”
4. Press the jog dial.
“Audio Setup?” appears.
5. Turn the jog dial to display “Video Setup?”
6. Press the jog dial.
“Cmponent: xxx” appears.
7. Turn the jog dial to select the connectors to which the source is connected (“Input 1” or “Input 2”).
8. Press RETURN repeatedly or press SETUP to exit the setting mode.

Listening to Radio Broadcasts

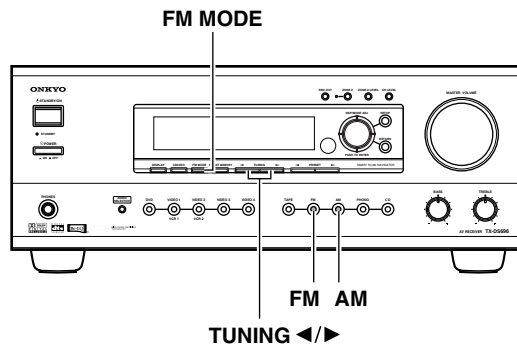

One of the features of the TX-DS696 that is most frequently used is its ability to play FM and AM broadcast radio stations. The TX-DS696 provides a number of listening modes perfect for listening to the radio and getting the most out of your audio system. Also, by presetting radio stations that you listen to frequently, you can select them easily by pressing the CH \leftrightarrow button on the remote controller.

Listening to a stereo radio station (FM mode)

When you tune into a radio station, **TUNED** indicator appears in the display. If you tune into an FM station in stereo, then "FM STEREO" appears. If the signal is weak, it may be impossible to tune into the station in stereo. In such a case, **press the FM MODE button** on the front panel. The AUTO indication disappears and the radio station is output in the monaural mode. To return to stereo, press the FM MODE button again. "AUTO" appears. Some inter-station noise may be heard, but the sound will not cut in and out as it would if stereo was selected.



Tuning into a radio station

1. Press either the AM or FM input source button.

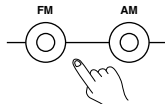

2. Using the TUNING \leftarrow and \rightarrow buttons on the front panel, tune into the station you desire.

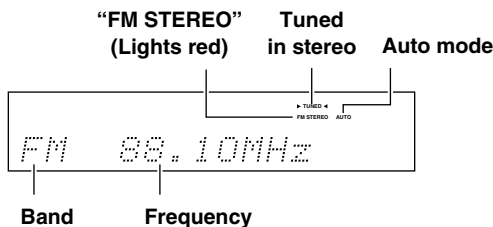
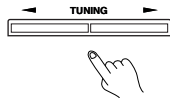

- The tuner frequency changes in 50 kHz increments for FM and 10 kHz (or 9kHz) increments for AM.
- When tuning into FM stations, you can press the TUNING \leftarrow or \rightarrow button continuously for more than 0.5 seconds to scan for an FM station in the direction of the button you pressed (FM auto tuning mode). After you release the button and a station is received in stereo, the scanning stops.
- The European model allows you to receive RDS broadcasts. See pages 27 and 28 for a more detailed explanation.

Listening to Radio Broadcasts

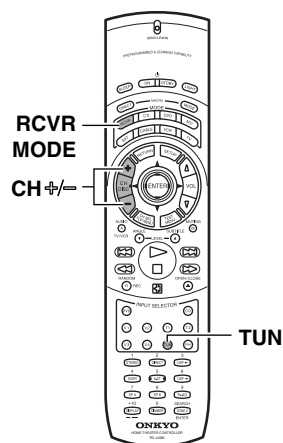
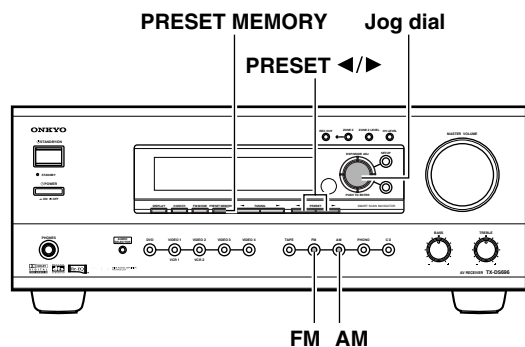

Presetting a radio station

1. Tune into the radio station you desire (see "Tuning into a radio station").

FM 88.10MHz

2. Press the PRESET MEMORY button on the front panel.



"Preset In?" appears in the front display for about five seconds.

Preset In?

3. Press the jog dial.

The MEMORY indicator lights red.



"MEMORY"
(Lights red)



4. Turning the jog dial, select a preset number (from 1 to 40) to assign the station to be preset.

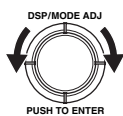

"MEMORY"
(Lights red) Flash

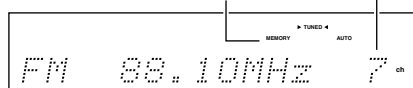

5. Press the jog dial to finalize the procedure.

This programs the radio station as a preset radio station.

- Up to 40 stations can be stored in memory as preset radio stations.

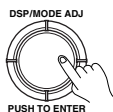

Selecting a preset radio station

1. Press either the AM or FM input source button. The front display should show the currently selected frequency.

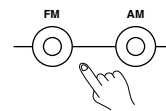

If it displays the listening mode, press the DISPLAY button to display the frequency.

2. Press the PRESET </> button and select the number of the desired preset station.

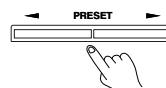

When using the remote controller:

1. Press the RCVR MODE button.
The RCVR MODE button lights green.
2. Press the TUN button.
3. Press the CH +/- button and select the number of the desired preset station.

Erasing a preset radio station

1. Press the AM or FM button and press the PRESET </> button to select the preset radio station that you want erase (see above).

FM 88.10MHz 7^{ch}

2. Press the PRESET MEMORY button.

"Preset In?" appears.



Preset In?

3. Turn the jog dial to display "Preset Erase?"

Preset Erase? 7^{ch}



4. Press the jog dial.

The selected preset station is erased.



Listening to RDS broadcasts (European models only)

Listening to RDS broadcasts

RDS reception is available only on the European model and only in areas where RDS broadcasts are available.

What is RDS?

RDS stands for Radio Data System and is a type of FM broadcasting. RDS was developed within the European Broadcasting Union (EBU) and is available in most European countries. Many FM broadcasting stations now transmit the RDS signals, which provide the additional information required. RDS provides you with various services so that you can choose a station that broadcasts your favorite categories of music, news, or other information.

There are three main classifications of RDS broadcasts. Though they can be tuned into by using the Tuning buttons as normal stations, RDS broadcasts allow you to scan for stations of the type and classification for which you are looking. This makes it much easier for you to find the station you want (see "Performing a PTY scan" and "Performing a TP scan" on page 28). The three main classifications are explained below.

RT: Radio Text

When an RDS station broadcasting RT information is selected, the text information received from the station is displayed.

PTY: Program Type

When an RDS station broadcasting PTY information is selected, the station type (classification) is displayed.

TP: Traffic Program

When an RDS station broadcasting TP information is selected, traffic information will be broadcasted periodically.

Notes:

- In some cases, the characters displayed on the display of the TX-DS696 may not be exactly the same as the ones broadcast by the radio station. Also, unusual characters may appear on the display if the TX-DS696 receives characters that cannot be displayed correctly. This is not a malfunction.
- When an RDS station broadcasting PS information is selected, the name of the station is displayed instead of the frequency.

PTY program types in Europe

The text given in parenthesis is what is actually displayed on the TX-DS696.

None (NONE):

No program type.

News reports (NEWS):

Reports on current events and happenings.

Current affairs (AFFAIRS):

Topical reporting of current affairs, often with a wider range of topics than news reports.

Information (INFO):

General information such as weather forecasts, consumer affairs, medical help, etc.

Sport (SPORT):

Live sports action, sports news, and interviews.

Education (EDUCATE):

Formal educational programs.

Drama (DRAMA):

Radio plays and serials.

Culture (CULTURE):

Cultural programs (including religious affairs).

Science and technology (SCIENCE):

Programs about the natural sciences and technology.

Varied (VARIED):

Speech-based programs not covered by the above categories (e.g., quizzes, panel games, and comedy).

Pop music (POP M):

Popular commercial music, usually from past or present sales charts (e.g., Top 40).

Rock music (ROCK M):

Popular music with an alternative appeal, often not appearing on sales charts.

Middle of the road music (M.O.R. M):

Easy listening music (as opposed to Pop, Rock, or Classical).

Light classics (LIGHT M):

Classical music for general rather than specialist appreciation.

Serious classics (CLASSICS):

Performances of major orchestral works, symphonies, chamber music, etc. (including the Grand Opera).

Other music (OTHER M):

Music styles not covered by the above categories (e.g., Jazz, Rhythm & Blues, Folk, Country, and Reggae).

• Alarm (ALARM):

When an RDS station is making an emergency broadcast, this ALARM will flash on the display.

Listening to RDS broadcasts

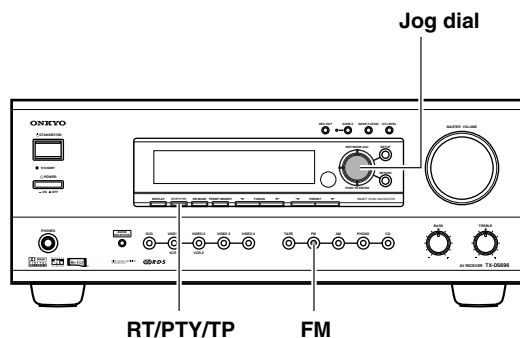

Displaying Radio Text (RT)

If the station you are currently tuned into is broadcasting RT signals, they will be displayed in the front display on the TX-DS696. If the station does not, this function will be ignored.

1. To display the radio text, press the RT/PTY/TP button once.



- If the current station you are listening to is not an RDS station, only the frequency of the station appears.
- If "Waiting" appears on the display, more time is required to receive the RT information. When the information is received, the characters will scroll across the front display.
- If "No Text Data" appears on the display, RT information is not available.
- The display shows the frequency for 3 seconds and returns to program service name.

Performing a PTY scan

1. Press the FM input source button.



2. Press the RT/PTY/TP button twice.

The current program type appears on the display.



ROCK M

3. Using the jog dial, select the PTY program type you desire.



LIGHT M

4. Press the jog dial.

The TX-DS696 will scan until it reaches a station of the program type you selected. It will then stop briefly at that station before continuing on until it reaches the next station. Pressing the jog dial stops the PTY scan at that point. If you press the RT/PTY/TP while "NONE" is displayed, "PTY ?" will appear. In this case, return to step 3.



5. Press the jog dial when it reaches the station that you want to listen to.

"Not Found" will appear when no RDS signal is being received from the station.

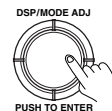

Performing a TP scan

1. Press the FM input source button.



2. Press the RT/PTY/TP button three times.



[TP]

"[TP]" will appear if the current station is broadcasting TP signals. This station will periodically broadcast traffic information. To find a different station, proceed to the next step. Also, if "TP" is displayed, proceed to the next step.

3. Press the jog dial.

The TX-DS696 will scan until it reaches a station broadcasting traffic information. If "Not Found" appears on the display, a TP station cannot be located.



Enjoying music or videos with the TX-DS696

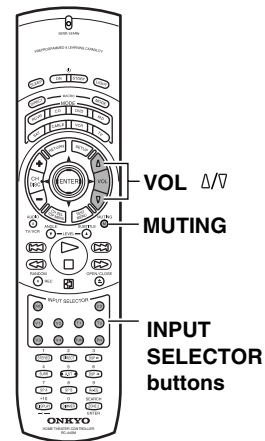
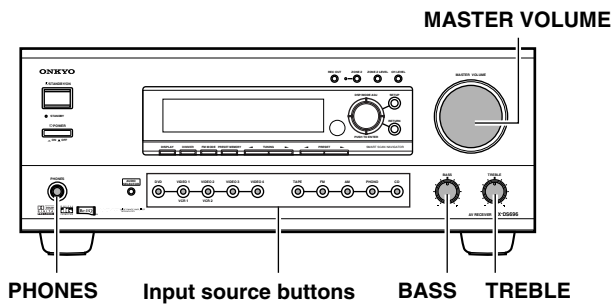

Though the TX-DS696 is often used to listen to the radio, it does not show you its true ability until it is used to play music or watch videos, DVDs, and the like. The TX-DS696 has the latest in state-of-the-art features to play back today's acoustic technologies with the utmost in fidelity and power. From a two-speaker system to a five-speaker system, you are assured a sound space that you can always enjoy.

Temporarily turning off the sound

To turn off the sound momentarily, such as when interrupted by a phone call, press the MUTING button on the remote controller. When pressed, "Muting" is displayed on the TX-DS696. Press the MUTING button again to turn the sound back on.

Remote controller

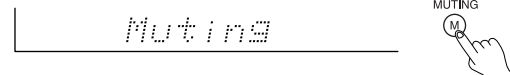

Basic operation

1. Press the input source (or input selector on the remote controller) button.

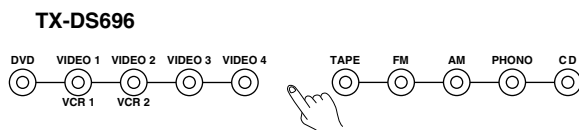

Remote controller

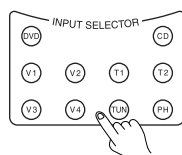

Adjusting the bass and treble

You can adjust the bass and treble levels using the BASS and TREBLE dials. This function only affects the front left and right speakers. For multichannel sources, these dials will not work if the tone control is set to "Off."

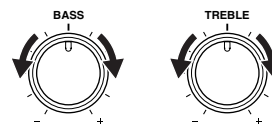

2. Turn on the corresponding component and play the media.

3. Adjust the volume.

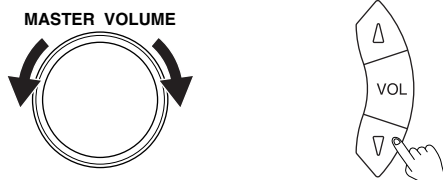

Adjusting the main volume adjusts the volume level output from all the speakers connected to the TX-DS696 together. If headphones are connected, this also adjusts the volume heard from the headphone speakers. To adjust the volume, either press the VOL Δ/V buttons on the remote controller or turn the MASTER VOLUME dial. To increase the volume, turn the dial clockwise; to decrease the volume, turn the dial counterclockwise. The volume can be set to Min, 1 to 79, and Max.

Listening with headphones

To listen with headphones, plug a pair headphones with a standard stereo plug into the PHONES jack on the TX-DS696 front panel. When you connect headphones, the unit will enter STEREO mode automatically and no sound will be heard from the speakers.

If you have selected MULTI CH INPUT, you will hear sound only from the FRONT L and R channels.

The headphone volume level can be adjusted at the Setup menu (see page 42).

Note that the signal to the remote zone (Zone 2) will not be affected whether or not headphones are connected.



Enjoying music or videos with the TX-DS696

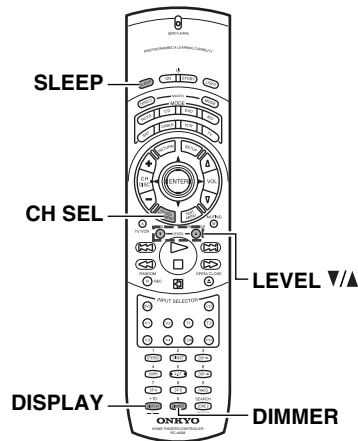
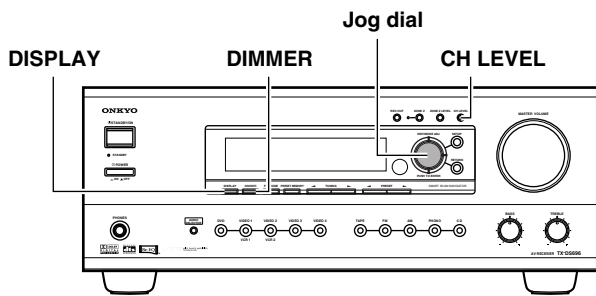

Switching the display

While listening to or watching an input source, you can display the information regarding the type of source and signal being input by pressing the DISPLAY button on the TX-DS696 or the remote controller.

TX-DS696



Remote controller



When an input source other than FM or AM is selected:

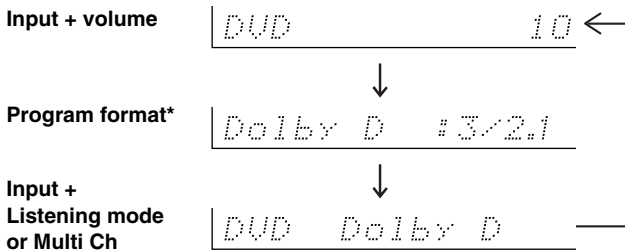

* If the input signal does not have a program format, then this will be skipped.

When FM or AM is selected as the input source:

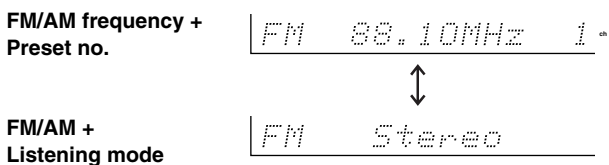

Adjusting the brightness of the front display

You can adjust the brightness of the front display of the TX-DS696 with DIMMER button on the remote controller or on the TX-DS696 front panel with other than European models.

TX-DS696
(Other than European models)



Remote controller



Using the sleep time (remote controller only)

The SLEEP button enables you to set the TX-DS696 to turn off automatically after a specified time period. If you press it once, the TX-DS696 will turn off after 90 minutes. Each time it is pressed thereafter, the remaining time until the TX-DS696 turns off decreases by 10 minutes. While the sleep function is enabled, you can press the SLEEP button to see how much time is left. To cancel the sleep function, press the SLEEP button when the time displayed is less than 10 minutes.

If you are using the remote zone (Zone 2), it will turn off at the same time as the main zone. If you want to set the sleep function for Zone 2 only, set the sleep function with main zone turned on and then put the main zone into the standby state.

Remote controller

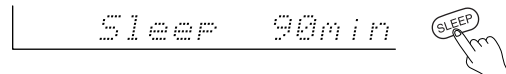

Temporarily changing the speaker output levels

To change the individual speaker volumes temporarily, follow the procedure given below. Each channel can be set between -12 to +12 decibels. Note that the calibration settings will return to the original settings when the TX-DS696 is put in standby.

1. Press the CH LEVEL button and select the desired speaker.



2. Turn the jog dial to adjust the volume level.



When using the remote controller:

1. Press the RCVR MODE button.

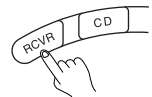

2. Press the CH SEL button and select the desired speaker.



3. Press the LEVEL ▲ or ▼ button to adjust the volume level.



Notes:

- You cannot select a speaker if the Speaker Config sub-menu of the Speaker Setup is set to No or None.
- If the speaker level is set to +1 dB or higher, the maximum level indicated on the display will change if you raise the volume level.
- When you press the TEST button after you set the level, the current level will be used as the value set via the test tone.

Enjoying music or videos with the TX-DS696

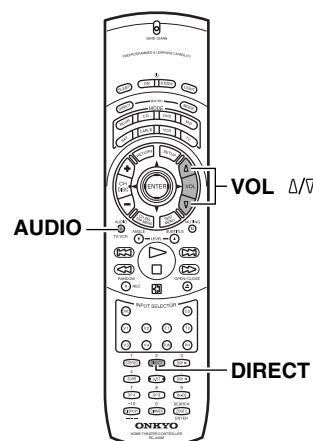
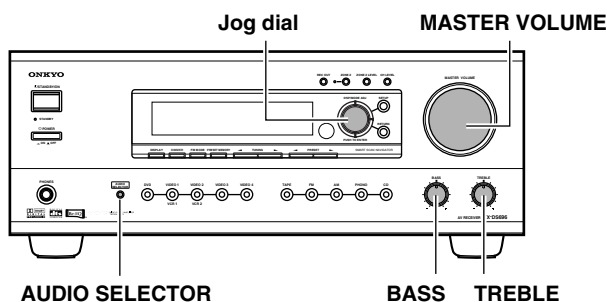

Changing the audio mode

Press the AUDIO SELECTOR button on the front panel (or AUDIO button on the remote controller) to change the audio mode. Each time the button is pressed, the mode changes from “AUTO” → “Multich” → “Analog” and back to “AUTO.” The “AUTO” audio mode is recommended for normal circumstances.

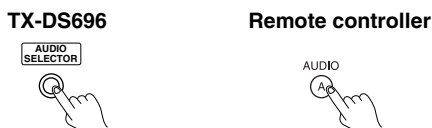

AUTO (automatic detection): With this setting, the TX-DS696 automatically detects whether the input signal is digital or analog. When a digital signal is not input, then the analog signal is played.

Multichannel: Select this setting to play back the input from the component connected to the MULTI CHANNEL INPUT port. This setting is effective when the Multichannel setting in the Audio Setup sub-menu is set to “Yes” (see pages 24, 39).

Analog: Select this setting to play back the input from a source component connected to an analog audio input jacks. With this setting, even if a digital signal is input from the same component, only the analog signal will be output.

Enjoying the multichannel output

Before starting operations, first make sure that the multichannel connection is properly made and that the Multichannel setting of the Input Setup → Audio Setup submenu is set to “Yes.”

1. Press the input source button for the component with multichannel output connected to the MULTI CHANNEL INPUT on the rear of the TX-DS696.
2. Select “Multich” using the AUDIO SELECTOR button on the front panel (AUDIO button on the remote controller).

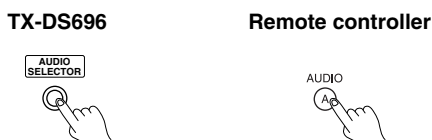

3. Turn on the connected component and start playing the desired media.

4. If necessary, adjust the output level of each speaker as desired (see page 30).

Adjust the speaker output levels so that you can hear the same sound level from each speaker at the listening position. For the front right, front left, center, surround right, and surround left speakers, the output levels can be adjusted between -12 to +12 decibels. The subwoofer can be adjusted between -30 to +12 decibels.

5. Adjust the volume with the MASTER VOLUME dial or the VOL Δ/V buttons on the remote controller.

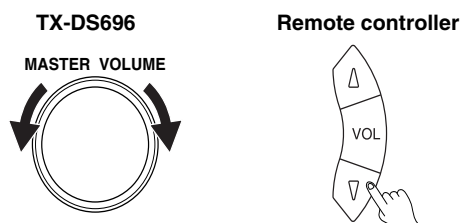

Using the tone control:

To make the BASS and TREBLE dials work for multichannel sources, you must first set the tone control to “On.”

1. Turn the tone control on by pressing either the jog dial on the TX-DS696 or the DIRECT button on the remote controller.

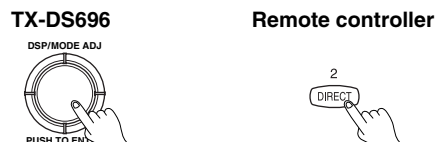

When pressed only once, the current setting appears, so press twice to change the setting.

2. Adjust the tone using the BASS and TREBLE dials.

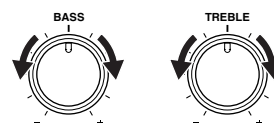

Notes:

- Adjusting the volume level of each speaker for the MULTI CH INPUT source does not affect the speaker level adjusted by the listening position.
- If the speaker level is set to +1 dB or higher, the maximum level indicated on the display will change if you raise the volume level.

Using listening mode

The TX-DS696's surround sound enables you to enjoy the presence of a movie theater or concert hall in your room.

The configuration of the speakers are very important for the surround sound. Refer to "Connecting speakers" on page 17.

Before using a listening mode, make sure the Speaker Setup parameters have been set (refer to page 22-24). Once the parameters have been set, it is not necessary to set them again.

Listening modes

Stereo

This mode has all input sounds output from the left and right front speakers.

Direct

This mode delivers pure sound with minimum sound quality adjustment and filtration. The sound recorded for the right and left front channels is output to the right and left front speakers only and not output to the subwoofer.

Surround modes

With this mode, decoding is performed automatically to match the input signal. This original mode adds no sound processing to the input signal.

• Dolby D (Dolby Digital)

Digital data with AC-3 compression and a maximum of 5.1-channel* surround sound. This source signal comes from DVDs and LDs that have the  mark and therefore recorded for 5.1-channel output. This source also comes from digital satellite broadcasts that support Dolby Digital.

• DTS

DTS (Digital Theater System) is compressed digital data with a maximum 5.1-channel* surround output that allows for an extremely high-quality sound. This source signal requires a DVD player that supports DTS output and comes from compact discs, DVDs, and LDs that have the  mark.

Notes on DTS:

- If you play a CD or LD that supports DTS when the "Analog" setting is selected on the TX-DS696, the DTS encoded signal will not be decoded and noise will be output. This noise could damage the amplifier and speakers. Therefore, be sure to select "Auto" and use the digital input jacks (OPTICAL or COAXIAL) to connect the DTS source.
- The DTS indicator on the TX-DS696 lights while a DTS source is played. When playback finishes and the DTS signal transmission stops, the TX-DS696 remains in DTS mode and the DTS indicator remains lit. This prevents noise when you operate the pause or skip button on the player. Therefore, if the source is immediately switched from DTS to PCM, the PCM signal may not be played. In this case, stop the playback of the source on the player for about three seconds and then resume playback.
- If you press the pause or skip button on the player while playing a DTS source, on rare occasions a short noise may be heard. This is not a malfunction.
- You may not be able to play some DTS source signals from certain CD players and LD players even if you connect the player to the TX-DS696 digitally. This is because the digital signal has been processed (such as the output level, sampling frequency, or frequency response) and the TX-DS696 cannot recognize the signal as DTS data. Therefore you may hear noise when you play a DTS source while processing the signal.

- The outputs for the VIDEO 1 OUT, VIDEO 2 OUT, TAPE OUT, output analog audio signals. Do not record from CDs or LDs that support DTS using these outputs. If you do, the DTS-encoded signal will be recorded as noise.

- * The 5.1-channel digital surround format has a variety of versions including Dolby Digital and DTS. The 5.1-channel digital surround format enables you to individually record and play five full-range (20 Hz to 20 kHz) channels (left and right front, center, and two surround channels) plus an LFE channel (Low Frequency Effect) for the low-range effect sound. It will create a realistic sound that can be heard in the theaters and concert halls.

• DOLBY PRO LOGIC II Surround

This mode is a new generation 5-channel surround system that provides performance between the 4-channel (left front, right front, center, and monaural surround) Pro Logic Surround and the 5.1-channel Dolby Digital Surround. This mode can be set to the Movie mode designed for playing movies and the Music mode designed for listening to music. The Movie mode is monaural except for a stereo narrow band for the surround channels. The result is movie viewing with a realistic feel of movement. The Music mode uses the surround channels to provide a natural sound space that cannot be provided with normal stereo output.

This mode can be used with VHS and DVD videos with the  mark and certain television programs. The Music mode can be used with music compact discs and other stereo sources.

You can press the SURR button on the remote controller to switch between MOVIE and MUSIC. The initial setting is MOVIE. This setting can be made for each input source.

If no surround speakers are connected, then the surround sound is divided and output from the front left and right channels (3 stereo).

Orchestra

This mode is appropriate for classical and opera music. The center channel is cut and the surround channels are emphasized to widen the stereo image. It will simulate the natural reverberation that is created in large halls.

TV Logic

This mode gives realistic acoustics to TV programs that are aired from TV studios. It enhances the entire surround sound and clarity of the conversation.

Unplugged

This mode is suitable for acoustical instrumental sounds, vocals, and jazz music. By emphasizing the front stereo image, it will simulate the acoustics that you would experience in front of the stage.

Studio-Mix

This mode is for rock and popular music. The lively sounds are enhanced for a powerful acoustic image that simulates the feeling of being in a club or rock concert.

All Ch Stereo

This mode is designed for playing background music. The front, surround, and surround back channels create a stereo image that encompasses the entire area.

Using listening mode

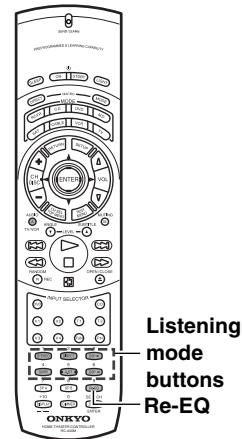
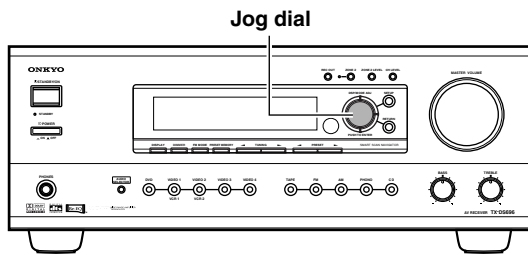

Changing the listening mode

To change the listening mode during playback, press the listening mode buttons on the remote controller.

You can also set the listening mode using the jog dial on the TX-DS696. Push the jog dial repeatedly to cycle the listening mode from Direct→Stereo→Surround→All Ch Stereo→Direct. Turn the jog dial to change the listening mode in the same manner as DSP ◀▶ on the remote controller.

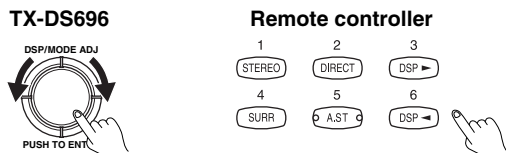

DIRECT: Changes the listening mode directly to the Direct listening mode. If pressed, the listening mode for the selected input source set in the Listening Mode Preset sub-menu is also changed to the Direct listening mode.

STEREO: Changes the listening mode directly to the Stereo listening mode. If pressed, the listening mode for the selected input source set in the Listening Mode Preset sub-menu is also changed to the Stereo listening mode.

SURR (Surround): Changes the listening mode to the surround mode for the current input signal (e.g., Dolby Pro Logic II, Dolby Digital, or DTS). If pressed, the listening mode for the selected input source set in the Listening Mode Preset sub-menu is also changed to the Surround listening mode. For Dolby Pro Logic II, this button also changes the mode between Dolby Pro Logic II Movie and Dolby Pro Logic II Music.

A.ST(All Channel Stereo): Changes the listening mode directly to the Stereo listening mode. If pressed, the listening mode for the selected input source set in the Listening Mode Preset sub-menu is also changed to the All Channel Stereo listening mode.

DSP ◀▶: Changes the listening mode as shown below. Direct ↔ Stereo ↔ Surround ↔ Orchestra ↔ Unplugged ↔ Studio-Mix ↔ TV Logic ↔ All Ch Stereo ↔ Direct. If pressed, the listening mode for the selected input source set in the Listening Mode Preset sub-menu is also changed.

Note: If you want to switch between Dolby Pro Logic II Movie and Dolby Pro Logic II Music at the TX-DS696, press the jog dial and select “Surround” for the listening mode.

Using Cinema Re-Equalization

Depending on the listening mode, you can either turn Re-EQ on or off. Re-EQ (re-equalization) takes the edginess or “brightness” out of your home cinema sound to compensate for the fact that sound mixed for theaters may sound too bright when played back through speakers in the home environment.

Remote controller only



- On:** Select to turn on the re-equalization filter.
- Off:** Select to turn off the re-equalization filter.

Note: The Re-EQ function is effective on the Dolby Pro Logic II Surround and Dolby Digital Surround.

Setup menus

When making the various settings required to configure your TX-DS696 optimally, you can either use the OSD menu that appears on your television monitor or you can use the display on the front of the TX-DS696.

The OSD menu is a settings menu that is displayed on your TV monitor.

For use as reference when performing the setting procedures, this manual shows both the OSD menu displayed on your television monitor and the display on the front of the TX-DS696.

The Setup menu consists of a main screen that is divided up into 5 menus: Speaker Setup, Input Setup, Listening Mode Setup, Preference, and OSD Setup. These menus are then divided up into various sub-menus, and these contain settings for you to optimize your home theater as you wish.

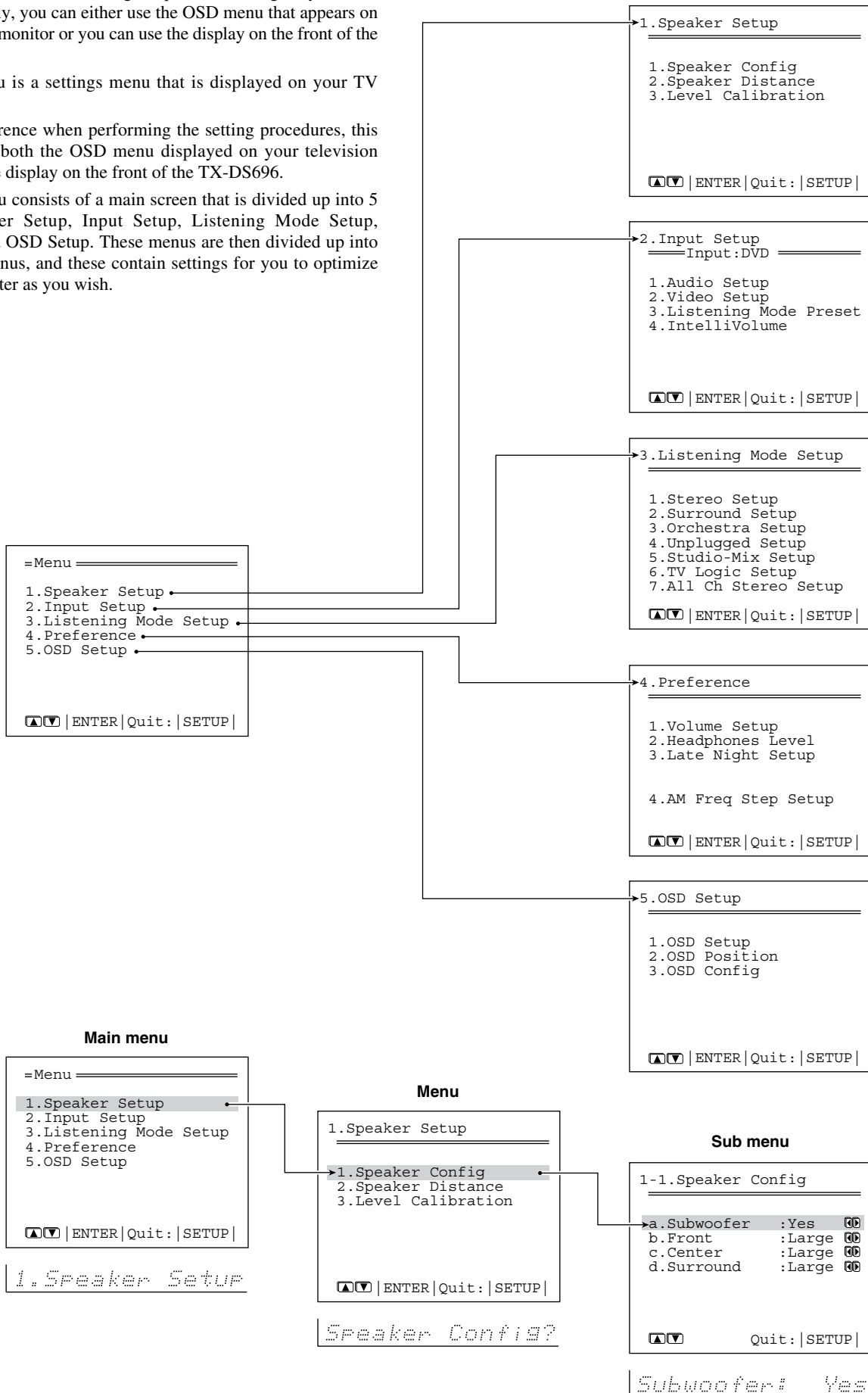

Setup menus

Navigating through the Setup menu

The explanations here assume you are using the buttons on the remote controller when entering the Setup menu. However, you can use the buttons on the TX-DS696 as well. When using the buttons on the TX-DS696, refer to the table on the right and pages 22 to 24.

In addition to the display of the Setup menu on your television monitor, the corresponding menu will also be displayed in the front display on the TX-DS696.

The buttons on the remote controller correspond to those on the TX-DS696 as shown on the right.

1. Press the SETUP button.

The main menu screen of the Setup menu appears on your television monitor and the TX-DS696 enters the setup mode.



2. Using the ▲ and ▼ cursor buttons, select the menu that you want to enter.

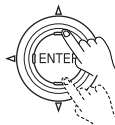

3. Press the ENTER button to enter the selected menu.

The screen for that menu appears.



4. Using the ▲ and ▼ cursor buttons, select the sub-menu that you want to enter, and press the ENTER button.

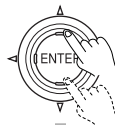

Each sub-menu has different settings that can be changed as desired, and they are all explained below. To change a setting, first select it using the ▲ and ▼ cursor buttons, and then change the setting using the ◀ and ▶ cursor buttons.

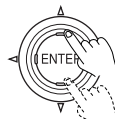

5. Press the RETURN button to return to the previous menu screen, and again to return to the main screen.



Note:

Press the SETUP button to exit the Setup menu immediately.



Setting procedures and button operations

	Remote controller	TX-DS696
Main menu		
Display menu (display OSD menu)		
Select item		
Enter selected item		
Menu		
Select item		
Enter selected item		
Submenu		
Select item		
Set parameter		
Other		
Move up one level		
Exit OSD menu		

Setup menus

1. Speaker Setup menu

The settings here are also explained on pages 22 to 24. Refer to those pages for reference.

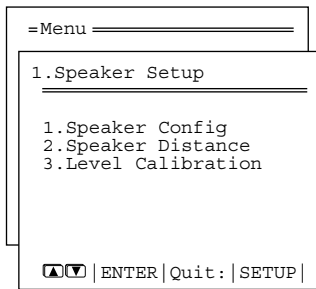

1. Speaker Setup

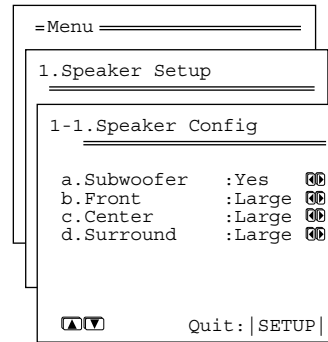

Speaker Config?

Your speaker settings:

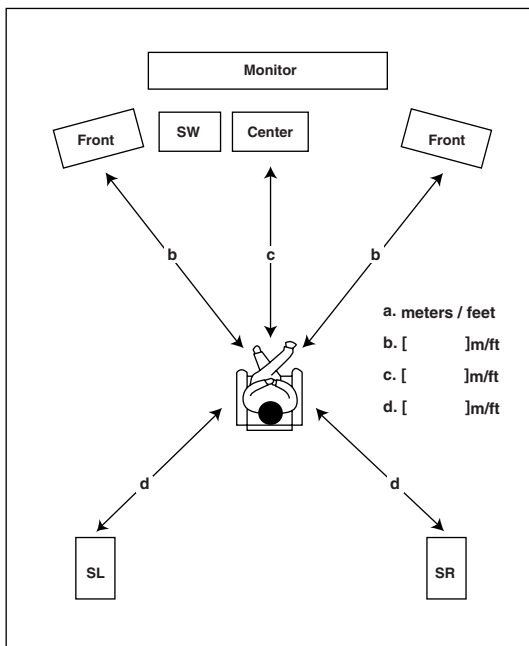

Tip:

When setting the speaker size in the Speaker Config sub-menu, use the guidelines given below.

Large: The complete frequency range for the channel you are setting will be output from the speaker.

Small: Frequencies of the channel you are setting lower than 80 Hz will be output from the subwoofer. If the front speakers are set to "Large," then the sound may be output from both the left and right speakers.

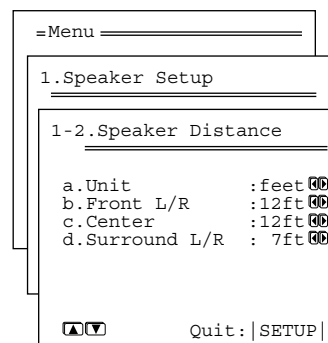

SP Distance?

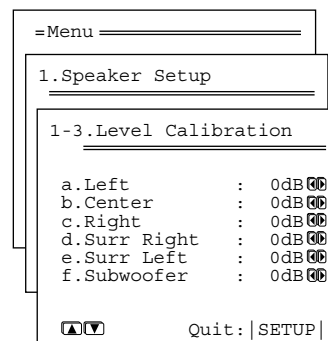

Level Cal?

Setup menus

1-1. Speaker Config sub-menu

Here you will enter which speakers are connected and the size of each speaker.

a. Subwoofer

Yes: Select when a subwoofer is connected.

No: Select when a subwoofer is not connected.

b. Front

Large: Select if the front speakers are large sized.

Small: Select if the front speakers are small sized.

- If “No” is selected for the Subwoofer setting, then this setting is fixed to “Large.”

c. Center

None: Select if no center speaker is connected.

Large: Select if the center speaker is large sized.

Small: Select if the center speaker is small sized.

- If “Small” is selected for the Front setting, then “Large” cannot be selected for this setting.

d. Surround

None: Select if no surround left and right speakers are connected.

Large: Select if the surround left and right speakers are large sized.

Small: Select if the surround left and right speakers are small sized.

- If “Small” is selected for the Front setting, then “Large” cannot be selected for this setting.

1-2. Speaker Distance sub-menu

Here you will enter the distance from each speaker to your normal listening position. This is important for the timing of the acoustics to create the proper sound space that the TX-DS696 and today’s sound systems are able to produce.

Note:

Speakers that you selected “No” or “None” for in the Speaker Config sub-menu will not appear.

a. Unit

feet: Select if you will enter the distances in feet.

meters: Select if you will enter the distances in meters.

b. Front L/R

Set the distance from the front left and right speakers to your normal listening position between 1 and 30 feet in 1-foot intervals (0.3 to 9 meters in 0.3-meter intervals).

Position the front left and right speakers so that they are the same distance from the listener. If they are not, you may lose the center position for stereo sound.

c. Center

Set the distance from the center speaker to your normal listening position between 1 and 30 feet in 1-foot intervals (0.3 to 9 meters in 0.3-meter intervals).

d. Surround L/R

Set the distance from the surround left and right speakers to your normal listening position between 1 and 30 feet in 1-foot intervals (0.3 to 9 meters in 0.3-meter intervals).

1-3. Level Calibration sub-menu

Here you will set the volume for each speaker so that they are all heard by the listener at the same level. This is especially important for speaker layouts where the left and right speakers are at different distances or in asymmetrical positions due to room designs and configurations. These settings and the distance settings performed above are vital to create the proper acoustics required for the optimum sound space and dynamics.

Note:

The speaker level settings here are not effective for multi-channel input sources. To adjust the speaker levels for multi-channel input sources, you will need to use the CH SEL, LEVEL ▲, and LEVEL ▼ buttons on the RC-440M remote controller. See pages 30, 31.

Calibrating the speaker levels

- (1) When this sub-menu is entered, the TX-DS696 will emit a pink noise from the front left speaker. At this time, the Master volume automatically increases to the reference level (0dB). Remember the level of this noise and then press the ▼ cursor button. (Note that this can be adjusted to any level between –12 and 12 decibels in 1-decibel intervals.) The TX-DS696 will now emit the pink noise from the center speaker.
- (2) Using the ◀ and ▶ cursor buttons, adjust the volume level of the noise from the center speaker so that it is the same level as the front left speaker. You can jog back and forth between the speakers to help you compare the volume levels.
- (3) Press the ▼ cursor button again. The TX-DS696 will now emit the pink noise from the front right speaker.
- (4) Repeat steps (2) and (3) above for the front right and other speakers until all speakers are adjusted to the same volume level.

Note:

- Speakers that you selected “No” or “None” for in the Speaker Config sub-menu will not appear.

a. Left

Sound comes from the front left speaker. Adjust the sound level between –12 and 12 decibels in 1-decibel intervals.

b. Center

Sound comes from the center speaker. Adjust the sound level between –12 and 12 decibels in 1-decibel intervals.

c. Right

Sound comes from the front right speaker. Adjust the sound level between –12 and 12 decibels in 1-decibel intervals.

d. Surr Right

Sound comes from the surround right speaker. Adjust the sound level between –12 and 12 decibels in 1-decibel intervals.

e. Surr Left

Sound comes from the surround left speaker. Adjust the sound level between –12 and 12 decibels in 1-decibel intervals.

f. Subwoofer

Sound comes from the subwoofer. Adjust the sound level between –12 and 12 decibels in 1-decibel intervals.

Setup menus

2. Input Setup menu

This menu allows you to setup the various input sources available with the TX-DS696. Each input source may have a great number of settings that are difficult to keep track of, so we recommend making a chart to record what you have set and for which component to prevent confusion later.

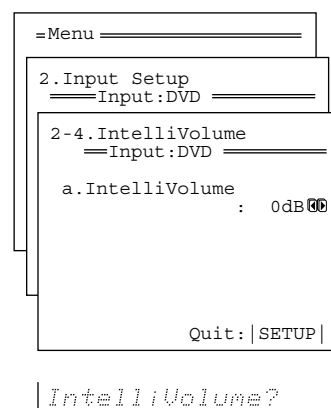
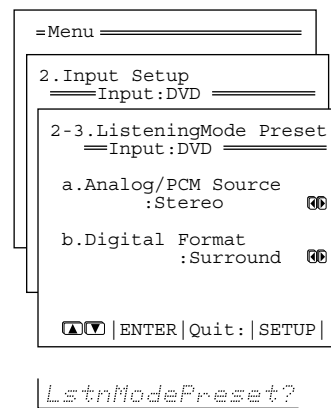
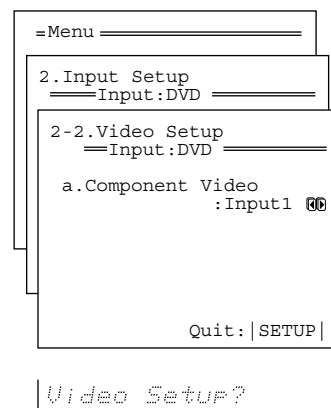
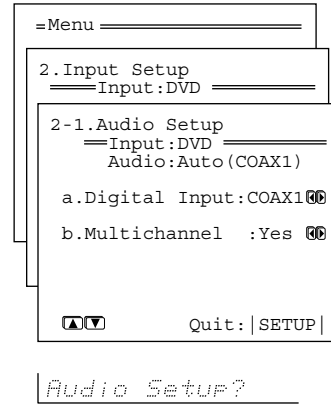
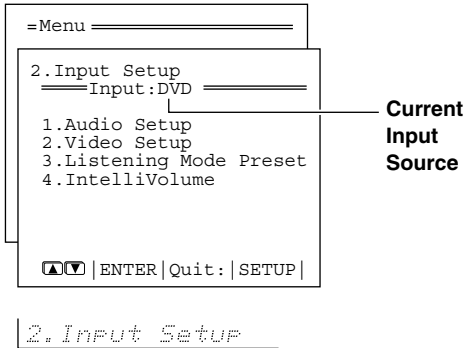

Setup menus

2-1. Audio Setup sub-menu

The settings made in this sub-menu are valid for the input source that is currently selected with the input source buttons at the front panel and, therefore, these settings are made separately for each digital input source. This sub-menu will not appear if the selected input source button is AM or FM. If this setting is incorrectly made, the digital audio signals may not be properly output, or not heard at all.

a. Digital Input

This setting tells the TX-DS696 which input source button on the front panel is connected with which digital input jack on the rear panel. To perform this setting, you must first select a digital input source at the front panel and then set the name of the digital input jack it is connected to here.

For example, if the input source selected at the front panel is CD and the compact disc player is connected to DIGITAL INPUT (OPTICAL) 1, then select "OPT1" here. If the input source selected is not connected to a digital input, then select "----."

OPT1: Select if connected to DIGITAL INPUT (OPTICAL) 1.

OPT2: Select if connected to DIGITAL INPUT (OPTICAL) 2.

COAX1: Select if connected to DIGITAL INPUT (COAXIAL) 1.

COAX2: Select if connected to DIGITAL INPUT (COAXIAL) 2.

----: Select if the input source is not from a digital input jack.

Note:

Do not assign a digital input to more than one input source. If you are making a digital connection that requires you to change the default settings, be sure to always first cancel the current digital input setting and then assign the new setting.



b. Multichannel

This sub-menu will not appear if AM or FM is selected at the front panel for the input source. The initial settings are "Yes" for the DVD input source and "No" for all other input sources. This setting is normally set to "No," and only needs to be changed to "Yes" if a DVD player, MPEG decoder, or other component that has a multi channel port is connected to the MULTI CHANNEL INPUT port for 5.1-channel audio. For example, if a DVD player is connected to the MULTI CHANNEL INPUT port, then select DVD at the front panel as the input source, bring up this sub-menu, and select "Yes" for the Multichannel setting. You can only select Multichannel with the AUDIO SELECTOR button when "Yes" is selected here.

Note:

When playing a device that is actually connected to the MULTI CHANNEL INPUT terminal, select Multichannel with the AUDIO SELECTOR button.

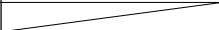
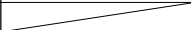
Initial settings for each input source

Input source	Digital input	Multichannel
DVD	COAX 1	Yes
VIDEO1	COAX 2	No
VIDEO2	----	No
VIDEO 3	OPT2	No
VIDEO 4	----	No
TAPE	----	No
FM		
AM		
PHONO	----	No
CD	OPT 1	No

----: Available for digital input but not set in initial settings.

 : Not available for digital input.

2-2. Video Setup sub-menu

a. Component Video

If a component is connected to the one of the COMPONENT VIDEO inputs (1 or 2), then that input must be set here. This setting will not appear if AM, FM, PHONO, CD or TAPE is selected as the input source.

The default settings are given below.

Input source selected	Component video input
DVD	INPUT 1
VIDEO1	INPUT 2
VIDEO2	INPUT 1
VIDEO 3	INPUT 1
VIDEO 4	INPUT 1

Setup menus

2-3. Listening Mode Preset sub-menu

With the TX-DS696, you can set a different listening mode for each different signal type that comes from each input source and also set the parameters for the listening mode itself. For example, if your DVD player also plays compact discs and the DVD video signal is DTS and the compact disc signal is PCM, then you can set a different listening mode for each.

This is especially convenient if you frequently play the same types of movies or music.

Input source signals

a. Analog/PCM Source

Set a listening mode for the input signal from analog sources and PCM sources.

Note:

For PCM sources recorded at a sampling rate of 96 kHz or greater, only the Stereo or Direct listening modes can be selected. However, the set listening mode is stored in memory.

b. Digital Format

Set a listening mode for the input signal from Dolby Digital and DTS sources.

- The TX-DS696 will automatically switch to the listening mode set for the current input signal. For example, even when using the same DVD player, if a CD is played, the listening mode automatically becomes "Stereo," and if a DVD is played (Dolby Digital 3/2.1), the listening mode automatically becomes Dolby D.

2-4. IntelliVolume sub-menu

a. IntelliVolume

When switching input sources, you may find that the output level for different components or input sources connected to the TX-DS696 is different even though the main volume setting is the same. Under normal circumstances, you would then have to change the volume setting each time you change the input source. This IntelliVolume sub-menu allows you to preset a volume level for each input source separately so that when you do switch from one input source to another, the TX-DS696 adjusts the volume accordingly so that the resulting volume stays the same. To set the IntelliVolume, simply select an input source at the front panel, and if that source is quieter than other sources, increase its decibel level with the ► cursor button, or if it is louder than other sources, decrease its decibel level with the ◀ cursor button.

The IntelliVolume can be adjusted between -12 and +12 decibels.

Relationship between input source and listening mode

Input source signal (display)		Analog/PCM Source	Digital Format	
Type of media		Tape, CD, Record, Tuner DVD Video (PCM), LD (PCM) Digital satellite broadcast	DVD, Digital satellite broadcast, DTS-CD	
Listening Mode			Dolby Digital 2ch Source	DTS, All excluding Dolby Digital 2ch
Direct		●		
Stereo		●	●	●
Surround	Pro Logic II (Movie)	●	●	
	Pro Logic II (Music)	●	●	
	Dolby Digital			●
	DTS			●
Orchestra		●		
Unplugged		●		
Studio-Mix		●		
TV Logic		●		
All Ch Stereo		●		

Notes:

- The listening modes that can be set are different for each input source format.
- You may not be able to select all the listening modes shown here depending on your speaker configuration or the selected input source.

Setup menus

3. Listening Mode Setup menu

This menu allows you to make adjustments to the various listening modes. These adjustments are in the form of parameters and each one is explained below. Note that some parameters cannot be set for some listening modes and that no sub-menu will have all parameters. Also, for some input signal formats, changes in the listening mode parameters may actually result in no change to the resulting output signal.

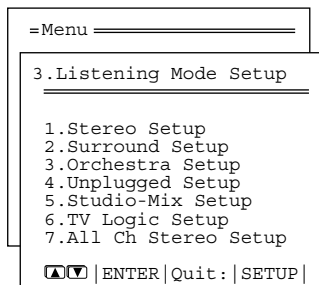

3.LstnModeSetup

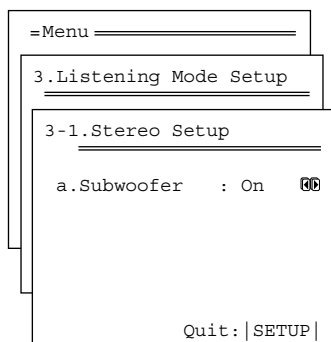

Stereo Setup?

Description listening mode parameters

Subwoofer

Set this to "Off" if you are not using a subwoofer (even if one is connected). If "No" is selected for the Subwoofer setting in the Speaker Config sub-menu, then this setting will not appear.

Front Effect

You can choose from "Low," "Middle," or "High." Some live recordings contain acoustic reverberation. When you play these sources, more reverberation will be applied by the DSP, creating too much reverb effects and the sound loses frame or presence. In this case, set this setting to "Low." No reverberation from the DSP will be applied to the sound output from the three front channels, so the sound source is played as it is without any further reverberation.

Surround Effect

You can choose from "Low," "Middle," or "High." This adjusts the reflected and residual noises from the surround left and right speakers.

Relationship between listening mode and parameter

Listening mode \ Parameter	Direct	Stereo	Surround Dolby Pro Logic II Dolby Digital DTS	Orchestra Unplugged Studio-Mix TV Logic	All Ch Stereo
Subwoofer		Off, On	Off, On	Off, On	Off, On
Front Effect				Low, Mid, High	
Surround Effect				Low, Mid, High	

The parameters that can be set are different for each listening mode.

4. Preference menu

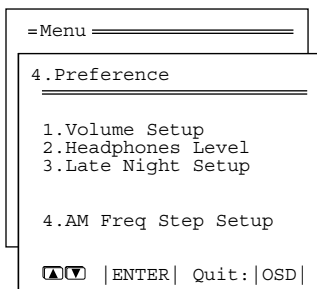

4. Preference

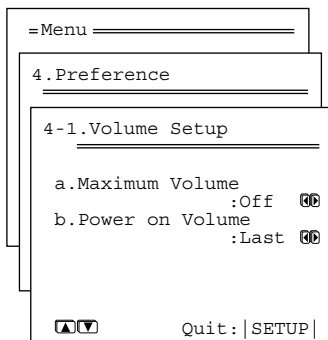

Volume Setup?

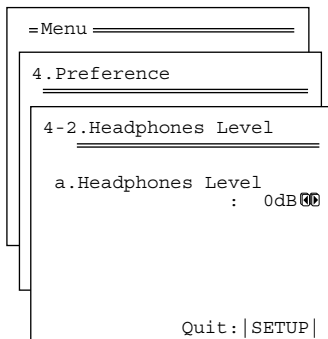

Headphones Lvl?

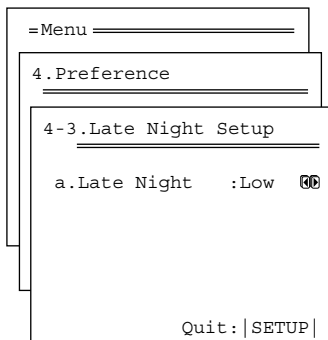

Late Night?

4-1. Volume Setup sub-menu

This sub-menu allows you to make various settings concerning the volume control of the TX-DS696.

a. Maximum Volume

This setting allows you to set the maximum volume that can be output with the MASTER VOLUME dial to prevent components from being damaged by excessively loud volumes. The maximum volume can be set between 30 and 79.

b. Power On Volume

This sets a designated volume setting for the TX-DS696 to be set every time that the power is turned on. This prevents the TX-DS696 from being turned on while it is set to an extremely high volume and suddenly output very loud sounds. The power on volume can be set between min and max. If you do not mind having the TX-DS696 turned on with its current volume setting, set this to "Last."

4-2. Headphones Level sub-menu

a. Headphones Level

You can use this sub-menu to adjust the volume output from the headphones so that it matches the level output from the speakers. The headphone volume can be adjusted between -12 and +12 decibels.

4-3. Late Night Setup sub-menu

a. Late Night

Sets "High," "Low," or "Off" for the late night function.

Cinema sound has a vast dynamic range; therefore, to hear the quieter sounds such as human conversations, they must be played back at larger volumes. When this parameter is set to "High" or "Low," the dynamic range of the sound is narrowed down to allow you to easily hear minute sounds at low volumes. This function is especially useful if you wish to play a movie at low volumes during the nighttime.

Notes:

- The depth of the Late Night effect is determined by Dolby Digital software. Some sounds may produce no or little effect.
- The Late Night function is effective only on Dolby Digital encoded software.

4-4. AM Freq Step Setup sub-menu (Worldwide model only)

a. AM Frequency Step

This sub-menu only appears on the worldwide model. The initial setting is 9 kHz, and this needs only to be changed if you are using the TX-DS696 in a 10-kHz region.

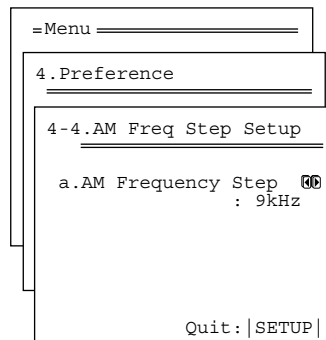

AM Freq Step?

Setup menus

5. OSD Setup menu

This menu provides settings for you to customize the on-screen display (OSD) for the TX-DS696 by setting different colors or positions for its display.

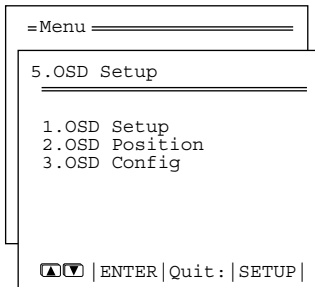

5.OSD Setup

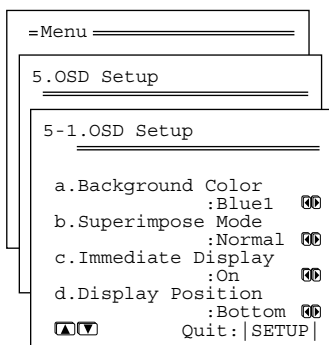

OSD Setup?

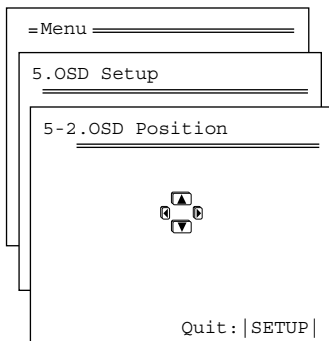

OSD Position?

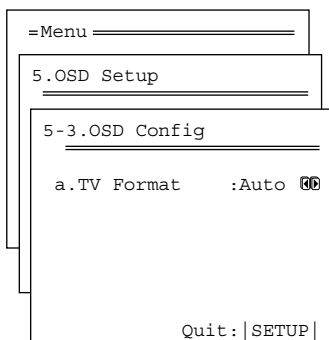

OSD Config?

5-1. OSD Setup sub-menu

This sub-menu allows you to customize the OSD Setup menu to display in the manner you desire.

a. Background Color

Select either Blue1, Blue2, Green1, Green2, Magenta, Red1, or Red2 as the background color while the OSD Setup menu is displayed.

b. Superimpose

Off: Select to have the OSD Setup menu displayed on the selected background color.

Normal: Select to have the OSD Setup menu superimposed over the current video if one is displayed or on the selected background color if there is no video signal.

Black: Select to have the OSD Setup menu displayed on a black background at all times.



c. Immediate Display

On: Select this to have the screen immediately display certain operations as you perform them. The display will remain for a few seconds after the operation is completed.

Off: Select this to turn off the immediate display of operations.

Hint:

If this is set to "Off," the background color will not be displayed even when there is no video signal input.

d. Display Position

Use this setting to select the position of the immediate display that appears when certain operations are performed. You can position the immediate display at any of ten different levels ranging from the top all the way to the bottom.

5-2. OSD Position sub-menu

This sub-menu allows you to adjust the position of the OSD Setup menu as it is displayed on your screen. Depending on the monitor used, there may be cases where the OSD Setup menu is not displayed in the center and parts of the menus are cut off. To adjust the position of the OSD Setup menu, simply press the cursor buttons to inch the menu to position you desire.

5-3. OSD Config sub-menu

a. TV format

(For all models other than USA and Canadian models)

The default setting is "Auto," which means that the television format is detected and automatically set by the TX-DS696. However, if you know the correct format, you can use this setting to choose either PAL or NTSC so that no time is wasted on detection.

Recording

Caution

- Surround and multichannel audio cannot be recorded.
- You cannot perform digital recording with the TX-DS696. Also, digital-to-analog signal conversion is not possible, so to record audio signals from digital sources (e.g. CD players), their analog connection must be made as well.

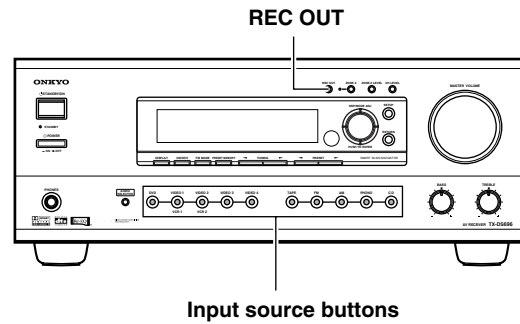

Recording the input source (REC OUT selector)

When using the TX-DS696 to record a source, you must select that source to be output from the TAPE OUT jacks.

Recording the same source that you are listening to:

1. Press the input source button for the source that you want to record.

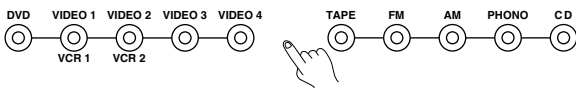

2. Press the REC OUT button repeatedly until "Rec Sel : SOURCE" appears in the front display.

The signal from the currently selected source is also output to the TAPE OUT jacks.

Rec Sel : SOURCE

3. Start recording at the recording device connected to the TAPE OUT jacks.

Note:

Be aware that if you change the input source that you are watching (or listening to), the source being recording will also change.

Recording a source different from that you are listening to:

The TX-DS696 allows you to listen to one source while recording the signal from another source. The procedure below uses the example of recording the audio from a CD player while watching the input from a DVD player.

1. While playing the DVD, press the REC OUT button.



2. Within 3 seconds, press the input source button of the source that you wish to record.

In this example you would press the CD source button. The signal from the CD player is now output to the TAPE OUT jacks.



Rec Sel : CD

3. Start recording at the recording device connected to the TAPE OUT jacks.

You can press the REC OUT button to display which input source is selected for recording. When "Rec Sel : Off" is displayed, no signal is output for recording.

Notes:

- You cannot use the REC OUT selector to record video signals.
- Be aware that the ZONE 2 and REC OUT selectors use the same circuit and therefore cannot be used at the same time.
- Even if you change the input source that you are listening to, the input source that is selected for recording will not change. However, if you have selected FM (or AM) as the source to be recorded and the AM (or FM) source button is pressed, the source being recorded will be changed to the AM (or FM) input signal.

Recording both the audio and video

The TX-DS696 also allows you to record the audio and video signals output from the VIDEO OUT 1 and 2 jacks.

1. Press the input source button for the source you want to record.



2. Start recording at the recording device connected to the VIDEO OUT 1 and 2 jacks.

Note:

Be aware that if you change the input source that you are watching (or listening to), the source being recording will also change.

Hint

You can also record the video from one source and the audio from another source together to make your own home movies and the like. For example, if you want to record the video from a video camera connected to VIDEO 4 and the audio from a CD player connected to CD IN, at step 1 above, press the VIDEO 4 source button and then the CD source button.

Enjoying music in the remote zone

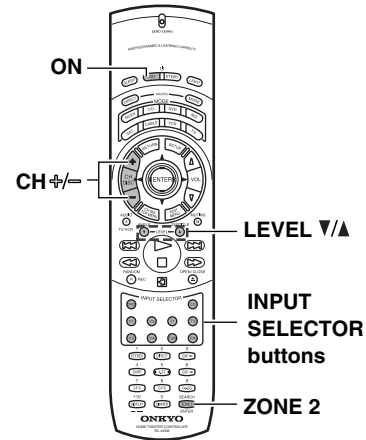
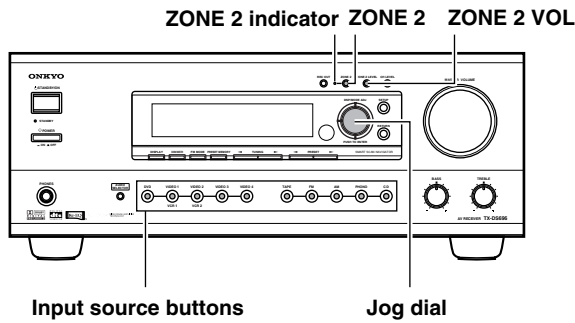

Here is an explanation of how to setup speakers in a room separated from the TX-DS696 so that you can listen to audio sources remotely.

Selecting an input source and adjusting the volume on the TX-DS696

1. Press the ZONE 2 button on the TX-DS696.

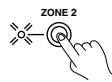

2. Select a source.

After pressing the ZONE 2 button, you must press an input source button within 3 seconds. The ZONE 2 indicator lights.

Ex.: When the CD button is pressed.



Zone2Sel:CD

To select the same source for the remote zone that is selected for the main zone, press the ZONE 2 button again until "Zone2Sel:SOURCE" appears in the display.



Zone2Sel:SOURCE

When "Zone2Sel:Off" is displayed, the output to the remote zone is turned off.

Caution:

If you are not using the system in the remote zone, always press the ZONE 2 button consecutively to turn the ZONE 2 function off.

3. Press the ZONE 2 LEVEL button.

"Zone2 Level" appears for approximately three seconds.



Zone2 Level

4. While "Zone 2 Level" is displayed, turn the jog dial to adjust the volume to the desired level.

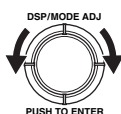

Tip:

When using Zone 2, even if you put the TX-DS696 in the standby state, it will not affect Zone 2 and the volume in Zone 2 can still be adjusted. Moreover, components that have their power supply connect to the AC OUTLET connector on the TX-DS696 will not be turned off.

Selecting an input source and adjusting the volume using the remote controller

Turning on the Zone 2 and putting it in the standby state when the TX-DS696 is in the standby state:

After pressing the ZONE 2 button, press the ON/STDBY button within 5 seconds.

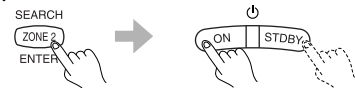

Selecting an input source:

After pressing the ZONE 2 button, press an input source button within 5 seconds.

If tuner is selected with the TUN button, the CH +/- button becomes enabled.

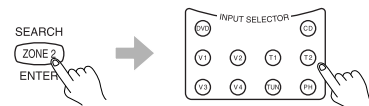

Adjusting the volume:

After pressing the ZONE 2 button, adjust the volume using the LEVEL ▲/▼ buttons within 5 seconds.



Notes:

- If you wish to use the remote controller from a separate room or other location where the signals will not reach the TX-DS696, you will need to purchase a commercially available remote control sensor and emitter.
- After you press the ZONE 2 button on the remote controller, the STANDBY indicator on the TX-DS696 flashes for five seconds. During this time, you will not be able to perform operations in the main zone using the remote controller.
- If the source for the main zone is selected as the source for the remote zone and the source for the main zone is changed, then the source for the remote zone will change as well.
- In the remote zone, you can only play the source in the 2-channel mode. You cannot play the source in the remote zone in the surround mode.
- When you are listening to a source in the remote zone (Zone 2), you can only play sources in the Stereo or Direct modes in the main zone. Therefore, when sources playing from the multichannel input in the main zone, audio from the left and right surround speakers will not be output.
- The REC OUT and ZONE 2 buttons use the same circuit and therefore cannot be used at same times. If the REC OUT button is pressed in the main room while someone is using the system in the remote zone, the Zone 2 function will be deactivated and the source will turn off in the remote zone.
- The Zone 2 terminal is an analog output. Digital signals are not output. If no sound is heard from the selected input source, check if the component is connected to the analog inputs.

Using remote controller

Overview

The RC-440M remote controller is a useful tool to help you operate the components of your home theater. To do so, first press the Mode button that corresponds to the device you wish to control. Then simply press the desired operation button and the component will operate accordingly. For example, if you wish to select the CD input source at the TX-DS696 with the remote controller, first press the RCVR MODE button to select the TX-DS696 and then press the CD (INPUT SELECTOR) button.

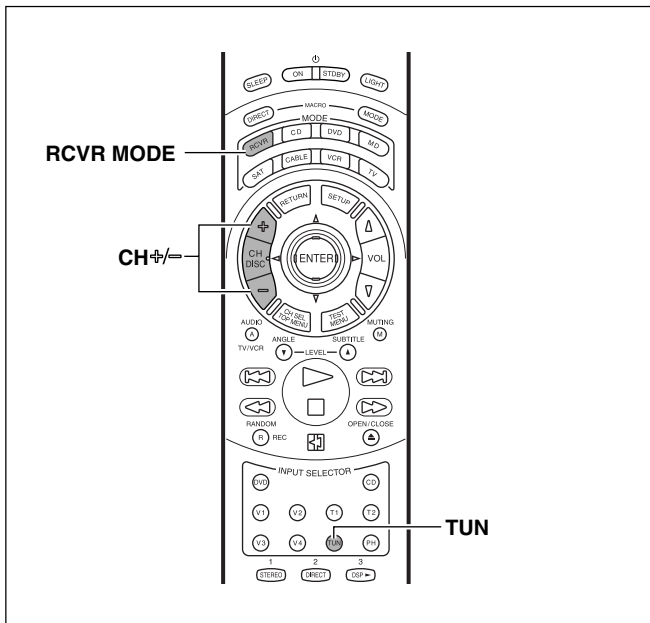

Calling up a preset radio station

1. Press the **RCVR MODE** button.
The RCVR MODE button lights green.
2. Press the **TUN** input selector button.
3. Press the **CH +** or **=** button to select the desired preset station number.

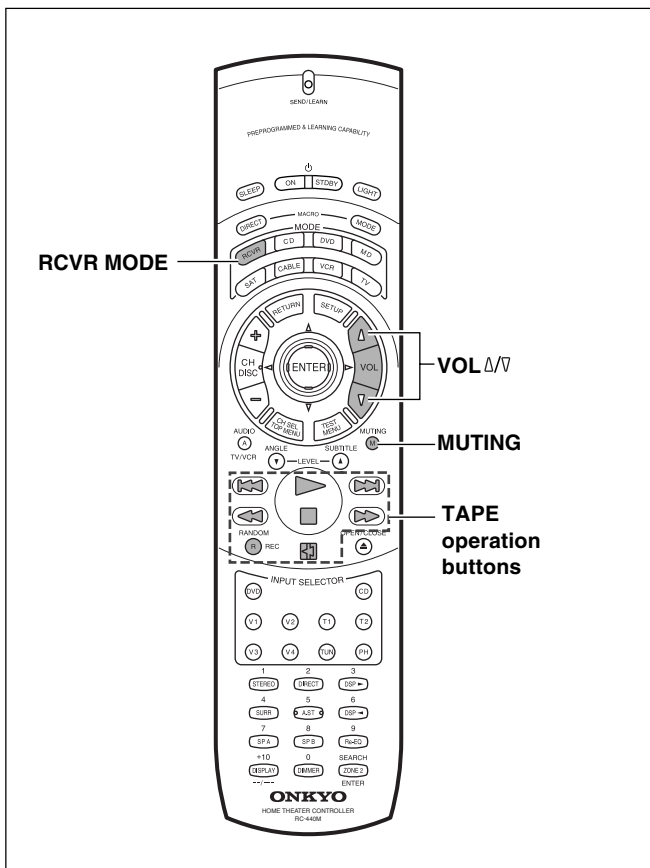

Controlling an Onkyo cassette tape deck

The **RI** connector of the Onkyo cassette tape deck must be connected to the TX-DS696 (see page 16).

1. Press the **RCVR MODE** button.
The RCVR MODE button lights green.
2. Press the **desired operation button**.
The buttons shaded in the figure to the left are the operation buttons that can be used to control an Onkyo cassette tape deck.

Operation buttons:

- ▷: Play
- ◻: Stop
- ◀: Rewind
- ▶: Fast forward
- ⏩: Press during playback to skip to the beginning of the next track.
- ⏪: Press during playback to skip to the beginning of the current track.
- R (Rec)**: Record/Pause
- ⏮: Reverse playback

You may also use the following buttons:

VOL Δ/V: Adjusts the volume at the TX-DS696

MUTING: Activates the muting function at the TX-DS696

Note:

Even for devices with the ⏩ and ⏪ buttons, signal discrepancies may cause them not to work properly.

Using remote controller

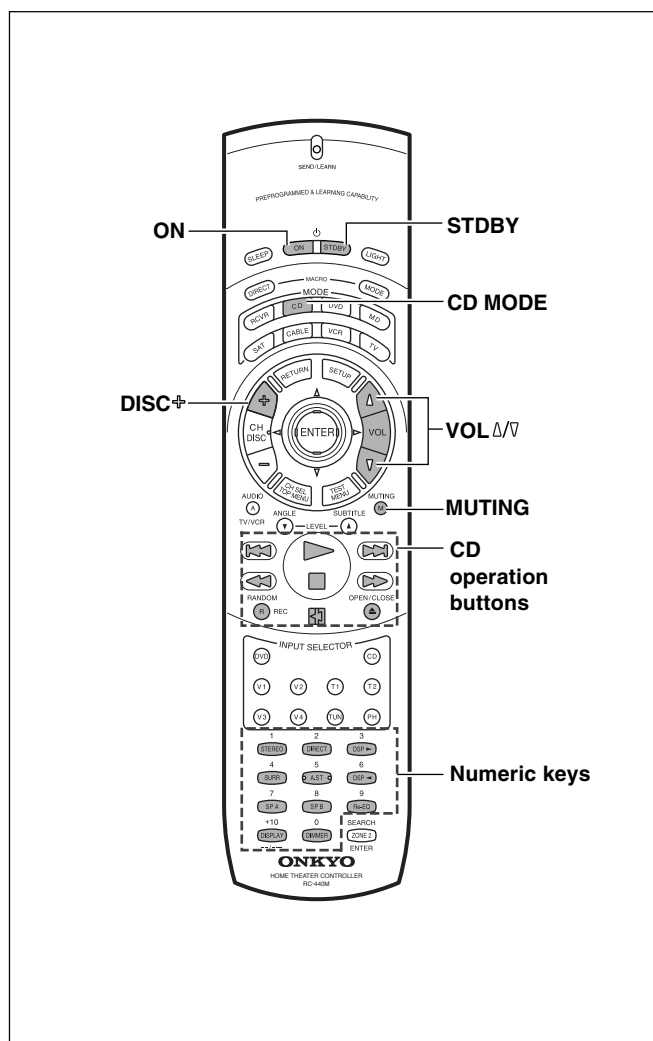

Controlling an Onkyo CD player

The **RI** connector of the Onkyo compact disc player must be connected to the TX-DS696 (see page 16).

1. Press the CD MODE button.

The CD MODE button lights green.

2. Press the desired operation button.

The buttons shaded in the figure to the left are the operation buttons that can be used to control an Onkyo compact disc player.

Operation buttons:

ON: Turns on and off the compact disc player (same as **STDBY** button on the remote controller).

DISC +: Selects a disc in the CD changer

⏮: Track down

⏭: Track up

▶: Play

⏹: Stop

⏪: Fast reverse

⏩: Fast forward

⏸: Pause

OPEN/CLOSE ▲: Open/close the disc tray

0, 1 to 9, +10: Numeric keys

RANDOM/R: For random playback.

You may also use the following buttons:

VOL Δ/∇: Adjusts the volume at the TX-DS696

MUTING: Activates the muting function at the TX-DS696

Using remote controller

Controlling an Onkyo DVD player

The **RI** connector of the Onkyo DVD player must be connected to the TX-DS696 (see page 16).

1. Press the DVD MODE button.

The DVD MODE button lights green.

2. Press the desired operation button.

The buttons shaded in the figure to the left are the operation buttons that can be used to control an Onkyo DVD player.

Operation buttons:

ON: Turns the DVD player on and off

STDBY: Turns the DVD player off. (Some sets may not respond to this button. In this case, use the ON button to put the DVD player in the standby state.)

SETUP: Displays the menu

Δ/∇/◀/▶: Moves the cursor

ENTER: Confirms the selection

RETURN: Return button

TOP MENU or MENU: Displays the menu screen(s) recorded on DVD media.

DISC ◀/▶: Selects a disc in the DVD changer.

AUDIO: Press repeatedly to select an audio and/or language track recorded on a DVD-Audio/Video.

ANGLE: Press repeatedly to select a camera angle when a DVD-Video is recorded with multiple angle playback.

SUBTITLE: Press repeatedly to select one of the subtitle languages recorded on a DVD-Video.

SEARCH: Press to find the specific section on a disc where you want to start playback.

RANDOM/R: Press to start random playback.

⏮: Chapter/Track down

⏭: Chapter/Track up

▶: Play

□: Stop

⏪: Fast reverse

⏩: Fast forward

⏸: Pause

OPEN/CLOSE ▲: Open/close the disc tray

0, 1 to 9, +10: Numeric keys

You may also use the following buttons:

VOL Δ/∇: Adjusts the volume at the TX-DS696

MUTING: Activates the muting function at the TX-DS696

Note:

When operating an Onkyo DVD player directly with the remote controller without connecting the **RI** terminals, pre-programming is necessary (see page 50).

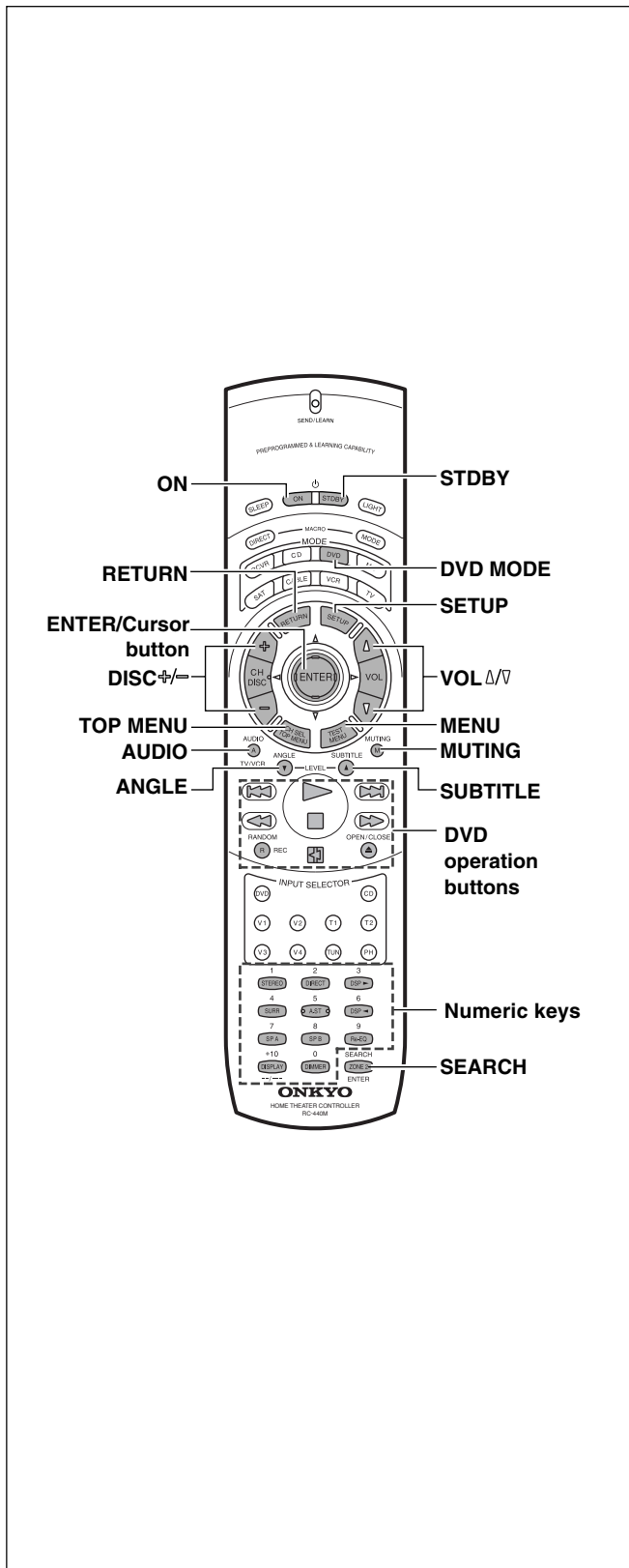

Using remote controller

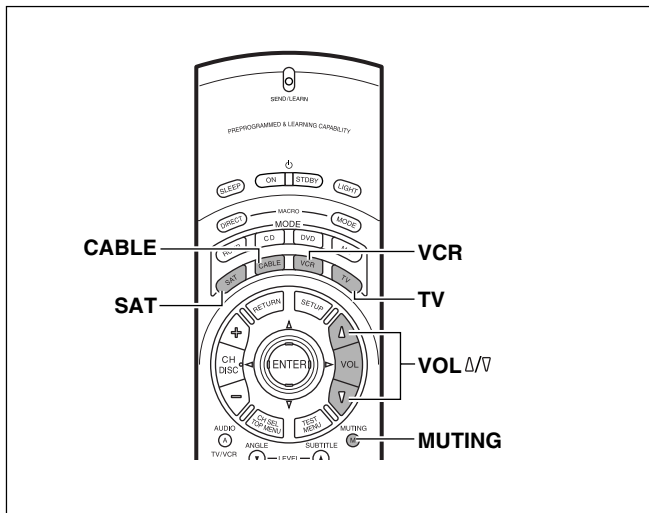
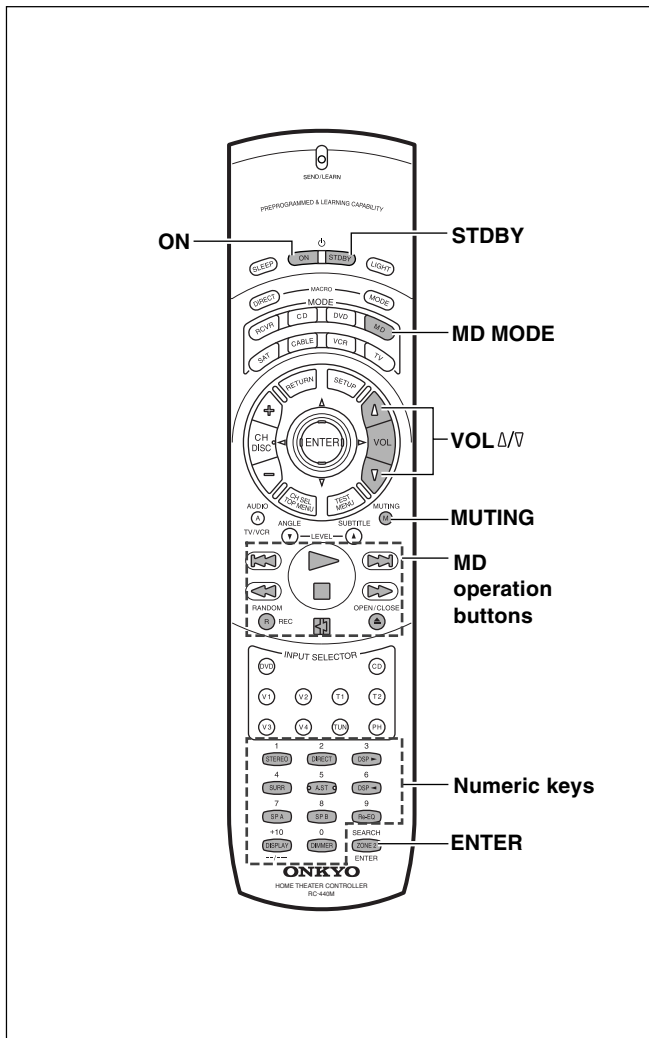

Controlling an Onkyo MD recorder

The **RI** connector of the Onkyo MD recorder must be connected to the TX-DS696 (see page 16).

1. Press the MD MODE button.

The MD MODE button lights green.

2. Press the desired operation button.

The buttons shaded in the figure to the left are the operation buttons that can be used to control an Onkyo MD recorder.

Operation buttons:

ON: Turns on and off the MD player (same as **STDBY** button on the remote controller).

: Track down

: Track up

: Play

: Stop

: Fast reverse

: Fast forward

R (Rec): Record

: Pause

: Eject the disc

1 to 9, 0, --/--: Numeric keys

ENTER: Enters the settings

You may also use the following buttons:

VOL Δ/V: Adjusts the volume at the TX-DS696

MUTING: Activates the muting function at the TX-DS696

SAT, CABLE, VCR, and TV MODE buttons

No preset codes are programmed into the SAT, CABLE, VCR, and TV MODE buttons. You can use these buttons to program the remote controller signals of other devices.

There are two methods. One method is selecting the name of a different brand from the table, entering the setting number listed, and calling up the pre-programming code (see page 50). The other method is learning the commands from the other brand's remote control directly into this remote controller (see page 54).

When in the SAT, CABLE and VCR mode, you may use the following buttons:

VOL Δ/V: Adjusts the volume at the TX-DS696

MUTING: Activates the muting function at the TX-DS696

Learning a pre-programming code

The remote controller has three learning functions. One is entering the signal number for a remote controller of another brand that is pre-programmed. Another is a normal learning function that enables the remote controller to learn the codes from other remote controllers. And the last is a macro learning function that enables you to program a series of operations into the remote controller so that the operations can all be performed at once by pressing one button.

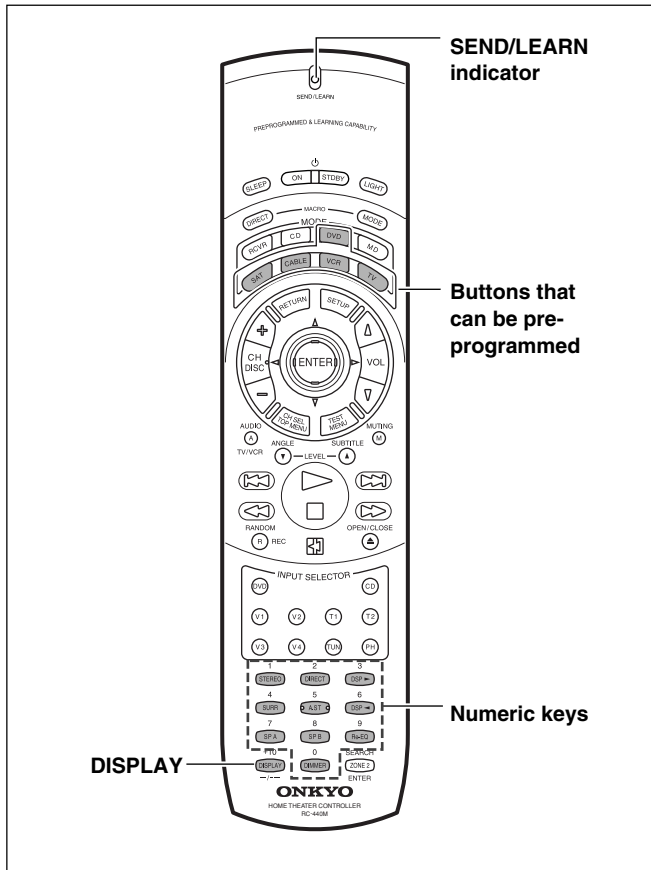

Caution

With some brand's components, some buttons may not work correctly. In this case, program the command separately.

Learning a pre-programming code

By learning a pre-programming code, you can make the RC-440M remote controller able to operate a product from another brand. The buttons that are used for operation are given on the next page.

1. **Find the 3-digit number for the brand name of the component that you want to operate in the table on the next page.**
2. **Turn on the component that you want to operate (i.e. DVD, satellite tuner, or television).**
3. **While holding down the MODE button on the RC-440M that you want to program, press the DISPLAY button, and then release both buttons.**

The SEND/LEARN indicator lights when the MODE button is pressed and turns off when the DISPLAY button is pressed. Wait until the indicator turns off before releasing both buttons. Then the SEND/LEARN indicator lights again.

4. **Within 30 seconds, enter the 3-digit code number.**

The SEND/LEARN indicator flashes twice slowly. If the SEND/LEARN indicator quickly flashes three times, then either a mistaken 3-digit code was entered or an incorrect operation was performed. If this occurs, return to step 3.

5. **Press the button that you programmed and check if the system operates correctly.**

If the component turns off, the code is correct. If the component does not turn off, return to step 3.

6. **If it still does not operate properly, then program the commands one by one to the buttons on the RC-440M remote controller.**

When entering the code of Onkyo DVD players:

There are three SETTING numbers. Choose the SETTING number according to how you will be using the DVD player.

No. 601/613: These codes are for operating the Onkyo DVD player by pointing the remote controller directly at it, either because it does not have an **RI** terminal, or it does but you are not using an **RI** cable and connecting it. First enter 601 and if it does not operate properly, enter 613.

No. 600: This code is for Onkyo DVD players that have an **RI** terminal that you are connecting to the TX-DS696 with an **RI** cable. You will then operate the DVD player by pointing the remote controller at the remote control sensor on the TX-DS696. You do not need to enter this code because it is factory preset. However, if the code has been changed to 601 or 613, then you will need to change it back to 600.

Learning a pre-programming code

Pre-programming codes

Note:

If more than one code is given in the table, try the code one by one until you reach the code for your component (i.e. if the first code does not work, then try the next).

DVD

BRAND	SETTING No.
DENON	602, 609
HITACHI	603
JVC	604
KENWOOD	605
MAGNAVOX	606, 613
MARANTZ	607
mitsubishi	608, 613
ONKYO	600, 601, 613
PANASONIC	609
PIONEER	610
PROSCAN	611
RCA	611
SONY	612
TOSHIBA	613
YAMAHA	609, 614
ZENITH	613, 615

SAT

BRAND	SETTING No.
ECHOSTAR	700
GENERAL	
INSTRUMENTS	701
HITACHI	702
HUGHES	
NETWORK	
SYSTEMS	703
PANASONIC	704
PRIMESTAR	705
PROSCAN	706, 707
RCA	706, 707
SONY	708
TOSHIBA	709

CABLE

BRAND	SETTING No.
GENERAL	
INSTRUMENTS	500
GEMINI	501
HAMLIN	502, 503, 504, 505
JERROLD	500, 506, 507, 508, 509, 510, 511, 512, 513, 514
MACOM	515, 516, 517
MAGNAVOX	518
OAK	519, 520, 521
PANASONIC	522, 523
PHILIPS	524, 525, 526, 527, 528, 529
PIONEER	530, 531
SCIENTIFIC	
ATLANTA	532, 533, 534
SAMSUNG	535
TOCOM	536
ZENITH	537, 538

VCR

BRAND	SETTING No.
AIWA	300, 301, 302
AKAI	303, 304, 305, 306, 307
BAIRD	308
BELL & HOWELL	309
BLAUPUNKT	310
CGM	311, 312, 313
COLTINA	314
DAEWOO	315, 316
DIGITAL	317
EMERSON	318, 319, 320, 321, 322
FENNER	323
FISHER	324, 325, 326, 327
FUJITSU GENERAL	328
FUNAI	329
GE	330, 331
GO VIDEO	332, 336, 337
GOLDSTAR	333, 334
GOODMANS	335
GRUNDIG	338
HITACHI	339, 340, 341
JVC	342, 343, 344, 345, 346, 347, 348, 349, 350
LOEWE	351, 352
MAGNAVOX	353, 354, 355
MITSUBISHI	356, 357, 358, 359, 360, 361, 362, 363, 364
NEC	365, 366, 367
NOKIA	313
NORDMENDE	368, 369, 370
OKANO	371, 372
ORION	319, 373
PANASONIC	374, 375, 376, 377, 378
PHILIPS	353, 379, 380
PHONOLA	311
PIONEER	381
RCA	382
SABA	383
SAMSUNG	384, 385, 386, 387, 388, 389, 390
SANYO	391, 392, 393
SCOTT	394
SELECO	395
SHARP	396, 397, 398, 399
SHINTOM	400
SIEMENS	401
SONY	402, 403, 404, 405, 406, 407, 408, 409, 410, 411, 412, 413
SYMPHONIC	414
TEKNIKA	414, 415
TELEFUNKEN	416, 417
TOSHIBA	418, 419, 420
WHITE	
WESTINGHOUSE	333
WATSON	421
ZENITH	422

TV

BRAND	SETTING No.
AIWA	100, 101
AKAI	102, 103, 104
AUDIOSONIC	105
BELL & HOWELL	106
BLAUPUNKT	107
BRIONVEGA	108, 109
CENTURION	110
COLTINA	111, 112, 113
CORONAD	114
CROWN	115, 116
DAEWOO	117, 118, 119, 120, 121
DUAL	122
EMERSON	123, 124, 125, 126, 127
FENNER	128, 129
FERGUSON	130, 131
FISHER	132
FUNAI	133, 134, 135
FUJITSU GENERAL	136, 137, 138
GE	139, 140, 141
GOLDSTAR	142, 143
GOODMANS	144
GRUNDIG	145, 146
HITACHI	147, 148, 149, 150
HYPER	151
INNO HIT	152
IRRADIO	103
JVC	153, 154, 155, 156, 157
KENDO	158
KTV	159, 160
LUXOR	161
MAGNAVOX	162, 163
MARANTZ	164
MARK	165
MATSUI	166, 167, 168, 169
MITSUBISHI	170, 171, 172, 173
MIVAR	174, 175
NEC	176, 177
NOKIA	178, 179, 180, 181
OCEANIC	181
NORDMENDE	182, 183
OKANO	152
ORION	184, 185, 186
PANASONIC	187, 188, 189, 190
PHILIPS	152, 162, 191
PIONEER	192, 193
PROSCAN	194
QUASAR	195
RADIO SHACK	196
RCA	110, 141, 197, 198, 199, 200
SABA	182, 183, 201
SAMSUNG	202, 203, 204, 205, 206, 207, 208
SANYO	209, 210, 211, 212
SCHNEIDER	103
SEARS	213
SELECO	214, 215
SHARP	216, 217
SONY	218, 219, 220, 221, 222, 223
SYMPHONIC	224, 225
TELEFUNKEN	201, 226, 227
THOMSON	228
TOSHIBA	213, 229
UNIVERSUM	230
ZENITH	231, 232

Operating your programmed remote controller

After performing the procedure given above, the following modes become enabled for use.

DVD MODE (DVD Player Mode)

Buttons with programmed usage and operations are the same as the operational buttons on page 48.

SAT MODE (Satellite Tuner Mode)

1. Press the SAT MODE button.

The SAT button lights green.

2. Press the desired operation button.

The buttons shaded in the figure to the left are the operation buttons that can be used to control your satellite tuner unit.

The buttons given below have operations programmed into them.

ON: Turns on and off the satellite tuner unit (same as **STDBY** button on the remote controller)

CH +/-: Moves up and down the preset channel numbers

Δ/∇/◀/▶: Moves the cursor

ENTER: Confirms the selection

MENU: Displays the menu

0,1 to 9: Numeric keys

ENTER: Confirm

You may also use the following buttons:

VOL Δ/∇: Adjusts the volume at the TX-DS696

MUTING: Activates the muting function at the TX-DS696

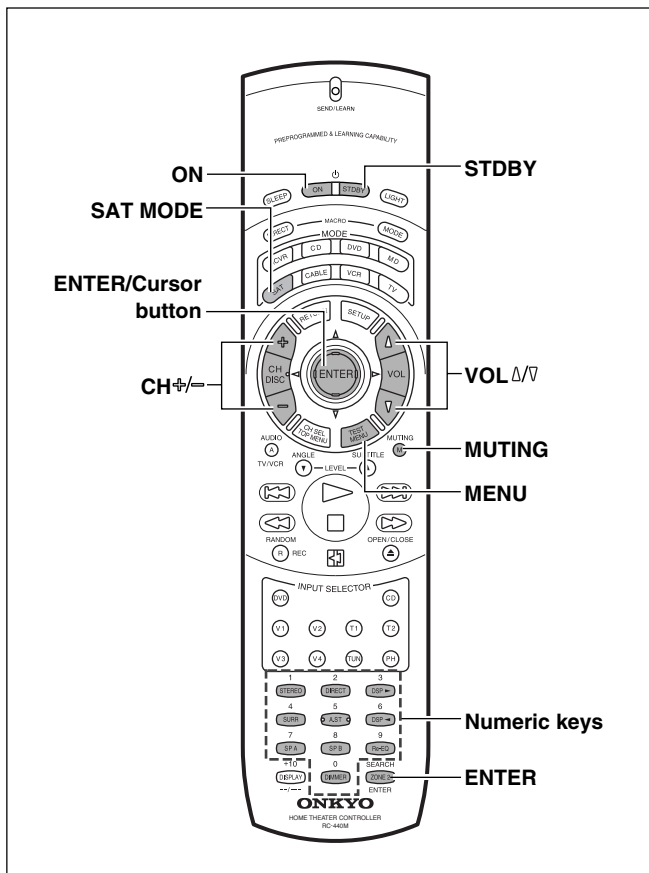

CABLE MODE (Cable Tuner Mode)

1. Press the CABLE MODE button.

The CABLE button lights green.

2. Press the desired operation button.

The buttons shaded in the figure to the left are the operation buttons that can be used to control your cable tuner unit.

The buttons given below have operations programmed into them.

ON: Turns on and off the cable tuner unit (same as **STDBY** button on the remote controller)

CH +/-: Moves up and down the preset channel numbers

0,1 to 9: Numeric keys

ENTER: Confirm

You may also use the following buttons:

VOL Δ/∇: Adjusts the volume at the TX-DS696

MUTING: Activates the muting function at the TX-DS696

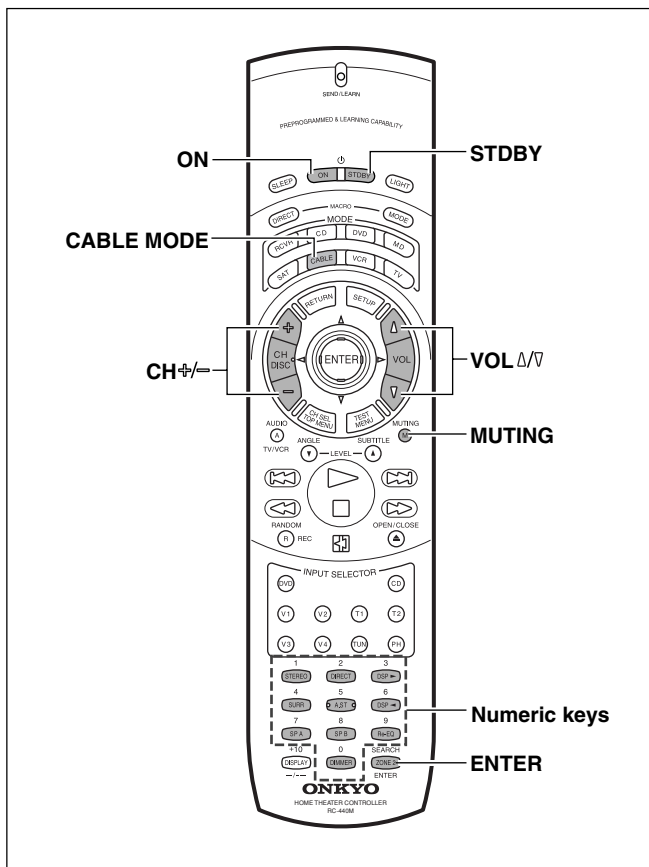

Operating your programmed remote controller

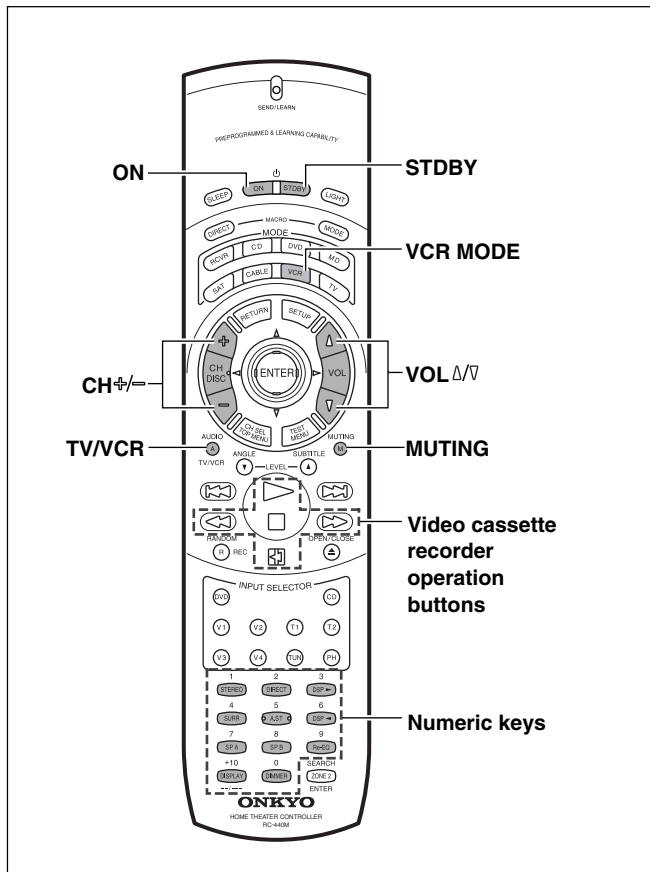

VCR MODE (VCR Mode)

1. Press the **VCR MODE** button.

The VCR button lights green.

2. Press the **desired operation button**.

The buttons shaded in the figure to the left are the operation buttons that can be used to control your VCR.

The buttons given below have operations programmed into them.

ON: Turns on and off the VCR (same as **STDBY** button on the remote controller)

CH +/-: Moves up and down the preset channel numbers

TV/VCR: Switches the AV input for the VCR

▶: Play

□: Stop

◀: Rewind

▶▶: Fast Forward

⏸: Pause

0,1 to 9, +10: Numeric keys

You may also use the following buttons:

VOL +/-: Adjusts the volume at the TX-DS696

MUTING: Activates the muting function at the TX-DS696

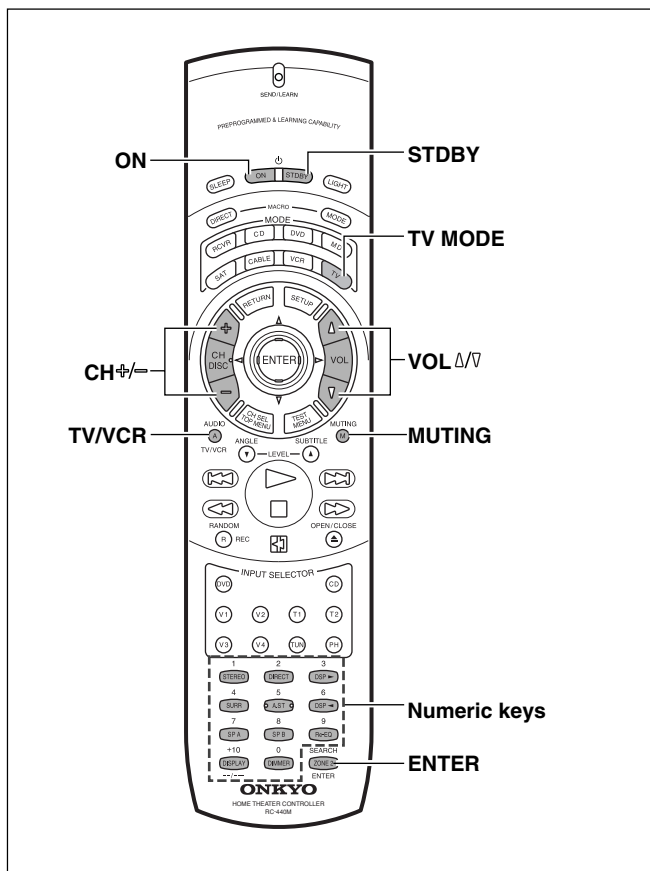

TV MODE (TV Mode)

1. Press the **TV MODE** button.

The TV button lights green.

2. Press the **desired operation button**.

The buttons shaded in the figure to the left are the operation buttons that can be used to control your television.

The buttons given below have operations programmed into them.

ON: Turns on and off the television (same as **STDBY** button on the remote controller)

CH +/-: Moves up and down the television channels

TV/VCR: Switches the TV/VCR input for the television

0,1 to 9, +10: Numeric keys

ENTER: Confirm

VOL +/-: Adjusts the volume at the television

MUTING: Activates the muting function at the television

Programming the commands of remote controllers for other devices into the remote controller

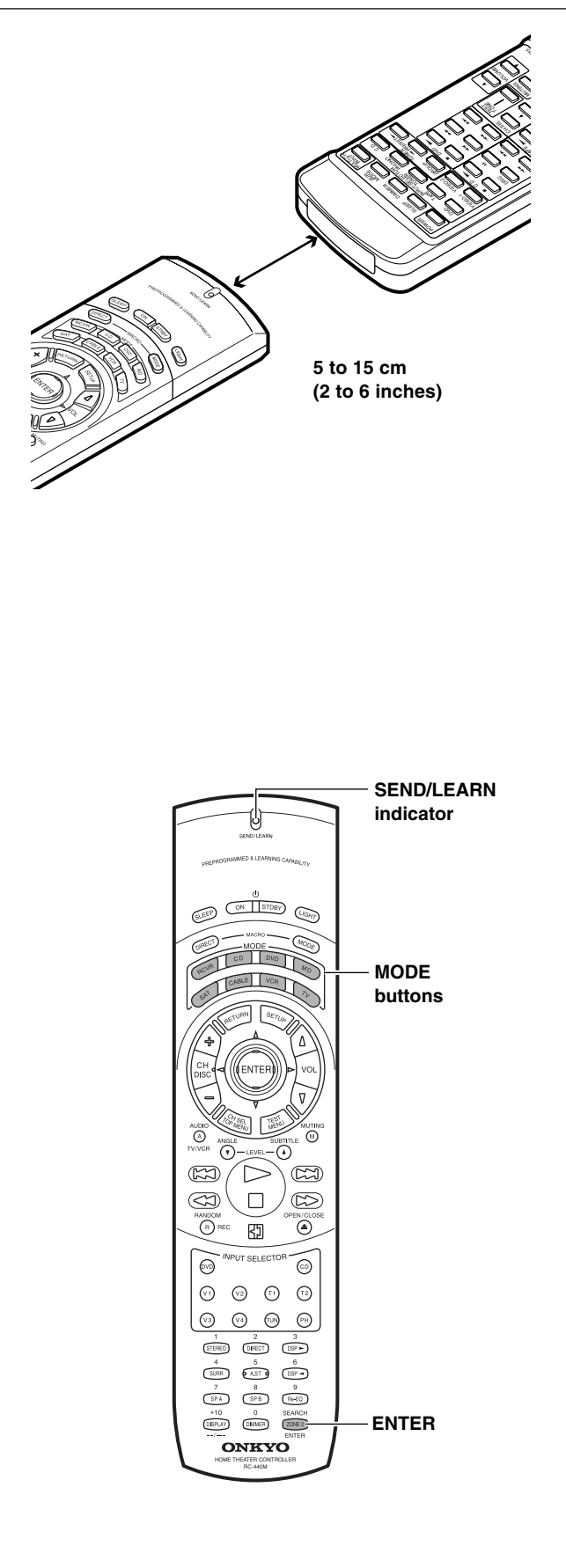

Programming procedure

When programming the commands of another remote controller to the RC-440M remote controller, you must first decide under which MODE button you want the commands to be linked. In general, you will select the MODE button that corresponds to the component you are programming. For example, if you are programming the functions from a remote controller for a compact disc player, you would choose the CD MODE button. Then, by pressing the CD MODE button, the buttons on the RC-440M remote controller will change to the commands you program here to operate the compact disc player.

After programming which MODE button to use, you will then transfer the separate commands from the other remote controller one at a time. Each command is then programmed to a different button on the RC-440M remote controller. Any button is programmable for this step except for the eight MODE buttons (RCVR, CD, DVD, MD, SAT, CABLE, VCR, and TV), the two MACRO buttons (DIRECT and MODE), and the LIGHT button.

Even after the commands have been memorized, keep your old remote controller in a safe place. If for some reason the commands are lost (e.g., when the batteries run down), it will be necessary to memorize them once again.

1. Place the remote controller and the remote controller for the other device facing each other at a distance of 5 to 15 cm (2 to 6 inches) apart.

2. While pressing and holding down the desired MODE button on the remote controller, press the ENTER button and then release both buttons.

When you press and hold down the MODE button, the SEND/LEARN indicator lights. When you press the ENTER button, the lamp turns off. When you release the buttons, the lamp lights again.

3. Press and release the button on the remote controller to which you want to transfer the next command.

You may select any button but the eleven ones indicated in the figure below. When you press the button, the SEND/LEARN indicator turns off. When you release the button, the indicator lights again.

If you press the wrong button by mistake, press that same button again. The SEND/LEARN indicator flashes twice, and the remote controller exits the programming mode.

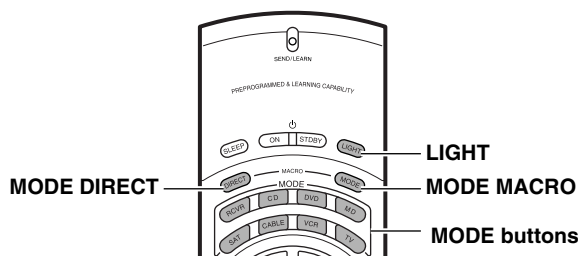

■ : Buttons that cannot be programmed.

Programming the commands of remote controllers for other devices into the remote controller

- 4. Press and hold down the button (that corresponds to the command you are programming) on the remote controller of the other device until the SEND/LEARN lamp on the remote controller flashes twice.**

After flashing twice, the SEND/LEARN indicator will light again.

- 5. Repeat Steps 3 and 4 to transfer all the commands you desire from the other remote controller and program them to buttons on the remote controller under the same MODE.**

Repeat Steps 2 through 4 to program commands to a different MODE (e.g., when programming from a different remote controller).

- 6. Press the MODE button that you pressed in step 2 to complete the programming.**

- 7. Operate the newly programmed buttons to make sure the learning function was performed properly.**

Notes:

- The remote controller codes for Onkyo compact disc players, cassette tape decks, DVD players, and mini disc recorder have already been programmed into buttons on the remote controller. You may, however, use these buttons to program the codes for other remote controllers. If you wish to restore the Onkyo preset codes after you program new codes, you must first erase the new codes (see page 56).
- The remote controller has 408 memory slots (8 modes × 51 buttons). Some remote controllers may have more commands that can be remembered by the remote controller. In such cases, it will be necessary for you to determine which commands are more important than others.
- If no button is pressed for more than 30 seconds during the programming, or if you perform an invalid operation during programming, the SEND/LEARN indicator flashes three times quickly, and the remote controller exits the programming mode. Resume from Step 2.
- If a failure occurs during programming, the SEND/LEARN indicator flashes three times quickly, and the remote controller exits the programming mode. Resume from Step 3.
- If a failure occurs five times in row during programming, the remote controller exits the programming mode. Resume from Step 3.
- If you try to program beyond the learning capacity of the remote controller, the SEND/LEARN indicator flashes six times quickly, and the remote controller exits the programming mode. Try programming under a different MODE button.
- When you want to program a command to a button to which you have already programmed a command, simply follow the same procedure given and programming for that button will be overwritten.
- The remote controller uses infrared rays to send its commands, as do most other remote controllers. Though most remote controller codes can be memorized by the remote controller, be aware that some remote controllers use a system that is quite different from the remote controller and therefore may not be able to be programmed.
- Some remote controllers have a single button that performs multiple functions (for example, the function may change each time the button is pressed). If this is the case, each function must be programmed to a separate button on the remote controller.
- Once you have transferred the commands from the other remote controller, refer to the instruction manual that came with that product for instructions on how to operate that product.
- Make sure both the remote controller and the other remote controller have new batteries. If either of them has batteries that are low, you may not be able to program the commands of the other remote controller properly into the remote controller.

See page 56 for how to erase the memorized commands from all buttons.

Programming the commands of remote controllers for other devices into the remote controller

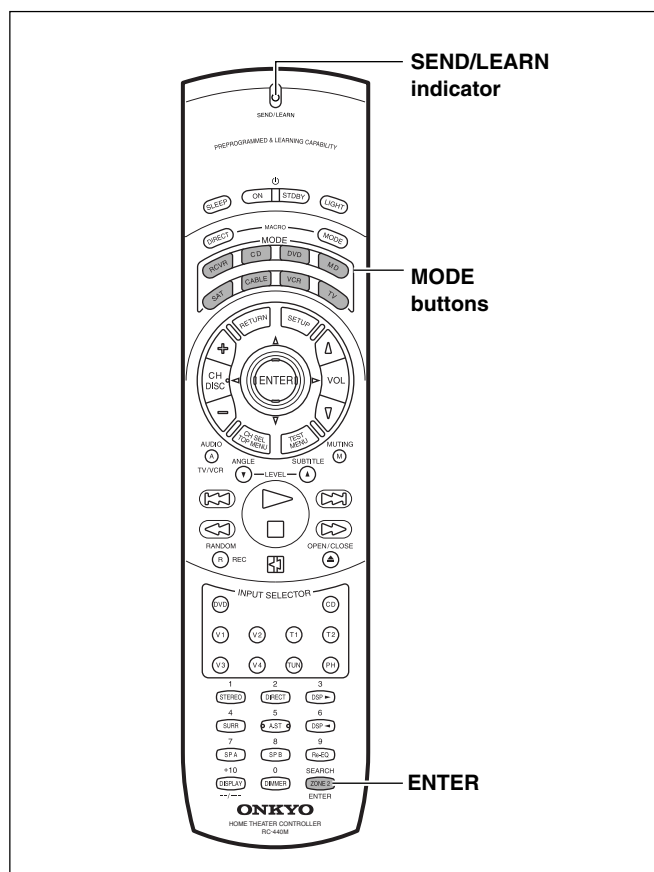

Erasing the programmed command from one button

You can only erase memorized commands and not preset ones.

1. **Press and hold down the desired MODE button for the command, press the ENTER button, and then release both buttons.**

When you press the MODE button, the SEND/LEARN indicator lights. When you press the ENTER button, the lamp turns off. When you release the buttons, the lamp lights again.

2. **Press and release the button for the command you wish to erase.**

When you press the button, the SEND/LEARN indicator turns off. When you release the button, the lamp lights again.

3. **Press and release the same button again.**

The SEND/LEARN lamp flashes twice slowly. The memorized command is erased.

Note:

If no button is pressed for more than 30 seconds during the erasing procedure, the SEND/LEARN indicator flashes three times quickly, and the remote controller exits the erasing mode. Resume from Step 1.

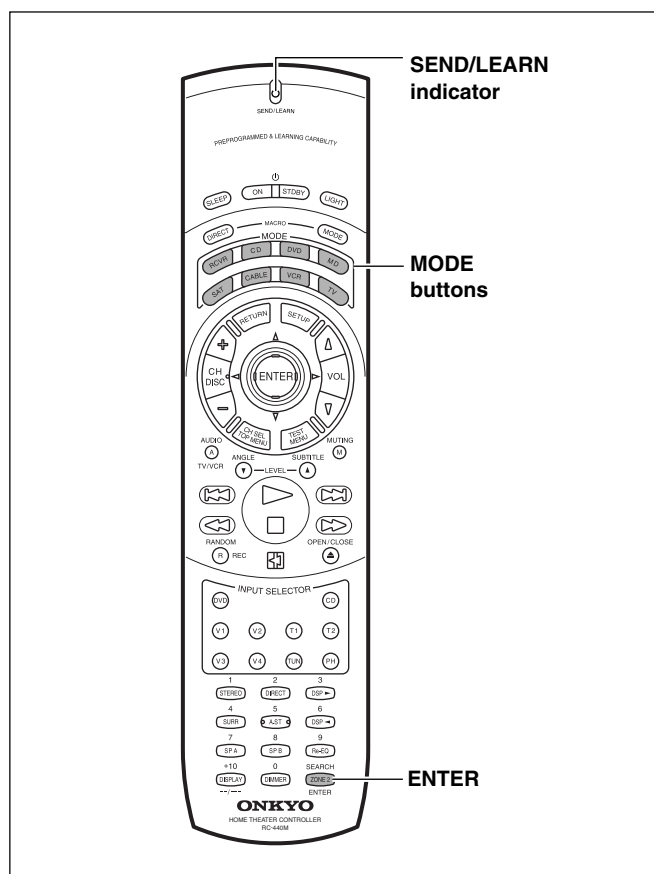

Erasing all the commands programmed under a MODE button

1. **Press and hold down the desired MODE button, press the ENTER button twice, and then release both buttons.**

When you press the MODE button, the SEND/LEARN indicator lights. When you press the ENTER button, the lamp turns off. When you release the buttons, the lamp flashes twice slowly and then lights again.

2. **Press and release the same MODE button again.**

When you release the button, the SEND/LEARN indicator flashes twice slowly. This erases all the commands memorized to the MODE button.

Notes:

- If no button is pressed for more than 30 seconds during the erasing procedure, the SEND/LEARN indicator flashes three times quickly and the remote controller exits the erasing mode. Resume from Step 1.
- If you perform an invalid operation during erasing, the SEND/LEARN indicator flashes three times quickly, and the remote controller exits the erasing mode. Resume from Step 1.
- If many commands have been programmed to the MODE button, then the SEND/LEARN indicator may remain lit for up to 20 seconds during Step 2. This is not a malfunction.

Using a Macro function

What is a Macro function?

A Macro function enables you to program a series of button operations (up to 16) on the remote controller into a single button. For example, to play a compact disc player connected to the TX-DS696 normally, you must perform the following steps:

1. Press the RCVR MODE button.
2. Press the ON button.
3. Press the CD (INPUT SELECTOR) button.
4. Press the CD MODE button.
5. Press the playback (▷) button.

By using the macro function, you can perform the above five operations by **only pressing two buttons**.

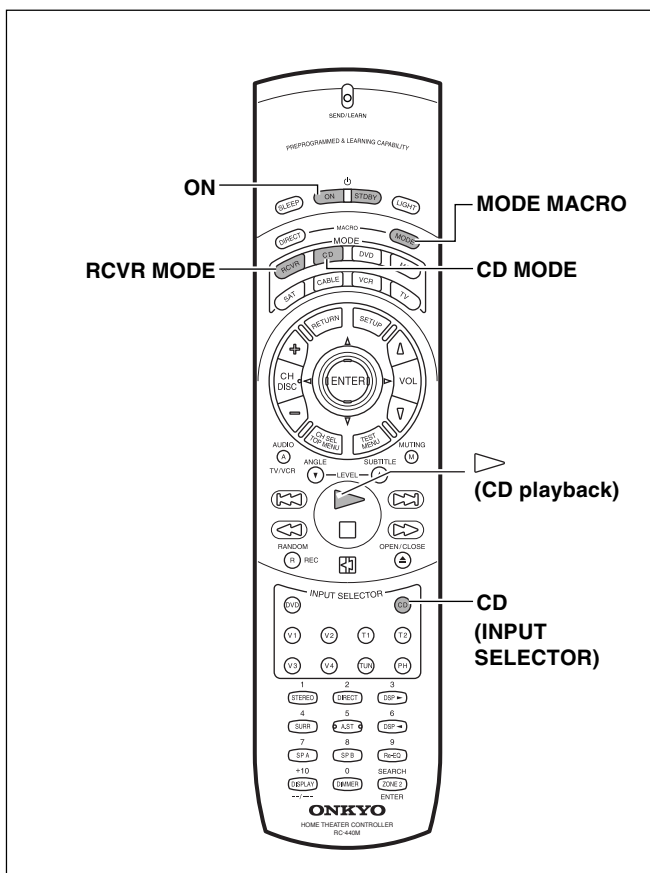

Tips:

- If you erase or change the command of a button programmed in a macro, that operation of that button will no longer work in the macro. In this case, it will be necessary for you to reprogram the macro in order to avoid incorrect operation.
- The codes programmed into a macro will be transmitted at an interval of 0.5 seconds. However, some devices may not be able to complete one operation in 0.5 seconds and may miss the next code. In this case, after pressing one operation button, you can press the same MODE button again before pressing the next operation button to add another 0.5 seconds between the two operations.

Programming a Macro function

You can program a different macro into the MODE MACRO button for each of the eight MODE buttons. The macro is then executed by pressing the appropriate MODE button and then pressing the MODE MACRO button. For example, to program the macro described above into the CD MODE button, perform the steps given below.

1. Press and hold down the desired MODE button (in this case, the CD MODE button), press the MODE MACRO button, and then release both buttons.

When you press the CD MODE button, the SEND/LEARN indicator lights and the CD MODE button lights green. When you press the MODE MACRO button, the indicator turns off. When you release the buttons, the indicator flashes and lights again.

2. Press the operation buttons you wish to program in order (in this case, press RCVR MODE → ON → CD (INPUT SELECTOR) → CD MODE → playback (▷) button).

When you press each button, the SEND/LEARN indicator turns off. When you release the button, the indicator lights.

3. Press the MODE MACRO button to complete the programming.

The SEND/LEARN indicator flashes twice slowly.

4. Run the macro to check to see if the macro has been properly programmed.

Notes:

- You may program up to 16 button operations into each macro function. If you try to program a 17th operation, it will be ignored, and programming is stopped.
- If no button is pressed for more than 30 seconds during the programming, the SEND/LEARN indicator flashes three times quickly, and the remote controller exits the programming mode. Resume from Step 1.
- If you perform an invalid operation during programming, the SEND/LEARN indicator flashes three times quickly, and the remote controller exits the programming mode. Resume from Step 1.

Running a Macro function

Perform the procedure below to run a macro function that you have programmed into the remote controller. After programming a macro, you should always run it at least once to make sure that it has been programmed properly.

1. Point the remote controller at the TX-DS696 and press the CD MODE button.
2. Press the MODE MACRO, and verify that the devices operate properly.

It may take a while for the macro to finish transmitting, so be sure to continue pointing the remote controller at the device until the SEND/LEARN indicator turns off.

Using a Macro function

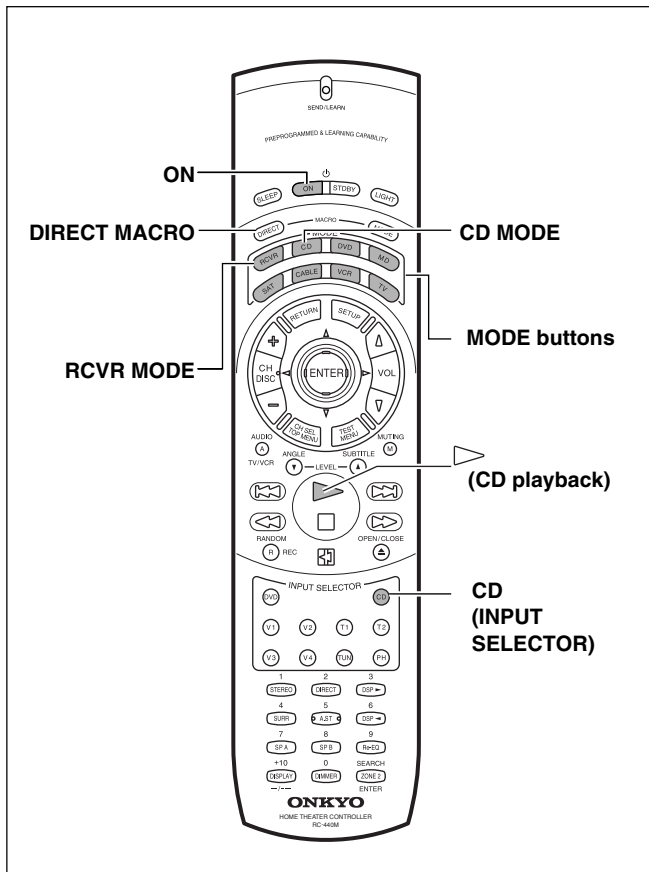

Tips:

- If you erase or change the command of a button programmed in the direct macro, that operation of that button will no longer work in the macro. In this case, it will be necessary for you to reprogram the direct macro in order to avoid incorrect operation.
- The codes programmed into a direct macro will be transmitted at an interval of 0.5 seconds. However, some devices may not be able to complete one operation in 0.5 seconds and may miss the next code. In this case, after pressing one operation button, you can press the same MODE button again before pressing the next operation button to add another 0.5 seconds between the two operations.

Programming the Direct Macro function

With the direct macro function, you can program a series of button operations as a macro into the DIRECT MACRO button so the macro can be executed with just one touch. Note that for the direct macro function, only one macro can be programmed. For example, to program the macro described on the previous page for the DIRECT MACRO button, perform the steps given below.

1. **Press and hold down any one of the eight MODE buttons, press the DIRECT MACRO button, and then release both buttons.**

When you press the MODE button, it lights green and the SEND/LEARN indicator lights. When you press the DIRECT MACRO button, the indicator turns off. When you release the buttons, the indicator flashes briefly and then lights again.

2. **Press the operation buttons you wish to program in order (in this case, press RCVR MODE → ON → CD (INPUT SELECTOR) → CD MODE → playback (▶) button).**

When you press each button, the SEND/LEARN indicator turns off. When you release the button, the indicator lights.

3. **Press the DIRECT MACRO button to complete the procedure.**

The SEND/LEARN indicator flashes twice slowly.

4. **Check to see if the macro has been properly programmed.**

Notes:

- You may program up to 16 button operations into the direct macro function. If you try to program a 17th operation, it will be ignored, and programming is stopped.
- If no button is pressed for more than 30 seconds during the programming, the SEND/LEARN indicator flashes three times quickly, and the remote controller exits the programming mode. Resume from Step 1.
- If you perform an invalid operation during programming, the SEND/LEARN indicator flashes three times quickly, and the remote controller exits the programming mode. Resume from Step 1.

Running a Direct Macro function

Perform the procedure below to run a direct macro function that you have programmed into the remote controller. After programming a direct macro, you should always run it at least once to make sure that it has been programmed properly.

1. **Point the remote controller at the TX-DS696 and press the DIRECT MACRO button.**

It may take a while for the macro to finish transmitting, so be sure to continue pointing the remote controller at the device until the SEND/LEARN indicator turns off.

Using a Macro function

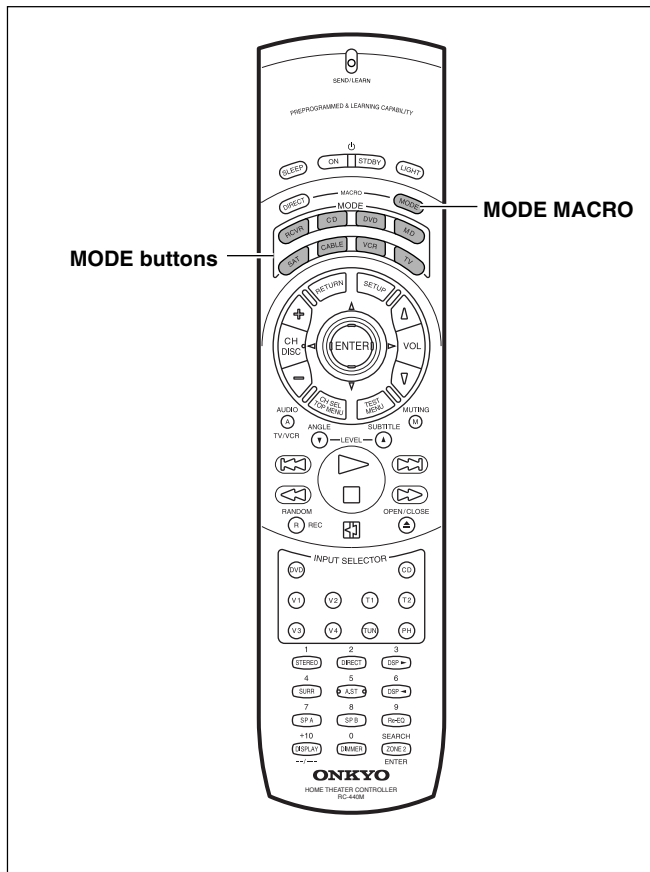

Erasing a macro from the MODE MACRO button

1. Press and hold down the desired **MODE** button, press the **MODE MACRO** button, and then release both buttons.

When you press the MODE button, it lights green and the SEND/LEARN indicator lights. When you press the MODE MACRO button, the indicator turns off. When you release the buttons, the indicator flashes once.

2. Press the **MODE MACRO** button again.

The SEND/LEARN indicator flashes twice slowly. The macro programmed to the MODE button pressed in Step 1 above is erased.

Notes:

- If no button is pressed for more than 30 seconds during the erasing procedure, the SEND/LEARN indicator flashes three times quickly, and the remote controller exits the erasing mode. Resume from Step 1.
- Be aware that if you press a button other than MODE MACRO button in Step 2, then you will in effect be overwriting the previous macro with a new macro.

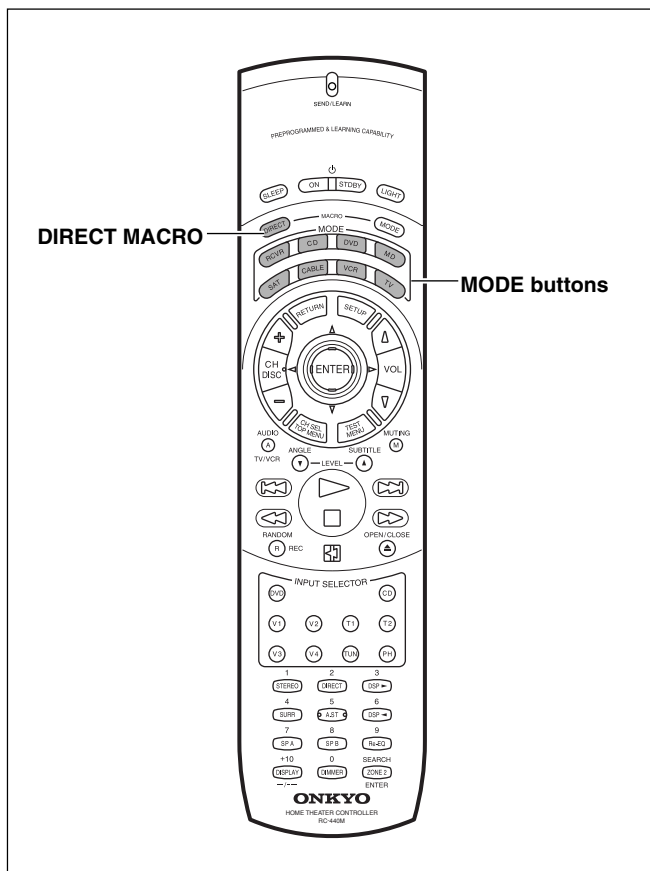

Erasing a direct macro from the DIRECT MACRO button

1. Press and hold down any one of the eight **MODE** buttons, press the **DIRECT MACRO** button, and then release both buttons.

When you press the MODE button, it lights green and the SEND/LEARN indicator lights. When you press the DIRECT MACRO button, the indicator turns off. When you release the buttons, the indicator flashes once.

2. Press the **DIRECT MACRO** button again.

The SEND/LEARN indicator flashes twice slowly. The macro programmed to the DIRECT MACRO button is erased.

Notes:

- If no button is pressed for more than 30 seconds during the erasing procedure, the SEND/LEARN indicator flashes three times quickly, and the remote controller exits the erasing mode. Resume from Step 1.
- Be aware that if you press a button other than DIRECT MACRO button in Step 2, then you will in effect be overwriting the previous direct macro with a new direct macro.

Using a Macro function

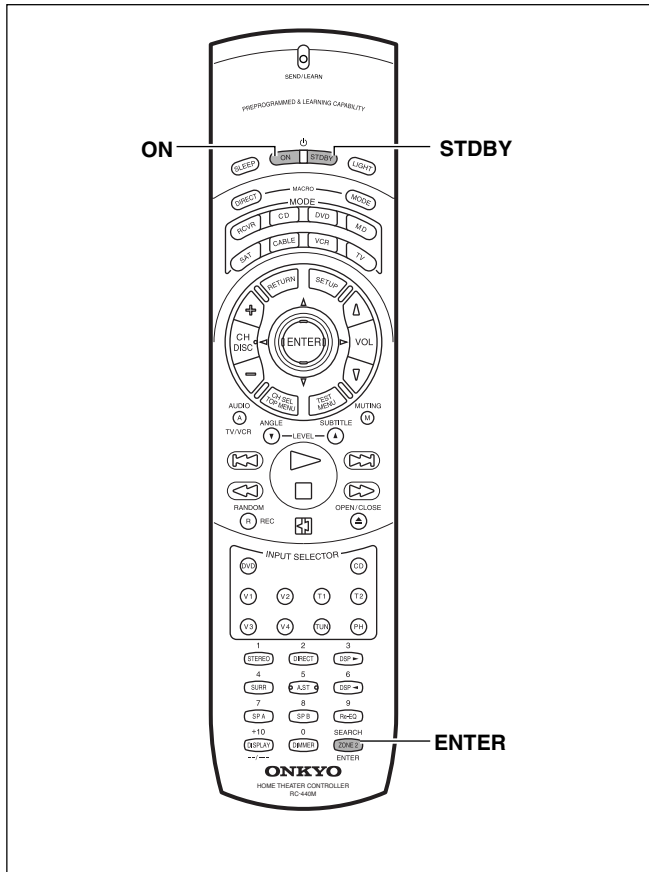

Erasing all commands and macros that have been programmed

This procedure will erase all the commands and macros that you have programmed into the remote controller and return it to its default settings. This operation will not affect the preset settings of the remote controller.

1. **Open the battery cover and remove the batteries from the remote controller.**
2. **While pressing and holding down the ON and STDBY buttons, re-insert the batteries in their correct orientation, and then release both buttons.**

The SEND/LEARN indicator flashes slowly.

3. **Press the ENTER button.**
- The SEND/LEARN indicator lights up for about ten seconds and then turns off.

All programmed commands and macros are erased and the remote controller returns to its factory presets.

- Notes:**
- Proceed to Step 3 immediately after Step 2; otherwise, the batteries will be consumed quickly.
 - If you press any button other than the ENTER button in Step 3, nothing will be erased. In this case, resume from Step 1.

Macro mode programming memo:

MACRO	MODE MACRO ↓ RCVR	MODE MACRO ↓ CD	MODE MACRO ↓ DVD	MODE MACRO ↓ MD	MODE MACRO ↓ SAT	MODE MACRO ↓ CABLE	MODE MACRO ↓ VCR	MODE MACRO ↓ TV	DIRECT MACRO
Operation 1									
Operation 2									
Operation 3									
Operation 4									
Operation 5									
Operation 6									
Operation 7									
Operation 8									
Operation 9									
Operation 10									
Operation 11									
Operation 12									
Operation 13									
Operation 14									
Operation 15									
Operation 16									

Specifications

AMPLIFIER SECTION

Continuous Average Power output (FTC)

All channels: **100 W per channel min. RMS at 8 Ω , 2 channels driven from 20 Hz to 20 kHz with no more than 0.08% total harmonic distortion.**
125 W min. RMS at 6 Ω , 2 channels driven from 1 kHz with no more than 0.1% total harmonic distortion.

Continuous Power output (DIN) 130 W at 6 Ω

Maximum Power output (EIAJ) 160 W at 6 Ω

Dynamic Power Output (Stereo) 2×230 W at 3 Ω

2×170 W at 4 Ω

2×115 W at 8 Ω

Total Harmonic Distortion: 0.08% at rated power

0.08% at 1 W output

IM Distortion: 0.08% at rated power

0.08% at 1 W output

Damping Factor: 60 at 8 Ω

Input Sensitivity and Impedance

PHONO: 2.5 mV, 50 k Ω

LINE (CD, TAPE, DVD,

VIDEO 1-4): 200 mV, 50 k Ω

MULTICHANNEL INPUT

(FRONT L/C/R, SURROUND L/R):

200 mV, 50 k Ω

(SUBWOOFER): 36 mV, 50 k Ω

COAXIAL 1, 2 (DIGITAL): 0.5 Vp-p, 75 Ω

DVD, VIDEO1-4: 1 Vp-p, 75 Ω

1 Vp-p, 75 Ω (Y)

0.28 Vp-p, 75 Ω (C)

COMPONENT VIDEO 1, 2: 1 Vp-p, 75 Ω (Y)

0.7 Vp-p, 75 Ω (Cb/Cr, Pb/Pr)

Output Level and Impedance

Rec out (TAPE, VIDEO 1, 2): 200 mV, 2.2 k Ω

Pre out: 1 V, 470 Ω

VIDEO (VIDEO 1, 2, MONITOR OUT):

1 Vp-p, 75 Ω

1 Vp-p, 75 Ω (Y)

0.28 Vp-p, 75 Ω (C)

COMPONENT VIDEO OUT: 1 Vp-p, 75 Ω (Y)

0.7 Vp-p, 75 Ω (Cb/Cr, Pb/Pr)

Phono Overload:

Frequency Response: 5 Hz to 100 kHz: +1 dB, -3 dB

RIAA Deviation: 20 Hz to 20 kHz : ± 0.8 dB

Tone Control

Bass: ± 10 dB at 50 Hz

Treble: ± 10 dB at 20 kHz

Signal-to-Noise Ratio (Stereo)

Phono: 80 dB (IHF A, 5 mV input)

CD/Tape: 100 dB (IHF A, 0.5 V input)

Muting: -50 dB

TUNER SECTION

FM

Tuning Range: 87.5 to 108.0 MHz (50-kHz steps)

Usable Sensitivity

Mono: 11.2 dBf, 1.0 μ V (75 Ω IHF)

0.9 μ V (75 Ω DIN)

Stereo: 17.2 dBf, 2.0 μ V (75 Ω IHF)

23 μ V (75 Ω DIN)

50 dB Quieting Sensitivity

Mono: 17.2 dBf, 2.0 μ V (75 Ω)

Stereo: 37.2 dBf, 20 μ V (75 Ω)

Capture Ratio: 2.0 dB

Image Rejection Ratio:

USA & Canadian models: 40 dB

Other area models: 85 dB

IF Rejection Ratio: 90 dB

Signal-to-Noise Ratio

Mono: 76 dB

Stereo: 70 dB

Alternate Channel Attenuation: 55 dB

Selectivity: 50 dB (DIN)

AM Suppression Ratio: 50 dB

Total Harmonic Distortion

Mono: 0.2%

Stereo: 0.3%

Frequency Response: 30 Hz to 15 kHz, ± 1.0 dB

Stereo Separation: 45 dB at 1 kHz

30 dB at 100 Hz to 10 kHz

AM

Tuning Range

USA & Canadian models: 530 to 1,710 kHz (10-kHz steps)

European & Australian models: 522 to 1,611 kHz (9-kHz steps)

Worldwide models: 531 to 1,602 kHz (9-kHz steps)

530 to 1,710 kHz (10-kHz steps)

Usable Sensitivity: 30 μ V

Image Rejection Ratio: 40 dB

IF Rejection Ratio: 40 dB

Signal-to-Noise Ratio: 40 dB

Total Harmonic Distortion: 0.7%

GENERAL

Power Supply:

AC 120 V, 60 Hz

(USA & Canadian models)

AC 230-240 V, 50 Hz

(European & Australian models)

AC 220-230 and 120 V switchable,

50/60 Hz (Worldwide models)

Power Consumption:

5.7 A

460 W

Dimensions (W \times H \times D):

435 \times 175 \times 431 mm

17-1/8" \times 6-7/8" \times 16-15/16"

Weight:

27.8 lbs. (USA & Canadian models)

13.5 kg (Other models)

REMOTE CONTROLLER

Transmitter:

Infrared

Signal range:

Approx. 5 meters, 16 ft.

Power supply:

Two "AA" batteries (1.5 V \times 2)

Specifications and features are subject to change without notice.

Power supply and voltage vary depending on the area in which the unit is purchased.

Troubleshooting guide

If a problem occurs while you are using the remote controller, first try to operate the controls on the front panel of the TX-DS696 to make sure that it is not due to a malfunction (or worn out batteries) in the remote controller.

POWER

Power shuts off immediately after power on.

- Amplifier protection circuitry has been activated.
→ Remove the power cord from outlet immediately. Contact your Onkyo service center.

No power.

- Power cord is disconnected.
→ Connect power cord.
- External noise is affecting the internal microcomputer.
→ Turn the power button off and then on again or remove the power cord from the outlet and then plug it in again.
- Internal fuse is blown.
→ Contact your Onkyo Service Center.

Power turns on but no sound.

- "Muting" is displayed.
→ Press the MUTING button on the remote controller to turn it off.
- Bad connections or wiring.
→ Check connections, speaker cables, etc.
- Amplifier protection circuitry has been activated.
→ Contact your Onkyo Service Center.

The sound of the playback source is not heard.

- Input selector is not set properly.
→ Set to correct input source.
- Headphones are connected.
→ Lower volume and then disconnect headphones.

SPEAKERS

No sound from the center speaker, or at very low volume.

- Speaker cable is not connected.
→ Check the connection between the amplifier and the speaker.
- Listening mode is set to Stereo or Direct.
→ Set the Listening mode to any mode other than Stereo or Direct. The output to the center speaker may differ depending on the listening mode.
- Center speaker level is set to minimum.
→ Set the Center speaker level to the appropriate volume (page 22, 23, 27).
- The Center setting of the Speaker Config submenu is set to "None."
→ Set the Center setting at the Speaker Config submenu to "Large" or "Small" (see pages 22, 23, 27).

No sound or very low volume from subwoofer.

- Subwoofer is set to "No."
→ Check the speaker setting (pages 22, 23, 27).
- Subwoofer speakers output level setting is improper.
→ Check the output level of the Subwoofer using the test tone.

Low frequency humming is heard.

- Not properly grounded.
→ Check outer conductor of input plugs.

- Turntable motor is not properly grounded.
→ Check for proper ground connection.
- Audio connection cables on the rear panel are connected incorrectly.
→ Adjust the placement of the cable to reduce hum.

Howling is heard when the volume is turned up.

- Turntable and speakers are located too close together.
→ Move them farther apart.

Rough or scratchy sound is heard. High range is not clear.

- The needles of turntable is dirty or worn, or a problem exists with a connected component.
→ Refer to the instruction of the connected components and check for problem.
- Treble control is too high.
→ Turn treble down.

FM/AM TUNER

AM stations cannot be received.

- AM loop antenna is not connected.
→ Connect the included AM loop antenna to the AM antenna terminals.

Buzzing noise on AM stations (particularly noticeable at night or with weak stations).

- Noise from electrical apparatus such as fluorescent lamp.
→ Move the AM loop antenna to different position.
→ Set up an outdoor AM antenna.

Noise is heard at high-pitched sounds on AM stations.

- Noise from TV set.
→ Place the AM loop antenna as far as possible from the TV.
→ Move unit away from TV set.

Crackling noise on both AM and FM stations.

- Noise caused by fluorescent lamp being turned on and off.
→ Move antenna as far as possible from the fluorescent lamp.
- Noise from automobile ignition.
→ Install an FM outdoor antenna as far as possible from the road.
→ Change the position or direction of the outdoor antenna.

The indicators light for stereo reception, but sound is distorted and stereo separation is bad.

- Station is too strong.
→ Change to FM indoor antenna.
- Multiple reflection of the radio waves because of tall buildings or mountains.
→ Use antenna that has better directivity and select a point where distortion is least.

Indicators for stereo reception flicker and hiss is heard on FM stations.

- Station is too weak.
→ Install an outdoor FM antenna.
- Stereo FM broadcasts cover only about half the distance of an ordinary broadcast.
→ Change the position or direction of the outdoor antenna.

No preset station is recalled.

- Power cord has been unplugged or the POWER switch has been turned off for a long time.
→ The memory contents are lost. Store all stations again.

Troubleshooting guide

VIDEO and AUDIO

Desired picture does not appear.

- Improper connection.
→ Check the connection again. Insert the plugs and connectors completely.

No OSD Menu display.

- Improper connection.
→ Check connections.
- OSD Menu is displayed when monitor is connected to VIDEO or S VIDEO of MONITOR OUT.
→ Confirm connections.

No sound, or sound of the selected source is not heard.

- Audio Setup sub-menu of Input Setup menu settings are incorrect.
→ Check settings.

No picture appears on the TV screen (or monitor).

- TV (or monitor) is not set to receive the output signals from the receiver.
→ Set the TV (or monitor) to the receiver input.
- Video cable is not connected securely.
→ Check connections.
- You have connected to the COMPONENT VIDEO connectors but the TX-DS696 is not set properly.
→ Check the Video Setup submenu of the Input Setup menu (page 38).

REMOTE CONTROLLER

Front panel controls function but remote controller controls do not.

- No batteries in remote controller.
→ Insert batteries.
- Batteries have worn out.
→ Replace batteries.
- Remote controller is not pointed at the remote sensor of the TX-DS696.
→ Point the remote controller at the remote sensor of the TX-DS696.
- Remote controller is too far from the TX-DS696.
→ Operate the remote controller within 5 meters (16 feet).
- Remote controller is functioning in a different mode
→ Press the RCVR MODE button.

OTHER

LATE NIGHT function cannot be used.

- Playback source is not Dolby Digital encoded.
→ Check that the DOLBY DIGITAL indicator lights up on the display.

Re-EQ function cannot be used.

- Re-EQ is only enabled for Analog/PCM sources and Dolby Digital surround.
→ See page 33.

Parameter cannot be set for Front Effect etc.

- Parameter may not be able to be set depending on the listening mode.
→ See table on page 41.

Multichannel audio is not output.

- To listen to multichannel audio, “Yes” must be selected in the “Multichannel” in the Audio setup sub-menu of the Input Setup menu. Also, it is necessary to select Multichannel with the AUDIO SELECTOR button.
→ Check that the component is connected to the MULTI CHANNEL INPUT port and check the Setup menu settings.

Components in remote zone (Zone 2) do not operate properly.

- Components are incorrectly connected.
→ Check connections.
- Objects are interfering with remote controller signals.
→ Move interfering objects away from path of remote controller signals.

If one of the messages shown below appears

“Not available with headphones use”

The operation is not allowed because headphones are plugged into the TX-DS696.

“Not available with Multichannel use”

The operation is not allowed because the selected input source is set for multichannel input.

“Not available in this Sp Config”

The operation is not allowed by the current speaker configuration.

“Not available in Zone 2 mode”

The operation is not allowed because the Zone 2 mode is turned on.

“Only available with Dolby D”

No setting other than Dolby Digital can be set.

“Not available in this Listening mode”

This operation cannot be performed in this listening mode.

“Not available with this signal”

This operation cannot be performed with this input signal.

Also refer to the respective instruction manuals of the compact disc player, DVD player, video cassette recorder, TV monitor, etc., that compose your entertainment system.

The TX-DS696 contains an internal microcomputer that performs high-level operations. However, on extremely rare occasions, noise or interference from an external source or static electricity may cause faulty operation. If this occurs, unplug the power cord from the wall outlet, wait five or more seconds, and then plug it back in. This should correct the situation.

- * To reset the surround mode and other settings to the factory default settings, hold down the PRESET MEMORY button with the TX-DS696 turned on and then press the STANDBY/ON button. “CLEAR” appears in the front display and the TX-DS696 enters the standby state.

ONKYO CORPORATION

Sales & Product Planning Div. : 2-1, Nisshin-cho, Neyagawa-shi, OSAKA 572-8540, JAPAN
Tel: 072-831-8111 Fax: 072-833-5222

ONKYO U.S.A. CORPORATION

18 Park Way, Upper Saddle River, N.J. 07458, U.S.A.
Tel: 201-785-2600 Fax: 201-785-2650 E-mail: onkyo@onkyousa.com

ONKYO EUROPE ELECTRONICS GmbH

Industriestrasse 20, 82110 Germering, GERMANY
Tel: 089-849-320 Fax: 089-849-3265 E-mail: info@onkyo.de

ONKYO CHINA LIMITED

Units 2102-2107, Metroplaza Tower I, 223 Hing Fong Road, Kwai Chung,
N.T., HONG KONG Tel: 852-2429-3118 Fax: 852-2428-9039



Free Manuals Download Website

<http://myh66.com>

<http://usermanuals.us>

<http://www.somanuals.com>

<http://www.4manuals.cc>

<http://www.manual-lib.com>

<http://www.404manual.com>

<http://www.luxmanual.com>

<http://aubethermostatmanual.com>

Golf course search by state

<http://golfingnear.com>

Email search by domain

<http://emailbydomain.com>

Auto manuals search

<http://auto.somanuals.com>

TV manuals search

<http://tv.somanuals.com>