

ONKYO®

AV Receiver

TX-SR500 *TX-SR500E*

Instruction Manual

Thank you for purchasing the Onkyo AV Receiver. Please read this manual thoroughly before making connections and plugging in the unit. Following the instructions in this manual will enable you to obtain optimum performance and listening enjoyment from your new AV Receiver. Please retain this manual for future reference.

Contents

Before using

Important safeguards	2
Precautions	3
Features	4
Supplied accessories	4
Before using the unit	5

Facilities and connections

Index to parts and controls	6
Connecting to audio/video equipment	10
Positioning speakers/Connecting speakers	12
Connecting antennas	14
Connections for remote control (RI)	16
Connecting the power/ Turning on the AV Receiver	17

Enjoying music or videos

Speaker setup	18
Playing the connected source	21
Listening to the radio	24
Various functions common to all the sources	26
Enjoying the listening modes	30
Recording a source	33

Remote controller

Using remote controller	34
Pre-programming remote controller (North American models only)	36

Appendix

Troubleshooting	38
Specifications	back cover page

WARNING:

TO REDUCE THE RISK OF FIRE OR ELECTRIC SHOCK, DO NOT EXPOSE THIS APPLIANCE TO RAIN OR MOISTURE.

CAUTION:

TO REDUCE THE RISK OF ELECTRIC SHOCK, DO NOT REMOVE COVER (OR BACK). NO USER-SERVICEABLE PARTS INSIDE. REFER SERVICING TO QUALIFIED SERVICE PERSONNEL.



WARNING
RISK OF ELECTRIC SHOCK
DO NOT OPEN

AVIS
RISQUE DE CHOC ELECTRIQUE
NE PAS OUVRIR



The lightning flash with arrowhead symbol, within an equilateral triangle, is intended to alert the user to the presence of uninsulated "dangerous voltage" within the product's enclosure that may be of sufficient magnitude to constitute a risk of electric shock to persons.



The exclamation point within an equilateral triangle is intended to alert the user to the presence of important operating and maintenance (servicing) instructions in the literature accompanying the appliance.

Important safeguards

- 1. Read Instructions** – All the safety and operating instructions should be read before the appliance is operated.
- 2. Retain Instructions** – The safety and operating instructions should be retained for future reference.
- 3. Heed Warnings** – All warnings on the appliance and in the operating instructions should be adhered to.
- 4. Follow Instructions** – All operating and use instructions should be followed.
- 5. Cleaning** – Unplug the appliance from the wall outlet before cleaning. The appliance should be cleaned only as recommended by the manufacturer.
- 6. Attachments** – Do not use attachments not recommended by the appliance manufacturer as they may cause hazards.
- 7. Water and Moisture** – Do not use the appliance near water – for example, near a bath tub, wash bowl, kitchen sink, or laundry tub; in a wet basement; or near a swimming pool; and the like.
- 8. Accessories** – Do not place the appliance on an unstable cart, stand, tripod, bracket, or table. The appliance may fall, causing serious injury to a child or adult, and serious damage to the appliance. Use only with a cart, stand, tripod, bracket, or table recommended by the manufacturer, or sold with the appliance. Any mounting of the appliance should follow the manufacturer's instructions, and should use a mounting accessory recommended by the manufacturer.
- 9. An appliance and cart combination should be moved with care. Quick stops, excessive force, and uneven surfaces may cause the appliance and cart combination to overturn.**

PORTABLE CART WARNING
S3125A
- 10. Ventilation** – Slots and openings in the cabinet are provided for ventilation and to ensure reliable operation of the appliance and to protect it from overheating, and these openings must not be blocked or covered. The openings should never be blocked by placing the appliance on a bed, sofa, rug, or other similar surface. The appliance should not be placed in a built-in installation such as a bookcase or rack unless proper ventilation is provided. There should be free space of at least 20 cm (8 in.) and an opening behind the appliance.
- 11. Power Sources** – The appliance should be operated only from the type of power source indicated on the marking label. If you are not sure of the type of power supply to your home, consult your appliance dealer or local power company.
- 12. Grounding or Polarization** – The appliance may be equipped with a polarized alternating current line plug (a plug having one blade wider than the other). This plug will fit into the power outlet only one way. This is a safety feature. If you are unable to insert the plug fully into the outlet, try reversing the plug. If the plug should still fail to fit, contact your electrician to replace your obsolete outlet. Do not defeat the safety purpose of the polarized plug.
- 13. Power-Cord Protection** – Power-supply cords should be routed so that they are not likely to be walked on or pinched by items placed upon or against them, paying particular attention to cords at plugs, convenience receptacles, and the point where they exit from the appliance.
- 14. Outdoor Antenna Grounding** – If an outside antenna or cable system is connected to the appliance, be sure the antenna or cable system is grounded so as to provide some protection against voltage surges and built-up static charges. Article 810 of the National Electrical Code, ANSI/NFPA 70, provides information with regard to proper grounding of the mast and supporting structure, grounding of the lead-in wire to an antenna-discharge unit, size of grounding conductors, location of antenna-discharge unit, connection to grounding electrodes, and requirements for the grounding electrode. See Figure 1.
- 15. Lightning** – For added protection for the appliance during a lightning storm, or when it is left unattended and unused for long periods of time, unplug it from the wall outlet and disconnect the antenna or cable system. This will prevent damage to the appliance due to lightning and power-line surges.
- 16. Power Lines** – An outside antenna system should not be located in the vicinity of overhead power lines or other electric light or power circuits, or where it can fall into such power lines or circuits. When installing an outside antenna system, extreme care should be taken to keep from touching such power lines or circuits as contact with them might be fatal.
- 17. Overloading** – Do not overload wall outlets, extension cords, or integral convenience receptacles as this can result in a risk of fire or electric shock.
- 18. Object and Liquid Entry** – Never push objects of any kind into the appliance through openings as they may touch dangerous voltage points or short-out parts that could result in a fire or electric shock. Never spill liquid of any kind on the appliance.
- 19. Servicing** – Do not attempt to service the appliance yourself as opening or removing covers may expose you to dangerous voltage or other hazards. Refer all servicing to qualified service personnel.
- 20. Damage Requiring Service** – Unplug the appliance from the wall outlet and refer servicing to qualified service personnel under the following conditions:
 - When the power-supply cord or plug is damaged,
 - If liquid has been spilled, or objects have fallen into the appliance,
 - If the appliance has been exposed to rain or water,
 - If the appliance does not operate normally by following the operating instructions. Adjust only those controls that are covered by the operating instructions as an improper adjustment of other controls may result in damage and will often require extensive work by a qualified technician to restore the appliance to its normal operation,
 - If the appliance has been dropped or damaged in any way, and
 - When the appliance exhibits a distinct change in performance – this indicates a need for service.

21. **Replacement Parts** – When replacement parts are required, be sure the service technician has used replacement parts specified by the manufacturer or have the same characteristics as the original part. Unauthorized substitutions may result in fire, electric shock, or other hazards.
22. **Safety Check** – Upon completion of any service or repairs to the appliance, ask the service technician to perform safety checks to determine that the appliance is in proper operation condition.
23. **Wall or Ceiling Mounting** – The appliance should be mounted to a wall or ceiling only as recommended by the manufacturer.
24. **Heat** – The appliance should be situated away from heat sources such as radiators, heat registers, stoves, or other appliances (including amplifiers) that produce heat.
25. **Liquid Hazards** – The appliance shall not be exposed to dripping or splashing and no objects filled with liquids, such as vases shall be placed on the appliance.

FIGURE 1:
EXAMPLE OF ANTENNA GROUNDING AS PER NATIONAL ELECTRICAL CODE, ANSI/NFPA 70

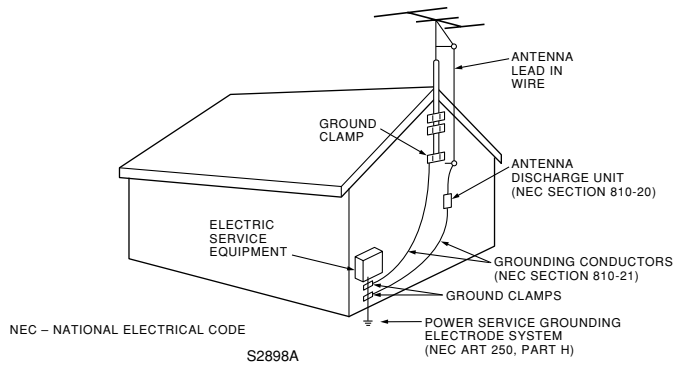

Precautions

For British models

Replacement and mounting of an AC plug on the power supply cord of this unit should be performed only by qualified service personnel.

IMPORTANT

The wires in the mains lead are coloured in accordance with the following code:

- Blue: Neutral
- Brown: Live

As the colours of the wires in the mains lead of this apparatus may not correspond with the coloured markings identifying the terminals in your plug, proceed as follows:

The wire which is coloured blue must be connected to the terminal which is marked with the letter N or coloured black.

The wire which is coloured brown must be connected to the terminal which is marked with the letter L or coloured red.

IMPORTANT

A 5 ampere fuse is fitted in this plug. Should the fuse need to be replaced, please ensure that the replacement fuse has a rating of 5 amperes and that it is approved by ASTA or BSI to BS1362. Check for the ASTA mark or the BSI mark on the body of the fuse.

IF THE FITTED MOULDED PLUG IS UNSUITABLE FOR THE SOCKET OUTLET IN YOUR HOME THEN THE FUSE SHOULD BE REMOVED AND THE PLUG CUT OFF AND DISPOSED OF SAFELY. THERE IS A DANGER OF SEVERE ELECTRICAL SHOCK IF THE CUT OFF PLUG IS INSERTED INTO ANY 13 AMPERE SOCKET.

If in any doubt, consult a qualified electrician.

For European models

Declaration of Conformity

We, ONKYO EUROPE ELECTRONICS GmbH
INDUSTRIESTRASSE 20
82110 GERMERING,
GERMANY



declare in own responsibility, that the ONKYO product described in this instruction manual is in compliance with the corresponding technical standards such as EN60065, EN55013, EN55020 and EN61000-3-2, -3-3.

GERMERING, GERMANY

 I. MORI

ONKYO EUROPE ELECTRONICS GmbH

For U.S. models

Note to CATV system installer:

This reminder is provided to call the CATV system installer's attention to Section 820-40 of the NEC which provides guidelines for proper grounding and, in particular, specifies that the cable ground shall be connected to the grounding system of the building, as close to the point of cable entry as practical.

FCC Information for User

CAUTION:

The user changes or modifications not expressly approved by the party responsible for compliance could void the user's authority to operate the equipment.

NOTE:

This equipment has been tested and found to comply with the limits for a Class B digital device, pursuant to Part 15 of the FCC Rules. These limits are designed to provide reasonable protection against harmful interference in a residential installation. This equipment generates, uses and can radiate radio frequency energy and, if not installed and used in accordance with the instructions, may cause harmful interference to radio communications. However, there is no guarantee that interference will not occur in a particular installation. If this equipment does cause harmful interference to radio or television reception, which can be determined by turning the equipment off and on, the user is encouraged to try to correct the interference by one or more of the following measures:

- Reorient or relocate the receiving antenna.
- Increase the separation between the equipment and receiver.
- Connect the equipment into an outlet on a circuit different from that to which the receiver is connected.
- Consult the dealer or an experienced radio/TV technician for help.

For Canadian models

NOTE: THIS CLASS B DIGITAL APPARATUS COMPLIES WITH CANADIAN ICES-003.

For models having a power cord with a polarized plug:

CAUTION: TO PREVENT ELECTRIC SHOCK, MATCH WIDE BLADE OF PLUG TO WIDE SLOT, FULLY INSERT.

Modele pour les Canadien

REMARQUE: CET APPAREIL NUMÉRIQUE DE LA CLASSE B EST CON-FORME À LA NORME NMB-003 DU CANADA.

Sur les modèles dont la fiche est polarisée:

ATTENTION: POUR ÉVITER LES CHOCS ÉLECTRIQUES, INTRODUIRE LA LAME LA PLUS LARGE DE LA FICHE DANS LA BORNE CORRESPONDANTE DE LA PRISE ET POUSSER JUSQU'AU FOND.

Precautions

1. Recording Copyright

Recording of copyrighted material for other than personal use is illegal without permission of the copyright holder.

2. AC Fuse

The fuse is located inside the chassis and is not user-serviceable. If power does not come on, contact your Onkyo authorized service station.

3. Care

From time to time you should wipe the front and rear panels and the cabinet with a soft cloth. For heavier dirt, dampen a soft cloth in a weak solution of mild detergent and water, wring it out dry, and wipe off the dirt. Following this, dry immediately with a clean cloth. Do not use rough material, thinners, alcohol or other chemical solvents or cloths since these could damage the finish or remove the panel lettering.

4. Power

WARNING

BEFORE PLUGGING IN THE UNIT FOR THE FIRST TIME, READ THE FOLLOWING SECTION CAREFULLY.

The voltage of the available power supply differs according to country or region. Be sure that the power supply voltage of the area where this unit will be used meets the required voltage (e.g., AC 230 V, 50 Hz or AC 120 V, 60 Hz) written on the rear panel.

Worldwide models are equipped with a voltage selector to conform to local power supplies. Be sure to set this switch to match the voltage of the power supply in your area before plugging in the unit.

Memory Preservation

This unit does not require memory preservation batteries.

A built-in memory power backup system preserves the contents of memory during power failures and even when the POWER switch is set to OFF (other than USA and Canadian models) or when the power cord is unplugged.

The power cord must be plugged and the POWER switch must be set to ON (other than USA and Canadian models) in order to charge the backups system. The memory preservation period after the unit has been turned off varies depending on climate and placement of the unit. On average, memory contents are protected over a period of a few weeks after the time the unit has been turned off. This period is shorter when the unit is exposed to a very humid climate.

Features

Amplifier Features

- **Dolby* Digital & DTS** decoding**
- **5.1-Channel input**
- **4 S-video input**
- **3 Assignable digital inputs (2 optical, 1 coaxial)**
- **Digital output**
- **9 DSP soundfields**
- **Wide Range Amplifier Technology (WRAT)**
- **State-of-the-art linear PCM 96 kHz/24bit DACs for all channels**

FM/AM Tuner Features

- **30 FM/AM random presets**
- **FM auto tuning**
- **FM indoor antenna supplied**
- **AM indoor antenna supplied**

* Manufactured under license from Dolby Laboratories. "Dolby", "Pro Logic" and the double-D symbol are trademarks of Dolby Laboratories. Confidential Unpublished Works. ©1992-1997 Dolby Laboratories. All rights reserved.

** Manufactured under license from Digital Theater Systems, Inc. US Pat. No.5,451,942 and other worldwide patents issued and pending. "DTS" and "DTS Digital Surround" are trademarks of Digital Theater Systems, Inc. ©1996 Digital Theater Systems, Inc. All Rights reserved.

Supplied accessories

Check that the following accessories are supplied with the TX-SR500/TX-SR500E.



AM loop antenna × 1



FM indoor antenna × 1
(Connector will vary depending on the area which it was purchased.)

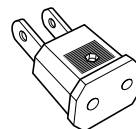

Conversion plug × 1
(Use this plug if the power cord plug of the TX-SR500/TX-SR500E does not fit your AC outlet. Shape may vary depending on the area which it was purchased.)

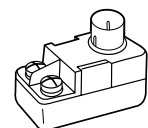

75/300 Ω antenna adapter × 1
(For all models other than USA, Canadian and European models)

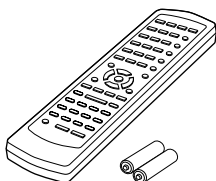

Remote controller × 1
Batteries (AA, R6 or UM-3) × 2

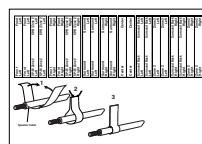

Speaker cable label × 1

Before using the unit

Setting the voltage selector (Worldwide models only)

Worldwide models are equipped with a voltage selector to conform with local power supplies. Be sure to set this switch to match the voltage of the power supply in your area before plugging in the unit. Determine the proper voltage for your area: 220-230 V or 120 V. If the preset voltage is not correct for your area, insert a screwdriver into the groove in the switch. Slide the switch all the way to the upper (120 V) or to the lower (220-230 V), whichever is appropriate.

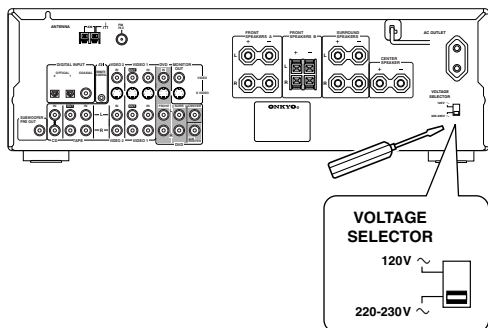

Setting the AM tuning step frequency (Worldwide models only)

Refer to page 24 to set the AM tuning step frequency correctly.

Inserting the batteries

1 Detach the battery cover.

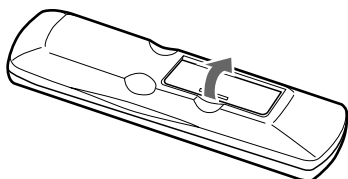

2 Insert the two size AA/R6/UM3 batteries.

Be sure to match the + and - ends of the batteries with the diagram inside the battery compartment.

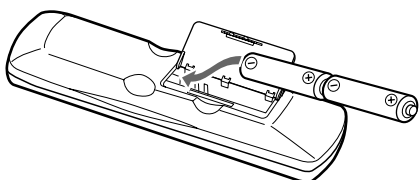

3 Attach the battery cover.

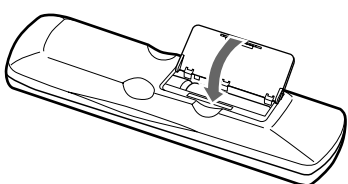

Notes

- Do not mix new batteries with old batteries or different kinds of batteries.
- To avoid corrosion, remove the batteries if the remote controller is not to be used for a long time.
- Remove dead batteries immediately to avoid damage from corrosion. If the remote controller does not operate smoothly, replace both batteries at the same time.
- The life of the supplied batteries is about six months but this varies depending on usage.

Using the remote controller

Point the remote controller toward the remote control sensor. The STANDBY indicator lights up when the unit receives a signal from the remote controller.

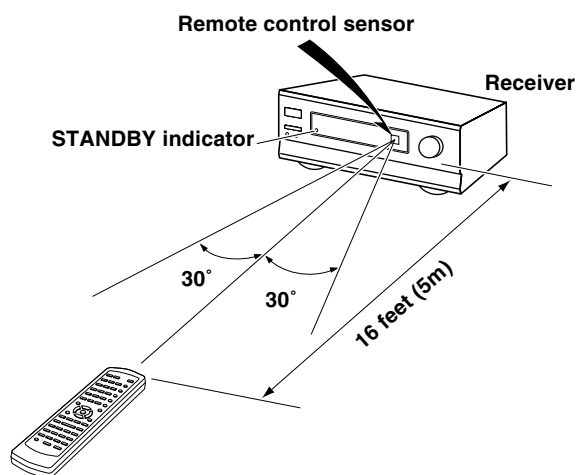

Notes

- Place the unit away from strong light such as direct sunlight or inverted fluorescent light which can prevent proper operation of the remote controller.
- Using another remote controller of the same type in the same room or using the unit near equipment which uses infrared rays may cause operational interference.
- Do not put any object (such as a book) on the remote controller. The buttons of the remote controller may be pressed by mistake and drain the batteries.
- Make sure the audio rack doors do not have colored glass. Placing the unit behind such doors may prevent proper remote controller operation.
- If there is any obstacle between the remote controller and the remote control sensor, the remote controller will not operate.

Index to parts and controls

Front panel

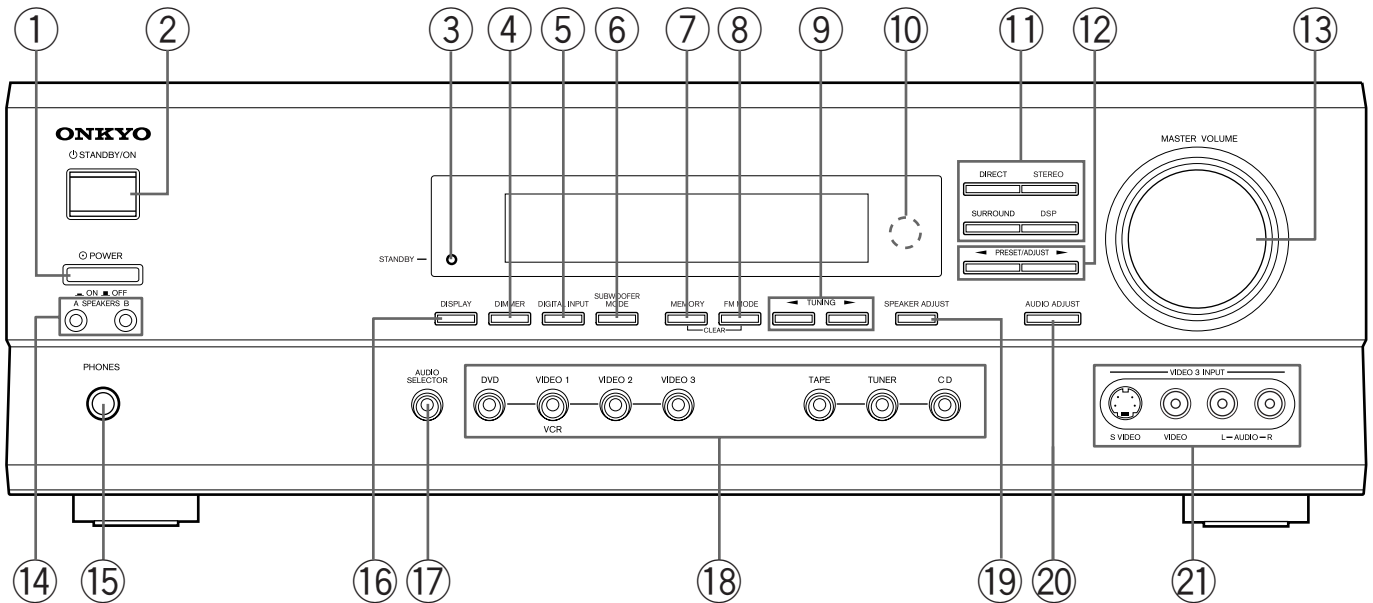

For operational instructions, refer to the page indicated in brackets.

1 POWER switch (other than USA and Canadian models) [17]

Turns on the main power supply for the TX-SR500/TX-SR500E. The TX-SR500/TX-SR500E enters standby state and the STANDBY indicator lights up. Pressing the switch again to the off position (■ OFF) shuts down the main power supply into the TX-SR500/TX-SR500E.

- Before turning on the power, make sure all cables are properly connected.
- Turning on the TX-SR500/TX-SR500E may cause a momentary power surge that might interfere with other electrical equipment on the same circuit. If this is a problem, plug the TX-SR500/TX-SR500E into a different electrical circuit.

2 STANDBY/ON button [17]

When STANDBY/ON button is pressed to ON (while the POWER switch is set to ON (other than USA and Canadian models)), the display will light to show the current volume setting for about 5 seconds then show the current sound input source. Pressing the button again returns the TX-SR500/TX-SR500E to the standby state. This state turns off the display, disables control functions.

3 STANDBY indicator [17]

Lights when the TX-SR500/TX-SR500E is in the standby state and flashes when a signal is received from the remote controller.

4 DIMMER button [27]

Press to set the brightness of the front display. The brightness changes to normal, dim and very dim.

5 DIGITAL INPUT button [22]

When digital components are connected to the DIGITAL INPUT jacks of the TX-SR500/TX-SR500E, use this button to assign the DIGITAL INPUT jacks to them according to their forms of connection.

6 SUBWOOFER MODE button [20]

Press to select the subwoofer mode.

7 MEMORY button [24, 25]

This button is used to assign the radio station that is currently tuned in to a preset channel or delete a previously preset station.

8 FM MODE button [24, 25]

Press to switch the reception mode between stereo and monaural. If audio is interrupted or noise interferes with audio during FM stereo broadcasting, press this button to switch to the monaural reception mode.

9 TUNING ◀▶ buttons [24, 25]

Use these buttons to change the tuner frequency. The tuner frequency is displayed in the front display and it can be changed in 50 kHz increments for FM and 10 kHz (or 9 kHz) increments for AM.

When FM is selected, you can hold down one of the TUNING ◀▶ buttons and then release it to activate the auto-search feature. It will search for a station in the direction of the button you pressed and stop when it tunes into one.

10 Remote control sensor [5]

This sensor receives the control signals from the remote controller.

11 Listening mode buttons [32]

Press these buttons to select a listening mode for the current source. Press the DSP button to recall the Onkyo-original DSP modes in sequence. Press the DIRECT, STEREO or SURROUND button to recall the corresponding listening mode directly.

12 PRESET/ADJUST ◀▶ buttons [18,19, 29]

These buttons make it possible to store desired radio stations under the desired preset numbers and recall them with an easy operation. Also, these buttons adjust the values and parameters of the mode selected using the AUDIO ADJUST, SPEAKER ADJUST or AUDIO SELECTOR button.

13 MASTER VOLUME dial [21, 24]

The MASTER VOLUME dial is used to control the volume level. Turn the dial clockwise to increase the volume level and counterclockwise to decrease it.

Index to parts and controls

Display

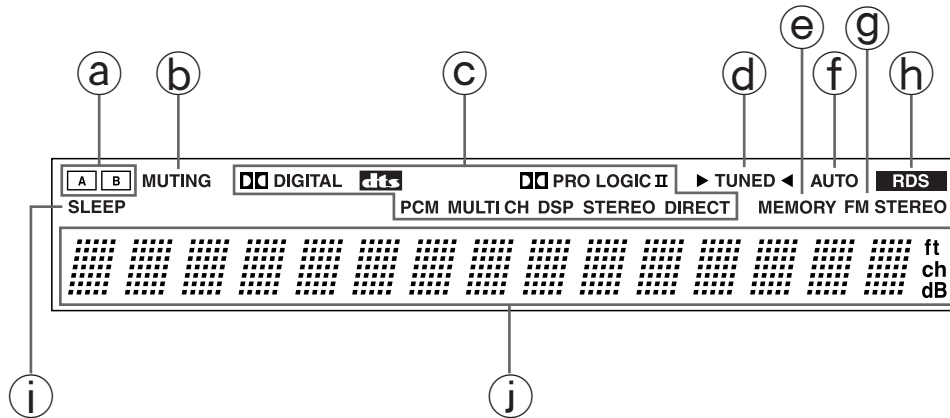

14 SPEAKERS A/B buttons [21, 26]

Press SPEAKERS A/B to turn on/off the speaker system A/B. The (SPEAKERS) A/B indicators corresponding to the selected speaker system light up. You can use SPEAKERS A and B simultaneously.

15 PHONES jack [26]

This is a standard stereo jack for connecting stereo headphones. The audio for the front right and left speakers are sent to the headphone speakers.

16 DISPLAY button [27]

Each time you press the DISPLAY button, the display changes.

17 AUDIO SELECTOR button [28]

Press to select an audio input signal format other than FM and AM. Each time this button is pressed, the setting cycles.

18 Input selector buttons (DVD, VIDEO 1, VIDEO 2, VIDEO 3, TAPE, TUNER, and CD) [21-25, 28, 33]

These buttons are used to select the input source. Pressing and holding the TAPE button for about 2 seconds allows the TAPE and MD sources to be switched.

19 SPEAKER ADJUST button [18, 19]

Press to select speaker setting item.

20 AUDIO ADJUST button [29]

Press to adjust bass, treble, late night function and cinema filter function setting.

21 VIDEO 3 INPUT jacks [33]

For connecting a video camera or game device.

a (SPEAKERS) A/B indicators [21, 26]

Shows the current speaker system in use.

b MUTING indicator [26]

Flashes when the mute function is active.

c Source/Listening mode indicators [21, 32]

One of these indicators lights to show the format of the current source as "PCM", "DIGITAL" or "DTS". In addition, one of the listening mode indicators "PRO LOGIC II", "MULTI CH", "DSP", "STEREO" and "DIRECT" lights according to the current listening mode.

d TUNED indicator [24]

Lights up when a radio station is received.

e MEMORY indicator [25]

Lights up when the MEMORY button is pressed in the radio station preset operation.

f AUTO indicator [24]

Lights up to indicate auto reception mode (stereo/monaural). At this time, interstation noise will be muted (FM only). It extinguishes when the monaural reception mode is started by pressing the FM MODE button.

g FM STEREO indicator [24]

Lights up when an FM stereo broadcast station is received.

h RDS indicator (European models only) [24]

Lights up when a RDS station is received.

i SLEEP indicator [27]

Lights up when the sleep timer is active.

j Multi function display

In usual operation, shows the current input source and volume. When the FM or AM input is selected, it shows the frequency and preset number. When the DISPLAY button is pressed, it shows the current input source and the listening mode.

Index to parts and controls

Rear panel

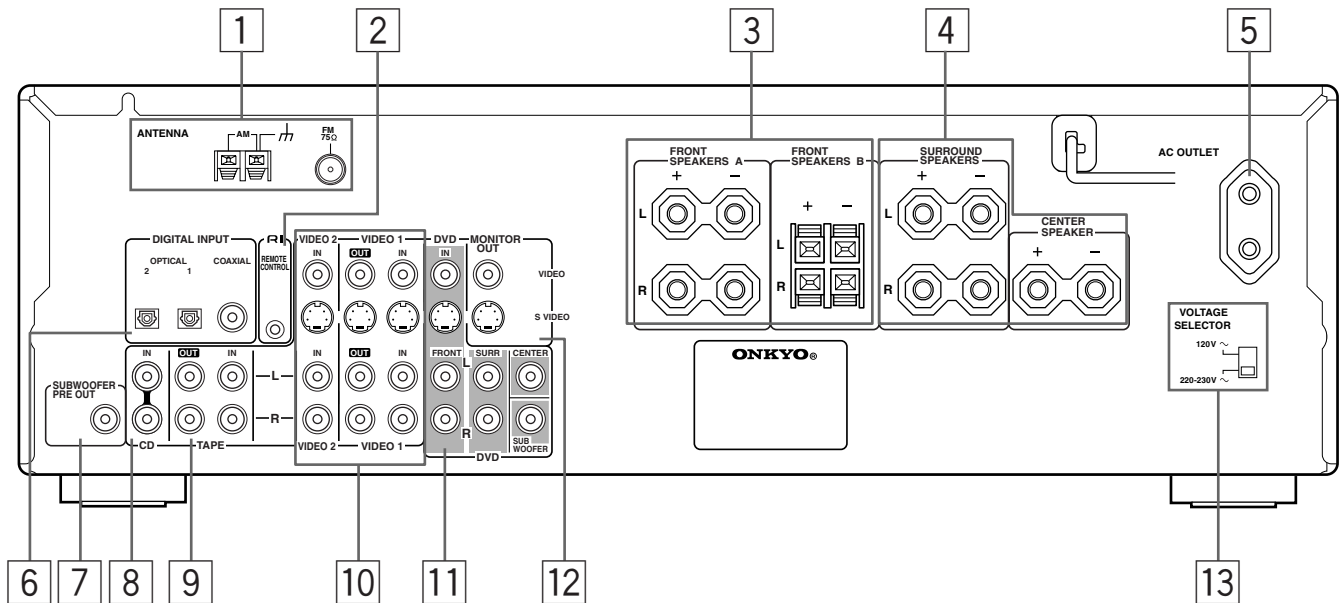

For operational instructions, refer to the page indicated in brackets.

1 ANTENNA [14, 15]

These terminals are for connecting the FM antenna and AM antenna.

2 RI (REMOTE CONTROL) [16]

Connect the Onkyo components that have **RI** connectors such as a CD player, and cassette tape deck using the **RI** cables provided with them. When these components are interconnected, they can be controlled from the remote controller provided with the TX-SR500/TX-SR500E.

After connecting the **RI** connectors, check the operation of the remote controller buttons for use in controlling other components.

3 FRONT SPEAKERS A/B [13]

Speaker terminals are provided for the front left, front right speakers. **SPEAKERS A** are compatible with banana plug connectors (other than European models).

4 SURROUND SPEAKERS L/R, CENTER SPEAKER [13]

Speaker terminals are provided for the center, surround left and surround right speakers.

5 AC OUTLET [11]

The TX-SR500/TX-SR500E is supplied with AC mains outlet for connecting the power cord from other devices so that their power is supplied through the TX-SR500/TX-SR500E. By doing this, you can use the **STANDBY/ON** button on the TX-SR500/TX-SR500E to turn on and off the connected devices as well.

6 DIGITAL INPUT OPTICAL 1, 2, COAXIAL [10, 11]

These are the digital audio inputs. There are 2 digital inputs with optical jacks and 1 with a coaxial jack. The inputs accept digital audio signals from DVD, LD, CD, or other digital source.

7 SUBWOOFER PRE OUT [13]

This terminal is for connecting an active subwoofer.

8 CD IN [10]

Connect the output terminal on the CD player to the CD IN L/R jacks on the TX-SR500/TX-SR500E.

9 TAPE IN/OUT [10]

Connect the output terminals (**PLAY**) of the cassette tape deck or MD recorder to the TAPE IN L/R jacks on the TX-SR500/TX-SR500E and the input terminals (**REC**) to the TAPE OUT L/R jacks.

10 VIDEO 1 IN/OUT, VIDEO 2 IN [11]

Connect the output terminals (**PLAY**) of the video cassette recorder to the VIDEO 1 IN L/R jacks on the TX-SR500/TX-SR500E and the input terminals (**REC**) to the VIDEO 1 OUT jacks.

Connect the output terminals of the video cassette player or satellite tuner to the VIDEO 2 IN jacks on the TX-SR500/TX-SR500E.

11 DVD [11]

By connecting a DVD player, MPEG decoder, or other component that has a multi channel port, you can playback the audio with 5.1 channel output. So, be sure to prepare a cable that can properly connect the TX-SR500/TX-SR500E to the peripheral device.

- You can connect 2 channel audio output to the FRONT L/R jacks.

12 MONITOR OUT [10]

The monitor output includes both RCA type and S video configurations. This output is for connecting television monitors or projectors.

13 VOLTAGE SELECTOR (worldwide models only) [5]

Tip

The audio input jacks of the TX-SR500/TX-SR500E do not accept direct connection of an analog turntable.

If you want to connect a turntable to the TX-SR500/TX-SR500E, prepare a phono equalizer and connect it to the unused audio input jacks (IN L/R).

Refer to the instruction manuals of the phono equalizer and turntable for details.

Index to parts and controls

RC-479S (For models other than North American models)

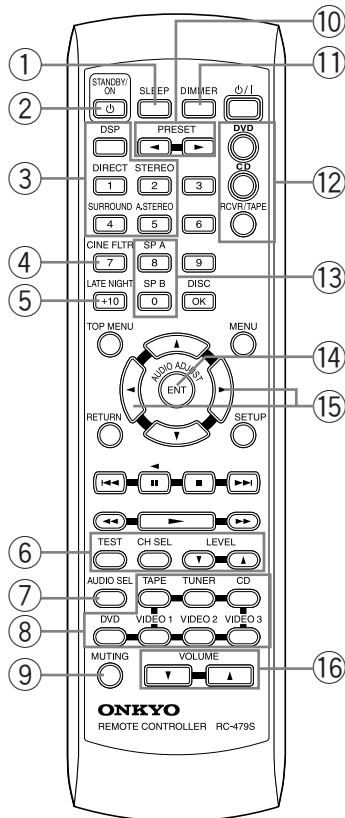

Explanations on this page are for controlling the TX-SR500/TX-SR500E. To operate other components, see "Using remote controller" on pages 34 through 35, and "Pre-programming remote controller (North American models only)" on pages 36 and 37.

For operational instructions, refer to the page indicated in brackets.

- ① **SLEEP button [27]**
For setting the sleep time.
This button is provided only on the remote controller.
- ② **STANDBY/ON button [17]**
Turns on the TX-SR500/TX-SR500E or put it in standby.
- ③ **Listening mode buttons [32]**
Press to change the listening mode.
- ④ **CINE FLTR button [29]**
Press to activate/de-activate Cinema Filter function.
- ⑤ **LATE NIGHT button [29]**
Press to change the late night setting.
- ⑥ **TEST/CH SEL/LEVEL ▲/▼ buttons [20, 28]**
For setting the output levels for each speaker.
These buttons are provided only on the remote controller.
- ⑦ **AUDIO SEL button [28]**
Press to select an audio input signal format other than TUNER.

- ⑧ **INPUT SELECTOR buttons [21-25, 28, 33]**
For selecting the input source.

- ⑨ **MUTING button [26]**
Activates the mute function.
This button is provided only on the remote controller.

- ⑩ **PRESET ◀▶ button [25]**
For selecting a tuner preset channel.

- ⑪ **DIMMER button [27]**
For adjusting the brightness of the front display.

- ⑫ **Mode buttons [34-37]**
For selecting the component to be operated by the remote controller.

- ⑬ **SP A/SP B buttons [21, 26]**
Press to switch the speaker systems in use between A and B.

- ⑭ **AUDIO ADJUST button [29]**
Press to adjust bass, treble, late night function and cinema filter function setting.

- ⑮ **ADJUST ◀▶ button [29]**
Press to adjust the values and parameters of the mode selected using the AUDIO ADJUST, SPEAKER ADJUST or AUDIO SELECTOR button.

- ⑯ **VOLUME ▲/▼ button [21, 24]**
For adjusting the volume.

RC-478M (For North American models)

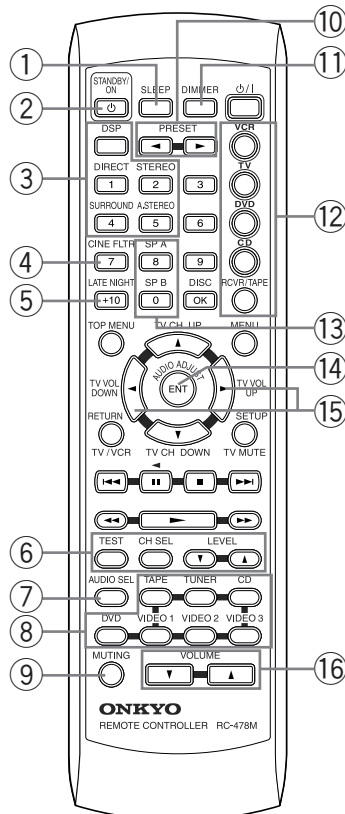

Connecting to audio/video equipment

Here is explanation of how to connect the main components to the TX-SR500/SR500E in the standard manner. There are many ways that any one component can be connected, and it is up to you to decide which method best fits your situation. The directions given here are only one option and should only be thought of as such. It is best to fully understand the nature of each connector and terminal as well as each of your components and their features to ascertain which method of connection is best.

- Be sure to always refer to the instruction manual that came with the component that you are connecting.
- Do not plug in the power cord until all connections have been made.
- For input jacks, red connectors (marked R) are used for the right channel, white connectors (marked L) are used for the left channel, and yellow connectors (marked VIDEO) are used for video connection.

Note

The signal that comes in from S VIDEO IN is sent to S VIDEO OUT. The signal that comes in from VIDEO IN is sent to VIDEO OUT.

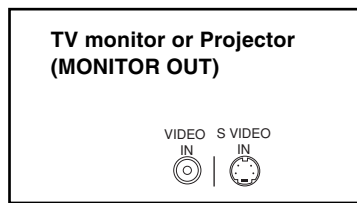

- Insert all plugs and connectors securely. Improper connections can result in noise, poor performance, or damage to the equipment.

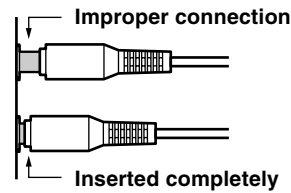

- Do not bind audio connection cables with power cords and speaker cables. Doing so may adversely effect the sound quality.

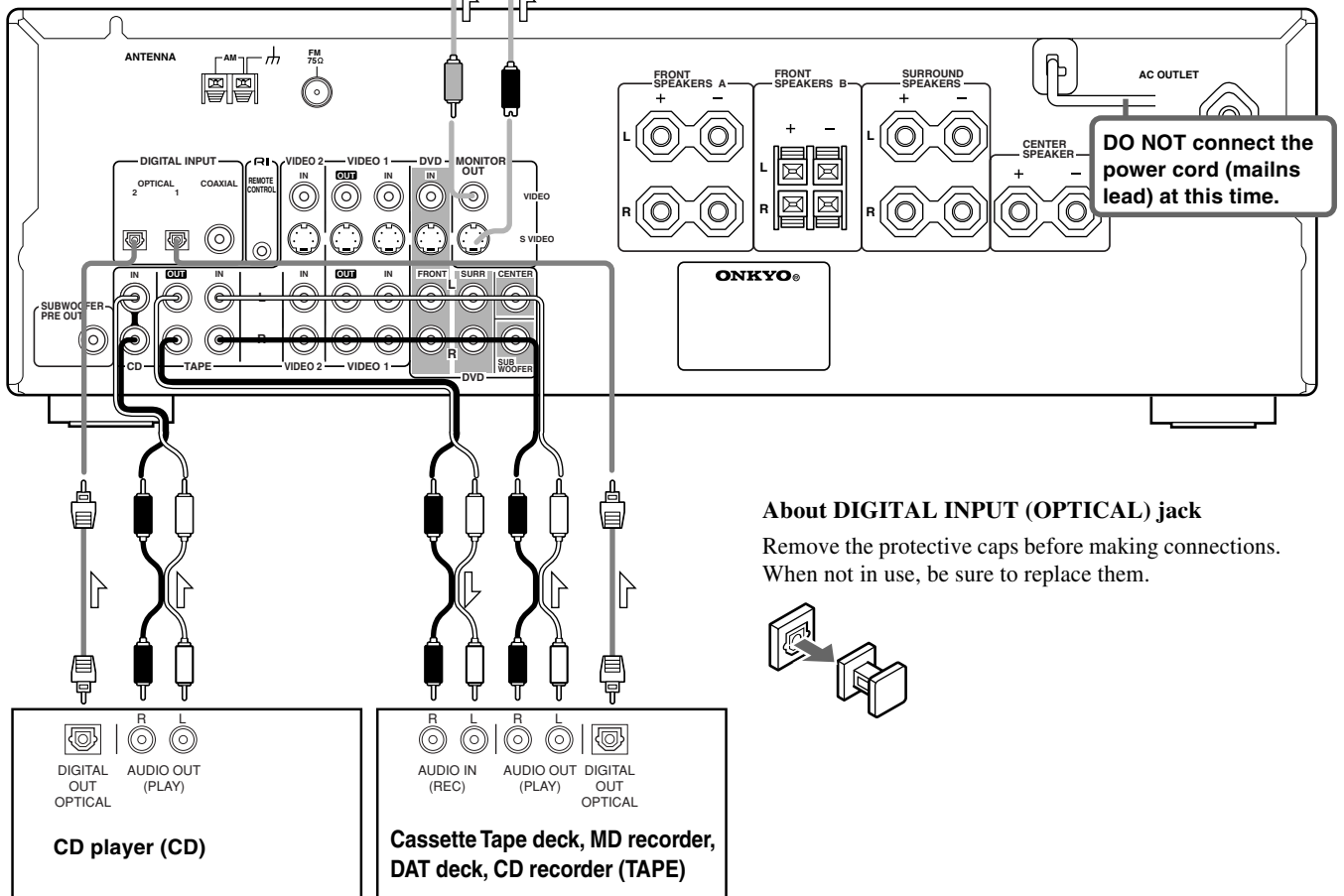
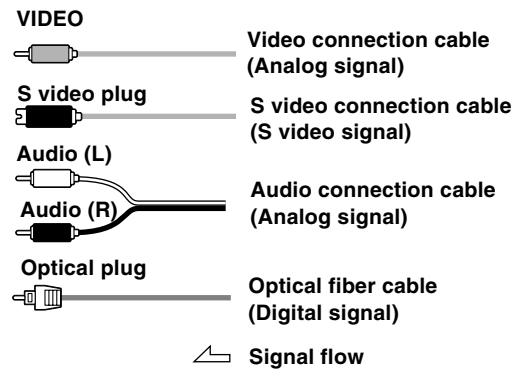

About DIGITAL INPUT (OPTICAL) jack

Remove the protective caps before making connections. When not in use, be sure to replace them.

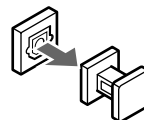

- To connect the digital output from a component connected to the TAPE jacks to this unit, use the OPTICAL 1 input jack.
To connect the digital output to the OPTICAL 2 or COAXIAL input jack of this unit, it is required to change the assignment of digital inputs to input sources by referring to "Setting the digital inputs" on page 22.
- The TAPE OUT jack does not output the signal input from the DIGITAL INPUT jack. (The digital signal is not converted into analog signal.)

- To connect the digital output from CD player connected to the CD jacks to this unit, use the OPTICAL 2 input jack.
To connect the digital output to the OPTICAL 1 or COAXIAL input jack of this unit, it is required to change the assignment of digital inputs to input sources by referring to "Setting the digital inputs" on page 22.

Connecting to audio/video equipment

About the DVD, VIDEO 1, VIDEO 2 and MONITOR OUT jacks

The video input/output connections are also necessary even if you make the S video input/output connections.

- If the DVD player has both 5.1 channel audio outputs and 2 channel audio outputs, and you want to connect the DVD player only using the FRONT L/R jacks on the TX-SR500/TX-SR500E, use the 2 channel audio output jacks on the DVD player.
- If the DVD player only has the 2 channel audio outputs, connect it to the FRONT L/R jacks.
- To connect the digital output from DVD player connected to the DVD jacks to this unit, use the COAXIAL input jack.

To connect the digital output to the OPTICAL 1 or 2 input jack of this unit, it is required to change the assignment of digital inputs to input sources by referring to "Setting the digital inputs" on page 22.

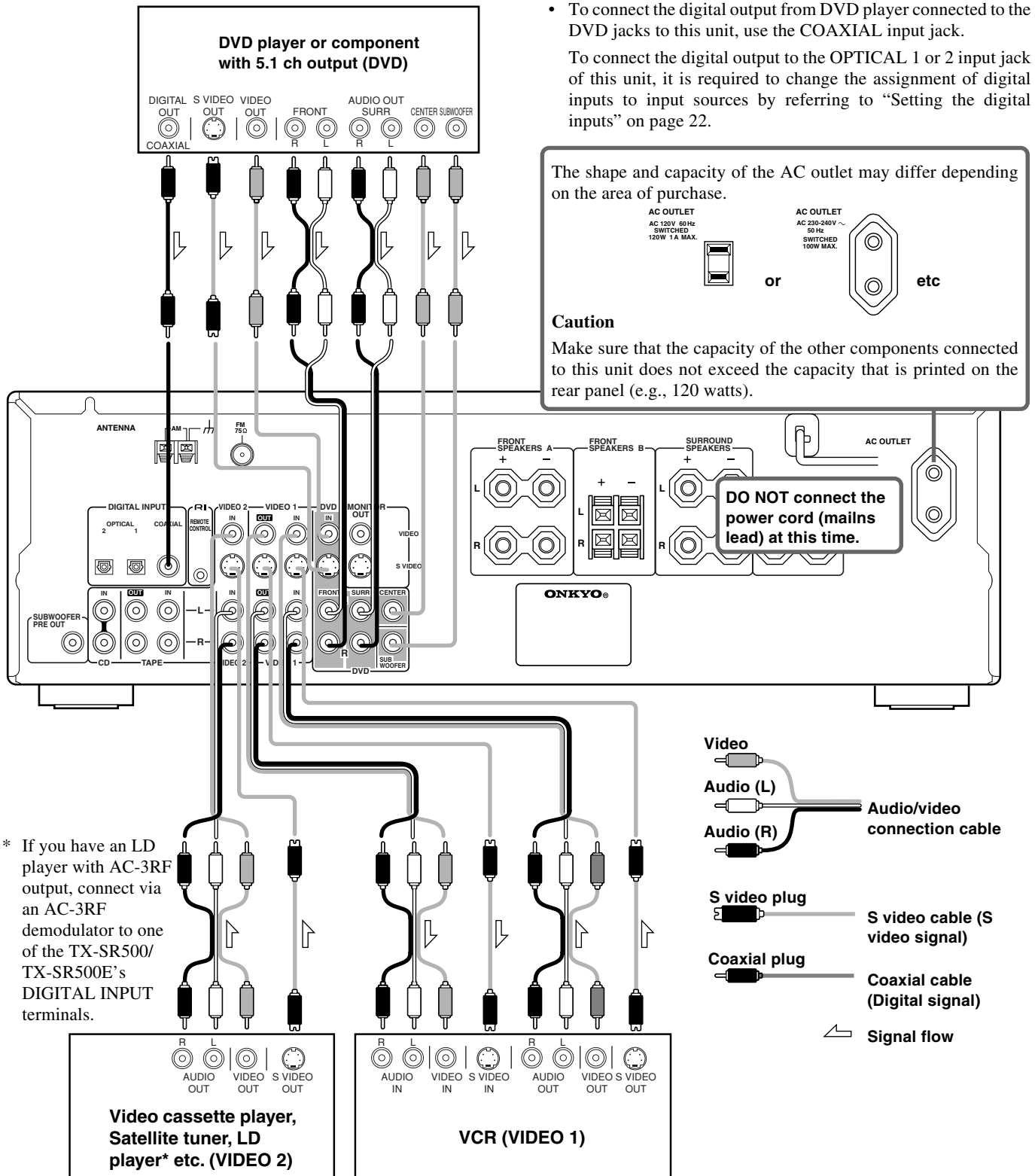

* If you have an LD player with AC-3RF output, connect via an AC-3RF demodulator to one of the TX-SR500/TX-SR500E's DIGITAL INPUT terminals.

To connect the digital output from satellite tuner etc. connected to the VIDEO 1 or VIDEO 2 jacks to the COAXIAL, OPTICAL 1 or 2 input jack of this unit, it is required to change the assignment of digital inputs to input sources by referring to "Setting the digital inputs" on page 22.

Positioning speakers/Connecting speakers

Two speaker systems (FRONT SPEAKERS A and FRONT SPEAKERS B) can be connected to the Receiver.

The FRONT SPEAKERS A system is to be placed in the main room, and the FRONT SPEAKERS B system is to be placed in a second room.

The configuration of the FRONT SPEAKERS A system

The FRONT SPEAKERS A system consists of the front left, center, and right speakers, surround left and right speakers, and subwoofer. You can reproduce the sounds such as Dolby surround and DTS surround.

The configuration of the FRONT SPEAKERS B system

The FRONT SPEAKERS B system consists of the front left and right speakers.

You can reproduce only monaural and stereo sounds.

Standard speaker placement of the SPEAKERS A system

Speaker placement plays an important role in the reproduction of Surround sound.

The placement of the speakers varies depending on the size of the room and the wall coverings used in the room. The illustration below shows an example of a layout for standard speaker placement. Refer to this example when you position the speakers in order to experience the best of Surround sound.

For ideal Surround effects, all speakers should be installed.

If a center speaker or subwoofer is not connected, the sound from the unused channel is properly distributed to the connected speakers in order to reproduce the best Surround sound possible.

Front

The center speaker reproduces a richer sound image by enhancing the perception of the sound's source and movement.

The left, right, and center speakers should face the seated listener and be placed at ear level.

Surround

The surround speakers reproduce the feel of a moving sound while creating the sensation of being in the middle of the action.

Place the left and right surround speakers 3 feet (1 meter) above the listener's ear level and facing toward the sides of the room, making sure that the listener is within the speakers' dispersion angle.

Subwoofer

Install a subwoofer with a built-in power amplifier for powerful bass sounds.

The placement of the subwoofer does not affect the final quality of the sound image much, therefore, you can install it wherever it is convenient.

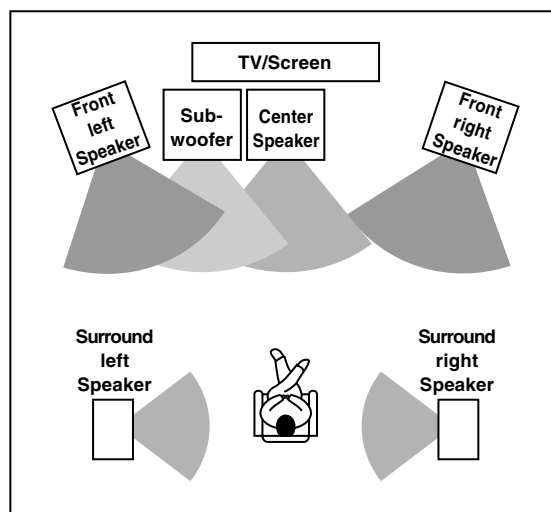

Refer to the speakers' instruction manuals for details.

Using the provided speaker labels

The speaker terminals (+) of this unit are given different colors for ease of identification. By attaching the provided speaker labels to the speaker cables, the cables to be connected to the terminals can be identified easily.

Attach the speaker label of each color to the speaker cable for the corresponding terminal and connect the speaker cable to the terminal having the same color as the label attached to the cable.

The speaker terminals are colored as follows.

- | | |
|-----------------------------|-------|
| Front left speaker (+): | white |
| Front Right speaker (+): | red |
| Center speaker (+): | green |
| Surround left speaker (+): | blue |
| Surround right speaker (+): | gray |

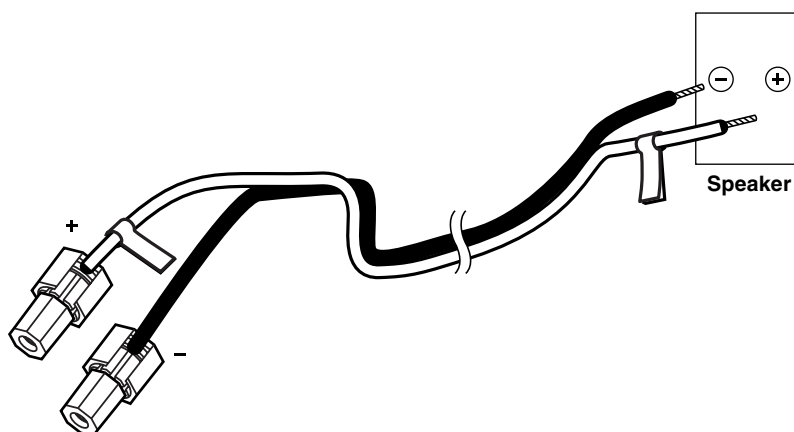

Positioning speakers/Connecting speakers

Before connecting

- Refer also to the instruction manuals of the speakers.
- Be sure to connect the positive and negative cables for the speakers properly. If they are mixed up, the left and right signals will be reversed and the audio will sound unnatural.
- Connect speakers with an impedance between 6 Ω and 16 Ω. Connecting speakers with an impedance less than 6 Ω may damage the TX-SR500/TX-SR500E.
- To prevent damage to circuits, never short-circuit the positive (+) and negative (-) speaker wires.

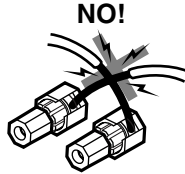

- Do not connect more than one speaker cable to one speaker terminal. Doing so may damage the TX-SR500/TX-SR500E.
- When you are using only one speaker or when you wish to listen to monaural (mono) sound, a single speaker should never be connected in parallel to both the right and left channel terminals simultaneously.

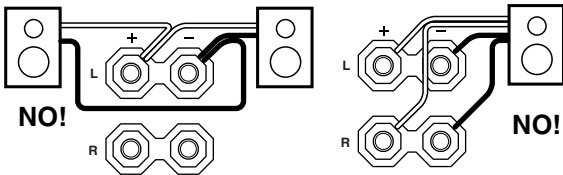

How to connect to the FRONT SPEAKERS A, SURROUND SPEAKERS and CENTER SPEAKER terminals

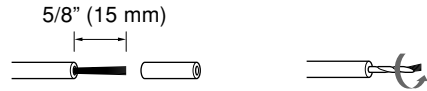

Strip 5/8" (15 mm) from the end of each cable, then twist the exposed wires tightly.

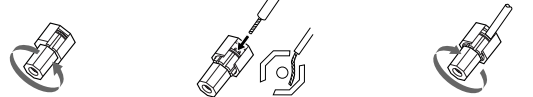

Loosen the screw.

Fully insert the end of the cable.

Tighten the screw.

How to connect to the FRONT SPEAKERS B terminals

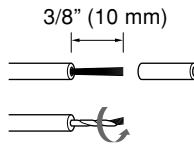

Strip 3/8" (10 mm) from the end of each cable, then twist the exposed wires tightly.

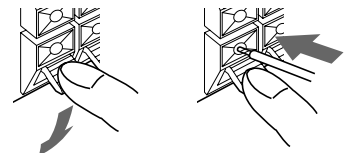

Press and hold the lever.

Insert the stripped end of the cable. By releasing the lever, the lever is replaced.

Connecting to SPEAKERS A

Use the SUBWOOFER PRE OUT jack to connect a subwoofer with a built-in power amplifier.

If your subwoofer does not have a built-in amplifier, connect an amplifier to the SUBWOOFER PRE OUT jack and the subwoofer to the amplifier.

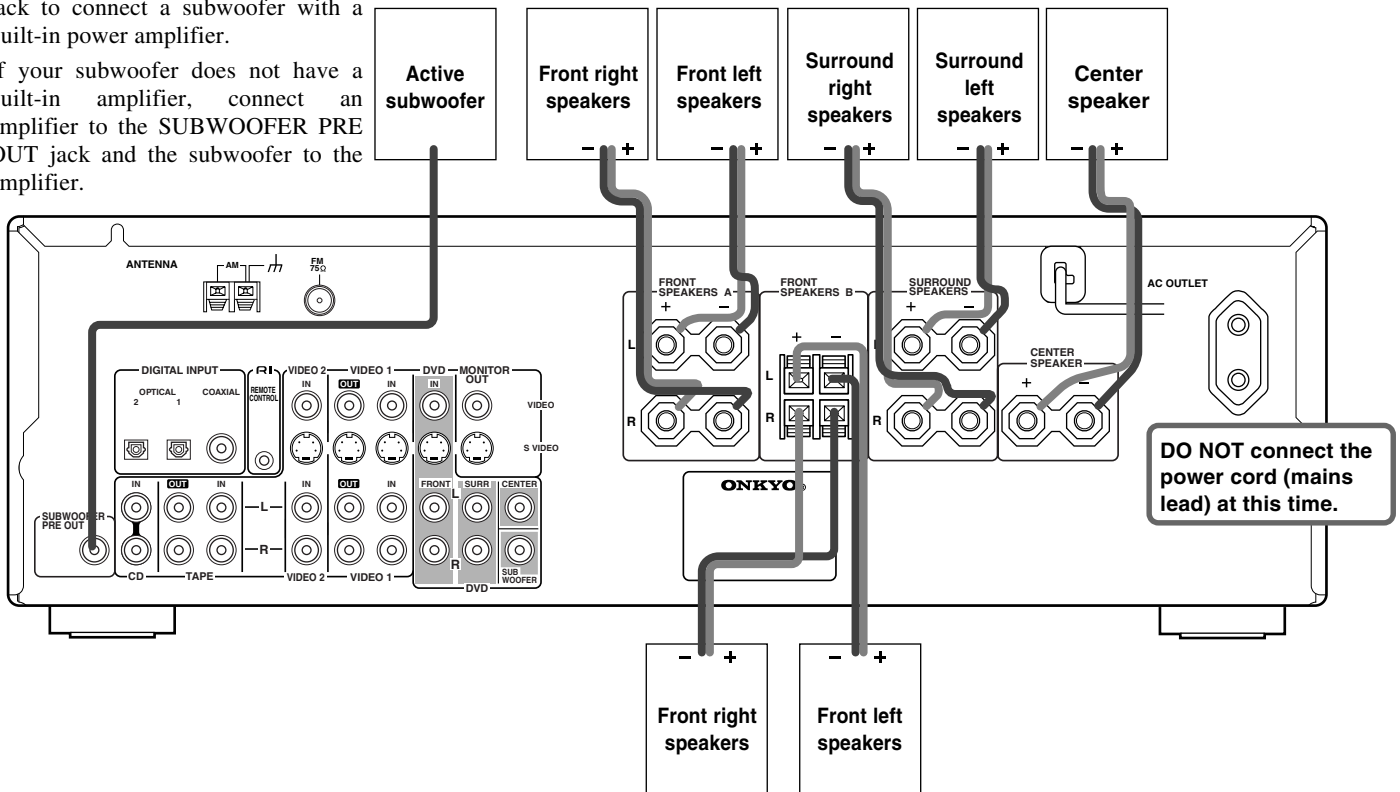

Connecting to SPEAKERS B

Connecting antennas

Connecting the supplied FM and AM indoor antennas (aerials)

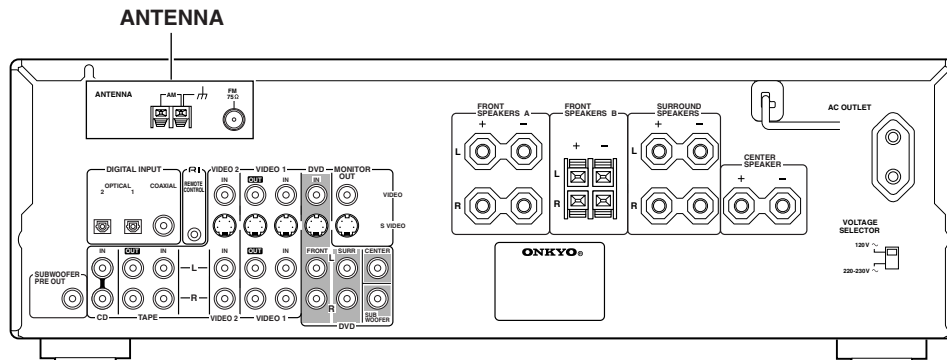

North American models

- 1 Strip away the insulation from the end of the cord.
- 2 Fully insert the stripped end of the cord.

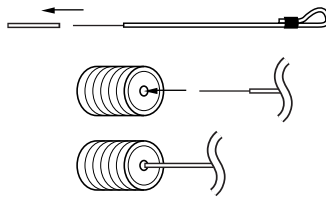

Except for North American models

Fully insert the end of the cord.

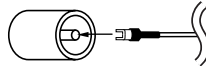

FM indoor antenna (aerial)

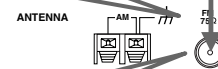

Adjusting the position of the FM indoor antenna (aerial)

The FM indoor antenna is for indoor use only. During use, extend the antenna and move it in various directions until the clearest signal is received. Fix it with push pins or similar implements in the position that will cause the least amount of distortion.

If the reception is not very clear with the attached FM indoor antenna, the use of an outdoor antenna is recommended.

Rotate the outer frame of the antenna.

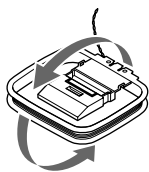

Insert into the hole.

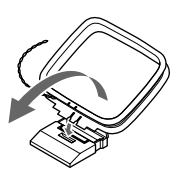

Extend the antenna cord.

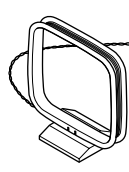

AM indoor antenna (aerial)

Press up and hold the lever.

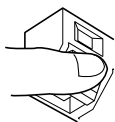

Insert the end of the cord.

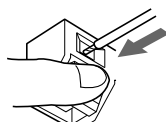

Release the lever to secure the connection.

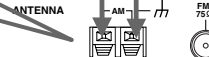
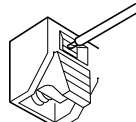

Note

Insert one end of the AM antenna (aerial) cord to either of the AM antenna (aerial) connectors and the other end to the other connector. There is no difference between one end of the AM antenna (aerial) cord and the other end, unlike the speaker cables which have positive and negative poles.

Adjusting the position of the AM indoor antenna (aerial)

The AM loop antenna is for indoor use only. Set it in the direction and position where you receive signals clearly. Put it as far away as possible from the TX-SR500/TX-SR500E, televisions, speaker cables, and power cords.

When reception is not satisfactory with the attached AM loop antenna alone, connection of an outdoor antenna is recommended.

Connecting antennas

Connecting an FM outdoor antenna (aerial)

If the FM reception is not very clear with the supplied antenna (aerial), connect an FM outdoor antenna (aerial) instead of the indoor FM antenna (aerial).

Connecting coaxial cable to a 75/300 ohm antenna (aerial) adapter*

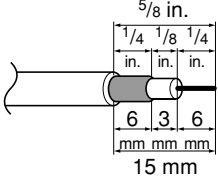
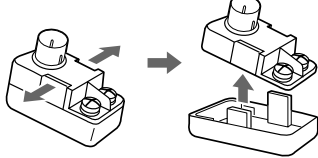
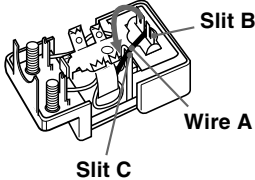
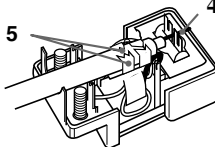
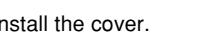
- Strip the end of the coaxial cable.
 
- With your fingernail or a small screwdriver, press the stoppers outward and remove the cover.
 
- Remove the transformer wire A from slit B and insert it into slit C.
 
- Insert the end of the cable.
- Clamp it in place with pliers.
 
- Reinstall the cover.
 

FM outdoor antenna (aerial)

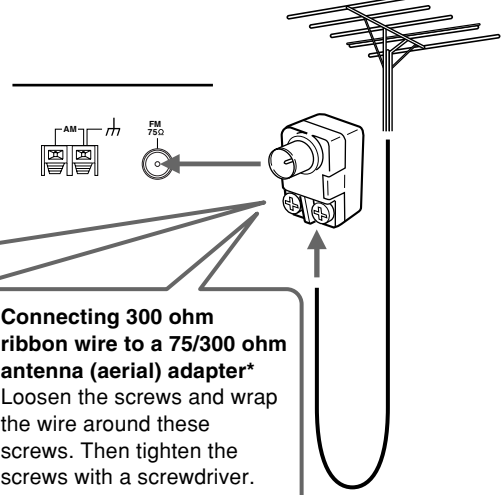

Connecting 300 ohm ribbon wire to a 75/300 ohm antenna (aerial) adapter*
Loosen the screws and wrap the wire around these screws. Then tighten the screws with a screwdriver.

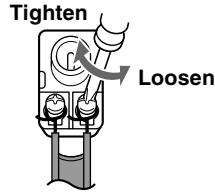

Tighten
Loosen

* (USA, Canadian and European models) Not supplied
(Other models) Supplied

Notes

- Install the antenna (aerial) well away from tall buildings and in an area where FM stations can directly be received.
- Keep the antenna (aerial) away from noise sources (neon signs, busy roads, etc.).
- It is dangerous to put the antenna (aerial) close to power lines. Keep it well away from power lines, transformers, etc.
- To avoid the risk of lightning and electrical shock, grounding is necessary. Follow item 14 of the "Important Safeguards" on page 2 when you install the outdoor antenna (aerial).

Connecting an AM outdoor antenna (aerial)

An outdoor antenna (aerial) will be more effective if it is stretched horizontally above a window or outside.

Leave the supplied AM indoor antenna (aerial) connected.

Note

To avoid the risk of lightning and electrical shock, grounding is necessary. Follow item 14 of the "Important Safeguards" on page 2 when you install an outdoor antenna (aerial).

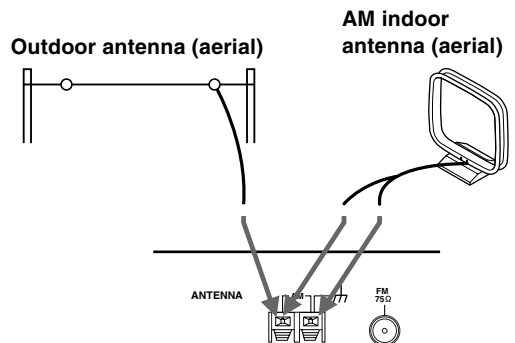

Directional linkage

Do not use the same antenna (aerial) for both FM and TV (or VCR) reception since the FM and TV (or VCR) signals can interfere with each other. If you must use a common FM/TV (or VCR) antenna (aerial), use a directional linkage type splitter.

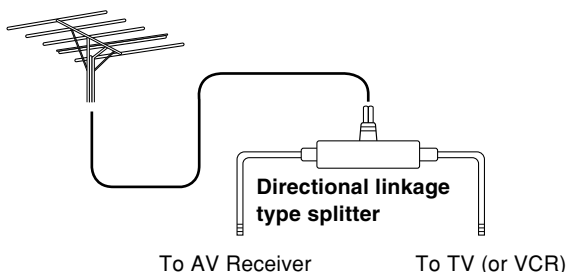

Connections for remote control (RI)

The **RI** terminal on the TX-SR500/TX-SR500E is for connecting other Onkyo components equipped with the same **RI** terminal. When a component is **RI**-connected, you can point the remote controller supplied with the TX-SR500/TX-SR500E at the sensor on the TX-SR500/TX-SR500E and operate that component without having to switch remote controllers. In addition, by connecting components to the **RI** terminal, you can also perform the system operation given below.

To connect components using the **RI** terminal, simply connect a **RI** cable from this **RI** terminal to the **RI** terminal of the other component. An **RI** cable with a 3.5 mm (1/8 inch) miniature two-conductor plug comes with every cassette tape deck, compact disk player, MD recorder, and DVD player that has an **RI** terminal.

Power on/ready function

When the TX-SR500/TX-SR500E is in the standby state, if an **RI**-connected component is turned on, then the TX-SR500/TX-SR500E also turns on and the input source selected at the TX-SR500/TX-SR500E automatically switches to that component.

If the power cord for an **RI**-connected component is connected to the AC OUTLET on the TX-SR500/TX-SR500E, or if the TX-SR500/TX-SR500E is turned on, this function will not work.

Direct change function

When the play button is pressed at an **RI**-connected component, the input source selected at the TX-SR500/TX-SR500E automatically changes to that component.

Power off function

When the TX-SR500/TX-SR500E is placed in the standby state, all **RI**-connected components are also automatically put in the standby state.

Note

If an MD recorder is connected to the TAPE jack on the TX-SR500/TX-SR500E, switch the input selector from TAPE to MD (see page 23).

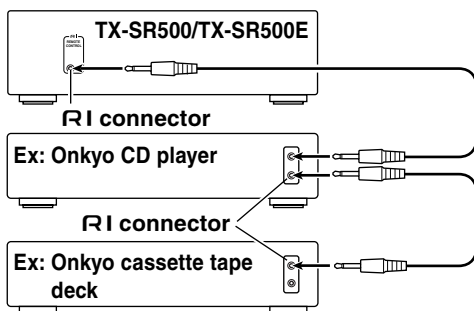
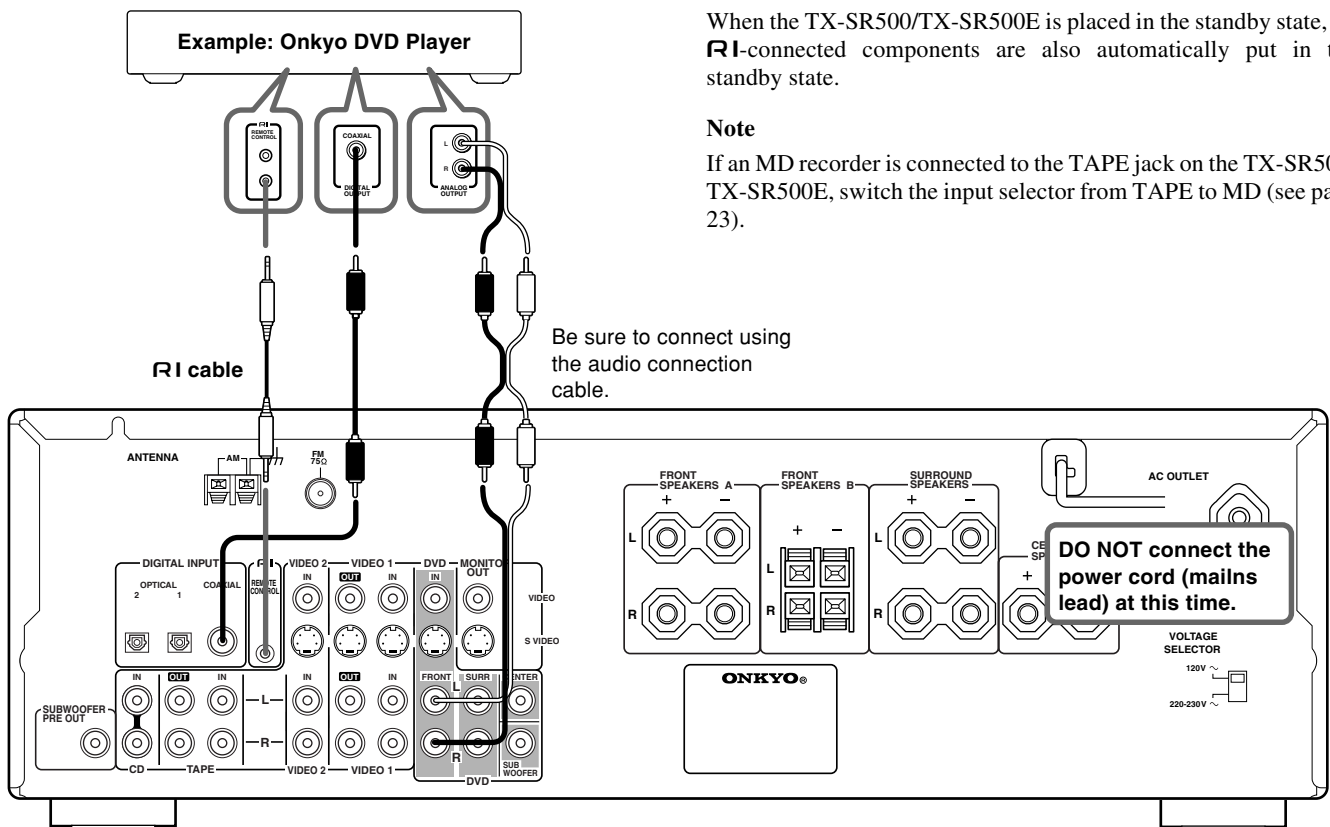

Connection example when there is more than one ONKYO components equipped with **RI** terminals

Notes

- Connect the plugs securely.
- Be sure to connect to the **RI** connectors using the **RI** cable.
- For remote control operation, the audio connection cables must also be connected.
- If a component has two **RI** terminals, you can use either one to connect to the TX-SR500/TX-SR500E. The other one can be used to daisy chain with another component.
- (USA and Canadian models only) With Onkyo DVD players, you can enter the pre-program code so that you can operate the DVD player directly with the remote controller without connecting the **RI** terminals (see page 36).
- Do not connect the AV Receiver's **RI** connector to any component other than an Onkyo product. It may cause malfunction.
- Certain component models may not be able to control the TX-SR500/TX-SR500E.

Connecting the power/Turning on the AV Receiver

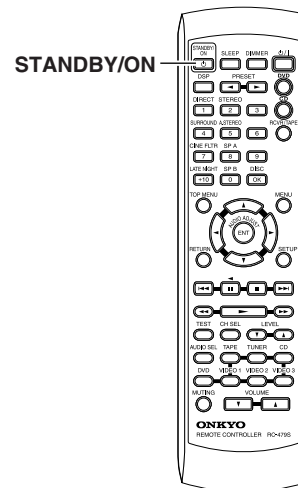
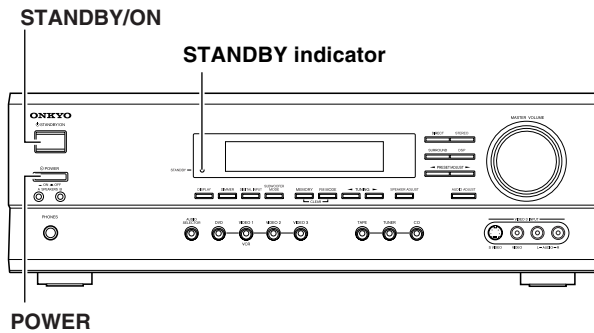

Before connecting

- Make sure that all the connections from pages 10 to 16 are complete.
- Turning on the AV Receiver may cause a momentary power surge, which might interfere with other electrical equipment such as computers. If this happens, use a wall outlet on a different circuit.

1. Connect the power cord (mains lead) to a wall outlet (the mains).

2. (Other than USA and Canadian models only) Press POWER to switch on the main power.

The TX-SR500/TX-SR500E enters standby mode.
The STANDBY indicator lights up.

Notes

- The TX-SR500/TX-SR500E is shipped with the main power (POWER) switch in the on position (ON).
- To switch off the main power, press the POWER switch again.
- The buttons on the remote controller don't operate if the POWER switch is set to OFF.

3. Press STANDBY/ON.

The AV Receiver turns on.

The ON indicator and display on the AV Receiver's front panel light. At the same time, the STANDBY indicator goes off.

Note

To turn off the AV Receiver, press STANDBY/ON. The AV Receiver enters standby mode. Be sure to set the volume to minimum before turning off the AV receiver.

Speaker setup

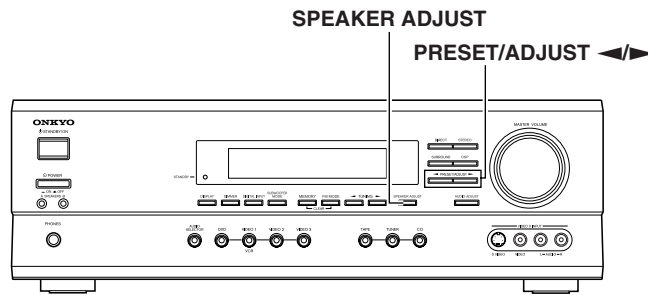

You need to set up the speaker configuration for the speaker system connected to the FRONT SPEAKERS A connectors (see page 13). (There is no speaker configuration setup for the SPEAKERS B system.)

Notes

- Speaker setup cannot be done if;
 - Headphones are connected (see page 26),
 - The FRONT SPEAKERS B system is on (see page 26),
 - “Multi ch” is selected with AUDIO SELECTOR button, or
 - Connected source is played.
- It is not necessary to set the parameters again once you have completed the setup unless you change the speaker configuration.

Selecting the number of speaker channels

1. Press SPEAKER ADJUST.

When the button is pressed, the current speaker setup will be displayed.

2. Press PRESET/ADJUST ◀/▶ repeatedly to select the number of channels.

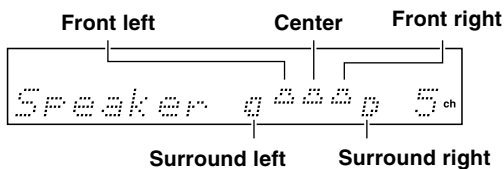

Display and number of speaker channels

- Speaker 5ch
- Speaker 2ch
- Speaker 3ch
- Speaker 4ch

Note

The listening mode will automatically change according to the number of channels if you set the number of channels.

Setting the crossover frequency

To reproduce low frequencies between 80 Hz and 120 Hz in an optimum condition, set the crossover frequency according to the low-frequency reproduction capabilities of the subwoofer and other speakers (front, center and surround).

1. Press SPEAKER ADJUST twice.

The current setting is displayed.

2. Press PRESET/ADJUST ◀/▶ repeatedly to select the crossover frequency.

Select from 80 Hz, 100 Hz and 120 Hz.

Refer to the following example for deciding the setting.

- When other speakers than the subwoofer are relatively small (when they cannot reproduce low frequencies sufficiently): 120 Hz
- When other speakers than the subwoofer are relatively large (when they can reproduce low frequencies sufficiently): 80 Hz

If you want more accurate setting, refer to the instruction manuals of the speakers and perform the setting according to their reproduce frequency bands. Also listen to the actual sound and set to the high position (120 Hz) if you feel that the sound from the subwoofer is not enough or to the low position (80 Hz) if you feel that the sound is loud.

Speaker setup

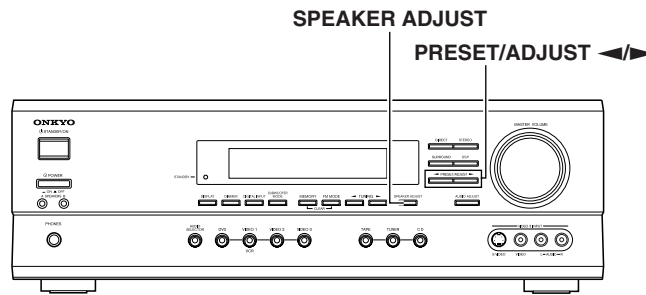

Setting the delay time

In the procedure below, select the values which approximate the actual distances.

This operation consists of entering the time error between output of sound from each speaker type (front, center and surround) and arrival at the listening position. The user should measure the distance from the listening position to each speaker type and obtain the time error (delay time) based on the appropriate table.

Assume that the distance from the listening position to the left/right front speakers is (L).

Assume that the distance from the listening position to the center speaker is (L₁).

Assume that the distance from the listening position to the surround speakers is (L₂).

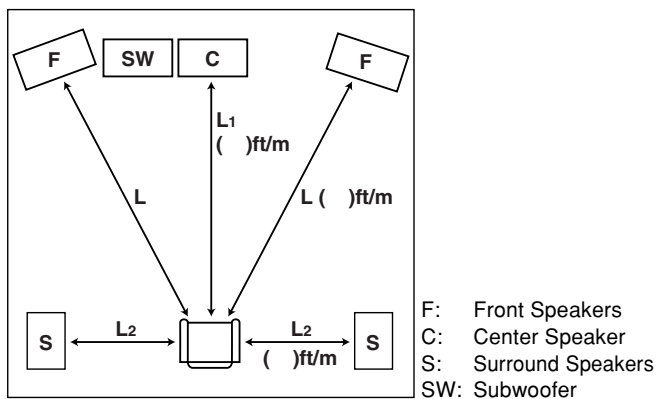

L - L ₁ /L - L ₂ (ft/m)	Center delay	Surround delay
0/0	0	0
1/0.3	1	1
2/0.6	2	2
3/0.9	3	3
4/1.2	4	4
5/1.5	5	5
6/1.8	—	6
7/2.1	—	7
8/2.4	—	8
9/2.7	—	9
10/3.0	—	10
11/3.3	—	11
12/3.6	—	12
13/3.9	—	13
14/4.2	—	14
15/4.5	—	15

Setting the center delay

Calculate the difference between (L) and (L₁), find the closest value to it from the table below and obtain the center delay time.

For example, when (L) is 16 feet (5 meters) and (L₁) is 13 feet (4 meters),

$$(L) - (L_1) = 16 - 13 = 3 \text{ feet} / 5 - 4 = 1 \text{ meter}$$

Since the closest value to 3 feet (1 meter) in the table below is 3/0.9 (ft/m), the center delay time to be set is 3.

1. Press **SPEAKER ADJUST** repeatedly until **“CenterDelay”** is displayed.

2. Press **PRESET/ADJUST** ◀/▶ repeatedly to select the center delay value.

It can be selected from 0, 1, 2, 3, 4 and 5 ms.

Setting the surround delay

Calculate the difference between (L) and (L₂), find the closest value to it from the table below and obtain the surround delay time.

For example, when (L) is 16 feet (5 meters) and (L₂) is 6 feet (2 meters),

$$(L) - (L_2) = 16 - 6 = 10 \text{ feet} / 5 - 2 = 3 \text{ meters}$$

Since the value of 10 feet (3 meters) is found in the 11th line in the table below, the surround delay time to be set is 10.

1. Press **SPEAKER ADJUST** repeatedly until **“Surr Delay”** is displayed.

2. Press **PRESET/ADJUST** ◀/▶ repeatedly to select the surround delay value.

It can be selected from 0 to 15 ms.

Speaker setup

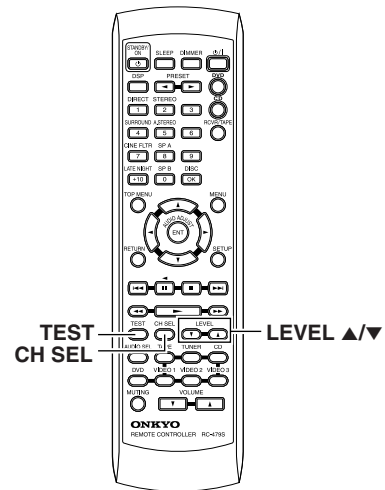
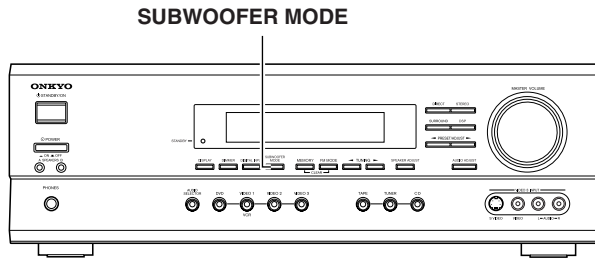

Setting the subwoofer mode

Press **SUBWOOFER MODE** on the unit.

With the first press of the button, you can check the present setting. Then each press of the button changes the subwoofer mode as follows (a tip on how to select the right subwoofer mode is in parentheses):

Subwoofer Mode 1

Mode1

(To output the low frequencies of all channels from the subwoofer.)

↓

Subwoofer Mode 2

Mode2

(To output the low frequencies of the center and surround channels from the subwoofer.)

↓

Subwoofer Mode 3

Mode3

(To output only the LFE channel* of a 5.1-channel source from the subwoofer.)

↓

Subwoofer Off

Off

(When no subwoofer is connected or when a subwoofer is connected but not used.)

* LFE channel: The channel recording the LFE (Low Frequency Effects).

The normal display resumes in three seconds.

Note

When the subwoofer mode is set to Mode 2 or Mode 3 and audio is reproduced in the Stereo mode, the subwoofer may not output audio from certain sources (2 channel-Dolby Digital/DTS source etc.).

Adjusting each speaker's relative volume balance — Test tone

Adjust each speaker's relative volume balance so that the volumes of all speakers' test tones sound equal at the listening position.

Note

You cannot adjust the volume balance while the muting function is activated.

1. Press TEST on the remote controller.

Each speaker emits the test tone (pink noise) and the display shows the speaker emitting the test tone.

2. Press CH SEL repeatedly to select the speaker, then press LEVEL ▲/▼ on the remote controller to adjust the volume level.

When CH SEL is pressed repeatedly, each speaker produces the test tone (pink noise) in the following order: Left → Center → Right → Surr Right → Surr Left → Subwoofer.

The volume level can be adjusted between -12dB and +12dB.



Notes

- No test tone will be emitted from the speaker which is not included in the speaker configuration on page 20 even if it is actually connected.
- No test tone will be emitted from the subwoofer when the subwoofer mode is set to "Subwoofer Off".
- Even when CH SEL is not pressed, the test tone will move to the next speaker in 2 seconds.

3. When you have completed the adjustment by repeating step 2, press TEST.

The test tone stops and the normal display resumes.

Note

Even if you don't press TEST, the test tone will stop after 2 minutes.

Playing the connected source

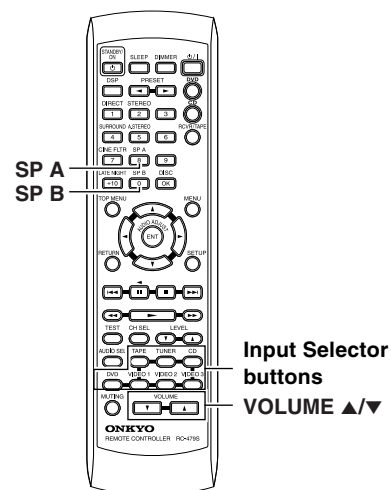
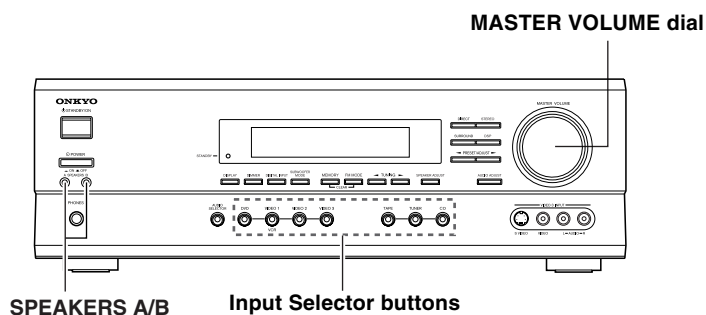

This section shows you how to play the sources connected to the AV Receiver.

You may need to see “Connecting to audio/video equipment” on page 10 while following the steps in this section.

Selecting a sound source

1. Press input selector button to select one of the following input sources:

- DVD
- VIDEO 1
- VIDEO 2
- VIDEO 3
- TAPE
- CD

e.g. When VIDEO 3 is selected.

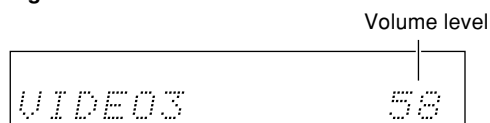

When MD recorder is connected to the TAPE jacks, you can switch the source from TAPE to MD (see page 23).

2. Ensure that the indicator(s) for the speaker system(s) to be used are lit on the display.

If no SPEAKERS indicator is lit, press SPEAKERS A/B on the unit or SP A/SP B on the remote controller to select the speaker system(s) to be used.

3. Start playing the selected source.

4. Press VOLUME ▲/▼ on the remote controller or turn MASTER VOLUME dial on the unit to adjust the volume.

About digital sound

If the equipment is digitally connected to the AV Receiver, the sound from the digital input will automatically be selected and reproduced instead of the analog sound as explained below.

The initial settings are as follows:

- When the DVD source is selected, the digital sound from the DIGITAL INPUT COAXIAL connector is reproduced.
- When the CD source is selected, the digital sound from the DIGITAL INPUT OPTICAL 2 connector is reproduced.
- When the TAPE source is selected, the digital sound from the DIGITAL INPUT OPTICAL 1 connector is reproduced.

When the digital sound is reproduced, the DIGITAL, DTS, or PCM (2 channel digital stereo) indicator lights up according to the received sound system in the AV Receiver's display.

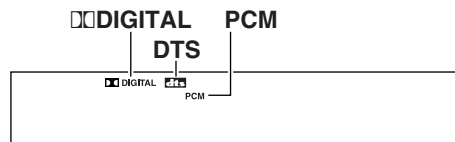

Various functions while playing the connected source

To use the following functions, see pages 26 and 27.

- Turning on/off the SPEAKERS A/SPEAKERS B systems
- Muting the sound
- Listening through headphones
- Changing the display
- Controlling the brightness of the lights on the AV Receiver
- Using the sleep timer

Enjoying the surround modes while playing the connected source

See page 30.

Playing the connected source

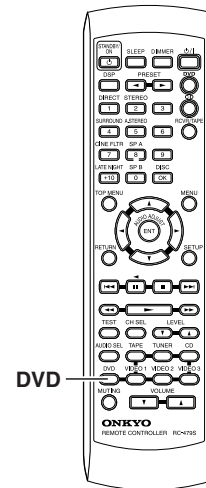
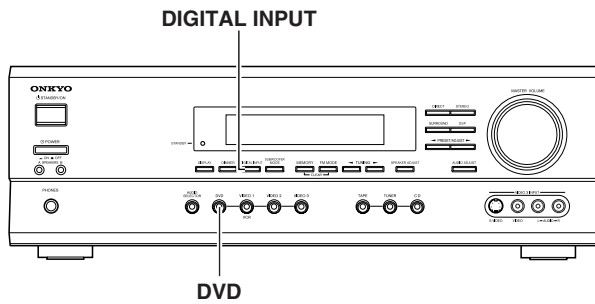

Setting the digital inputs

When connecting digital source components to the DIGITAL INPUT jacks on the rear panel, assign the input source button on the front panel to either a DIGITAL INPUT OPTICAL or COAXIAL jack depending on the type of connector on the digital source components. The DVD, CD, VIDEO 1, VIDEO 2, VIDEO 3 and TAPE inputs can be assigned to the DIGITAL INPUT jacks.

With the initial setting, the OPTICAL 2 connector is assigned to the CD input, COAXIAL is assigned to the DVD input and OPTICAL 1 is assigned to the TAPE input, and no input connector is assigned to the VIDEO 1-3 inputs.

Default setting

Input source	Digital input
CD	OPTICAL 2
TUNER	/
TAPE	OPTICAL 1
VIDEO 3	----
VIDEO 2	----
VIDEO 1	----
DVD	COAXIAL

---- : Available for digital input but not set in initial setting.

/ : Not available for digital input.

For example, follow the steps below to assign OPTICAL 1 to the DVD device connected to the DIGITAL INPUT OPTICAL 1 jack.

1. Press DVD.

The DVD input is selected and “DVD” appears in the display.

DVD Stereo

2. Press DIGITAL INPUT.

The current DVD setting (COAX) appears.

DVD ← COAX

3. Press DIGITAL INPUT repeatedly to select “OPT 1”.

DVD ← OPT1

Pressing DIGITAL INPUT repeatedly will change the setting as follows:

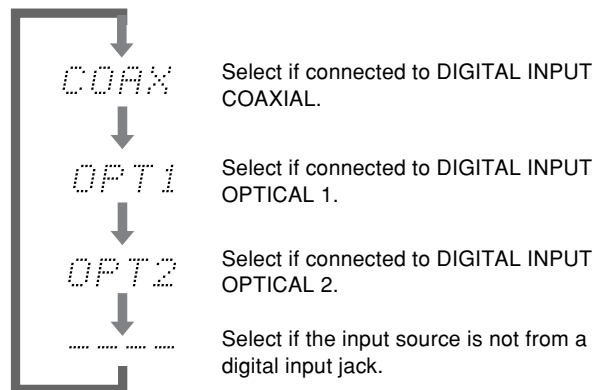

About three seconds after “DVD ← OPT1” is selected, the original display appears and the setting is completed.

If you have selected digital input, you can also select the input signal format (refer to “Setting the input signal format” on page 28).

Playing the connected source

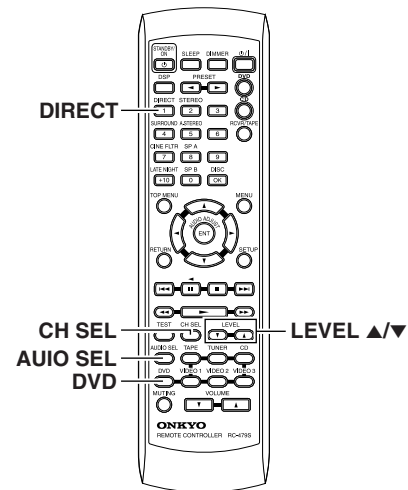
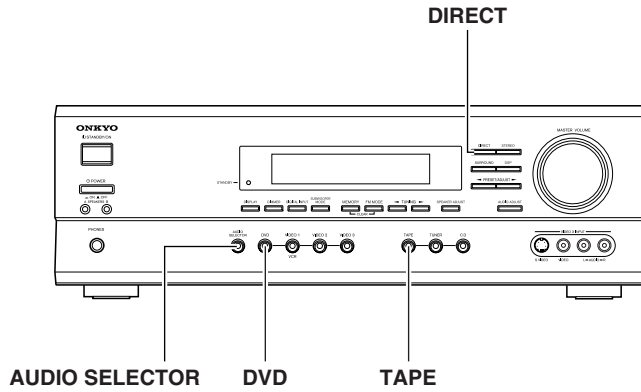

Using multi channel input

The multi channel input refers to a system, which is compatible with a source component equipped with 5.1-channel outputs (DVD player, MPEG decoder, etc.), reproducing the left/right front, center and left/right surround channels from five respective speakers and outputting the subwoofer channel from SUB WOOFER (refer to page 13).

1. Press **DVD**.
2. Press **AUDIO SELECTOR** on the unit or **AUDIO SEL** on the remote controller repeatedly to select "Multich".
3. Turn on the component connected to the **DVD (FRONT L/R, SURR L/R, CENTER and SUBWOOFER)** port and start playing the desired media.
4. If necessary, press **CH SEL** on the remote controller to select an individual speaker. Then press **LEVEL ▲/▼** to adjust the output level as desired.

Adjust the speaker output level so that you can hear the same sound level from each speaker at the listening position. For the front right, front left, center, surround right and surround left speakers, the output levels can be adjusted between -12 to +12 dB. The subwoofer can be adjusted between -30 to +12 dB.

The volume levels from the speakers reproducing multi channel input source are independent from the speaker levels set using the test tone (page 20). These settings are not applied to speakers reproducing multi channel input source.

Applying the audio tone adjustment (Bass/Treble) effects to the audio

Press **DIRECT** on the unit or remote controller to set "Tone On". Each press of the button alternates "On" and "Off". Refer to page 29 to adjust audio.

Notes

- "Multich" can be selected only when DVD is selected as the input source.
- The surround mode cannot be selected when "Multich" is selected. Also, if "Multich" is selected during use of a surround mode, it is canceled automatically.
- Regardless of the speaker configuration, the input signal will be output to each corresponding speaker. For example, even if the speaker configuration is set to 2 ch, sound comes from all speakers.

Switch the source from TAPE to MD

You can set the AV receiver to show "MD" when the TAPE source is selected by pressing TAPE on the remote controller or on the unit.

This setting is needed to make the **RI** system control effective among the Onkyo cassette tape deck or MD recorder.

- 1 Press **TAPE** to select the input source.
- 2 Press and hold **TAPE** on the unit until the display changes (for about 2 seconds).

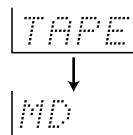

To restore the display

Press and hold **TAPE** on the unit until the display changes (for about 2 seconds).

Listening to the radio

There are two ways to select radio stations:

- Manual tuning
- Presetting radio stations then selecting the preset channels

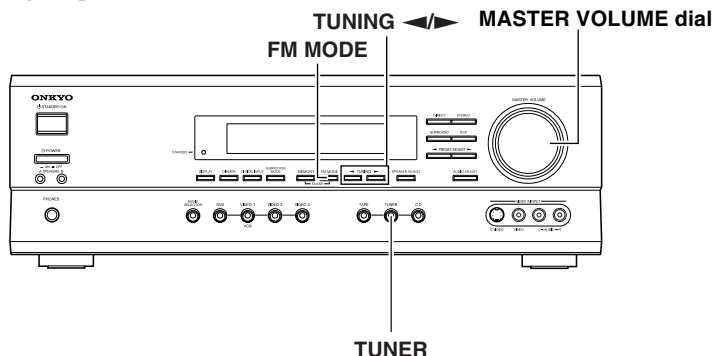

Setting the AM tuning step frequency (Worldwide models only)

You can switch the AM band tuning steps between 9 kHz and 10 kHz.

The initial setting is 9 kHz. Please set the AM tuning step frequency to match the AM band tuning step frequency in your area.

- USA and Canadian models 10 kHz
- Other models 9 kHz

Press **MEMORY** while holding down **TUNER**.

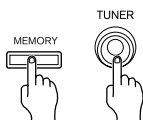

Note

All the preset stations are erased when you switch the AM band tuning steps.

When the band is AM

The frequency changes as follows:

- (USA and Canadian area)
In 10 kHz steps
- (Other area)
In 9 kHz steps

When you release the button, the frequency stops changing and flashes in the display.

Note

If you press and hold PRESET/ADJUST $\blacktriangleleft/\blacktriangleright$ short time, the AV Receiver enters the selecting preset stations mode. Refer to “Selecting preset stations” on page 25.

4. While the frequency is flashing (for about 3 seconds), press TUNING $\blacktriangleleft/\blacktriangleright$ to change the frequency.

- The frequency changes each time you press TUNING $\blacktriangleleft/\blacktriangleright$.
- You can change the frequency as long as the frequency in the display is flashing. Each press of either button causes the frequency to flash for about 3 seconds.

Tuning manually

1. Press TUNER.

The selected band appears in the display. Each time you press the button, the band changes as follows: AM \leftrightarrow FM.

e.g. When FM is selected.

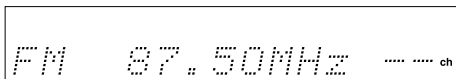

2. Turn MASTER VOLUME dial on the unit to adjust the volume.

3. Press and hold TUNING $\blacktriangleleft/\blacktriangleright$ for about 0.5 seconds.

When the band is FM

Auto tuning starts. The frequency changes in 50 kHz steps.

When a broadcast is received, scanning stops and the frequency flashes in the display.

Appears when a broadcast is received.

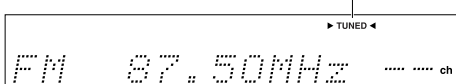

Tuning in a weak frequency (only for FM stations)

When you tune in a stereo FM station, the FM STEREO indicator lights up if the signal is sufficiently strong.



If the signal is weak, you may not be able to tune to the station. In this case, press FM MODE. The FM STEREO indicator goes off.

Then select the station to which you want to listen.

(At this time, the station will be in mono and interstation noise will be heard.)



Receiving RDS (European models only)

When an Radio Data System (RDS) station broadcasting Program Service Name (PS) information is received, the RDS indicator lights up and the name of the station is displayed.

RDS reception is only available on the European models, and only in areas where RDS broadcasts are available.



Listening to the radio

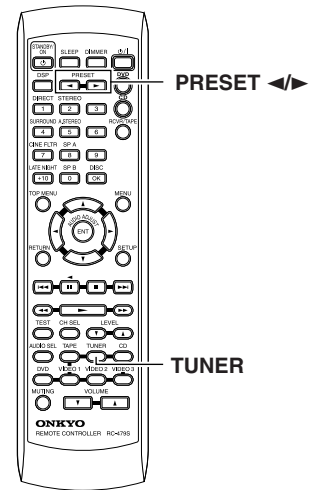
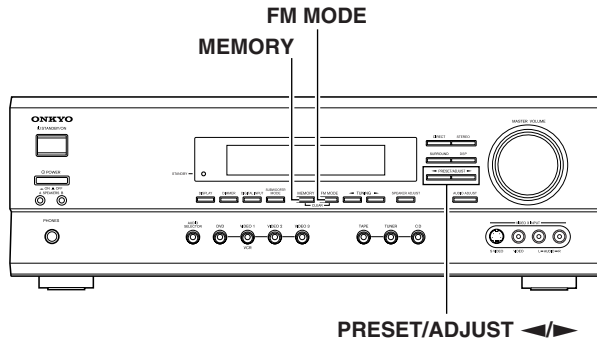

Presetting radio stations

You can preset up to 30 stations.

1. Tune in the radio station you wish to preset (refer to the previous page).
2. Press MEMORY.

The MEMORY indicator lights and the preset number starts flashing in the display.

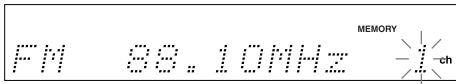

3. While the MEMORY indicator is lit (for about 8 seconds), press PRESET/ADJUST ◀▶ to select the preset number.

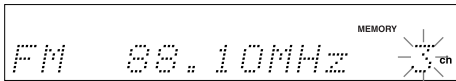

4. Press MEMORY.

The radio station is registered to the preset channel. To register another preset station, repeat steps 1 to 4.

Selecting preset stations

Before selecting preset stations, you need to preset the radio stations. See "Presetting radio stations" on the left column of this page.

1. Press TUNER to switch the input source to the tuner.

"FM" or "AM" appears in the display.

The band selected in this step will not affect the next step.

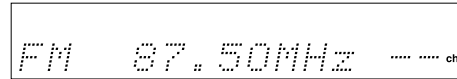

2. Press PRESET ◀▶ on the remote controller or PRESET/ADJUST ◀▶ on the unit repeatedly to select the preset number of the desired radio station.

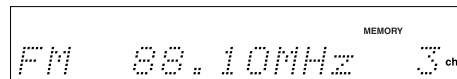

Erasing a preset station

1. Select the preset channel you wish to erase (see steps in the previous page).

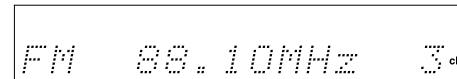

2. Press FM MODE while holding down MEMORY.

The selected preset channel will be erased.

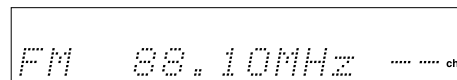

Various functions while listening to radio programs

To use the following functions, see pages 26 and 27.

- Turning on/off the SPEAKERS A/SPEAKERS B systems
- Muting the sound
- Listening through headphones
- Changing the display
- Controlling the brightness of the lights on the AV Receiver
- Using the sleep timer

Enjoying the surround modes while listening to radio programs

See page 30.

Various functions common to all the sources

SPEAKERS A/B

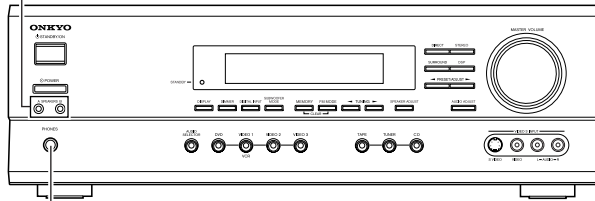

PHONES jack

SP A/SP B

MUTING

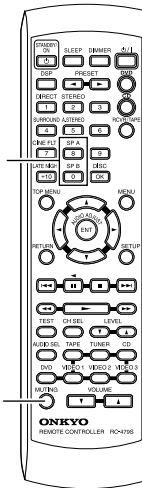

Turning on/off the SPEAKERS A/SPEAKERS B systems

You can turn on or off the speaker systems connected to the FRONT SPEAKERS A and FRONT SPEAKERS B connectors individually.

Press SPEAKER A on the unit or SP A on the remote controller to turn on or off the SPEAKERS A system.

Press SPEAKER B on the unit or SP B on the remote controller to turn on or off the SPEAKERS B system.

Note

If you turn on the SPEAKERS B system, the SPEAKERS A system also reproduces stereo sound automatically. (The listening mode is set to "Stereo.")

The lit (speaker) A/B indicators indicate the corresponding speaker systems are on.



Muting the sound (remote controller only)

Press MUTING.

The MUTING indicator flashes in the display during the muting mode.

MUTING

To restore the sound, press MUTING again.

Tip

If you turn off the unit during muting, and turn it on again, the sound will be restored.

Listening through headphones

Connect the plug of the stereo headphones to the PHONES jack on the AV Receiver.

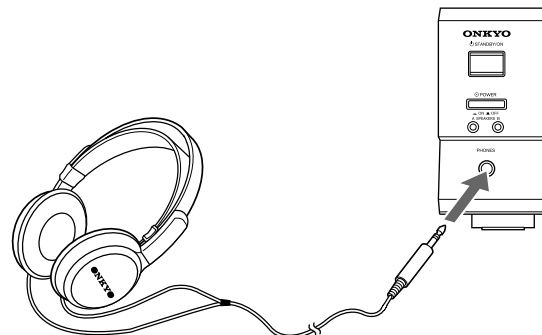

Notes

- The speakers will not reproduce sound while headphones are connected.
- When a listening mode other than "Direct" is selected, the listening mode is set to "Stereo" after connecting the headphones to the PHONES jack. When you disconnect the headphones, the listening mode returns to the previous mode.

Various functions common to all the sources

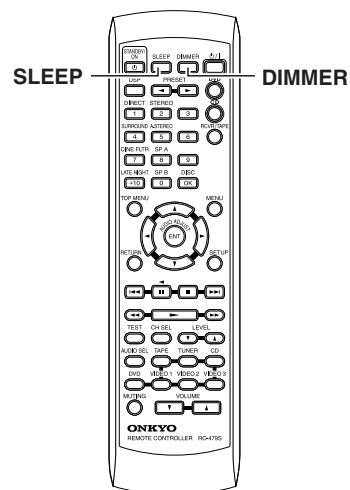
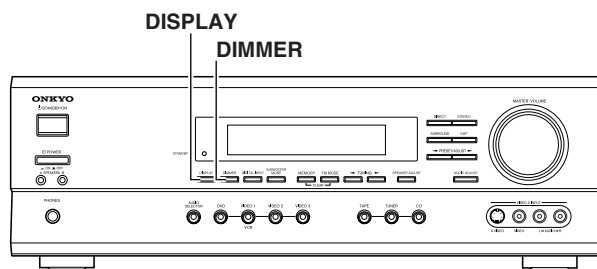

Changing the display

Press DISPLAY.

Each time you press DISPLAY, the screen changes as follows:

When an input source other than FM or AM is selected

Input source + volume *DVD 25*



Program format* *Dolby D 3/2.1*



Input source + Listening mode (or Multich) *DVD Dolby D*

Press DISPLAY once to initiate the program format display. Pressing the button again switches the display to the other display.

* If the input signal does not have a program format, then this will be skipped. The format display returns to the previous display after the format display has lasted for about three seconds (***>).

When FM or AM is selected as the input source

FM/AM frequency + Preset no. *FM 88.10MHz 1*



FM/AM + Listening mode *FM Stereo*

When an RDS station broadcasting PS information is settled as the input source (European models only)

Press DISPLAY once to initiate the frequency display. Pressing the button again switches the display to the other display.

Program Service Name + Preset no. *WDR-R2 1 ch*



FM frequency + Preset no.* *FM 88.10MHz 1 ch*



FM + Listening mode *FM Stereo*

* The frequency display returns to the previous display after the frequency display has lasted for about 5 seconds (***>).

Controlling the brightness of the lights on the AV Receiver

Press DIMMER.

Each press of the button changes the brightness as follows:

- The display becomes less bright.
- ↓
- The display is dimmed.
- ↓
- The display becomes bright.

Using the sleep timer (remote controller only)

Press SLEEP.

"Sleep 90 min" appears in the multipurpose display for about 5 seconds, which means the AV Receiver will turn off and enter standby mode in 90 minutes. Also the SLEEP indicator is lit in the display while the sleep timer is on.

SLEEP indicator

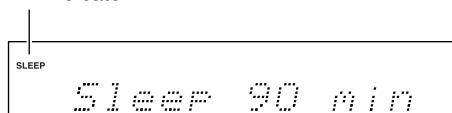

Each press of the button makes the remaining time shorter by 10 minutes.

Checking the remaining time

Press SLEEP while the sleep timer is On.

The remaining time is displayed.

If you press SLEEP while the remaining time is displayed, the remaining time is reduced by 10 minutes.

Canceling the sleep timer

Press SLEEP repeatedly until the SLEEP indicator goes off.

Various functions common to all the sources

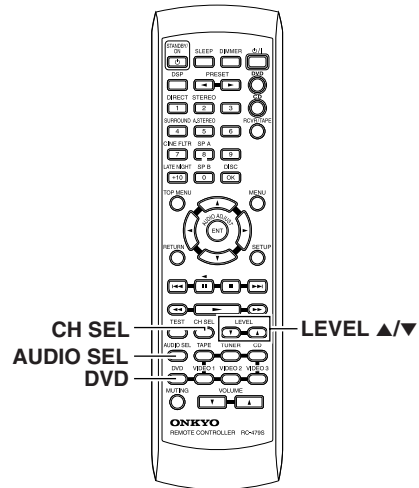
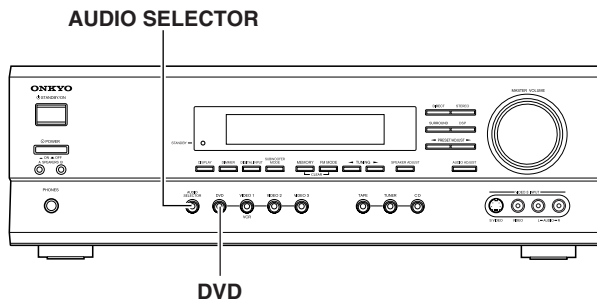

Adjusting each speaker's relative volume balance temporarily

You can readjust each speaker's relative volume balance according to your preference while listening to the sound.

The adjusted values will return to the values set on page 20 when the AV Receiver enters standby mode, or the main power is switched off unless you save the values.

Note

You cannot adjust the volume balance while the muting function is activated.

1. While playing the source, press CH SEL repeatedly to check each speaker's relative volume balance.

Each press of the button changes the speaker and the selected speaker appears in the display in the following order:

LEFT (Front left) → CENTER (Center) → RIGHT (Front right) → SURR RIGHT (Surround right) → SURR LEFT (Surround left) → SUBWOOFER (Subwoofer) → Speaker volume adjustment mode off



Note

Any speaker that is not included in the speaker configuration on page 20 is not selected even if it is actually connected.

2. Press CH SEL repeatedly to select the speaker, then press LEVEL ▲/▼ to adjust the volume level.

The volume level can be adjusted between -12dB and +12dB. Repeat this step to change another speaker's volume balance.

When TEST is pressed after the above adjustment, the set levels will become the levels adjusted using the test tone by overwriting the existing ones.

Setting the input signal format

If the input source is DVD, CD, VIDEO 1, VIDEO 2, VIDEO 3 or TAPE, you can specify the input signal format.

With the initial setting, "Auto" is assigned to the DVD, CD and TAPE inputs, and "Analog" is assigned to the VIDEO 1, 2 and 3 inputs. You can change this according to the signal format of the input source.

For example, follow the steps below to specify the input signal format for the DVD input

1. Press DVD.

DVD is selected as the input source and "DVD" appears in the display.

2. Press AUDIO SELECTOR on the unit or AUDIO SEL on the remote controller.

The current setting is displayed for three seconds.

While the current setting is displayed, press AUDIO SELECTOR or AUDIO SEL repeatedly until the desired input signal format is displayed.

Each press of the button switches the displayed input format as follows:

Auto (*) → Multich** → Analog → Auto (back to the beginning)

* The name of the input terminals (OPT1, OPT2, COAX, etc.) is shown inside ().

"Auto" will be skipped when digital input jack is not assigned to the input source.

** "Multich" can be selected only when DVD is selected as the input source.

Auto: Setting to play a digital signal in priority. When a digital signal is not input, the analog signal will be played. If there is a problem as described below, it is possible to fix the digital signal to PCM or DTS.

- If the beginning of each PCM track is cut in Auto mode → Fix the digital signal to PCM. However, care is required in using this mode for playback of a DTS-CD may be interfered by noise.
- If, during playback of a DTS-CD in Auto mode, noise is output when the CD is fast-forwarded or reversed → Fix the digital signal to DTS.

To fix the digital signal to DTS or PCM

- 1) Press AUDIO SELECTOR on the main unit (or AUDIO SEL on the remote controller) to select "Auto".
- 2) While "Auto" is displayed, press ADJUST ◀/▶. Each press of the button switches the display between Auto ↔ PCM ↔ DTS ↔ Auto.

When the digital signal is fixed at DTS or PCM, the digital signal is reproduced only when the selected type of signal is input. Digital signals of other types are not reproduced. In this case, only the indicator of the non-reproduced source (PCM or DTS) will blink.

Multich: Setting to play back the input from the component connected to the DVD port.

Analog: Setting to play the analog signal. Even when a digital signal is input, it will not be reproduced.

Note

When a digital input setting is changed while an input signal format other than "Multich" is set, the digital input becomes automatically Analog if it has been "-- --" or "Auto" if it has been "OPT 1", "OPT 2" or "COAX".

Various functions common to all the sources

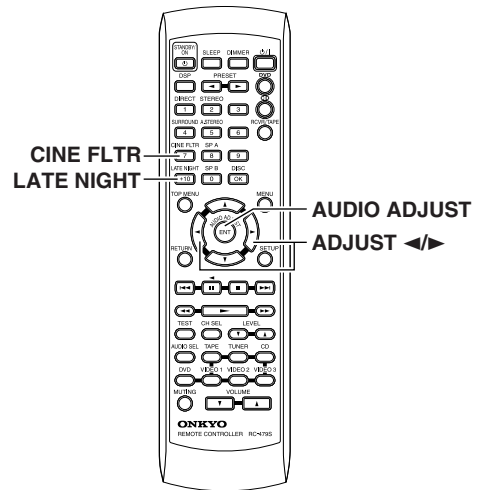
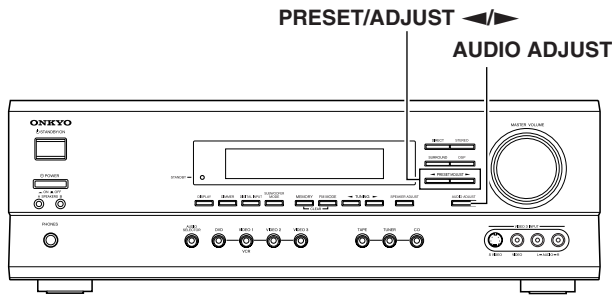

Using the AUDIO ADJUST function

The AUDIO ADJUST function adjusts the following items.

- Audio quality (Bass/Treble)
- Late Night On/Off
- Cinema Filter On/Off

Note

The adjustment is not available when the listening mode is "Direct" or Multich setting is "Tone Off" (see page 23).

1. Press AUDIO ADJUST (repeatedly) until the item to be adjusted is displayed.

Each press switches the displayed item in order of Bass → Treble → LateNight → Cine Fltr.

The items that can be selected are variable depending on the current source and listening mode.



Item

2. Press PRESET/ADJUST ◀▶ on the unit or ADJUST ◀▶ on the remote controller to adjust the item.

Refer to the right column for AUDIO ADJUST items and settings.



Value or setting

Note

Cinema Filter and Late Night can also be adjusted from the remote control.

Press the CINE FLTR or LATE NIGHT button to display the current setting (On or Off). To change the current setting, press the same button again.

Remote controller



Remote controller



Bass adjustment

The level of low frequencies from the front speakers can be adjusted in 2 dB steps in the range between -12 dB and +12 dB.

Treble adjustment

The level of high frequencies from the front speakers can be adjusted in 2 dB steps in the range between -12 dB and +12 dB.

Late night function

The late night function operates when the sound is Dolby Digital surround.

Cinema sound has a vast dynamic range; therefore, to hear the quieter sounds such as human conversations, they must be played back at larger volumes. When this function is set to on, the dynamic range of the sound is narrowed down to allow you to easily hear minute sounds at low volumes. This function is especially useful if you wish to play a movie at low volumes during the nighttime.

Late Night = On: Activate late night function

Late Night = Off: De-activate late night function

Notes

- The late night effect is determined by each Dolby Digital sound source. Some sources may produce little or no effect.
- If you turn off the unit and turn it on again, the late night function is set to "Late Night = Off".

Cinema filter function

Cinema filter takes the edginess or "brightness" out of your home cinema sound to compensate for the fact that sound mixed for theaters may sound too bright when played back through speakers in the home environment.

This parameter is enabled for PL II Movie, Dolby Digital or DTS listening mode.

Cine Fltr = On: Activate cinema filter function

Cine Fltr = Off: De-activate cinema filter function

Enjoying the listening modes

The surround sound of the AV Receiver enables you to enjoy the presence of a movie theater or concert hall in your room.

Before using any surround mode, make sure the Speaker Setup configurations have been set (see page 18).

The speaker configuration is very important for the surround sound. See "Positioning speakers/Connecting speakers" on page 13. For operational instructions, refer to the page 32.

Following are the sound systems the AV Receiver can reproduce.

Dolby Digital surround, DTS (Digital Theater System) surround

This 5.1-channel digital surround format enables you to individually record and play five full-range (20 Hz-20 kHz) channels (left and right front, center, two surround channels) plus an LFE channel (Low Frequency Effect) for the low-range effect sound. It will create a realistic sound that could be heard in the theaters and concert halls.

Dolby Digital

Select this option when you play a DVD video that has a  mark.

DTS

Select this option when you play a DVD player, LD, or CD that has a  mark.

- If you press the pause or skip button on the player while playing a DTS source, a short noise may be heard. This is not a malfunction.
- The DTS indicator on the TX-SR500/TX-SR500E lights up while it plays the DTS source. When playback concludes and the DTS signal transmission stops, the TX-SR500/TX-SR500E remains in DTS mode and the DTS indicator remains lit. This prevents noise when you operate the pause or skip button on the player. Therefore, if the source switches from the DTS signal to the PCM signal immediately, the PCM signal may not be played. In this case, stop the playback of the source on the player for about 3 seconds, then resume playback.
- Some CD players and LD players may be unable to play DTS sources correctly even if you connect the player to the TX-SR500/TX-SR500E digitally. This is because the digital signal has been processed (such as the output level, sampling frequency, frequency response, etc.), and the TX-SR500/TX-SR500E cannot recognize the signal as DTS data. Therefore, you may hear noise when you play a DTS source while processing the signal.
- The TAPE OUT or VIDEO 1 OUT jacks of the TX-SR500/TX-SR500E output analog audio. Do not record CDs or LDs that support DTS using these jacks. Otherwise, you will record a DTS encoded signal as noise.

Dolby Pro Logic II surround

This mode is a new generation 5-channel surround system that provides performance between the 4-channel (left front, right front, center, and monaural surround) Pro Logic Surround and the 5.1-channel Dolby Digital Surround. This mode can be set to the Movie mode designed for playing movies and the Music mode designed for listening to music.

In the Movie mode, the surround channels, which used to provide monaural output over only a narrow frequency range, now provide complete stereo output over the full frequency range. The result is viewing with a realistic feel of movement.

The Music mode uses the surround channels to provide a natural sound space that cannot be provided with normal stereo output.

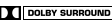
This mode can be used with VHS and DVD videos with the  mark and certain television programs. The Music mode can be used with music compact discs and other stereo sources.

If no surround speakers are connected, then the surround sound is divided and output from the front left and right channels.

Onkyo's original Digital Signal Processing (DSP) modes

Analog sources include the audio records, AM/FM broadcasting and cassette tapes. The PCM (Pulse Code Modulation) signal is a kind of digital audio signal, which is recorded directly on CD or DVD without being compressed. When an analog or PCM source is played, you can enjoy unique surround modes to Onkyo as listed below.

Orchestra

This mode is suitable for classical and opera music. The center channel is cut and the surround channels are emphasized to widen the stereo image. It simulates a natural reverberation as created in a large hall.

Unplugged

This mode is suitable for acoustic instrumental sounds, vocals, and jazz music. By emphasizing the front stereo image, it simulates the acoustics in front of the stage.

Studio-Mix

This mode is suitable for rock and popular music. Lively sounds with a powerful acoustic image will make you feel as if you are in a club.

TV Logic

This mode offers the realistic acoustics of a TV program being aired in the TV studio. It enhances the entire surround sound and clarity of conversation.

All Ch St (All Channel Stereo)

This mode is useful for background music. The front and surround channels will create a stereo image.

Stereo mode, Direct mode

Stereo

This mode has all input sound is output from the left and right front speakers. Subwoofer also can be used for playback.

Direct

This mode delivers pure sound with minimum sound quality adjustment and filtration. The sound recorded for the left and right front channel is output to the left and right front speakers only and not output to the subwoofer.

Enjoying the listening modes

The input sources and available listening mode

The listening modes that can be selected are variable depending on the signal formats employed with the input sources.

Notes

- Only “Stereo” (“Stereo” or “Direct” for PCM/Analog source) can be selected when the speaker configuration is set to “Speaker 2ch”, when headphones are used, or when speakers B is selected.
- The listening mode cannot be selected when “Multich” is selected.
- You can select “Orchestra”, “Unplugged”, “Studio-Mix” and “TV Logic” only when the speaker configuration is set to “Speaker 4ch” or “Speaker 5ch”.
- If you select “Orchestra”, no sound is reproduced from the center speaker even when the speaker configuration is set to “Speaker 5ch”.

Input source signal format	Analog	PCM* ¹	Dolby Digital		DTS
Source software Listening mode	Tape, FM/AM Video cassette tape	CD, Video CD, DVD Video, DVD Audio	DVD video, LD* ²		CD DVD Video, LD* ²
			Multi channel	Stereo	
Direct	●	●			
Stereo	●	●	●	●	●
PL II Movie	●	●		●	
PL II Music	●	●		●	
Dolby D			●		
DTS					●
Orchestra	●	●			
Unplugged	●	●			
Studio-Mix	●	●			
TV Logic	●	●			
All Ch St	●	●			

*¹ Only Stereo or Direct can be selected when the PCM source has been recorded with a sampling rate 96 kHz.

*² If you have an LD player with AC-RF output, connect it via a AC-RF demodulator to one of the TX-SR500/TX-SR500E's DIGITAL INPUT terminals.

Enjoying the listening modes

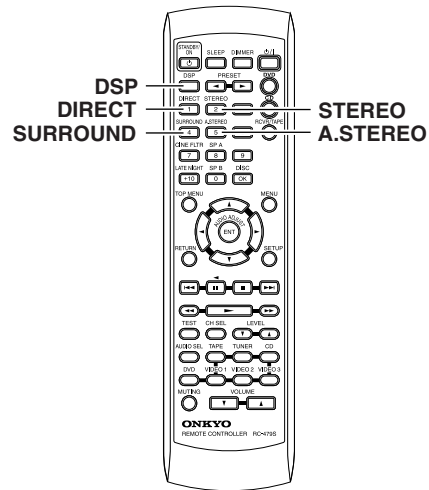
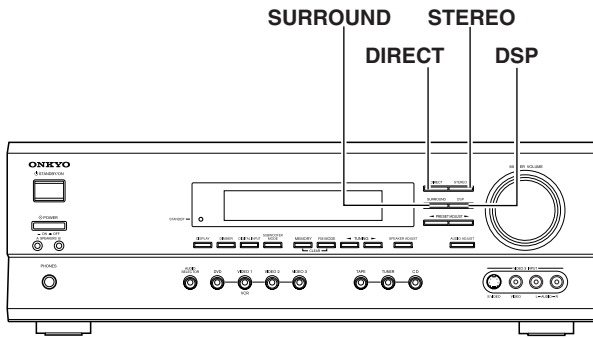

Selecting the listening mode

See "Relationship between input sources and listening modes" on page 31.

Press one of the listening mode buttons to select the listening mode.

DIRECT: Set the listening mode to "Direct".

STEREO: Set the listening mode to "Stereo".

SURROUND: Set the listening mode to "PLII" (when the sound is analog, PCM or Dolby Digital stereo source), "Dolby D" (when the sound is Dolby Digital) or "DTS" (when the sound is DTS).

A.STEREO: Set the listening mode to "All Ch St".

DSP: The listening modes that can be selected are different between the main unit and remote control unit.

DSP (on the front panel): Recall the Onkyo-original DSP mode. Each time this button is pressed, the listening mode cycles; "Orchestra" → "Unplugged" → "Studio Mix" → "TV Logic" → "All Ch St" → "Orchestra" (back to the beginning).

DSP (on the remote controller): All of the listening modes that can be selected for the current source can be selected in sequence. This button is valid also when the remote control mode is other than RCVR/TAPE (see pages 34 and 35).

Various functions while playing surround sound

When the sound is Dolby Digital

To narrow the dynamic range of the sound, see "Late night function" on page 29.

When the sound is Pro Logic II Movie, Dolby Digital or DTS

When the sound is too bright, use "Cinema filter function" on page 29.

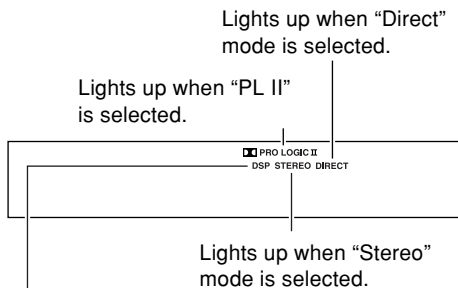

Lights up when Onkyo-original DSP mode ("Orchestra", "Unplugged", "Studio-Mix", "TV Logic" or "All Ch St") is selected.

Recording a source

To record the input source signal you are currently watching or listening to

Recording of video and/or audio signals can be performed on the components connected to the VIDEO 1 OUT and TAPE OUT (audio only) jacks.

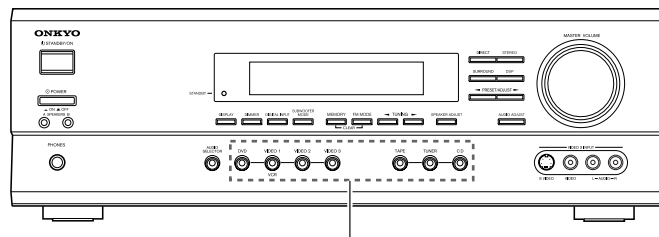

Input selector buttons

1. Press an input selector button to select the input source to record.

The input source is now selected and you may watch or listen to it as desired. The currently selected input source signal to the VIDEO 1 OUT and TAPE OUT outputs for recording.

2. Start recording at the recording component as desired.

Notes

- You can record analog audio, but not digital audio. Make sure that you have made a correct analog connection.
- If you change the input source during recording, you will record the signals from the newly selected input source.
- You cannot record the surround effects.

Recording the video from one source and the audio from another

You can add the sound from one source to the video of another source to make your own video recordings.

Below is an example of recording the sound from a CD player connected to CD L/R jacks and the video from a video camera connected to VIDEO 3 INPUT VIDEO jack to video cassette tape in a video cassette recorder connected to the VIDEO 1 OUT L/R and VIDEO jacks.

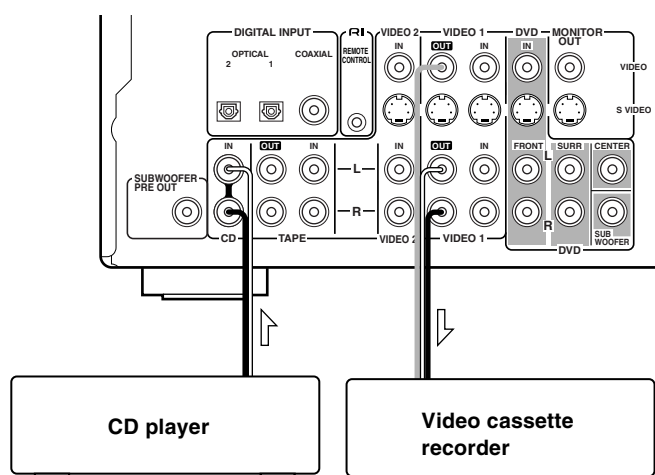
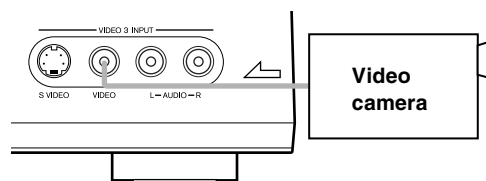

1. Insert a CD in the CD player and insert a tape in the video camera connected to the VIDEO 3 INPUT.

2. Insert a video tape for recording in the video cassette recorder connected to VIDEO 1 OUT.

3. Press VIDEO 3.

4. Press CD.

This switches the audio output to CD, but the video output remains VIDEO 3 that has been selected in step 3.

5. Start recording on the video cassette recorder and start playing at the CD player and video camera as desired.

The recorded video signal becomes the output from the video camera and recorded audio signal becomes that from the CD player.

Notes

- You can record analog audio, but not digital audio. Make sure that you have made a correct analog connection.
- If you change the input source during recording, you will record the audio signals from the newly selected input source and the video signals assigned to that input source.
- You cannot record the surround effects.

Using remote controller

You can operate the **RI**-connected Onkyo DVD player, CD player or cassette tape deck with the remote controller provided with the TX-SR500/TX-SR500E. The graied buttons in the illustration operates the TX-SR500/TX-SR500E in any mode. The RC-478M remote controller is for USA and Canadian models, and the RC-479S remote controller is for other models.

Controlling an Onkyo DVD player

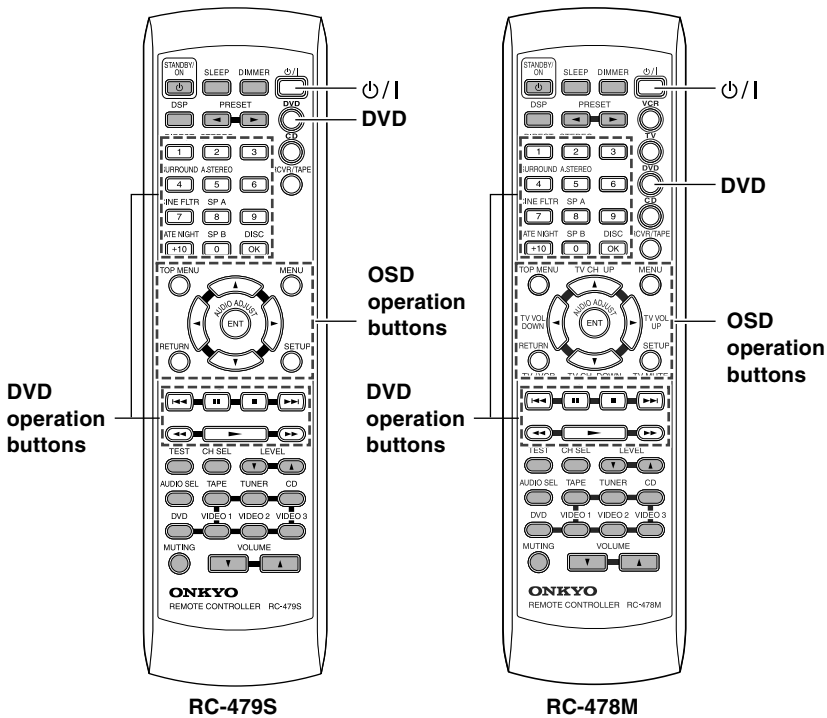

The **RI** connector of the Onkyo DVD player must be connected to the TX-SR500/TX-SR500E (refer to page 16).

1. Press DVD.
2. Press **Power/I** to turn on the Onkyo DVD player.
3. Press the desired operation button.

DVD operation buttons

- ▶ : Starts playback of DVD.
- : Stops playback.
- ▶▶ : Searches the disc in the forward direction.
- ◀◀ : Searches the disc in the reverse direction.
- ◀|| : Lets playback pause temporarily or advances the disc frame by frame.
- ▶▶| : Starts playback from the beginning of the next chapter/track.
- |◀◀ : Starts playback from the beginning of the current chapter/track.

DISC : This button is valid when the DVD changer is used and selects the disc to be played.

1-9, +10, 0 : Use to enter numeric values.

OSD operation buttons

- TOP MENU : Displays the top menu of each DVD disc.
- MENU : Displays a menu recorded in the DVD disc.
- RETURN : Returns to the previous menu.
- SETUP : Displays the setup menu.
- ▲/▼/◀/▶ : Selects an item in a menu.
- ENT : Enters the selection in memory.

Using remote controller

Controlling an Onkyo CD player

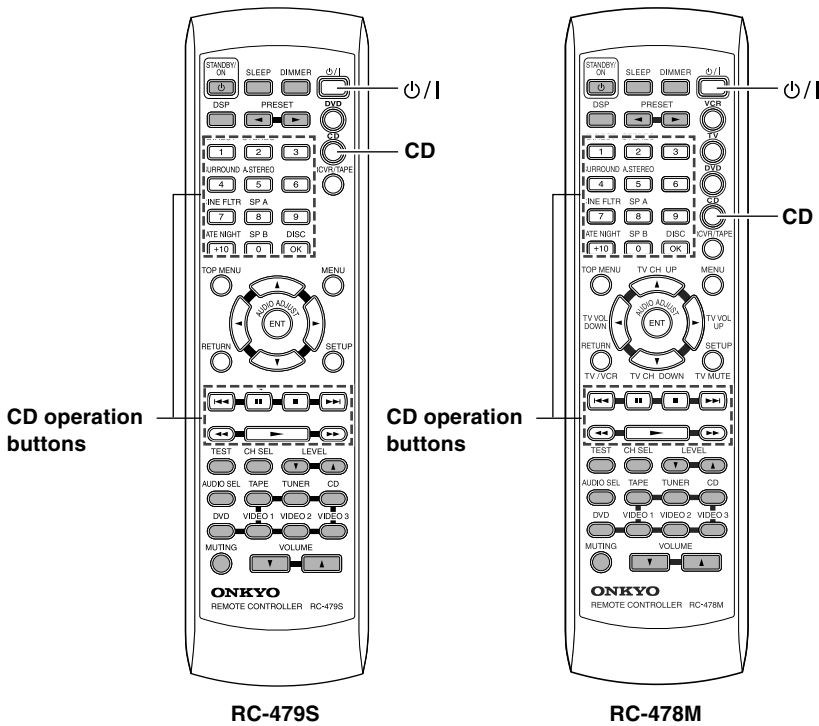

The **RI** connector of the Onkyo compact disc player must be connected to the TX-SR500/TX-SR500E (refer to page 16).

1. Press **CD**.
2. Press **⏻/I** to turn on the Onkyo compact disc player.
3. Press the desired operation button.

- ▶ : Starts playback of CD.
- : Stops playback, fast forward or fast reverse.
- ▶▶ : Fast forwards the CD.
- ◀◀ : Fast reverses the CD.
- ◀|| : Lets playback pause temporarily.
- ▶▶▶ : Skips to the beginning of the next track.
- ◀◀◀ : Skips to the beginning of the current or previous track.
- DISC : This button is valid when the CD changer is used and selects the disc to be played.

1-9, +10, 0 : Use to enter numeric values.

Controlling an Onkyo cassette tape deck

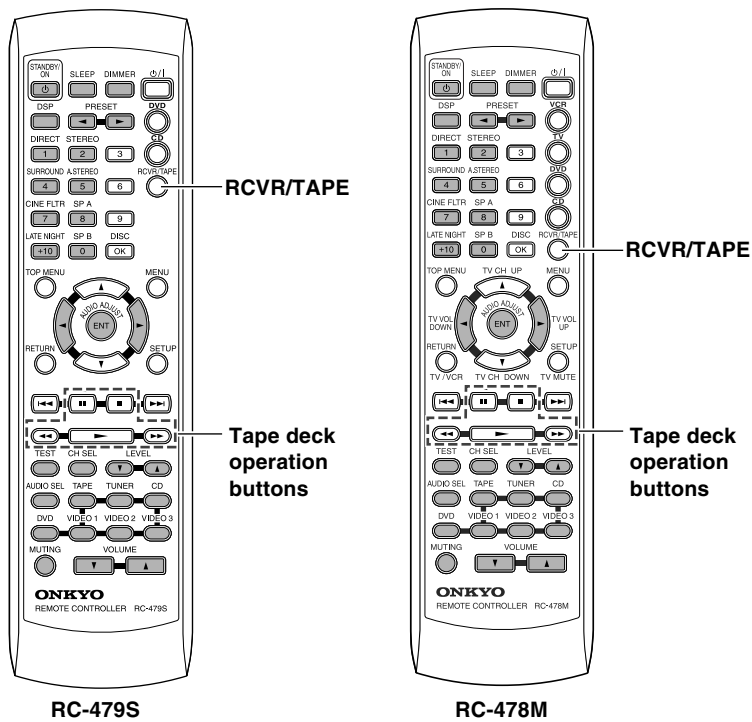

The **RI** connector of the Onkyo cassette tape deck must be connected to the TX-SR500/TX-SR500E (refer to page 16).

1. Press **RCVR/TAPE**.
2. Press the desired operation button.

- ▶ : Plays side A (the side facing the front) of tape.
- : Stops playback, recording, fast forward or rewinding.
- ▶▶ : Fast forwards the tape.
- ◀◀ : Rewinds the tape.
- ◀|| : Plays side B (the side facing the rear) of the tape.

Pre-programming remote controller (North American models only)

You can make RC-478M remote controller to operate a product from other brand than Onkyo by storing the pre-programming code of the brand in the RC-478M.

Brand	TV	VCR	DVD
AIWA		137	
AKAI	227		
DENON			302, 309
EMERSON	228		
FISHER	200	100, 101, 102, 140	
GE		103, 104	
GE • PANA	201, 202		
GE • RCA	203		
GO VIDEO		105, 106, 107	
GOLD STAR	204, 205	108	
HITACHI	206, 207	103, 109	303
JVC	208	110, 111, 112, 113	304
KENWOOD			305
MAGNAVOX	209, 210	114, 115, 116	306, 313
MARANTZ	211		307
mitsubishi		117, 118, 119, 120, 121, 139	308, 313

Brand	TV	VCR	DVD
NEC		136	
ONKYO			300, 301, 313
PANASONIC	212, 213	122, 123	309
PHILIPS	214	114	
PIONEER	215		310
PROSCAN	216		311
RCA	217, 218, 219, 220, 229, 230	109	311
SAMSUNG	221, 222	124, 125, 126	
SHARP	223	127, 128	
SHINTOM		138	
SONY	224	129, 130, 131, 132, 133, 141, 142	312
TOSHIBA		134	313
YAMAHA			309, 314
ZENITH	225, 226	135	313, 315

Learning a pre-programming code

- Find the 3-digit number for the brand name of the component that you want to operate in the table on this page.
- Turn on the component that you want to operate (i.e. DVD, VCR, or television).
- While holding down VCR, TV or DVD on the RC-478M that you want to program, press ENT, and then release both buttons.
- Within 10 seconds, enter the 3-digit code number.
To enable entry of the 3-digit code number, some of the remote controller keys become the numeric keys with the assignment as shown in the figure.
- Press some operation buttons for the component that you want to operate to check if the system operates properly.

If the system operates properly, the code is correct. If the component does not operate properly, return to step 3.

Notes

- With some brand's components, some buttons may not work correctly.
- If more than one code is given in the table, try the code one by one until you reach the code for your component (i.e. if the first code does not work, then try the next).

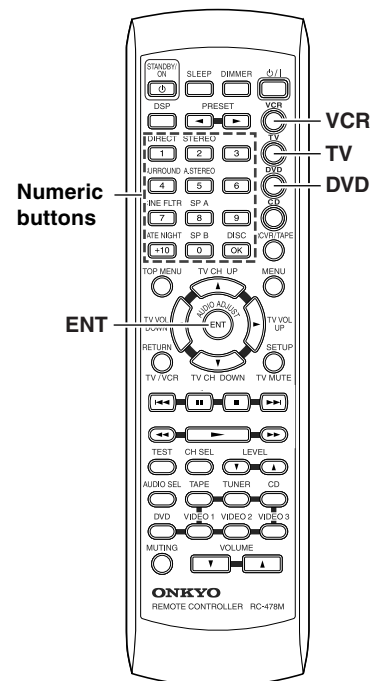

Pre-programming remote controller (North American models only)

Controlling a TV

1. Press TV mode.
2. Press ϕ/I to turn on the TV.
3. Press the desired operation button.

- 1-9, +10, 0 : Use to enter numeric values.
 OK : Confirm
 TV CH UP \blacktriangle : Changes the TV channel upward.
 TV CH DOWN \blacktriangledown : Changes the TV channel downward.
 TV VOL UP \blacktriangleright : Increases the TV volume.
 TV VOL DOWN \blacktriangleleft : Decrease the TV volume.
 TV/VCR : Switches the TV/VCR inputs.
 TV MUTE : Mutes the sound
- The graied buttons in the illustration operates the TX-SR500/ TX-SR500E in any mode.

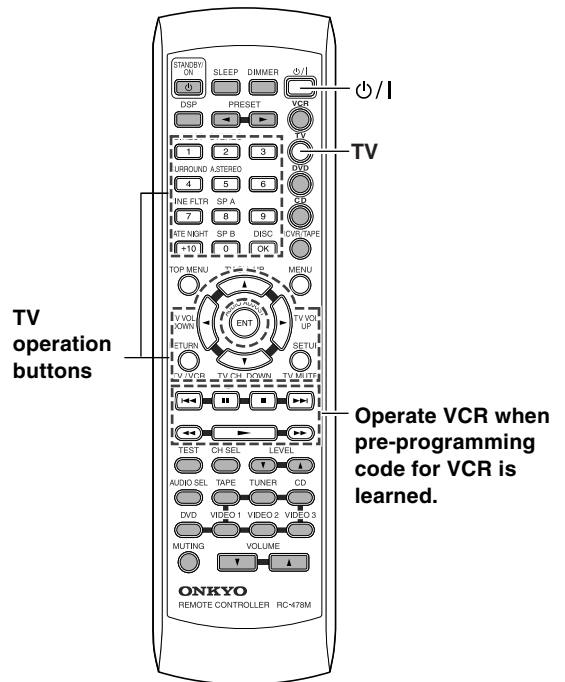

Controlling a VCR

1. Press VCR mode.
2. Press ϕ/I to turn on the VCR.
3. Press the desired operation button.

- 1-9, +10, 0 : Use to enter numeric values.
 TV CH UP \blacktriangle : Changes the received channel upward.
 TV CH DOWN \blacktriangledown : Changes the received channel downward.
- \blacktriangleright : Starts playback of videotape.
 \blacksquare : Stops playback, recording, fast forward or rewinding.
 $\blacktriangleright\blacktriangleright$: Fast-forwards the videotape.
 $\blacktriangleleft\blacktriangleleft$: Rewinds the videotape.
 \blacktriangleleft : Changes the VCR channel downward.
 \blacktriangleright : Changes the VCR channel upward.
 $\blacktriangleleft\parallel$: Lets playback pause temporarily.
- The graied buttons in the illustration operates the TX-SR500/ TX-SR500E in any mode.

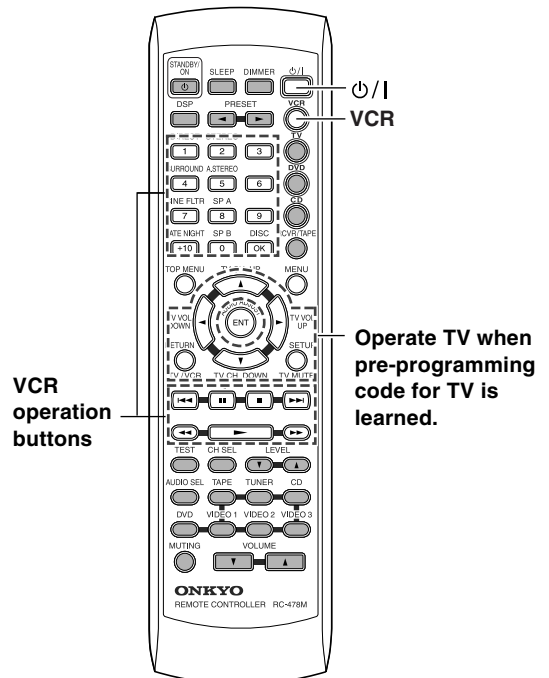

Controlling a DVD player

Buttons with programmed usage and operations are the same as the operational buttons on page 35.

When entering the code of Onkyo DVD players

There are two SETTING numbers. Choose the SETTING number according to how you will be using the DVD player.

No. 601: This code is for operating the Onkyo DVD player by pointing the remote controller directly at it, either because it does not have an **RI** connector, or it does but you are not using an **RI** cable and connecting it.

No. 600: This code is for Onkyo DVD players that have an **RI** connector that you are connecting to the TX-SR500/TX-SR500E with an **RI** cable. You will then operate the DVD player by pointing the remote controller at the remote control sensor on the TX-SR500/TX-SR500E. You do not need to enter this code because it is factory preset. However, if the code has been changed to 601, then you will need to change it back to 600.

Troubleshooting

Check the following guide for the possible cause of a problem before contacting service. Refer also to the respective instruction manuals of the connected components and TV.

	Symptoms	Causes	Remedies	Pages
Amplifier	The AV receiver doesn't switch on.	<ul style="list-style-type: none"> The power cord (mains lead) is disconnected. The main power is set to OFF. There is external noise interfering with the computer circuits of the AV receiver. 	<ul style="list-style-type: none"> Check the connection of the power cord (mains lead). Turn on the main power. Switch off the main power, then switch it on again. If not recovered, disconnect the power cord (mains lead), then connect it again. 	17 17 17
	Power shuts off immediately after power on.	<ul style="list-style-type: none"> Amplifier protection circuitry has been activated. 	<ul style="list-style-type: none"> Contact your Onkyo Service Center. 	–
	The buttons on the remote controller and AV receiver do not operate.	<ul style="list-style-type: none"> Power supply fluctuations or other abnormalities such as static electricity may interrupt correct operation. 	<ul style="list-style-type: none"> Switch off the main power, then switch it on again. If not recovered, disconnect the power cord (mains lead), then connect it again. 	–
	No sound is reproduced.	<ul style="list-style-type: none"> The muting function is activated. The AV receiver is not properly connected. Input selector is not set properly. Headphones are connected. The input signal format is set to "PCM". 	<ul style="list-style-type: none"> Deactivate the muting function. Check the connections to the AV receiver. Set to correct input source. Decrease the volume, then disconnect the headphones. Set the input signal format to "Auto". 	26 10, 11 21, 24 26 –
	No sound or very little sound is reproduced from the center speaker.	<ul style="list-style-type: none"> The speakers are not properly connected. The listening mode is set to "Stereo" or "Orchestra". The volume level of the center speaker ("Center") is set to minimum. A speaker configuration without the center speaker is selected. 	<ul style="list-style-type: none"> Check the speaker connections. No sound is reproduced from the center speaker when the listening mode is "Stereo" or "Orchestra". Adjust the volume level of the center speaker. Check that the selected speaker configuration includes the center speaker. 	13 32 21, 28 18
	Hum, low-frequency noise.	<ul style="list-style-type: none"> The placement of the audio connection cables on the rear panel is incorrect. 	<ul style="list-style-type: none"> Adjust the placement of the cable to reduce hum. 	–
	Rough or scratchy sound. High range is not clear.	<ul style="list-style-type: none"> Treble control too high. 	<ul style="list-style-type: none"> Use AUDIO ADJUST function to cut the treble response. 	29
	No sound or very low volume from subwoofer.	<ul style="list-style-type: none"> Subwoofer mode is set to "Off". Subwoofer mode setting is improper. 	<ul style="list-style-type: none"> Check the subwoofer mode setting. Check the subwoofer mode setting. 	20 20
	No picture appears on the TV screen.	<ul style="list-style-type: none"> The TV is not set to receive the output signals from the AV receiver. The video cable is not connected securely. Only the S video connection is made. 	<ul style="list-style-type: none"> Set the TV to the AV receiver's input. Check the connections between the AV receiver and TV set. Also make video connection. Check the TV's video input and AV receiver's output signal. 	– 10 10, 11
	The sound of the playback source is not heard.	<ul style="list-style-type: none"> Another input source is selected. 	<ul style="list-style-type: none"> Select the appropriate input source. 	25
Remote controller	The buttons on the AV receiver operate but the buttons on the remote controller do not operate.	<ul style="list-style-type: none"> A wrong mode button is pressed. No batteries are inserted in the remote controller. The batteries are worn out. The remote controller is not pointed at the remote sensor of the AV receiver. The remote controller is too far from the AV receiver. 	<ul style="list-style-type: none"> Press the appropriate mode control button. Insert new batteries. Replace with new batteries. Point the remote controller at the remote sensor of the AV receiver. Operate the remote controller within 16 feet (5 m). 	34-37 5 5 5 5

Troubleshooting

	Symptoms	Causes	Remedies	Pages
Tuner	Too much noise is heard or sound is interrupted occasionally. (The FM STEREO indicator does not light steadily.)	<ul style="list-style-type: none"> FM stereo waves may produce a hiss noise when a certain level is reached. The position or direction of the FM antenna (aerial) is incorrect. The station is too weak. 	<ul style="list-style-type: none"> Switch the frequency receiving mode to mono. Adjust the position, height, and direction of the FM antenna (aerial). Connect an FM outdoor antenna (aerial). Try to use an antenna (aerial) with more elements. [For installation of the outdoor antenna (aerial), consult your nearest dealer as it requires special skills and experience.] 	24 14, 15 15
	Sound is distorted or sound volume decreases.	<ul style="list-style-type: none"> The radio wave is distorted. Cars are running or airplanes are flying near the house. 	— —	— —
	Sound is excessively distorted.	<ul style="list-style-type: none"> There is a tall building or a mountain nearby. [The waves transmitted from the transmission center (direct waves) and the waves reflected by buildings or mountains (diffraction waves) interfere with each other causing multi pass distortion.] 	—	—
	No preset channels are selected.	<ul style="list-style-type: none"> The power cord (mains lead) is unplugged, or the main power is switched off, for a long time. 	<ul style="list-style-type: none"> The preset data in memory is lost. Preset the radio stations again. 	25
Recording	Sound is reproduced from the speakers but not recorded.	<ul style="list-style-type: none"> The sound system you are trying to record is DTS surround. 	<ul style="list-style-type: none"> DTS surround sound is unable to be recorded. Make an analog connection. 	33 33
Other	LATE NIGHT function cannot be used.	<ul style="list-style-type: none"> Playback source is not Dolby Digital encoded. 	<ul style="list-style-type: none"> Check that the <input type="checkbox"/> DIGITAL indicator lights up in the display. 	21
	Multichannel audio is not output.	<ul style="list-style-type: none"> Input signal format is set to "Auto" or "Analog". The component is not connected to the DVD jacks 	<ul style="list-style-type: none"> Set the input signal format to "Multich". Check that the multichannel output jacks of the component is connected to the DVD FRONT L/R, SURROUND L/R, CENTER and SYBWOOFER jacks. 	28 11

When incorrect operation is observed

- The TX-SR500/TX-SR500E contains an internal microcomputer that performs high-level operations. However, on extremely rare occasions, noise or interference from an external source or static electricity may cause faulty operation. If this occurs, unplug the power cord from the wall outlet, wait five or more seconds, and then plug it back in. This should correct the situation.
- To reset the surround mode and other settings to the factory default settings, hold down the VIDEO 1 button with the TX-SR500/TX-SR500E turned on and then press the STANDBY/ON button. "Clear" appears in the front display and the TX-SR500/TX-SR500E enters the standby state.

Specifications

AMPLIFIER SECTION

Continuous Average Power output (FTC)	
All channels:	65 watts per channel min. RMS at 8 ohms, 2 channels driven from 20 Hz to 20 kHz with no more than 0.08% total harmonic distortion.
Continuous Power output (DIN)	85 watts × 5 at 6 ohms
Maximum Power output (EIAJ)	115 watts × 5 at 6 ohms
Dynamic power output:	160 watts × 2 at 3 ohms 125 watts × 2 at 4 ohms 85 watts × 2 at 8 ohms
Total Harmonic Distortion:	0.08% at rated power 0.08% at 1 watt output
IM Distortion:	0.08% at rated power 0.08% at 1 watt output
Damping Factor:	60 at 8 ohms
Input Sensitivity and Impedance	
DIGITAL INPUT (OPTICAL 1, 2):	0.5 V _{p-p} , 75 ohms
DIGITAL INPUT (COAXIAL):	0.5 V _{p-p} , 175 ohms
LINE (CD, VIDEO 1, 2, 3, TAPE):	200 mV, 50 kohms
Multichannel Input	
(DVD FRONT L/C/R, SURR L/R):	200 mV, 50 kohms
(SUBWOOFER):	36 mV, 50 kohms
Output Level and Impedance	
Rec out (TAPE, VIDEO 1):	200 mV, 470 ohms
Pre out (SUBWOOFER):	1 V, 470 ohms
Frequency Response:	10 Hz to 10 kHz, +1/-3 dB (Direct mode)
Tone Control	
Bass:	±12 dB at 50 Hz
Treble:	±12 dB at 20 kHz
Signal-to-Noise Ratio:	CD/TAPE: 100 dB (IHF-A, Direct mode)
Muting:	-50 dB

VIDEO SECTION

Input Sensitivity and Impedance	
VIDEO (DVD, VIDEO 1, 2, 3):	1 V _{p-p} , 75 ohms
S VIDEO (DVD, VIDEO 1, 2, 3):	1 V _{p-p} , 75 ohms (Y) 0.28 V _{p-p} , 75 ohms (C)
Output Level and Impedance	
VIDEO (VIDEO 1, 2, MONITOR):	1 V _{p-p} , 75 ohms
S VIDEO (VIDEO 1, 2, MONITOR):	1 V _{p-p} , 75 ohms (Y) 0.28 V _{p-p} , 75 ohms (C)

TUNER SECTION

FM	
Tuning Range:	87.5-108.0 MHz (50 kHz steps)
Usable Sensitivity	
Mono:	11.2 dBf, 1.0 μV (75 ohms, IHF) 11.2 dBf, 0.9 μV (75 ohms, DIN)
Stereo:	17.2 dBf, 2.0 μV (75 ohms, IHF) 17.2 dBf, 23 μV (75 ohms DIN)

50 dB Quieting Sensitivity	
Mono:	17.2 dBf, 2.0 μV (75 ohms)
Stereo:	37.2 dBf, 20.0 μV (75 ohms)
Capture Ratio:	2.0 dB
Image Rejection Ratio	
North American models:	40 dB
Other models:	85 dB
IF Rejection Ratio:	90 dB
Signal-to-Noise Ratio	
Mono:	76 dB, IHF
Stereo:	70 dB, IHF
Alternate Channel Attenuation:	55 dB, IHF, ±400 kHz
Selectivity:	50 dB (DIN)
AM Suppression Ratio:	50 dB
Total Harmonic Distortion	
Mono:	0.2%
Stereo:	0.3%
Frequency Response:	30 Hz-15 kHz, ±1.0 dB
Stereo Separation:	45 dB at 1 kHz 30 dB at 100 Hz-10 kHz

AM

Tuning Range	
North American models:	530-1,710 kHz (10 kHz steps)
European & Australian models:	522-1,611 kHz (9 kHz steps)
Worldwide models:	531-1,602 kHz (9 kHz steps), 530-1,710 kHz (10 kHz steps)
Usable Sensitivity:	30 μV
Image Rejection Ratio:	40 dB
IF Rejection Ratio:	40 dB
Signal-to-Noise Ratio:	40 dB
Total Harmonic Distortion:	0.7%

GENERAL

Power Supply and Power Consumption:	AC 120 V, 60 Hz 4.0 A AC 230-240 V, 50 Hz 320 W AC 220-230 V and 120 V switchable, 50/60 Hz 320 W
Dimensions (W × H × D):	17-1/8" × 5-7/8" × 14-13/16" 435 × 150 × 376 mm
Weight	
North American models:	18.7 lbs., 8.5 kg
Other models:	19.4 lbs., 8.8 kg

REMOTE CONTROL

Transmitter:	Infrared
Signal range:	Approx. 16 ft., 5 meters
Power supply:	Two "AA" batteries (1.5 V × 2)

Specifications and features are subject to change without notice.
Power supply and voltage vary depending on the area in which the unit is purchased.

ONKYO CORPORATION

Sales & Product Planning Div. : 2-1, Nisshin-cho, Neyagawa-shi, OSAKA 572-8540, JAPAN
Tel: 072-831-8111 Fax: 072-833-5222

ONKYO U.S.A. CORPORATION

18 Park Way, Upper Saddle River, N.J. 07458, U.S.A.
Tel: 201-785-2600 Fax: 201-785-2650 <http://www.onkyousa.com>

ONKYO EUROPE ELECTRONICS GmbH

Industriestrasse 20, 82110 Germering, GERMANY
Tel: 089-849-320 Fax: 089-849-3265 E-mail: info@onkyo.de

ONKYO CHINA LIMITED

Units 2102-2107, Metroplaza Tower I, 223 Hing Fong Road, Kwai Chung,
N.T., HONG KONG Tel: 852-2429-3118 Fax: 852-2428-9039



Free Manuals Download Website

<http://myh66.com>

<http://usermanuals.us>

<http://www.somanuals.com>

<http://www.4manuals.cc>

<http://www.manual-lib.com>

<http://www.404manual.com>

<http://www.luxmanual.com>

<http://aubethermostatmanual.com>

Golf course search by state

<http://golfingnear.com>

Email search by domain

<http://emailbydomain.com>

Auto manuals search

<http://auto.somanuals.com>

TV manuals search

<http://tv.somanuals.com>