

**ONKYO®**

**AV Receiver**

***TX-SR504***  
***TX-SR504E***  
***TX-SR8450***

**Instruction Manual**

Thank you for purchasing an Onkyo AV Receiver.  
Please read this manual thoroughly before making  
connections and plugging in the unit.  
Following the instructions in this manual will enable  
you to obtain optimum performance and listening  
enjoyment from your new AV Receiver.  
Please retain this manual for future reference.

**Contents**

**Introduction ..... 2**

**Connection ..... 16**

**Turning On & First Time Setup..... 32**

**Basic Operation**

Playing your AV components ..... 36  
Listening to the Radio ..... 38

**Enjoying the Listening Modes ..... 48**

**Advanced Operation ..... 54**

**Troubleshooting ..... 62**



## WARNING:

TO REDUCE THE RISK OF FIRE OR ELECTRIC SHOCK, DO NOT EXPOSE THIS APPARATUS TO RAIN OR MOISTURE.

## CAUTION:

TO REDUCE THE RISK OF ELECTRIC SHOCK, DO NOT REMOVE COVER (OR BACK). NO USER-SERVICEABLE PARTS INSIDE. REFER SERVICING TO QUALIFIED SERVICE PERSONNEL.



**WARNING**  
RISK OF ELECTRIC SHOCK  
DO NOT OPEN

**AVIS**  
RISQUE DE CHOC ELECTRIQUE  
NE PAS OUVRIR



The lightning flash with arrowhead symbol, within an equilateral triangle, is intended to alert the user to the presence of uninsulated "dangerous voltage" within the product's enclosure that may be of sufficient magnitude to constitute a risk of electric shock to persons.



The exclamation point within an equilateral triangle is intended to alert the user to the presence of important operating and maintenance (servicing) instructions in the literature accompanying the appliance.

## Important Safety Instructions

1. Read these instructions.
2. Keep these instructions.
3. Heed all warnings.
4. Follow all instructions.
5. Do not use this apparatus near water.
6. Clean only with dry cloth.
7. Do not block any ventilation openings. Install in accordance with the manufacturer's instructions.
8. Do not install near any heat sources such as radiators, heat registers, stoves, or other apparatus (including amplifiers) that produce heat.
9. Do not defeat the safety purpose of the polarized or grounding-type plug. A polarized plug has two blades with one wider than the other. A grounding type plug has two blades and a third grounding prong. The wide blade or the third prong are provided for your safety. If the provided plug does not fit into your outlet, consult an electrician for replacement of the obsolete outlet.
10. Protect the power cord from being walked on or pinched particularly at plugs, convenience receptacles, and the point where they exit from the apparatus.
11. Only use attachments/accessories specified by the manufacturer.
12. Use only with the cart, stand, tripod, bracket, or table specified by the manufacturer, or sold with the apparatus. When a cart is used, use caution when moving the cart/apparatus combination to avoid injury from tip-over.  
  
PORTABLE CART WARNING  
S3125A
13. Unplug this apparatus during lightning storms or when unused for long periods of time.
14. Refer all servicing to qualified service personnel. Servicing is required when the apparatus has been damaged in any way, such as power-supply cord or plug is damaged, liquid has been spilled or objects have fallen into the apparatus, the apparatus has been exposed to rain or moisture, does not operate normally, or has been dropped.
15. Damage Requiring Service  
Unplug the apparatus from the wall outlet and refer servicing to qualified service personnel under the following conditions:
  - A. When the power-supply cord or plug is damaged,
  - B. If liquid has been spilled, or objects have fallen into the apparatus,
  - C. If the apparatus has been exposed to rain or water,
  - D. If the apparatus does not operate normally by following the operating instructions. Adjust only those controls that are covered by the operating instructions as an improper adjustment of other controls may result in damage and will often require extensive work by a qualified technician to restore the apparatus to its normal operation,
  - E. If the apparatus has been dropped or damaged in any way, and
  - F. When the apparatus exhibits a distinct change in performance this indicates a need for service.
16. Object and Liquid Entry  
Never push objects of any kind into the apparatus through openings as they may touch dangerous voltage points or short-out parts that could result in a fire or electric shock.  
The apparatus shall not be exposed to dripping or splashing and no objects filled with liquids, such as vases shall be placed on the apparatus.  
Don't put candles or other burning objects on top of this unit.
17. Batteries  
Always consider the environmental issues and follow local regulations when disposing of batteries.
18. If you install the apparatus in a built-in installation, such as a bookcase or rack, ensure that there is adequate ventilation.  
Leave 20 cm (8") of free space at the top and sides and 10 cm (4") at the rear. The rear edge of the shelf or board above the apparatus shall be set 10 cm (4") away from the rear panel or wall, creating a flue-like gap for warm air to escape.

# Precautions

1. **Recording Copyright**—Unless it's for personal use only, recording copyrighted material is illegal without the permission of the copyright holder.
2. **AC Fuse**—The AC fuse inside the unit is not user-serviceable. If you cannot turn on the unit, contact your Onkyo dealer.
3. **Care**—Occasionally you should dust the unit all over with a soft cloth. For stubborn stains, use a soft cloth dampened with a weak solution of mild detergent and water. Dry the unit immediately afterwards with a clean cloth. Don't use abrasive cloths, thinners, alcohol, or other chemical solvents, because they may damage the finish or remove the panel lettering.
4. **Power**

## WARNING

BEFORE PLUGGING IN THE UNIT FOR THE FIRST TIME, READ THE FOLLOWING SECTION CAREFULLY.

AC outlet voltages vary from country to country. Make sure that the voltage in your area meets the voltage requirements printed on the unit's rear panel (e.g., AC 230–240 V, 50 Hz or AC 120 V, 60 Hz).

Some models have a voltage selector switch for compatibility with power systems around the world. Before you plug in such a model, make sure that the voltage selector is set to the correct voltage for your area. Before you plug in this model, make sure that the voltage selector is set to the correct voltage for your area. If it isn't, use a small screwdriver to set it as appropriate. For example, if the voltage in your area is 120 volts, set the selector to "120V." If it's between 220 and 240 volts, set it to "220-240V."

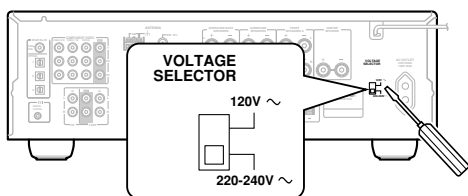

Pressing the [STANDBY/ON] button to select Standby mode does not fully shutdown the unit. If you do not intend to use the unit for an extended period, remove the power cord from the AC outlet.

5. **Never Touch this Unit with Wet Hands**—Never handle this unit or its power cord while your hands are wet or damp. If water or any other liquid gets inside this unit, have it checked by your Onkyo dealer.
6. **Handling Notes**
  - If you need to transport this unit, use the original packaging to pack it how it was when you originally bought it.
  - Do not leave rubber or plastic items on this unit for a long time, because they may leave marks on the case.

- This unit's top and rear panels may get warm after prolonged use. This is normal.
- If you do not use this unit for a long time, it may not work properly the next time you turn it on, so be sure to use it occasionally.

## For U.S. models

### FCC Information for User

#### CAUTION:

The user changes or modifications not expressly approved by the party responsible for compliance could void the user's authority to operate the equipment.

#### NOTE:

This equipment has been tested and found to comply with the limits for a Class B digital device, pursuant to Part 15 of the FCC Rules. These limits are designed to provide reasonable protection against harmful interference in a residential installation.

This equipment generates, uses and can radiate radio frequency energy and, if not installed and used in accordance with the instructions, may cause harmful interference to radio communications. However, there is no guarantee that interference will not occur in a particular installation. If this equipment does cause harmful interference to radio or television reception, which can be determined by turning the equipment off and on, the user is encouraged to try to correct the interference by one or more of the following measures:

- Reorient or relocate the receiving antenna.
- Increase the separation between the equipment and receiver.
- Connect the equipment into an outlet on a circuit different from that to which the receiver is connected.
- Consult the dealer or an experienced radio/TV technician for help.

## For Canadian Models

**NOTE:** THIS CLASS B DIGITAL APPARATUS COMPLIES WITH CANADIAN ICES-003.

For models having a power cord with a polarized plug:

**CAUTION:** TO PREVENT ELECTRIC SHOCK, MATCH WIDE BLADE OF PLUG TO WIDE SLOT, FULLY INSERT.

## Modèle pour les Canadien

**REMARQUE:** CET APPAREIL NUMÉRIQUE DE LA CLASSE B EST CONFORME À LA NORME NMB-003 DU CANADA.

Sur les modèles dont la fiche est polarisée:

**ATTENTION:** POUR ÉVITER LES CHOCS ÉLECTRIQUES, INTRODUIRE LA LAME LA PLUS LARGE DE LA FICHE DANS LA BORNE CORRESPONDANTE DE LA PRISE ET POUSSER JUSQU'AU FOND.

### For British models

Replacement and mounting of an AC plug on the power supply cord of this unit should be performed only by qualified service personnel.

#### IMPORTANT

The wires in the mains lead are coloured in accordance with the following code:

Blue: Neutral

Brown: Live

As the colours of the wires in the mains lead of this apparatus may not correspond with the coloured markings identifying the terminals in your plug, proceed as follows:

The wire which is coloured blue must be connected to the terminal which is marked with the letter N or coloured black.

The wire which is coloured brown must be connected to the terminal which is marked with the letter L or coloured red.

#### IMPORTANT

The plug is fitted with an appropriate fuse. If the fuse needs to be replaced, the replacement fuse must be approved by ASTA or BSI to BS1362 and have the same ampere rating as that indicated on the plug. Check for the ASTA mark or the BSI mark on the body of the fuse. If the power cord's plug is not suitable for your socket outlets, cut it off and fit a suitable plug. Fit a suitable fuse in the plug.

### For European Models

#### Declaration of Conformity

We, ONKYO EUROPE  
ELECTRONICS GmbH  
LIEGNITZERSTRASSE 6,  
82194 GROEBENZELL,  
GERMANY



declare in own responsibility, that the ONKYO product described in this instruction manual is in compliance with the corresponding technical standards such as EN60065, EN55013, EN55020 and EN61000-3-2, -3-3.

GROEBENZELL, GERMANY

K. MIYAGI

ONKYO EUROPE ELECTRONICS GmbH

## Supplied Accessories

Make sure you have the following accessories:

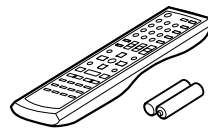

Remote controller and two batteries (AA/R6)



Indoor FM antenna

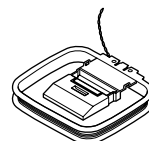

AM loop antenna

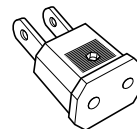

Power-plug adapter

Only supplied in certain countries. Use this adapter if your AC outlet does not match with the plug on the AV receiver's power cord. (Adapter varies from country to country.)

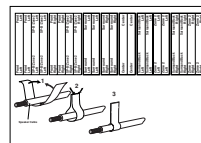

Speaker cable labels

\* In catalogs and on packaging, the letter at the end of the product name indicates the color. Specifications and operation are the same regardless of color.

# Features

---

## Amplifier

---

- 7-channel amplifier
- 75 watts per channel rms into 8 ohms, 2 channels driven, 20 Hz to 20 kHz, less than 0.08% total harmonic distortion (FTC rating)
- WRAT (Wide Range Amplifier Technology)
- Optimum Gain Volume Circuitry

## Processing

---

- Dolby<sup>\*1</sup> Digital EX and Dolby Pro Logic IIx
- DTS, DTS-ES Matrix/Discrete, DTS Neo:6, and DTS 96/24<sup>\*2</sup>
- Neural Surround<sup>\*3</sup> (North American models only)
- CinemaFILTER function
- Linear PCM 192 kHz/24-bit D/A converters on all channels
- Pure Audio listening mode (not North American model)
- Powerful and highly accurate 32-bit DSP processing

## Audio/Video

---

- Adjustable crossover (40, 50, 60, 80, 100, 120, 150, 200 Hz)
- HDTV-capable component video (3 inputs, 1 output)
- 3 S-Video inputs, 2 outputs
- 4 assignable digital inputs (3 optical, 1 coaxial)
- Subwoofer pre out
- Color-coded 7.1 multichannel input for use with Super Audio CD and DVD-Audio
- A/B speaker drive
- Color-coded speaker terminal posts

## Tuner

---

- XM<sup>\*4</sup> Satellite Radio (North American models only)  
\*XM Passport System required; sold separately.
- 40 AM/FM/XM presets
- AM/FM auto tuning
- RDS (Radio Data System) (Europe only)

## Remote Controller

---

- Preprogrammed for use with other AV components



Manufactured under license from Dolby Laboratories. "Dolby", "Pro Logic" and the double-D symbol are registered trademarks of Dolby Laboratories.



"DTS," "DTS 96/24," "DTS-ES," and "Neo:6" are trademarks of Digital Theater Systems, Inc.



Neural Surround name and related logos are trademarks owned by Neural Audio Corporation.



XM Ready<sup>®</sup>, XM Public Radio<sup>™</sup> are trademarks of XM Satellite Radio Inc. ©2005 XM Satellite Radio Inc. All rights reserved. All other trademarks are the property of their respective owners.

# Enjoying Home Theater

## Speaker Sets A and B

You can use two sets of speakers with the AV receiver: *speaker set A* and *speaker set B*.

**Speaker set A** should be used in your main listening room for up to 7.1-channel playback.

\*While speaker set B is on, speaker set A is reduced to 5.1-channel playback.

**Speaker set B** can be used in another room and offers 2-channel stereo playback.

\*Only analog input sources are output by speaker set B.

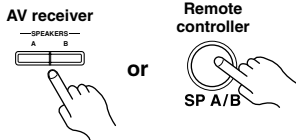

| Speaker set A | Speaker set B | Indicator         | Output                                   |
|---------------|---------------|-------------------|--|
| On            | On            | <b>A</b> <b>B</b> | Set A: 5.1 channels<br>Set B: 2 channels |
|               | Off           | <b>A</b>          | Set A: 7.1 channels                      |
| Off           | On            | <b>B</b>          | Set B: 2 channels                        |
|               | Off           |                   | No sound                                 |

### Speaker Set A: Main Room

#### Front left and right speakers

These output the overall sound. Their role in a home theater is to provide a solid anchor for the sound image. They should be positioned facing the listener at about ear level, and equally spaced from the TV. Angle them inward.

#### Center speaker

This speaker enhances the front left and right speakers, making sound movements distinct and providing a full sound image. For movies it's used mainly for dialog. Position it close to your TV facing forward at about ear level, or at the same height as the front left and right speakers.

#### Subwoofer

The subwoofer handles the bass sounds of the LFE (Low-Frequency Effects) channel. In general, a good bass sound can be obtained by installing the subwoofer in a front corner, or at one-third the way along the wall, as shown.

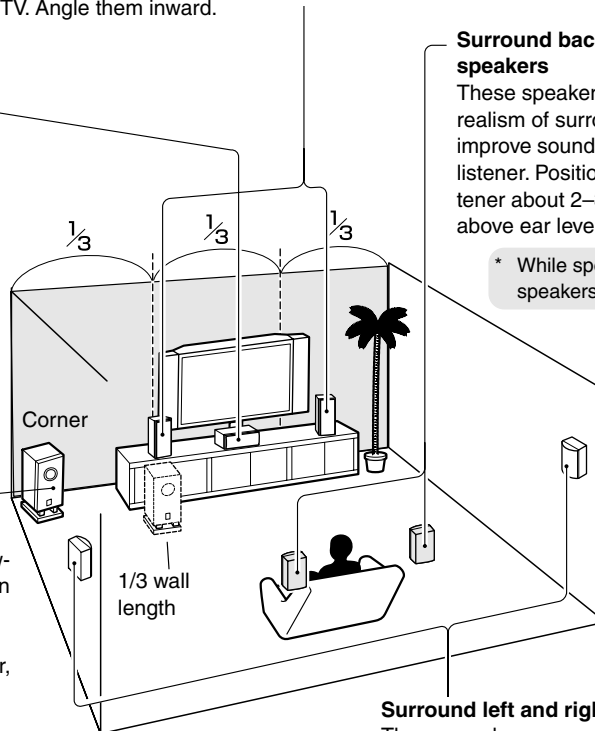

#### Surround back left and right speakers

These speakers further enhance the realism of surround sound and improve sound localization behind the listener. Position them behind the listener about 2–3 feet (60–100 cm) above ear level.

\* While speaker set B is on, these speakers output no sound.

#### Surround left and right speakers

These speakers are used for precise sound positioning and to add realistic ambience. Position them at the sides of the listener, or slightly behind, about 2–3 feet (60–100 cm) above ear level. Ideally they should be equally spaced from the listener.

### Speaker Set B: Sub Room

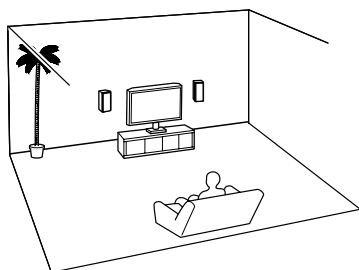

# Contents

## Introduction

|  |           |
|--|-----------|
| Important Safety Instructions .....          | 2         |
| Precautions .....                            | 3         |
| Supplied Accessories.....                    | 4         |
| Features .....                               | 5         |
| <b>Enjoying Home Theater .....</b>           | <b>6</b>  |
| Speaker Sets A and B .....                   | 6         |
| <b>Getting to Know the AV Receiver .....</b> | <b>8</b>  |
| <b>Remote Controller.....</b>                | <b>11</b> |

## Connection

|  |           |
|--|-----------|
| <b>Connecting Your Speakers .....</b>                          | <b>16</b> |
| <b>Connecting Antennas .....</b>                               | <b>18</b> |
| <b>Connecting Your Components .....</b>                        | <b>20</b> |
| About AV Connections .....                                     | 20        |
| Connecting Audio and Video Signals<br>to the AV Receiver ..... | 21        |
| Which Connections Should I Use? .....                          | 21        |
| <b>TV or Projector .....</b>                                   | <b>22</b> |
| <b>DVD player .....</b>  | <b>23</b> |
| VCR or DVD Recorder for Playback .....                         | 25        |
| VCR or DVD Recorder for Recording.....                         | 26        |
| Camcorder, Games Console,<br>or Other Device .....             | 26        |
| Satellite, Cable, Set-top box,<br>or Other Video Source .....  | 27        |
| CD Player or Turntable.....                                    | 28        |
| HDD-compatible Component .....                                 | 29        |
| Cassette, CDR, MiniDisc,<br>or DAT Recorder.....               | 30        |
| Connecting the Power Cord of Another<br>Component .....        | 30        |
| <b>Connecting Onkyo <b>RI</b> Components.....</b>              | <b>31</b> |
| Connecting the Power Cord .....                                | 31        |

## Turning On & First Time Setup

|  |           |
|--|-----------|
| <b>Turning On the AV Receiver .....</b>                            | <b>32</b> |
| <b>First Time Setup .....</b>                                      | <b>33</b> |
| Assigning Digital Inputs to Input Sources....                      | 33        |
| Changing the Input Display .....                                   | 33        |
| Minimum Speaker Impedance Setup<br>(not North American model)..... | 34        |
| Speaker Configuration.....   | 34        |

## Basic Operation

|  |           |
|--|-----------|
| <b>Playing Your AV Components .....</b>                                | <b>36</b> |
| Basic AV Receiver Operation .....                                      | 36        |
| Using the Multichannel DVD Input.....                                  | 37        |
| Displaying Source Information .....                                    | 37        |
| <b>Listening to the Radio.....</b>                                     | <b>38</b> |
| Listening to AM/FM stations .....                                      | 38        |
| Presetting AM/FM Stations<br>and XM Channels.....                      | 39        |
| Listening to XM Satellite Radio®<br>(North American Models Only) ..... | 42        |
| <b>Common Functions.....</b>   | <b>46</b> |
| Setting the Display Brightness.....                                    | 46        |
| Adjusting the Bass and Treble.....                                     | 46        |
| Muting the AV Receiver .....   | 46        |
| Using the Sleep Timer .....  | 47        |
| Using Headphones .....   | 47        |
| Adjusting Speaker Levels .....   | 47        |

## Enjoying the Listening Modes

|                                       |           |
|---------------------------------------|-----------|
| <b>Using the Listening Modes.....</b> | <b>48</b> |
| Selecting Listening Modes .....       | 48        |
| About the Listening Modes .....       | 50        |
| Using the Late Night Function .....   | 52        |
| Using the CinemaFILTER.....           | 52        |
| Using the Audio Adjust Settings ..... | 52        |

## Advanced Operation

|  |           |
|--|-----------|
| <b>Recording.....</b>  | <b>54</b> |
| <b>Advanced Setup .....</b>  | <b>55</b> |
| Advanced Speaker Settings .....  | 55        |
| Digital Input Signal Formats .....   | 57        |
| Correcting Sound and Picture Sync .....                                    | 58        |
| <b>Controlling Other Components.....</b>                                   | <b>59</b> |
| Entering Remote Control Codes.....   | 59        |
| Remote Control Codes for Onkyo<br>Components Connected via <b>RI</b> ..... | 60        |
| Resetting REMOTE MODE Buttons .....  | 60        |
| Resetting the Remote Controller .....                                      | 60        |

|   |           |
|---|-----------|
| <b>Troubleshooting .....</b>  | <b>62</b> |
| If you can't resolve an issue, try resetting the AV receiver by holding down the [VIDEO 1] button and pressing the [STANDBY/ON] button. |           |

|                             |           |
|-----------------------------|-----------|
| <b>Specifications .....</b> | <b>66</b> |
|-----------------------------|-----------|

# Getting to Know the AV Receiver

## Front Panel

### North American Model

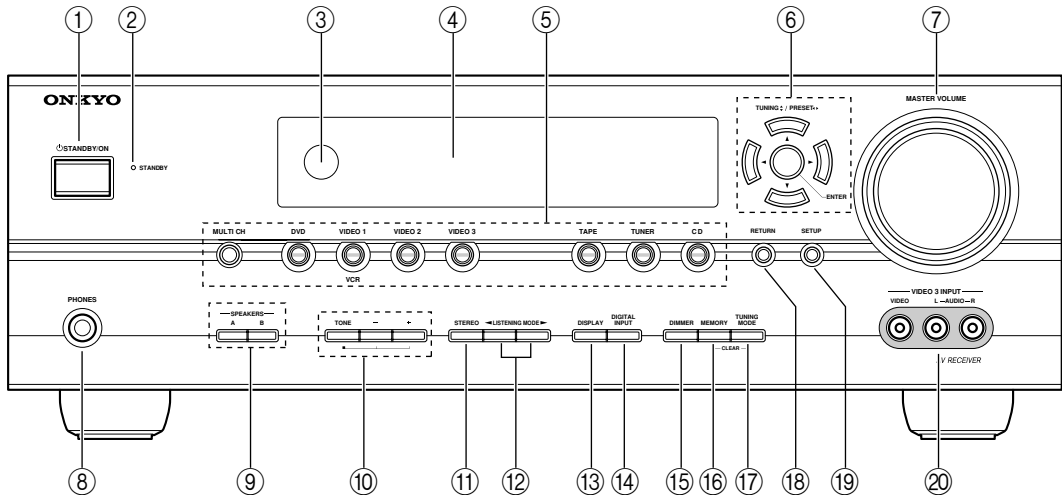

### Other Models

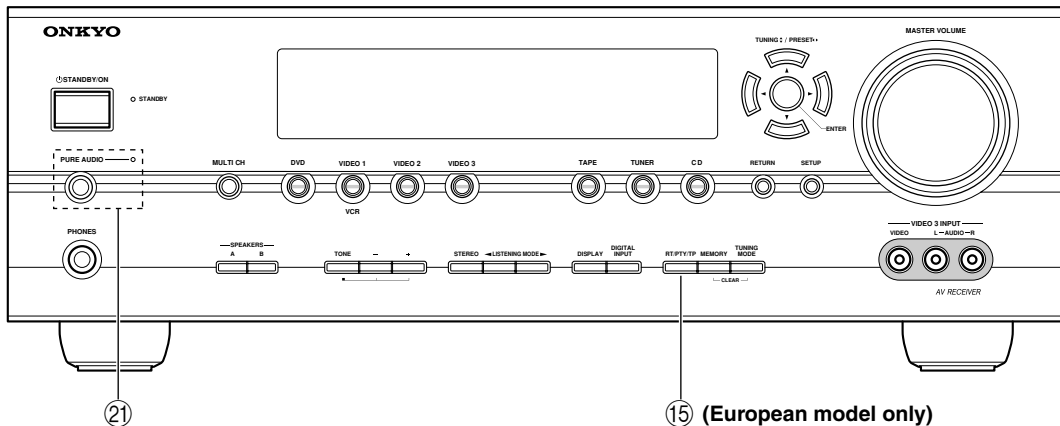

For detailed information, see the pages in parentheses.

- ① **STANDBY/ON button (32)**  
Sets the AV receiver to On or Standby.
- ② **STANDBY indicator (32)**  
Lights up when the AV receiver is on Standby and flashes while a signal is being received from the remote controller.
- ③ **Remote-control sensor (11)**  
Receives control signals from the remote controller.
- ④ **Display**  
See "Display" on page 9.
- ⑤ **Input selector buttons (36)**  
Select the input sources.  
The [MULTI CH] button selects the multichannel DVD input.
- ⑥ **Arrow/TUNING/PRESET and ENTER buttons**  
When AM, FM, or XM is selected, the TUNING [▲] [▼] buttons are used for radio tuning, and the PRESET [◀] [▶] buttons are used to select radio presets (see page 39). With the setup menus, they work as arrow buttons and are used to select and set items. The ENTER button is also used with the setup menus.
- ⑦ **MASTER VOLUME control (36)**  
Sets the volume of the AV receiver to MIN, 1 through 79, or MAX.
- ⑧ **PHONES jack (47)**  
This 1/4-inch phone jack is for connecting a standard pair of stereo headphones for private listening.
- ⑨ **SPEAKERS A and B buttons (6, 36)**  
Turn speaker sets A and B on or off.



## Getting to Know the AV Receiver—Continued

- ⑩ **TONE, [-], and [+] buttons (46)**  
Used to adjust the bass and treble.
- ⑪ **STEREO button (48)**  
Selects the Stereo listening mode.
- ⑫ **LISTENING MODE [◀]/[▶] buttons (48)**  
Select the listening modes.
- ⑬ **DISPLAY button (37)**  
Displays various information about the currently selected input source.
- ⑭ **DIGITAL INPUT button (33, 57)**  
Used to assign the digital inputs and to specify the format of digital input signals.
- ⑮ **DIMMER or RT/PTY/TP button (41, 46)**  
Adjusts the display brightness.  
On the European model, this is the RT/PTY/TP button, and it's used with RDS (Radio Data System). See "Using RDS (European Models Only)" on page 40.
- ⑯ **MEMORY button (39)**  
Used when storing or deleting radio presets.
- ⑰ **TUNING MODE button (38)**  
Selects the Auto or Manual tuning mode for AM and FM radio.
- ⑱ **RETURN button**  
Selects the previously displayed setup menu.
- ⑲ **SETUP button**  
Used to access the setup menus.
- ⑳ **VIDEO 3 INPUT (26, 54)**  
Used to connect a camcorder, games console, and so on. There are jacks for composite video and analog audio.
- ㉑ **PURE AUDIO button and indicator (48)**  
The North American model doesn't have this button and indicator.  
Selects the Pure Audio listening mode. The indicator lights up when this mode is selected.

### Display

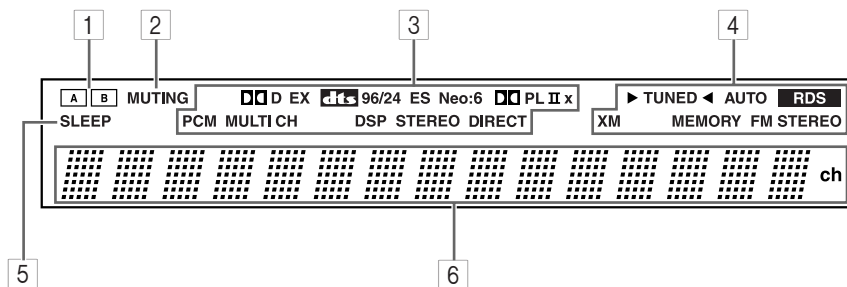

For detailed information, see the pages in parentheses.

- ① **A and B speaker indicators (6, 36)**  
Indicator A lights up when speaker set A is on. Indicator B lights up when speaker set B is on.
- ② **MUTING indicator (46)**  
Flashes while the AV receiver is muted.
- ③ **Listening mode and format indicators (50)**  
Show the selected listening mode and the format of digital audio signals.
- ④ **Radio indicators**  
**TUNED (38):** Lights up when tuned to a radio station.  
**AUTO (38):** For AM and FM radio, lights up when Auto Tuning is selected, and disappears when Manual Tuning mode is selected.  
**RDS (European models only) (40):** Lights up when tuned to a radio station that supports RDS (Radio Data System).
- XM (North American models only) (42):**  
Lights up when XM radio is selected.
- MEMORY (39):** Lights up when presetting radio stations.
- FM STEREO (38):** Lights up when tuned to a stereo FM station.
- ⑤ **SLEEP indicator (47)**  
Lights up when the Sleep function has been set.
- ⑥ **Message area**  
Displays various information about the selected input source.

## Rear Panel

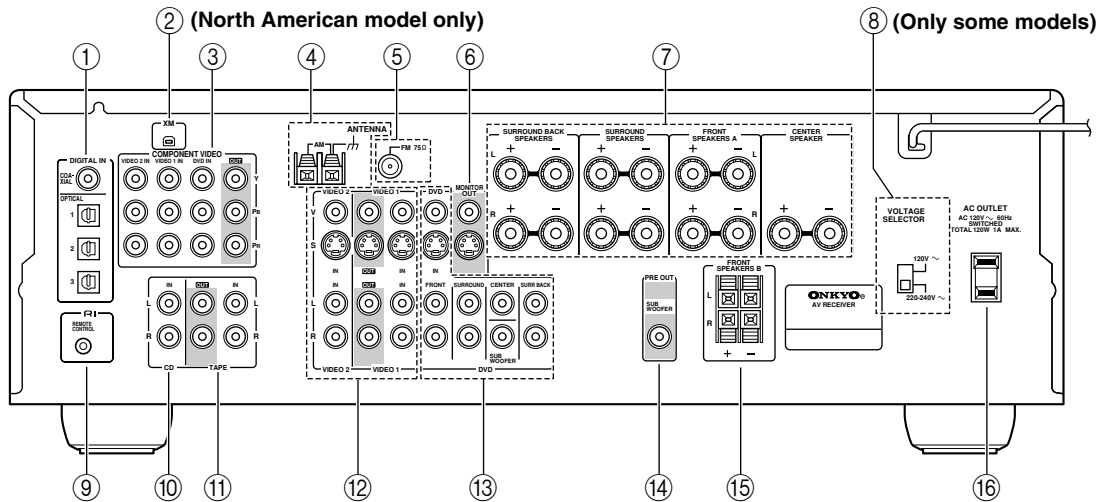

**① DIGITAL IN OPTICAL 1, 2, 3, and COAXIAL**  
 These optical and coaxial digital audio inputs are for connecting components with optical or coaxial digital audio outputs, such as CD and DVD players.

**② XM antenna (on North American models)**  
 This jack is for connecting an XM Passport System, sold separately (see page 42).

**③ COMPONENT VIDEO**  
 A DVD player, TV, or other component that supports component video can be connected here.

**④ AM ANTENNA**  
 These push terminals are for connecting an AM antenna.

**⑤ FM ANTENNA**  
 This jack is for connecting an FM antenna.

**⑥ MONITOR OUT**  
 The S-Video or composite video output should be connected to a video input on your TV or projector.

**⑦ FRONT SPEAKERS A, SURROUND SPEAKERS, CENTER SPEAKER, and SURROUND BACK SPEAKERS**  
 These terminal posts are for connecting speaker set A.

**⑧ VOLTAGE SELECTOR (Only some models)**  
 This voltage selector provides compatibility with power systems around the world (see page 3).

**⑨ RI REMOTE CONTROL**  
 This RI Remote Interactive jack can be connected to the RI jack on another RI-capable Onkyo component. To use RI, you must make an analog audio connection (RCA) between the AV receiver and the other component, even if they are connected digitally.

**⑩ CD IN**  
 This analog audio input is for connecting a CD player's analog audio output.

**⑪ TAPE IN/OUT**  
 This analog audio input and output are for connecting a recorder with an analog audio input and output, such as a cassette deck, MD recorder, etc.

**⑫ VIDEO 1 IN/OUT and VIDEO 2 IN**  
 The VIDEO 1 inputs and outputs can be used to connect a VCR. The VIDEO 2 inputs can be used to connect another video source (e.g., cable/satellite receiver, set-top box, etc).

**⑬ DVD IN**  
 These jacks can be used to connect a DVD player with an analog multichannel audio output for SACD and DVD-Audio playback.

**⑭ SUBWOOFER PRE OUT**  
 A powered subwoofer can be connected here.

**⑮ FRONT SPEAKERS B**  
 These push terminals are for connecting speaker set B.

**⑯ AC OUTLET**  
 This switched AC outlet can be used to supply power to another AV component. The type of outlet depends on the country in which you purchased your AV receiver.

See pages 16–31 for hookup information.

# Remote Controller

## Installing the Batteries

- 1 To open the battery compartment, press the small hollow and slide open the cover.**

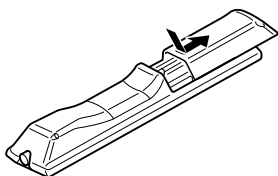

- 2 Insert the two supplied batteries (AA/R6) in accordance with the polarity diagram inside the battery compartment.**

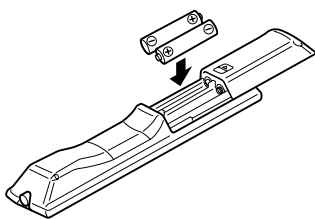

- 3 Slide the cover shut.**

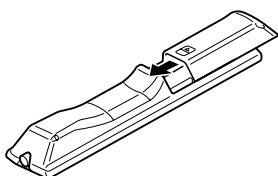

### Notes:

- If the remote controller doesn't work reliably, try replacing the batteries.
- Don't mix new and old batteries or different types of batteries.
- If you intend not to use the remote controller for a long time, remove the batteries to prevent damage from leakage or corrosion.
- Expired batteries should be removed as soon as possible to prevent damage from leakage or corrosion.

## Aiming the Remote Controller

When using the remote controller, point it toward the AV receiver's remote control sensor, as shown below.

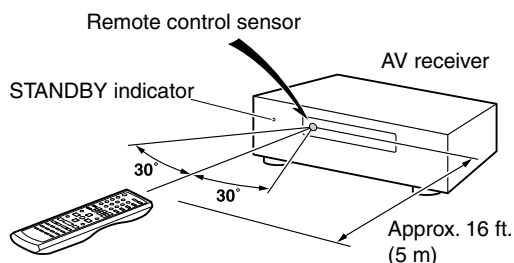

### Notes:

- The remote controller may not work reliably if the AV receiver is subjected to bright light, such as direct sunlight or inverter-type fluorescent lights. Keep this in mind when installing.
- If another remote controller of the same type is used in the same room, or the AV receiver is installed close to equipment that uses infrared rays, the remote controller may not work reliably.
- Don't put anything on top of the remote controller, such as a book or magazine, because a button may be pressed continuously, thereby draining the batteries.
- The remote controller may not work reliably if the AV receiver is installed in a rack behind colored glass doors. Keep this in mind when installing.
- The remote controller will not work if there's an obstacle between it and the AV receiver's remote control sensor.

## Using the Remote Controller

Including the AV receiver, the remote controller can be used to control up to seven different components. The remote controller has a specific operating mode for use with each type of component. Modes are selected by using the six REMOTE MODE buttons.

### ■ RECEIVER/TAPE Mode

In RECEIVER/TAPE mode, you can control the AV receiver and an Onkyo cassette recorder connected via **RI**.

### ■ DVD and CD/MD/CDR/HDD Modes

With these modes, you can control a DVD player and CD, MD, CDR, or HDD player or recorder. By entering the appropriate remote control code, you can control Onkyo components or components made by other manufacturers (see page 59).

### ■ TV, VCR and SAT/CABLE Modes

With these modes, you can control a TV, VCR, and satellite or cable receiver. You must enter the appropriate remote control code first (see page 59).

**1** Press one of the REMOTE MODE buttons to select a mode.

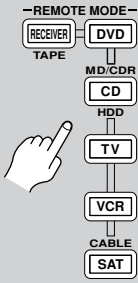

**2** Use the buttons supported by that mode to control the component.

RECEIVER/TAPE mode: see right column

DVD mode: see page 14

CD/MD/CDR/HDD mode: see page 15

TV, VCR, SAT/CABLE modes: see page 61

## RECEIVER/TAPE Mode

RECEIVER/TAPE mode is used to control the AV receiver. It can also be used to control an Onkyo cassette recorder connected via **RI**.

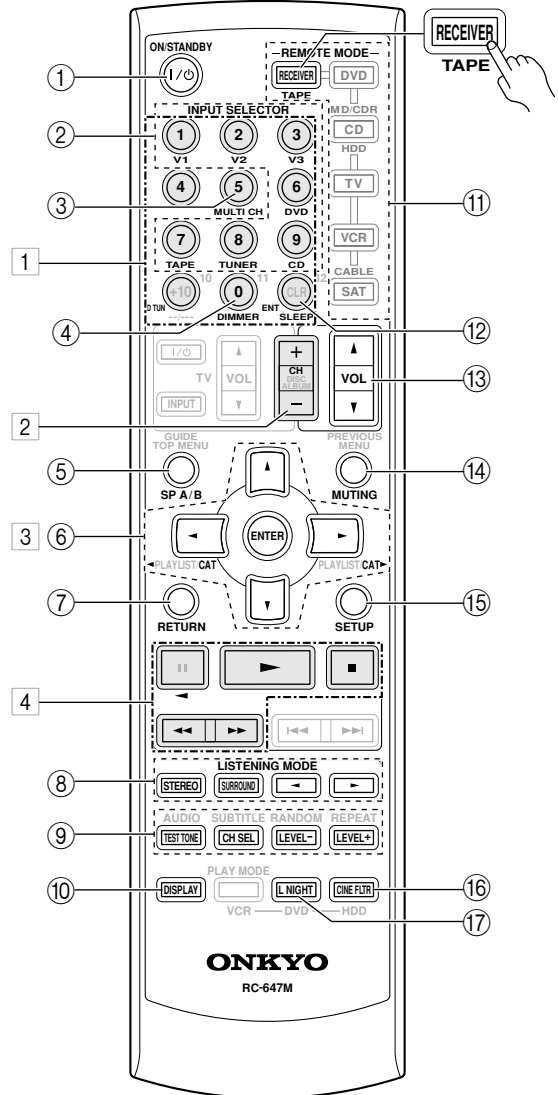

Buttons **1**, **2**, **3**, and **4** are used when the TUNER or TAPE input is selected.

### Note:

Some of the remote controller operations described in this manual may not work as expected with other components.

## Remote Controller—Continued

For detailed information, see the pages in parentheses.

- ① **ON/STANDBY button (32)**  
Sets the AV receiver to On or Standby.
- ② **INPUT SELECTOR buttons (36)**  
Used to select the input sources.
- ③ **MULTI CH button (37)**  
Selects the multichannel DVD input.
- ④ **DIMMER button (46)**  
Adjusts the display brightness.
- ⑤ **SP A/B button (6, 36)**  
Used to turn speaker sets A and B on or off.
- ⑥ **Arrow [▲]/[▼]/[◀]/[▶] and ENTER buttons**  
Used to select and adjust settings.
- ⑦ **RETURN button**  
Selects the previously displayed setup menu.
- ⑧ **LISTENING MODE buttons (48)**  
Used to select the listening modes. These buttons work in all remote controller modes.  
**STEREO button**  
Selects the Stereo listening mode.  
**SURROUND button**  
Selects the Dolby and DTS listening modes and the Neural Surround listening mode (North American model only).  
**[◀]/[▶] buttons**  
Used to select the available listening modes.
- ⑨ **TEST TONE, CH SEL, LEVEL-, and LEVEL+ buttons (35, 47, 57)**  
Used to adjust the level of each speaker.
- ⑩ **DISPLAY button (37)**  
Displays various information about the selected input source.
- ⑪ **REMOTE MODE buttons (12)**  
Used to select the remote controller modes. When a remote controller button is pressed, the REMOTE MODE button for the currently selected mode lights up.
- ⑫ **SLEEP button (47)**  
Used with the Sleep function.
- ⑬ **VOL [▲]/[▼] button (36)**  
Adjusts the volume of the AV receiver regardless of the currently selected remote controller mode.
- ⑭ **MUTING button (46)**  
Mutes or unmutes the AV receiver.
- ⑮ **SETUP button**  
Used to access the setup menus.
- ⑯ **CINE FLTR button (52)**  
Used with the CinemaFILTER function.
- ⑰ **L NIGHT button (52)**  
Used with the Late Night function.

### ■ Buttons used when the TUNER input is selected

To select the Tuner (AM/FM/XM) as the input source, press:



- ① **Number, D TUN, and ENT buttons (39, 43)**  
Used to select AM and FM radio stations and XM radio channels directly.
- ② **CH +/- button (39)**  
Used to select radio presets.
- ③ **Arrow [▲]/[▼]/[◀]/[▶] and ENTER buttons**  
For AM and FM, the Up and Down [▲]/[▼] buttons are used for tuning.

#### North American model only

For XM, the Up and Down [▲]/[▼] buttons are used to select channels, and the [ENTER] button is used to change the search mode. The Left and Right [◀]/[▶] buttons are used to select categories.

### ■ Buttons used when the TAPE input is selected

To select your Cassette deck as the input source, press:



- ④ **Playback buttons**  
On twin cassette decks, only deck B can be controlled.  
**Play [▶] button**  
Starts playback.  
**Stop [■] button**  
Stops playback.  
**Reverse Play [◀] button**  
Starts reverse playback.  
**Rewind and FF [◀◀]/[▶▶] buttons**  
The Rewind [◀◀] button starts rewind. The FF [▶▶] button starts fast forward.

## DVD Mode

By default, the remote controller is set to control an Onkyo DVD player.

To select your DVD player as the input source, press:

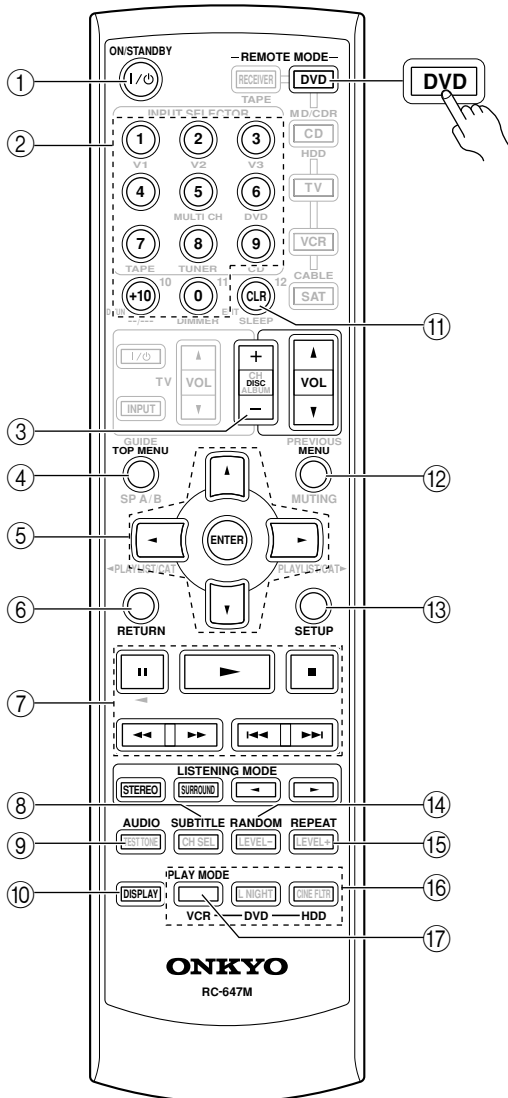

- ① **ON/STANDBY button**  
Sets the DVD player to On or Standby.
- ② **Number buttons**  
Used to enter title, chapter, and track numbers and times for locating specific points.
- ③ **DISC +/- button**  
Selects discs on a DVD changer.
- ④ **TOP MENU button**  
Selects a DVD's top menu.
- ⑤ **Arrow [▲]/[▼]/[◀]/[▶] and ENTER buttons**  
Used to navigate DVD menus and the DVD player's onscreen setup menus.
- ⑥ **RETURN button**  
Exits the DVD player's onscreen setup menus.
- ⑦ **Playback buttons**  
From left to right: Pause, Play, Stop, Fast Reverse, Fast Forward, Previous, and Next.
- ⑧ **SUBTITLE button**  
Selects subtitles.
- ⑨ **AUDIO button**  
Selects foreign language soundtracks and audio formats (e.g., Dolby Digital or DTS).
- ⑩ **DISPLAY button**  
Displays information about the current disc, title, chapter, or track, including elapsed time, remaining time, total time, and so on.
- ⑪ **CLR button**  
Cancels functions and clears entered numbers.
- ⑫ **MENU button**  
Displays a DVD's menu.
- ⑬ **SETUP button**  
Used to access the DVD player's onscreen setup menus.
- ⑭ **RANDOM button**  
Used with the random playback function.
- ⑮ **REPEAT button**  
Used with the repeat playback functions.
- ⑯ **VCR, DVD, and HDD buttons**  
Used to select VCR, HDD (hard disk drive), or DVD playback on a VCR/DVD recorder with a built-in hard disk drive.
- ⑰ **PLAY MODE button**  
Selects play modes on components with selectable play modes.

## CD/MD/CDR/HDD Mode

By default, the remote controller is set to control an Onkyo CD player.

To select the input source, press:



\* If you're using an MD, CDR, or HDD component, you must change the Input Display (see page 33).

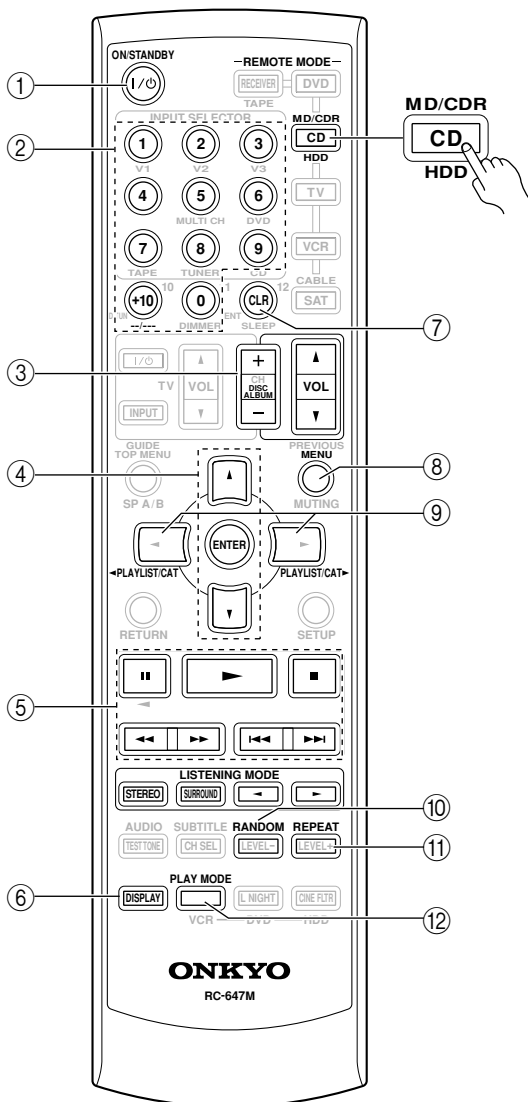

- ① **ON/STANDBY button**  
Sets the component to On or Standby.
- ② **Number buttons**  
Used to enter track numbers and times for locating specific points on CD/MD players.
- ③ **DISC/ALBUM +/- button**  
Selects discs on a CD changer, or the next or previous album on an HDD-compatible component.
- ④ **Arrow [▲]/[▼] and ENTER buttons**  
Used to navigate menus on an HDD-compatible component.
- ⑤ **Playback buttons**  
From left to right: Pause, Play, Stop, Fast Reverse, Fast Forward, Previous and Next.
- ⑥ **DISPLAY button**  
Displays information about the current disc or track on a CD player or MD/CD recorder, including elapsed time, remaining time, total time, and so on. On an HDD-compatible component, it turns on the back light for 30 seconds.
- ⑦ **CLR button**  
Cancels functions and clears entered numbers on a CD player or MD/CD recorder.
- ⑧ **MENU button**  
Used to navigate menus on an HDD-compatible component.
- ⑨ **PLAYLIST [◀]/[▶] buttons**  
Selects the previous or next playlist on an HDD-compatible component.
- ⑩ **RANDOM button**  
Used with the random/shuffle playback function.
- ⑪ **REPEAT button**  
Used with the repeat playback functions.
- ⑫ **PLAY MODE button**  
Used to select play modes on components with selectable play modes.

# Connecting Your Speakers

## Speaker Configuration

For the best surround-sound experience, you should connect seven speakers and a powered subwoofer.

The following table shows which channels you should use based on the number of speakers that you have.

| Number of speakers: | 2 | 3 | 4 | 5 | 6 | 7 |
|---------------------|---|---|---|---|---|---|
| Front left          | ✓ | ✓ | ✓ | ✓ | ✓ | ✓ |
| Front right         | ✓ | ✓ | ✓ | ✓ | ✓ | ✓ |
| Center              |   | ✓ |   | ✓ | ✓ | ✓ |
| Surround left       |   |   | ✓ | ✓ | ✓ | ✓ |
| Surround right      |   |   | ✓ | ✓ | ✓ | ✓ |
| Surround back*      |   |   |   |   | ✓ |   |
| Surround back left  |   |   |   |   |   | ✓ |
| Surround back right |   |   |   |   |   | ✓ |

\*If you're using only one surround back speaker, connect it to the left (L) SURROUND BACK SPEAKERS terminals.

No matter how many speakers you use, a powered subwoofer is recommended for a really powerful and solid bass.

Before using the AV receiver, you must specify which speakers are connected and their sizes (see page 34).

To get the very best from your surround-sound system, you should also set the advanced speaker settings (see page 55.)

## Attaching the Speaker Labels

The AV receiver's positive (+) speaker terminals are color-coded for ease of identification. (The negative (-) speaker terminals are all black.)

| Speaker terminal    | Color |
|---------------------|-------|
| Front left          | White |
| Front right         | Red   |
| Center              | Green |
| Surround left       | Blue  |
| Surround right      | Gray  |
| Surround back left  | Brown |
| Surround back right | Tan   |

The supplied speaker labels are also color-coded and you should attach them to the positive (+) side of each speaker cable in accordance with the above table. All you need to do then is to match the color of each label to the corresponding speaker terminal.



## Speaker Connection Precautions

Read the following before connecting your speakers:

- **North American models:** You can connect speakers with an impedance of between 6 and 16 ohms. If you use speakers with a lower impedance, and use the amplifier at high volume levels for a long period of time, the built-in amp protection circuit may be activated.
- **Other models:** You can connect speakers with an impedance of between 4 and 16 ohms. If the impedance of any of the connected speakers is 4 ohms or more, but less than 6 ohms, be sure to set the minimum speaker impedance to "4 ohms" (see page 34). If you use speakers with a lower impedance, and use the amplifier at high volume levels for a long period of time, the built-in amp protection circuit may be activated.
- Disconnect the power cord from the wall outlet before making any connections.
- Read the instructions supplied with your speakers.
- Pay close attention to speaker wiring polarity. In other words, connect positive (+) terminals to only positive (+) terminals, and negative (-) terminals to only negative (-) terminals. If you get them the wrong way around, the sound will be out of phase and will sound unnatural.
- Unnecessarily long or very thin speaker cables may affect the sound quality and should be avoided.
- Be careful not to short the positive and negative wires. Doing so may damage the AV receiver.
- Don't connect more than one cable to each speaker terminal. Doing so may damage the AV receiver.
- Don't connect a speaker to several terminals.

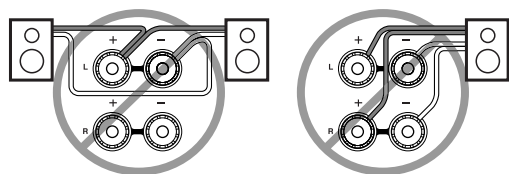
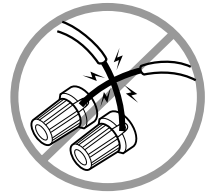



## Connecting Your Speakers—Continued

### Connecting Speaker Set A

- Strip 5/8" (15 mm) of insulation from the ends of the speaker cables, and twist the bare wires tightly, as shown.

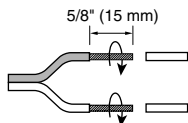

- Unscrew the terminal. Fully insert the bare wire, making sure that it's touching the threaded shaft in the center. Screw the terminal tight.

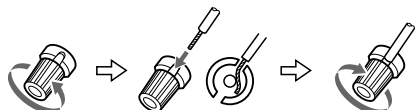

### Connecting Speaker Set B

- Strip 3/8" (10 mm) of insulation from the ends of the speaker cables, and twist the bare wires tightly, as shown.

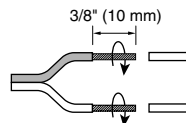

- While pressing the lever, insert the wire into the hole, and then release the lever. Make sure that the terminals are gripping the bare wires, not the insulation.

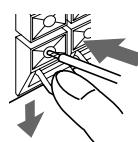

#### Note:

While speaker set B is on, speaker set A is reduced to 5.1-channel playback.

### Connecting a Powered Subwoofer

Using a suitable cable, connect the AV receiver's SUBWOOFER PRE OUT to the input on your powered subwoofer. If your subwoofer is unpowered and you're using an external amplifier, connect the SUBWOOFER PRE OUT to its input.

#### Note:

Make sure the plugs are pushed in all the way.

The following illustration shows which speaker should be connected to each pair of terminals.

If you're using only one surround back speaker, connect it to the left (L) SURROUND BACK SPEAKERS terminals.

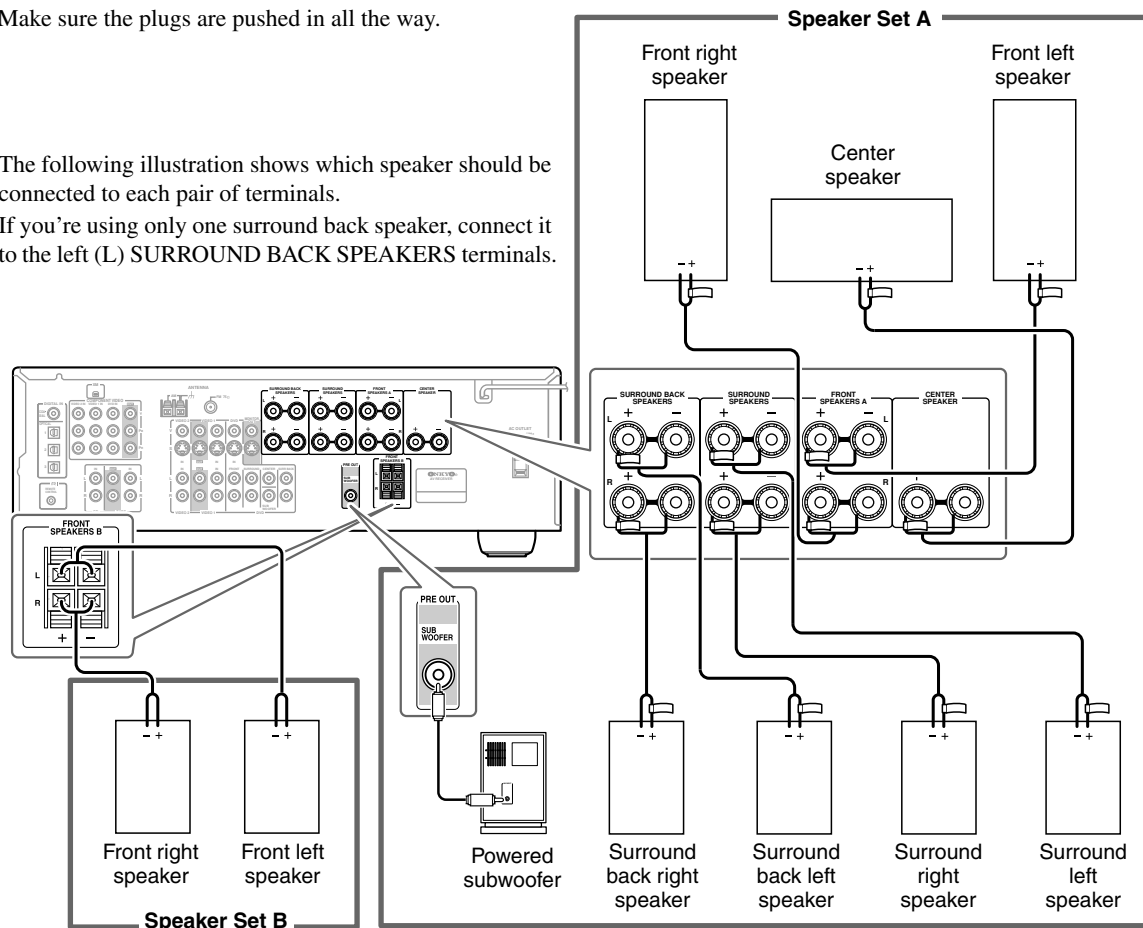

# Connecting Antennas

This section explains how to connect the supplied indoor FM antenna and AM loop antenna, and how to connect commercially available outdoor FM and AM antennas. The AV receiver won't pick up any radio signals without any antenna connected, so you must connect the antenna to use the tuner.

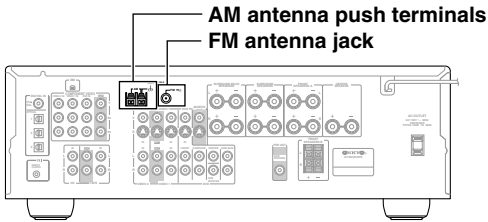

## Connecting the Indoor FM Antenna

The supplied indoor FM antenna is for indoor use only.

### 1 Attach the FM antenna, as shown.

#### ■ American Model

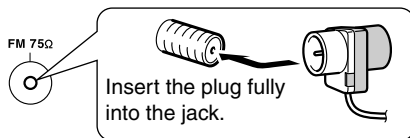

#### ■ Other Models

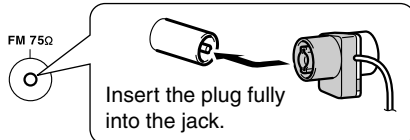

Once your AV receiver is ready for use, you'll need to tune into an FM radio station and adjust the position of the FM antenna to achieve the best possible reception.

### 2 Use thumbtacks or something similar to fix the FM antenna into position.

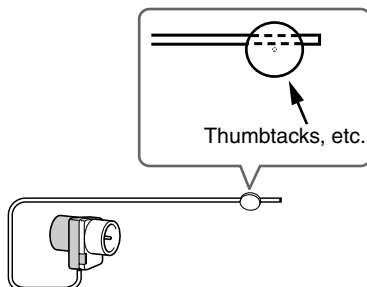

**Caution:** Be careful that you don't injure yourself when using thumbtacks.

If you cannot achieve good reception with the supplied indoor FM antenna, try a commercially available outdoor FM antenna instead (see page 19).

## Connecting the AM Loop Antenna

The supplied indoor AM loop antenna is for indoor use only.

### 1 Assemble the AM loop antenna, inserting the tabs into the base, as shown.

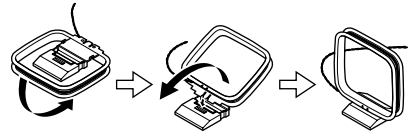

### 2 Connect both wires of the AM loop antenna to the AM push terminals, as shown.

(The antenna's wires are not polarity sensitive, so they can be connected either way around).

Make sure that the wires are attached securely and that the push terminals are gripping the bare wires, not the insulation.

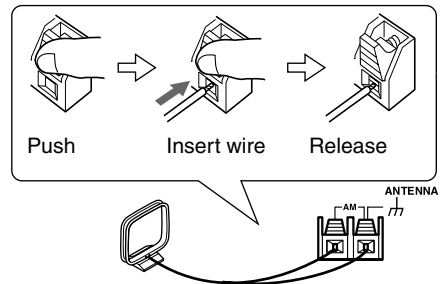

Once your AV receiver is ready for use, you'll need to tune into an AM radio station and adjust the position of the AM antenna to achieve the best possible reception.

Keep the antenna as far away as possible from your AV receiver, TV, speaker cables, and power cords.

If you cannot achieve good reception with the supplied indoor AM loop antenna, try using it with a commercially available outdoor AM antenna (see page 19).

### Connecting an Outdoor FM Antenna

If you cannot achieve good reception with the supplied indoor FM antenna, try a commercially available outdoor FM antenna instead.

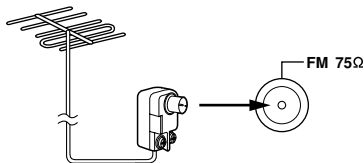

#### Notes:

- Outdoor FM antennas work best outside, but usable results can sometimes be obtained when installed in an attic or loft.
- For best results, install the outdoor FM antenna well away from tall buildings, preferably with a clear line of sight to your local FM transmitter.
- Outdoor antenna should be located away from possible noise sources, such as neon signs, busy roads, etc.
- For safety reasons, outdoor antenna should be situated well away from power lines and other high-voltage equipment.
- Outdoor antenna must be grounded in accordance with local regulations to prevent electrical shock hazards.

### ■ Using a TV/FM Antenna Splitter

It's best not to use the same antenna for both FM and TV reception, as this can cause interference problems. If circumstances demand it, use a TV/FM antenna splitter, as shown.

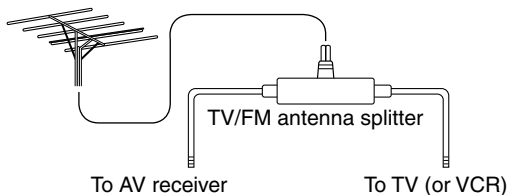

### Connecting an Outdoor AM Antenna

If good reception cannot be achieved using the supplied AM loop antenna, an outdoor AM antenna can be used in addition to the loop antenna, as shown.

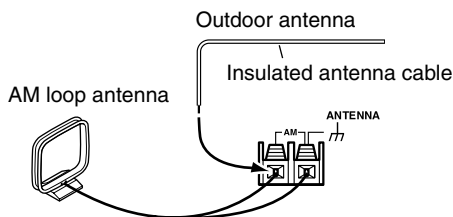

Outdoor AM antennas work best when installed horizontally outside, but good results can sometimes be obtained indoors by mounting horizontally above a window. Note that the AM loop antenna should be left connected. Outdoor antenna must be grounded in accordance with local regulations to prevent electrical shock hazards.

# Connecting Your Components

## About AV Connections

- Before making any AV connections, read the manuals supplied with your other AV components.
- Don't connect the power cord until you've completed and double-checked all AV connections.

## Optical Digital Jacks

The AV receiver's optical digital jacks have shutter-type covers that open when an optical plug is inserted and close when it's removed. Push plugs in all the way.

**Caution:** To prevent shutter damage, hold the optical plug straight when inserting and removing.

## AV Connection Color Coding

RCA-type AV connections are usually color coded: red, white, and yellow. Use red plugs to connect right-channel audio inputs and outputs (typically labeled "R"). Use white plugs to connect left-channel audio inputs and outputs (typically labeled "L"). And use yellow plugs to connect composite video inputs and outputs.

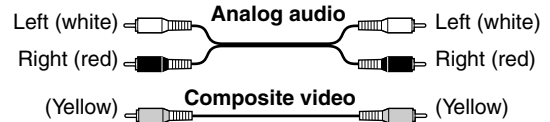

- Push plugs in all the way to make good connections (loose connections can cause noise or malfunctions).
- To prevent interference, keep audio and video cables away from power cords and speaker cables.

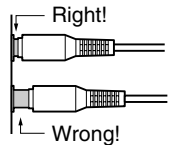

## AV Cables and Jacks

### Video

|                       | Cable | Jack              | Description  |
|-----------------------|-------|-------------------|--|
| Component video cable |       | <br>Y<br>PB<br>PR | Component video separates the luminance (Y) and color difference signals (PR, PB), providing the best picture quality. (Some TV manufacturers label their component video jacks slightly differently.) |
| S-Video cable         |       |                   | S-Video separates the luminance and color signals and provides better picture quality than composite video.  |
| Composite video cable |       |                   | Composite video is commonly used on TVs, VCRs, and other video equipment. Use only dedicated composite video cables.   |

### Audio

|                                       | Cable | Jack  | Description   |
|---------------------------------------|-------|---|---|
| Optical digital audio cable           |       |   | This offers the best sound quality and allows you to enjoy Dolby Digital and DTS. The audio quality is the same as for coaxial.   |
| Coaxial digital audio cable           |       |   | This offers the best sound quality and allows you to enjoy Dolby Digital and DTS. The audio quality is the same as for optical.   |
| Analog audio cable (RCA)              |       | <br>L<br>R  | This cable carries analog audio. It's the most common connection format for analog audio and can be found on virtually all AV components.   |
| Multichannel analog audio cable (RCA) |       | <br>FRONT SURROUND CENTER SURRBACK<br>SUB RECIPIER<br>DVD | This cable carries multichannel analog audio and is typically used to connect DVD players with a 7.1-channel analog audio output. Several standard analog audio cables can be used instead of a multichannel cable. |

**Note:** The AV receiver does not support SCART connections.

## Connecting Audio and Video Signals to the AV Receiver

By connecting both the audio and video outputs of your DVD player and other AV components to the AV receiver, you can switch the audio and video signals simultaneously simply by changing the input source on the AV receiver.

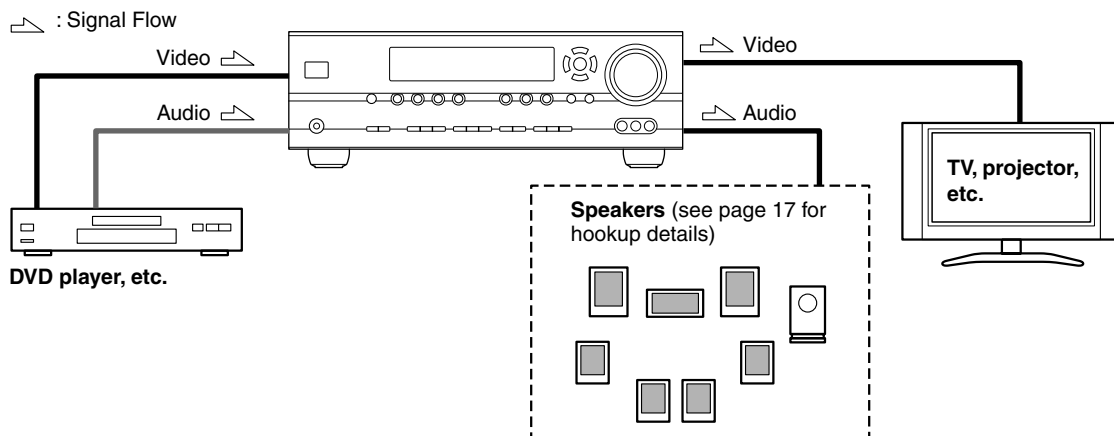

## Which Connections Should I Use?

The AV receiver supports several connection formats for compatibility with a wide range of AV equipment. The format you choose will depend on the formats supported by your other components. Use the following sections as a guide. For video components, such as a DVD player, you must make an audio connection and a video connection.

### Video Connection Formats

When choosing a connection format, bear in mind that the AV receiver doesn't convert between formats, so only outputs of the same format as the input will output the signal.

#### Video Signal Flow Chart

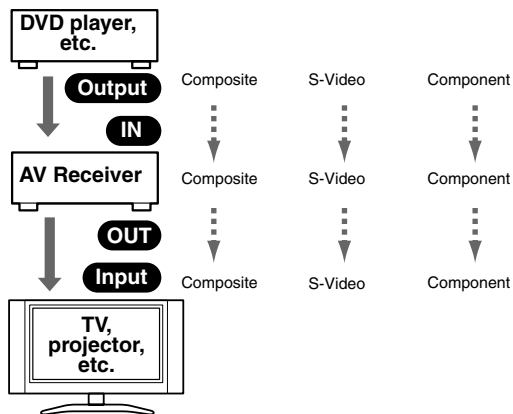

### Audio Connection Formats

When choosing a connection format, bear in mind that the AV receiver doesn't convert between formats. For example, audio signals connected to an OPTICAL or COAXIAL digital input are not output by the analog TAPE OUT, so if you want to record from, for example, your CD player, in addition to connecting it to a digital input, you must also connect it to the analog CD IN.

#### Audio Signal Flow Chart

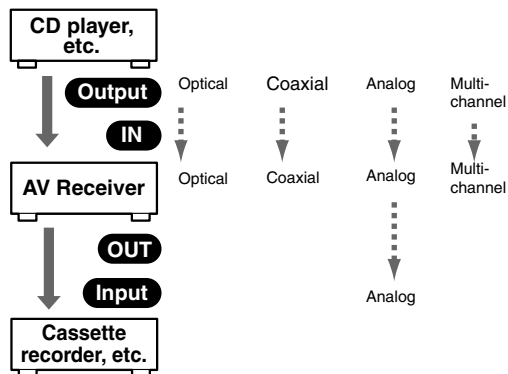

## Connecting Your Components—Continued

### Connecting a TV or Projector

#### Step 1: Video Connection

Choose a video connection that matches your TV (**A**, **B**, or **C**), and then make the connection.

#### Step 2: Audio Connection

Choose an audio connection that matches your TV (**a**, **b**, or **c**), and then make the connection.

- With connection **a**, you can listen to and record audio from your TV and listen via speaker set B.
- To enjoy Dolby Digital and DTS, use connection **b** or **c**. (For recording, use **a** and **b**, or **a** and **c**.)

| Connection | AV receiver          | Signal flow | TV                      | Picture quality |
|------------|----------------------|-------------|-------------------------|-----------------|
| <b>A</b>   | COMPONENT VIDEO OUT  | ⇒           | Component video input   | Best            |
| <b>B</b>   | MONITOR OUT S        | ⇒           | S-Video input           | Better          |
| <b>C</b>   | MONITOR OUT V        | ⇒           | Composite video input   | Standard        |
| <b>a</b>   | VIDEO 2 IN L/R       | ←           | Analog audio L/R output |                 |
| <b>b</b>   | DIGITAL IN COAXIAL   | ←           | Digital coaxial output  |                 |
| <b>c</b>   | DIGITAL IN OPTICAL 2 | ←           | Digital optical output  |                 |

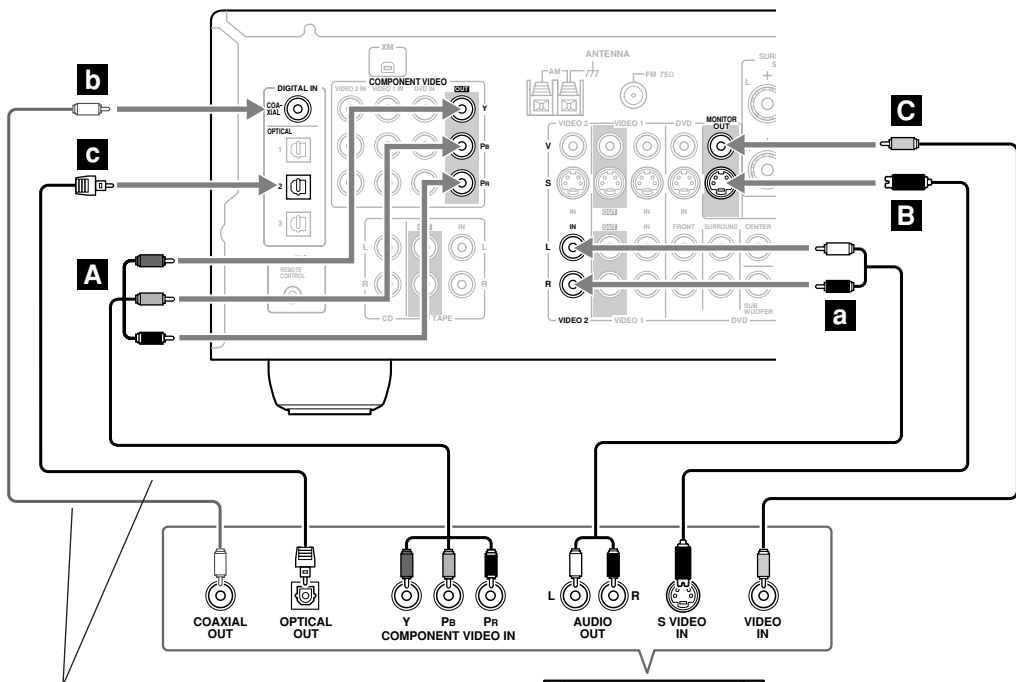

Connect one or the other  
Connection **b** must be assigned (see page 33)

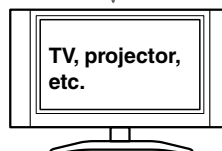

If your TV has no audio outputs, connect an audio output from your VCR or cable or satellite receiver to the AV receiver and use its tuner to listen to TV programs through the AV receiver (see pages 25 and 27).

## Connecting Your Components—Continued

### Connecting a DVD player

#### Step 1: Video Connection

Choose a video connection that matches your DVD player (**A**, **B**, or **C**), and then make the connection. You must connect the AV receiver to your TV via the same type of connection.

#### Step 2: Audio Connection

Choose an audio connection that matches your DVD player (**a**, **b**, or **c**), and then make the connection.

- With connection **a**, you can listen to and record audio from a DVD and listen via speaker set B.
- To enjoy Dolby Digital and DTS, use connection **b** or **c**. (For recording, use **a** and **b**, or **a** and **c**.)
- If your DVD player has main left and right outputs and multichannel left and right outputs, be sure to use the main left and right outputs for connection **a**.

| Connection | AV receiver            | Signal flow | DVD player              | Picture quality |
|------------|------------------------|-------------|-------------------------|-----------------|
| <b>A</b>   | COMPONENT VIDEO DVD IN | ←           | Component video output  | Best            |
| <b>B</b>   | DVD IN S               | ←           | S-Video output          | Better          |
| <b>C</b>   | DVD IN V               | ←           | Composite video output  | Standard        |
| <b>a</b>   | DVD IN FRONT           | ←           | Analog audio L/R output |                 |
| <b>b</b>   | DIGITAL IN COAXIAL     | ←           | Digital coaxial output  |                 |
| <b>c</b>   | DIGITAL IN OPTICAL 1   | ←           | Digital optical output  |                 |

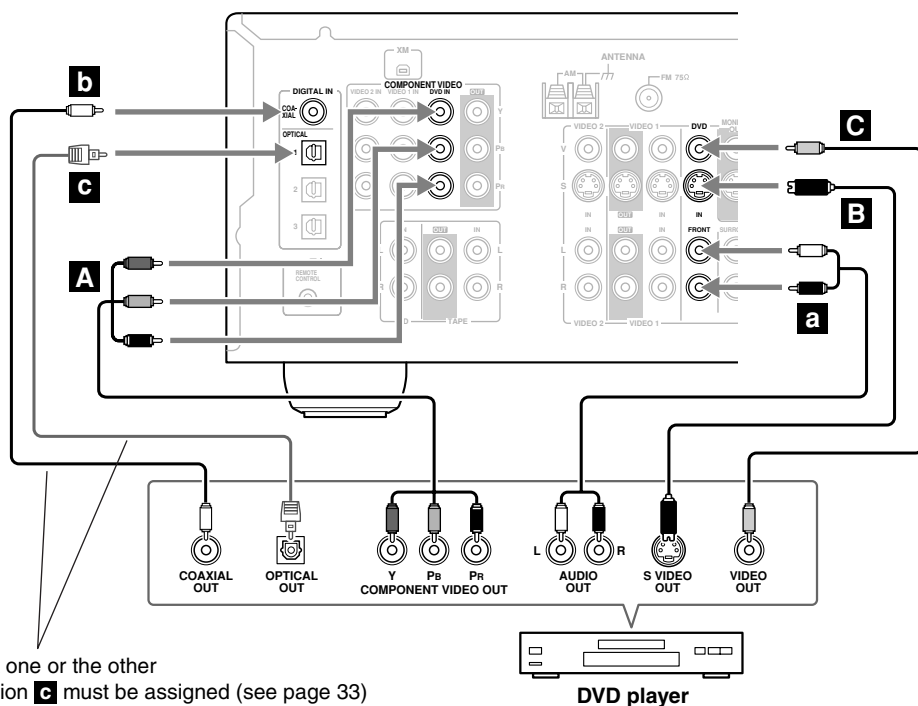

Connect one or the other  
Connection **c** must be assigned (see page 33)

To connect a DVD player or DVD-Audio/SACD-capable player with a multichannel analog audio output, see page 24. ➔

## Hooking Up the Multichannel DVD Input

If your DVD player supports multichannel audio formats such as DVD-Audio or SACD, and it has a multichannel analog audio output, you can connect it to the AV receiver's multichannel DVD input.

Use a multichannel analog audio cable, or several normal audio cables, to connect the AV receiver's DVD IN FRONT L/R, CENTER, SURROUND L/R, SURR BACK L/R, and SUBWOOFER jacks to the 7.1-channel analog audio output on your DVD player. If your DVD player has a 5.1-channel analog audio output, don't connect anything to the AV receiver's SURR BACK L/R jacks.

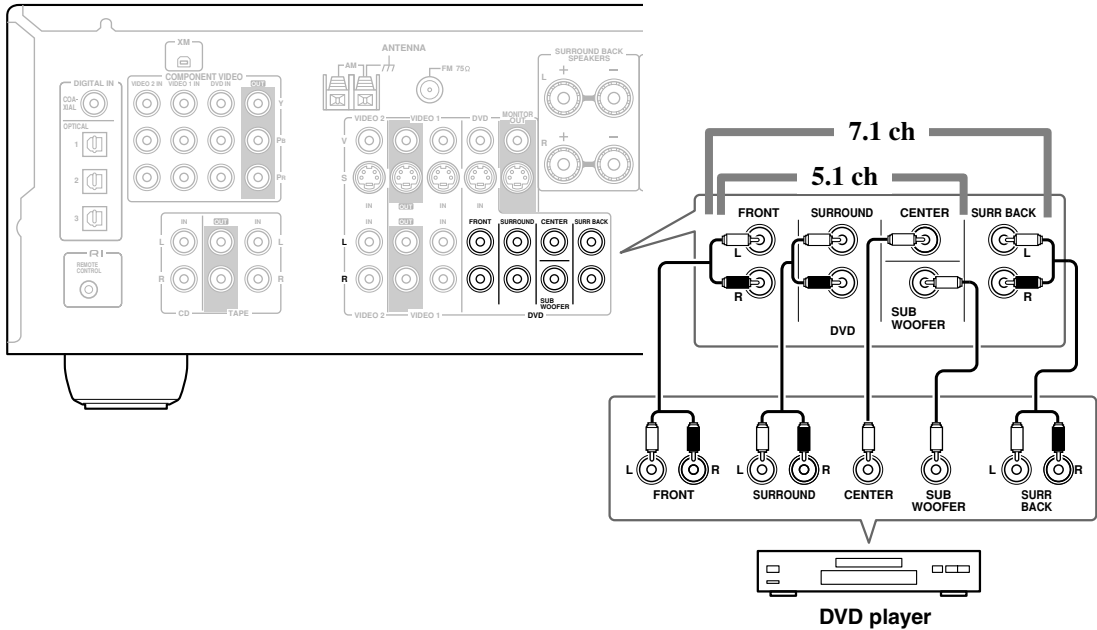



## Connecting Your Components—Continued

### Connecting a VCR or DVD Recorder for Playback



With this hookup, you can use your VCR's tuner to listen to your favorite TV programs via the AV receiver, useful if your TV has no audio outputs.

#### Step 1: Video Connection

Choose a video connection that matches your VCR or DVD recorder (**A**, **B**, or **C**), and then make the connection. You must connect the AV receiver to your TV via the same type of connection.

#### Step 2: Audio Connection

Choose an audio connection that matches your VCR or DVD recorder (**a**, **b**, or **c**), and then make the connection.

- With connection **a**, you can listen to the VCR or DVD recorder even via speaker set B.
- To enjoy Dolby Digital and DTS, use connection **b** or **c**. (To listen via speaker set B, use **a** and **b**, or **a** and **c**.)

| Connection | AV receiver                | Signal flow | VCR or DVD recorder     | Picture quality |
|------------|----------------------------|-------------|-------------------------|-----------------|
| <b>A</b>   | COMPONENT VIDEO VIDEO 1 IN | ←           | Component video output  | Best            |
| <b>B</b>   | VIDEO 1 IN S               | ←           | S-Video output          | Better          |
| <b>C</b>   | VIDEO 1 IN V               | ←           | Composite video output  | Standard        |
| <b>a</b>   | VIDEO 1 IN L/R             | ←           | Analog audio L/R output |                 |
| <b>b</b>   | DIGITAL IN COAXIAL         | ←           | Digital coaxial output  |                 |
| <b>c</b>   | DIGITAL IN OPTICAL 1       | ←           | Digital optical output  |                 |

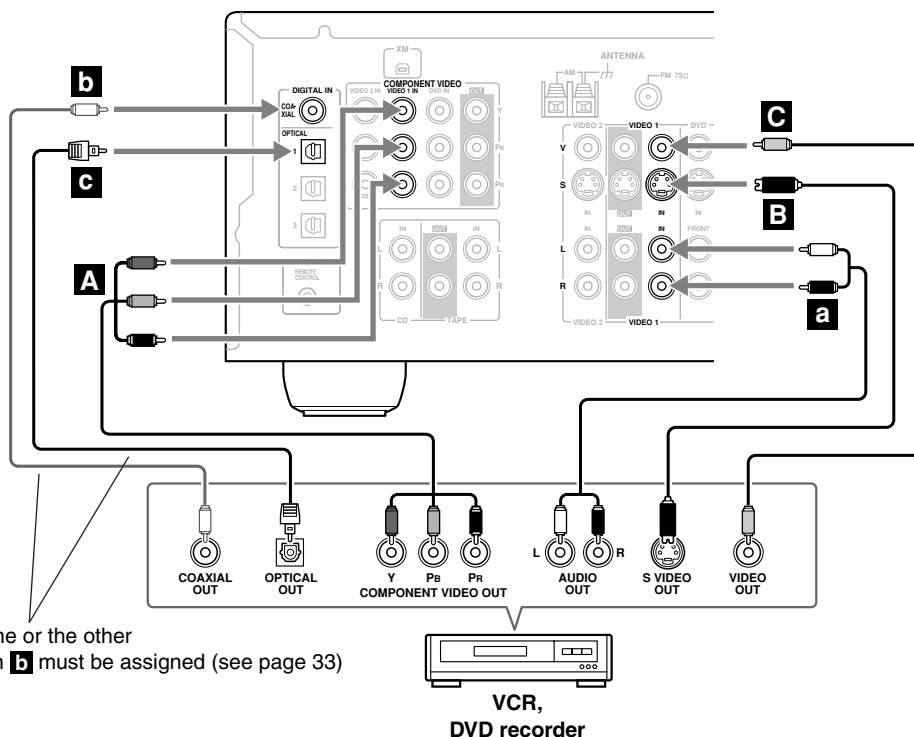

## Connecting Your Components—Continued

### Connecting a VCR or DVD Recorder for Recording

**Step 1:** Choose a video connection that matches your VCR or DVD recorder (**A** or **B**), and then make the connection. The video source to be recorded must be connected to the AV receiver via the same type of connection.

**Step 2:** Make the audio connection **a**.

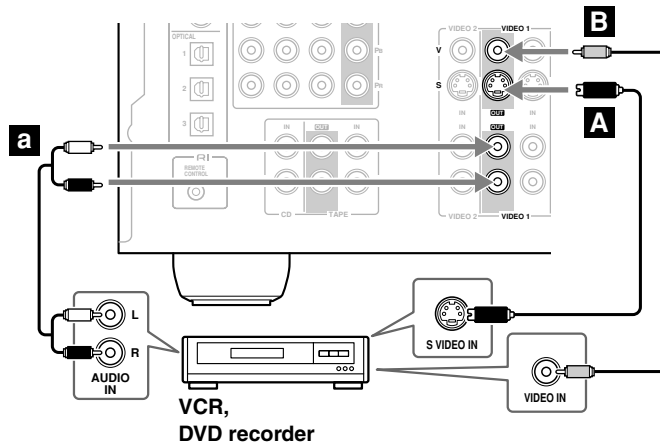

| Connection | AV receiver     | Signal flow | VCR or DVD recorder    | Picture quality |
|------------|-----------------|-------------|------------------------|-----------------|
| <b>A</b>   | VIDEO 1 OUT S   | ⇒           | S-Video input          | Better          |
| <b>B</b>   | VIDEO 1 OUT V   | ⇒           | Composite video input  | Standard        |
| <b>a</b>   | VIDEO 1 OUT L/R | ⇒           | Analog audio L/R input | —               |

### Connecting a Camcorder, Games Console, or Other Device

**Step 1:** Make the video connection **A**.

**Step 2:** Make the audio connection **a**.

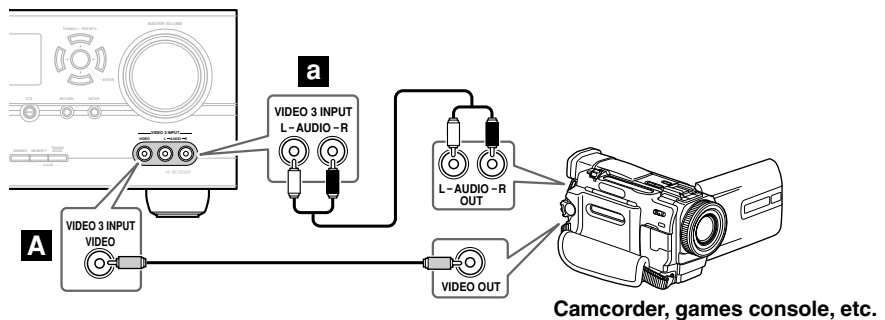

| Connection | AV receiver       | Signal flow | Camcorder or console    |
|------------|-------------------|-------------|-------------------------|
| <b>A</b>   | VIDEO 3 INPUT     | ←           | Composite video output  |
| <b>a</b>   | VIDEO 3 INPUT L/R | ←           | Analog audio L/R output |

## Connecting Your Components—Continued

### Connecting a Satellite, Cable, Set-top box, or Other Video Source



With this hookup, you can use your satellite or cable receiver to listen to your favorite TV programs via the AV receiver, useful if your TV has no audio outputs.

#### Step 1: Video Connection

Choose a video connection that matches the video source (**A**, **B**, or **C**), and then make the connection. You must connect the AV receiver to your TV via the same type of connection.

#### Step 2: Audio Connection

Choose an audio connection that matches the video source (**a**, **b**, or **c**), and then make the connection.

- With connection **a**, you can listen to and record audio from the video source and listen via speaker set B.
- To enjoy Dolby Digital and DTS, use connection **b** or **c**. (For recording, use **a** and **b**, or **a** and **c**.)

| Connection | AV receiver                | Signal flow | Video source            | Picture quality |
|------------|----------------------------|-------------|-------------------------|-----------------|
| <b>A</b>   | COMPONENT VIDEO VIDEO 2 IN | ←           | Component video output  | Best            |
| <b>B</b>   | VIDEO 2 IN S               | ←           | S-Video output          | Better          |
| <b>C</b>   | VIDEO 2 IN V               | ←           | Composite video output  | Standard        |
| <b>a</b>   | VIDEO 2 IN L/R             | ←           | Analog audio L/R output |                 |
| <b>b</b>   | DIGITAL IN COAXIAL         | ←           | Digital coaxial output  |                 |
| <b>c</b>   | DIGITAL IN OPTICAL 2       | ←           | Digital optical output  |                 |

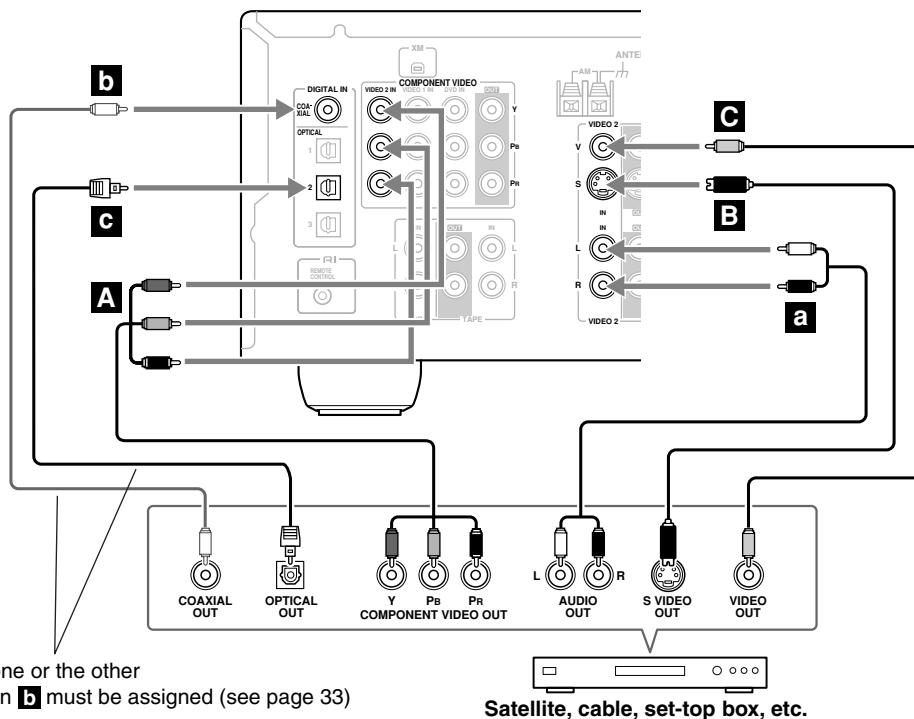

## Connecting a CD Player or Turntable

### ■ CD Player or Turntable (MM) with Built-in Phono Preamp

#### Step 1:

Choose a connection that matches your CD player (**a**, **b**, or **c**). Use connection **a** for a turntable with a built-in phono preamp.

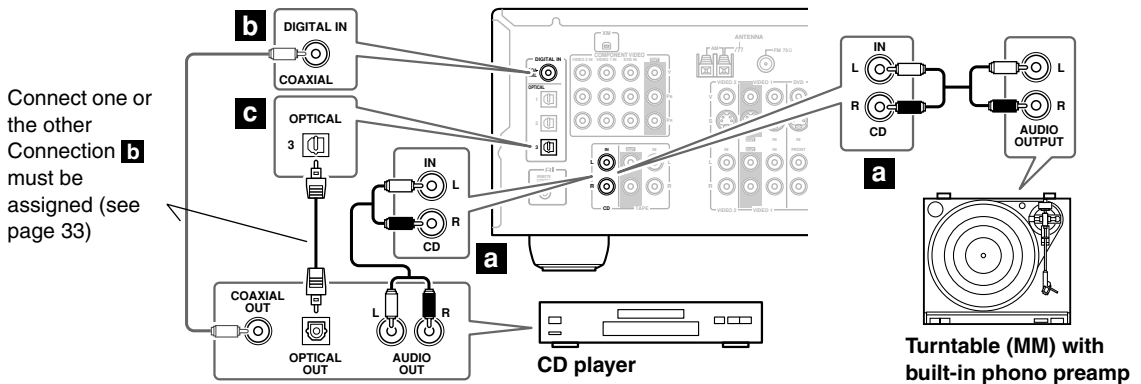

- With connection **a**, you can listen to and record audio from your CD player or turntable and listen via speaker set B.
- To connect the CD player digitally, use connection **b** or **c**. (For recording, use **a** and **b**, or **a** and **c**.)

| Connection | AV receiver          | Signal flow | CD or turntable         |
|------------|----------------------|-------------|-------------------------|
| <b>a</b>   | CD IN L/R            | ←           | Analog audio L/R output |
| <b>b</b>   | DIGITAL IN COAXIAL   | ←           | Digital coaxial output  |
| <b>c</b>   | DIGITAL IN OPTICAL 3 | ←           | Digital optical output  |

### ■ Turntable (MM) with no Phono Preamp Built-in

A phono preamp is necessary to connect a turntable that doesn't have a phono preamp built-in.

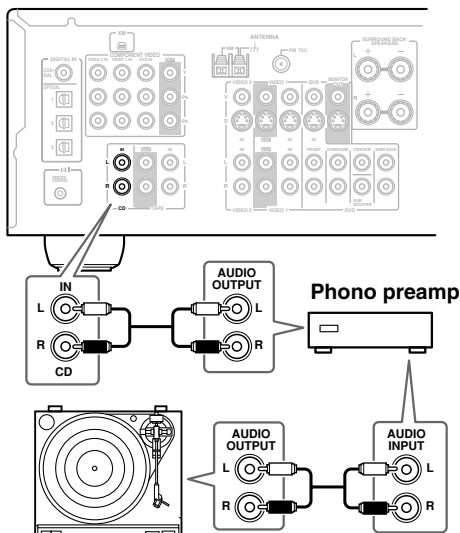

### ■ Turntable with an MC (Moving Coil) Cartridge

An MC head amp and phono preamp are necessary to connect a turntable with an MC (Moving Coil) cartridge.

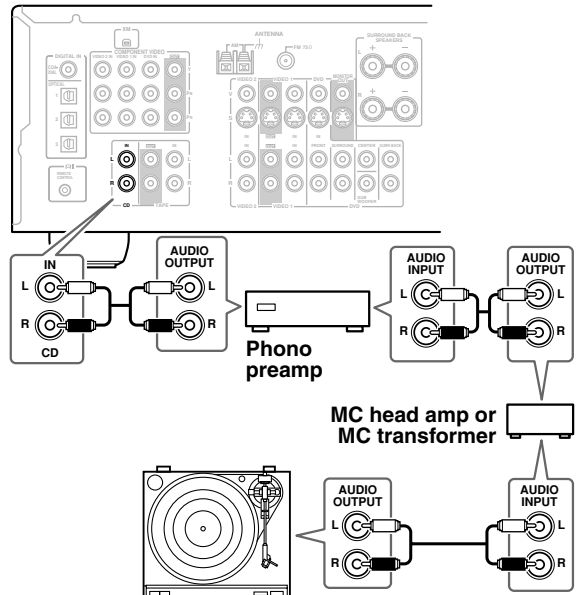

### Connecting an HDD-compatible Component

As of this printing, the Onkyo Remote Interactive Dock is the only HDD-compatible component available.

#### ■ For HDD-compatible components that support video

Connect your HDD-compatible component's analog audio output jacks and S-Video output jack to the AV receiver's VIDEO 2 IN L/R jacks and VIDEO 2 IN S jack.

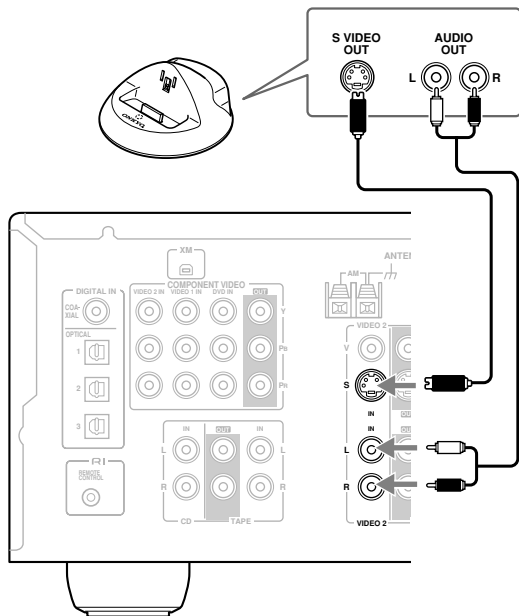

#### ■ For HDD-compatible components that don't support video

Connect your HDD-compatible component's analog audio output jacks to the AV receiver's TAPE IN L/R jacks.

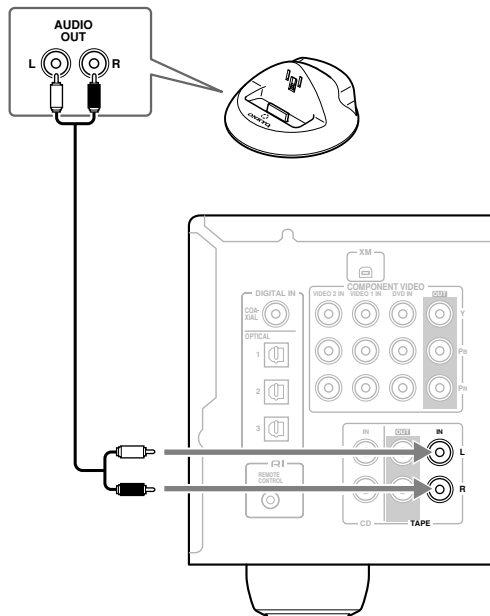

#### Notes:

- Connect the Remote Interactive Dock with an **RI** cable (see page 31).
- Set the Remote Interactive Dock's RI MODE switch to HDD.
- Set the AV receiver's Input Display to HDD (see page 33).
- Refer to the Remote Interactive Dock's instruction manual.

## Connecting Your Components—Continued

### Connecting a Cassette, CDR, MiniDisc, or DAT Recorder

#### Step 1:

Choose a connection that matches the recorder (**a**, **b**, or **c**), and then make the connection.

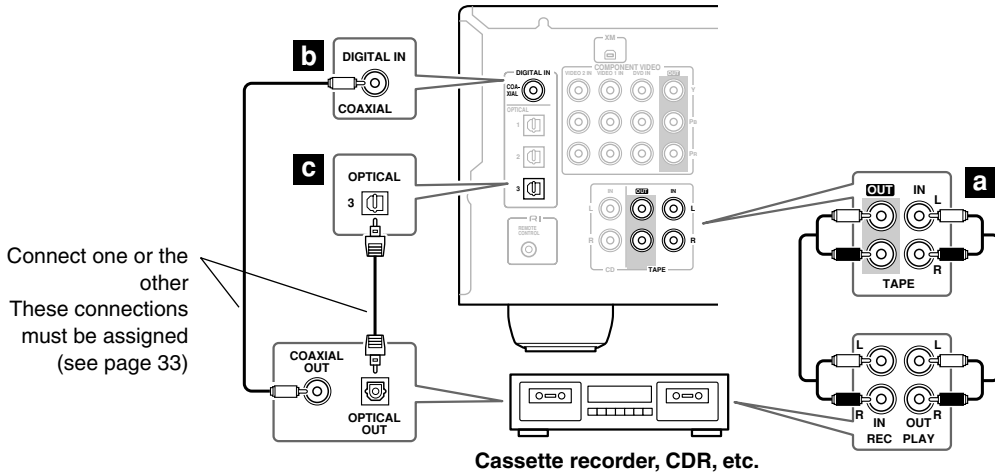

- With connection **a**, you can listen via speaker set B.
- To connect the recorder digitally, use connections **a** and **b**, or **a** and **c**.

| Connection | AV receiver                 | Signal flow | Cassette/CDR/MD/DAT recorder                      |
|------------|-----------------------------|-------------|---|
| <b>a</b>   | TAPE IN L/R<br>TAPE OUT L/R | ←<br>⇒      | Analog audio L/R output<br>Analog audio L/R input |
| <b>b</b>   | DIGITAL IN COAXIAL          | ←           | Digital coaxial output                            |
| <b>c</b>   | DIGITAL IN OPTICAL 3        | ←           | Digital optical output                            |

### Connecting the Power Cord of Another Component

The AV receiver has an AC outlet on its rear panel for connecting the power cord of another AV component. The other component's power switch can then be left in the ON position so that it turns on or off when the AV receiver is set to On or Standby.

#### Caution:

- Make sure that the capacity of the component that you connect to the AC OUTLET does not exceed the stated capacity (e.g., 100 W).

#### Notes:

- Onkyo components connected via **R1** should be connected directly to a wall outlet, not the AV receiver's AC OUTLET.
- The socket type and capacity depends on the country in which you purchased the AV receiver.

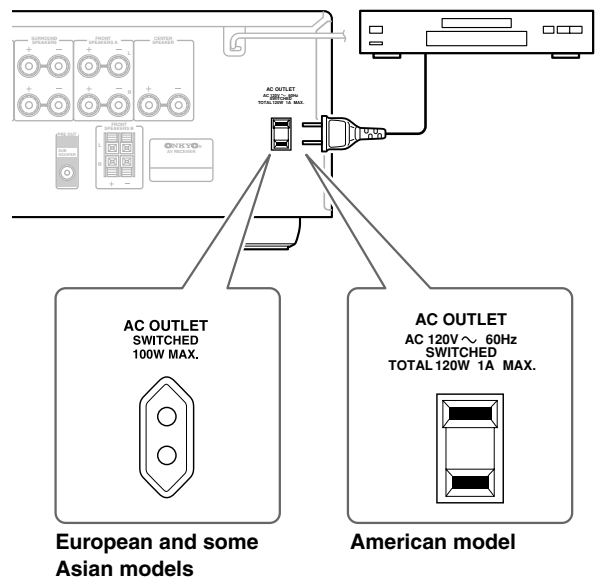

### Connecting Onkyo RI Components

**Step 1:** Make sure that each Onkyo component is connected to the AV receiver with an analog audio cable (connection **a** in the hookup examples) (see pages 22 to 30).

**Step 2:** Make the **RI** connection.

**Step 3:** If you're using an MD, CDR, or HDD component, change the input Display (see page 33).

With **RI** (Remote Interactive), you can use the following special functions:

#### ■ Auto Power On/Standby

When you start playback on a component connected via **RI**, if the AV receiver is on Standby, it will automatically turn on and select that component as the input source. Similarly, when the AV receiver is set to Standby, all components connected via **RI** will also go on Standby. This function will not work on components connected to an AC OUTLET on the AV receiver.

#### ■ Direct Change

When playback is started on a component connected via **RI**, the AV receiver automatically selects that component as the input source. If your DVD player is connected to the AV receiver's multichannel DVD input, you'll need to press the [MULTI CH] button to hear all channels (see page 37), as the Direct Change **RI** function only selects the FRONT DVD IN jacks.

#### ■ Remote Control

You can use the AV receiver's remote controller to control your other **RI**-capable Onkyo components, pointing the remote controller at the AV receiver's remote control sensor instead of the component. You must enter the appropriate remote control code first (page 60).

#### Notes:

- Use only **RI** cables for **RI** connections. **RI** cables are supplied with Onkyo players (DVD, CD, etc.).
- Some components have two **RI** jacks. You can connect either one to the AV receiver. The other jack is for connecting additional **RI**-capable components.
- Connect only Onkyo components to **RI** jacks. Connecting other manufacturer's components may cause a malfunction.
- Some components may not support all **RI** functions. Refer to the manuals supplied with your other Onkyo components.

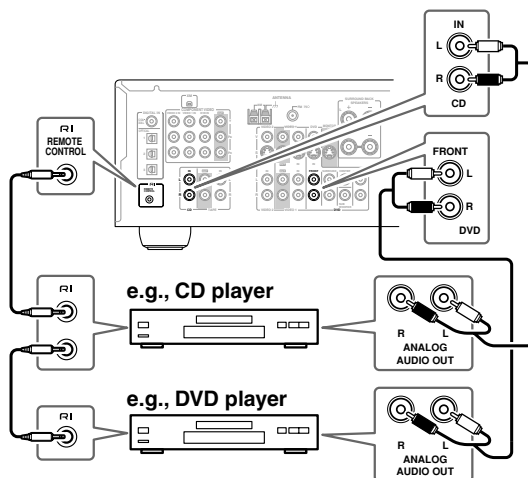

### Connecting the Power Cord

- Connect the AV receiver's power cord to a suitable wall outlet.

#### Notes:

- **Before connecting the power cord, connect all of your speakers and AV components.**
- Turning on the AV receiver may cause a momentary power surge that might interfere with other electrical equipment on the same circuit. If this is a problem, plug the AV receiver into a different branch circuit.

# Turning On the AV Receiver

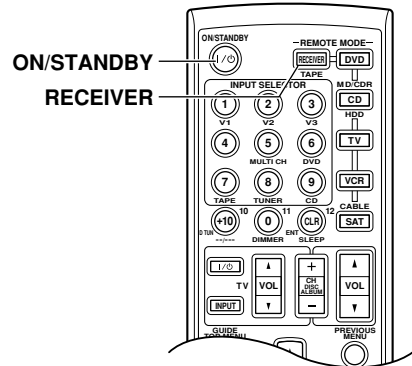
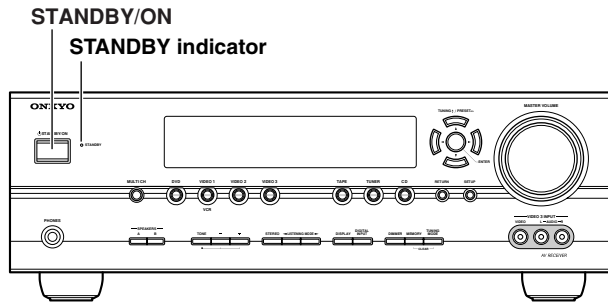

## Turning On and Standby

1

AV receiver



or

Remote controller



Press the [STANDBY/ON] button.

Alternatively, press the remote controller's [RECEIVER] button, followed by the [ON/STANDBY] button.

The AV receiver comes on, the display lights up, and the STANDBY indicator goes off.

To turn the AV receiver off, press the [STANDBY/ON] button, or press the remote controller's [ON/STANDBY] button. The AV receiver will enter Standby mode. To prevent any loud surprises when you next turn on the AV receiver, always turn down the volume before you turn it off.

## Smooth Operation in a Few Easy Steps

To ensure smooth operation, here's a few easy steps to help you configure the AV receiver before you use it for the very first time. These settings only need to be made once.

### ■ Have you connected a component to a digital audio input?

If you have, see "Assigning Digital Inputs to Input Sources" on page 33.

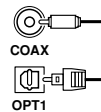

### ■ Have you connected an Onkyo MD recorder, CD recorder, or next generation HDD-compatible component?

If you have, see "Changing the Input Display" on page 33.



### ■ Have you connected any speakers with an impedance of between 4 and 6 ohms?

If you have, see "Minimum Speaker Impedance Setup" on page 34. (Not North American models.)

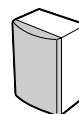

4-6 ohm speakers

### ■ Do the speaker configuration—this is essential!

See "Speaker Configuration" on page 34.





# First Time Setup

## Assigning Digital Inputs to Input Sources

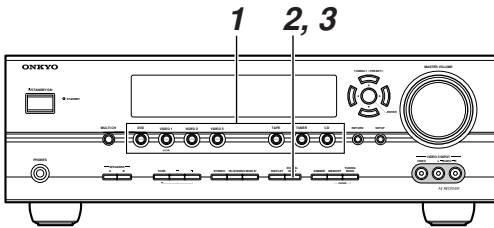

To enjoy Dolby Digital and DTS, you must connect your DVD player to the AV receiver digitally (coaxial or optical).

Here are the default assignments.

| Input selector | Default assignment |
|----------------|--------------------|
| DVD            | COAX               |
| VIDEO 1        | OPT 1              |
| VIDEO 2        | OPT 2              |
| VIDEO 3        | ---                |
| TAPE           | ---                |
| CD             | OPT 3              |

With this function, you can change the digital inputs assign. If, for example, you connect your DVD player to the DIGITAL IN OPTICAL 1 input (OPT1), you'll need to assign it to the DVD input source, as follows.

**1**

**Press the input selector button for the input source that you want to assign.**  
(Digital inputs cannot be assigned to the TUNER input source.)

**2**

**Press the [DIGITAL INPUT] button.**  
The current assignment appears.

DVD                   # COAX

**3**

**Press the [DIGITAL INPUT] button repeatedly to select COAX, OPT1, OPT2, OPT3, or "----" (analog).**

DVD                   # OPT1

**Note:**

Make sure that components connected digitally are configured to output digital audio. Refer to the relevant manuals.

## Changing the Input Display

If you connect an **RI**-capable Onkyo MiniDisc recorder, CD recorder or next generation HDD-compatible component to the TAPE IN/OUT or VIDEO 2 IN jacks, for **RI** to work properly, you must change this setting.

This setting can only be changed on the AV receiver.

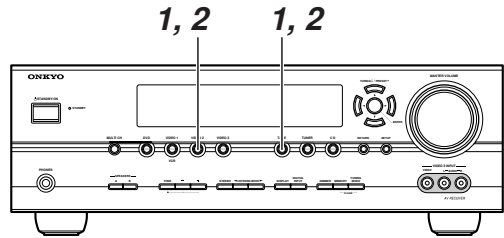

**1**

**Press the [TAPE] or [VIDEO 2] input selector button so that "TAPE" or "VIDEO2" appears on the display.**

TAPE

VIDEO2

**2**

**Press and hold down the [TAPE] or [VIDEO 2] input selector button (about 3 seconds) to change the setting.**  
Repeat this step to select MD, CDR, or HDD.  
For the TAPE input selector, the setting changes in this order:  
TAPE → MD → CDR → HDD  
For the VIDEO 2 input selector, the setting changes in this order:  
VIDEO 2 ↔ HDD

**Note:**

HDD can be selected for the TAPE input selector or VIDEO 2 input selector, but not both at the same time.

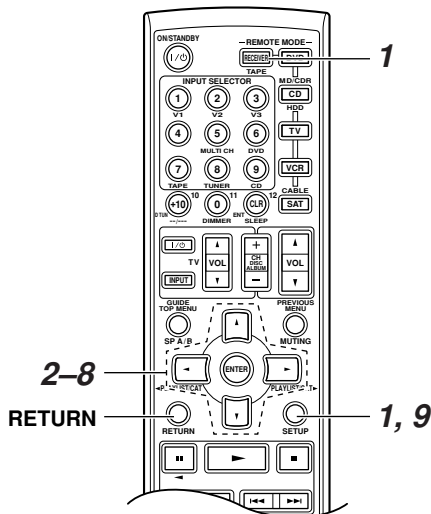

### Minimum Speaker Impedance Setup (not North American model)

If the impedance of any of the connected speakers is 4 ohms or more but less than 6, set the minimum speaker impedance to “4 ohms.”

**Note:**

Before you change this setting, turn down the volume.

- 1** Press the [RECEIVER] button, followed by the [SETUP] button.
- 2** Use the Up and Down [▲]/[▼] buttons to select “0. Hardware Setup,” and then press [ENTER].
- 3** Use the Left and Right [◀]/[▶] buttons to select the setting for “Impedance.”
  - 4 ohms:** Select if the impedance of any connected speaker is 4 ohms or more but less than 6.
  - 6 ohms:** Select if the impedances of all connected speakers are between 6 and 16 ohms.

Press the [RETURN] button to go to step 2 of the “Speaker Configuration” (next column).

**Note:**

- This procedure can also be performed on the AV receiver by using the [SETUP], [ENTER], and arrow buttons.

### Speaker Configuration

This section explains how to specify your speaker configuration.

For speakers with a cone diameter larger than 6-1/2 inches (16 cm), specify **Large** (full band). For those with a smaller diameter, specify **Small** (default crossover 100 Hz).

The crossover frequency can be changed on page 55.

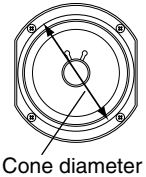

- 1** Press the [RECEIVER] button, followed by the [SETUP] button.
- 2** Use the Up and Down [▲]/[▼] buttons to select “1. SP Config,” and then press [ENTER].
 

1. SP Config
- 3** While the “Subwoofer” setting is selected, use the Left and Right [◀]/[▶] buttons to select **Yes** or **No**.
  - Yes:** Select if a subwoofer is connected.
  - No:** Select if no subwoofer is connected.
- 4** Use the Down [▼] button to select “Front,” and then use the Left and Right [◀]/[▶] buttons to select **Small** or **Large**.
  - Small:** Select if the front speakers are small.
  - Large:** Select if the front speakers are large.

**Note:**

  - If the Subwoofer setting in step 3 is set to No, this setting is fixed at Large and does not appear.

5

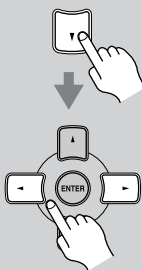

Use the Down [▼] button to select “Center,” and then use the Left and Right [◀]/[▶] buttons to select **Small, Large, or None.**

**Small:** Select if the center speaker is small.

**Large:** Select if the center speaker is large.

**None:** Select if no center speaker is connected.

**Note:**

- If the Front setting in step 4 is set to Small, the Large option cannot be selected.

6

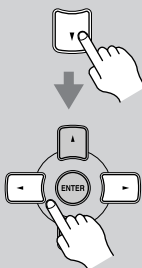

Use the Down [▼] button to select “Surround,” and then use the Left and Right [◀]/[▶] buttons to select **Small, Large, or None.**

**Small:** Select if the surround speakers are small.

**Large:** Select if the surround speakers are large.

**None:** Select if no surround speakers are connected.

**Note:**

- If the Front setting in step 4 is set to Small, the Large option cannot be selected.

7

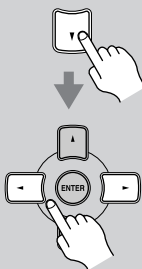

Use the Down [▼] button to select “Surr Back,” and use the Left and Right [◀]/[▶] buttons to select **Small, Large, or None.**

**Small:** Select if the surround back speakers are small.

**Large:** Select if the surround back speakers are large.

**None:** Select if no surround back speakers are connected.

**Notes:**

- If the Surround setting in step 6 is set to None, this setting does not appear.
- If the Surround setting in step 6 is set to Small, the Large option cannot be selected.

8

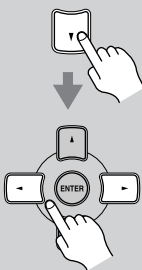

Use the Down [▼] button to select “Surr Back Ch,” and use the Left and Right [◀]/[▶] buttons to select **2ch or 1ch.**

**2ch:** Select if two (left and right) surround back speakers are connected.

**1ch:** Select if one surround back speaker is connected.

**Note:**

- If the Surround and Surr Back settings in steps 6 and 7 are set to None, this setting does not appear.

9



Press the [SETUP] button.

Setup closes.

**Testing the Speakers**

To test that all of the speakers are working properly, press the remote controller’s [TEST TONE] button.

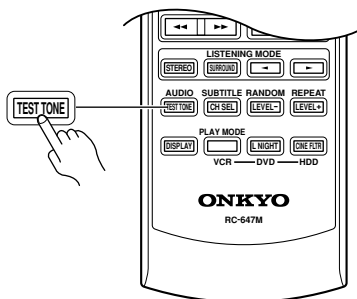

The test tone will be output by each speaker in turn and the name of each speaker will appear on the display. To turn off the test tone, press the [TEST TONE] button again.

- If the test tone is not produced by a speaker, or it’s produced by a speaker other than that shown on the display, you may have wired the speakers incorrectly and you should check your connections (see page 17).
- If the test tone is not produced by a speaker and its name does not appear on the display, you may have set the speaker configuration incorrectly (see page 34).
- Testing cannot be performed while speaker set B is on or a pair of headphones is connected.

# Playing Your AV Components

## Basic AV Receiver Operation

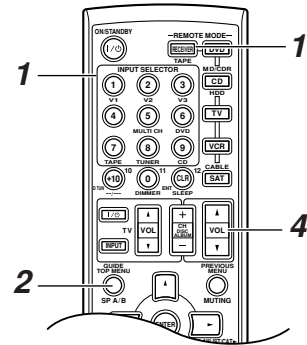
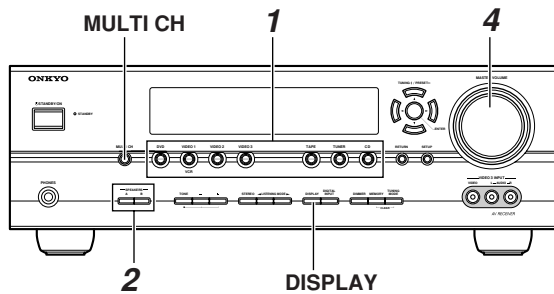

|   |  |
|---|--|
| <p><b>1</b></p> <p>Remote controller</p> <p>AV receiver</p> | <p><b>Use the AV receiver's input selector buttons to select the input source.</b></p> <p><b>To select the input source with the remote controller, press the [RECEIVER] REMOTE MODE button, and then use the INPUT SELECTOR buttons.</b></p> <p>On the remote controller, the [V1], [V2], and [V3] buttons select the VIDEO 1, VIDEO 2, and VIDEO 3 input sources respectively.</p>   |
| <p><b>2</b></p> <p>Remote controller</p> <p>AV receiver</p> | <p><b>To turn the speakers on or off, use the AV receiver's SPEAKERS [A] and [B] buttons, or use the remote controller's [SP A/B] button.</b></p> <p>Pressing the remote controller's [SP A/B] button cycles through the following settings: Speaker Set A → Speaker Set A&amp;B → Speaker Set B → Off.</p> <p>Note that while speaker set B is on, speaker set A is reduced to 5.1-channel playback.</p> <div style="border: 1px solid black; padding: 5px; display: inline-block;"> <span style="border: 1px solid black; padding: 2px;">A</span> <span style="border: 1px solid black; padding: 2px;">B</span> — Indicators         </div> <p>See page 6 for more information about speaker sets A and B.</p> |
| <p><b>3</b></p>   | <p><b>Start playback on the source component.</b></p> <p>To watch a DVD or other video source, on your TV, select the video input that's connected to the AV receiver's MONITOR OUT jack.</p>  |
| <p><b>4</b></p> <p>Remote controller</p> <p>AV receiver</p> | <p><b>To adjust the volume, use the MASTER VOLUME control, or the remote controller's [VOL] button.</b></p> <p>The volume can be set to MIN, 1 through 79, or MAX. Since the AV receiver is designed for home theater enjoyment, it has a wide volume range for precise adjustment.</p>  |
| <p><b>5</b></p>   | <p><b>Select a suitable listening mode and enjoy!</b></p> <p>See "Using the Listening Modes" on page 48.</p>   |

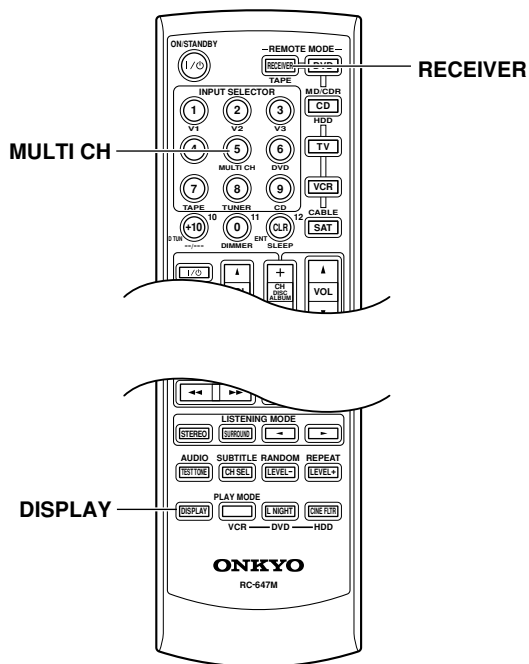

## Displaying Source Information

You can display various information about the current input source as follows.

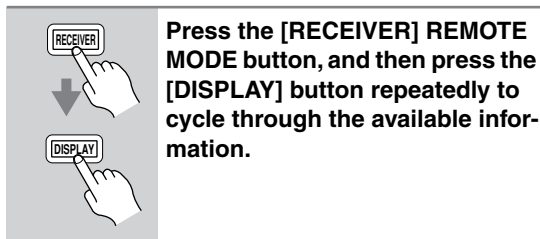

The following information can typically be displayed:

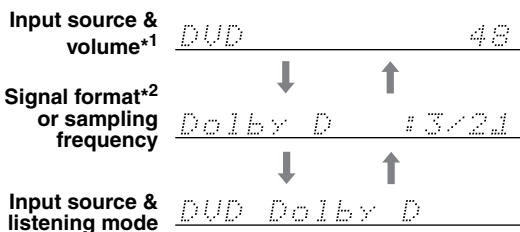

- \*1 When AM or FM radio is used, the band, preset number, and frequency are displayed.
- \*2 If the input signal is analog, or AM or FM radio is selected, no format information is displayed. If the input signal is PCM, the sampling frequency is displayed. If the input signal is digital but not PCM, the signal format is displayed. Information is displayed for about 3 seconds, then the previous display reappears.

### Note:

- The listening mode is displayed only when speaker set A is on.

## Using the Multichannel DVD Input

The multichannel DVD input is for connecting a component with a 7.1-channel analog audio output, such as a DVD-Audio or SACD-capable DVD player, or an MPEG decoder. See page 24 for hookup information.

Audio from the multichannel DVD input will now be used for the DVD input source.

### Note:

- While the multichannel DVD input is selected, the Speaker Configuration settings on page 34 are ignored, and signals from the multichannel input are fed to the speakers as they are.

## Interpreting Surround Channel Information

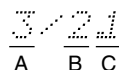

- A: The number of front channels (front left, front right, and center).
- B: The number of surround channels (surround left and surround right). If there's surround back channel information, this number will be 3.
- C: LFE channel for subwoofer (1 means yes).

# Listening to the Radio

## Listening to AM/FM stations

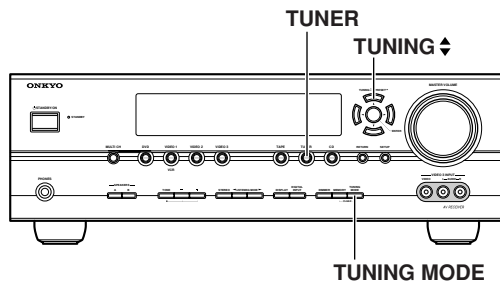

With the built-in tuner, you can enjoy AM and FM radio stations.

**1**  Use the [TUNER] input selector button to select AM or FM. In this example, FM has been selected.

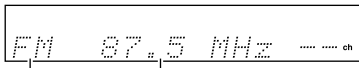

Band      Frequency

(Actual display depends on country.)



### ■ AM Frequency Step Setup (not North America and Europe)

You must specify the AM frequency step used in your area. Note that when this setting is changed, all radio presets are deleted.

- 1** Press the [SETUP] button, use the Up and Down [▲]/[▼] buttons to select "0. Hardware Setup," and then press [ENTER].
- 2** Use the Up and Down [▲]/[▼] buttons to select "AM Freq," and then use the Left and Right [◀]/[▶] buttons to select:
  - 10 kHz:** Select if 10 kHz steps are used in your area.
  - 9 kHz:** Select if 9 kHz steps are used in your area.
- 3** Press the [SETUP] button. Setup closes.

## Tuning into AM/FM Radio Stations

### ■ Auto Tuning Mode

- 1**  Press the [TUNING MODE] button so that the AUTO indicator appears on the display.
- 2**  Press the TUNING Up or Down [▲]/[▼] button. Searching stops when a station is found.

### ■ Manual Tuning Mode

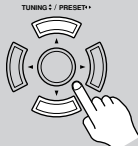
- 1**  Press the [TUNING MODE] button so that the AUTO indicator disappears from the display.
- 2**  Press and hold the TUNING Up or Down [▲]/[▼] button. The frequency stops changing when you release the button. Press the buttons repeatedly to change the frequency one step at a time.

The American model changes FM frequency in 0.2 MHz steps, 10 kHz steps for AM. For other models it's 0.05 MHz steps for FM and 9 kHz (or 10 kHz) steps for AM.

When tuned into a station, the TUNED indicator appears. When tuned into a stereo FM station, the FM STEREO indicator also appears.

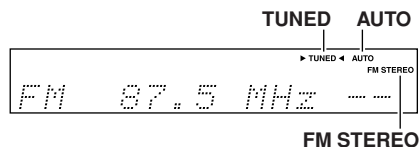

### Tuning into Weak FM Stereo Stations

If the signal from a stereo FM station is weak, it may be impossible to get good reception. In this case, switch to Manual Tuning mode and listen to the station in mono.

#### Note:

- You can also use the remote controller's Up and Down [▲]/[▼] buttons to tune the radio.

## Listening to the Radio—Continued

### ■ Tuning into Stations by Frequency

You can tune into AM and FM stations directly by entering the appropriate frequency.

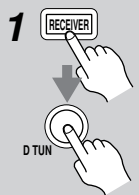
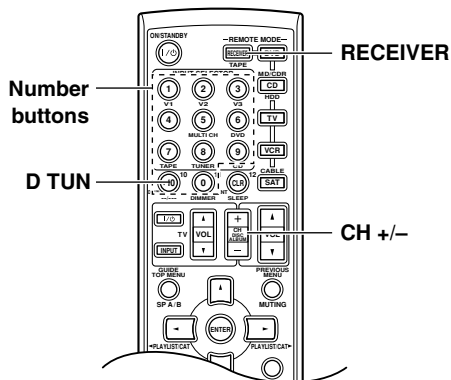

**1** Press the [RECEIVER] button, followed by the [D TUN] button.



(Actual display depends on country.)  
The [RECEIVER] button flashes.

**2**

Within 8 seconds, use the number buttons to enter the frequency of the radio station.

For example, to tune to 87.5 (FM), press 8, 7, 5.

**Note:** While the [RECEIVER] button is flashing, the input source cannot be changed by using the remote controller.

**2**

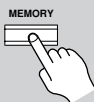

Press the [MEMORY] button.

The MEMORY indicator appears and the preset number flashes.

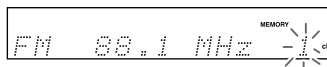

**3**



While the MEMORY indicator is displayed (about 8 seconds), use the PRESET [◀]/[▶] buttons to select a preset from 1 through 40.

**4**

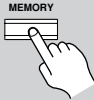

Press the [MEMORY] button again to store the station or channel.

The station or channel is stored and the preset number stops flashing.

Repeat this procedure for all of your favorite AM/FM radio stations and XM channels.

### ■ Selecting Presets



**1** To select a preset, use the PRESET [◀]/[▶] buttons, or the remote controller's CH [+/-] button.



### ■ Deleting Presets



**1** Select the preset that you want to delete.

See the previous section.

**2**

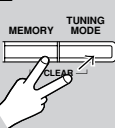

While holding down the [MEMORY] button, press the [TUNING MODE] button.

The preset is deleted and its number disappears from the display.

### Presetting AM/FM Stations and XM Channels

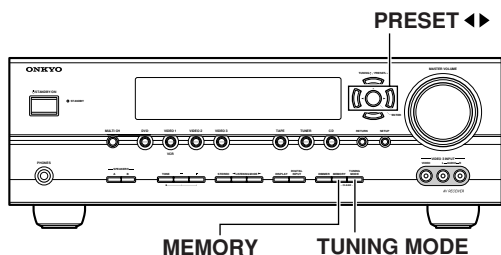

You can store a combination of up to 40 of your favorite AM/FM radio stations and XM channels as presets.

**1**

Tune into the AM/FM station or XM channel that you want to store as a preset.

See page 42 to select XM channels.

### Using RDS (European Models Only)

RDS only works with European models and only in areas where RDS broadcasts are available.

When tuned into an RDS station, the RDS indicator appears.

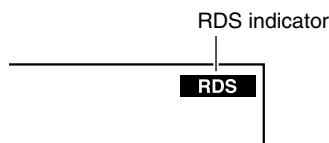

#### ■ What is RDS?

RDS stands for *Radio Data System* and is a method of transmitting data in FM radio signals. It was developed by the European Broadcasting Union (EBU) and is available in most European countries. Many FM stations use it these days. In addition to displaying text information, RDS can also help you find radio stations by type (e.g., news, sport, rock, etc.).

The AV receiver supports four types of RDS information:

#### **PS (Program Service)**

When tuned to an RDS station that's broadcasting PS information, the station's name will be displayed. Pressing the [DISPLAY] button will display the frequency for 3 seconds.

#### **RT (Radio Text)**

When tuned to an RDS station that's broadcasting text information, the text will be shown on the display (see page 41).

#### **PTY (Program Type)**

This allows you to search for RDS radio stations by type (see page 41).

#### **TP (Traffic Program)**

This allows you to search for RDS radio stations that broadcast traffic information (see page 41).

#### **Notes:**

- In some cases, the text characters displayed on the AV receiver may not be identical to those broadcast by the radio station. Also, unexpected characters may be displayed when unsupported characters are received. This is not a malfunction.
- If the signal from an RDS station is weak, RDS data may be displayed intermittently or not at all.

### RDS Program Types (PTY)

| Type                     | Display  | Description   |
|--------------------------|----------|---|
| None                     | NONE     | No program type.  |
| News reports             | NEWS     | Reports on current events and happenings.   |
| Current affairs          | AFFAIRS  | Topical reporting of current affairs, often with a wider range of topics than news reports.                 |
| Information              | INFO     | General information such as weather forecasts, consumer affairs, medical help, etc.                         |
| Sport                    | SPORT    | Live sports action, sports news, and interviews.  |
| Education                | EDUCATE  | Formal educational programs.  |
| Drama                    | DRAMA    | Radio plays and serials.  |
| Culture                  | CULTURE  | Cultural programs (including religious affairs).  |
| Science and technology   | SCIENCE  | Programs about the natural sciences and technology.   |
| Varied                   | VARIED   | Talk programs not covered by the above categories (e.g., quizzes, panel games, and comedy).                 |
| Pop music                | POP M    | Popular commercial music, usually from past or present sales charts (e.g., Top 40).                         |
| Rock music               | ROCK M   | Popular music with an alternative appeal, often not appearing on sales charts.                              |
| Middle of the road music | M.O.R.M  | Easy listening music (as opposed to Pop, Rock, or Classical).   |
| Light classics           | LIGHT M  | Classical music for general rather than specialist appreciation.  |
| Serious classics         | CLASSICS | Performances of major orchestral works, symphonies, chamber music, etc. (including the Grand Opera).        |
| Other music              | OTHER M  | Music styles not covered by the above categories (e.g., Jazz, Rhythm and Blues, Folk, Country, and Reggae). |
| Alarm                    | ALARM    | When an RDS station is making an emergency broadcast, ALARM will flash on the display.                      |



## Displaying Radio Text (RT)

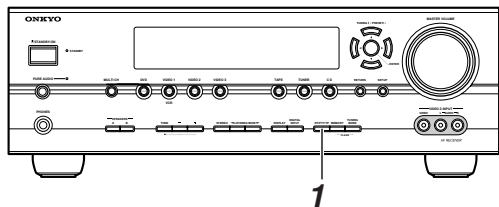

When tuned to an RDS station that's broadcasting text information, the text can be displayed.

**1**



**Press the [RT/PTY/TP] button once.**

The RT information scrolls across the display.

### Notes:

- The message "Waiting" may appear while the AV receiver waits for the RT information.
- If the message "No Text Data" appears on the display, no RT information is available.

## Finding Stations by Type (PTY)

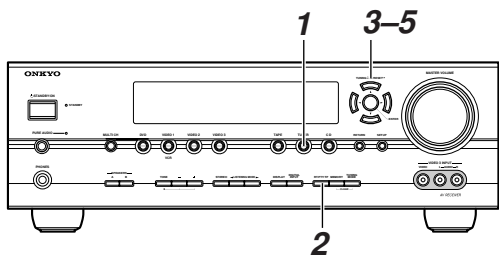

You can search for radio stations by type.

**1**



**Use the [TUNER] input selector button to select FM.**

**2**



**Press the [RT/PTY/TP] button twice.**

The current program type appears on the display.

**3**



**Use the PRESET [◀/▶] buttons to select the type of program you want.**

See the table on page 40.

**4**

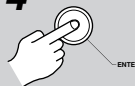

**To start the search, press [ENTER].**

The AV receiver searches until it finds a station of the type you specified, at which point it stops briefly before continuing with the search.

**5**

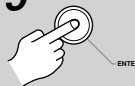

**When a station you want to listen to is found, press [ENTER].**

If no stations are found, the message "Not Found" appears.

## Listening to Traffic News (TP)

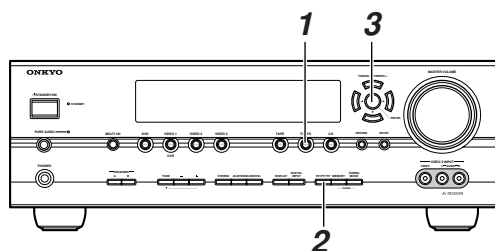

You can search for stations that broadcast traffic news.

**1**



**Use the [TUNER] input selector button to select FM.**

**2**



**Press the [RT/PTY/TP] button three times.**

If the current radio station is broadcasting TP (Traffic Program), "[TP]" will appear on the display, and traffic news will be heard as and when it's broadcast. If "TP" without square brackets appears, this means that the station is not broadcasting TP.

**3**



**To locate a station that is broadcasting TP, press [ENTER].**

The AV receiver searches until it finds a station that's broadcasting TP.

If no stations are found, the message "Not Found" appears.

### Listening to XM Satellite Radio® (North American Models Only)

#### Important XM Radio Information

To receive XM Radio on this receiver you need to purchase an optional XM Passport System and subscribe to XM's paid programming. Please note that XM is currently only licensed to provide service to the contiguous 48 United States (not available in Alaska and Hawaii) and portions of Canada. XM Radio service is not currently available in Mexico or any other region outside the continental U.S. and portions of Canada. For updates on service availability please visit XM's website at <http://www.xmradio.com> or <http://www.xmradio.ca>

#### Note:

Hardware and required basic monthly subscription sold separately. Premium Channels available at additional monthly cost. Installation costs and other fees and taxes, including a one-time activation fee may apply. Subscription fee is consumer only. All fees and programming subject to change.

#### About XM Radio:

There is a world beyond AM and FM. It is XM Satellite Radio. XM offers more than 160 digital channels of audio entertainment, including 100% commercial-free music channels, in the top markets in the U.S. Channels with frequent explicit language are indicated with an XL. Channel blocking is available for XM radio receivers by calling 1-800-XMRADIO.

#### About XM Canada:

XM Canada offers the most commercial-free music – and engaging talk show programs. XM Canada creates original content that reflects our unique Canadian culture and broadcasts it throughout North America.

Canadian Satellite Radio Inc. offers its satellite radio service and operates under the XM Canada™ brand. XM Canada has an exclusive Canadian licence from XM Satellite Radio Inc.

For more information about XM Canada, visit [www.xmradio.ca](http://www.xmradio.ca) or call 1-877-GET-XMSR

#### A warning against reverse engineering:

It is prohibited to copy, decompile, disassemble, reverse engineer, or manipulate any technology incorporated in receivers compatible with the XM Satellite Radio system. Furthermore, the AMBE® voice compression software included in this product is protected by intellectual property rights including patent rights, copyrights, and trade secrets of Digital Voice Systems, Inc. The user of this or any other software contained in an XM Radio is explicitly prohibited from attempting to copy, decompile, reverse engineer, or disassemble the object code, or in any other way convert the object code into human-readable form. The software is licensed solely for use within this product.

### Connecting the XM Passport System

The XM Passport System is sold separately. You can purchase the *XM Passport System* from the XM Web site at: <http://www.xmradio.com> (U.S.A.)  
<http://www.xmradio.ca> (Canada)

Connect the Passport System to the XM antenna jack on the rear panel.

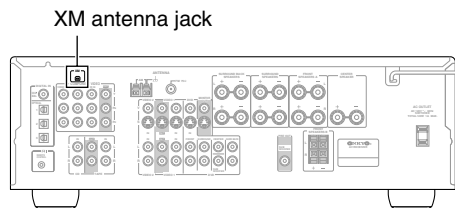

Put the XM Passport System by a southerly facing window, with nothing obstructing its path to the sky.

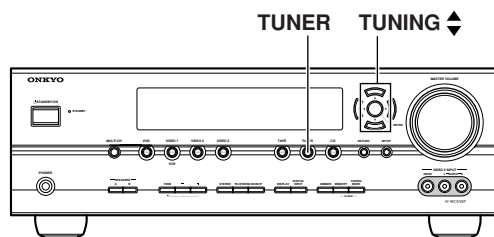

### Selecting XM Satellite Radio

1



Press the [TUNER] input selector button repeatedly to select XM.

If "CHECK ANTENNA" appears on the display, make sure the XM Passport System is connected properly.

## Signing Up for XM Satellite Radio

Before you can use XM Satellite Radio, you must first sign up for an account. You'll need a major credit card and your *XM Satellite Radio ID*, which you can get from the AV receiver, as explained below, or from the Passport System package and itself.

|          |  |
|----------|--|
| <b>1</b> | <p><b>Use the TUNING Up and Down [▲]/[▼] buttons to select channel 0.</b></p> <p>Your XM Satellite Radio ID number is displayed. Write it below.</p> <p style="text-align: center;">ID _____</p>   |
| <b>2</b> | <p><b>To sign up, go to:</b><br/> <a href="http://activate.xmradio.com">http://activate.xmradio.com</a><br/> <b>Or call: 1-800-967-2346</b></p> <p><b>For XM Canada, go to:</b><br/> <a href="http://xmradio.ca">http://xmradio.ca</a><br/> <b>Or call: 1-877-GET-XMSR</b></p> |

### Notes:

- Channel 0 cannot be selected in Category Search mode. You must select Channel Search mode (see page 43).
- The following letters are not used in XM Satellite Radio IDs: I, O, S, F.

## Selecting XM Radio Channels

There are three ways to select XM radio channels:

- **Channel Search mode:** select any channel.
- **Category Search mode:** select channels by category.
- **Direct tuning:** enter channel number.

### Note:

You can't select Channel Search or Category Search mode, while the Tuning Arrow ► ◀ indicators are flashing, as tuning is in progress.

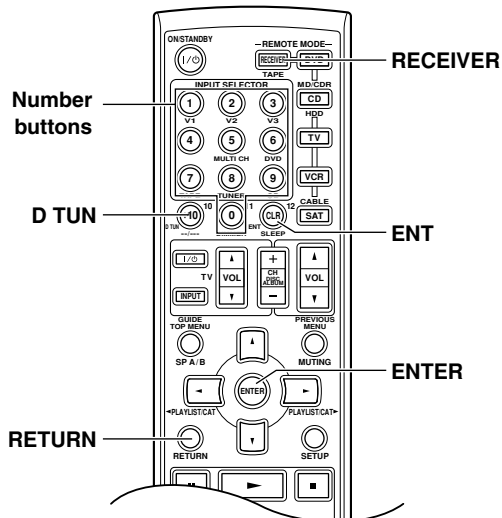

## Channel Search Mode

|          |   |
|----------|---|
| <b>1</b> | <p><b>Press the [RECEPTOR] button, followed by the [ENTER] button to select "Channel Search" mode.</b></p> <p style="text-align: center;">ChannelSearch</p>   |
| <b>2</b> | <p><b>Use the Up and Down [▲]/[▼] buttons to select a channel.</b></p> <p style="text-align: center;">050 The Loft</p> <p style="text-align: center;">Channel number    Channel name</p> <p>You can also use the Left and Right [◀]/[▶] buttons to select a category.</p> |

## Category Search Mode

|          |   |
|----------|---|
| <b>1</b> | <p><b>Press the [RECEPTOR] button, followed by the [ENTER] button to select "Category Search" mode.</b></p> <p style="text-align: center;">CategorySearch</p> |
| <b>2</b> | <p><b>Use the Left and Right [◀]/[▶] buttons to select a category, and use the Up and Down [▲]/[▼] buttons to select a channel in that category.</b></p>      |



## Direct Tuning

You can select an XM radio channel directly by entering its number.

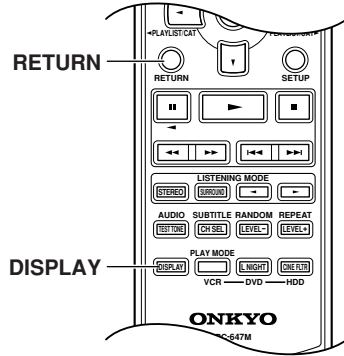
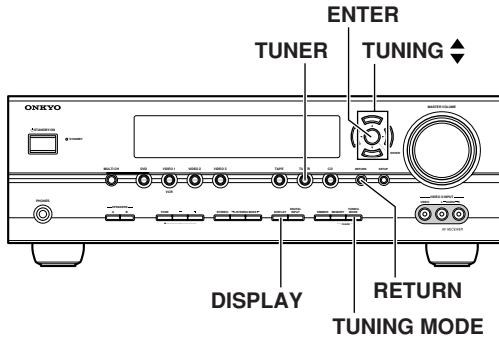

|          |   |
|----------|---|
| <b>1</b> | <p><b>Press the [RECEPTOR] button, followed by the [D TUN] button. The [RECEPTOR] button flashes.</b></p> <p style="text-align: center;">XM</p>   |
| <b>2</b> | <p><b>Within 8 seconds, use the number buttons to enter the channel number.</b></p> <p>The channel is selected.</p> <p>For example, to select channel #20, press 0, 2, 0, or 2, 0, [ENT].</p> <p><b>Note:</b> While the [RECEPTOR] button is flashing, the input source cannot be changed by using the remote controller.</p> |

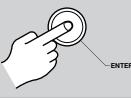



### Selecting XM Channels from the Front Panel:

- 1**  Press the [TUNING MODE] button to select “Channel Search” or “Category Search” mode.
- 2**  Press the [ENTER] button repeatedly to select a category.
- 3**  Use the TUNING Up and Down [▲]/[▼] buttons to select a channel.  
 In Channel Search mode, you can select any channel.  
 In Category Search mode, you can only select channels from the currently selected category.

### Selecting the Previous Channel:

- 1**   To listen to the previously selected XM channel, press the [RETURN] button.

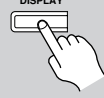
### Displaying XM Radio Information

- 1**   Press the [DISPLAY] button repeatedly to cycle through the available information.

The following information can be displayed:

|                                |                               |
|--------------------------------|-------------------------------|
| Channel name                   | <code>XM The Loft</code>      |
| Channel number & preset number | <code>XM 050 5</code>         |
| Category                       | <code>CAT &gt;Rock</code>     |
| Artist                         | <code>NAME&gt;Coldplay</code> |
| Song title                     | <code>TITL&gt;Clocks</code>   |
| Listening mode                 | <code>XM Stereo</code>        |

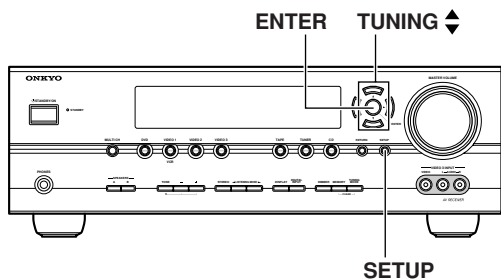

#### Notes:

- If the category, artist, or song title is not available, “- -” will be displayed instead.
- The listening mode is displayed only when speaker set A is on.



## Positioning the XM Passport System

You can check the signal strength of the XM radio signal and adjust the position of the XM Passport System accordingly.

|   |   |
|---|---|
| <b>1</b><br> | <p><b>On the AV receiver, press the [SETUP] button.</b></p>   |
| <b>2</b><br> | <p><b>Use the Up and Down [▲]/[▼] buttons to select “5. ANT Aiming,” and then press [ENTER].</b></p> <div style="border: 1px solid black; padding: 5px; text-align: center; margin-top: 10px;">             5.ANT Aiming         </div>   |
| <b>3</b>  | <p><b>Adjust the position of the XM Passport System so that the SAT signal strength bar is as long as possible.</b></p> <div style="border: 1px solid black; padding: 5px; text-align: center; margin-top: 10px;">             SAT: [#####-----]         </div> <p>If you can't receive a satellite signal, press the Down [▼] button to display the terrestrial (TER) signal strength meter and adjust your XM Passport System so that the bar is as long as possible.</p> <p>Terrestrial signals are only available in certain areas.</p> <div style="border: 1px solid black; padding: 5px; text-align: center; margin-top: 10px;">             TER: [#####-----]         </div> <p>So long as the signal strength is good, you can enjoy XM Radio by using either satellite or terrestrial reception.</p> |

## XM Radio Messages

The following messages may appear while using XM radio.

CHECK ANTENNA

The XM Passport System is not connected properly. Check the connection.

UPDATING

The XM user encryption code is being updated. Please wait.

NO SIGNAL

The signal is too weak. Check the XM Passport System connection and reposition it for the best reception.

LOADING

The AV receiver is tuning or decoding audio or text data. Please wait.

OFF AIR

The XM channel you selected is not currently broadcasting. Select another channel.

# Common Functions

This section explains functions that can be used with any input source.

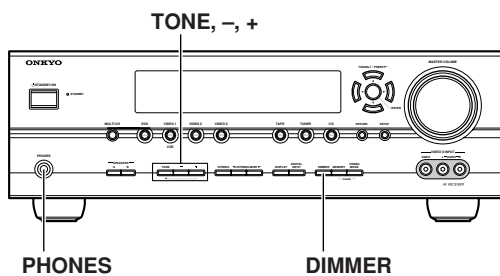
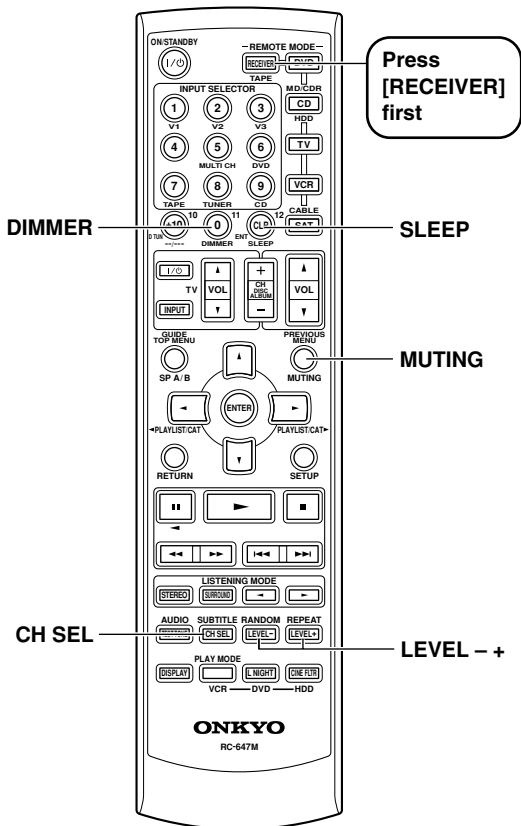

## Setting the Display Brightness

You can adjust the brightness of the display.



Press the remote controller's [DIMMER] button repeatedly to select: dim, dimmer, or normal brightness.

Alternatively, you can use the AV receiver's [DIMMER] button (not European models).

## Adjusting the Bass and Treble

You can adjust the bass and treble for the front speakers, except when the Direct or Pure Audio (not North American models) listening mode is selected.

1



Press the AV receiver's [TONE] button repeatedly to select either Bass or Treble.

2

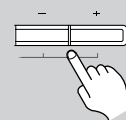

Use the TONE [-]/[+] buttons to adjust.

### ■ Bass

You can boost or cut low-frequency sounds output by the front speakers from -10 dB to +10 dB in 2 dB steps.

### ■ Treble

You can boost or cut high-frequency sounds output by the front speakers from -10 dB to +10 dB in 2 dB steps.

### Note:

- To bypass the bass and treble tone circuits, select the Direct or Pure Audio (not North American model) listening mode.

## Muting the AV Receiver

You can temporarily mute the output of the AV receiver.



Press the remote controller's [MUTING] button.

The output is muted and the MUTING indicator flashes on the display.



To unmute the AV receiver, press the remote controller's [MUTING] button again, or adjust the volume. The output is unmuted and the MUTING indicator goes off. Muting is cancelled when the AV receiver is set to Standby.

### Using the Sleep Timer

With the sleep timer, you can set the AV receiver so that it turns off automatically after a specified period.



**Press the remote controller's [SLEEP] button repeatedly to select the required sleep time.**

You can set the sleep time from 90 to 10 minutes in 10 minute steps.

The SLEEP indicator appears on the display when the sleep timer has been set, as shown. The specified sleep time appears on the display for about 5 seconds, then the previous display reappears.

SLEEP indicator

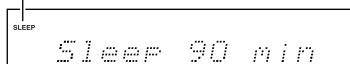

**To cancel the sleep timer,** press the [SLEEP] button repeatedly until the SLEEP indicator disappears.

**To check the remaining sleep time,** press the [SLEEP] button. Note that if you press the [SLEEP] button while the sleep time is being displayed, you'll shorten the sleep time by 10 minutes.

### Using Headphones

For private listening, you can connect a pair of stereo headphones (1/4-inch phone plug) to the AV receiver's PHONES jack.

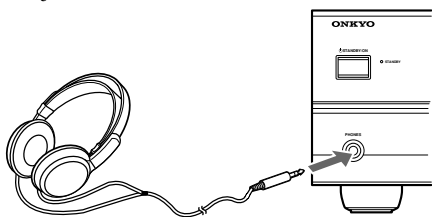

#### Notes:

- Always turn down the volume before connecting your headphones.
- Speaker sets A and B are turned off while the headphones plug is inserted in the PHONES jack.
- When you connect a pair of headphones, the listening mode is set to Stereo, unless it was set to Pure Audio, Mono, Stereo, or Direct, in which case it stays the same.
- When the multichannel DVD input is selected, only the front left and front right channels can be heard in the headphones.

### Adjusting Speaker Levels

You can adjust the volume of each speaker in speaker set A. These temporary adjustments are cancelled when the AV receiver is set to Standby.

1



**Use the remote controller's [CH SEL] button to select each speaker, and use the [LEVEL-] and [LEVEL+] buttons to adjust the volume.**

You can adjust the volume of each speaker from -12 dB to +12 dB (-15 dB to +12 dB for the subwoofer).



#### Notes:

- You cannot use this function while the AV receiver is muted.
- Speakers that are set to No or None in the Speaker Configuration cannot be adjusted.

#### ■ Speaker Set B

While speaker set B is on, you can adjust the volume of the left and right speakers, from -12 dB to +12 dB.

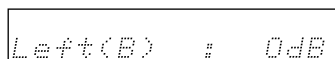

- These settings are stored when the AV receiver is set to Standby.
- While speaker set B is on, you cannot adjust the levels of speaker set A's surround back speakers.

#### ■ Headphones

While a pair of headphones is connected, you can adjust the volume of each headphone speaker, from -12 dB to +12 dB each.

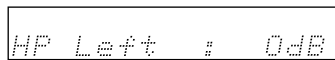

- These settings are stored when the AV receiver is set to Standby.

# Using the Listening Modes

## Selecting Listening Modes

For a description of each listening mode, see “About the Listening Modes” on page 50.

- The Dolby Digital and DTS listening modes can only be selected if your DVD player is connected to the AV receiver with a digital audio connection (coaxial or optical).
- Listening mode availability depends on the format of the current input signal.
- While a pair of headphones is connected, you can select only the Pure Audio (not North American model), Mono, Direct, or Stereo listening mode.
- The listening modes cannot be selected while speaker set A is off.

## Selecting on the AV Receiver

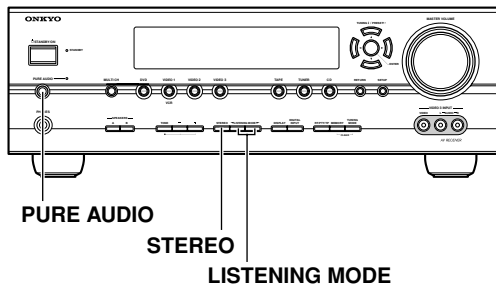

- **[PURE AUDIO] button (not North American model)**  
This button selects the Pure Audio listening mode. When this mode is selected, the AV receiver outputs no video signals and its display is turned off. Pressing this button again will select the previous listening mode.
- **[STEREO] button**  
This button selects the Stereo listening mode.
- **LISTENING MODE [◀/▶] buttons**  
Pressing these buttons repeatedly cycles through all of the listening modes that can be used with the current input source.

## Selecting with the Remote Controller

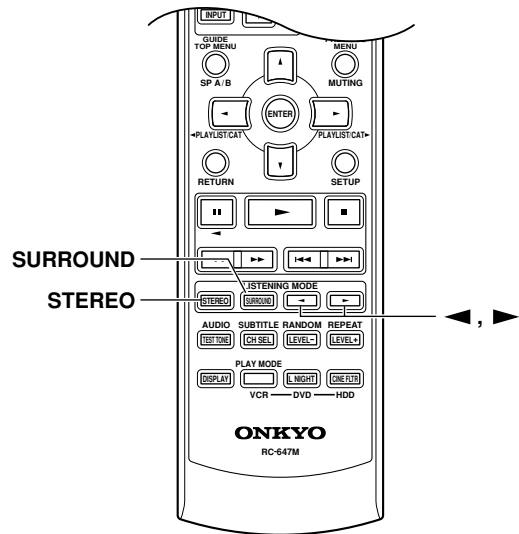

- **[STEREO] button**  
This button selects the Stereo listening mode.
- **[SURROUND] button**  
This button selects the Dolby Digital and DTS listening modes and the Neural Surround listening mode (North American model only).
- **LISTENING MODE [◀/▶] buttons**  
Pressing these buttons repeatedly cycles through all of the listening modes that can be used with the current input source.



## Using the Listening Modes—Continued

The following table shows which listening modes can be used with each input signal format.

| Source format   |  | Analog, PCM <sup>*1</sup>     | Dolby Digital  |     |          |       | DTS/DTS 96/24 <sup>*2</sup> |     |                 |   | Multich analog |
|---|--|-------------------------------|----------------|-----|----------|-------|-----------------------------|-----|-----------------|---|----------------|
|   |  |                               | 3/2.1<br>2/2.1 | 2/0 | 1/0, 1+1 | Other | 3/2.1<br>2/2.1              | 2/0 | DTS-ES          |   |                |
|   |  | CD, TV, radio, cassette, etc. | DVD, DTV, etc. |     |          |       | DVD, CD, etc.               |     |                 |   | DVD            |
| Listening mode  |  |                               |                |     |          |       |                             |     |                 |   |                |
| Pure Audio (Not North American models)<br>Direct                    |  | ✓                             | ✓              | ✓   | ✓        | ✓     | ✓                           | ✓   | ✓               | ✓ |                |
| Stereo<br>Mono  |  | ✓                             | ✓              | ✓   | ✓        | ✓     | ✓                           | ✓   | ✓               |   |                |
| Multich   |  |                               |                |     |          |       |                             |     |                 | ✓ |                |
| PLIIx Movie/Music/Game <sup>*3</sup><br>Neo:6 Cinema<br>Neo:6 Music |  | ✓                             |                | ✓   |          |       |                             | ✓   |                 |   |                |
| Neural Surround (North American models only)                        |  | ✓ <sup>*4</sup>               |                |     |          |       |                             |     |                 |   |                |
| Dolby   | Dolby D  |                               | ✓              |     |          | ✓     |                             |     |                 |   |                |
|   | Dolby D + Neo:6<br>Dolby D EX<br>Dolby D+PLIIx Music   |                               | ✓              |     |          |       |                             |     |                 |   |                |
|   | Dolby D+PLIIx Music  |                               | ✓              |     |          |       |                             |     |                 |   |                |
|   | Dolby D+PLIIx Movie  |                               | ✓              |     |          |       |                             |     |                 |   |                |
| DTS   | DTS, DTS 96/24   |                               |                |     |          | ✓     |                             |     | ✓ <sup>*5</sup> |   |                |
|   | DTS-ES Discrete  |                               |                |     |          |       |                             | ✓   |                 |   |                |
|   | DTS-ES Matrix  |                               |                |     |          |       |                             |     | ✓               |   |                |
|   | DTS+Neo:6<br>DTS+Dolby EX<br>DTS+PLIIx Music   |                               |                |     |          | ✓     |                             |     |                 |   |                |
|   | DTS+PLIIx Movie  |                               |                |     |          | ✓     |                             |     |                 |   |                |
| Onkyo Original DSP  | Mono Movie<br>Orchestra<br>Unplugged<br>Studio-Mix<br>TV Logic<br>All Ch Stereo<br>Full Mono <sup>*6</sup> | ✓                             | ✓              | ✓   | ✓        | ✓     | ✓                           | ✓   | ✓               |   |                |

\*1. In the Pure Audio and Direct listening modes, 32 kHz, 44.1 kHz, and 48 kHz PCM is processed at 64 kHz, 88.2 kHz, and 96 kHz respectively. In listening modes other than Pure Audio, Direct, and Stereo, 64 kHz, 88.2 kHz, and 96 kHz PCM is processed at 32 kHz, 44.1 kHz, and 48 kHz respectively.

\*2. In listening modes other than Pure Audio, Direct, Stereo, and DTS 96/24, DTS 96/24 sources are processed as normal DTS.

\*3. If the Surr Back parameter is set to None, or speaker set B is on, normal Pro Logic II is used.

\*4. Not available for 88.2 kHz and 96 kHz PCM input signals.

\*5. If the Surr Back setting is set to None, or speaker set B is on, normal DTS is used.

\*6. Available only when surround speakers are connected.

■ : Only available on 6.1/7.1-channel playback systems. Not available while speaker set B is on.

■ : Only available on 7.1-channel playback systems. Not available while speaker set B is on.

**Tip:** To check the format of the digital input signal, see “Displaying Source Information” on page 37.

## About the Listening Modes

The AV receiver's listening modes can transform your listening room into a movie theater or concert hall, with high fidelity and stunning surround sound.

The illustration shows which speakers are active in each listening mode with 7.1 channel speaker system.

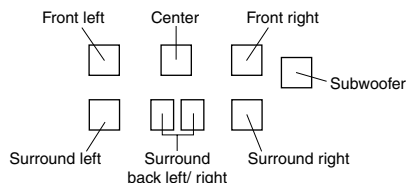

### Pure Audio (not North American models)

In this mode, the display and video circuitry are turned off, minimizing possible noise sources for the ultimate in high-fidelity reproduction. (As the video circuitry is turned off, no video signals are output in this mode.)

### Direct

In this mode, audio from the input source is output directly with minimal processing, providing high-fidelity reproduction. All of the source's audio channels are output as they are.

### Stereo

Sound is output by the front left and right speakers and subwoofer.

### Mono

Use this mode when watching an old movie with a mono soundtrack, or use it with the foreign language soundtracks recorded in the left and right channels of some movies. It can also be used with DVDs or other sources containing multiplexed audio, such as karaoke DVDs.

### Dolby Pro Logic IIx

### Dolby Pro Logic II

**Dolby Pro Logic IIx** expands any 2-channel source for 7.1-channel playback. It provides a very natural and seamless surround-sound experience that fully envelops the listener. As well as music and movies, video games can also benefit from the dramatic spatial effects and vivid imaging. If you're not using any surround back speakers, **Dolby Pro Logic II** will be used instead of Dolby Pro Logic IIx.

- **PLIIx Movie**

Use this mode with any stereo or Dolby Surround (Pro Logic) movie (e.g., TV, DVD, VHS).

- **PLIIx Music**

Use this mode with any stereo or Dolby Surround (Pro Logic) music source (e.g., CD, radio, cassette, TV, VHS, DVD).

- **PLIIx Game**

Use this mode with video games, especially those that bear the Dolby Pro Logic II logo.

### Dolby Digital

Use this mode with DVDs that bear the  Dolby Digital logo, and Dolby Digital TV broadcasts. This is the most common digital surround-sound format, and it'll put you right in the middle of the action, just like being in a movie theater or concert hall.

### Dolby Digital EX DTS+Dolby EX

These modes expand 5.1-channel Dolby Digital and DTS sources for 6.1/7.1-channel playback. They're especially suited to Dolby Digital EX soundtracks that include a matrix-encoded surround back channel. The additional channel adds an extra dimension and provides an enveloping surround sound experience, perfect for rotating and fly-by sound effects. Use them with DVDs that bear the Dolby Digital or DTS logo.

### Dolby Digital+PLIIx Music DTS+PLIIx Music

These modes use the Pro Logic IIx Music mode to expand 5.1-channel Dolby Digital and DTS sources for 6.1/7.1-channel playback. Use them with Dolby Digital or DTS 5.1 music sources (e.g., DVD and Dolby Digital TV broadcasts).

### Dolby Digital+PLIIx Movie DTS+PLIIx Movie

These modes use the Pro Logic IIx Movie mode to expand 5.1-channel Dolby Digital and DTS sources for 7.1-channel playback. Use them with Dolby Digital and DTS 5.1 movies (e.g., DVD and select digital TV broadcasts).

### DTS

The DTS digital surround-sound format supports up to 5.1 discrete channels and uses less compression for high-fidelity reproduction. Use it with DVDs and CDs that bear the DTS logo.

### DTS 96/24

This mode is for use with DTS 96/24 sources. This is high-resolution DTS with a 96 kHz sampling rate and 24-bit resolution, providing superior fidelity. Use it with DVDs that bear the DTS 96/24 logo.

### DTS-ES Discrete

This mode is for use with DTS-ES Discrete soundtracks, which use a discrete surround back channel for true 6.1/7.1-channel playback. The seven totally separate audio channels provide better spatial imaging and 360-degree sound localization, perfect for sounds that pan across the surround channels. Use it with DVDs that bear the DTS-ES logo, especially those with a DTS-ES Discrete soundtrack.

### DTS-ES Matrix

This mode is for use with DTS-ES Matrix soundtracks, which use a matrix-encoded back-channel for 6.1/7.1-channel playback. Use it with DVDs that bear the DTS-ES logo, especially those with a DTS-ES Matrix soundtrack.



### DTS Neo:6

This mode expands any 2-channel source for 6.1-channel playback. It uses six full-bandwidth channels of matrix decoding for matrix-encoded material, providing a very natural and seamless surround sound experience that fully envelops the listener.

- **Neo:6 Cinema**

Use this mode with any stereo movie (e.g., TV, DVD, VHS).

- **Neo:6 Music**

Use this mode with any stereo music source (e.g., CD, radio, cassette, TV, VHS, DVD).

### Dolby Digital + Neo:6

This mode uses Neo:6 to expand 5.1-channel Dolby Digital and DTS sources for 6.1/7.1-channel playback. Use it with DVDs that bear the Dolby Digital or DTS logo and feature a 5.1-channel soundtrack.



### Neural Surround

#### (North American models only)

Neural Surround represents the latest advancement in surround technology developed for music and is adopted by XM Satellite Radio for digital radio broadcast of surround recordings and live events in surround sound. Neural Surround employs psychoacoustic frequency-domain processing, which allows delivery of a more detailed sound stage, with superior channel separation and localization of audio elements. System playback is scalable from 5.1 to 7.1 multichannel surround playback.

## Onkyo Original DSP Modes

### Mono Movie

This mode is suitable for old movies and other mono sources. The center speaker outputs the sound as it is, while reverb is applied to the sound output by the other speakers, giving presence to even mono material.

### Orchestra

Suitable for classical or operatic music, this mode emphasizes the surround channels in order to widen the stereo image, and simulates the natural reverberation of a large hall.

### Unplugged

Suitable for acoustic instruments, vocals, and jazz, this mode emphasizes the front stereo image, giving the impression of being right in front of the stage.

### Studio-Mix

Suitable for rock or pop music, listening to music in this mode creates a lively sound field with a powerful acoustic image, like being at a club or rock concert.

### TV Logic

This mode adds realistic acoustics to TV shows produced in a TV studio, surround effects to the entire sound, and clarity to voices.

### All Ch Stereo

Ideal for background music, this mode fills the entire listening area with stereo sound from the front, surround, and surround back speakers.

### Full Mono

In this mode, all speakers output the same sound in mono, so the sound you hear is the same regardless of where you are within the listening room.

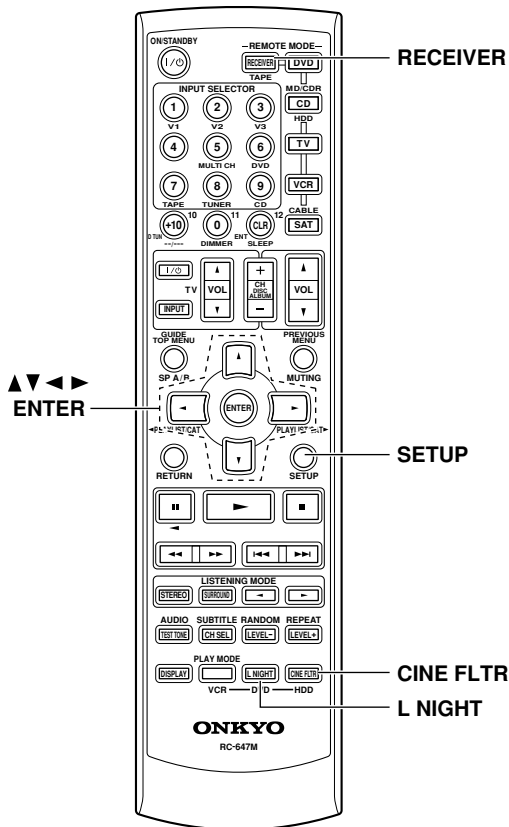

## Using the Late Night Function (Dolby Digital only)

With the Late Night function, you can reduce the dynamic range of Dolby Digital material so that you can still hear quiet parts even when listening at low volume levels—ideal for watching movies late at night when you don't want to disturb anyone.

- Press the [RECEIVER] REMOTE MODE button, and then press the [L NIGHT] button repeatedly to select:**

  - Off:** Late Night function off.
  - Low:** Small reduction in dynamic range.
  - High:** Big reduction in dynamic range.

### Notes:

- The effect of the Late Night function depends on the Dolby Digital material that you are playing, and with some material there will be little or no effect.
- The Late Night function is set to Off when the AV receiver is set to Standby.

## Using the CinemaFILTER

With the CinemaFILTER, you can soften overly bright movie soundtracks, which are typically mixed for reproduction in a movie theater.

CinemaFILTER can be used with the following listening modes: Dolby Digital, Dolby Digital EX, PLII/IIx Movie, DTS, DTS-ES, DTS Neo:6 Cinema, DTS 96/24, Dolby/DTS+PLIIx Movie, Dolby/DTS+Neo:6, and DTS+Dolby EX.

- Press the [RECEIVER] REMOTE MODE button, and then press the [CINE FLTR] button repeatedly to select:**

  - On:** CinemaFILTER on.
  - Off:** CinemaFILTER off.

## Using the Audio Adjust Settings

The Audio Adjust settings only affect speaker set A.

- Press the [RECEIVER] button followed by the [SETUP] button.**
- Use the Up and Down [▲]/[▼] buttons to select "4. Audio Adjust," and then press [ENTER].**

4. Audio Adjust
- Use the Left and Right [◀]/[▶] buttons to change the setting. Press the Down [▼] button to select the next setting. Repeat this step for the other settings.**

4



**Press the [SETUP] button.**

Setup closes.

The Audio Adjust settings are explained below.

### **Input Channel Settings**

---

#### ■ **Multiplex**

This setting determines which channel is output from a stereo multiplex source. Use it to select audio channels or languages with multiplex sources, multilingual TV broadcasts, and so on.

**Main:** The main channel is output (default).

**Sub:** The sub channel is output.

**M/S:** Both the main and sub channels are output.

#### ■ **Mono (2ch)**

This setting determines which channel is output when the Mono listening mode is used with a stereo source.

**L+R:** Both the left and right channels are output (default).

**L:** Only the left channel is output.

**R:** Only the right channel is output.

### **PLII and PLIIX Music Mode Settings**

---

These settings apply to only 2-channel (stereo) sources.

#### ■ **Panorama**

With this setting, you can broaden the width of the front stereo image when using the Pro Logic II Music or Pro Logic IIX Music listening mode.

**On:** Panorama function on.

**Off:** Panorama function off (default).

#### ■ **Dimension**

With this setting, you can move the sound field forward or backward when using the Pro Logic II Music or Pro Logic IIX Music listening mode. The default value is 3. It can be adjusted from 0 to 6. Higher settings move the sound field forward. Lower settings move it backward. If the stereo image feels too wide, or there's too much surround sound, move the sound field forward to improve the balance. Conversely, if the stereo image feels like it's in mono, or there's not enough surround sound, move it backward.

#### ■ **Center Width**

With this setting, you can adjust the width of the sound from the center speaker when using the Pro Logic II Music or Pro Logic IIX Music listening mode. Normally, the center channel sound is output by only the center speaker. (If you're not using a center speaker, the center channel sound will be distributed to the front left and right speakers to create a phantom center). This setting

adjusts the front left, right, and center mix, allowing you to adjust the weight of the center channel sound. It can be adjusted from 0 to 7 (default value is 3).

### **DTS Neo:6 Music Mode Setting**

---

#### ■ **Center Image**

The DTS Neo:6 Music listening mode creates 6-channel surround sound from 2-channel (stereo) sources. With this setting, you can specify by how much the front left and right channel output is attenuated in order to create the center channel. It can be adjusted from 0 to 5 (default value is 2). This setting has no effect if no center speaker is connected.

When set to 0, the front left and right channel output is attenuated by half (–6 dB), giving the impression that the sound is located centrally. This setting works well when the listening position is considerably off center. When set to 5, the front left and right channels are not attenuated, maintaining the original stereo balance.

### **Dolby Digital EX Input Signal Setting**

---

#### ■ **Dolby EX**

This setting determines how Dolby Digital EX signals are handled. This setting is unavailable if no surround back speakers are connected or speaker set B is on.

**Auto:** If the source signal contains a Dolby Digital EX flag, the Dolby Digital EX listening mode is used (default).

**Manual:** You can select Pro Logic IIX Movie, Pro Logic IIX Music, Dolby Digital, or Dolby Digital EX.

### **Multichannel Subwoofer Setting**

---

#### ■ **SW Sens**

On some DVD players, the signal from the multichannel subwoofer output is 15 dB higher than normal. You can change the subwoofer sensitivity to match your DVD player. Note that this setting only affects signals connected to the SUBWOOFER input jack of the multichannel DVD input.

You can select 0 dB (default), +5 dB, +10 dB, or +15 dB. If you find that your subwoofer is too loud, try the +10 dB or +15 dB setting.

# Recording

This section explains how to record the selected input source to a component with recording capability, and how to record audio and video from different sources.

## Recording the Input Source

You can only record to a component that's connected to the TAPE OUT or VIDEO 1 OUT jacks.

See pages 20–31 for information on connecting your AV components.

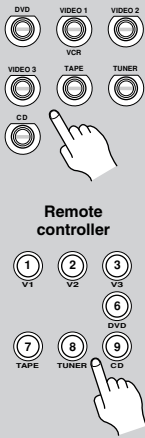
|   |   |
|---|---|
| <p><b>1</b></p>  | <p><b>Use the input selector buttons to select the component that you want to record.</b></p> <p>Audio signals from the selected input source are output by the TAPE OUT and VIDEO 1 OUT jacks.</p> <p>You can listen to the source while recording. The AV receiver's VOLUME control has no effect on recording.</p> |
| <p><b>2</b></p>   | <p><b>On your recorder, start recording.</b></p>  |
| <p><b>3</b></p>   | <p><b>Start playback on the source component.</b></p>   |

### Notes:

- You cannot record from a component that's connected to a digital input. Only analog inputs can be recorded.
- The surround sound effects provided by the listening modes cannot be recorded.
- You cannot record from a component that's connected to the multichannel DVD input.
- If you select another input source while recording, that input source will be recorded instead.
- While the Pure Audio listening mode is selected, the VIDEO 1 OUT V and S jacks don't output video signals, so select another mode when recording.

## Recording Audio and Video from Separate Sources

You can overdub audio onto your video recordings by simultaneously recording audio and video from two separate sources. This is possible because only the audio source is switched when an audio-only input source, such as TAPE, TUNER, or CD, is selected, the video source remains the same.

In the following example, audio from the CD player connected to the CD IN jacks, and video from the camcorder connected to the VIDEO 3 INPUT VIDEO jack are recorded by the VCR connected to the VIDEO 1 OUT jacks.

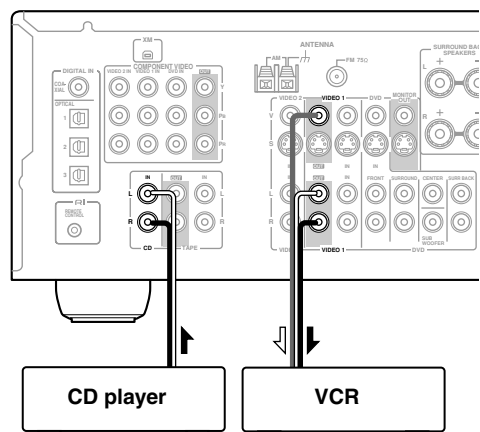
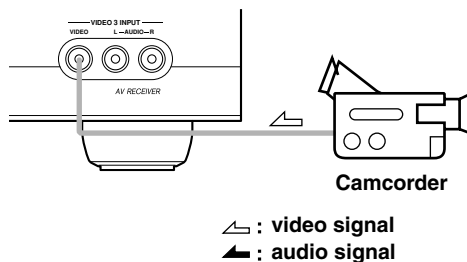

- 1. Prepare the camcorder and CD player for playback.**
- 2. Prepare the VCR for recording.**
- 3. Press the [VIDEO 3] input selector button.**
- 4. Press the [CD] input selector button.**  
This selects the CD player as the audio source, but leaves the camcorder as the video source.
- 5. Start recording on the VCR, then start playback on the camcorder and CD player.**  
Video from the camcorder and audio from the CD player are recorded by the VCR.

# Advanced Setup

## Advanced Speaker Settings

The Crossover Frequency, Double Bass, and Speaker Distance settings cannot be changed while a pair of headphones is connected, speaker set B is on, or the multichannel DVD input is being used.

### Crossover Frequency

This setting only applies to the speakers that you specified as *Small* in the “Speaker Configuration” on page 34. To get the best bass performance from your speaker system, you need to set the crossover frequency according to the size and frequency response of your speakers.

- 

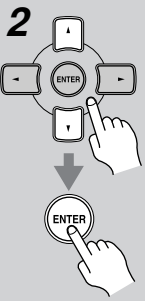
**1** Press the [RECEIVER] REMOTE MODE button, followed by the [SETUP] button.
- 

**2** Use the Up and Down [▲]/[▼] buttons to select “1. SP Config,” and then press [ENTER].

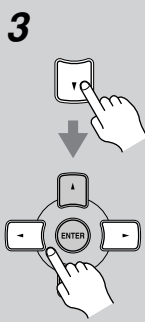
1. SP Config
- 

**3** Use the Down [▼] button to select “Crossover,” and then use the Left and Right [◀]/[▶] buttons to select a crossover frequency.

Use the diameter of the smallest speaker in your system when choosing the crossover frequency.

| Speaker cone diameter         | Crossover frequency |
|-------------------------------|---------------------|
| Over 8 in. (20 cm)            | 40/50/60Hz*         |
| 6-1/2 to 8 in. (16–20 cm)     | 80Hz                |
| 5-1/4 to 6-1/2 in. (13–16 cm) | 100Hz (default)     |
| 3-1/2 to 5-1/4 in. (9–13 cm)  | 120Hz               |
| Under 3-1/2 in. (9 cm)        | 150/200Hz*          |

\*Choose the setting suitable for the speaker.

Continue with step 4 of the “Double Bass” setting below.

#### Notes:

- For a more accurate setting, look up the frequency response in the manuals supplied with your speakers and set accordingly.
- Choose a higher crossover frequency if you want more sound from your subwoofer.

### Double Bass

With the Double Bass function, you can boost bass output by feeding bass sounds from the front left and right channels to the subwoofer. This function can only be set if in the Speaker Configuration on page 34, the Subwoofer setting is set to Yes (step 3), and the Front setting is set to Large (step 4).

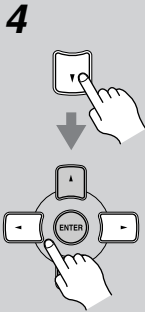
- 

**4** Use the Down [▼] button to select “Double Bass,” and then use the Left and Right [◀]/[▶] buttons to select:

**On:** Double Bass function on. Bass from the front left and right channels is also fed to the subwoofer (default).

**Off:** Double Bass function off.
- 

**5** Press the [SETUP] button. Setup closes.

## Speaker Distance

With these settings, you can specify the distance from each speaker to the listening position.

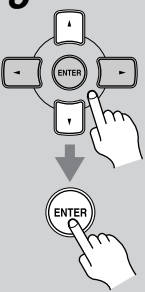
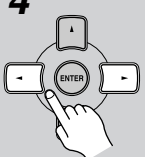
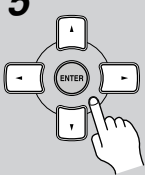
|   |  |
|---|--|
| <b>1</b>  | <b>Measure and make a note of the distance from each speaker to the listening position.</b>  |
| <b>2</b><br>   | <b>Press the [RECEIVER] REMOTE MODE button, followed by the [SETUP] button.</b>  |
| <b>3</b><br>   | <b>Use the Up and Down [▲]/[▼] buttons to select “2. SP Distance,” and then press [ENTER].</b><br><div style="border: 1px solid black; padding: 5px; text-align: center; margin-top: 10px;">2.SP Distance</div>  |
| <b>4</b><br>  | <b>While “Unit” is displayed, use the Left and Right [◀]/[▶] buttons to select “feet” or “meters”.</b><br><b>feet:</b> Distances can be set in feet. Range: 1 to 30 feet in 1-foot steps.<br><b>meters:</b> Distances can be set in meters. Range: 0.3 to 9 meters in 0.3-meter steps. |
| <b>5</b><br> | <b>Use the Down [▼] button to select “Front,” and use the Left and Right [◀]/[▶] buttons to specify the distance for the front speakers, then press the Down [▼] button to select the next speaker.</b>  |
| <b>6</b>  | <b>Repeat step 5 for all speakers.</b><br><b>Note:</b> Speakers that you set to No or None in the Speaker Configuration (page 34) cannot be selected.  |
| <b>7</b>  | <b>Press the [SETUP] button.</b><br>Setup closes.  |

### Notes:

- The Center and Subwoofer distances can be set up to 5 ft. (1.5 m) more or less than the Front distance. For

example, if the Front distance is set to 20 ft. (6 m), the Center and Subwoofer distances can be set between 15 and 25 ft. (4.5 and 7.5 m).

- The Surround and Surround Back distances can be set up to 5 ft. (1.5 m) more or 15 ft. (4.5 m) less than the Front distance. For example, if the Front distance is set to 20 ft. (6 m), the SurrRight, Surr Left, Surr Back R, and Surr Back L distances can be set between 5 and 25 ft. (1.5 and 7.5 m).

## Speaker Levels

You can set the volume level of each speaker so that all speakers can be heard equally at the listening position.

The speaker levels cannot be adjusted while a pair of headphones is connected, speaker set B is on, or the AV receiver is muted.

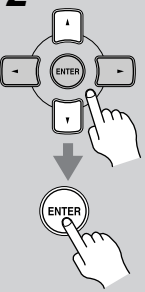
|   |  |
|---|--|
| <b>1</b><br>  | <b>Press the [RECEIVER] REMOTE MODE button, followed by the [SETUP] button.</b>  |
| <b>2</b><br> | <b>Use the Up and Down [▲]/[▼] buttons to select “3. Level Cal,” and then press [ENTER].</b><br>A pink noise test tone is output by the front left speaker.<br><div style="border: 1px solid black; padding: 5px; text-align: center; margin-top: 10px;">3.Level Cal</div> |
| <b>3</b>  | <b>Turn up the volume so that you can hear the test tone sufficiently.</b><br>As each speaker outputs the test tone, its name appears on the display.<br><div style="border: 1px solid black; padding: 5px; text-align: center; margin-top: 10px;">Left : 0dB</div>        |



**4**

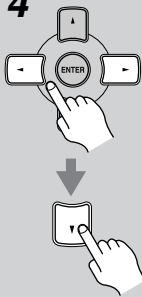

Use the Left and Right [◀]/[▶] buttons to adjust the speaker level, and use the Down [▼] button to select the next speaker.

The levels can be adjusted from -12 to +12 dB in 1 dB steps (-15 to +12 dB for the subwoofer).

**5**

Repeat step 4 so that the level of the test tone coming from each speaker is the same.

Speakers that you set to No or None in the Speaker Configuration (page 34) do not output the test tone.

**6**

Press the [SETUP] button.

Setup closes.

Don't forget to turn down the volume if you turned it up while setting the levels.



### Note:

- A quick way to adjust the speaker levels is to press the remote controller's [TEST TONE] button to turn on the test tone, use the [LEVEL-] and [LEVEL+] buttons to adjust the levels, and use the [CH SEL] button to select the speakers.

## Digital Input Signal Formats

The following table shows the display indicator for each digital signal format.

| Format        | Display |
|---------------|---------|
| Dolby Digital | D       |
| DTS           |         |
| PCM           | PCM     |

Normally, the AV receiver detects the signal format automatically. However, if you experience either of the following issues when playing PCM or DTS material, you can specify the signal format as either PCM or DTS:

- If the beginnings of tracks from a PCM source are cut off, try the PCM setting.
- If noise is produced when fast forwarding or reversing a DTS CD, try the DTS setting.

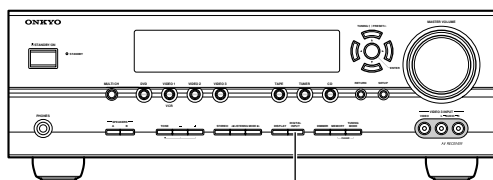

DIGITAL INPUT

**1** Press and hold the AV receiver's [DIGITAL INPUT] button for about 3 seconds.

**2** While "Auto" is displayed (about 3 seconds), press the [DIGITAL INPUT] button repeatedly to select: PCM, DTS, or Auto.

**PCM:** Only PCM format input signals will be heard. If the input signal is not PCM, the PCM indicator will flash and there will be no sound.



**DTS:** Only DTS format input signals will be heard. If the input signal is not DTS, the DTS indicator will flash and there will be no sound.

**Auto (default):** The format is detected automatically. If no digital input signal is present, the corresponding analog input is used instead.

## Correcting Sound and Picture Sync

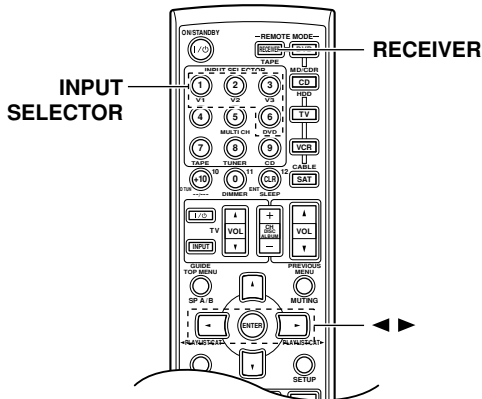
When using progressive scanning on your DVD player, you may find that the picture and sound are out of sync. With this setting, you can correct this by delaying the audio signals. You can set it from 0 to 100 milliseconds (ms) in 20 millisecond steps.

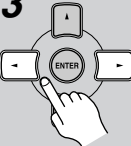

|   |  |
|---|--|
| <p><b>1</b></p>    | <p><b>Press the [RECEIVER] REMOTE MODE button.</b></p>   |
| <p><b>2</b></p>  | <p><b>Press and hold, for more than 4 seconds, the input selector button for the input source that you want to correct.</b></p> <p>This can be the [DVD], [VIDEO 1], [VIDEO 2], or [VIDEO 3] input source.</p>   |
| <p><b>3</b></p>  | <p><b>Use the Left and Right [◀]/[▶] buttons to adjust the delay from 0 to 100 milliseconds in 20 millisecond steps.</b></p> <div style="border: 1px solid black; padding: 5px; width: fit-content; margin: 10px auto;"> <p>A/V Sync : 20ms</p> </div> |

**Note:**

- This setting is not available when the Pure Audio listening mode is used, or the Direct listening mode is used with an analog input signal.

# Controlling Other Components

You can use the AV receiver's remote controller (RC-647M) to control your other AV components, including those made by other manufacturers. This section explains how to enter the necessary remote control code for the component that you want to control (e.g., DVD player, TV, or VCR).

## Entering Remote Control Codes

To control another component, you must first enter the appropriate remote control code to a REMOTE MODE button. You'll need to enter a code for each component that you want to control.

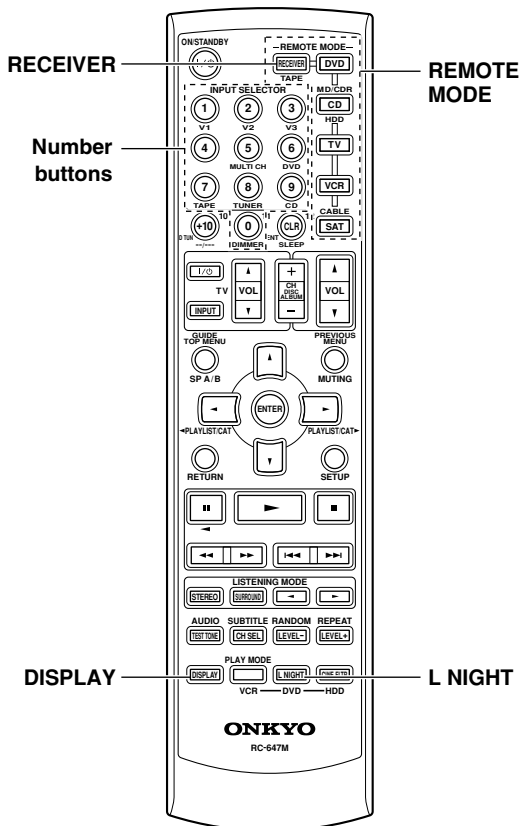

**1**

**Look up the appropriate remote control code in the separate Remote Control Codes list.**

The codes are organized by category (e.g., DVD player, TV, etc.).

**2**

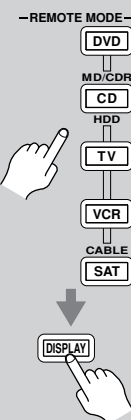

**While holding down the REMOTE MODE button that you want to set, press the [DISPLAY] button for 3 seconds.**

The REMOTE MODE button lights up.

**3**

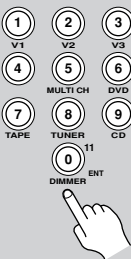

**Within 30 seconds, use the number buttons to enter the 4-digit remote control code.**

The REMOTE MODE button flashes twice.

**4**

**Press the REMOTE MODE button again to select the remote controller mode, point the remote controller at the component, and check the operation.**

If the remote controller doesn't work as expected, and several remote codes are listed, try each one in turn and use the one that works best.

### Notes:

- A remote control code cannot be entered for the [RECEIVER] REMOTE MODE button.
- The remote control codes provided are correct at the time of printing, but are subject to change.

### Remote Control Codes for Onkyo Components Connected via **RI**

Onkyo components that are connected via **RI** are controlled by pointing the remote controller at the AV receiver, not the component. This allows you to control components that are out of view, in a rack, for example.

- 1** Make sure the Onkyo component is connected with an **RI** cable and an analog audio cable (RCA).  
See page 31 for details.
- 2** Enter the appropriate remote control code for the [DVD] or [CD] REMOTE MODE button.  
[DVD] REMOTE MODE button  
**1612:** Onkyo DVD player with **RI**  
[CD/MD/CDR/HDD] REMOTE MODE button  
**1327:** Onkyo CD player with **RI**  
**1808:** Onkyo MD recorder with **RI**  
**1322:** Onkyo CD recorder with **RI**  
**1993:** HDD-compatible component with **RI**  
See the previous page for how to enter remote control codes.
- 3** Press the [DVD] or [CD] REMOTE MODE button, point the remote controller at the AV receiver, and operate the component.

If you want to control an Onkyo component by pointing the remote controller directly at it, or you want to control an Onkyo component that's not connected via **RI**, use the following remote control codes:

- [DVD] REMOTE MODE button  
**0627:** Onkyo DVD player without **RI** (default)
- [CD/MD/CDR/HDD] REMOTE MODE button  
**1817:** Onkyo CD player without **RI** (default)  
**0868:** Onkyo MD recorder without **RI**  
**1323:** Onkyo CD recorder without **RI**  
**1990:** HDD-compatible component without **RI**

**Note:**

If you connect an **RI**-capable Onkyo MD recorder, CD recorder, or HDD-compatible component to the TAPE IN/OUT or VIDEO 2 jacks, for remote operation to work properly, you must set the Input Display to MD, CDR, or HDD (see page 33).

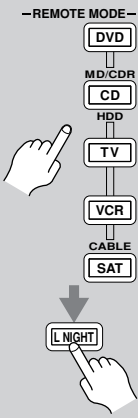
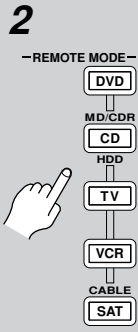

### Resetting REMOTE MODE Buttons

You can reset a REMOTE MODE button to its default remote control code.

- 1** While holding down the REMOTE MODE button that you want to reset, press the [L NIGHT] button for 3 seconds.  
The REMOTE MODE button lights up.  

- 2** Press the REMOTE MODE button again.  
The REMOTE MODE button flashes twice, indicating that it's been reset.  
The [DVD] and [CD] REMOTE MODE buttons are preprogrammed with remote control codes for controlling Onkyo DVD players and CD players respectively. When these buttons are reset, the preprogrammed code is restored.  

### Resetting the Remote Controller

You can reset the remote controller to its default settings.

- 1** While holding down the [RECEIVER] REMOTE MODE button, press the [L NIGHT] button for 3 seconds.  
The [RECEIVER] button lights up.  

- 2** Press the [RECEIVER] REMOTE MODE button again.  
The [RECEIVER] button flashes twice, indicating that it's been reset.  

## Controlling Other Components—Continued

To control another component, point the remote controller at it and use the buttons explained below. (You must select the appropriate remote control mode first.) With some AV components, certain buttons may not work as expected, and some may not work at all.

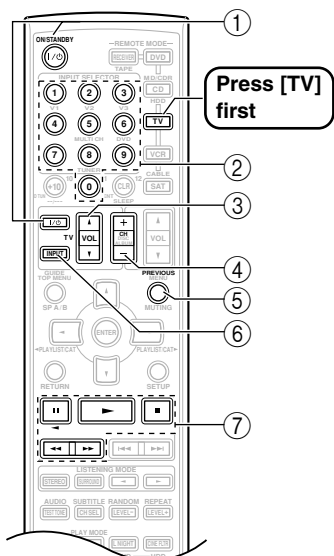
### ■ Controlling a TV



- ① **[ON/STANDBY], TV [⏻/⏷]\***  
Sets the TV to On or Standby.
- ② **Number buttons**  
Enter numbers.
- ③ **TV VOL [▲]/[▼]\***  
Adjusts the TV's volume.
- ④ **[CH +/-]**  
Selects channels on the TV.
- ⑤ **[PREVIOUS]**  
Selects the previous channel.
- ⑥ **[TV INPUT]\***  
Selects the TV's VCR input.
- ⑦ **[⏸], [▶], [⏹], [◀], [▶▶]**  
Operates the VCR.

\* Buttons marked with an asterisk (\*) are exclusively for controlling a TV and can be used at any time regardless of the current remote controller mode.

### ■ Controlling a VCR

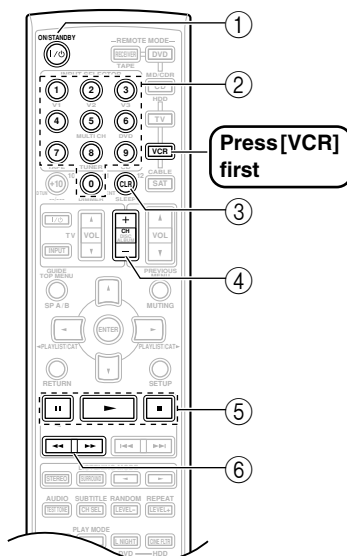

- ① **[ON/STANDBY]**  
Sets the VCR to On or Standby.
- ② **Number buttons**  
Select channels.
- ③ **[CLR]**  
Cancels functions.
- ④ **[CH +/-]**  
Selects channels on the VCR.
- ⑤ **[⏸], [▶], [⏹]**  
Pause, Play, Stop.
- ⑥ **[◀◀], [▶▶]**  
Rewind and Fast forward.

### ■ Controlling a Satellite or Cable Receiver

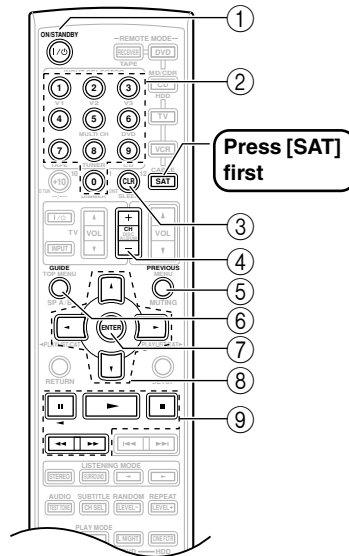

- ① **[ON/STANDBY]**  
Sets the satellite/cable receiver to On or Standby.
- ② **Number buttons**  
Enter numbers.
- ③ **[CLR]**  
Cancels functions.
- ④ **[CH +/-]**  
Selects satellite/cable channels.
- ⑤ **[PREVIOUS]**  
Selects the previous channel.
- ⑥ **[GUIDE]**  
Displays the program guide.
- ⑦ **[ENTER]**  
Confirms the selection.
- ⑧ **[▲]/[▼]/[◀]/[▶]**  
Selects menu items.
- ⑨ **[⏸], [▶], [⏹], [◀], [▶▶]**  
Operates the VCR.

# Troubleshooting

If you have any trouble using the AV receiver, look for a solution in this section.

If you can't resolve the issue yourself, try resetting the AV receiver before contacting your Onkyo dealer.

**To reset the AV receiver to its factory defaults, turn it on and, while holding down the [VIDEO 1] button, press the [STANDBY/ON] button. "Clear" will appear on the display and the AV receiver will enter Standby mode.**

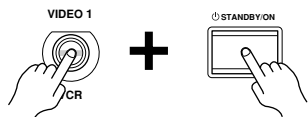

Note that resetting the AV receiver will delete your radio presets and custom settings.

## Power

### Can't turn on the AV receiver

- Make sure that the power cord is plugged into the wall outlet properly.
- Unplug the power cord from the wall outlet, wait 5 seconds or more, then plug it in again.

### The AV receiver turns off as soon as it's turned on

- The amp protection circuit has been activated. Remove the power cord from the wall outlet immediately. Disconnect all speaker cables and input sources, and leave the AV receiver with its power cord disconnected for 1 hour. After that, reconnect the power cord and set the volume to maximum. If the AV receiver stays on, set the volume to minimum, disconnect the power cord, and reconnect your speakers and input sources. If the AV receiver turns off when you set the volume to maximum, disconnect the power cord, and contact your Onkyo dealer.

## Audio

### There's no sound or it's very quiet

- Make sure that the digital input source is selected properly (page 33). Press the [DIGITAL INPUT] button repeatedly.
- Make sure the speaker set A or B is on (page 6).
- Make sure that all audio connecting plugs are pushed in all the way (page 20).
- Make sure that the polarity of the speaker cables is correct, and that the bare wire is in contact with metal part of each speaker terminal (page 17)
- Make sure that the speaker cables are not shorting.
- Check the volume. It can be set to MIN, 1 through 79, or MAX (page 36). The AV receiver is designed for

home theater enjoyment and has a wide volume range for precise adjustment.

- If the MUTING indicator is shown on the display, press the remote controller's [MUTING] button to unmute the AV receiver (page 46).
- While a pair of headphones is connected to the PHONES jack, no sound is output by the speakers (page 47).
- Check the digital audio output settings on the connected device. On some games consoles, such as those that can play DVDs, the default setting is off.
- With some DVD-Video discs, you need to select an audio format from a menu.
- If your turntable doesn't have a phono preamp built-in, you must connect one between it and the AV receiver. If your turntable uses an MC cartridge, you must connect an MC head amp, or an MC transformer and a phono preamp.
- Specify the speaker distances and adjust the individual speaker levels (pages 56, 57).
- The input signal format is set to PCM or DTS. Set it to Auto (page 57).

### Only the front speakers produce sound

- When the Stereo or Mono listening mode is selected, only the front speakers and subwoofer produce sound.
- Make sure the speakers are configured correctly (page 34).

### Only the center speaker produces sound

- If you use the Pro Logic IIX Movie, Pro Logic IIX Music, or Pro Logic IIX Game listening mode with a mono source, such as an AM radio station or mono TV program, the sound is concentrated in the center speaker.
- Make sure the speakers are configured correctly (page 34).

### The surround speakers produce no sound

- When the Stereo or Mono listening mode is selected, the surround speakers produce no sound (page 50).
- Depending on the source and current listening mode, not much sound may be produced by the surround speakers. Try selecting another listening mode.
- Make sure the speakers are configured correctly (page 34).

### The center speaker produces no sound

- When the Stereo or Mono listening mode is selected, the center speaker produces no sound (page 50).
- Make sure the speakers are configured correctly (page 34).

### The surround back speakers produce no sound

- While speaker set B is on, speaker set A is reduced to 5.1-channel playback and the surround back speakers produce no sound.

- The surround back speakers are not used with all listening modes. Select another listening mode (page 50).
- Not much sound may be produced by the surround back speakers with some sources.
- Make sure the speakers are configured correctly (page 34).

### The subwoofer produces no sound

- The subwoofer outputs no sound while only speaker set B is on. Turn on speaker set A.
- When you play source material that contains no information in the LFE channel, the subwoofer produces no sound.
- Make sure the speakers are configured correctly (page 34).

### Speaker set B produces no sound

- Speaker set B only outputs sources that are connected to an analog input. Make sure that the analog audio cables are connected properly.

### There's no sound with a certain signal format

- Check the digital audio output setting on the connected device. On some games consoles, such as those that can play DVDs, the default setting is off.
- With some DVD-Video discs, you need to select an audio output format from a menu.

### Can't get 6.1- or 7.1-channel playback

- While speaker set B is on, speaker set A is reduced to 5.1-channel playback.

### The volume cannot be set to 79

- When the volume level of each speaker has been adjusted (pages 47, 56), the maximum possible volume may be reduced.

### Noise can be heard

- Using cable ties to bundle audio cables with power cords, speaker cables, and so on may degrade the audio performance, so don't do it.
- An audio cable may be picking up interference. Try repositioning your cables.

### The Late Night function doesn't work

- Make sure the source material is Dolby Digital (page 52).

### The multichannel DVD input doesn't work

- Check the multichannel DVD input connections (page 24).
- To select the multichannel DVD input, press the [MULTI CH] input selector button.
- Check the audio output settings on your DVD player.

### About DTS signals

- When playing DTS program material, using the pause, fast forward, or fast reverse function on your player

may produce a short audible noise. This is not a malfunction.

- When DTS program material ends and the DTS bitstream stops, the AV receiver remains in DTS listening mode and the DTS indicator remains on. This is to prevent noise when you use the pause, fast forward, or fast reverse function on your player. If you switch your player from DTS to PCM, because the AV receiver does not switch formats immediately, you may not hear any sound, in which case you should stop your player for about 3 seconds, and then resume playback.
- With some CD players, you won't be able to playback DTS material properly even though your player is connected to a digital input on the AV receiver. This is usually because the DTS bitstream has been processed (e.g., output level, sampling rate, or frequency response changed) and the AV receiver doesn't recognize it as a genuine DTS signal. In such cases, you may hear noise.

## Video

### There's no picture

- Make sure that all video connecting plugs are pushed in all the way (page 20).
- Make sure that each video component is properly connected.
- The AV receiver does not convert between formats, so if a video source component is connected to a component video input, your TV must be connected to the component video output (page 21).
- On your TV, make sure that the video input to which the AV receiver is connected is selected.
- While the Pure Audio listening mode (not North American model) is selected, the video circuits are turned off and the AV receiver outputs no video signals.

## Tuner

### Reception is noisy, stereo FM reception suffers from hiss, or the FM STEREO indicator doesn't appear

- Relocate your antenna.
- Move the AV receiver away from your TV or computer.
- Listen to the station in mono (page 38).
- When listening to an AM station, operating the remote controller may cause noise.
- Passing cars and airplanes can cause interference.
- Concrete walls weaken radio signals.
- If nothing improves the reception, install an outdoor antenna.

### Remote Controller

#### The remote controller doesn't work

- Make sure that the batteries are installed with the correct polarity (page 11).
- Make sure that the remote controller is not too far away from the AV receiver, and that there's no obstruction between the remote controller and the AV receiver's remote control sensor (page 11).
- Make sure you've selected the correct remote controller mode (page 12).
- Make sure you've entered the correct remote control code (page 59).

#### Can't control other components

- Make sure you've selected the correct remote controller mode (page 12).
- If you've connected an **RI**-capable Onkyo MD recorder, CD recorder, or next generation HDD-compatible component to the TAPE IN/OUT jacks, or a DS-A1 Remote Interactive Dock to the VIDEO 2 IN jacks, for the remote controller to work properly, you must set the Input Display to MD, CDR, or HDD (see page 33).
- The entered remote control code may not be correct. If more than one code is listed, try each one.
- With some AV components, certain buttons may not work as expected, and some may not work at all.
- To control an Onkyo component that's connected via **RI**, point the remote controller at the AV receiver. Be sure to enter the appropriate remote control code first (see page 60).
- To control an Onkyo component that's not connected via **RI**, or another manufacturer's component, point the remote controller at the component. Be sure to enter the appropriate remote control code first (see page 59).

### Recording

#### Can't record

- On your recorder, make sure the correct input is selected.
- To prevent signal loops and damage to the AV receiver, input signals are not fed through to outputs with the same name (e.g., TAPE IN to TAPE OUT, or VIDEO 1 IN to VIDEO 1 OUT).
- When the Pure Audio listening mode is selected, recording is not possible because no video signals are output. Select another listening mode.

### Others

#### The sound changes when I connect my headphones

- When a pair of headphones is connected, the listening mode is set to Stereo, unless it's already set to Stereo, Mono, Direct, or Pure Audio (not North American model).

#### The display doesn't work

- The display is turned off when the Pure Audio (not North American model) listening mode is selected.

#### How do I change the language of a multiplex source

- Use the "Multiplex" setting on the "4. Audio Adjust" menu to select Main or Sub (page 53).

#### The **RI** functions don't work

- To use **RI**, you must make an **RI** connection and an analog audio connection (RCA) between the component and AV receiver, even if they are connected digitally (page 31).



The AV receiver contains a microcomputer for signal processing and control functions. In very rare situations, severe interference, noise from an external source, or static electricity may cause it to lockup. In the unlikely event that this happens, unplug the power cord from the wall outlet, wait at least five seconds, and then plug it back in again.

Onkyo is not responsible for damages (such as CD rental fees) due to unsuccessful recordings caused by the unit's malfunction. Before you record important data, make sure that the material will be recorded correctly.

Before disconnecting the power cord from the wall outlet, set the AV receiver to Standby.

### Memory Backup

The AV receiver uses a battery-less memory backup system in order to retain radio presets and other settings when it's unplugged or in the case of a power failure. Although no batteries are required, the AV receiver must be plugged into an AC outlet in order to charge the backup system. Once it has been charged, the AV receiver will retain the settings for several weeks, although this depends on the environment and will be shorter in humid climates.

### The following settings can be made for the S-Video and composite video inputs

You must use the buttons on the unit to make these settings.

1. While holding down the input selector button for the input source that you want to set, press the [SETUP] button.
2. Use the Up and Down [▲]/[▼] buttons to select a setting (see below).
3. Use the Left and Right [◀]/[▶] buttons to change the setting:
4. Press the [SETUP] button when you've finished.

#### • Video Attenuation

This setting can be made for the DVD, VIDEO 1, VIDEO 2, or VIDEO 3 input.

If you have a games console connected to an S-Video or composite video input, and the picture isn't very clear, you can attenuate the gain.

**Video ATT:0:** (default).

**Video ATT:2:** Gain is reduced by 2 dB.

#### • Outputting S-Video Sources from the Composite Video Outputs

This setting can be made for the DVD, VIDEO 1, or VIDEO 2 input.

With this setting, you can output S-Video input sources from the composite video outputs, useful if your TV doesn't have any S-Video inputs.

**Y/C Mix:Off:** S-Video input signals are output by only S-Video outputs (default).

**Y/C Mix:On:** S-Video input signals are output by S-Video outputs and composite video outputs.

# Specifications

## Amplifier Section

|                                 |  |
|---------------------------------|--|
| Rated Output Power (FTC)        |  |
| All channels:                   | <b>75 watts minimum continuous power per channel, 8 ohm loads, 2 channels driven from 20 Hz to 20 kHz, with a maximum total harmonic distortion of 0.08%</b><br><b>100 watts minimum continuous power per channel, 6 ohm loads, 2 channels driven at 1 kHz, with a maximum total harmonic distortion of 0.1%</b> |
| Rated Output Power (IEC)        | 7 ch × 130 W at 6 ohms, 1 kHz, 1 ch driven   |
| Maximum Output Power (JEITA)    | 7 ch × 160 W at 6 ohms, 1 kHz, 1 ch driven   |
| Dynamic Power                   | 180 W + 180 W (3Ω, Front)<br>140 W + 140 W (4Ω, Front)<br>95 W + 95 W (8Ω, Front)  |
| THD (Total Harmonic Distortion) | 0.08% (Power Rated)  |
| Damping Factor                  | 60 (Front, 1kHz, 8Ω)   |
| Input Sensitivity and Impedance | 200 mV/ 47 kΩ (LINE)   |
| Output Level and Impedance      | 200 mV/ 470 Ω (REC OUT)  |
| Frequency Response              | 5 Hz–100 kHz/ +1 dB–3 dB (Direct mode)   |
| Tone Control                    | ±10 dB, 80 Hz (BASS)<br>±10 dB, 20 kHz (TREBLE)  |
| Signal to Noise Ratio           | 100 dB (LINE, IHF-A)   |
| Speaker Impedance               | North American: 6Ω–16Ω<br>Others: 4Ω– or 6Ω–16Ω  |

## Video Section

|  |  |
|--|--|
| Input Sensitivity/Output Level and Impedance | 1 Vp-p /75Ω (Component and S-Video Y)<br>0.7 Vp-p /75Ω (Component Pb/Cb, Pr/Cr)<br>0.28 Vp-p /75Ω (S-Video C)<br>1 Vp-p /75Ω (Composite) |
| Component Video Frequency Response           | 5 Hz – 50 MHz  |

## Tuner Section

### ■ FM

|                        |   |
|------------------------|---|
| Tuning Frequency Range | North American: 87.5 MHz– 107.9 MHz<br>Other: 87.5 MHz– 108.0 MHz |
| Usable Sensitivity     | Stereo: 17.2 dBf 2 μV (75Ω IHF)<br>Mono: 11.2 dBf 1 μV (75Ω IHF)  |
| Signal to Noise Ratio  | Stereo: 70 dB (IHF-A)<br>Mono: 76 dB (IHF-A)                      |
| THD                    | Stereo: 0.3% (1 kHz)<br>Mono: 0.2% (1 kHz)                        |
| Frequency Response     | 30 Hz–15 kHz / ±1 dB  |
| Stereo Separation      | 40 dB (1 kHz)   |

### ■ AM

|                        |   |
|------------------------|---|
| Tuning Frequency Range | North American: 530 kHz–1710 kHz<br>European: 522 kHz–1611 kHz<br>Others: 522/530 kHz–1611/1710 kHz |
| Usable Sensitivity     | 300 μV  |
| Signal to Noise Ratio  | 40 dB   |
| THD                    | 0.7%  |

## General

|                           |  |
|---------------------------|--|
| Power Supply              | North American: AC 120 V, 60 Hz<br>European: AC 230-240 V, 50 Hz<br>Others: AC 120/220-240 V, 50/60 Hz<br>AC 230-240 V, 50Hz<br>AC 220-230 V, 50/60 Hz |
| Power Consumption         | North American: 4.9 A<br>European: 570 W<br>Others: 525 W  |
| Standby Power Consumption | North American: 0.1 W<br>European: 0.2 W<br>Others: 0.5 W  |
| Dimensions (W × H × D)    | 435 × 151 × 377 mm<br>17-1/8" × 5-15/16" × 14-13/16"   |
| Weight                    | North American: 9.6 kg<br>21.2 lbs.<br>Models with voltage selector: 10.4 kg<br>22.9 lbs.<br>Others: 10.3 kg<br>22.7 lbs.                              |

### ■ Video Inputs

|           |                             |
|-----------|-----------------------------|
| Component | DVD, VIDEO1, VIDEO2         |
| S-Video   | DVD, VIDEO1, VIDEO2         |
| Composite | DVD, VIDEO1, VIDEO2, VIDEO3 |

### ■ Video Outputs

|           |                 |
|-----------|-----------------|
| Component | MONITOR         |
| S-Video   | MONITOR, VIDEO1 |
| Composite | MONITOR, VIDEO1 |

### ■ Audio Inputs

|                     |  |
|---------------------|--|
| Digital Inputs      | Optical: 3<br>Coaxial: 1                             |
| Analog Inputs       | DVD (MULTICHANNEL), VIDEO1, VIDEO2, VIDEO3, TAPE, CD |
| Multichannel Inputs | 7.1  |

### ■ Audio Outputs

|                       |   |
|-----------------------|---|
| Analog Outputs        | TAPE, VIDEO1                                    |
| Subwoofer Pre Outputs | 1   |
| Speaker Outputs       | SP A (L, R, C, SL, SR, SBL, SBR)<br>SP B (L, R) |
| Phones                | 1   |

Specifications and features are subject to change without notice.

# Memo

---



## **ONKYO CORPORATION**

Sales & Product Planning Div. : 2-1, Nisshin-cho, Neyagawa-shi, OSAKA 572-8540, JAPAN  
Tel: 072-831-8023 Fax: 072-831-8124

### **ONKYO U.S.A. CORPORATION**

18 Park Way, Upper Saddle River, N.J. 07458, U.S.A.  
Tel: 201-785-2600 Fax: 201-785-2650 <http://www.us.onkyo.com/>

### **ONKYO EUROPE ELECTRONICS GmbH**

Liegnitzerstrasse 6, 82194 Groebenzell, GERMANY  
Tel: +49-8142-4401-0 Fax: +49-8142-4401-555 <http://www.eu.onkyo.com/>

### **ONKYO EUROPE UK Office**

Suite 1, Gregories Court, Gregories Road, Beaconsfield, Buckinghamshire, HP9 1HQ  
UNITED KINGDOM Tel: +44-(0)1494-681515 Fax: +44(0)-1494-680452

### **ONKYO CHINA LIMITED**

Units 2102-2107, Metroplaza Tower I, 223 Hing Fong Road, Kwai Chung,  
N.T., HONG KONG Tel: 852-2429-3118 Fax: 852-2428-9039  
<http://www.ch.onkyo.com/>



I0602-1

SN 29344181

(C) Copyright 2006 ONKYO CORPORATION Japan. All rights reserved.

Download from [www.Somanuals.com](http://www.Somanuals.com). All Manuals Search And Download.



\* 2 9 3 4 4 1 8 1 \*

# Remote Control Codes

1. While holding down the **REMOTE MODE** button that you want to set, press the **[DISPLAY]** button for 3 seconds.
2. Use the number buttons to enter the 4-digit remote control code.

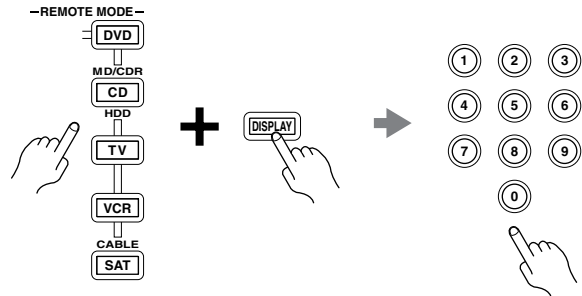

## Codes de télécommande

1. Maintenez le bouton **REMOTE MODE** à initialiser enfoncé et appuyez sur le bouton **[DISPLAY]** durant 3 secondes.
2. Entrez les 4 chiffres du code de télécommande avec les boutons numériques.

## Codici del telecomando

1. Mentre tenete premuto il pulsante **REMOTE MODE** che volete impostare, premete il pulsante **[DISPLAY]** per 3 secondi.
2. Utilizzate i pulsanti numerici per inserire il codice di telecomando a 4 cifre.

## Afstandsbedieningscodes

1. Houd de **REMOTE MODE** toets ingedrukt die u wilt instellen en druk dan de **[DISPLAY]** toets 3 seconden in.
2. Met de cijfertoetsen de 4-cijferige afstandsbedieningscode in.

## 遙控代碼

1. 按下您希望設置的遙控鍵，同時按下 **[DISPLAY]** 鍵保持 3 秒鐘。
2. 使用數字鍵輸入 4 位數字的遙控代碼。

## Códigos de control remoto

1. Manteniendo pulsado el botón **REMOTE MODE** que desee ajustar, pulse el botón **[DISPLAY]** durante 3 segundos.
2. Utilice los botones de número para introducir el código de 4 dígitos para control remoto.

## Fernbedienungscodes

1. Halten Sie die änderungsbedürftige **REMOTE MODE**-Taste gedrückt, während Sie die **[DISPLAY]**-Taste 3 Sekunden lang betätigen.
2. Geben Sie mit den Zifferntasten den 4-stelligen Fernbedienungscodes ein.

## Fjärrstyrningskoder

1. Tryck in och håll lämplig lägesväljare (**REMOTE MODE**) intryckt och tryck samtidigt in knappen **[DISPLAY]** i tre sekunder.
2. In den 4-siffriga fjärrstyrningskoden med hjälp av sifferknapparna.

## 遙控代碼

1. 按下您希望設置的遙控鍵，同時按下 **[DISPLAY]** 鍵保持 3 秒鐘。
2. 使用數字鍵輸入 4 位數字的遙控代碼。

**DVD Player**

|                         |  |
|-------------------------|--|
| Acoustic Solutions      | 0730, 0713                               |
| Advent                  | 1016                                     |
| Aiwa                    | 0641                                     |
| Akai                    | 0899, 1115                               |
| Akura                   | 0898                                     |
| Amoisonic               | 0835                                     |
| Amphion Media Works     | 0872                                     |
| Amstrad                 | 0713                                     |
| AMW                     | 0872                                     |
| Apex Digital            | 0755, 0794, 0830, 1020, 1061             |
| Aspire Digital          | 1168                                     |
| Audiovox                | 1071, 1121, 1122                         |
| Axion                   | 1071, 1193                               |
| Blue Nova International | 1321                                     |
| Broksonic               | 1419                                     |
| Bush                    | 0516, 0690, 0713                         |
| Cambridge Soundworks    | 0690                                     |
| Celestial               | 1020                                     |
| Changhong               | 0627, 1061                               |
| CineVision              | 0833, 1483                               |
| Clayton                 | 0713                                     |
| Coby                    | 0852, 1086, 1321, 1351                   |
| Conia                   | 0835                                     |
| CyberHome               | 0714, 0874, 1023, 1129                   |
| Daewoo                  | 0714, 0833                               |
| Daytek                  | 0872                                     |
| Denver                  | 0898, 1321                               |
| Diamond                 | 0768                                     |
| Dick Smith Electronics  | 0833, 1483                               |
| Digitor                 | 0690                                     |
| Disney                  | 0675                                     |
| DSE                     | 0833, 1483                               |
| DVD2000                 | 0521                                     |
| ECC                     | 0730                                     |
| Elta                    | 1115                                     |
| Eltax                   | 1321                                     |
| Emerson                 | 0675, 0821, 1268                         |
| Ferguson                | 0898                                     |
| Funai                   | 0675, 1268, 1334                         |
| Gateway                 | 1073                                     |
| GE                      | 0815                                     |
| Go Video                | 0715, 0833, 1044, 1075, 1099, 1304, 1483 |
| Go Vision               | 1071                                     |
| H & B                   | 0818, 0841, 1233, 1421                   |
| Harman/Kardon           | 0582                                     |
| Hitachi                 | 1247, 1664                               |
| iLo                     | 1348                                     |
| Integra                 | 0627                                     |
| Jensen                  | 1016                                     |
| JVC                     | 0558                                     |
| jWin                    | 1051                                     |
| Kiss                    | 0841, 1523                               |
| KLH                     | 1020, 1261                               |

**DVD Player**

|               |  |
|---------------|--|
| Kreisen       | 1421                                     |
| KXD           | 1321                                     |
| Lecson        | 1533                                     |
| Lenoxx        | 0838                                     |
| LG            | 0801                                     |
| Limit         | 0768                                     |
| LiteOn        | 1058, 1416, 1440                         |
| Loewe         | 0511                                     |
| Lumatron      | 1321                                     |
| Magnavox      | 0675, 0821, 1140, 1268                   |
| McIntosh      | 1533                                     |
| Medion        | 1347                                     |
| Memorex       | 0690                                     |
| Metronic      | 0690                                     |
| Mitsubishi    | 1521, 0521, 1403                         |
| Mustek        | 0730                                     |
| NEC           | 0785, 1404                               |
| Nintaus       | 1051                                     |
| Norcent       | 1003, 0872                               |
| Onkyo         | 0627, 1612(RI)                           |
| Orion         | 1419                                     |
| Palsonic      | 0835, 0852                               |
| Panasonic     | 0703, 1010, 1011, 1362, 1462, 1490, 1762 |
| Philco        | 0690                                     |
| Philips       | 0675, 0854, 1260, 1340, 1354             |
| Pioneer       | 0525, 0631                               |
| Polaroid      | 1020, 1061, 1086                         |
| Prima         | 1016                                     |
| ProVision     | 1321                                     |
| RCA           | 0822, 1022, 1132, 1193                   |
| Redstar       | 0898                                     |
| Relisys       | 1347                                     |
| Roadstar      | 1051                                     |
| Sampo         | 1321                                     |
| Samsung       | 0820, 0899, 1044, 1075                   |
| Santosh       | 1115                                     |
| Sanyo         | 0873                                     |
| Sharp         | 0675, 1256, 1419                         |
| Skyworth      | 0898                                     |
| Sliding       | 1115                                     |
| SM Electronic | 0730, 0690                               |
| Sonic Blue    | 1099                                     |
| Sony          | 1533, 1033, 1069, 1070, 1431             |
| Sova          | 1122                                     |
| Superscan     | 0821                                     |
| Sylvania      | 0675, 0821, 1268                         |
| Symphonic     | 0675, 1268                               |
| Tangent       | 1321                                     |
| Teac          | 0516, 0759, 0809, 0833, 1006, 1021, 1483 |
| Technics      | 0703                                     |
| Technosonic   | 0730                                     |
| Tedelex       | 0690                                     |
| Tevion        | 1036, 1227, 1382                         |

**DVD Player**

|                 |                  |
|-----------------|------------------|
| Thomson         | 0551             |
| Toshiba         | 1045, 1154, 1510 |
| TRANS-continent | 1321             |
| Umax            | 0690             |
| Vizio           | 1064             |
| Yamada          | 0872, 1416       |
| Yamaha          | 0545             |
| Yamakawa        | 0872             |

**DVD Recorder**

|                |                        |
|----------------|------------------------|
| Aspire Digital | 1168                   |
| Coby           | 1086                   |
| CyberHome      | 1129                   |
| Eltax          | 1321                   |
| Funai          | 0675, 1334             |
| Gateway        | 1073                   |
| Go Video       | 1304                   |
| H & B          | 1421                   |
| Hitachi        | 1664                   |
| iLo            | 1348                   |
| Kreisen        | 1421                   |
| LiteOn         | 1416, 1440             |
| Medion         | 1347                   |
| Mitsubishi     | 1403                   |
| NEC            | 1404                   |
| Panasonic      | 1010, 1011             |
| Pioneer        | 0631                   |
| Polaroid       | 1086                   |
| Relisys        | 1347                   |
| Sharp          | 0675, 1419             |
| Sony           | 1033, 1069, 1070, 1431 |
| Sylvania       | 0675                   |
| Tangent        | 1321                   |
| Tevion         | 1227                   |
| Thomson        | 0551                   |
| Toshiba        | 1510                   |
| Yamada         | 1416                   |

**TV/DVD Combination**

|              |                  |
|--------------|------------------|
| Advent       | 1016             |
| Apex Digital | 0830             |
| Audiovox     | 1071, 1121, 1122 |
| Axion        | 1071, 1193       |
| Bush         | 0516, 0713       |
| Emerson      | 0675, 1268       |
| Go Vision    | 1071             |
| Hitachi      | 1247             |
| Jensen       | 1016             |
| KLH          | 1261             |
| Magnavox     | 1268             |
| Panasonic    | 1490             |
| Philips      | 0854, 1260       |
| Prima        | 1016             |
| RCA          | 1022, 1193       |
| Samsung      | 0899             |
| Sliding      | 1115             |
| Sova         | 1122             |
| Sylvania     | 0675, 1268       |
| Teac         | 1021             |

**CD Player**

|                  |                                    |
|------------------|------------------------------------|
| Anthem           | 0897                               |
| Bush             | 0388                               |
| Carver           | 0179                               |
| Classic          | 1297                               |
| Copland          | 0393                               |
| Denon            | 0034, 0766                         |
| Dynamic Bass     | 0179                               |
| Fisher           | 0179, 1325                         |
| Garrard          | 0393                               |
| Genexxa          | 0426                               |
| GoldStar         | 1208                               |
| GPX              | 1296                               |
| Harman/Kardon    | 0173, 0426, 1202                   |
| HHB              | 0192                               |
| Inkel            | 0180                               |
| JVC              | 1294                               |
| Kenwood          | 0826, 0028, 0037                   |
| KLH              | 1373                               |
| LG               | 1208                               |
| Magnavox         | 0038                               |
| Marantz          | 0038, 0180, 0435                   |
| Memorex          | 0180                               |
| Musical Fidelity | 0393                               |
| NAD              | 0721, 1208                         |
| Onkyo            | 1327(RI), 1817                     |
| Optimus          | 1063, 0037, 0468, 0087, 0179, 0426 |
| Panasonic        | 0388, 0752                         |
| Philips          | 0274                               |
| Pioneer          | 1063, 1062, 1087, 0468, 0192       |
| RCA              | 1062, 0468, 0053, 0179             |
| Realistic        | 0179, 0180                         |
| Roksan           | 0435                               |
| Rotel            | 0897                               |
| Sanyo            | 0087, 0179                         |
| Sharp            | 0861, 0037, 0034, 0180             |
| Sherwood         | 1067, 0180, 0426                   |
| Silsonic         | 0888                               |
| Sony             | 0100, 1364, 0185                   |
| TDK              | 1208                               |
| Teac             | 0393, 0180, 0435                   |
| Technics         | 0207, 1078                         |
| Thomson          | 0053                               |
| Universum        | 0053                               |
| Wards            | 0053                               |
| Yamaha           | 0888, 1292                         |

**CD Recorder**

|               |                  |
|---------------|------------------|
| Classic       | 1297             |
| Denon         | 0766             |
| Fisher        | 1325             |
| GPX           | 1296             |
| Harman/Kardon | 1202             |
| HHB           | 0192             |
| JVC           | 1294             |
| KLH           | 1373             |
| LG            | 1208             |
| NAD           | 1208             |
| Onkyo         | 1322(RI), 1323   |
| Pioneer       | 1062, 1087, 0192 |
| RCA           | 0053             |
| Sony          | 0100, 1364       |
| TDK           | 1208             |
| Yamaha        | 0888, 1292       |

**MD Recorder**

|          |                |
|----------|----------------|
| Kenwood  | 0826           |
| Onkyo    | 0868, 1808(RI) |
| Optimus  | 1063           |
| Pioneer  | 1063           |
| Sharp    | 0861           |
| Sherwood | 1067           |
| Sony     | 0185           |
| Technics | 1078           |
| Yamaha   | 0888           |

**HDD Player**

|       |                |
|-------|----------------|
| Onkyo | 1990, 1993(RI) |
|-------|----------------|

| TV             |  |
|----------------|--|
| 888            | 0264   |
| Acura          | 0009   |
| Addison        | 0653, 0108, 0092, 1150   |
| Admiral        | 0463, 0163   |
| Advent         | 0761, 0783, 0815, 0842   |
| Aiko           | 0092   |
| Aiwa           | 0701, 1180   |
| Akai           | 0060, 0812, 0702, 0030, 0264, 0218, 0009, 0208, 0672, 0729, 0745, 0753, 1207 |
| Akura          | 0264, 0218   |
| Alba           | 0037, 0218, 0009, 0371   |
| Albatron       | 0700   |
| Alfide         | 0672   |
| America Action | 0180   |
| Amstrad        | 0171, 0037, 0009, 0371   |
| Anam           | 0250, 0180, 0009, 0161, 0700   |
| Anam National  | 0250, 0161   |
| Anhua          | 0051   |
| Anitech        | 0009   |
| AOC            | 0451, 0180, 0060, 0030, 0108, 0009, 0092, 1150                               |
| Aolinpike      | 0264   |
| Apex Digital   | 0156, 0748, 0765, 0767, 0879, 1217   |
| Asuka          | 0218   |
| Audinac        | 0180   |
| Audiosonic     | 0037, 0109   |
| Audiovox       | 0451, 0180, 0092, 0623, 0802   |
| Aventura       | 0171   |
| Awa            | 0009   |
| Baihe          | 0264, 0009   |
| Baile          | 0001, 0009, 0374, 0661   |
| Baird          | 0343   |
| Bang & Olufsen | 0565   |
| Baohuashi      | 0264   |
| Baosheng       | 0009   |
| Basic Line     | 0218, 0009   |
| Baur           | 0037, 0512   |
| Baysonic       | 0180   |
| Beijing        | 0812, 0264, 0226, 0001, 0009, 0208, 0374, 0661                               |
| Beko           | 0714, 0370   |
| Bell & Howell  | 0154   |
| BenQ           | 1032   |
| Beon           | 0037   |
| Blaupunkt      | 0195   |
| Blue Sky       | 0556, 0218, 1254   |
| BPL            | 0896   |
| Bradford       | 0180   |

| TV                   |  |
|----------------------|--|
| Brandt               | 0109, 0335   |
| Broksonic            | 0236, 0463, 0180   |
| BTC                  | 0218   |
| Bush                 | 0037, 0698, 0218, 0009, 0371, 0374                                     |
| Caihong              | 0009   |
| Cailing              | 0748   |
| Candle               | 0030, 0056   |
| Carnivale            | 0030   |
| Carver               | 0054, 0170   |
| Cascade              | 0009   |
| Cathay               | 0037   |
| CCE                  | 0037   |
| Celebrity            | 0000   |
| Celera               | 0765   |
| Celestial            | 0767   |
| Centrex              | 0780   |
| Centurion            | 0037   |
| Changcheng           | 0051, 0264, 0001, 0009, 0374, 0661                                     |
| Changfei             | 0009, 0374   |
| Changfeng            | 0264, 0753   |
| Changhai             | 0009   |
| Changhong            | 0156, 0765, 0264, 0508, 0009, 0767, 0783, 1156                         |
| Chengdu              | 0009   |
| Ching Tai            | 0009, 0092   |
| Chun Yun             | 0000, 0180, 0009, 0092, 0161, 0700, 1150                               |
| Chunfeng             | 0264, 0009   |
| Chung Hsin           | 0180, 0053, 0108, 1150   |
| Chunsun              | 0009   |
| Cimline              | 0009   |
| Cinema               | 0672   |
| Cineral              | 0451, 0092   |
| Citizen              | 0060, 0030, 0056, 0092   |
| Clarion              | 0180   |
| Clarivox             | 0037   |
| Clatronic            | 0370   |
| Commercial Solutions | 0047, 1447   |
| Concerto             | 0056   |
| Condor               | 0370   |
| Conrowa              | 0156, 0145, 0698, 0264, 0009, 0753, 1156                               |
| Contec               | 0180, 0009   |
| Craig                | 0180, 0161   |
| Crosley              | 0054   |
| Crown                | 0180, 0037, 0370, 0009, 0418, 0672                                     |
| Crown Mustang        | 0672   |
| Curtis Mathes        | 0047, 0054, 0154, 0451, 0060, 0702, 0030, 0145, 0166, 0056, 1147, 1347 |
| CXC                  | 0180   |

| TV                     |  |
|------------------------|--|
| Cybertron              | 0218   |
| Daewoo                 | 0154, 0451, 0180, 0030, 0037, 0634, 0108, 1150, 0880, 0700, 0672, 0661, 0623, 0374, 0170, 0092, 0056, 0009 |
| Dainichi               | 0218   |
| Dansai                 | 0037   |
| Dayton                 | 0009   |
| Dayu                   | 0374, 0661   |
| De Graaf               | 0548, 0208   |
| Decca                  | 0037   |
| Dell                   | 1454, 1080   |
| Denon                  | 0145, 0511   |
| Dick Smith Electronics | 0698   |
| Digatron               | 0037   |
| Digital Life           | 0780   |
| Digitor                | 0037, 0698   |
| Digix                  | 0880   |
| Dixi                   | 0037, 0009   |
| Dongda                 | 0009   |
| Donghai                | 0009   |
| DSE                    | 0698   |
| Dumont                 | 0017   |
| Durabrand              | 0463, 0180, 0171   |
| ECE                    | 0037   |
| Electroband            | 0000   |
| Elektra                | 0017   |
| Elin                   | 0037, 0548   |
| Elite                  | 0218   |
| Elta                   | 0009   |
| Emerson                | 0154, 0451, 0236, 0463, 0180, 0171, 0623   |
| Envision               | 0030   |
| Erres                  | 0037   |
| ESA                    | 0812, 0171   |
| Ether                  | 0030, 0009, 0161   |
| Etron                  | 0009   |
| Feilang                | 0009   |
| Feilu                  | 0009   |
| Feiyan                 | 0264   |
| Feiyue                 | 0009   |
| Ferguson               | 0037, 0560, 0109, 0335, 0343   |
| Finlandia              | 0208, 0346   |
| Finlux                 | 0037, 0105, 0346   |
| Firstar                | 0236, 0009   |
| Firstline              | 0009   |
| Fisher                 | 0154, 0370, 0208   |
| Formenti               | 0037   |
| Frontech               | 0264, 0163   |
| Fujitsu                | 0809, 1181   |
| Funai                  | 0180, 0171, 0264, 0342   |
| Furi                   | 0145, 0264   |
| Futuretech             | 0180   |



| TV            |  |
|---------------|--|
| GE            | 0047, 0051, 0451, 0180, 0030, 1447, 1454, 0560, 0092, 1147, 1347   |
| GEC           | 0037   |
| Geloso        | 0009   |
| Genexxa       | 0218, 0163   |
| Gibraltar     | 0017, 0030   |
| Gintai        | 1150   |
| Go Video      | 0886   |
| GoldStar      | 0154, 0030, 0037, 0001, 0056, 0109, 1150, 1378   |
| Goodmans      | 0037, 0634, 0343, 0360, 0371, 0374   |
| Gorenje       | 0370   |
| GPM           | 0218   |
| Gradiente     | 0053, 0056, 0170   |
| Graetz        | 0714, 0163   |
| Granada       | 0037, 0208   |
| Grandin       | 0610, 0880   |
| Grundig       | 0556, 0037, 0195, 0487, 0672   |
| Grunpy        | 0180   |
| Haier         | 0037, 0698, 0508, 0896   |
| Haihong       | 0009   |
| Haiyan        | 0264   |
| Hankook       | 0180, 0030, 0056   |
| Hanseatic     | 0556, 0037, 0661   |
| Harman/Kardon | 0054   |
| Harvard       | 0180   |
| Harwa         | 0773   |
| HCM           | 0009   |
| Hello Kitty   | 0451   |
| Himitsu       | 0180   |
| Hinari        | 0037, 0218, 0009   |
| Hisense       | 0156, 0748, 0145, 0556, 0508, 0009, 0753, 0780, 1156   |
| Hitachi       | 0156, 0030, 1145, 0145, 1256, 0548, 0225, 0508, 1378, 1245, 1156, 1150, 1149, 0744, 0578, 0577, 0481, 0163, 0109, 0105, 0092, 0056, 0009 |
| Hongmei       | 0264, 0009   |
| Hongyan       | 0264   |
| Hua Tun       | 0009, 1150   |
| Huafa         | 0145, 0009   |
| Huanghaimei   | 0009   |
| Huanghe       | 0009   |
| Huanglong     | 0009   |
| Huangshan     | 0264, 0009   |
| Huanyu        | 0264, 0374   |
| Huaqiang      | 0264   |
| Huari         | 0145, 0264   |
| Huodateji     | 0051   |
| Hypson        | 0037, 0264   |
| ICE           | 0264, 0371   |

| TV             |  |
|----------------|--|
| ICeS           | 0218   |
| Imperial       | 0370, 0418   |
| Imperial Crown | 0264, 0001, 0009, 0374, 0661                         |
| Indiana        | 0037   |
| Infinity       | 0054   |
| Ingelen        | 0163   |
| Innova         | 0037   |
| Inteq          | 0017   |
| Interfunk      | 0037, 0163, 0512                                     |
| Intervision    | 0037, 0264   |
| IRT            | 0451, 0698   |
| Isukai         | 0218   |
| ITS            | 0371   |
| ITT            | 0548, 0163   |
| IX             | 0877   |
| JBL            | 0054   |
| JCB            | 0000   |
| Jean           | 0156, 0051, 0236, 0009, 0092                         |
| Jensen         | 0761, 0815   |
| Jiahua         | 0051   |
| JiaLiCai       | 0264, 0009   |
| Jinfeng        | 0051, 0226, 0208                                     |
| Jinque         | 0264, 0009   |
| Jinta          | 0264, 0009   |
| Jinjing        | 0054, 0156, 0145, 0556, 0037, 0698, 0264, 0009       |
| Juhua          | 0264   |
| JVC            | 0463, 0053, 0606, 0653, 0508, 0160, 0371, 1172, 1253 |
| Kaige          | 0264, 0009   |
| Kaisui         | 0218, 0009   |
| Kanghua        | 0896   |
| Kangli         | 0264, 0001, 0009, 0374, 0661                         |
| Kangyi         | 0264, 0009   |
| Kapsch         | 0163   |
| Karcher        | 0610   |
| Kathrein       | 0556   |
| KEC            | 0180   |
| Kendo          | 0037   |
| Kenwood        | 0030   |
| Kioto          | 0054, 0556   |
| KLH            | 0765, 0767   |
| KLL            | 0037   |
| Kolin          | 0180, 0150, 0053, 0108, 1150                         |
| Kongque        | 0264, 0009   |
| Konka          | 0037   |
| Korpel         | 0037   |
| Koyoda         | 0009   |
| KTV            | 0180, 0030   |
| Kuaile         | 0264, 0009   |
| Kulun          | 0009   |
| Kunlun         | 0051, 0264, 0226, 0208, 0374, 0661                   |
| Leyco          | 0037, 0264   |

| TV             |  |
|----------------|--|
| LG             | 1265, 0060, 0030, 0037, 0714, 0108, 0001, 0056, 0442, 0644, 0700, 0856, 1148, 1378 |
| Liesenk & Tter | 0037   |
| Local India TV | 0264, 0371   |
| Loewe          | 0136, 0512, 0633, 0790   |
| Logik          | 0001, 1217   |
| Longjiang      | 0264   |
| Luxman         | 0056   |
| LXI            | 0047, 0054, 0154, 0156   |
| M & S          | 0054   |
| M Electronic   | 0037, 0009, 0105, 0109, 0163, 0346, 0374, 0480                                     |
| Magnavox       | 0054, 0030, 1454, 0780, 0802, 1254   |
| Manesth        | 0264   |
| Marantz        | 0054, 0030, 1454, 0556, 0037, 0855   |
| Mark           | 0037   |
| Matsui         | 0037, 0487, 0009, 0035, 0208, 0371   |
| Matsushita     | 0250, 0161   |
| Mediator       | 0037   |
| Medion         | 0880, 1248   |
| Megapower      | 0700   |
| Megatron       | 0145   |
| Meile          | 0264   |
| Memorex        | 0154, 0463, 0150, 0009   |
| Mercury        | 0001   |
| Mermaid        | 0037   |
| Metronic       | 0625   |
| MGA            | 0150, 0030   |
| Midland        | 0047, 0017, 0051   |
| Minerva        | 0487   |
| Mitsubishi     | 0154, 0250, 0236, 0180, 0150, 1250, 0030, 0108, 0056, 0512, 0836, 1150, 1171, 1182 |
| Monivision     | 0700   |
| MTC            | 0060, 0030, 0056, 0512   |
| Mudan          | 0051, 0264, 0226, 0009, 0208   |
| Multitech      | 0180, 0009   |
| Myryad         | 0556   |
| NAD            | 0156, 0866   |
| Nanbao         | 0264, 0009   |
| Nansheng       | 0264   |
| National       | 0051, 0226, 0508, 0208   |

| TV           |  |
|--------------|--|
| NEC          | 0154, 0156, 0051, 0053, 0030, 0264, 0508, 0009, 0056, 0170, 1150, 1182, 1378, 1456 |
| Neckermann   | 0556, 0037   |
| NEI          | 0037   |
| Netsat       | 0037   |
| Newave       | 0009, 0092, 0161, 1150   |
| Nikkai       | 0037, 0264, 0218, 0035   |
| Nikko        | 0030, 0092   |
| Noblex       | 0154   |
| Nokia        | 0548, 0606, 0480, 0631   |
| Norcent      | 0748, 0824   |
| Nordmende    | 0560, 0109, 0343   |
| NTC          | 0092   |
| Oceanic      | 0163   |
| Onwa         | 0180   |
| Optimus      | 0154, 0250, 0166   |
| Orion        | 0236, 0463, 0037, 0880, 1463   |
| Osaki        | 0264, 0218   |
| Oso          | 0218   |
| Otto Versand | 0556, 0037, 0343, 0512   |
| Palladium    | 0370, 0418   |
| Palsonic     | 0773   |
| Panama       | 0264   |
| Panasonic    | 0054, 0250, 0051, 0037, 0226, 0508, 0161, 0163, 0208, 0896, 1168, 1175, 1177, 1210 |
| Panda        | 0051, 0698, 0264, 0226, 0508, 0009, 0208, 0780                                     |
| Pausa        | 0009   |
| Penney       | 0047, 0156, 0051, 0060, 0030, 1347, 1378   |
| Philco       | 0054, 0463, 0180, 0030, 0145, 0037, 0056   |
| Philips      | 0054, 0000, 0051, 0030, 1454, 0556, 0037, 0108, 0056, 0092, 0374, 0512, 0690, 1455 |
| Phonola      | 0037   |
| Pilot        | 0030   |
| Pioneer      | 0166, 0109, 0163, 0760, 0866, 1260   |
| Polaroid     | 0765   |
| Portland     | 0092   |
| Prima        | 0761, 0783, 0815   |
| Princeton    | 0700   |
| Prism        | 0051   |
| Profex       | 0009   |
| Proscan      | 0047, 1447, 1347   |

| TV         |  |
|------------|--|
| Protech    | 0037, 0264, 0009, 0418   |
| Proton     | 0030, 0001, 0009, 0056, 0644   |
| Pulsar     | 0017   |
| Pye        | 0037   |
| Qingdao    | 0051, 0264, 0226, 0208   |
| Quasar     | 0250, 0051   |
| Quelle     | 0037, 0512   |
| R-Line     | 0037   |
| Radiola    | 0037   |
| RadioShack | 0047, 0154, 0180, 0030, 0056   |
| RCA        | 0047, 0000, 0060, 0030, 1447, 1454, 0618, 0090, 0092, 1047, 1147, 1247, 1347, 1547   |
| Realistic  | 0154, 0180, 0030, 0056   |
| Relisys    | 0877, 1207   |
| Reoc       | 0714   |
| Revox      | 0037   |
| Rex        | 0264, 0163   |
| Roadstar   | 0264, 0218, 0009, 0418   |
| Rowa       | 0748, 0037, 0698, 0712, 0009   |
| Runco      | 0017, 0030   |
| Saba       | 0109, 0163, 0335, 0343   |
| Sagem      | 0610   |
| Saige      | 0009   |
| Saisho     | 0264, 0009   |
| Salora     | 0548, 0163   |
| Sampo      | 0154, 0030, 0171, 0009, 0092, 0700   |
| Samsung    | 0154, 0156, 0060, 0812, 0702, 0030, 0556, 0037, 0264, 0370, 0618, 0226, 1150, 1060, 0814, 0766, 0644, 0208, 0092, 0090, 0056, 0009 |
| Sanjian    | 0264   |
| Sansei     | 0451   |
| Sansui     | 0463, 0729   |
| Sanyo      | 0154, 0156, 0180, 0145, 0264, 0508, 0088, 0208, 0376, 0424, 0799, 1150, 1179   |
| Sanyuan    | 0009   |
| SBR        | 0037   |
| Sceptre    | 1217   |
| Schneider  | 0037, 0218, 0371, 0394   |
| Scott      | 0236, 0180   |
| Sears      | 0047, 0054, 0154, 0156, 0171, 0056   |
| SEG        | 0264   |

| TV         |  |
|------------|--|
| Seleco     | 0163   |
| Semivox    | 0180   |
| Semp       | 0156, 1356   |
| Sentra     | 0035   |
| Shancha    | 0264   |
| Shanghai   | 0264, 0226, 0009, 0208                                     |
| Shaofeng   | 0145   |
| Sharp      | 0030, 0009, 0256, 0787, 0818, 1165                         |
| Shen Ying  | 0009, 0092   |
| Shencai    | 0145, 0264, 0009   |
| Sheng Chia | 0236, 0009, 1150   |
| Shenyang   | 0264, 0009, 0753   |
| Sherwood   | 0009   |
| Siemens    | 0037, 0195   |
| SKY        | 0037   |
| Skygiant   | 0180   |
| Skyworth   | 0748, 0037, 0698, 0264, 0009, 0753                         |
| Sliding    | 0880   |
| Solavox    | 0163   |
| Songba     | 0009   |
| Sonitron   | 0208   |
| Sonoko     | 0037, 0009   |
| Sonolor    | 0163, 0208   |
| Sontec     | 0037   |
| Sony       | 1100, 0000, 1505, 0353, 0810, 1167, 1300, 1651             |
| Soundesign | 0180   |
| Soundwave  | 0037, 0418   |
| Sowa       | 0156, 0051, 0060, 0226, 0092, 1150                         |
| Squareview | 0171   |
| SSS        | 0180   |
| Standard   | 0218, 0009   |
| Starlite   | 0180   |
| Stern      | 0163   |
| Superscan  | 0864   |
| Supra      | 0056   |
| Supreme    | 0000   |
| Susumu     | 0218   |
| SVA        | 0748   |
| Sylvania   | 0054, 0030, 0171   |
| Symphonic  | 0180, 0171   |
| Synco      | 0000, 0451, 0060, 0092                                     |
| Sysline    | 0037   |
| Tacico     | 0009, 0092, 1150   |
| Tai Yi     | 0009, 1150   |
| Taishan    | 0009, 0374   |
| Tandy      | 0218, 0163   |
| Tashiko    | 0092, 1150   |
| Tatung     | 0054, 0154, 0156, 0051, 0060, 0037, 0009, 1150, 1156, 1254 |
| TCL        | 0698   |

| <b>TV</b>       |  |
|-----------------|--|
| Teac            | 0037, 0698, 0712, 0264, 0009, 0418, 1149   |
| Technics        | 0250, 0051   |
| Technisson      | 0714   |
| Techwood        | 0051, 0056   |
| Teco            | 0051, 0264, 0218, 0653, 0009, 0092   |
| Teknika         | 0054, 0180, 0150, 0060, 0056, 0092   |
| Teleavia        | 0343   |
| Telefunken      | 0702, 0625, 0056, 0109, 0335, 0343, 0896   |
| Teletex         | 0009   |
| Tensai          | 0218   |
| Tera            | 0030, 0092   |
| Tevion          | 0767   |
| Textet          | 0218   |
| Thompson        | 0625   |
| Thomson         | 1447, 0625, 0560, 0109, 0343   |
| Thorn           | 0037, 0035, 0343, 0512   |
| Thorn-Ferguson  | 0343   |
| Tiny            | 1269   |
| TMK             | 0056   |
| TNCi            | 0017   |
| Tobo            | 0748, 0264, 0009   |
| Tongguang       | 0264   |
| Tongtel         | 0780   |
| Tophouse        | 0180   |
| Toshiba         | 0154, 0156, 1265, 0060, 0145, 1256, 0264, 0618, 0508, 1456, 1356, 1173, 1169, 1156, 1150, 0845, 0644, 0509, 0241, 0161, 0035, 0009 |
| Transonic       | 0698, 0712   |
| Tuntex          | 0030, 0009, 0092   |
| TVS             | 0463   |
| Universum       | 0037, 0264, 0370, 0105, 0346, 0492   |
| Vector Research | 0030   |
| Vestel          | 0037   |
| Victor          | 0250, 0053, 0653, 0160, 0376   |
| Videocon        | 0508   |
| Vidikron        | 0054   |
| Viewsonic       | 0857, 0864, 0885   |
| Viore           | 1207   |
| Vizio           | 0864, 0885   |
| Voxson          | 0163   |
| Wards           | 0054, 0030, 0056, 0866, 1156   |
| Warumaia        | 0374, 0661   |
| Watson          | 0037   |
| Waycon          | 0156   |
| Weipai          | 0009   |
| Westinghouse    | 0451, 0889   |

| <b>TV</b>          |                        |
|--------------------|------------------------|
| White Westinghouse | 0463, 0037, 0623       |
| Xenius             | 0661                   |
| Xiahua             | 0698, 0264, 0009, 0773 |
| Xianghai           | 0009                   |
| Xiangyang          | 0264                   |
| Xiangyu            | 0009                   |
| Xihu               | 0264                   |
| Xingfu             | 0009                   |
| Xinghai            | 0264                   |
| Xoro               | 1217                   |
| Yamaha             | 0030                   |
| Yapshe             | 0250                   |
| Yingge             | 0009                   |
| Yoko               | 0037, 0264             |
| Yonggu             | 0009                   |
| Yousida            | 0009                   |
| Yuhang             | 0009                   |
| Zenith             | 0017, 0463, 1145, 0092 |
| ZhuHai             | 0009, 0374             |
| Zonda              | 0698                   |

| <b>VCR</b>             |  |
|------------------------|--|
| ABS                    | 1972   |
| Admiral                | 0209, 0479   |
| Aiwa                   | 0348, 0307, 0352, 0124, 0479, 1291                                     |
| Akai                   | 0041, 0315, 0175   |
| Akiba                  | 0072   |
| Alba                   | 0209, 0072, 0352, 0315   |
| Alienware              | 1972   |
| American High          | 0035   |
| Amoisonic              | 0479   |
| Anam                   | 0162, 0226, 0480, 1037   |
| Anam National          | 0162, 1562, 0226   |
| Anitech                | 0072   |
| Baird                  | 0041   |
| Basic Line             | 0072   |
| Blaupunkt              | 0162, 0226   |
| Brandt                 | 0320   |
| Brandt Electronique    | 0041   |
| Broksonic              | 0184, 0121, 0209, 0002, 0348, 0479, 1479                               |
| Bush                   | 0209, 0072, 0352   |
| Canon                  | 0035   |
| CCE                    | 0072   |
| Cimline                | 0072   |
| Citizen                | 1278   |
| Colt                   | 0072   |
| Combitech              | 0352   |
| Craig                  | 0047, 0072   |
| Crown                  | 0072   |
| Curtis Mathes          | 0060, 0035, 0162, 0041, 1035   |
| CyberPower             | 1972   |
| Daewoo                 | 0637, 0642, 0046, 1278   |
| Dansai                 | 0072   |
| Dell                   | 1972   |
| Dick Smith Electronics | 0642   |
| Digitor                | 0642   |
| DirecTV                | 0739   |
| DSE                    | 0642   |
| Dual                   | 0041   |
| Durabrand              | 0039   |
| Elcatech               | 0072   |
| Emerson                | 0035, 0184, 0121, 0209, 0002, 0637, 0348, 0479, 0593, 1278, 1479, 1593 |
| Ferguson               | 0041, 0320   |
| Firstline              | 0209, 0072   |
| Fisher                 | 0047, 0046   |
| Fuji                   | 0035, 0033   |
| Funai                  | 0593, 1593   |
| Gateway                | 1972   |
| GE                     | 0060, 0035, 0226, 0807, 1035, 1060                                     |
| Go Video               | 0432   |

| <b>VCR</b>             |  |
|------------------------|--|
| GoldHand               | 0072   |
| GoldStar               | 0209, 0226, 0225, 0480, 1237   |
| Goodmans               | 0072, 0637   |
| Graetz                 | 0041   |
| Granada                | 0046   |
| Grandin                | 0072   |
| Grundig                | 0072, 0226   |
| Harwood                | 0072   |
| HCM                    | 0072   |
| Headquarter            | 0046   |
| Hewlett Packard        | 1972   |
| HI-Q                   | 0047   |
| Hinari                 | 0072, 0352   |
| Hitachi                | 0041, 0089, 1037   |
| Howard Computers       | 1972   |
| HP                     | 1972   |
| Hughes Network Systems | 0739   |
| Humax                  | 0739   |
| Hush                   | 1972   |
| Hypson                 | 0072   |
| iBUYPOWER              | 1972   |
| ITT                    | 0041, 0046   |
| Jensen                 | 0041   |
| JVC                    | 0041, 1162, 1279   |
| Kaisui                 | 0072   |
| Kendo                  | 0209   |
| Kenwood                | 0041   |
| Kioto                  | 0348   |
| KLH                    | 0072   |
| Kodak                  | 0035   |
| Kolin                  | 0041   |
| Korpel                 | 0072   |
| Leyco                  | 0072   |
| LG                     | 0209, 0480, 1037   |
| Linksys                | 1972   |
| Loewe                  | 0162, 1562   |
| Logik                  | 0072   |
| Luxor                  | 0046   |
| Magnasonic             | 0593, 1278   |
| Magnavox               | 0035, 0039, 0149, 0563, 0593, 1781   |
| Manesth                | 0072   |
| Marantz                | 0035   |
| Matsui                 | 0209, 0348, 0352   |
| Matsushita             | 0035, 0162, 0226, 1162   |
| Media Center PC        | 1972   |
| Medion                 | 0348   |
| MEI                    | 0035   |
| Memorex                | 0035, 0162, 0039, 0047, 0209, 0348, 0307, 0046, 0479, 1037, 1162, 1237, 1262 |
| Memphis                | 0072   |
| Metz                   | 0162, 1562   |
| Microsoft              | 1972   |

| <b>VCR</b>    |  |
|---------------|--|
| Mind          | 1972   |
| Mitsubishi    | 0041, 0807, 1343   |
| Motorola      | 0035   |
| Multitech     | 0072   |
| National      | 0226   |
| NEC           | 0035, 0041, 1287   |
| Nesco         | 0072   |
| Niveus Media  | 1972   |
| Nokia         | 0041, 0046   |
| Nordmende     | 0041, 0320   |
| Northgate     | 1972   |
| Oceanic       | 0041   |
| Okano         | 0348, 0315   |
| Olympus       | 0035, 0226   |
| Optimus       | 1062, 0162, 0432, 0593, 1162, 1262   |
| Orion         | 0184, 0121, 0209, 0002, 0348, 0352, 0479, 1479                               |
| Osaki         | 0072   |
| Palladium     | 0041, 0072   |
| Panasonic     | 1062, 0035, 0162, 1562, 0226, 0225, 0616, 0836, 1035, 1162, 1244, 1262, 1293 |
| Pathe Marconi | 0041   |
| Penney        | 0035, 1035, 1237   |
| Philco        | 0035, 0209, 0226, 0479   |
| Philips       | 0035, 0226, 0563, 0593, 0618, 0739, 1081, 1181, 1818                         |
| Proscan       | 0060, 1060   |
| Protec        | 0072   |
| Pulsar        | 0039   |
| Qisheng       | 0060   |
| Quarter       | 0046   |
| Quartz        | 0046   |
| Quasar        | 0035, 0162, 1035, 1162   |
| RadioShack    | 1037   |
| RCA           | 0060, 0035, 0149, 0226, 0807, 0880, 1035, 1060                               |
| Realistic     | 0035, 0047, 0046   |
| Reoc          | 0348   |
| ReplayTV      | 0614, 0616   |
| Rex           | 0041   |
| Ricavision    | 1972   |
| Roadstar      | 0072   |
| Runco         | 0039   |
| Saba          | 0041, 0320   |
| Saisho        | 0209   |
| Salora        | 0046   |
| Samsung       | 0432, 0739, 1014   |
| Sanky         | 0039   |
| Sansui        | 0209, 0041, 0479, 1479   |

| <b>VCR</b>         |  |
|--------------------|--|
| Sanyo              | 0047, 0046, 0159, 1330   |
| Saville            | 0352   |
| Schaub Lorenz      | 0041   |
| Schneider          | 0072   |
| Scott              | 0184, 0121   |
| Sears              | 0035, 0047, 0046, 1237   |
| Seleco             | 0041   |
| Sharp              | 0209, 0807, 0848, 1285   |
| Shintom            | 0072   |
| Singer             | 0072   |
| Sonic Blue         | 0614, 0616   |
| Sonolor            | 0046   |
| Sony               | 0035, 0033, 0636, 1032, 1232, 1295, 1296, 1447, 1448, 1636, 1972 |
| Stack 9            | 1972   |
| Sunkai             | 0348   |
| Sylvania           | 0035, 0593, 1593, 1781   |
| Symphonic          | 0593, 1593   |
| Systemax           | 1972   |
| Tagar Systems      | 1972   |
| Tatung             | 0041   |
| Teac               | 0041, 0637, 0307, 0642, 0593                                     |
| Technics           | 0035, 0162, 0226   |
| Teco               | 0035, 0041   |
| Teknika            | 0035   |
| Teleavia           | 0041   |
| Telefunken         | 0041, 0320   |
| Tenosal            | 0072   |
| Thomson            | 0060, 0041, 0320   |
| Thorn              | 0041   |
| Tivo               | 0618, 0636, 0739, 1996   |
| Toshiba            | 0209, 0041, 0828, 0845, 1008, 1145, 1290, 1972, 1996             |
| Touch              | 1972   |
| Victor             | 0041   |
| Viewsonic          | 1972   |
| Voodoo             | 1972   |
| Wards              | 0060, 0035, 0047, 0072, 0149                                     |
| Wharfedale         | 0593   |
| White Westinghouse | 0209, 0072, 0637   |
| XR-1000            | 0035, 0072   |
| Yamaha             | 0041   |
| Yamishi            | 0072   |
| Yokan              | 0072   |
| Zenith             | 0039, 0033, 0209, 0637, 0479, 1139, 1479                         |
| ZT Group           | 1972   |

| <b>DBS/PVR Combination</b> |                              |
|----------------------------|------------------------------|
| Hughes Network Systems     | 0739                         |
| Philips                    | 0739                         |
| Samsung                    | 0739                         |
| <b>PVR</b>                 |                              |
| ABS                        | 1972                         |
| Alienware                  | 1972                         |
| CyberPower                 | 1972                         |
| Dell                       | 1972                         |
| DirecTV                    | 0739                         |
| Gateway                    | 1972                         |
| Hewlett Packard            | 1972                         |
| Howard Computers           | 1972                         |
| HP                         | 1972                         |
| Hughes Network Systems     | 0739                         |
| Humax                      | 0739                         |
| Hush                       | 1972                         |
| iBUYPOWER                  | 1972                         |
| JVC                        | 1279                         |
| Linksys                    | 1972                         |
| Media Center PC            | 1972                         |
| Microsoft                  | 1972                         |
| Mind                       | 1972                         |
| Niveus Media               | 1972                         |
| Northgate                  | 1972                         |
| Panasonic                  | 0616, 1244                   |
| Philips                    | 0618, 0739, 1818             |
| RCA                        | 0880                         |
| ReplayTV                   | 0614, 0616                   |
| Sonic Blue                 | 0614, 0616                   |
| Sony                       | 0636, 1447, 1448, 1636, 1972 |
| Stack 9                    | 1972                         |
| Systemax                   | 1972                         |
| Tagar Systems              | 1972                         |
| Tivo                       | 0618, 0636, 0739             |
| Toshiba                    | 0828, 1008, 1972             |
| Touch                      | 1972                         |
| Viewsonic                  | 1972                         |
| Voodoo                     | 1972                         |
| ZT Group                   | 1972                         |

| <b>TV/VCR Combination</b> |                                    |
|---------------------------|------------------------------------|
| Aiwa                      | 0479                               |
| Broksonic                 | 0002, 0479, 1479                   |
| Citizen                   | 1278                               |
| Colt                      | 0072                               |
| Curtis Mathes             | 1035                               |
| Daewoo                    | 0637, 1278                         |
| Emerson                   | 0002, 0637, 0479, 0593, 1278, 1479 |
| GE                        | 0807, 1035, 1060                   |
| GoldStar                  | 1237                               |
| Goodmans                  | 0637                               |
| LG                        | 0480, 1037                         |
| Magnasonic                | 0593, 1278                         |
| Magnavox                  | 0593, 1781                         |
| Memorex                   | 0162, 1037, 1162, 1237, 1262       |
| Mitsubishi                | 0807                               |
| Optimus                   | 0162, 0593, 1162, 1262             |
| Orion                     | 0002, 0479, 1479                   |
| Panasonic                 | 0162, 1035, 1162, 1262             |
| Penney                    | 1035, 1237                         |
| Philco                    | 0479                               |
| Quasar                    | 0162, 1035, 1162                   |
| RadioShack                | 1037                               |
| RCA                       | 0807, 1035, 1060                   |
| Samsung                   | 0432, 1014                         |
| Sansui                    | 0479, 1479                         |
| Sanyo                     | 1330                               |
| Sears                     | 1237                               |
| Sharp                     | 0807                               |
| Sony                      | 1232, 1295, 1296                   |
| Sylvania                  | 1781                               |
| Symphonic                 | 0593                               |
| Teac                      | 0637, 0593                         |
| Toshiba                   | 0845, 1145                         |
| White Westinghouse        | 0637                               |
| Zenith                    | 0637, 0479, 1479                   |

**Cable Converter**

|                          |                                    |
|--------------------------|------------------------------------|
| ABC                      | 0003, 0008, 0033                   |
| Americast                | 0899                               |
| Amstrad                  | 1222                               |
| Bell South               | 0899                               |
| British Telecom          | 0003                               |
| Cable & Wireless         | 1068                               |
| Clearmaster              | 0883                               |
| ClearMax                 | 0883                               |
| Contec                   | 0019                               |
| Coolmax                  | 0883                               |
| Daeryung                 | 0877, 1877, 0477, 0008             |
| Digeo                    | 1187                               |
| Director                 | 0476                               |
| DX Antenna               | 1500                               |
| Filmnet                  | 0443                               |
| France Telecom           | 1734                               |
| Fujitsu                  | 1497                               |
| Funai                    | 0019                               |
| Gehua                    | 0476                               |
| General Instrument       | 0476, 0810, 0003                   |
| GoldStar                 | 0144                               |
| Hamlin                   | 0009, 0273                         |
| Hitachi                  | 0033                               |
| Jerrold                  | 0476, 0810, 0003, 0012             |
| KNC                      | 0008                               |
| LG                       | 0144                               |
| Macom                    | 0033                               |
| Memorex                  | 0000                               |
| MNET                     | 0019, 0443                         |
| Motorola                 | 1376, 0476, 0810, 1187, 1483       |
| Multichoice              | 0019, 0443                         |
| Multitech                | 0883                               |
| MultiVision              | 0012                               |
| NEC                      | 1496                               |
| Noos                     | 0817, 1624                         |
| NTL                      | 1068, 1060, 0003                   |
| Oak                      | 0019                               |
| Ono                      | 1068                               |
| Pace                     | 1877, 0237, 1068, 1060, 0008, 1577 |
| Panasonic                | 0000, 0107, 0008, 1488             |
| Paragon                  | 0000                               |
| Philips                  | 0317, 1305                         |
| Pioneer                  | 0877, 1877, 0144, 0533, 1021, 1500 |
| Pulsar                   | 0000                               |
| PVP Stereo Visual Matrix | 0003                               |
| Quasar                   | 0000                               |
| RadioShack               | 0883                               |
| Regal                    | 0279, 0273                         |
| Runco                    | 0000                               |
| Sagem                    | 0817                               |
| Samsung                  | 0000, 0144, 1666                   |
| Scientific Atlanta       | 0877, 1877, 0477, 0008             |

**Cable Converter**

|              |                  |
|--------------|------------------|
| Sony         | 1006, 1460       |
| Starcom      | 0003             |
| Sumitomo     | 1500             |
| Supermax     | 0883             |
| Tele Danmark | 1016             |
| Tele+1       | 0443             |
| Telewest     | 1068             |
| Thomson      | 1734             |
| Tocom        | 0012             |
| Torx         | 0003             |
| Toshiba      | 0000, 1509       |
| Tristar      | 0883             |
| TS           | 0003             |
| United Cable | 0003             |
| V2           | 0883             |
| Viewmaster   | 0883             |
| Vision       | 0883             |
| Vortex View  | 0883             |
| Zenith       | 0000, 0525, 0899 |

**Cable/PVR Combination**

|                    |                        |
|--------------------|------------------------|
| Americast          | 0899                   |
| Digeo              | 1187                   |
| France Telecom     | 1734                   |
| General Instrument | 0476, 0810             |
| Jerrold            | 0476, 0810             |
| Motorola           | 1376, 0476, 0810, 1187 |
| Noos               | 1624                   |
| Pace               | 1877, 0237             |
| Pioneer            | 0877, 1877             |
| Scientific Atlanta | 0877, 1877             |
| Sony               | 1006                   |
| Thomson            | 1734                   |
| Zenith             | 0899                   |

**Satellite Receiver**

|                          |  |
|--------------------------|--|
| @sat                     | 1300   |
| @ Sky                    | 1334   |
| ADB                      | 1259, 1367   |
| Aiwa                     | 1514   |
| Alba                     | 1284   |
| AlphaStar                | 0772   |
| Amstrad                  | 0847, 0338   |
| Ankaro                   | 0713   |
| Astro                    | 0173   |
| Atsat                    | 1300   |
| AtSky                    | 1334   |
| Austar                   | 0642, 1259   |
| Black Diamond            | 1284   |
| Blaupunkt                | 0173   |
| British Sky Broadcasting | 0847, 1175   |
| Bush                     | 1284, 1672   |
| Canal Digital            | 0853   |
| Canal+                   | 0853   |
| CanalSatellite           | 0853, 1339, 1853   |
| Chaparral                | 0216   |
| CNS                      | 1367   |
| Comag                    | 1412   |
| Crossdigital             | 1109   |
| Cyrus                    | 0200   |
| D-box                    | 0873   |
| Dgtec                    | 1242, 1542   |
| Digenius                 | 0299   |
| Digiturk                 | 1076   |
| DirecTV                  | 1377, 0392, 0566, 0639, 1639, 1142, 0247, 0749, 1749, 0724, 0819, 1856, 1076, 1108, 1109, 1392, 1414, 1442, 1443, 1444, 1609, 1640 |
| Dish Network System      | 1505, 1005, 0775, 1170, 1775   |
| Dishpro                  | 1505, 1005, 0775, 1775   |
| DMT                      | 1075   |
| DNT                      | 0200   |
| Dream Multimedia         | 1237   |
| DSTV                     | 1433   |
| DX Antenna               | 1530   |
| Echostar                 | 1505, 1005, 0775, 0853, 0610, 1200, 0713, 1170, 1775   |
| Expressvu                | 0775, 1775   |
| Ferguson                 | 0711, 1291   |
| Foxtel                   | 0879, 1356   |
| Funai                    | 0338   |
| GbSAT                    | 1214   |
| GE                       | 0392, 0566   |
| General Instrument       | 0869   |
| GOI                      | 0775, 1775   |
| Gold Box                 | 0853   |
| Goodmans                 | 1246, 1284   |
| Gradiente                | 0887   |
| Grundig                  | 0847, 0173, 1291   |

**Satellite Receiver**

|                        |  |
|------------------------|--|
| Hirschmann             | 0173   |
| Hisense                | 1535   |
| Hitachi                | 0819, 1250, 1284, 1525   |
| HTS                    | 0775, 1775   |
| Hughes                 | 0749, 1749, 1442   |
| Hughes Network Systems | 1142, 0749, 1749, 1442, 1443, 1444   |
| Humax                  | 1176, 1427, 1675   |
| iLo                    | 1535   |
| Indovision             | 0887   |
| ISkyB                  | 0887   |
| Jerrold                | 0869   |
| JVC                    | 0775, 0492, 1170, 1531, 1775   |
| Kathrein               | 0173, 0200, 0442, 0480, 0504, 0622, 0658, 1416, 1567                                     |
| Kreiselmeier           | 0173   |
| LG                     | 1226, 1414   |
| Lorenzen               | 0299   |
| Magnavox               | 0724, 0722   |
| Marantz                | 0200   |
| Maspro                 | 1530   |
| Matsui                 | 1284   |
| Maximum                | 1334   |
| MediaSat               | 0853   |
| Medion                 | 1232, 1626   |
| Memorex                | 0724   |
| Metronic               | 0132, 0713, 1283, 1334   |
| Mitsubishi             | 0749   |
| Morgan's               | 0132   |
| Motorola               | 0869   |
| Multichoice            | 0879, 0642, 1433   |
| Myryad                 | 0200   |
| NEC                    | 1270, 1519   |
| Netsat                 | 0887   |
| Next Level             | 0869   |
| Nikko                  | 0713   |
| Nokia                  | 0873, 1023, 1223, 1310   |
| OctalTV                | 1505   |
| Opentel                | 1232, 1412   |
| Optex                  | 1283   |
| Orbitech               | 1100   |
| Pace                   | 0847, 0887, 0720, 1175, 0241, 0791, 1323, 1850   |
| Panasat                | 0879   |
| Panasonic              | 0247, 0701, 0847, 1304, 1404, 1526   |
| Paysat                 | 0724   |
| Philips                | 1142, 0749, 1749, 0724, 0819, 1076, 0722, 0853, 0200, 1114, 0887, 0133, 0898, 1442, 1672 |
| Pioneer                | 0853, 0329, 1308, 1442   |
| Plasmatic              | 0442   |

**Satellite Receiver**

|               |  |
|---------------|--|
| Preisner      | 0132, 0262   |
| Proscan       | 0392, 0566   |
| Proton        | 1535   |
| QNS           | 1367, 1404   |
| Radiola       | 0200   |
| RadioShack    | 0869   |
| RCA           | 0392, 0566, 0855, 0143, 1291, 1392                   |
| Rebox         | 1214   |
| Sagem         | 0820, 1114, 1690                                     |
| Samsung       | 1377, 1142, 1276, 1108, 1109, 1442, 1458, 1570, 1609 |
| Sanyo         | 1219   |
| Sat Control   | 1300   |
| Schwaiger     | 0504   |
| SEG           | 1626   |
| Sharp         | 1517   |
| Siemens       | 0173   |
| SKY           | 1856, 0847, 0887, 1175, 1848, 1850                   |
| Skymaster     | 0713, 1409   |
| Skyplus       | 1334, 1412   |
| SM Electronic | 1200, 0713, 1409                                     |
| Smart         | 0132   |
| Sony          | 0639, 1639, 0847, 1524, 1558, 1640                   |
| Star          | 0887   |
| Star Choice   | 0869   |
| Strong        | 0879, 0132, 1146, 1300, 1409, 1626                   |
| Supernova     | 0887   |
| Teac          | 1227   |
| TechniSat     | 0262, 1099, 1100                                     |
| Technomate    | 1610   |
| Technotrend   | 1429   |
| Techwood      | 1284   |
| Telestar      | 1100, 1334   |
| Televisa      | 0887   |
| Tevion        | 1409   |
| Thomson       | 0853, 0711, 1046, 1291, 1534, 1900                   |
| Tiny          | 1672   |
| Tivo          | 1142, 1442, 1443, 1444                               |
| Topfield      | 1206, 1208, 1545                                     |
| Toshiba       | 0749, 1749, 0790, 0819, 1285, 1516, 1530             |
| TPS           | 0820   |
| UEC           | 0879   |
| UltimateTV    | 1392, 1640   |
| Uniden        | 0724, 0722, 1521                                     |
| Universum     | 0173   |
| US Digital    | 1535   |
| USDTV         | 1535   |
| Ventana       | 0200   |
| Victor        | 0492   |
| Voom          | 0869   |
| Wisi          | 0173   |
| Xsat          | 1323   |

**Satellite Receiver**

|         |                        |
|---------|------------------------|
| Yes     | 0887                   |
| Zehnder | 1075, 1232, 1334, 1412 |
| Zenith  | 1856                   |

**DBS/PVR Combination**

|                          |  |
|--------------------------|--|
| @sat                     | 1300   |
| Atsat                    | 1300   |
| British Sky Broadcasting | 1175   |
| CanalSatellite           | 1339   |
| Comag                    | 1412   |
| Digiturk                 | 1076   |
| DirecTV                  | 1377, 0392, 0639, 1142, 1076, 1392, 1442, 1443, 1444, 1640 |
| Dish Network System      | 1505, 0775   |
| Dishpro                  | 1505, 0775   |
| Dream Multimedia         | 1237   |
| Echostar                 | 1505, 0775, 0610, 1170                                     |
| Expressvu                | 0775   |
| Foxtel                   | 1356   |
| GbSAT                    | 1214   |
| Hughes Network Systems   | 1142, 1442, 1443, 1444                                     |
| Humax                    | 1176, 1427, 1675   |
| JVC                      | 1170   |
| Maximum                  | 1334   |
| Motorola                 | 0869   |
| Nokia                    | 1310   |
| Opentel                  | 1412   |
| Philips                  | 1142, 1442   |
| Proscan                  | 0392   |
| RCA                      | 1392   |
| Rebox                    | 1214   |
| Samsung                  | 1442   |
| SKY                      | 1175, 1848, 1850   |
| Skyplus                  | 1412   |
| Sony                     | 0639, 1640   |
| Star Choice              | 0869   |
| Strong                   | 1300   |
| Thomson                  | 1534, 1900   |
| Topfield                 | 1206, 1545   |
| Zehnder                  | 1075, 1412   |

## **ONKYO CORPORATION**

Sales & Product Planning Div. : 2-1, Nisshin-cho, Neyagawa-shi, OSAKA 572-8540, JAPAN  
Tel: 072-831-8023 Fax: 072-831-8124

### **ONKYO U.S.A. CORPORATION**

18 Park Way, Upper Saddle River, N.J. 07458, U.S.A.  
Tel: 201-785-2600 Fax: 201-785-2650 <http://www.us.onkyo.com/>

### **ONKYO EUROPE ELECTRONICS GmbH**

Liegnitzerstrasse 6, 82194 Groebenzell, GERMANY  
Tel: +49-8142-4401-0 Fax: +49-8142-4401-555 <http://www.eu.onkyo.com/>

### **ONKYO EUROPE UK Office**

Suite 1, Gregories Court, Gregories Road, Beaconsfield, Buckinghamshire, HP9 1HQ  
UNITED KINGDOM Tel: +44-(0)1494-681515 Fax: +44(0)-1494-680452

### **ONKYO CHINA LIMITED**

Units 2102-2107, Metroplaza Tower I, 223 Hing Fong Road, Kwai Chung,  
N.T., HONG KONG Tel: 852-2429-3118 Fax: 852-2428-9039  
<http://www.ch.onkyo.com/>



I0603-2

647

SN 29344188A

(C) Copyright 2006 ONKYO CORPORATION Japan. All rights reserved.



Download from [www.Somanuals.com](http://www.Somanuals.com). All Manuals Search And Download \* 2 9 3 4 4 1 8 8 A \*



## Free Manuals Download Website

<http://myh66.com>

<http://usermanuals.us>

<http://www.somanuals.com>

<http://www.4manuals.cc>

<http://www.manual-lib.com>

<http://www.404manual.com>

<http://www.luxmanual.com>

<http://aubethermostatmanual.com>

Golf course search by state

<http://golfingnear.com>

Email search by domain

<http://emailbydomain.com>

Auto manuals search

<http://auto.somanuals.com>

TV manuals search

<http://tv.somanuals.com>