

# ONKYO®

## AV Receiver

# *TX-SR800*

## Instruction Manual

Thank you for purchasing the Onkyo AV Receiver. Please read this manual thoroughly before making connections and plugging in the unit. Following the instructions in this manual will enable you to obtain optimum performance and listening enjoyment from your new AV Receiver. Please retain this manual for future reference.

## Contents

<b>Before using</b>	<b>2</b>
<b>Facilities and connections</b>	<b>8</b>
<b>Setup and operation</b>	<b>29</b>
<b>Remote controller</b>	<b>61</b>
<b>Appendix</b>	<b>73</b>



## WARNING:

TO REDUCE THE RISK OF FIRE OR ELECTRIC SHOCK, DO NOT EXPOSE THIS APPLIANCE TO RAIN OR MOISTURE.

## CAUTION:

TO REDUCE THE RISK OF ELECTRIC SHOCK, DO NOT REMOVE COVER (OR BACK). NO USER-SERVICEABLE PARTS INSIDE. REFER SERVICING TO QUALIFIED SERVICE PERSONNEL.



**WARNING**  
RISK OF ELECTRIC SHOCK  
DO NOT OPEN

**AVIS**  
RISQUE DE CHOC ELECTRIQUE  
NE PAS OUVRIR



The lightning flash with arrowhead symbol, within an equilateral triangle, is intended to alert the user to the presence of uninsulated "dangerous voltage" within the product's enclosure that may be of sufficient magnitude to constitute a risk of electric shock to persons.



The exclamation point within an equilateral triangle is intended to alert the user to the presence of important operating and maintenance (servicing) instructions in the literature accompanying the appliance.

# Important Safeguards

- 1. Read Instructions** – All the safety and operating instructions should be read before the appliance is operated.
- 2. Retain Instructions** – The safety and operating instructions should be retained for future reference.
- 3. Heed Warnings** – All warnings on the appliance and in the operating instructions should be adhered to.
- 4. Follow Instructions** – All operating and use instructions should be followed.
- 5. Cleaning** – Unplug the appliance from the wall outlet before cleaning. The appliance should be cleaned only as recommended by the manufacturer.
- 6. Attachments** – Do not use attachments not recommended by the appliance manufacturer as they may cause hazards.
- 7. Water and Moisture** – Do not use the appliance near water –for example, near a bath tub, wash bowl, kitchen sink, or laundry tub; in a wet basement; or near a swimming pool; and the like.
- 8. Accessories** – Do not place the appliance on an unstable cart, stand, tripod, bracket, or table. The appliance may fall, causing serious injury to a child or adult, and serious damage to the appliance. Use only with a cart, stand, tripod, bracket, or table recommended by the manufacturer, or sold with the appliance. Any mounting of the appliance should follow the manufacturer's instructions, and should use a mounting accessory recommended by the manufacturer.
- 9. An appliance and cart combination should be moved with care.** Quick stops, excessive force, and uneven surfaces may cause the appliance and cart combination to overturn.
- 10. Ventilation** – Slots and openings in the cabinet are provided for ventilation and to ensure reliable operation of the appliance and to protect it from overheating, and these openings must not be blocked or covered. The openings should never be blocked by placing the appliance on a bed, sofa, rug, or other similar surface. The appliance should not be placed in a built-in installation such as a bookcase or rack unless proper ventilation is provided. There should be free space of at least 20 cm (8 in.) and an opening behind the appliance.
- 11. Power Sources** – The appliance should be operated only from the type of power source indicated on the marking label. If you are not sure of the type of power supply to your home, consult your appliance dealer or local power company.
- 12. Grounding or Polarization** – The appliance may be equipped with a polarized alternating current line plug (a plug having one blade wider than the other). This plug will fit into the power outlet only one way. This is a safety feature. If you are unable to insert the plug fully into the outlet, try reversing the plug. If the plug should still fail to fit, contact your electrician to replace your obsolete outlet. Do not defeat the safety purpose of the polarized plug.
- 13. Power-Cord Protection** – Power-supply cords should be routed so that they are not likely to be walked on or pinched by items placed upon or against them, paying particular attention to cords at plugs, convenience receptacles, and the point where they exit from the appliance.
- 14. Outdoor Antenna Grounding** – If an outside antenna or cable system is connected to the appliance, be sure the antenna or cable system is grounded so as to provide some protection against voltage surges and built-up static charges. Article 810 of the National Electrical Code, ANSI/NFPA 70, provides information with regard to proper grounding of the mast and supporting structure, grounding of the lead-in wire to an antenna-discharge unit, size of grounding conductors, location of antenna-discharge unit, connection to grounding electrodes, and requirements for the grounding electrode. See Figure 1.
- 15. Lightning** – For added protection for the appliance during a lightning storm, or when it is left unattended and unused for long periods of time, unplug it from the wall outlet and disconnect the antenna or cable system. This will prevent damage to the appliance due to lightning and power-line surges.
- 16. Power Lines** – An outside antenna system should not be located in the vicinity of overhead power lines or other electric light or power circuits, or where it can fall into such power lines or circuits. When installing an outside antenna system, extreme care should be taken to keep from touching such power lines or circuits as contact with them might be fatal.
- 17. Overloading** – Do not overload wall outlets, extension cords, or integral convenience receptacles as this can result in a risk of fire or electric shock.
- 18. Object and Liquid Entry** – Never push objects of any kind into the appliance through openings as they may touch dangerous voltage points or short-out parts that could result in a fire or electric shock. Never spill liquid of any kind on the appliance.
- 19. Servicing** – Do not attempt to service the appliance yourself as opening or removing covers may expose you to dangerous voltage or other hazards. Refer all servicing to qualified service personnel.
- 20. Damage Requiring Service** – Unplug the appliance from the wall outlet and refer servicing to qualified service personnel under the following conditions:
  - When the power-supply cord or plug is damaged,
  - If liquid has been spilled, or objects have fallen into the appliance,
  - If the appliance has been exposed to rain or water,
  - If the appliance does not operate normally by following the operating instructions. Adjust only those controls that are covered by the operating instructions as an improper adjustment of other controls may result in damage and will often require extensive work by a qualified technician to restore the appliance to its normal operation,
  - If the appliance has been dropped or damaged in any way, and
  - When the appliance exhibits a distinct change in performance – this indicates a need for service.

PORTABLE CART WARNING



S3125A

21. **Replacement Parts** – When replacement parts are required, be sure the service technician has used replacement parts specified by the manufacturer or have the same characteristics as the original part. Unauthorized substitutions may result in fire, electric shock, or other hazards.
22. **Safety Check** – Upon completion of any service or repairs to the appliance, ask the service technician to perform safety checks to determine that the appliance is in proper operation condition.
23. **Wall or Ceiling Mounting** – The appliance should be mounted to a wall or ceiling only as recommended by the manufacturer.
24. **Heat** – The appliance should be situated away from heat sources such as radiators, heat registers, stoves, or other appliances (including amplifiers) that produce heat.
25. **Liquid Hazards** – The appliance shall not be exposed to dripping or splashing and no objects filled with liquids, such as vases shall be placed on the appliance.

FIGURE 1:  
EXAMPLE OF ANTENNA GROUNDING AS PER NATIONAL  
ELECTRICAL CODE, ANSI/NFPA 70

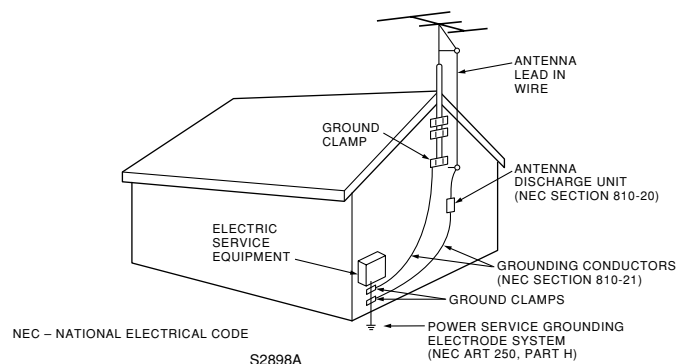

## Precautions

### 1. Recording Copyright

Recording of copyrighted material for other than personal use is illegal without permission of the copyright holder.

### 2. AC Fuse

The fuse is located inside the chassis and is not user-serviceable. If power does not come on, contact your Onkyo authorized service station.

### 3. Care

From time to time you should wipe the front and rear panels and the cabinet with a soft cloth. For heavier dirt, dampen a soft cloth in a weak solution of mild detergent and water, wring it out dry, and wipe off the dirt. Following this, dry immediately with a clean cloth. Do not use rough material, thinners, alcohol or other chemical solvents or cloths since these could damage the finish or remove the panel lettering.

### 4. Power

#### WARNING

BEFORE PLUGGING IN THE UNIT FOR THE FIRST TIME, READ THE FOLLOWING SECTION CAREFULLY.

The voltage of the available power supply differs according to country or region. Be sure that the power supply voltage of the area where this unit will be used meets the required voltage (e.g., AC 230 V, 50 Hz or AC 120 V, 60 Hz) written on the rear panel.

Worldwide models are equipped with a voltage selector to conform to local power supplies. Be sure to set this switch to match the voltage of the power supply in your area before plugging in the unit.

#### For British models

Replacement and mounting of an AC plug on the power supply cord of this unit should be performed only by qualified service personnel.

#### IMPORTANT

The wires in the mains lead are colored in accordance with the following code:

- Blue : Neutral
- Brown : Live

As the colors of the wires in the mains lead of this apparatus may not correspond with the colored markings identifying the terminals in your plug, proceed as follows:

The wire which is colored blue must be connected to the terminal which is marked with the letter N or colored black.

The wire which is colored brown must be connected to the terminal which is marked with the letter L or colored red.

#### IMPORTANT

A 5 ampere fuse is fitted in this plug. Should the fuse need to be replaced, please ensure that the replacement fuse has a rating of 5 amperes and that it is approved by ASTA or BSI to BS1362. Check for the ASTA mark or the BSI mark on the body of the fuse.

IF THE FITTED MOULDED PLUG IS UNSUITABLE FOR THE SOCKET OUTLET IN YOUR HOME THEN THE FUSE SHOULD BE REMOVED AND THE PLUG CUT OFF AND DISPOSED OF SAFELY. THERE IS A DANGER OF SEVERE ELECTRICAL SHOCK IF THE CUT OFF PLUG IS INSERTED INTO ANY 13 AMPERE SOCKET.

If in any doubt, consult a qualified electrician.

### For U.S. models

#### Note to CATV system installer:

This reminder is provided to call the CATV system installer's attention to Section 820-40 of the NEC which provides guidelines for proper grounding and, in particular, specifies that the cable ground shall be connected to the grounding system of the building, as close to the point of cable entry as practical.

#### FCC Information for User

#### CAUTION:

The user changes or modifications not expressly approved by the party responsible for compliance could void the user's authority to operate the equipment.

#### NOTE:

This equipment has been tested and found to comply with the limits for a Class B digital device, pursuant to Part 15 of the FCC Rules. These limits are designed to provide reasonable protection against harmful interference in a residential installation. This equipment generates, uses and can radiate radio frequency energy and, if not installed and used in accordance with the instructions, may cause harmful interference to radio communications. However, there is no guarantee that interference will not occur in a particular installation. If this equipment does cause harmful interference to radio or television reception, which can be determined by turning the equipment off and on, the user is encouraged to try to correct the interference by one or more of the following measures:

- Reorient or relocate the receiving antenna.
- Increase the separation between the equipment and receiver.
- Connect the equipment into an outlet on a circuit different from that to which the receiver is connected.
- Consult the dealer or an experienced radio/TV technician for help.

#### For Canadian models

**NOTE:** THIS CLASS B DIGITAL APPARATUS COMPLIES WITH CANADIAN ICES-003.

For models having a power cord with a polarized plug:

**CAUTION:** TO PREVENT ELECTRIC SHOCK, MATCH WIDE BLADE OF PLUG TO WIDE SLOT, FULLY INSERT.

#### Modèle pour les Canadien

**REMARQUE:** CET APPAREIL NUMÉRIQUE DE LA CLASSE B EST CON-FORME À LA NORME NMB-003 DU CANADA.

Sur les modèles dont la fiche est polarisée:

**ATTENTION:** POUR ÉVITER LES CHOCS ÉLECTRIQUES, INTRODUIRE LA LAME LA PLUS LARGE DE LA FICHE DANS LA BORNE CORRESPONDANTE DE LA PRISE ET POUSSER JUSQU'AU FOND.

# Contents

## Before using

<b>Important Safeguards</b> .....	<b>2</b>
<b>Precautions</b> .....	<b>3</b>
<b>Contents</b> .....	<b>4</b>
<b>Features</b> .....	<b>6</b>
<b>Supplied accessories</b> .....	<b>6</b>
<b>Before using this unit</b> .....	<b>7</b>
Setting the voltage selector (Worldwide models only) ...	7
Installing the remote controller batteries .....	7
Using the remote controller .....	7

## Facilities and connections

<b>Index parts and facilities</b> .....	<b>8</b>
Front panels .....	8
Front panel display .....	10
Remote controller .....	11
Rear panel .....	13
<b>Connecting to Audio/Video equipment</b> .....	<b>14</b>
Connecting your audio components .....	15
Connecting your video components .....	16
<b>Connecting speakers</b> .....	<b>20</b>
Ideal speaker configuration .....	20
Minimum speaker configuration for surround sound playback .....	20
Speaker placement .....	20
Connecting speakers .....	21
Using the speaker labels .....	21
<b>Connecting antennas</b> .....	<b>22</b>
Assembling the AM loop antenna .....	22
Connecting the AM antenna cable .....	22
Connecting the included antennas .....	22
Connecting an FM outdoor antenna .....	23
Connecting an AM outdoor antenna .....	23
Directional linkage .....	23
Connecting the antenna cable to the 75/300 $\Omega$ antenna adapter (For all models other than USA & Canadian models) .....	23
<b>Connecting the remote zone (Zone 2) speakers</b> ....	<b>24</b>
When using the SURR BACK/ZONE 2 SPEAKERS terminals .....	24
When using the SURR BACK/ZONE 2 PRE OUT terminals .....	24
Connecting the TX-SR800 to the monitor for the remote zone ..	24
<b>Operating components not reached by the remote controller signals (IR IN/OUT)</b> .....	<b>25</b>
If the remote controller signal does not reach the TX- SR800 remote sensor .....	25
If the remote controller signal does not reach other components .....	25

## Miscellaneous connections ..... 26

Connecting for remote control (RI) .....	26
Connecting the power cords from other devices .....	26
Connecting to devices with analog multi channel output ....	27
Connecting auxiliary power amplifier .....	27

## Connecting the power ..... 28

Turning on the power .....	28
Turning on the power from the remote controller .....	28

## Setup and operation

### Enjoying music or videos with the TX-SR800 ... 29

Basic operation .....	29
To change the display of the input source from TAPE to MD ....	29
Temporarily turning off the sound .....	30
Adjusting the bass and treble .....	30
Listening with headphones .....	30
Using the sleep time (remote controller only) .....	30
Changing the listening mode .....	31
Switching the display .....	32
Adjusting the brightness of the front display .....	32
Temporarily changing the speaker output levels .....	32
Changing the audio mode .....	33
Enjoying the multichannel output .....	33

### Listening to Radio Broadcasts ..... 34

Tuning into a radio station .....	34
Listening to a stereo radio station (FM mode) .....	34
Presetting a radio station .....	35
Selecting a preset radio station .....	35
Erasing a preset radio station .....	35

### Enjoying music in the remote zone ..... 36

Using the buttons on the TX-SR800 .....	36
Using the remote controller .....	36
Adjusting the volume for the remote zone .....	36

### Recording a source ..... 37

To record the input source signal you are currently watching or listening to .....	37
To record an input source signal different from that you are currently watching or listening to .....	37
Recording the video from one source and the audio from another .....	38

### Setup Menu ..... 39

Navigating through the Setup Menu .....	40
---	----

### Hardware Setup ..... 41

<b>0. Hardware Setup Menu</b> .....	<b>41</b>
0-1. Speaker Impedance Sub-menu .....	41
0-2. Surr Back/Zone 2 Sub-menu .....	41
0-3. IR IN Setup Sub-menu .....	42
0-4. AM Frequency Step Sub-menu (Worldwide model Only) .....	42

# Contents

<b>Speaker Setup .....</b>	<b>43</b>
<b>1. Speaker Setup Menu .....</b>	<b>43</b>
1-1. Speaker Config Sub-menu .....	43
1-2. Speaker Distance Sub-menu .....	44
1-3. Level Calibration Sub-menu .....	45
<b>Input Setup .....</b>	<b>46</b>
<b>2. Input Setup Menu .....</b>	<b>46</b>
2-1. Digital Setup Sub-menu .....	46
2-2. Multichannel Setup Sub-menu .....	47
2-3. Video Setup Sub-menu .....	48
2-4. Character Input Sub-menu .....	49
2-5. IntelliVolume Sub-menu .....	49
2-6. Listening Mode Preset Sub-menu .....	50
<b>Audio Adjust .....</b>	<b>53</b>
<b>3. Audio Adjust Setup Menu .....</b>	<b>53</b>
3-1. Tone Control Sub-menu .....	53
3-2. Surround Speakers Sub-menu .....	53
3-3. Sound Effect Sub-menu .....	54
3-4. Delay Sub-menu .....	54
3-5. LFE Level Sub-menu .....	55
3-6. Mono Sub-menu .....	55
3-7. Theater Dimensional Sub-menu .....	55
3-8. Surround Sub-menu .....	56
3-9. THX Sub-menu .....	57
3-10. 3-11. 3-12. 3-13. 3-14. 3-15. Mono Movie/Enhanced 7/ Orchestra/Unplugged/Studio Mix /TV Logic Sub-menu .....	57
<b>Preference .....</b>	<b>59</b>
<b>4. Preference Menu .....</b>	<b>59</b>
4-1. Volume Setup Sub-menu .....	59
4-2. Headphones Level Setup Sub-menu .....	60
4-3. OSD Setup Sub-menu .....	60
4-4. OSD Position Sub-menu .....	60

<b>Programming the commands of remote controllers for other devices into the remote controller .....</b>	<b>69</b>
Programming procedure .....	69
Erasing the programmed command from one button .....	70
Erasing all the commands programmed under a MODE button .....	70
<b>Using the macro function .....</b>	<b>71</b>
<b>What is the macro function? .....</b>	<b>71</b>
Programming the macro .....	71
Executing the macro .....	71
Erasing a macro from the MACRO 1 (or 2) button .....	72
Erasing all commands and macros that have been programmed .....	72

## Appendix

<b>Troubleshooting guide .....</b>	<b>73</b>
POWER .....	73
SPEAKERS .....	73
FM/AM TUNER .....	73
VIDEO and AUDIO .....	74
REMOTE CONTROLLER .....	74
OTHER .....	74
If one of the messages shown below appears .....	75
<b>Specifications .....</b>	<b>76</b>

## Remote controller

<b>Using remote controller .....</b>	<b>61</b>
<b>Overview .....</b>	<b>61</b>
Controlling an Onkyo cassette tape deck .....	61
Controlling an Onkyo DVD player .....	62
Controlling an Onkyo CD player .....	63
Controlling an Onkyo MD recorder .....	64
<b>Entering a pre-programming code .....</b>	<b>65</b>
Learning a pre-programming code .....	65
Pre-programming codes .....	66
<b>Operating your programmed remote controller ....</b>	<b>67</b>
DVD MODE (DVD Player Mode) .....	67
SAT MODE (Satellite Tuner Mode) .....	67
CABLE MODE (Cable Mode) .....	67
VCR MODE (VCR Mode) .....	68
TV MODE (TV Mode) .....	68

# Features

## Amplifier Features

- 100 Watts per channel min. RMS. into 8  $\Omega$  2 channel driven, from 20 Hz to 20 kHz with no more than 0.08 % total harmonic distortion (FTC)
- 2  $\times$  160 Watts into 6  $\Omega$ , 1,000 Hz (EIAJ)
- 7 Channel Amplifier
- Wide Range Amplifier Technology (WRAT)
- Linear Optimum Gain Volume Circuitry
- 192 kHz/24 Bit D/A Converters (except for Surround Back L/R)
- Zone-2 Capability

## Audio/Video Features

- THX® Surround EX®
- THX Select Certified
- Dolby® Digital, Dolby Digital EX, Dolby Pro Logic II
- DTS, DTS-ES Discrete 6.1, DTS-ES Matrix 6.1, DTS Neo:6, and DTS 96/24
- Theater-Dimensional™ Virtual Surround Mode
- Non-Scaling Configuration
- Onscreen displays (Basic Menu/Advanced Menu)
- 2 Wideband Component-Video Inputs/1 Output
- Composite to S-Video Conversion
- 6 S-Video Inputs/3 Outputs
- 6 Assignable Digital Inputs (3 optical/3 Coaxial), 1 outputs, and 1 Digital Input (optical)
- Pre Out Terminals for Front L/R, Center, Surround L/R, Surround back L/R or Zone 2 L/R and Subwoofer

## FM/AM Tuner Features

- 40 FM/AM random presets
- FM auto tuning

## Other Performance Features

- VLSC (Vector Linear Shaping Circuitry) for L/C/R channels (Other than US & Canadian models and Australian models)
- IntelliVolume
- Character Input
- Powerful backlit/preprogrammed learning remote with macro and mode-key LEDs

\* Manufactured under license from Dolby Laboratories.

“Dolby,” “Pro Logic,” “Surround EX” and the double-D symbol are trademarks of Dolby Laboratories.

- “Theater-Dimensional” is a trademark of Onkyo Corporation.
- Lucasfilm THX and THX are trademarks or registered trademarks of THX Ltd. All rights reserved. Used under authorization.
- Re-Equalization and the “Re-EQ” logo are trademarks of THX Ltd. Manufactured under license of THX Ltd.
- Manufactured under license from Digital Theater Systems, Inc. US Pat. No. 5,451,942, 5,956,674, 5,974,380, 5,978,762 and other world-wide patents issued and pending. “DTS,” “DTS-ES Extended Surround” and “Neo:6” are trademarks of Digital Theater Systems, Inc. © 1996, 2000 Digital Theater Systems, Inc. All Rights Reserved.
- Xantech is a registered trademark of Xantech Corporation.
- Niles is a registered trademark of Niles Audio Corporation.

### THX Select

Before any home theatre component can be THX Select certified, it must pass a rigorous series of quality and performance tests. Only then can a product feature the THX Select logo, which is your guarantee that the Home Theatre products you purchase will give you superb performance for many years to come. THX Select requirements define hundreds of parameters, including power amplifier performance, and pre-amplifier performance and operation for both digital and analog domains. THX Select receivers also feature proprietary THX technologies (e.g., THX Mode, see page 52) which accurately translate film soundtracks for home theater playback.

# Supplied accessories

Check that the following accessories are supplied with the TX-SR800.

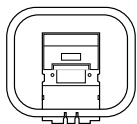

AM loop antenna  $\times$  1



FM indoor antenna  $\times$  1

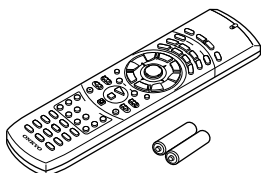

Remote controller  $\times$  1  
Batteries (AA, R6 or UM-3)  $\times$  2

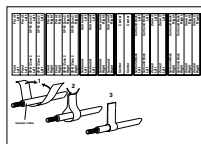

Speaker cable label  $\times$  1  
(See page 21.)

The following accessories may be available depending on the area which it was purchased.

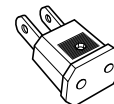

Conversion plug  $\times$  1

(Use this plug if the power cord plug of the TX-SR800 does not fit your AC outlet. Shape may vary depending on the area which it was purchased.)

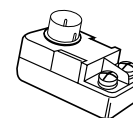

75/300  $\Omega$  antenna adapter  $\times$  1

6 The alphabet displayed at the end of the product name found in catalogs and on the packages represents the color of this receiver. Though the color varies, the specifications and operations are the same.

# Before using this unit

## Setting the voltage selector (Worldwide models only)

Worldwide models are equipped with a voltage selector so that you can set your TX-SR800 to conform with local power supplies. Be sure to set this switch to match the voltage of the power supply in your area before plugging in the unit.

Determine the proper voltage for your area: 220-230 V or 120 V. If the preset voltage is not correct for your area, insert a screwdriver into the groove in the switch and slide the switch all the way to the top (120 V) or bottom (220-230 V), whichever is appropriate.

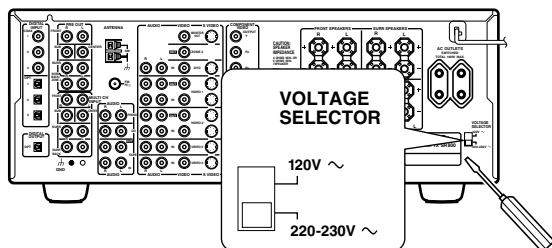

## Installing the remote controller batteries

1. Remove the battery compartment cover by pressing it and sliding it in the direction shown by the arrow below.
2. Insert two AA (R6 or UM-3) batteries into the battery compartment. Carefully follow the polarity diagram (positive (+) and negative (-) symbols) inside the battery compartment.
3. After the batteries are installed and seated correctly, replace the compartment cover.

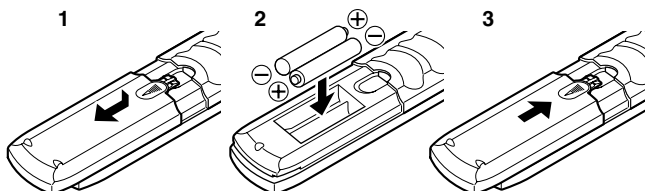

### Notes:

- Do not mix new batteries with old batteries or different kinds of batteries.
- To avoid corrosion, remove the batteries if the remote controller will not be used for a long time.
- Remove dead batteries immediately to avoid damage from corrosion. If the remote controller does not operate smoothly, remove the old batteries and replace them both with two new AA batteries.

## Using the remote controller

Point the remote controller toward the remote control sensor. The STANDBY indicator lights up when the unit receives a signal from the remote controller.

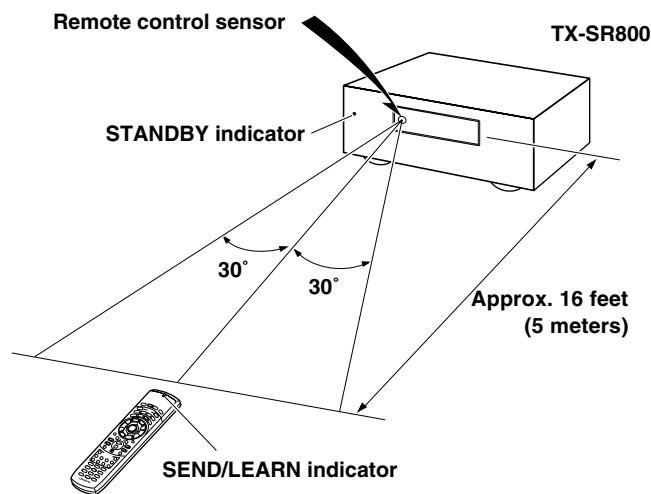

### Notes:

- Make sure that the remote control sensor is not subject to strong light such as direct sunlight or inverted fluorescent light for it may prevent proper operation of the remote controller.
- Using another remote controller in the same room or using the TX-SR800 near equipment that uses infrared rays may cause operational interference.
- Do not put objects on the remote controller. Its buttons may be pressed by mistake and drain the batteries.
- Make sure the audio rack doors do not have colored glass. Placing the TX-SR800 behind such doors may prevent proper remote controller operation.
- If there is any obstacle between the remote controller and the remote control sensor, the remote controller will not operate.

# Index parts and facilities

## Front panels

(USA and Canadian models)

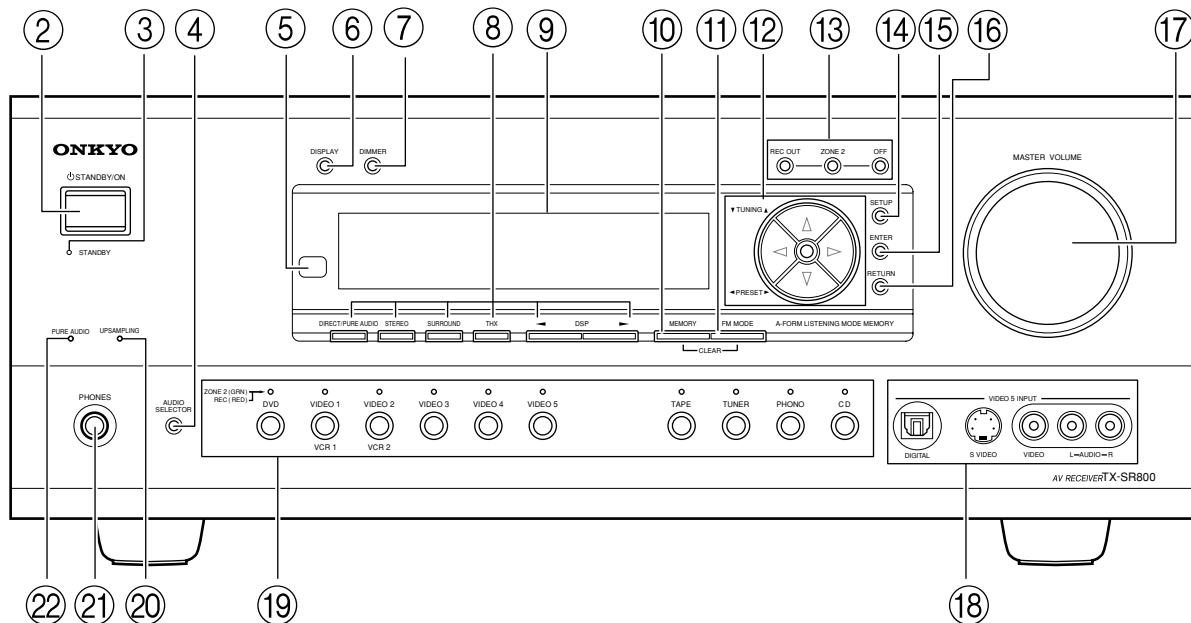

(Other than USA and Canadian models)

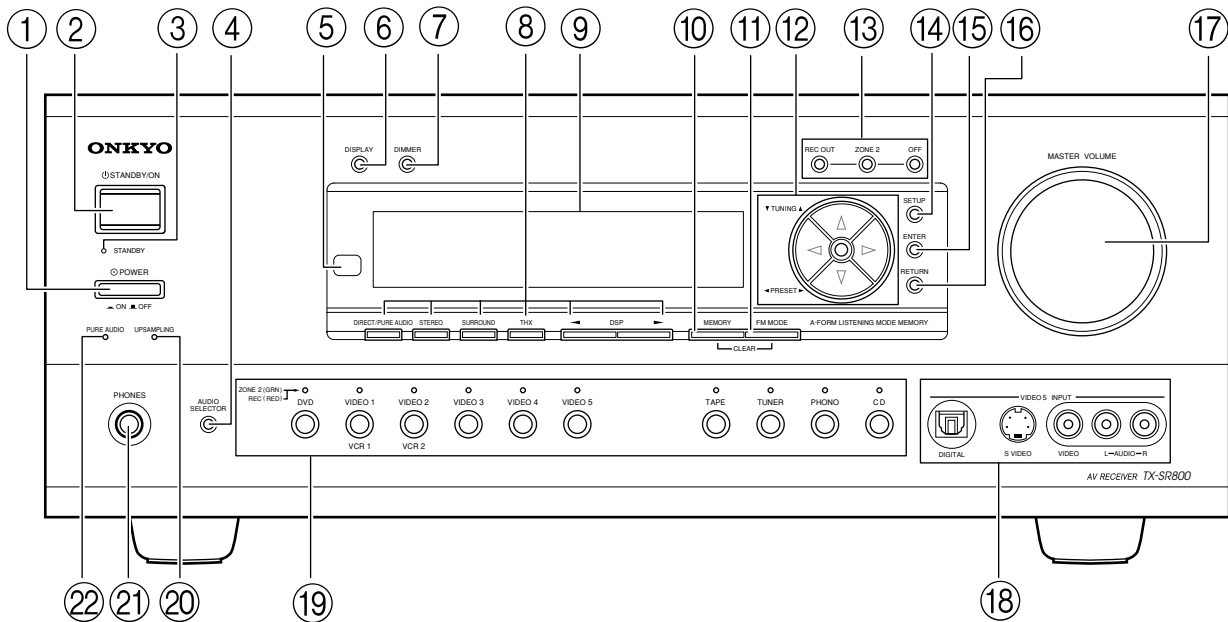



## Index parts and facilities

For further operational instructions, see the pages indicated in brackets [ ].

### ① **POWER switch (for all models other than USA and Canadian models) [28]**

Press to turn on and off the main power supply for the TX-SR800. When the TX-SR800 is turned on with the POWER switch, the STANDBY indicator lights.

- Before turning on the power, check to make sure that all cords are properly connected.
- When the power is turned on, a sudden surge of current will occur that may adversely affect the operation of other devices. To prevent this, do not plug the TX-SR800 into the same circuit used by sensitive equipment, e.g., computers.

### ② **STANDBY/ON button [28]**

If pressed with the POWER switch turned on (with the receiver plugged in for US models), the TX-SR800 turns on and the display lights up. If pressed again, the TX-SR800 returns to the standby state. In the standby state, the display is turned off and the TX-SR800 cannot be operated.

### ③ **STANDBY indicator [7, 28]**

Lights when the TX-SR800 is in the standby state and when a signal is received from the remote controller.

### ④ **AUDIO SELECTOR button [33]**

Press to select the type of audio input signal.

### ⑤ **Remote control sensor [7]**

### ⑥ **DISPLAY button [32]**

Press to display information about the current input source signal. Each time you press the DISPLAY button, the screen changes to show you different information concerning the input signal.

### ⑦ **DIMMER button [32]**

Press to set the brightness of the front display. There are three settings available: normal, dark, and very dark.

- The brightness of the front display can also be performed using the remote controller.

### ⑧ **LISTENING MODE buttons [31, 51]**

Press these buttons to select a listening mode for the current input source.

**DIRECT/PURE AUDIO:** Press to switch between the direct and pure audio listening modes.

**STEREO:** Selects for the stereo listening mode.

**SURROUND:** Selects for the Dolby Pro LogicII, DTS Neo:6, Dolby Digital, or DTS listening modes.

**THX:** Selects for the THX listening mode.

**DSP** ◀▶: Switches to the DSP mode.

### ⑨ **Front display**

### ⑩ **MEMORY button [35]**

Press to assign the radio station that you are currently tuned into to a preset channel or press to delete a previously preset station.

### ⑪ **FM MODE button [34]**

Press to change the stereo mode from AUTO to MONO and vice versa. Each time this button is pressed, the AUTO indication turns on and off indicating the current mode. If you are listening to an FM radio station in stereo and the sound cuts out or there is a great deal of noise, switch from AUTO to MONO.

### ⑫ **TUNING ▲/▼, PRESET ◀▶, cursor buttons (▲/▼/◀▶) [34, 35, 40]**

To tune into a radio station, press the TUNING ▲/▼ buttons. The tuner frequency is displayed in the front display and it can be changed in 100-kHz (or 50-kHz) increments for FM and 10-kHz (or 9-kHz) increments for AM.

When FM is selected as the input source, you can hold down either the TUNING ▲ or ▼ button and then release it to activate the auto-search feature. It will search for a station in the direction of the button you pressed and stop when it tunes into one. When navigating through the menu settings, these buttons move the cursor up or down (or change the highlighted item).

To select a radio station that was stored using the MEMORY button, press the PRESET ◀▶ buttons.

When navigating through the menu settings, these buttons select the value or item that you selected with the TUNING ▲/▼ buttons.

When you press the SETUP button, the TUNING and PRESET buttons become cursor buttons to be used for Setup Menu operations.

### ⑬ **REC OUT/ZONE 2/OFF buttons [36-38]**

These buttons allow you to use the TX-SR800 to output to a remote zone (Zone 2) or to another component for recording (Rec Out). Press the REC OUT button to output the audio and video signals to a recording component for recording. Press the ZONE 2 button to enjoy the output from the TX-SR800 in a different room, which is referred to as the remote zone (Zone 2).

When either button is pressed, the currently selected input source for recording or outputting to the remote zone is displayed in the front panel display. If "SOURCE" is displayed, then the same input source as that selected for the main zone will be output.

To select an input source, press the desired button (REC OUT or ZONE 2) and then press one of the input source button within 8 seconds. That source will be output for recording or viewing in the remote zone.

To set the output to the source channel, press the desired button (REC OUT or ZONE 2) twice in succession. To turn off the output, press the desired button (REC OUT or ZONE 2) and then press the OFF button within 8 seconds.

#### **Note:**

The Rec Out and Zone 2 buttons use the same circuit and therefore cannot be used at the same time. When REC OUT is selected, nothing is output to Zone 2. When ZONE 2 is selected, REC OUT is automatically fixed to SOURCE.

### ⑭ **SETUP button [40]**

Press to enter the Setup Menu. The OSD Menu will appear on the TV monitor as well as the front display on the TX-SR800.

### ⑮ **ENTER button [40]**

Press to display the screen for the item that is selected in the Setup Menu.

### ⑯ **RETURN button [40]**

When in the Setup Menu, press to go back one level. If pressed while at the Main Menu, you will exit the Setup Menu.

# Index parts and facilities

## 17 MASTER VOLUME dial [29]

Use to control the volume in the main zone. The volume for the remote zone (Zone 2) is independent.

## 18 VIDEO 5 INPUT terminals [19]

For connecting a video camera or game device.

## 19 Input source buttons and indicators (DVD, VIDEO 1-5, TAPE, TUNER, PHONO, and CD) [29, 36-38]

Press these buttons to select the input source for the main zone.

To select the input source for the remote zone (Zone 2) or recording out (Rec Out), first press the ZONE 2 or REC OUT button, and then press the desired input source button. The input channel with its indicator lit **red** is output to REC OUT and the one with its indicator lit **green** is output to ZONE 2.

## 20 UPSAMPLING indicator [54]

Lights during upsampling. This function is available when the input source is Analog/PCM and the listening mode is set to the stereo or surround mode.

## 21 PHONES jack [30]

This is a standard stereo jack for connecting stereo headphones.

## 22 PURE AUDIO indicator [31]

Lights during pure audio playback.

## Front panel display

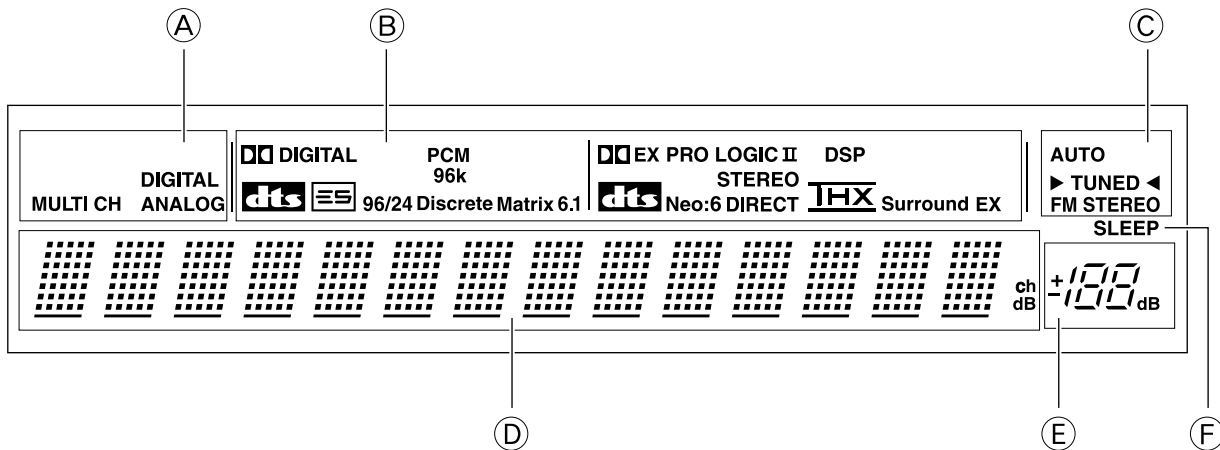

### A Input signal path indicators

Shows from which terminal the input signal is coming.

### B Listening mode or digital input format indicators

One of these indicators lights to show the format of the current input source. In addition, one of the listening mode indicators lights to indicate the current listening mode.

### C Tuning indicators

#### TUNED indicator

Lights when a radio station is received.

#### AUTO indicator

Lights when receiving FM broadcasts in the stereo mode. Turns off when placed into the monaural mode.

#### FM STEREO indicator

Lights when an FM broadcast station is received in stereo.

### D Multi function display

During normal operation, shows the current input source and volume. When the FM or AM input is selected, shows the frequency and preset number. When the DISPLAY button is pressed, shows the listening mode and input source format. However, does not show the source format when the FM or AM source is selected.

### E Volume display

Shows the volume level.

### F SLEEP indicator

Lights when the sleep timer is turned on.

## Remote controller

The RC-510M is a multi-functional remote controller. The instructions given here only explain how to use the remote controller in conjunction with the TX-SR800. To operate the TX-SR800 using the remote controller, first press the RCVR MODE button to place the remote controller in the receiver mode.

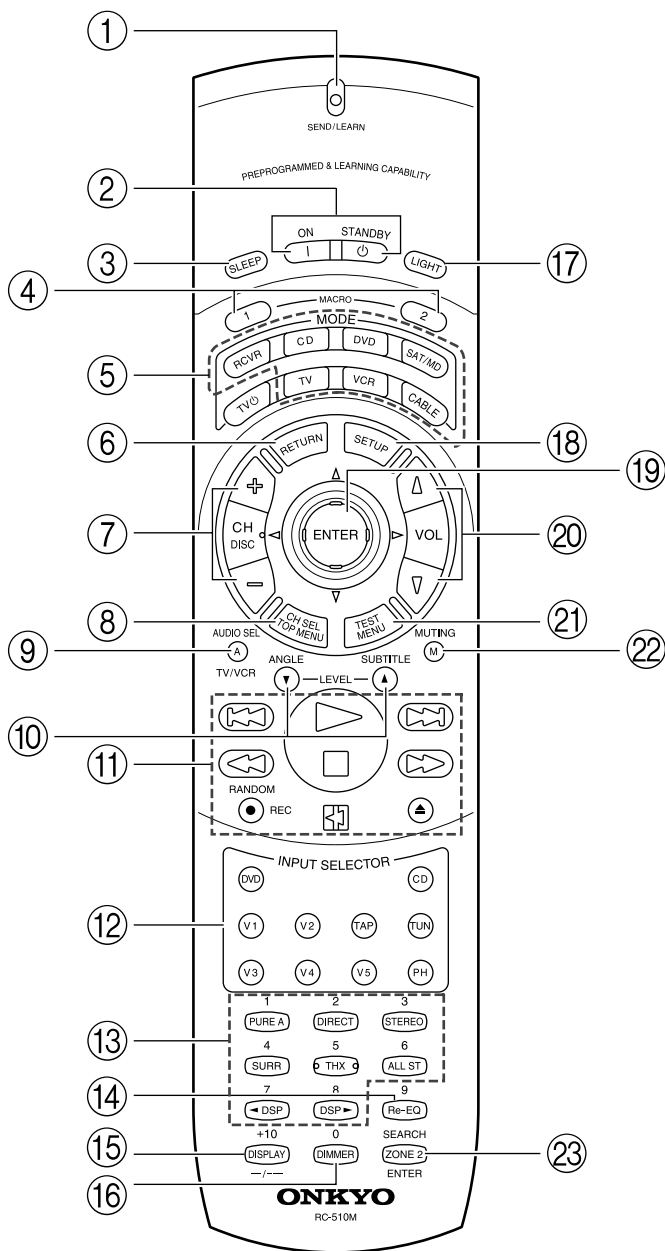

## Index parts and facilities

---

- ① **SEND/LEARN indicator**  
Lights red when signals are sent by the remote controller. It also flashes when a button is pressed when the battery power is low.
- ② **ON/STANDBY button [28]**  
**ON:** Press to turn on the TX-SR800.  
**STANDBY:** Press to place the TX-SR800 in the standby state.  
Be aware that pressing the STANDBY button only places the TX-SR800 in standby and does not turn the power completely off.
- ③ **SLEEP button [30]**  
Press to set the sleep function.  
The SLEEP button enables you to set the TX-SR800 to turn off automatically after a specified time period.
- ④ **MACRO 1, 2 button [71]**  
Press to program or execute the macro function.
- ⑤ **MODE buttons and indicators [28, 61]**  
Press to select the component to be operated by the remote controller. When a MODE button is pressed, it will light for 8 seconds. The selected MODE button will also light whenever any other operation button is pressed.
- ⑥ **RETURN button [40]**  
Press to enter the selected setting and return to the previous menu.
- ⑦ **CH  $\leftrightarrow$  button [35]**  
Press to select a preset channel for the tuner.
- ⑧ **CH SEL button [32, 45]**  
Press to select a speaker channel when adjusting the speaker level.
- ⑨ **AUDIO SEL button [33]**  
Press to select the audio input signal.
- ⑩ **LEVEL  $\nabla/\blacktriangle$  buttons [32, 45]**  
Press to adjust the volume of the speaker selected using the CH SEL button.
- ⑪ **TAPE operation buttons [61]**  
Press to operate other Onkyo cassette tapedeck connected to the TX-SR800 using the **R** terminals.
- ⑫ **INPUT SELECTOR buttons [29, 36-38]**  
Press to select an input source.  
Same as the input selector buttons on the front panel of the TX-SR800. The input source for each button is given here. DVD:DVD, CD:CD, V1:VIDEO1, V2:VIDEO2, V3:VIDEO3, V4:VIDEO4, V5:VIDEO5, TAP:TAPE, TUN:FM/AM, PH:PHONO.
- ⑬ **Listening mode buttons [31, 51]**  
You can select a listening mode.
- ⑭ **Re-EQ button [54, 57]**  
Depending on the listening mode, you can turn the Re-EQ function on or off.
- ⑮ **DISPLAY button [32]**  
For changing the display in the front display.
- ⑯ **DIMMER button [32]**  
Adjusts the display brightness.  
There are three settings available: normal, dark, and very dark.
- ⑰ **LIGHT button**  
Press to turn on and off the lights in the buttons of the remote controller.
- ⑱ **SETUP button [40]**  
Press to display the Setup Menu on the TV screen and in the display. Press again to exit the menu.
- ⑲  **$\blacktriangle/\nabla/\blacktriangleleft/\blacktriangleright$ , ENTER button [40]**  
When in the Setup Menu, press the upper and lower arrow buttons to select an item, press the right and left arrow buttons to select parameter values or modes, and press the ENTER button to advance to the next item.
- ⑳ **VOL  $\Delta/\nabla$  button [29]**  
Press to adjust the volume.
- ㉑ **TEST button [45]**  
This button is used to set the speaker output levels. Use this button in conjunction with the LEVEL  $\blacktriangle/\nabla$  and CH SEL buttons to calibrate the speakers levels without entering the Setup Menu.
- ㉒ **MUTING button [30]**  
Press to activate the mute function.
- ㉓ **ZONE 2 button [36]**  
Press to perform operations on the remote zone.

## Rear panel

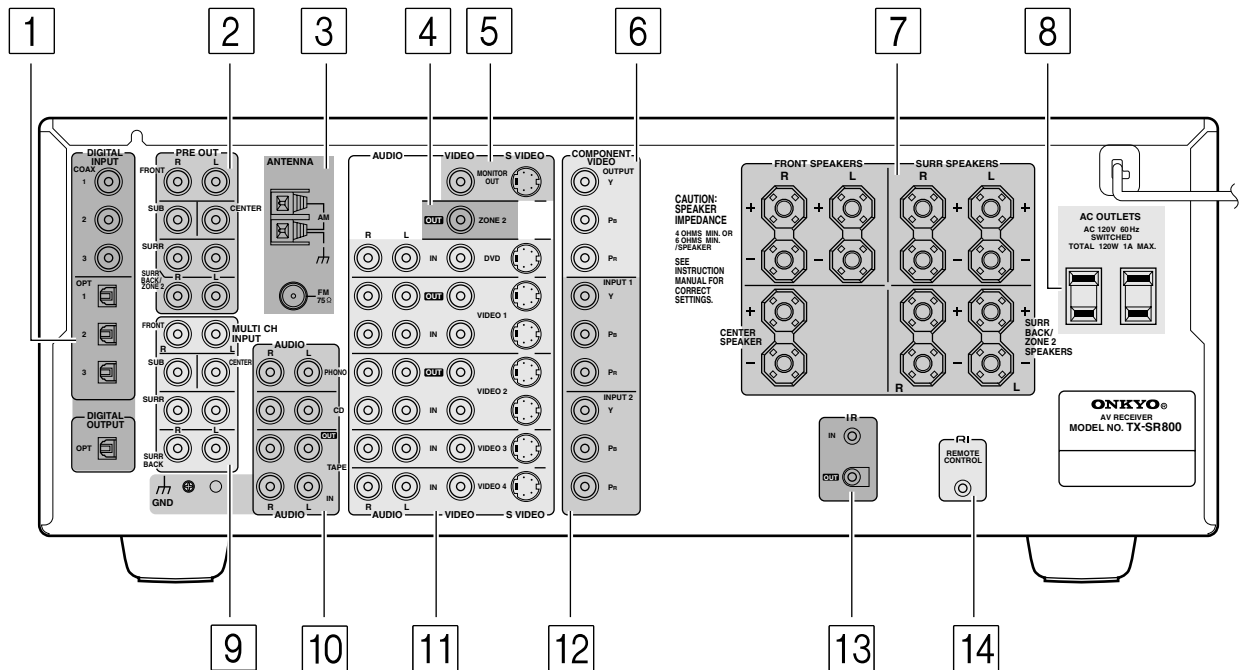

For more information regarding connection procedures, see pages indicated in brackets [ ].

### 1 DIGITAL INPUT/OUTPUT [15-19]

These jacks are for connecting components with digital input and output capabilities. To connect a CD player, see page 15; to connect an MD or CD recorder, see page 15; to connect a DAT deck, see page 15; to connect a DVD player, see page 16; to connect a DVD recorder, see page 18; and to connect a digital satellite tuner, see page 19.

### 2 PRE OUT [27]

To use the TX-SR800 as a preamplifier, connect a power amplifier to this jack.

### 3 ANTENNA [22-23]

These jacks are for connecting the FM indoor antenna and AM loop antenna that are supplied with the TX-SR800.

### 4 ZONE 2 VIDEO OUT [24]

These jacks are for connecting the components that will be used in the remote zone (Zone 2).

### 5 MONITOR OUT VIDEO/S VIDEO [17]

These jacks are for connecting to the video input jacks on television monitors or projectors.

### 6 COMPONENT VIDEO OUTPUT [17]

These jacks are for connecting to the component video input jacks on television monitors or projectors.

### 7 SPEAKERS [20-21]

These terminals are for connecting the speakers.

### 8 AC OUTLETS [26]

This AC outlet is provided to plug in the power cord from another component.

### 9 MULTI CH INPUT [27]

This connector is for connecting components with a multi-channel output.

### 10 PHONO/CD/TAPE AUDIO IN/OUT [15]

These connectors are for connecting to the audio input and output jacks on audio components. To connect a turntable, see page 15; to connect a CD player, see page 15; and to connect a cassette tape deck, MD recorder, or CD recorder, see page 15.

### 11 DVD/VIDEO1-4 IN/OUT [16-19]

These connectors are for connecting to the video input and output jacks on video components. To connect a DVD player, see page 16; to connect a DVD recorder, see page 18; to connect a VCR, see page 17; and to connect a satellite tuner, see page 19.

### 12 COMPONENT VIDEO INPUT1/2 [16, 18]

These connectors are for connecting to the component video outputs of video components that have them. To connect a DVD player, see page 16; to connect a DVD recorder, see page 18; and to connect a satellite tuner, see page 19.

### 13 IR IN/OUT [25]

These connectors are for connecting the remote sensor of a multi-room kit (sold separately).

### 14 RI [26]

This jack is for connecting other Onkyo components equipped with the same RI terminal.

# Connecting to Audio/Video equipment

- Be sure to always refer to the instructions that came with the component that you are connecting.
- Do not plug in the power cord until all connections have been properly made.
- For input jacks, red connectors (marked R) are used for the right channel, white connectors (marked L) are used for the left channel, and yellow connectors (marked V) are used for video connection.
- Insert all plugs and connectors securely. Improper connections can result in noise, poor performance, or damage to the equipment.

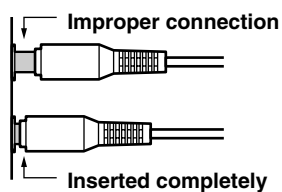

- Do not bind audio/video connection cables with power cords and speaker cables. Doing so may adversely affect the picture and sound quality.
- The optical digital jacks are all of the shutter-type construction. Connect an optical cable by first making sure the cable is oriented correctly and then inserting it into the jack pushing the shutter lid inwards.

Rear optical jack



Front optical jack



Cables are depicted in the connection diagrams as shown below.

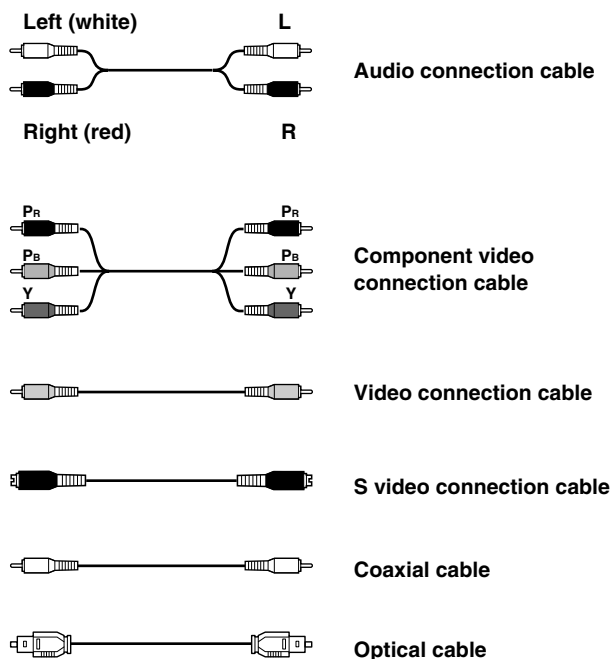

# Connecting to Audio/Video equipment

Here is an explanation of typical ways to connect various components to the TX-SR800. There are many ways that any one component can be connected, and it is up to you to decide which method best fits your situation. The directions given here are only one option and should only be thought of as such. It is best to fully understand the nature of each connector and terminal as well as those of your components and their features to ascertain which method of connection is best.

 : Signal flow

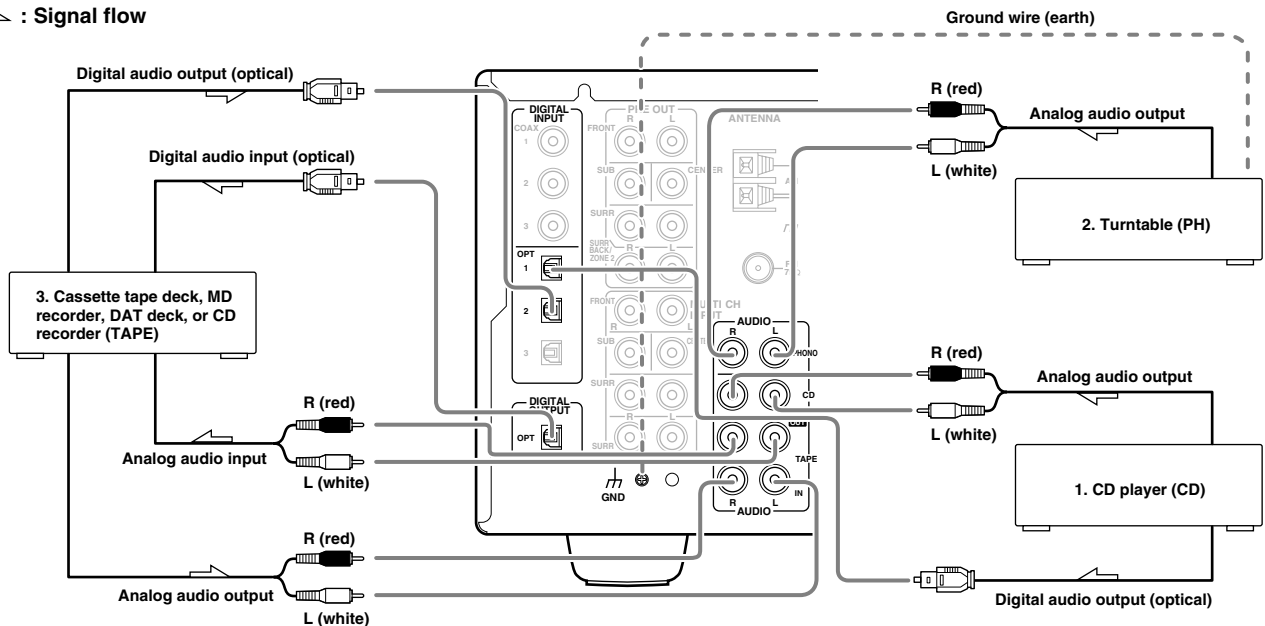

## Connecting your audio components

Below is an example of how you can connect your audio components to the TX-SR800. Refer to the diagram above for the following connection examples.

### AUDIO IN/OUT

These are the analog audio inputs and outputs. There are 8 audio inputs and three audio outputs on the rear panel. The audio inputs and outputs require RCA-type connectors.

### DIGITAL INPUT/OUTPUT

On the rear panel of the TX-SR800, there are three coaxial digital inputs, 3 optical digital inputs, and one optical digital output. To the digital inputs, connect CD players, LD players, DVD players, or other digital source component. To the digital output, connect MD recorders, CD recorders, DAT decks, or other similar components.

- Since an analog connection must be made when using REC OUT or ZONE 2, make sure that the connection to the input source is not digital only, but analog as well.
- When using an optical input or output jack, always use an optical fiber cable.

#### 1. Connecting a compact disc player (CD)

Using an RCA audio cable, connect the output jacks of the compact disc player to the CD AUDIO jacks of the TX-SR800. Make sure that you properly connect the left channel to the L jack and the right channel to the R jack.

If the compact disc player has a digital output, connect it to either the DIGITAL INPUT COAX jack or DIGITAL INPUT OPT jack of the TX-SR800 depending on the type of connector on the compact disc player.

**With the initial settings of the TX-SR800, the CD input source is set for digital input at the OPT 1 jack.**

If the digital connection is made to a different jack, this must be changed at Setup Menu → Input Setup → Digital Setup (see page 46).

#### 2. Connecting a turntable (PHONO)

Using an RCA audio cable, connect the output jacks of the turntable to the PHONO audio jacks of the TX-SR800. Make sure that you properly connect the left channel to the L jack and the right channel to the R jack.

#### Note:

The TX-SR800 is designed for use with moving magnet cartridges. For proper operation, connect a ground (or earth) wire to the GND terminal. For some turntables, however, connecting the ground wire may cause increased noise, and in such a case, a ground wire is not necessary and should not be connected.

#### 3. Connecting a cassette tape deck, MD recorder, DAT deck, or CD recorder (TAPE)

Using RCA audio cables, connect the output jacks (PLAY) of the device to the TAPE AUDIO IN jacks of the TX-SR800 and connect the input jacks (REC) of the device to the TAPE AUDIO OUT jacks of the TX-SR800. Make sure that you properly connect the left channels to the L jacks and the right channels to the R jacks.

If the device has a digital output, connect it to either the DIGITAL INPUT COAX jack or DIGITAL INPUT OPT jack of the TX-SR800 depending on the type of connector on the device.

**With the initial settings of the TX-SR800, the TAPE input source is set for digital input at the OPT 2 jack.**

If the digital connection is made to a different jack, this must be changed at Setup Menu: Input Setup → Digital Setup (see page 46).

If the device has a digital input, connect it to the DIGITAL OUTPUT OPT jack of the TX-SR800 for digital recording of the REC OUT signal from the TX-SR800.

#### Note:

The output from the DIGITAL OUTPUT jack of the TX-SR800 is only the digital signal input to the DIGITAL INPUT jack.

# Connecting to Audio/Video equipment

## Connecting a DVD Player

➤ : Signal flow

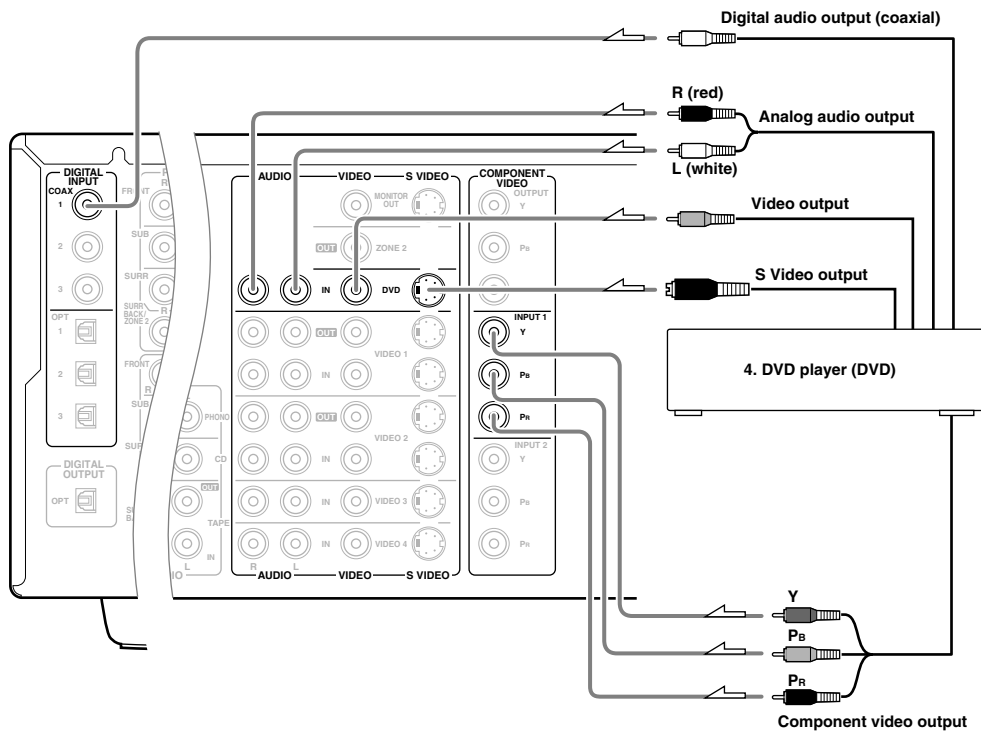

### Connecting your video components

Below is an example of how you can connect your video components to the TX-SR800. Refer to the diagram above for the following connection examples.

#### COMPONENT VIDEO INPUT/OUTPUT

For DVD players or other devices that have component video connectors, the TX-SR800 has two banks of component video input connectors (Y, Pb, Pr) for direct component video input. The TX-SR800 also has one bank of component video output connectors for direct component video output to the matrix decoder of a television, projector, or other display device. By sending the pure component video signal directly, the signal forgoes the extra processing that normally would degrade the image. The result is vastly increased image quality, with incredibly lifelike colors and crisp detail.

#### VIDEO IN/OUT

These are the video inputs and outputs. On the rear panel, there are five video inputs and two video outputs and each one includes both composite video and S video configurations.

Connect VCRs, VTRs, LD players, DVD players, and other video components to the video inputs. Connect VCRs, VTRs, and other recording components to the video outputs to make video recordings.

- When connecting a VCR or other video component, make sure you connect its audio and video leads to the same bank (e.g., both to VIDEO 3).
- The VIDEO 5 inputs are located on the front panel.

#### The flow of the video signals is as follows:

Signals that comes in from VIDEO and S-VIDEO INPUT are output to VIDEO and S VIDEO, signals that comes in from COMPONENT VIDEO INPUT are only output to COMPONENT VIDEO OUTPUT. When connecting a video player to the COMPONENT VIDEO INPUT jacks, be sure to connect your television to the COMPONENT VIDEO OUTPUT jacks.

#### 4. Connecting a DVD player (DVD)

Using an RCA video cable, connect the video output jack (composite) of the DVD or LD player to the DVD VIDEO IN jack of the TX-SR800. Or if the DVD or LD player has an S video output jack, connect it to the DVD S VIDEO IN jack with an S video cable. Or if the device has component video outputs, connect them to one of the banks of COMPONENT VIDEO INPUT jacks on the TX-SR800.

**With the initial settings of the TX-SR800, the DVD input source is set for the COMPONENT VIDEO INPUT 1 jacks.**

If you connect the DVD or LD player to the COMPONENT VIDEO INPUT 2 jacks, this must be changed at Setup Menu → Input Setup → Video Setup → Component Video (see page 48).

Using an RCA audio connection cable, connect the audio output jacks of the DVD or LD player to the DVD AUDIO IN jacks of the TX-SR800. Make sure that you properly connect the left channel to the L jack and the right channel to the R jack.

If the device has a digital output, connect it to either the DIGITAL INPUT COAX jack or DIGITAL INPUT OPT jack of the TX-SR800 depending on the type of connector on the DVD player.

**With the initial settings of the TX-SR800, the DVD input source is set for digital input at the COAX 1 jack.**

If the digital connection is made at a different jack, this must be changed at Setup Menu → Input Setup → Digital Setup (see page 46).



# Connecting to Audio/Video equipment

➤ : Signal flow

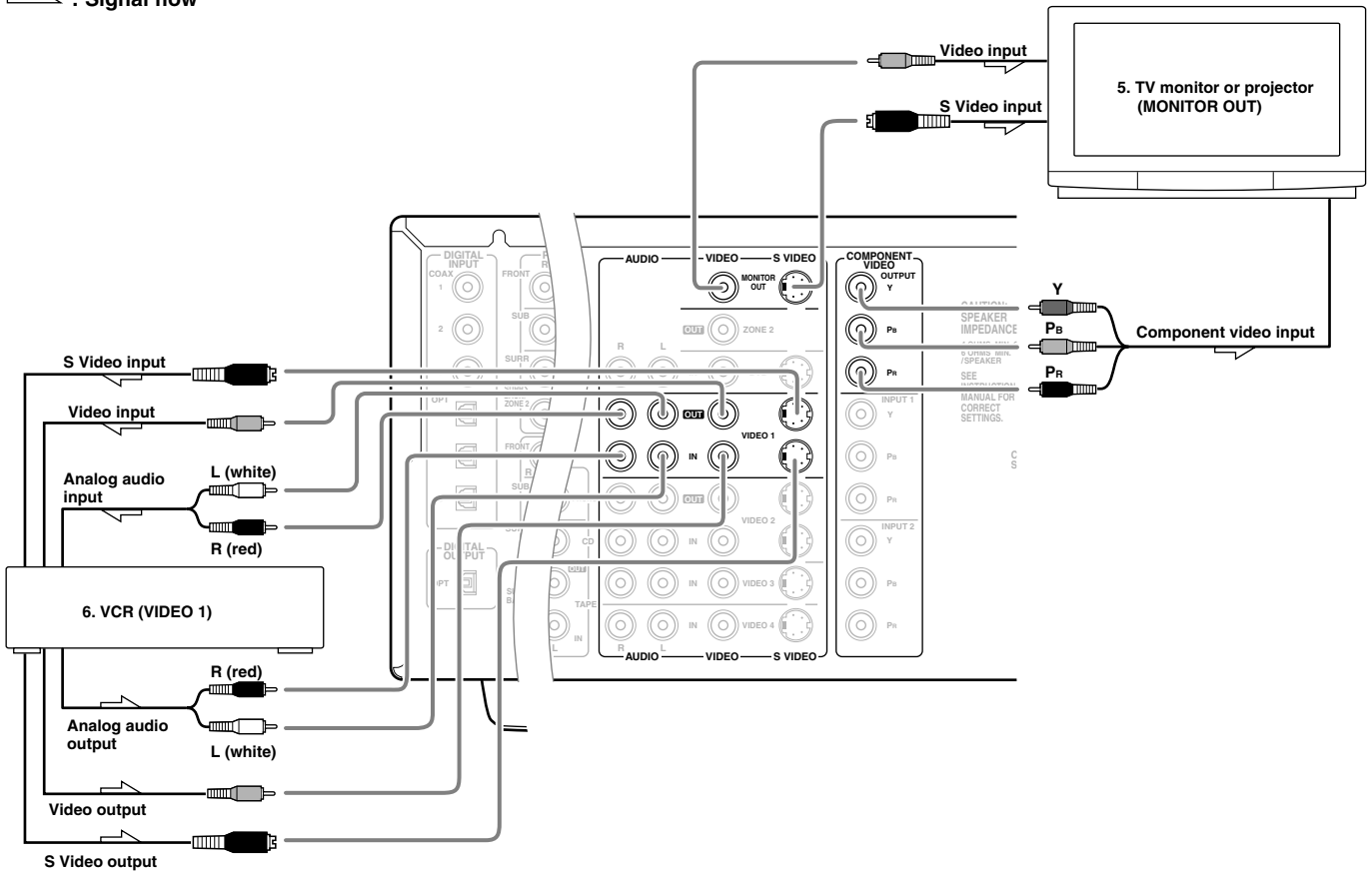

## 5. Connecting a television monitor or projector (MONITOR OUT)

The TX-SR800 is equipped with a simple Y/C separate circuit and simple Y/C mixed circuit. Since both the signal from the S VIDEO and VIDEO inputs are output to the MONITOR OUT S VIDEO output, if the television or projector is equipped with an S video input, it is unnecessary to connect the video connectors. If it is equipped with only a video input, connect it to the MONITOR OUT VIDEO output.

Using an RCA video cable, connect the video input jack (composite) of the device to the MONITOR OUT VIDEO jack of the TX-SR800. Or if the device has an S video input jack, connect it to the MONITOR OUT S VIDEO jack of the TX-SR800 using an S video cable. Or if the device has component video inputs, connect them to the bank of COMPONENT VIDEO OUTPUT jacks on the TX-SR800.

### Note:

The OSD menu is output for VIDEO and S VIDEO only.

## 6. Connecting a video cassette recorder (VIDEO 1)

Using RCA video cables, connect the video output jack (composite) of the video cassette recorder to the VIDEO 1 VIDEO IN jack of the TX-SR800 and connect the video input jack of the video cassette recorder to the VIDEO 1 VIDEO OUT jack of the TX-SR800. Or if the video cassette recorder has S video input and output jacks, connect them to the VIDEO 1 S VIDEO IN and OUT jacks of the TX-SR800 using S video cables. Or if the video cassette recorder has component video outputs, connect them to one of the banks of COMPONENT VIDEO INPUT jacks on the TX-SR800.

**With the initial settings of the TX-SR800, the VIDEO 1 input source is set for the COMPONENT VIDEO INPUT 2 jacks.**

If you connect the video cassette recorder to the COMPONENT VIDEO INPUT 1 jacks, this must be changed at Setup Menu → Input Setup → Video Setup → Component Video (see page 48).

Using RCA audio cable, connect the audio output jacks of the video cassette recorder to the VIDEO 1 AUDIO IN jacks of the TX-SR800 and connect the audio input jacks of the video cassette recorder to the VIDEO 1 AUDIO OUT jacks of the TX-SR800. Make sure that you properly connect the left channels to the L jacks and the right channels to the R jacks.

If you are connecting a digital output device to the VIDEO 1 jack instead of a VCR, connect it to either the DIGITAL INPUT COAX jack or DIGITAL INPUT OPT jack depending on the type of connector on the device.

**With the initial settings of the TX-SR800, the VIDEO 1 input source is set for digital input at the COAX 2 jack.**

If the digital connection is made at a different jack, this must be changed at Setup Menu → Input Setup → Digital Setup (see page 46).

# Connecting to Audio/Video equipment

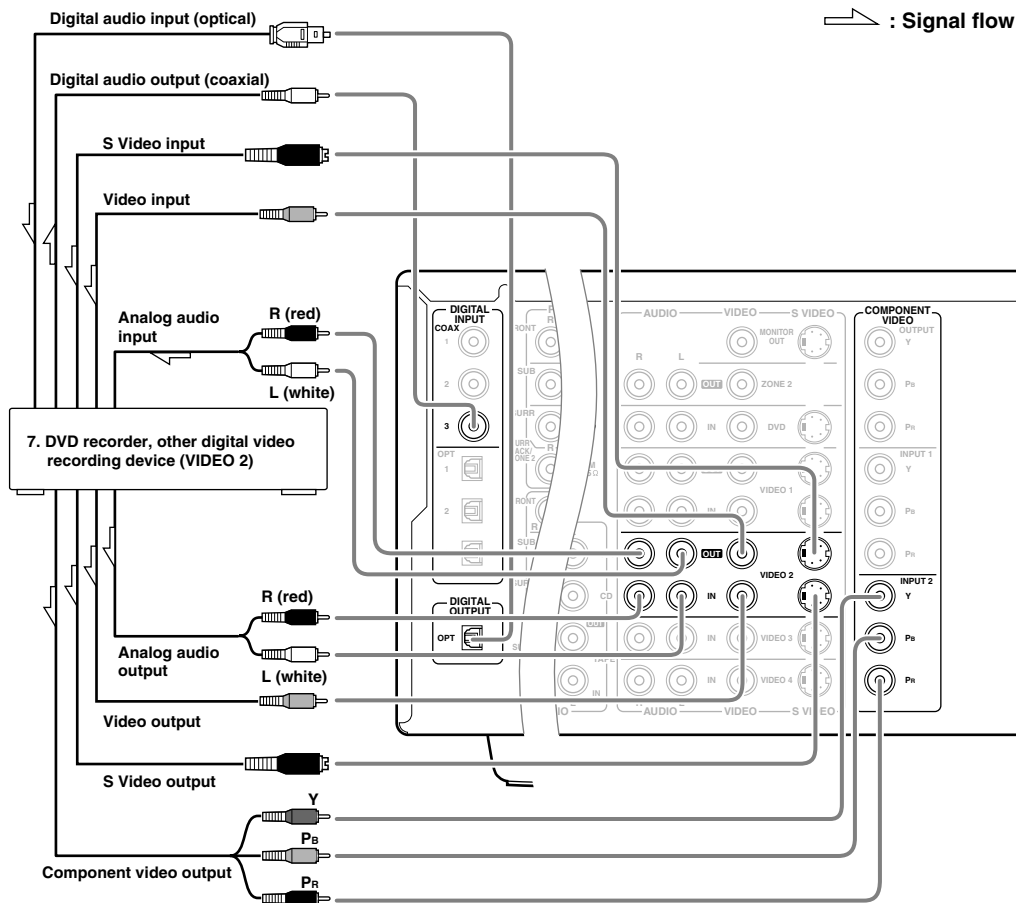

## 7. Connecting a DVD recorder or other digital video recording device (VIDEO 2)

Using RCA video cables, connect the video output jack (composite) of the device to the VIDEO 2 VIDEO IN jack of the TX-SR800 and connect the video input jack of the device to the VIDEO 2 VIDEO OUT jack of the TX-SR800. Or if the device has S video input and output jacks, connect them to the VIDEO 2 S VIDEO IN and OUT jacks of the TX-SR800 using S video cables. Or if the device has component video outputs, connect them to one of the banks of COMPONENT VIDEO INPUT jacks on the TX-SR800.

**With the initial settings of the TX-SR800, the VIDEO 2 input source is set for the COMPONENT VIDEO INPUT 2 jacks.**

If you connect the device to the COMPONENT VIDEO INPUT 1 jacks, this must be changed at Setup Menu → Input Setup → Video Setup → Component Video (see page 48).

Using RCA audio cables, connect the audio output jacks of the device to the VIDEO 2 AUDIO IN jacks of the TX-SR800 and connect the audio input jacks of the device to the VIDEO 2 AUDIO OUT jacks of the TX-SR800. Make sure that you properly connect the left channels to the L jacks and the right channels to the R jacks.

If the device has a digital output, connect it to either the DIGITAL INPUT COAX jack or DIGITAL INPUT OPT jack of the TX-SR800 depending on the type of connector on the device.

**With the initial settings of the TX-SR800, the VIDEO 2 input source is set for digital input at the COAX 3 jack.**

If the digital connection is made at a different jack, this must be changed at Setup Menu → Input Setup → Digital Setup (see page 46).

If the device has a digital input, connect it to the DIGITAL OUTPUT OPT jack of the TX-SR800 for digital recording of the REC OUT signal from the TX-SR800.

### Note:

The output from the DIGITAL OUTPUT jack of the TX-SR800 is only the digital signal input to the DIGITAL INPUT jack.

## Connecting to Audio/Video equipment

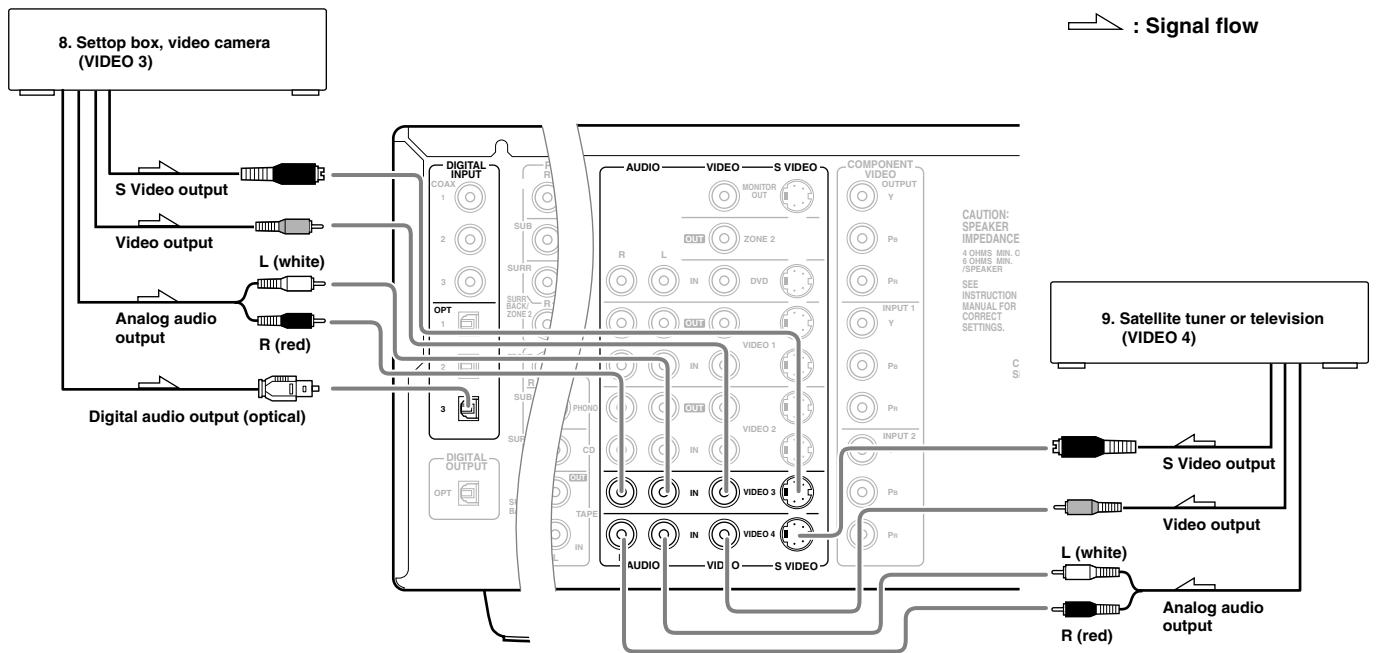

### 8, 9. Connecting a satellite tuner, television, or settop box (VIDEO 3 or 4)

Using an RCA video cable, connect the video output jack (composite) of the device to the VIDEO 3 (or 4) VIDEO IN jack of the TX-SR800. Or if the device has an S video output jack, connect it to the VIDEO 3 (or 4) S VIDEO IN jack of the TX-SR800 using an S video cable. Or if the device has component video outputs, connect them to one of the banks of COMPONENT VIDEO INPUT jacks on the TX-SR800.

**With the initial settings of the TX-SR800, the VIDEO 3 and 4 input sources are set for the COMPONENT VIDEO INPUT 2 jacks.**

If you connect the device to the COMPONENT VIDEO INPUT 1 jacks, this must be changed at Setup Menu → Input Setup → Video Setup → Component Video (see page 48).

Using an RCA audio cable, connect the audio output jack of the device to the VIDEO 3 (or 4) AUDIO IN jacks of the TX-SR800. Make sure that you properly connect the left channel to the L jack and the right channel to the R jack.

If the device has a digital output, connect it to either the DIGITAL INPUT COAX jack or DIGITAL INPUT OPT jack of the TX-SR800 depending on the type of connector on the device.

**With the initial settings of the TX-SR800, the VIDEO 3 input source is set for digital input at the OPT 3 jack.**

If the digital connection is made at a different jack, this must be changed at Setup Menu → Input Setup → Digital Setup (see page 46).

With the initial settings of the TX-SR800, the VIDEO 4 input source is not set for digital input. If you are connecting a digital component, these settings must be changed at Setup Menu → Input Setup → Digital Setup (see page 46).

### 10. Connecting video camera, etc. (VIDEO 5 INPUT)

Using an RCA video cable, connect the video output jack (composite) of the device to the VIDEO 5 VIDEO jack of the TX-SR800. Or if the device has an S video output jack, connect it to the VIDEO 5 S VIDEO jack of the TX-SR800 using an S video cable.

Using an RCA audio cable, connect the audio output jack of the device to the VIDEO 5 AUDIO jacks of the TX-SR800. Make sure that you properly connect the left channel to the L jack and the right channel to the R jack.

If the device has an optical digital output, connect it to the VIDEO 5 DIGITAL jack of the TX-SR800.

**The VIDEO 5 digital input is fixed to the OPTICAL input on the front panel.**

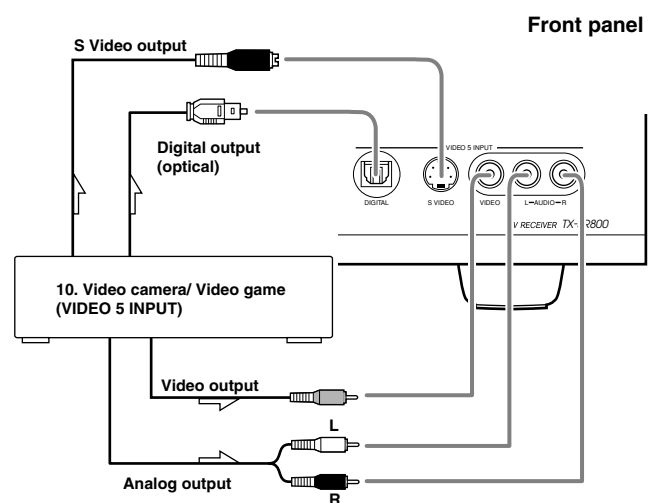

# Connecting speakers

Before connecting the speakers, it is very important to place them properly for the optimum sound space for your listening pleasure. Be sure to refer to the instruction manuals that came with the speakers during placement and connection. Furthermore, be aware that for surround playback, the configuration and placement of your speakers are both very important.

For THX surround EX playback, we recommend that you use a THX speaker system that is certified by THX Ltd.

## Ideal speaker configuration

- **Front right and left speakers**

- **Center speaker**

Produces a rich sound image by serving as a sound source for the front right and left speakers and enhancing the sonic movement.

- **Surround right and left speakers**

Adds three-dimensional sonic movement and produces environmental sound associated with the background and effect sound for each scene.

- **Surround back right and left speakers**

Required for enjoying THX Surround EX, DTS-ES Matrix 6.1, or DTS-ES Discrete 6.1 audio.

- **Subwoofer**

Produces powerful and heavy bass.

## Minimum speaker configuration for surround sound playback

- **Front right and left speakers**

- **Surround right and left speakers**

The sound recorded for the center speaker and the subwoofer will be properly distributed to the front right and left speakers for optimized surround playback.

## Speaker placement

Ideal speaker placement varies depending on the size of your room and the wall coverings. Here, only typical example of speaker placement and recommendations are shown.

In order to create the optimum conditions for the best sound quality, be sure to place all the speakers so that the greatest difference between the distances of each speaker to the listening position is less than 20 feet (6 meters).

### Important points regarding speaker placement

#### Front left and right speakers and center speaker

- Place these three speakers all at the same height.
- Place each speaker so that it is aimed at the location of the listener's ears when at the listening position.
- Place the right and left loudspeakers at an equal distance either side of the listening point.

#### Surround left and right speakers

- Place these speakers so that their height is 3 feet (1 meter) higher than that of the listener's ears.

### Surround back speakers

- Place these speakers so that their height is 3 feet (1 meter) higher than that of the listener's ears.
- When using surround back left and right speakers, place them behind the listener so that the angles between the lines from each speaker to the listener and a line straight back from the listener are less than 30 degrees.

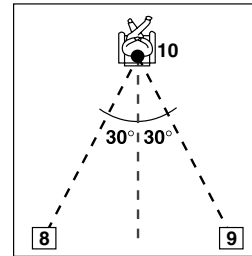

### Subwoofer

When bass sound is reproduced, its volume and quality greatly depend on subwoofer placement. Those characteristics also depend on the shape of your listening room as well as your listening point. Generally speaking, good bass sound is obtained when the subwoofer is placed in the corner of the room or at one-third the length of the room.

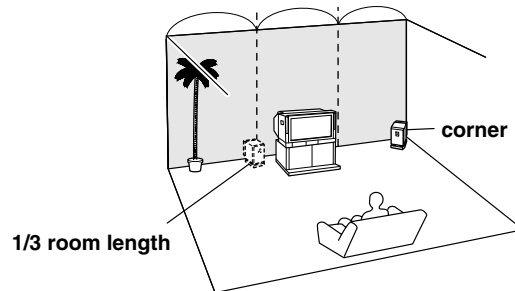

### For optimizing the subwoofer placement, we recommend you to:

- play a movie or music source containing good quality base sound,
- take some experimenting while changing subwoofer's position in the room, and
- try different positioning until you get the most out of the base sound while fixing the listening point.

#### Layout with dipolar speakers

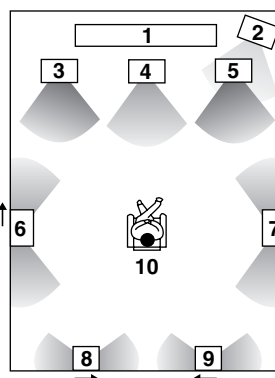

#### Layout with monopolar speakers

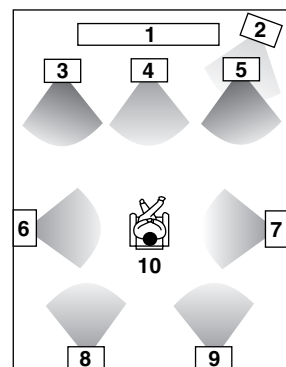

- 1 TV or screen
- 2 Subwoofer
- 3 Front left speaker
- 4 Center speaker
- 5 Front right speaker

- 6 Surround left speaker
- 7 Surround right speaker
- 8 Surround back left speaker
- 9 Surround back right speaker
- 10 Listening position

Most dipoles have an arrow on them to indicate their orientation in which that should be placed. For the correct acoustical phasing in the room, dipolar surround speakers should be placed so that their arrows point forward toward the screen and dipolar surround back speakers should be placed so that their arrows point to each other.

# Connecting speakers

## Connecting speakers

After determining the layout of your speaker system, it is now necessary to connect the speakers correctly to your TX-SR800.

### Caution:

**Connect only speakers with an impedance between 4 and 16  $\Omega$  to the TX-SR800. If the impedance of even one speaker is between 4 and 6  $\Omega$ , be sure to set the speaker impedance setting accordingly (see page 41).**

### Notes:

- Even if you are using only one speaker or listening to monaural (mono) sound, never connect a single speaker in parallel to both the right and left-channel terminals.

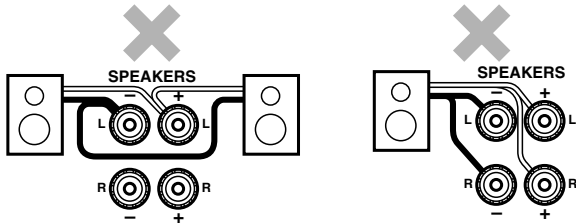

- To prevent damage to circuitry, never short-circuit the positive (+) and negative (-) speaker wire.

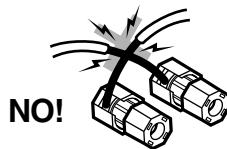

- Be sure to connect the positive and negative cables for the speakers properly. If they are mixed up, the left and right signals will be reversed and the audio will sound unnatural.
- Do not connect more than one speaker cable to one speaker terminal. Doing so may damage the TX-SR800.
- Connect either your surround back speakers or the speakers you will be using in the remote zone (Zone 2) to the SURR BACK SPEAKERS/ZONE 2 SPEAKERS terminals (see page 24).

## Using the speaker labels

The positive speaker terminals on the TX-SR800 are color coded for easy identification. Attach the supplied speaker labels to the speaker cables, and then match the colors on the speaker cables to the corresponding terminals.

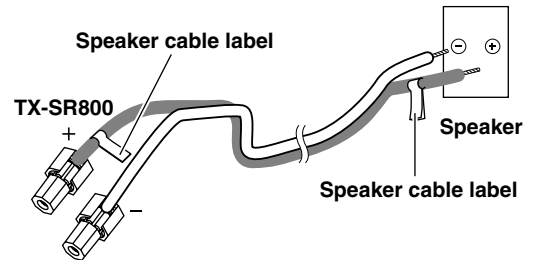

### The speaker channels are colored as follows:

- Front left speaker (+): White
- Front right speaker (+): Red
- Center speaker (+): Green
- Surround left speaker (+): Blue
- Surround right speaker (+): Grey
- Surround back/Zone 2 left speaker (+): Brown
- Surround back/Zone 2 right speaker (+): Tan

Use the PRE OUT SUBWOOFER jack to connect a subwoofer with a built-in power amplifier. If your subwoofer does not have a built-in amplifier, connect an amplifier to the PRE OUT SUBWOOFER jack and the subwoofer to the amplifier.

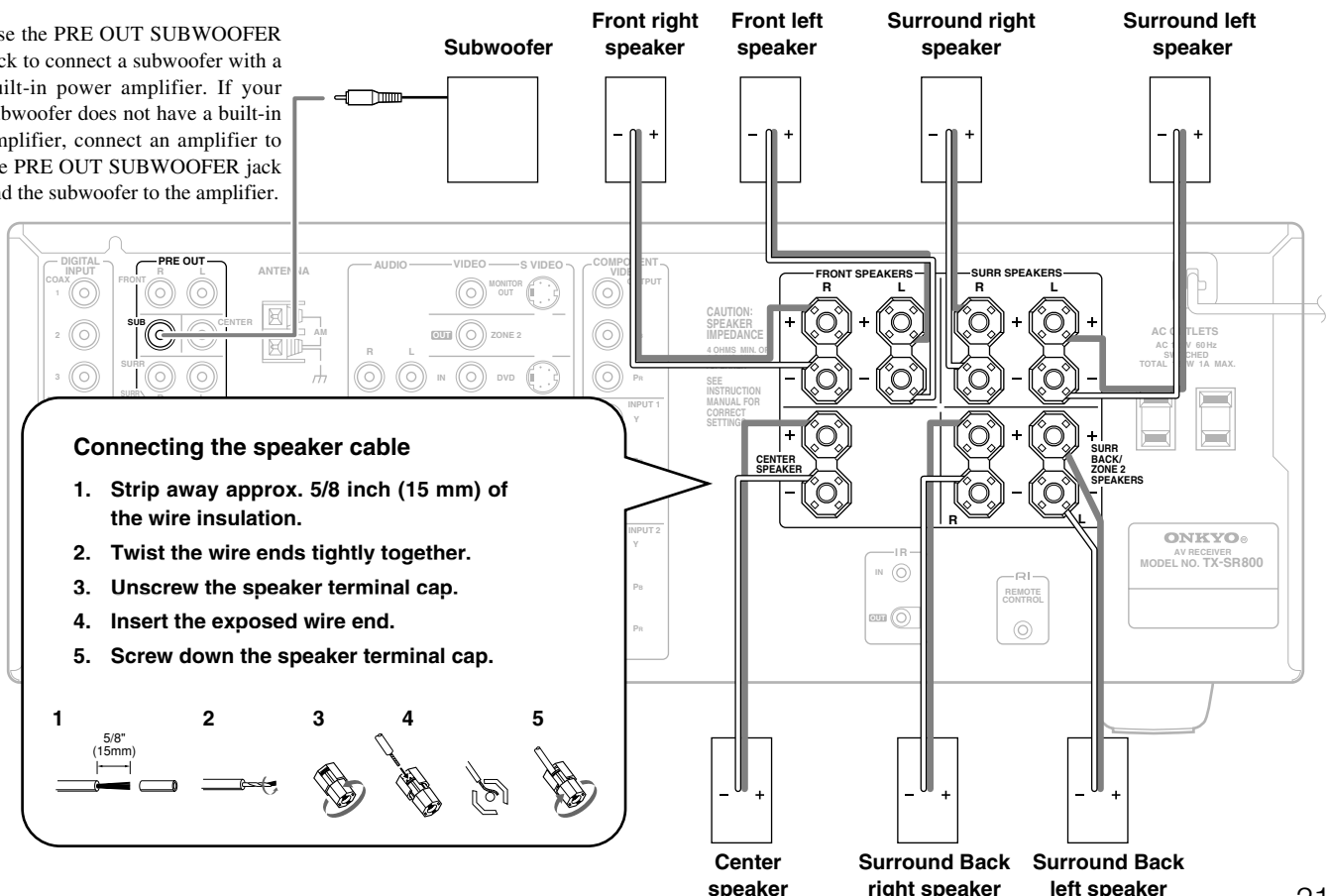

# Connecting antennas

To use the tuner of TX-SR800, it is necessary to prepare the supplied FM and AM antennas.

- Adjustment and placement of the FM and AM antennas for better reception must be done while listening to a station broadcast.
- If better reception cannot be obtained, then placement of an outside antenna is recommended.

## Assembling the AM loop antenna

Assemble the loop antenna as shown in the illustration.

- Refer to “Connecting the AM loop antenna” below for details on how to connect the loop antenna.

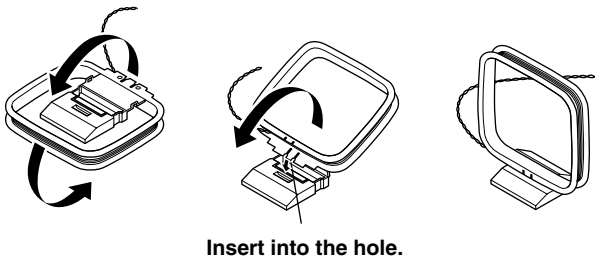

## Connecting the AM antenna cable

1. Press down the lever at the antenna terminal.
2. Insert the wire into the terminal hole.
3. Release the lever.

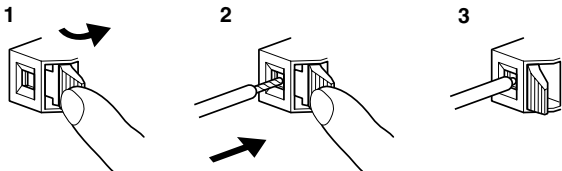

## Connecting the included antennas

### Connecting the FM indoor antenna:

The FM indoor antenna is for indoor use only. During use, extend the antenna and adjust its orientation until the clearest signal is received. Fix it with push pins or similar items in the position that will cause the least amount of distortion.

If the reception is not very clear with the attached FM indoor antenna, the use of an outdoor antenna is recommended.

### Connecting the AM loop antenna:

The AM loop antenna is for indoor use only. Set it in the direction and position where you receive the clearest sound. Put it as far away as possible from the TX-SR800, televisions, speaker cables, and power cords.

If the reception is not very clear with the attached AM indoor antenna, the use of an outdoor antenna is recommended.

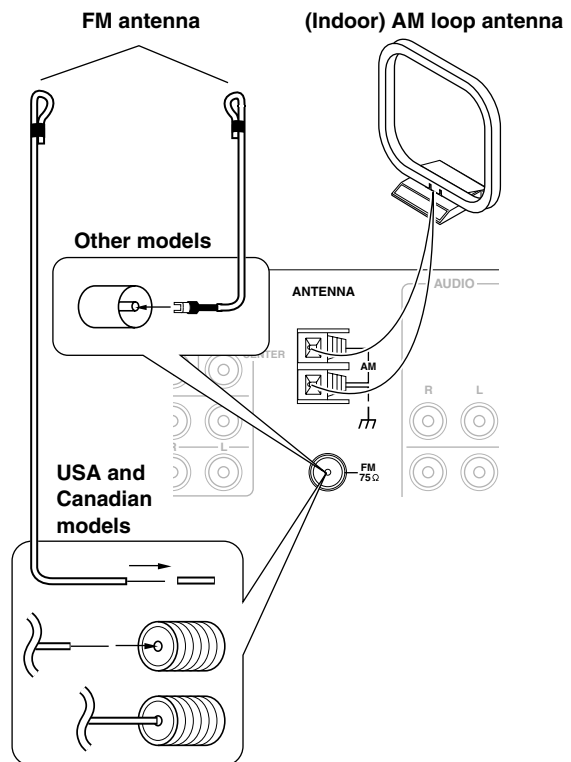

# Connecting antennas

## Connecting an FM outdoor antenna

Make sure to follow the general rules given below:

- Keep the antenna away from noise sources (neon signs, busy roads, etc.).
- It is dangerous to put the antenna close to power lines. Keep it well away from power lines, transformers, etc.
- To avoid the risk of lightning and electrical shock, grounding is necessary. Follow item 14 of the “Important Safeguards” on page 2 when you install the outdoor antenna.

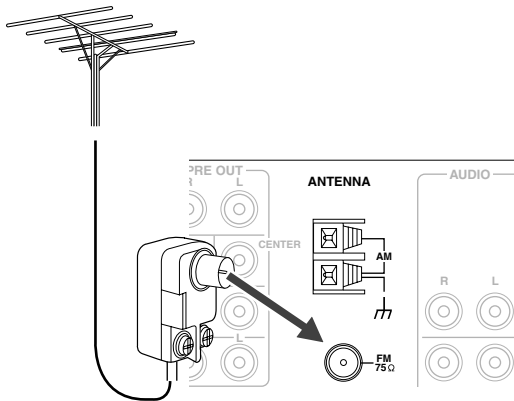

## Connecting an AM outdoor antenna

If reception is poor with the indoor AM antenna, stretch out the outdoor antenna (16 feet (5 meters) or more) above a window or outside.

- Keep the indoor AM loop antenna connected. Do not remove it.
- To avoid the risk of lightning and electrical shock, grounding is necessary. Follow item 14 of the “Important Safeguards” on page 2 when you install the outdoor antenna.

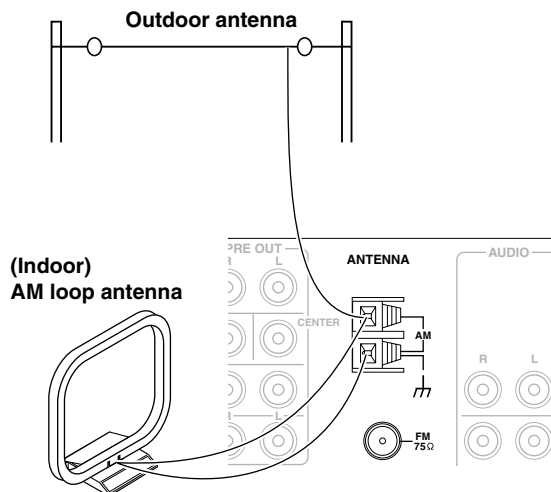

### Note:

If you are using the TX-SR800 worldwide model in a region where AM frequencies are delineated by 10-kHz steps, be sure to set the “AM Frequency Step” Setup setting accordingly (see page 42).

## Directional linkage

Do not use the same antenna for both FM and TV (or VCR) reception since the FM and TV (or VCR) signals can interfere with each other. If you must use a common FM/TV (or VCR) antenna, use a directional linkage type splitter.

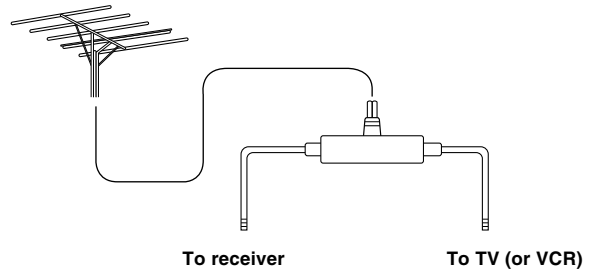

## Connecting the antenna cable to the 75/300 Ω antenna adapter (For all models other than USA & Canadian models)

### Connecting the 300 Ω ribbon wire:

Loosen the screws on the adapter and wrap the wires of the ribbon wire around these screws. Then tighten the screws down with a screwdriver.

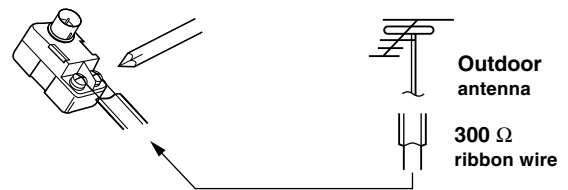

### Connecting the coaxial cable:

1. With your fingernail, or a small screwdriver, press the stoppers of the 75/300 Ω antenna adapter outward and remove the cover.
2. Remove the transformer wire A from slit B and insert it into slit C.
3. Prepare the coaxial cable as shown in the diagram.
4. Connect the 75/300 Ω antenna adapter to the coaxial cable.
  1. Insert the end of the cable.
  2. Clamp it in place with pliers.
5. Reinstall the cover.

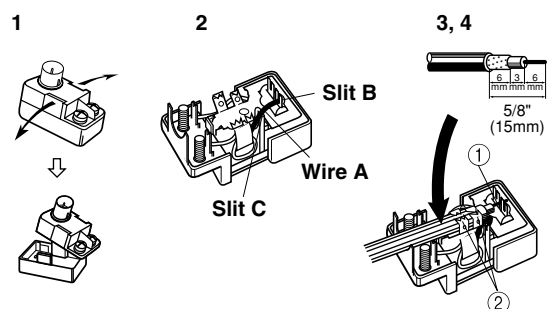

# Connecting the remote zone (Zone 2) speakers

The TX-SR800 allows you to watch and listen to two separate input sources at the same time. This allows you to, for example, place speakers and a television in two different rooms so that two or more people can enjoy two different movies at the same time. The room where the TX-SR800 is actually located is referred to as the main room while the separate room is referred to as the remote zone (Zone 2). In addition, the IR IN/OUT terminal of the TX-SR800 allows you to control the TX-SR800 from the remote zone (Zone 2) with the remote controller even though the remote zone is physically separated. The diagram below shows how to make the proper connections for the remote zone.

## When using the SURR BACK/ZONE 2 SPEAKERS terminals

If you are using a 5.1-channel speaker system in the main room, you can connect the speakers for the remote zone (Zone 2) to the open SURR BACK/ZONE 2 SPEAKERS terminals. With this connection, select "Zone 2" for the Hardware Setup → Surr Back/Zone2 → Surr Back/Zone2 setting in the Setup menu (see page 42).

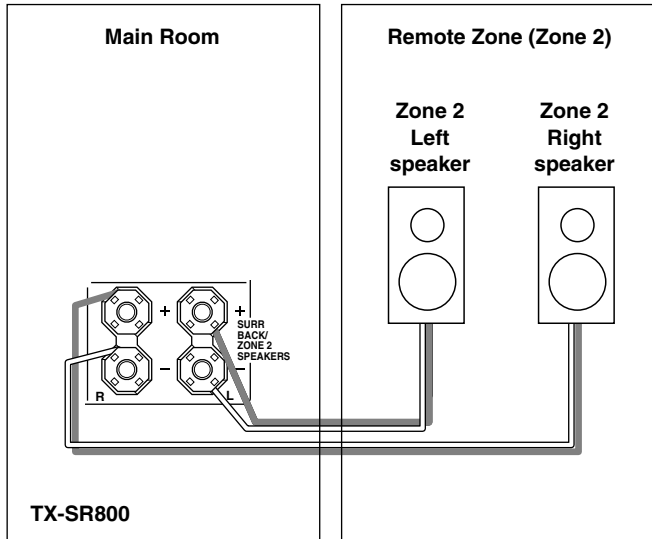

**Note:**  
It is important to be aware of the speaker impedance (see page 41).

## When using the SURR BACK/ZONE 2 PRE OUT terminals

If you are using a 5.1-channel speaker system in the main room, you can connect the amplifier for the remote zone (Zone 2) to the open SURR BACK/ZONE 2 PRE OUT terminals and connect the remote zone speakers.

With this connection, select "Zone 2" for the Hardware Setup → Surr Back/Zone 2 → Surr Back/Zone2 setting in the Setup menu (see page 42).

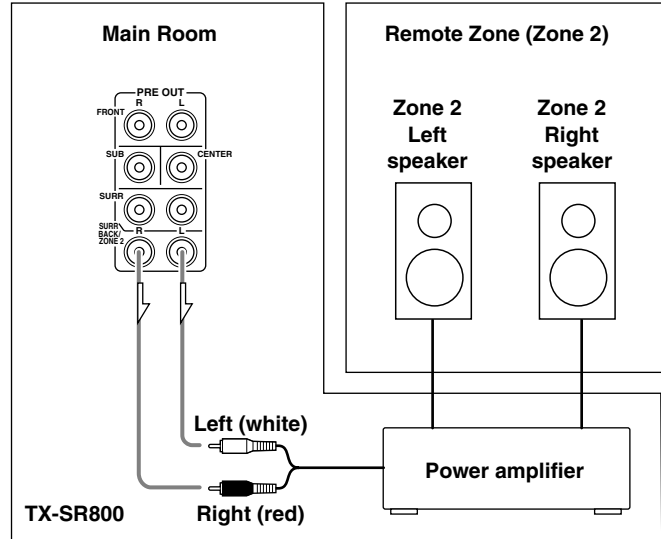

## Connecting the DTR-7.3 to the monitor for the remote zone

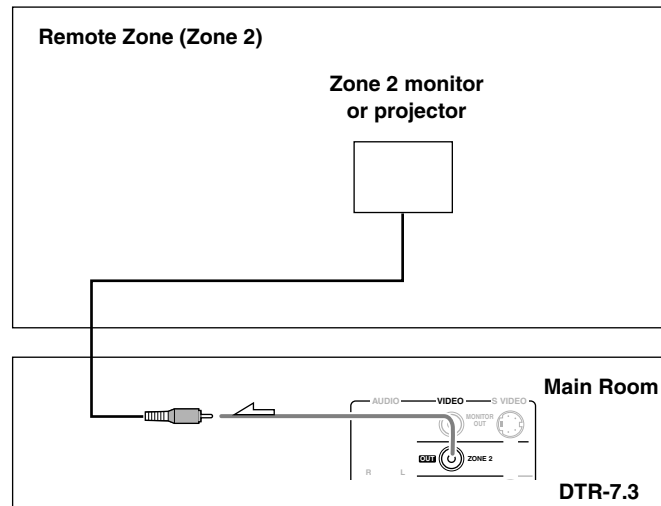



# Operating components not reached by the remote controller signals (IR IN/OUT)

In order to use the remote controller to control the TX-SR800 from a remote location, you will need to prepare a multi-room kit (sold separately) such as one of those given below:

- Onkyo's Multi-Room System kits (IR Remote Controller Extension System)
- Multiroom A/V distribution and control system such as those from Niles® and Xantech®

## If the remote controller signal does not reach the TX-SR800 remote sensor

If the TX-SR800 is located inside a cabinet or other enclosure where the infrared rays from the remote controller cannot enter, then operation with the remote controller will not be possible. In such a case, it will be necessary to install a remote sensor at a location outside of the cabinet for the infrared rays from the controller can reach.

With this connection, select "Main" for the Hardware Setup → IR IN Setup → Position setting in the Setup Menu (see page 42).

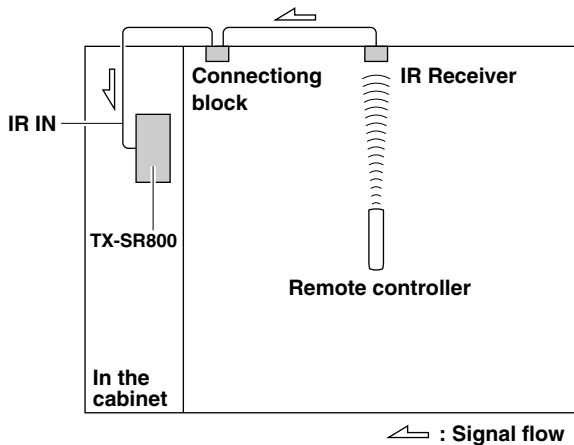

The IR IN input allows you to control the TX-SR800 from the remote zone (Zone 2) with the remote controller even though the remote zone may be on the other side of the building from the main zone. The diagram below shows how to make the proper connections for the remote zone.

With this connection, select "Zone 2" for the Hardware Setup → IR IN Setup → Position setting in the Setup Menu (see page 42).

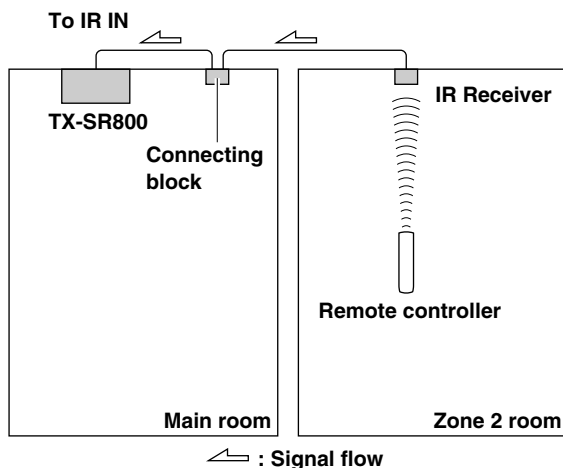

Make the connection as shown below. Do not plug in any equipment to the power outlet until all the connections are complete.

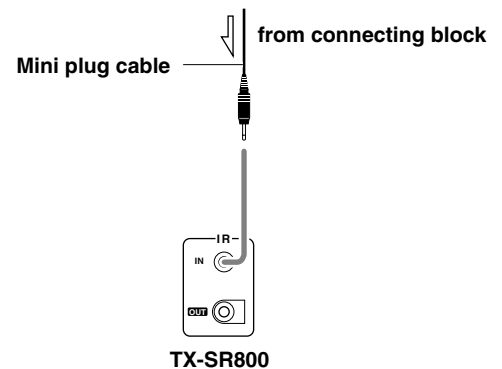

## If the remote controller signal does not reach other components

In this situation, you will need to use a commercially available IR emitter. Connect the mini plug of the IR emitter to the IR OUT terminal on the TX-SR800 and then place the IR emitter on the remote sensor of the component or facing it. When the IR emitter is connected, only the signal input to the IR IN terminal is output to the IR OUT terminal. The signal input from the remote sensor on the front of the TX-SR800 will not be output to the IR OUT terminal.

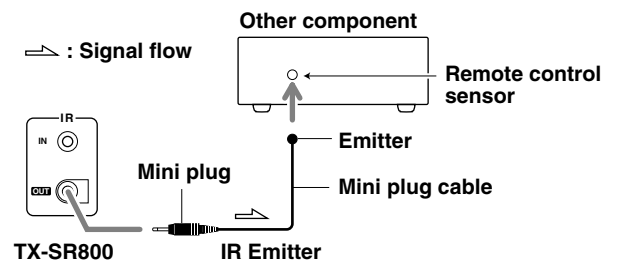
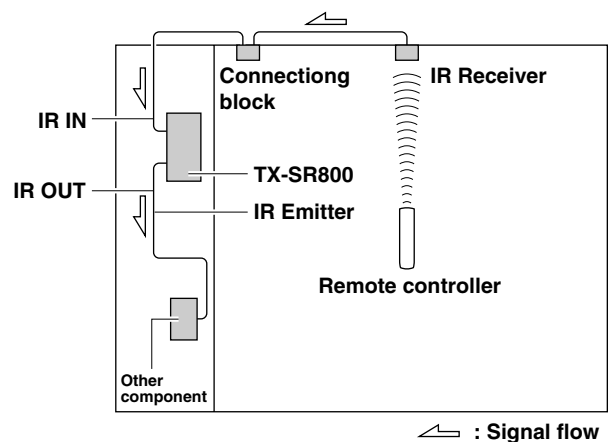

# Miscellaneous Connections

## Connections for remote control (RI)

The **RI** terminal on the TX-SR800 is for connecting other Onkyo components equipped with the same **RI** terminal. When a component is connected to the **RI** terminal, it can be operated by the remote controller supplied with the TX-SR800. In addition, when you connect a component to the **RI** terminal, you can also perform the system operations given below.

### Power on/ready function

When the TX-SR800 is in the standby state, if an **RI**-connected component is turned on, the TX-SR800 also turns on and the input source selected at the TX-SR800 automatically switches to that component.

Be aware that this function will not work if the power cord for the **RI**-connected component is connected to the AC OUTLET on the TX-SR800, or if the TX-SR800 has already been turned on.

### Direct change function

When the play button is pressed at an **RI**-connected component, the input source selected at the TX-SR800 automatically changes to that component.

### Power off function

When the TX-SR800 is placed in the standby state, all **RI**-connected components are also automatically put into the standby state.

Also, if you press the ON button on the TX-SR800 remote controller while the TX-SR800 is turned on, all **RI**-connected components (DVD players, CD players, MD recorders, tuners, etc.) are also turned on.

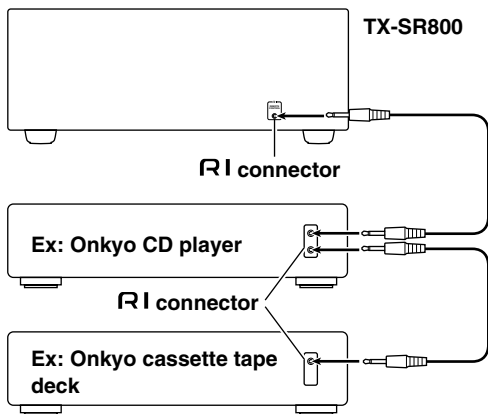

To connect components using the **RI** terminal, simply connect a remote control cable from this **RI** terminal to the **RI** terminal of the other component. An **RI** remote control cable with a 1/8-inch (3.5-mm) miniature two-conductor plug comes with every cassette tape deck, compact disc player, MD recorder, and DVD player that has an **RI** terminal.

- When performing operations with **RI**-connected components using the **RI** system, do not use the remote zone (Zone 2).
- For remote control operation, the audio connection cables must also be connected.
- If a component has two **RI** terminals, you can use either one to connect to the TX-SR800. The other one can be used to daisy chain with another component.
- With Onkyo DVD players, you can enter the pre-program code so that you can operate the DVD player directly with the remote controller without connecting the **RI** terminals (see page 65).

## Connecting the power cords from other devices

The TX-SR800 is equipped with AC mains outlets for connecting the power cords from other devices so that their power is supplied through the TX-SR800. By doing this, you can leave the connected device turned on and have the STANDBY/ON button on the TX-SR800 turn on and off the device together with the TX-SR800.

**The shape, number, and total capacity of the AC outlets may differ depending on the area of purchase.**

### Caution:

Make sure that the total capacity of the components connected to the TX-SR800 does not exceed the capacity that is printed on the rear panel (e.g., TOTAL 120W).

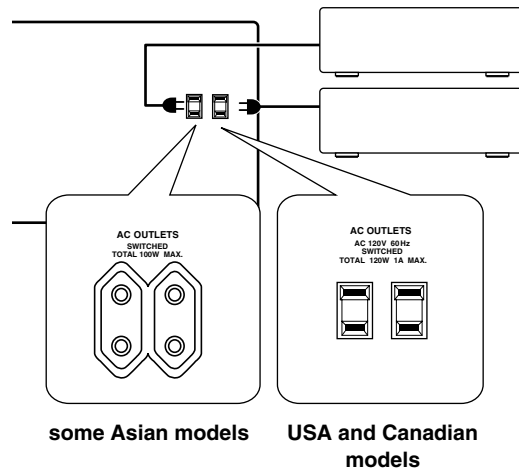

# Miscellaneous Connections

## Connecting to devices with analog multi channel output

Connect a DVD player, MPEG decoder, or other component that has a multi channel port for 5.1 channel or 7.1 channel output.

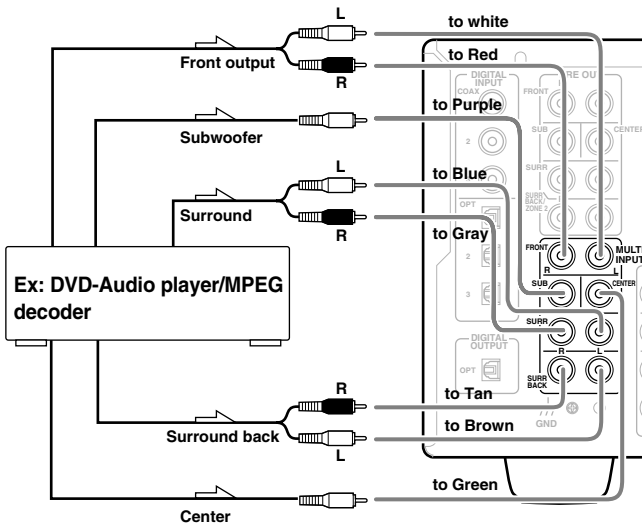

## Connecting auxiliary power amplifier

These jacks are for connecting auxiliary power amplifier. You can use an auxiliary power amplifiers to listen at louder volumes than you can with the TX-SR800 alone. When using a power amplifier, connect each speaker to the power amplifier.

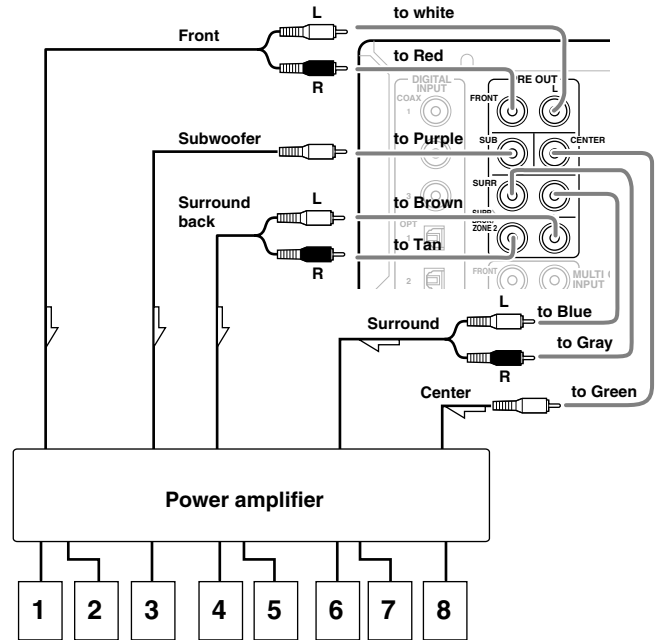

- |   |   |
|---|---|
| 1. Front left speaker                         | 5. Surround back right/<br>ZONE 2 right speaker |
| 2. Front right speaker                        | 6. Surround left speaker                        |
| 3. Subwoofer                                  | 7. Surround right speaker                       |
| 4. Surround back left/<br>ZONE 2 left speaker | 8. Center speaker                               |

# Connecting the power

(USA and Canadian models)

STANDBY/ON

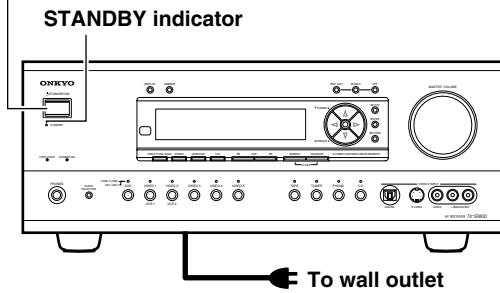

(All models other than USA and Canadian models)

STANDBY/ON

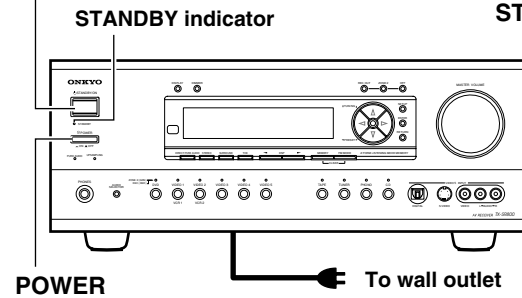

ON  
STANDBY  
RCVR

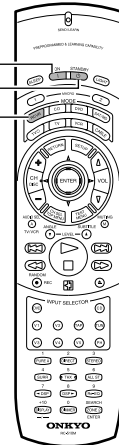

- Before you plug in the TX-SR800, confirm that all connections have been made properly.
- Turning on the power may cause a momentary power surge, which might interfere with other electrical equipment on the same circuit, such as computers. If this happens, use a wall outlet on a different circuit.

(All models other than USA and Canadian models)

- The TX-SR800 is shipped with the main power (POWER) switch in the on position (ON). When the power cord is plugged in for the first time, the TX-SR800 will automatically enter the standby state and the STANDBY indicator will light (same condition after step 2 below).

## Memory preservation (Other than USA and Canadian models)

The TX-SR800 does not require memory preservation batteries. A built-in memory backup system preserves the contents of memory (e.g., speaker settings and surround settings) during power failures and even when the power is turned off with the POWER switch. The backup system is charged when the POWER switch is turned on.

The length of time that the memory will be preserved will vary depending on the ambient climate. On the average, memory contents are protected over a period of a few weeks after the last time the unit has been turned off. This period may be shorter when the unit is exposed to a highly humid climate.

## Turning on the power

### 1. Plug the power cord into an AC wall outlet.

(USA and Canadian models)

The STANDBY indicator will light up.



(All models other than USA and Canadian models)

**Press the POWER switch to set the TX-SR800 to standby state.**

The STANDBY indicator will light up.

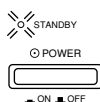

### 2. Press the STANDBY/ON button to turn on the TX-SR800.

The display will light up and the STANDBY indicator will turn off.

If you press the STANDBY/ON button again, the receiver returns to Standby state.

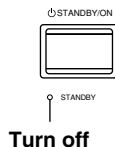

## Memory preservation (USA and Canadian models)

The TX-SR800 does not require memory preservation batteries. A built-in memory backup system preserves the contents of memory (e.g., speaker settings and surround settings) during power failures and even when the unit is unplugged. The unit must be plugged in order to charge the back-up system.

The length of time that the memory will be preserved will vary depending on the ambient climate. On the average, memory contents are protected over a period of a few weeks after the last time the unit has been unplugged. This period may be shorter when the unit is exposed to a highly humid climate.

## Turning on the power from the remote controller

Before you can use the remote controller, you must perform steps 1 and 2 above and place the TX-SR800 in the standby state.

### 1. Press the RCVR MODE button.

The RCVR MODE button lights.



### 2. Press the ON button to turn on the TX-SR800 (take it out of the standby state).

To return the TX-SR800 to the standby state, press the STANDBY button.

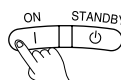

# Enjoying music or videos with the TX-SR800

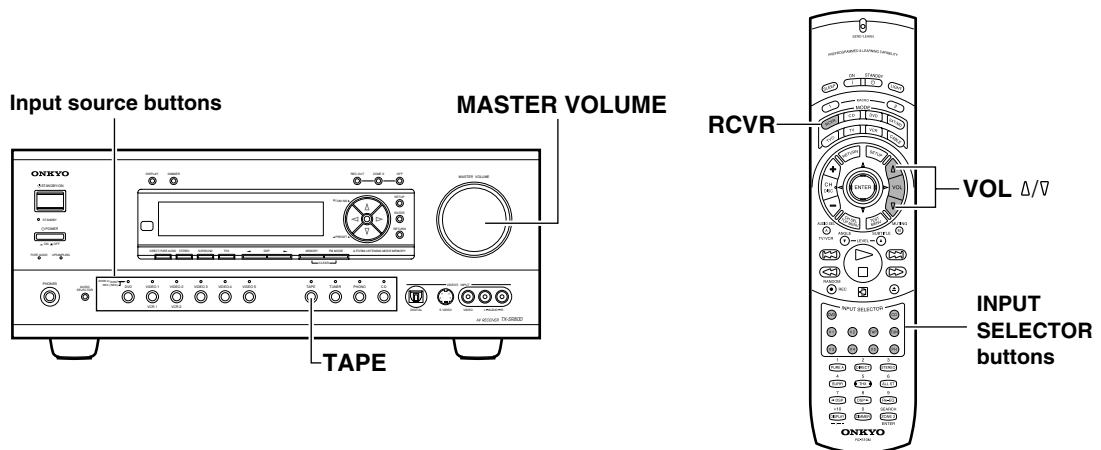

Though the TX-SR800 is often used to listen to the radio, it does not show you its true ability until it is used to play music or watch videos, DVDs, and the like. The TX-SR800 has the latest and most state-of-the-art features to play back today's technologies with the utmost in fidelity and power. From a two-speaker system to a seven-speaker system, you are assured a sound space that you can always enjoy.

To ensure the proper sound space, you must first perform the speaker setup settings. These settings allow you to set the type of speakers you are using, the distance that they are located from the listening position, and the individual speaker volumes. For more details, see Speaker Setup Sub-menu of the Setup Menu on page 43.

## Basic operation

If you want to perform these operations using the remote controller, first press the RCVR button.

1. Press the input source button (or INPUT SELECTOR button on the remote controller) that corresponds to the source to which you want to listen.

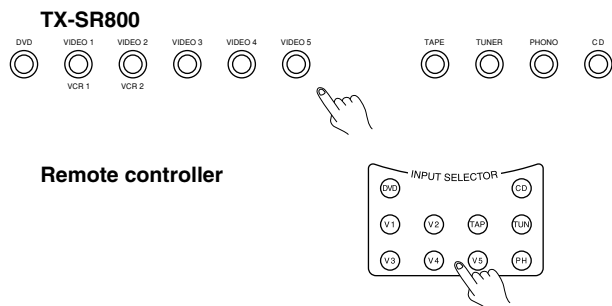

2. Turn on the corresponding component and play the media.

3. Adjust the volume.

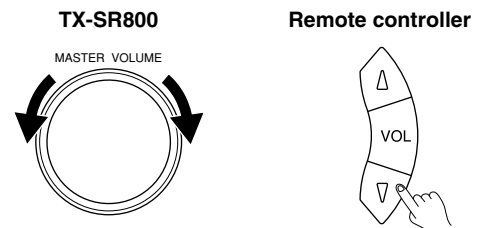

Adjusting the main volume adjusts the volume level of all the speakers connected to the TX-SR800 together. If headphones are connected, this also adjusts the volume heard from the headphone speakers. To adjust the volume, either press the VOL Δ/∇ buttons on the remote controller or turn the MASTER VOLUME dial. To increase the volume, turn the dial clockwise; to decrease the volume, turn the dial counterclockwise. The volume can be set to 0 to 100 (or  $-\infty$ ,  $-81$  to  $+18$  dB).

## To change the display of the input source from TAPE to MD

If you connected an MD recorder to the TAPE jack on the TX-SR800, you can have "MD" appear when the TAPE source button is pressed.

### Changing the display:

Press and hold down the TAPE source button until the display changes from TAPE to MD (approx. 3 seconds).

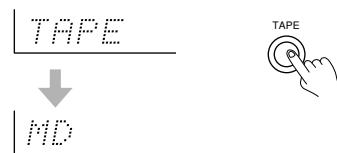

To return the display to its original setting, perform the same procedure.

# Enjoying music or videos with the TX-SR800

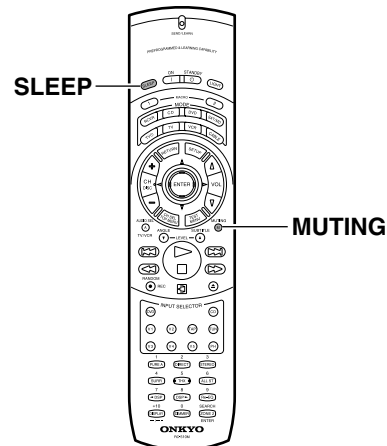
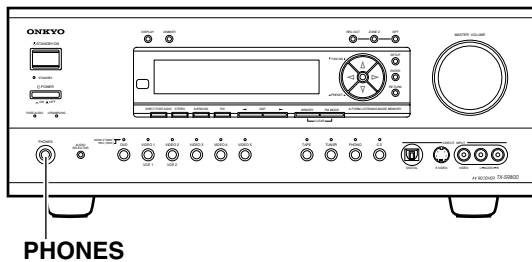

## Temporarily turning off the sound

To turn off the sound momentarily, press the MUTING button on the remote controller. When pressed, “Muting” is displayed on the TX-SR800. Press the MUTING button again to turn the sound back on.

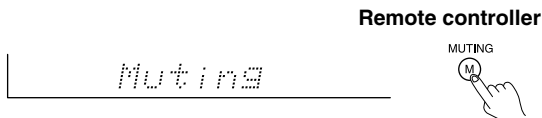

## Adjusting the bass and treble

You can adjust the bass and treble levels at the Setup Menu → Audio Adjust Menu → Tone Control Sub-menu (see page 53). This function only affects the front left and right speakers, center speaker, and subwoofer. Only the bass level can be adjusted for the subwoofer (the treble adjustment is not effective). For multichannel sources, these dials will not work if the tone control is set to “Direct” or “Pure Audio.”

## Listening with headphones

To listen with headphones, plug a pair of headphones with a standard stereo plug into the PHONES jack on the TX-SR800 front panel.

When you connect headphones, no sound will be heard from the speakers.

When the headphones are unplugged, the TX-SR800 returns to its original listening mode. When using the headphones, you can only use the Direct, Stereo, and Mono listening modes. (Available modes can vary depending on the current input source.)

If you have selected MULTI CH INPUT, you will only hear the sound only output to the front right and left channels.

The headphone volume level can be adjusted at the Setup Menu (see page 60).

### Note:

The signal to the remote zone (Zone 2) will not be affected by whether or not headphones are connected.

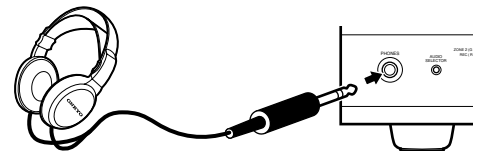

## Using the sleep time (remote controller only)

The SLEEP button enables you to set the TX-SR800 to turn off automatically after a specified time period. If you press it once, the TX-SR800 will turn off after 90 minutes. Each time it is pressed thereafter, the remaining time until the TX-SR800 turns off decreases by 10 minutes (i.e., from 90 to 80 minutes). While, the sleep function is enabled, you can press the SLEEP button to see how much time is left. If you now press the SLEEP button, the remaining time will be reduced down to the nearest 10 minutes. If it is pressed again, then the remaining time will be decreased by 10 minutes each time it is pressed (e.g., if SLEEP is pressed with the display reading 54 minutes, it will be reduced to 50 minutes. If it is pressed again, it will then be reduced to 40, then 30, and so on). If the SLEEP button is pressed when the time displayed is less than 10 minutes, the sleep function is cancelled.

If you are using the remote zone (Zone 2), it will turn off at the same time as the main zone. If you want to set the sleep function for Zone 2 only, set the sleep function with main zone turned on and then put the main zone into the standby state.

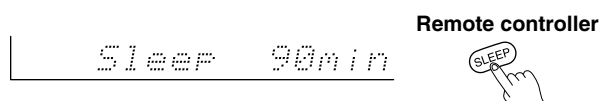

# Enjoying music or videos with the TX-SR800

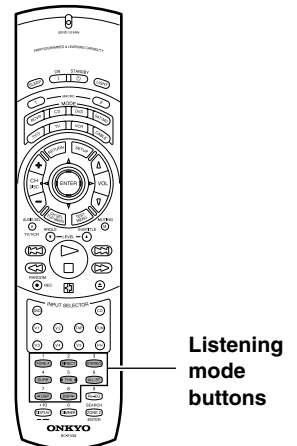
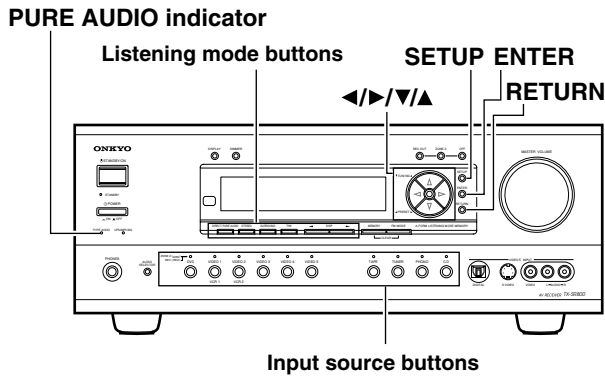

## Changing the listening mode

To change the listening mode during playback, press the listening mode buttons. The functions of the buttons on the TX-SR800 and those on the remote controller are the same.

For more information on each listening mode, see pages 50 through 52.

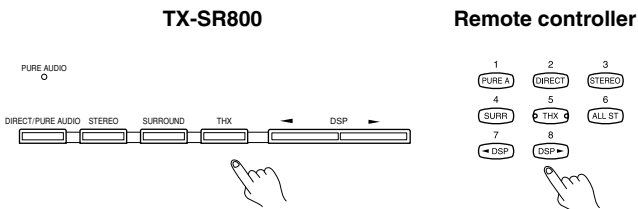

**DIRECT/PURE AUDIO (DIRECT/PURE A):** Changes the listening mode for the signal type that is currently being input from the selected input source to the Direct listening mode. If pressed, the corresponding setting in the Listening Mode Preset Sub-menu of the Input Setup Menu for the selected input source is also changed. When the listening mode is set to Direct, you can switch between Direct and Pure Audio. When you select Pure Audio, the video signal is interrupted (resulting in a blacked-out screen), and the PURE AUDIO indicator lights up.

When you are using the remote Zone (Zone 2), the Pure Audio setting will not work.

**STEREO:** Changes the listening mode for the signal type that is currently being input from the selected input source to the Stereo listening mode. If pressed, the corresponding settings in the Listening Mode Preset Sub-menu of the Input Setup Menu for the selected input source is also changed.

**SURROUND (SURR):** Changes the listening mode for the signal type that is currently being input from the selected input source to the surround mode that matches the signal type (e.g., Dolby Pro Logic II, Dolby Digital, or DTS). If pressed, the corresponding settings in the Listening Mode Preset Sub-menu of the Input Setup Menu for the selected input source is also changed.

### If the SURROUND button is pressed

- **While playing back DTS sources**  
Switches the DTS-ES setting from: Auto → On → Off.
- **While playing back Analog/PCM sources**  
Switches from: Pro Logic II Movie → Pro Logic II Music → DTS Neo6:Cinema → DTS Neo6:Music.

- **While playing back D.F. 2-channel sources**  
Switches from: Pro Logic II Movie → Pro Logic II Music → DTS Neo6:Cinema → DTS Neo6:Music.

**THX:** Changes the listening mode to the THX listening mode.

### If the THX listening mode is selected

- **While playing back Dolby Digital sources**  
Switches the THX Surround EX mode (Auto → On → Off) if the source is a THX Surround EX-compatible source.
- **While playing back Analog/PCM sources**  
Switches the decoding mode (Pro Logic II Movie → DTS Neo6:Cinema) for THX processing.
- **While playing back DTS sources**  
Switches the DTS-ES mode from Auto → On → Off. Changing the DTS-ES mode allows you to enjoy the DTS THX Cinema, DTS-ES Discrete 6.1 THX Cinema, and DTS-ES Matrix 6.1 THX Cinema surround systems.

Be aware that if surround back speakers are not connected, or if the Surr Back/Zone 2 setting of the Surr Back/Zone 2 Sub-menu is set to "Zone 2," the THX Surround EX, DTS-ES Discrete 6.1, or DTS-ES Matrix 6.1 listening modes cannot be selected.

**DSP** ◀▶: Changes the listening mode for the signal type that is currently being input from the selected input source as shown below.  
Mono ↔ Theater-Dimensional ↔ Mono Movie ↔ Enhanced 7  
↔ Orchestra ↔ Unplugged ↔ Studio-Mix ↔ TV Logic ↔ All Ch Stereo ↔ Mono.

If pressed, the corresponding settings in the Listening Mode Preset Sub-menu of the Setup Menu for the selected input source is also changed.

**All ST:** Changes to All Ch Stereo the listening mode for the input signal of the input source currently selected. If pressed, the corresponding setting in the Listening Mode Preset Sub-menu of the Setup Menu for the selected input source is also changed.

# Enjoying music or videos with the TX-SR800

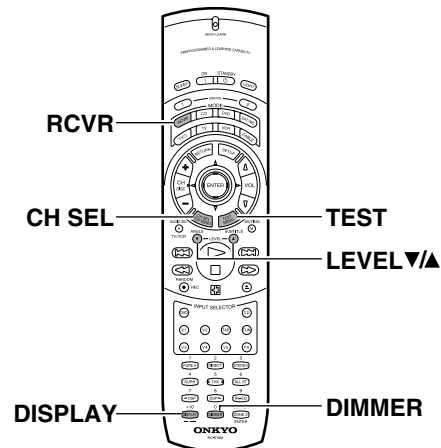
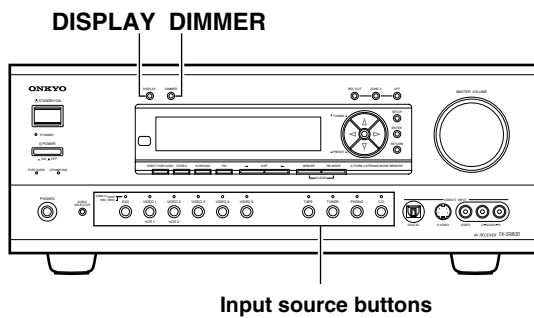

## Switching the display

While listening to or watching an input source, you can display the information regarding the type of source and signal being input by pressing the DISPLAY button on the TX-SR800 or the remote controller.

### TX-SR800



### Remote controller



## Adjusting the brightness of the front display

You can adjust the brightness of the front display of the TX-SR800 using the DIMMER button on the remote controller or on the TX-SR800 front panel.

### TX-SR800



### Remote controller



When an input source other than FM or AM is selected:

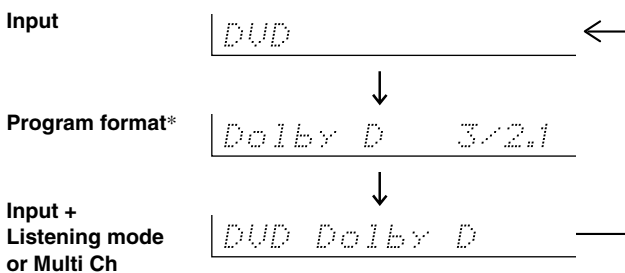

### \* When the input signal is digital audio

The program format is displayed. For example, the display “Dolby D: 3/2.1” shows that the format is Dolby Digital with 5.1 discrete channels consisting of three front channels (front left, front right, and center), two surround channels (surround left and surround right), and the low frequency effect (LFE) channel.

When the front channel number is 2, they are the front left and front right; when it is 1, it is monaural. When the surround channel number is 1, it is monaural; when it is 0, there is no surround channel. When no LFE number is given, there is no LFE channel. Also, if there is no program format for the input signal, nothing will be displayed.

### When the input signal is linear PCM

The sampling frequency is displayed. For example, the display “PCM fs: 44.1k” shows that the signal is PCM and that the sampling frequency is 44.1 kHz.

## Temporarily changing the speaker output levels

To change the individual speaker volumes temporarily, follow the procedure given below. Each channel can be set between -12 and +12 decibels. The subwoofer can be adjusted between -15 and +12 decibels. Note that the speaker volumes will return to the original settings when the TX-SR800 is put in the standby state.

1. Press the RCVR MODE button.
2. Press the CH SEL button and select the desired speaker.
3. Press the LEVEL ▼ or ▲ button to adjust the volume level.



### Notes:

- You cannot select a speaker if it is set to “No” or “None” in the Speaker Config Sub-menu of the Speaker Setup Menu.
- To have your new speaker levels set here overwrite the settings at Setup Menu → Speaker Setup Menu → Level Calibration Sub-menu, press the TEST button after you complete step 3 in the procedure above.

When FM or AM is selected as the input source:

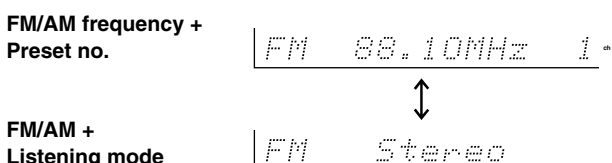



# Enjoying music or videos with the TX-SR800

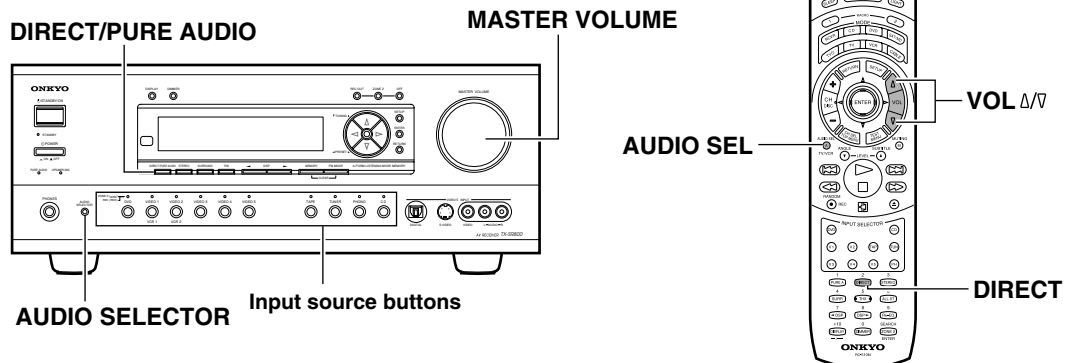

## Changing the audio mode

Press the AUDIO SELECTOR button on the front panel (or AUDIO SEL button on the remote controller) to change the audio mode. Each time the button is pressed, the mode changes from “Auto” → “Multich” → “Analog” and back to “Auto.” The “Auto” audio mode is recommended for normal circumstances.

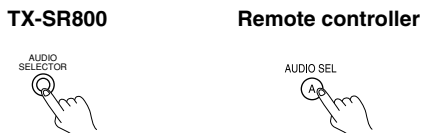

**Auto (automatic detection):** With this setting, the TX-SR800 automatically detects whether the input signal is digital or analog. When a digital signal is not input, then the analog signal is played. This setting only appears if a digital input is selected for the Digital Input setting at Setup Menu → Input Setup Menu → Digital Setup Sub-menu (see page 46).

**Multich (Multichannel):** Select this setting to play back the input from the component connected to the MULTI CHANNEL INPUT port. This setting only appears if “Yes” is selected for the Multichannel setting at Setup Menu → Input Setup Menu → Multichannel Setup Sub-menu (see page 47).

**Analog:** Select this setting to play back the input from a source component connected to analog audio input jacks. With this setting, even if a digital signal is input from the same component, only the analog signal will be output.

## Enjoying the multichannel output

Before starting operations, first make sure that the multichannel connection is properly made and that “Yes” is selected for the Multichannel setting at Setup Menu → Input Setup Menu → Multichannel Setup Sub-menu (see page 47).

1. Press the input source button for the component connected to the MULTI CHANNEL INPUT on the rear of the TX-SR800.
2. Select “Multich” using the AUDIO SELECTOR button on the front panel (or AUDIO SEL button on the remote controller).

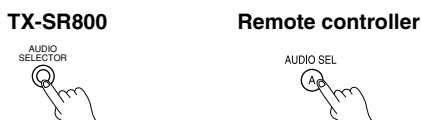

3. Turn on the connected component and start playing the desired media.

4. If necessary, adjust the output level of each speaker as desired (see page 32).

Adjust the volume at each speaker so that all the volumes sound at the same level at the listening position. For the front right, front left, center, surround right, surround left, surround back right, and surround back left speakers, the output levels can be adjusted between -12 and +12 decibels. The subwoofer can be adjusted between -30 and +12 decibels.

### Note:

If you change the speaker levels in step 4 above, these new levels for multichannel sources will have no effect on the settings at Setup Menu → Speaker Setup Menu → Level Calibration Sub-menu (see page 45).

5. Adjust the volume with the MASTER VOLUME dial (or the VOL Δ/V buttons on the remote controller.)

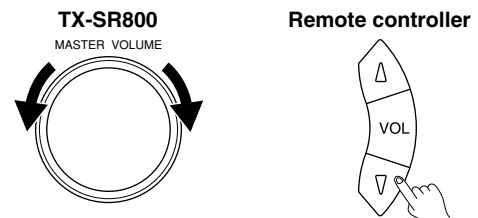

### Changing the listening mode:

Each time you press the DIRECT/PURE AUDIO button on the front panel, the display changes between “Direct” ↔ “Pure Audio.” When using a remote controller, press PURE A or DIRECT.

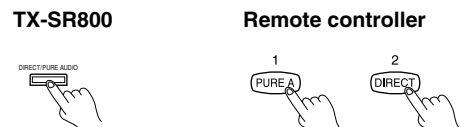

### Using the tone control:

1. Press the SURROUND button on the front panel (or the SURR button on the remote controller) to display “Tone On.”
2. Adjust the tone at Setup Menu → Audio Adjust Menu → Tone Control Sub-menu (see page 53).

Press the DIRECT/PURE AUDIO button on the front panel (or the DIRECT button on the remote controller) to turn off the tone control.

# Listening to Radio Broadcasts

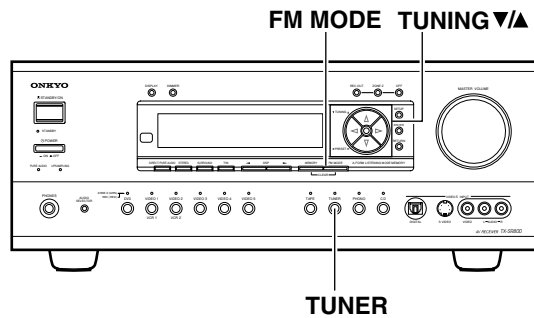

One of the features of the TX-SR800 that is most frequently used is its ability to play FM and AM broadcast radio stations. The TX-SR800 provides a number of listening modes perfect for listening to the radio and getting the most out of your audio system. Also, by presetting radio stations that you listen to frequently, you can select them easily by pressing the CH +/- button on the remote controller.

## Listening to a stereo radio station (FM mode)

When you tune into a radio station, ► TUNED ◀ indicator appears in the display. If you tune into an FM station in stereo, then "FM STEREO" appears. If the signal is weak, it may be impossible to tune into the station in stereo. In such a case, **press the FM MODE button** on the front panel. The AUTO indication disappears and the radio station is output in the monaural mode. To return to stereo, press the FM MODE button again. "AUTO" appears. Some inter-station noise may be heard, but the sound will not cut in and out as it would if stereo was selected.

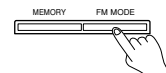

## Tuning into a radio station

### 1. Press the TUNER input source button.

Each time you press the TUNER button, the input source changes between AM and FM.



### 2. Using the TUNING ▼ and ▲ buttons on the front panel, tune into the station you desire.

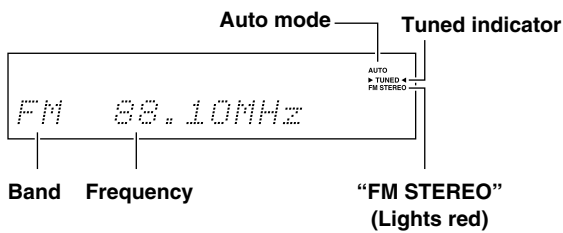
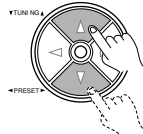

- The tuner frequency changes in 100-kHz (50-kHz) increments for FM and 10-kHz (or 9-kHz) increments for AM.
- You can press the TUNING ▼ or ▲ button continuously for more than 0.5 seconds to scan for an FM station in the direction of the button you pressed (FM auto tuning mode). After you release the button and a station is received in stereo, the scanning stops.

# Listening to Radio Broadcasts

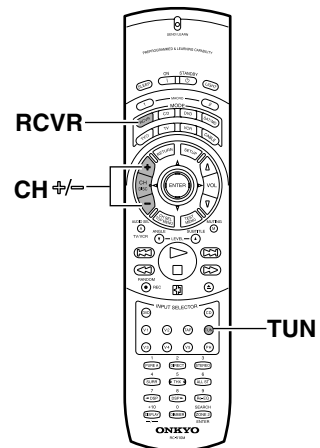
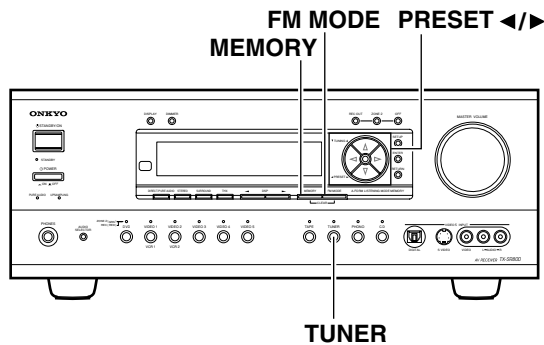

## Presetting a radio station

1. Tune into the radio station you desire (see “Tuning into a radio station”).

FM 88.10MHz

2. Press the MEMORY button on the front panel.

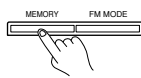

FM 88.10MHz 7

3. Using the PRESET <math>\triangleleft/\triangleright</math> buttons, select a preset number (from 1 to 40) to assign the station.

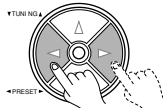

4. Press the MEMORY button to finalize the procedure.

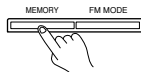

FM 88.10MHz 7

This programs the radio station as a preset radio station.

- Up to 40 stations can be stored in memory as preset radio stations.
- You can enter text names for any of the preset radio stations (see page 49).

## Selecting a preset radio station

1. Press TUNER input source button on the TX-SR800 or TUN button on the remote controller. The front display should show the currently selected frequency.



2. Press the PRESET <math>\triangleleft/\triangleright</math> buttons and select the number of the desired preset station.

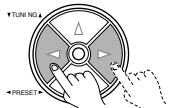

When using the remote controller:

1. Press the RCVR MODE button.  
The RCVR MODE button lights.
2. Press the TUN button.
3. Press the CH <math>\pm/\mp</math> button and select the number of the desired preset station.

## Erasing a preset radio station

1. Press the TUNER input source (or TUN) button and press the PRESET <math>\triangleleft/\triangleright</math> buttons to select the preset radio station that you want to erase (see above).

FM 88.10MHz 7

2. Press and hold the MEMORY button and then press the FM MODE button.

The selected preset station is erased.

# Enjoying music in the remote zone

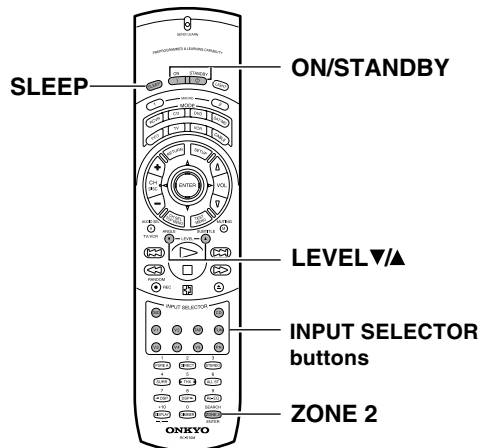
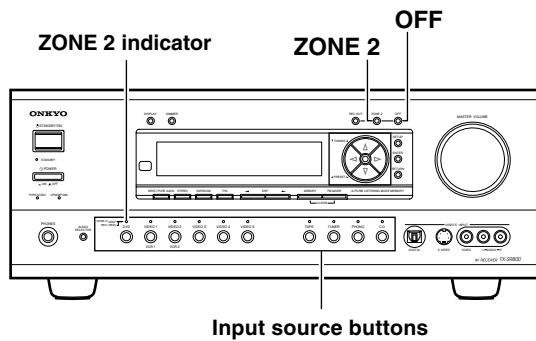

## Using the buttons on the TX-SR800

1. Press the ZONE 2 button on the TX-SR800.
2. Select an input source.

After pressing the ZONE 2 button, you must press an input source button within 8 seconds.

The indicator above the input source button lights green. In this condition, even if you change the input source for the main zone, the input source for the remote zone (Zone 2) will not change.

**Ex.: When the CD button is pressed.**

Z2 Sel: CD

To select the same source for the remote zone that is selected for the main zone, press the ZONE 2 button again until "Z2 Sel:SOURCE" appears in the display.

In this condition, if you change the input source for the main zone, the input source for the remote zone (Zone 2) will change as well.

Z2 Sel: SOURCE

When "Z2 Sel:Off" is displayed, the output to the remote zone is turned off.

### Notes:

- If a sleep time is set with the SLEEP button, the output to the remote zone will also turn off when the sleep time elapses.
- The ZONE 2 terminal is an analog output. Digital signals are not output. If no sound is heard from the selected input source, check if the component is connected to the analog inputs.
- If the REC OUT button is pressed in the main room while someone is using the system in the remote zone, the Zone 2 function will be deactivated and the source will turn off in the remote zone.
- If you select FM (or AM) with the TUNER input source buttons when the source for the remote zone (Zone 2) is set to AM (or FM), the output for the remote zone also changes to AM (or FM).
- 7.1-channel playback in the main room is disabled if the Surr Back/Zone 2 setting in the Surr Back/Zone 2 sub-menu of the Hardware Setup Menu is set to "Zone 2."
- When you are using the remote zone (Zone 2), RI system operation will not work.
- When you are using the remote zone (Zone 2), the Pure Audio setting will not work.
- **When you are not using the remote zone (Zone 2), press the OFF button to turn off the ZONE 2 indicator. (Using the remote controller, press the ZONE 2 button and then the STANDBY button.)**

## Using the remote controller

After pressing the ZONE 2 button, press the ON/STANDBY button within 5 seconds.

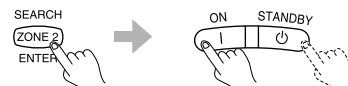

### Select an input source:

After pressing the ZONE 2 button, press an INPUT SELECTOR button within 8 seconds.

If tuner is selected with the TUN button, you can use the CH +/- button to select a preset radio station.

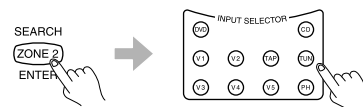

### Note:

After you press the ZONE 2 button on the remote controller, the STANDBY indicator on the TX-SR800 flashes for five seconds. During this time, you will not be able to perform operations in the main zone using the remote controller.

## Adjusting the volume for the remote zone

When the remote zone (Zone 2) speakers are connected to the SURR BACK/ZONE 2 SPEAKERS terminals, or to an amplifier connected to the SURR BACK/ZONE 2 PRE OUT terminals, adjust the volume as shown below.



### Using the remote controller:

After pressing the ZONE 2 button, the STANDBY indicator on the TX-SR800 will flash for 5 seconds. During this time press the LEVEL  $\blacktriangledown/\blacktriangle$  button.

# Recording a source

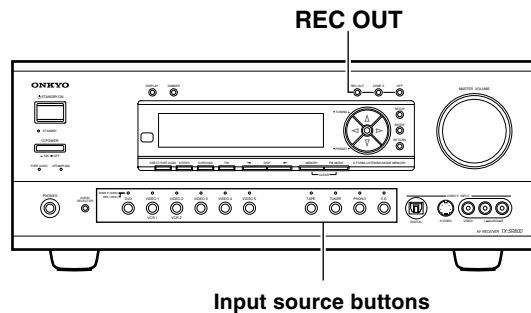

## To record the input source signal you are currently watching or listening to

This method outputs to the audio and video outputs the currently selected input source signal. This method allows you to a signal while you are actually listening to or watching it.

### 1. Select the input source to record by pressing the corresponding input source button.

The input source is now selected and you may watch or listen to it as desired.

### 2. Press the REC OUT button repeatedly until "Rec Sel:SOURCE" appears in the front display.

The signal from the currently selected input source is now output to the TAPE OUT, VIDEO 1 OUT, VIDEO 2 OUT outputs for recording.

```
RecSel #SOURCE
```

### 3. Start recording at the recording component as desired.

To confirm the settings, press the REC OUT button. The current settings will appear for 8 seconds in the front display.

#### Notes:

- If you change the input source during recording, you will record the signals from the newly selected input source.
- You cannot record the surround effects.
- Digital signals input to the DIGITAL INPUT (COAX) and DIGITAL INPUT (OPT) inputs will be output to the DIGITAL OUTPUT (OPT) output.
- Digital input signals are only output to the digital outputs and analog input signals are only output from the analog outputs. There is no conversion from digital to analog or vice versa. When connecting CD players and other digital components, do not connect only the digital terminals, but the analog ones as well.
- There are some restrictions on recording digital signals. When making digital recordings, consult the instruction manual that came with your digital recording equipment (e.g., MD recorder or DAT deck) to know what restrictions are imposed.
- You cannot record the source connected to the MULTI CHANNEL INPUT connector.
- When listening to music in the remote zone (see previous page), you can record the music or video that is being played in the main zone.
- If you select FM (or AM) with the TUNER input source button when the recording source is set to AM (or FM), the output for the recording source also changes to AM (or FM).

## To record an input source signal different from that you are currently watching or listening to

Follow the procedure given below to record an input source signal different from that which you are listening to or watching at the time of recording.

### 1. Press the REC OUT button.

### 2. Within 5 seconds, press the input source selector button of the input source signal that you wish to record.

The signal from the selected input source is now output to the TAPE OUT, VIDEO 1 OUT, and VIDEO 2 OUT outputs for recording.

```
RecSel #VIDEO3
```

### 3. Start recording at the recording component as desired.

To confirm the settings, press the Rec Out button. The current settings will appear for 8 seconds in the front display.

#### Notes:

- Be aware that the remote (Zone 2) and recording (REC OUT) outputs use the same circuit and therefore cannot be used at the same time.
- You cannot record the surround effects.
- Digital signals input to the DIGITAL INPUT (COAX) and DIGITAL INPUT (OPT) inputs will be output to the DIGITAL OUTPUT (OPT) outputs.
- There are some restrictions on recording digital signals. When making digital recordings, consult the instruction manual that came with your digital recording equipment (e.g., MD recorder or DAT deck) to know what restrictions are imposed.
- You cannot record the source connected to the MULTI CH INPUT connector.
- You cannot listen to a broadcast from one station while recording the broadcast from another.

## Recording a source

---

### Recording the video from one source and the audio from another

You can add the sound from one source to the video of another source to make your own video recordings.

Below is an example of recording the sound from a compact disc player connected to CD IN and the video from a video camera connected to VIDEO 5 INPUT to video cassette tape in a video cassette recorder connected to the VIDEO 1 OUT jack.

- 1. Press the CD input source button.**
- 2. Set “VIDEO 5” for the Video setting in the Video Setup sub-menu of the Setup menu: Input Setup → Video Setup → Video.**
- 3. Insert a CD in the CD player and insert a tape in the video camera connected to the VIDEO 5 INPUT.**
- 4. Insert a video tape for recording in the video cassette recorder connected to VIDEO 1 OUT.**
- 5. Press the REC OUT button repeatedly until “Rec Sel:SOURCE” appears in the front display.**

Now “CD” has been selected as the audio input source and “VIDEO 5” as the video input source.

- 6. Start recording on the video cassette recorder and start playing at the CD player and video camera as desired.**

#### Notes:

- If you change the input source during recording, you will record the audio signals from the newly selected input source and the video signals assigned to that input source.
- You cannot record the surround effects.

# Setup Menu

When making the various settings required to configure your TX-SR800 for optimum performance, you can either use the OSD Menu that appears on your television monitor or you can use the display on the front of the TX-SR800. The OSD Menu is a settings menu that is displayed on your TV monitor. For your reference when performing the setting procedures, this manual shows both the OSD Menu displayed on your television monitor and the display on the front of the TX-SR800.

The Setup Menu consists of the Basic Menu that is divided up into 4 menus, the Hardware Setup Menu, Speaker Setup Menu, Input Setup Menu, and Audio Adjust Menu, and the Advanced Menu that contains the menus of the Basic Menu plus the Preference Menu. These menus are then divided up into various sub-menus, and these contain settings for you to optimize your home theater as you wish.

The display shown below is an example. The actual contents of your display may differ depending on the model of your region and the selected input source.

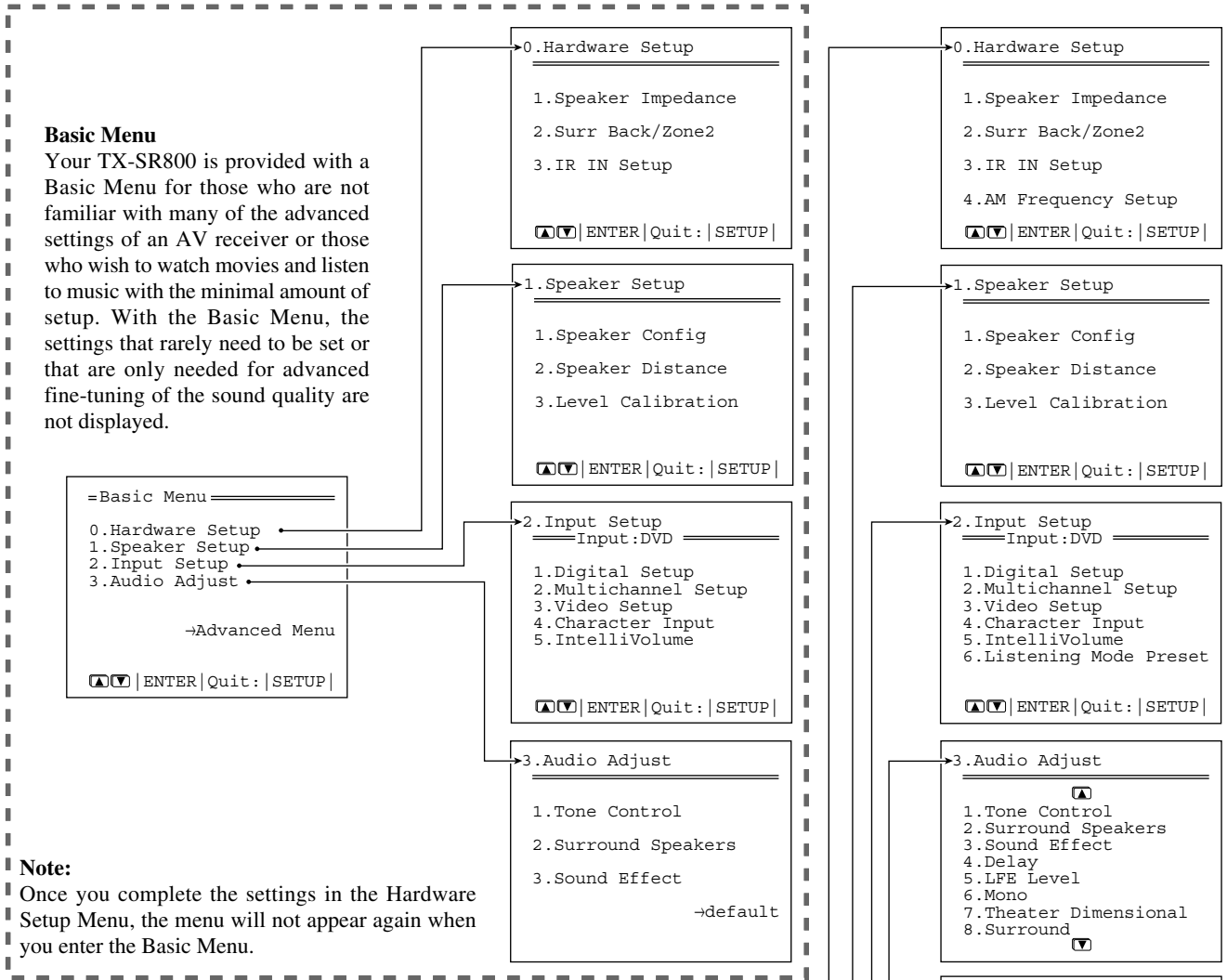

**Note:**

Once you complete the settings in the Hardware Setup Menu, the menu will not appear again when you enter the Basic Menu.

**Advanced Menu**

The Advanced Menu provides features such as the Listening Mode Presets that allow you to customize the output sound for movies and music just the way you like and the AV Sync Setup that allows you to adjust for discrepancies between the video and audio timing. Settings listed with **(Advanced)** next to their name are settings that can be set using the Advanced Menu.

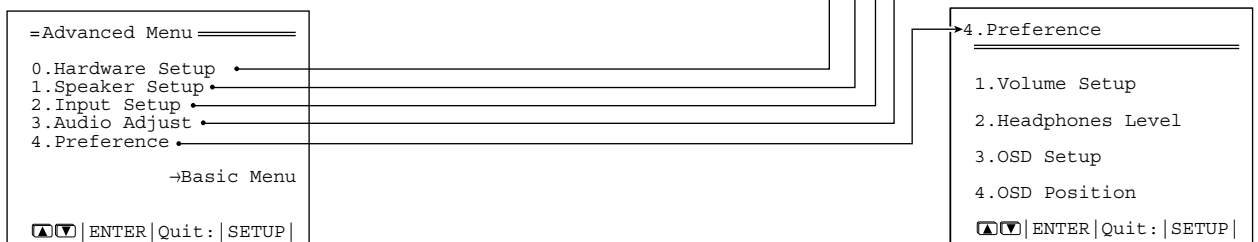



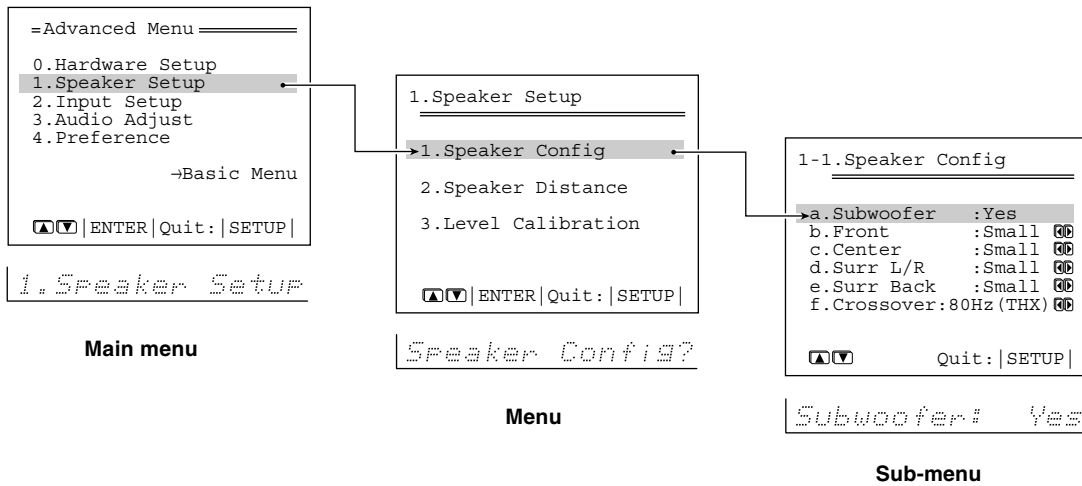









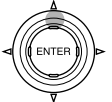

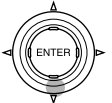
# Setup Menu

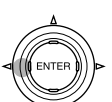

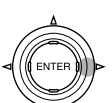
## Navigating through the Setup Menu

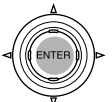
You can change settings in the Setup Menu using the buttons on the front panel and on the remote controller.

The buttons on the remote controller correspond to those on the TX-SR800 as shown below.

Button on remote controller	Button on TX-SR800
 SETUP	 SETUP
 (upper edge of ENTER button)	 UP
 (lower edge of ENTER button)	 DOWN
 (left edge of ENTER button)	 LEFT
 (right edge of ENTER button)	 RIGHT
 ENTER	 ENTER
 RETURN	 RETURN

### 1. Press the SETUP button.

The main menu (Advanced Menu or Basic Menu) appears on your television monitor.

### 2. Using the ▲ and ▼ cursor buttons, select the menu that you want to enter.

### 3. Press the ENTER button to enter the selected menu.

The screen for that menu appears.

### 4. Use the ▲ and ▼ cursor buttons to select the sub-menu that you want to enter and press the ENTER button.

Each sub-menu has different settings that can be changed as desired, and they are all explained in the pages that follow. To change a setting, first select it using the ▲ and ▼ cursor buttons, and then change the setting using the ◀ and ▶ cursor buttons.

### 5. Press the RETURN button to set the new settings and return to the previous menu screen.

Press the RETURN button again to return to the main menu.

#### Note:

Press the SETUP button to exit the Setup Menu immediately.



# Hardware Setup

## 0. Hardware Setup Menu

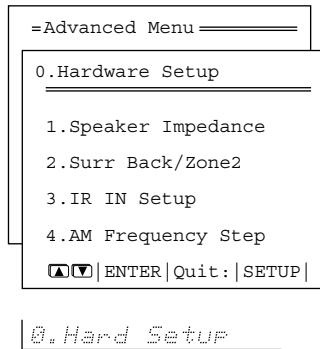

The settings within the Hardware Setup Menu will need to be made before you use your TX-SR800 for the first time. Once you have selected one of the Hardware Setup menu items, the setting will not be displayed again when you enter the Basic Menu. To change the setting at a later date, select the Advanced Menu to display the Hardware Setup Menu.

### 0-1. Speaker Impedance Sub-menu

Use this sub-menu to set the impedance level of the TX-SR800 to match the specifications of the speakers you are using. If the impedances of all speakers are between 6 and 16  $\Omega$ , select “6 ohms.” If the impedance of even one speaker is between 4 and 6  $\Omega$ , select “4 ohms.”

**Note:**

Before you change this setting, be sure to first lower the volume at the TX-SR800 to the minimum level.

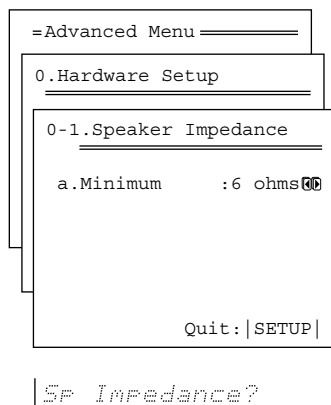

### 0-2. Surr Back/Zone 2 Sub-menu

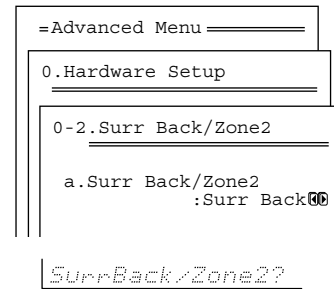

#### a. Surr Back/Zone 2

**Zone 2:** Select when connecting the speakers for the remote zone (Zone 2) to the SURR BACK/ZONE 2 PRE OUT or SURR BACK/ZONE 2 SPEAKERS terminals (for using the internal amplifier for Zone 2).

**Surr Back:** Select when connecting the speakers for the Surround back to the SURR BACK/ZONE 2 PRE OUT or SURR BACK/ZONE 2 SPEAKERS terminals (for using the internal amplifier for the surround back speakers).

**Note:**

#### The SURR BACK/ZONE 2 PRE OUT and SURR BACK/ZONE 2 SPEAKER terminals

In order to have 7.1-channel playback in the main room, you must set the Surr Back/Zone 2 setting to “Surr Back.” When set to “Surr Back,” the surround back signals are output from the SURR BACK/ZONE 2 PRE OUT and SURR BACK/ZONE 2 SPEAKER terminals. Connect the surround back speakers to the SURR BACK/ZONE 2 SPEAKER terminals or to the speakers terminals of the power amplifier connected to the SURR BACK/ZONE 2 PRE OUT terminals.

When you are not using the surround back speakers in the main room and using the internal amplifier to power the speakers for the remote zone (Zone 2), set the Surr Back/Zone 2 setting to “Zone 2.” When set to “Zone 2,” the Zone 2 signals are output from the SURR BACK/ZONE 2 PRE OUT and SURR BACK/ZONE 2 SPEAKER terminals. Connect the remote zone (Zone 2) speakers to the SURR BACK/ZONE 2 SPEAKER terminals or to the speakers terminals of the power amplifier connected to the SURR BACK/ZONE 2 PRE OUT terminals.

At this time, the main room is switched to 5.1 channel playback mode, and therefore you cannot select the THX Surround EX or DTS-ES, which requires the sound back.

# Hardware Setup

## 0-3. IR IN Setup Sub-menu

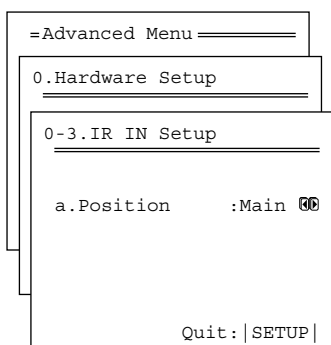

IR IN Setup?

This sub-menu allows you to set where you will be using the remote controller when you are using it in conjunction with the IR IN terminal. (i.e. remote controller signals are input at the IR IN terminal)

**Main:** Select when you have a remote sensor for the remote controller connected to the IR IN terminal in the main room.

**Zone 2:** Select to perform the remote zone (Zone 2) operations from the remote zone.

Advanced

## 0-4. AM Frequency Step Sub-menu (Worldwide model Only)

### a. Frequency Step

This sub-menu only appears on the worldwide model. The setting in this sub-menu determines the increment amount or decrement amount when adjusting the AM tuner frequency. The initial setting is 9 kHz, and this needs only to be changed if you are using the TX-SR800 in a 10-kHz region.

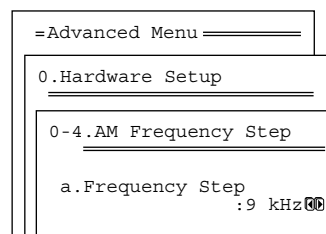

AM Freq Step?

# Speaker Setup

## 1. Speaker Setup Menu

After you have installed the TX-SR800, connected all the components, and determined the speaker layout, it is now time to perform the settings in the Speaker Setup Menu for the optimum sound acoustics for your environment and speaker layout.

Before you perform the following settings, it is important that you first determine the following items:

- The types and sizes of the speakers that are connected.
- The distance from each speaker to the normal listening position.

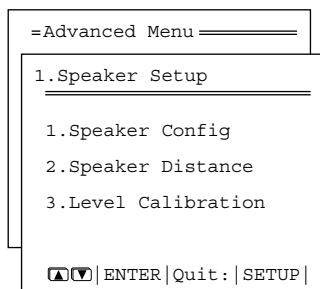

1. Speaker Setup

### Memo:

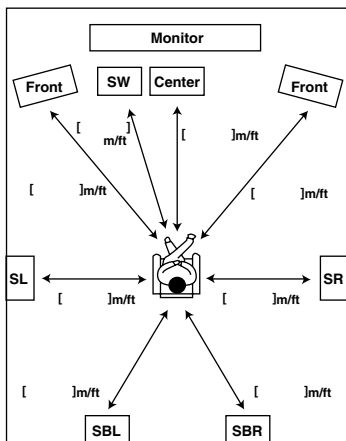

### Note:

When "Large" is set, the complete frequency range for that speaker channel will be output. When "Small" is set, the frequencies below 80 Hz for that speaker channel are output to the subwoofer. If there is no subwoofer, then they will be output to the left and right front speakers. (Set all speakers for THX speaker systems to "small.")

### 1-1. Speaker Config Sub-menu

Use this sub-menu to enter which speakers are connected and the size of each speaker.

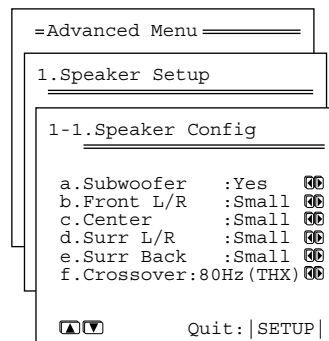

Speaker Config?

#### a. Subwoofer

**Yes:** Select when a subwoofer is connected.

**No:** Select when a subwoofer is not connected.

#### b. Front L/R

**Large:** Select if the front speakers are large sized.

**Small:** Select if the front speakers are small sized.

- If "No" is selected for the Subwoofer setting, this setting is fixed to "Large."

#### c. Center

**None:** Select if no center speaker is connected.

**Large:** Select if the center speaker is large sized.

**Small:** Select if the center speaker is small sized.

- If "Small" is selected for the Front setting, "Large" cannot be selected for this setting.

#### d. Surr L/R

**None:** Select if no surround left and right speakers are connected.

**Large:** Select if the surround left and right speakers are large sized.

**Small:** Select if the surround left and right speakers are small sized.

- If "Small" is selected for the Front setting, "Large" cannot be selected for this setting.

#### e. Surr Back

**None:** Select if no surround back left and right speakers are connected.

**Large:** Select if the surround back left and right speakers are large sized.

**Small:** Select if the surround back left and right speakers are small sized.

- If "None" is selected for the Surround L/R setting, this setting will not appear.
- If "Small" is selected for the Surround L/R setting, "Large" cannot be selected for this setting.
- If the Surr Back/Zone 2 setting in the Surr Back/Zone 2 Sub-menu of the Hardware Setup Menu is set to "Zone 2," this setting will not appear.

#### f. Crossover

This setting allows you to set the crossover frequency for your speaker system. The crossover frequency is the minimum frequency delivered to a speaker and can be set to 40 Hz, 60 Hz, 80 Hz (THX), 100 Hz, or 120 Hz. Select 80 Hz (THX) if you are using a THX-certified speaker system. This setting is valid when "Subwoofer" is set to "Yes," or for speakers that are set to "Small," at the "Speaker Config" menu. Frequencies below this are cut from speakers set to "Small" and sent to the subwoofer (or to speakers set to "Large").

# Speaker Setup

## 1-2. Speaker Distance Sub-menu

Use this sub-menu to enter the distance from each speaker to the normal listening position.

### Notes:

- Speakers that you selected “No” or “None” for in the Speaker Config Sub-menu will not appear in this sub-menu.
- The difference between the distances of different speakers cannot be set to more than 20 feet (6 meters).

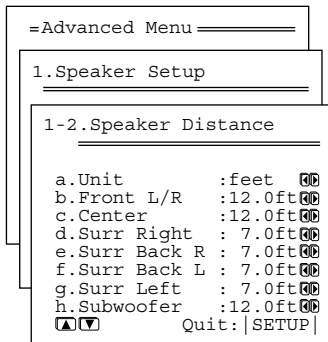

Sp Distance?

### a. Unit

**feet:** Select if you will enter the distances in feet.

**meters:** Select if you will enter the distances in meters.

### b. Front L/R

Set the distance from the front left and right speakers to your normal listening position. This can be set between 1 and 30 feet in 0.5-foot increments (between 0.3 and 9 meters in 0.15-meter increments).

### Note:

Position the front left and right speakers so that they are the same distance from the listener. If they are not, you may lose the center orientation with stereo sound.

### c. Center

Set the distance from the center speaker to your normal listening position. This can be set between 1 and 30 feet in 0.5-foot increments (between 0.3 and 9 meters in 0.15-meter increments).

### d. Surr Right

Set the distance from the surround right speaker to your normal listening position. This can be set between 1 and 30 feet in 0.5-foot increments (between 0.3 and 9 meters in 0.15-meter increments).

### e. Surr Back R

Set the distance from the surround back right speaker to your normal listening position. This can be set between 1 and 30 feet in 0.5-foot increments (between 0.3 and 9 meters in 0.15-meter increments).

### f. Surr Back L

Set the distance from the surround back left speaker to your normal listening position. This can be set between 1 and 30 feet in 0.5-foot increments (between 0.3 and 9 meters in 0.15-meter increments).

### Note:

If the Surr Back/Zone 2 setting in the Surr Back/Zone 2 Sub-menu of the Hardware Setup Menu is set to “Zone 2,” then the Surr Bk R and Surr Bk L settings will not be displayed.

### g. Surr Left

Set the distance from the surround left speaker to your normal listening position. This can be set between 1 and 30 feet in 0.5-foot increments (between 0.3 and 9 meters in 0.15-meter increments).

### h. Subwoofer

Set the distance from the subwoofer to your normal listening position. This can be set between 1 and 30 feet in 0.5-foot increments (between 0.3 and 9 meters in 0.15-meter increments).

# Speaker Setup

## 1-3. Level Calibration Sub-menu

Use this sub-menu to set the volume for each speaker so that each volume is heard by the listener at the same level. This is especially important for speaker layouts where the left and right speakers are at different distances or in asymmetrical positions due to room designs and configurations. These settings and the distance settings performed in the Speaker Distance Sub-menu are vital to create the proper sound space and dynamics.

### Note:

The speaker level settings here are not effective for multi-channel input sources. To adjust the speaker levels for multi-channel input sources, you will need to use the CH SEL, LEVEL ▲, and LEVEL ▼ buttons on the RC-510M remote controller. See page 33.

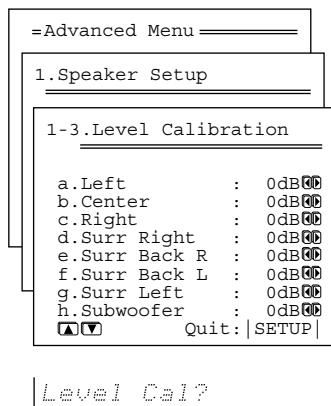

### Calibrating the speaker levels

- (1) When this sub-menu is entered, the TX-SR800 will emit a pink noise from the front left speaker. At this time, the volume of the pink noise will automatically increase to a predetermined reference level (0dB). Remember the volume level of this noise and then press the ▼ cursor button. (Note that this can be adjusted to any level between -12 and 12 decibels in 1-decibel increments.) The TX-SR800 will now emit the pink noise from the center speaker.
- (2) Using the ◀ and ▶ cursor buttons, adjust the volume level of the noise from the center speaker so that it is at the same level as that was emitted from the front left speaker. You can jog back and forth between the speakers to help you compare the volume levels.
- (3) Press the ▼ cursor button again. The TX-SR800 will now emit the pink noise from the front right speaker.
- (4) Repeat steps (2) and (3) above for the front right and other speakers until all speakers are adjusted to the same volume level.

### Notes:

- Speakers that you selected “No” or “None” for in the Speaker Config Sub-menu will not appear.
- To accurately set the output levels, it is recommended to use a handheld sound pressure level (SPL) meter. Set the meter to C-weighting and slow averaging. A Radio Shack® SPL meter or equivalent is recommended. Using the internal channel noise generators, set each channel so that you read a 75 decibel sound pressure level.

### a. Left

Sound comes from the front left speaker. Adjust the sound level between -12 and 12 decibels in 1-decibel increments.

### b. Center

Sound comes from the center speaker. Adjust the sound level between -12 and 12 decibels in 1-decibel increments.

### c. Right

Sound comes from the front right speaker. Adjust the sound level between -12 and 12 decibels in 1-decibel increments.

### d. Surr Right

Sound comes from the surround right speaker. Adjust the sound level between -12 and 12 decibels in 1-decibel increments.

### e. Surr Back R

Sound comes from the surround back right speaker. Adjust the sound level between -12 and 12 decibels in 1-decibel increments.

### f. Surr Back L

Sound comes from the surround back left speaker. Adjust the sound level between -12 and 12 decibels in 1-decibel increments.

### Note:

If the Surr Back/Zone 2 setting in the Surr Back/Zone 2 Sub-menu of the Hardware Setup Menu is set to “Zone 2,” then the Surr Bk R and Surr Bk L settings will not be displayed.

### g. Surr Left

Sound comes from the surround left speaker. Adjust the sound level between -12 and 12 decibels in 1-decibel increments.

### h. Subwoofer

Sound comes from the subwoofer. Adjust the sound level between -15 and 12 decibels in 1-decibel increments.

## Using the remote controller

### 1. Press the TEST button.

You will hear a pink noise will be emitted from the front left speaker.



- (1) Remember the volume level of this noise and then press the CH SEL button. The TX-SR800 will now emit the pink noise from the center speaker.
- (2) Using the LEVEL ▲/▼ buttons, adjust the volume level of the noise from the center speaker so that it is at the same level as that that was emitted from the front left speaker.
- (3) Press the CH SEL button again. The TX-SR800 will now emit the pink noise from the front right speaker.  
Use the LEVEL ▲/▼ buttons to adjust the volume of the noise from the front left speaker so that it is the same level as that that was emitted from the center speaker. The pink noise level can be adjusted in 1-decibel increments.
- (4) Use the CH SEL button to select other speakers and adjust the volumes until all speakers are adjusted to the same level.

### 2. Press the TEST button to complete the procedure.



# Input Setup

## 2. Input Setup Menu

This menu allows you to make the various settings concerning the signals input from the various input sources that you use with the TX-SR800. The settings made in this menu are valid for the input source that is currently selected with the input source buttons at the front panel and, therefore, these settings are made separately for each input source. Each input source may have a great number of settings that are difficult to keep track of, so we recommend making a chart to record what you have set and for which component to prevent confusion later.

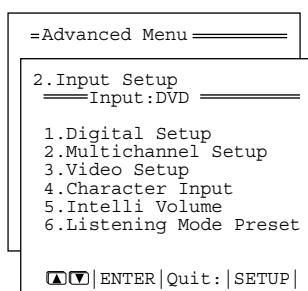

2. Input Setup

### 2-1. Digital Setup Sub-menu

This sub-menu concerns the input of digital signals from input sources and if these settings are incorrectly made, the digital audio signals may not be properly output, or not heard at all. This sub-menu will not appear if the selected input source button is AM or FM. It will also not appear if “Yes” is selected in 2-2. Multichannel Setup Sub-menu and “Multichannel” is selected in the AUDIO SELECTOR. Furthermore, since VIDEO 5 is fixed to the optical digital terminal on the front panel, this sub-menu will not appear if VIDEO 5 is selected.

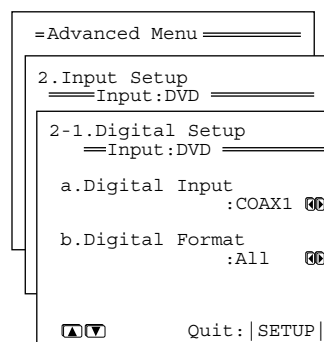

Digital Setup?

### Initial settings for each input source

Input source	Digital input
CD	OPT 1
PHONO	----
TUNER	
TAPE	OPT 2
VIDEO 1	COAX 2
VIDEO 2	COAX 3
VIDEO 3	OPT 3
VIDEO 4	----
VIDEO 5	OPTICAL on front panel (fixed)
DVD	COAX 1

---- : Available for digital input but not set in initial settings.

 : Not available for digital input.

#### a. Digital Input

This setting tells the TX-SR800 which input source button on the front panel is connected with which digital input jack on the rear panel. To perform this setting, you must first select a digital input source at the front panel and then set the name of the digital input jack it is connected to with this setting.

For example, if the input source selected at the front panel is CD and the compact disc player is connected to DIGITAL INPUT OPT 1, then select “OPT1” here. If the input source selected is not connected to a digital input, then select “----.”

**OPT1-3:** Select if the input source is connected to any of the DIGITAL INPUT OPT jacks 1 through 3.

**COAX1-3:** Select if the input source is connected to any of the DIGITAL INPUT COAX jacks 1 through 3.

----: Select if the input source is not from a digital input jack.

# Input Setup

## b. Digital Format

Sets the digital signal type to which priority is given during signal detection at the selected digital terminal.

The default setting is "All." If "----" is selected for this input source at the Digital Input setting, then this setting will not appear. Although you can use this default setting as is, you may change it as desired depending on the input signal format or if you know that you will always be listening to a certain input signal format from a particular input source.

**All:** Select for automatic detection of the input signal format. The input signal format (Dolby Digital, DTS, PCM or Analog) used by the selected input source is detected automatically to execute the required decoding process.

**DTS:** Select for DTS signal processing. The decoding process is executed only when DTS signals are input.

**PCM:** Select for PCM signal processing. The decoding process is executed only when PCM signals are input.

### Notes:

- If "All" is selected and a compact disc or LD is fast-forwarded during playback, decoded PCM signals may produce a skipping sound. In such cases, change the setting to "PCM."
- If a DTS signal is not input when "DTS" is selected, the TX-SR800 will not automatically switch to analog output even though "Auto" is selected with the AUDIO SELECTOR button.

### Notes on DTS:

- If you play a DTS-formatted CD or LD when the "PCM" setting is selected on the TX-SR800, the DTS encoded signal will not be decoded and noise will be output. This noise could damage the amplifier and speakers. Therefore, be sure to select "All" or "DTS" and use the digital input jacks (OPTICAL or COAXIAL) to connect the DTS source.
- If you play a DTS-formatted CD or LD when "All" is selected, you may hear a noise for a short while until the DTS decoder recognizes the DTS-encoded signal and starts operating. This is not a malfunction.
- If you press the PAUSE or SKIP button on the player while playing a DTS source, a short noise may be heard. This is not a malfunction. In such cases, try playing the source in the "DTS" selected.
- The DTS indicator on the TX-SR800 lights while a DTS source is played. When playback finishes and the DTS signal transmission stops, the TX-SR800 remains in DTS mode and the DTS indicator remains lit. This prevents noise when you operate the PAUSE or SKIP button on the player. Therefore, if the source is immediately switched from DTS to PCM, the PCM signal may not be played. In this case, stop the playback of the source on the player for about three seconds and then resume playback.
- You may not be able to play some DTS source signals from certain CD players and LD players even when you connect the player to the TX-SR800 digitally. This is because the digital signal has been processed (such as the output level, sampling frequency, or frequency response) and the TX-SR800 cannot recognize the signal as DTS data. Therefore you may hear noise when you play a DTS source while processing the signal.
- The outputs for the VIDEO 1 OUT, VIDEO 2 OUT, and TAPE OUT output analog audio signals. Do not record from CDs or LDs that support DTS using these outputs. If you do, the DTS-encoded signal will be recorded as noise.
- If a CD or LD encoded in the DTS format is played back with "PCM" selected, only noise will be produced. Always select "All" or "DTS" when playing back DTS-encoded sources.

## 2-2. Multichannel Setup Sub-menu

The setting in this sub-menu is normally set to "No," and only needs to be changed to "Yes" if a DVD player, MPEG decoder, or other component that has a multi channel port is connected to the MULTI CHANNEL INPUT port for 5.1-channel, 6.1-channel, or 7.1-channel audio. For example, if a DVD player is connected to the MULTI CHANNEL INPUT port, then select DVD at the front panel as the input source, bring up this sub-menu, and select "Yes" for the Multichannel setting. You can only select Multichannel with the AUDIO SELECTOR button when "Yes" is selected here.

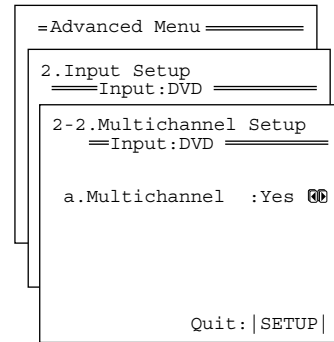

Multich Setup?

Input source selected	Multichannel
CD	No
PHONO	No
TUNER	No
TAPE	No
DVD	Yes
VIDEO 1	No
VIDEO 2	No
VIDEO 3	No
VIDEO 4	No
VIDEO 5	No

### Note:

- When playing a device connected to the MULTI CHANNEL INPUT terminal, be sure to select "Multich" with the AUDIO SELECTOR button on the front panel.
- Changing the setting to "No" during multi-channel playback forces the audio selector to "Analog."

# Input Setup

## 2-3. Video Setup Sub-menu

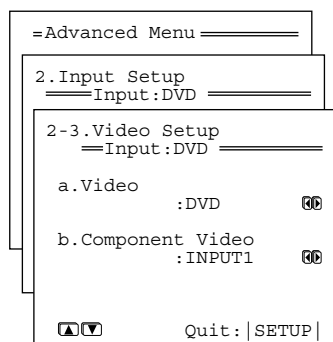

Video Setup?

### a. Video

This setting allows you to match the audio from one component with the video from another. Therefore, you can set a video source to be displayed while the audio from another input source is heard. For example, this allows you to play the music from a compact disc, while displaying the picture from a video cassette player or other video source.

The default settings are given below.

Input source selected	Video
CD	Last Valid
PHONO	Last Valid
TUNER	Last Valid
TAPE	Last Valid
DVD	DVD
VIDEO 1	VIDEO 1
VIDEO 2	VIDEO 2
VIDEO 3	VIDEO 3
VIDEO 4	VIDEO 4
VIDEO 5	VIDEO 5

**Last Valid:** Select to have the video of the previous input source continued. For example, if the selected input source is VIDEO 1, and you then change to CD (set to "Last Valid"), then the audio from the CD input is played while the video from VIDEO 1 continues.

### b. Component Video

If the video signal from a component is input to one of the COMPONENT VIDEO input banks (1 or 2), then which input source and which component video input bank must be set here.

The default settings are given below.

Input source selected	Component video input
CD	Last Valid
PHONO	Last Valid
TUNER	Last Valid
TAPE	Last Valid
DVD	INPUT 1
VIDEO 1	INPUT 2
VIDEO 2	INPUT 2
VIDEO 3	INPUT 2
VIDEO 4	INPUT 2
VIDEO 5	INPUT 2

**Last Valid (enables the source last selected):** Select to have the video of the previous input source continued.



# Input Setup

## 2-4. Character Input Sub-menu

This sub-menu allows you to give names to the stations you have preset for the AM/FM tuner, and to the input sources you have connected (excluding the tuner itself). Up to 10 characters can be entered for each name. For example, if you have a DVD connected to the VIDEO4 jack, then you can give it the name "DVD2." Or, if you have multiple VCRs connected, you can enter the model names or manufacturer names for each one so that you do not have to remember which is connected to which input source.

If you want to enter a name for a preset broadcast radio station, select the station that you want to name and enter the name.

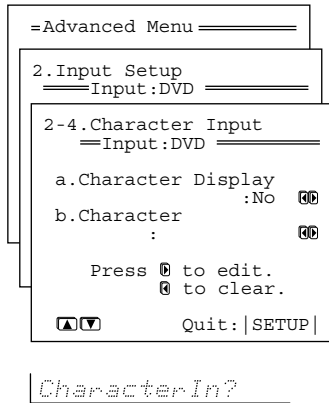

### a. Character Display

Use this setting to select whether or not to display a custom name when the current input source is selected.

**Yes:** Select to have your custom name displayed.

**No:** Select to have the default name displayed.

### b. Character

If you have selected "Yes" for the Character Display above, then here you can enter the name that you want to display. Press the ◀ cursor button to clear the current entry. Press the ▶ cursor button to bring up the Character Input screen.

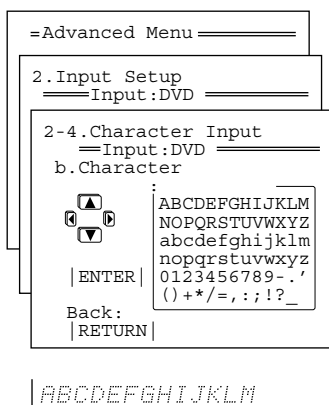

### Note:

If you are using the front display and not the OSD Menu, press the ▶ button when "Chr." appears in the front display. Then "ABCDEF.." appears. This is the Character Input screen. The cursor buttons will allow you to navigate through this screen just as they would if you were using the OSD Menu so you will need to refer to the figure below for the actual layout of the Character Input screen.

At the Character Input screen, press the cursor buttons to move the cursor to the desired character and then press the ENTER button. The characters entered will appear in order in the 10-character space field above.

Once 10 characters are entered, you will automatically return to the previous screen. If the name is completed before you enter 10 characters, enter spaces until 10 characters are entered.

To change an existing character, move the cursor backward with the RETURN button or forward with the ENTER button to the location of the mistaken character and then enter the desired character as explained above. To erase a character, enter a blank space in its place. After you have completed the name, press the ENTER button until you return to the Character Input Sub-menu.

## 2-5. Intelli Volume Sub-menu

This sub-menu allows you to adjust for the volume differences between your various input source components.

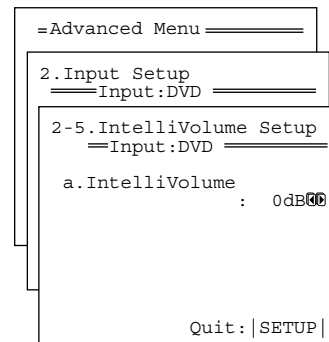

### a. Intelli Volume

When switching input sources, you may find that the output level for different components or input sources connected to the TX-SR800 is different even though the main volume setting is the same. Under normal circumstances, you would then have to change the volume setting each time you change the input source. This Intelli Volume setting allows you to preset a volume level for each input source separately so that when you do switch from one input source to another, the TX-SR800 adjusts the volume accordingly and the volume stays the same. To set the Intelli Volume, simply select an input source at the front panel, and if that source is quieter than other sources, increase its decibel level with the ▶ cursor button, or if it is louder than other sources, decrease its decibel level with the ◀ cursor button.

The Intelli Volume can be adjusted between -12 and +12 decibels.

# Input Setup

## 2-6. Listening Mode Preset Sub-menu Advanced

With the TX-SR800, you can set a different listening mode for each different signal type that comes from each input source. For example, if your DVD player also plays compact discs and the DVD video signal is Dolby Digital and the compact disc signal is PCM, then you can set a different listening mode for each.

This is especially convenient if you frequently play the same types of movies or music.

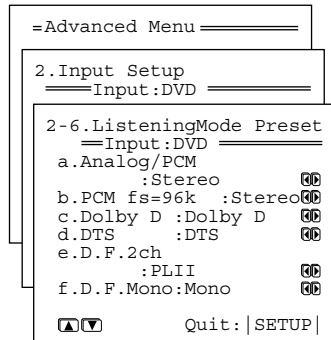

LstnModePreset?

\* The 5.1-channel digital surround format has a variety of versions including Dolby Digital and DTS. The 5.1-channel digital surround format enables the individual recording and playing of five full-range (20 Hz to 20 kHz) channels (left and right front, center, and two surround channels) plus an LFE channel (Low Frequency Effect) for the low-range effect sound. It will create a realistic sound that can be heard in the theaters and concert halls.

### Relationship between input source and listening mode

Listening modes marked with the “●” can be selected. For columns that list a number of listening modes, the display will correspond to the format of the signal from the source media.

Input source signal (display)	a. Analog/PCM (2ch)	b. PCM fs=96k (2ch)	c. Dolby D (Digital Format Multichannel)	d. DTS (Digital Format Multichannel)	e. D.F.2ch (Digital Format 2ch)	f. D.F.Mono (Digital Format Mono)
Type of software	Tape, Video tape, Vinyl, Tuner, CD, MD, DVD (Stereo), LD, Digital Satellite	DVD (96 kHz/24 bit)	DVD Digital Satellite	CD, LD DVD	DVD Digital Satellite	DVD
Listening Mode						
Mono	●				●	●
Direct/Pure Audio	●	●				
Stereo	●	●	●	●	●*	
T-D (Theater-Dimensional)	●		●	●	●	
Dolby Digital			●			
DTS				DTS DTS-ES Matrix 6.1 DTS-ES Discrete 6.1 DTS 96/24		
Dolby EX			Dolby Digital EX			
Dolby Pro Logic II DTS Neo:6	PL II Movie PL II Music DTS Neo:6 Cinema DTS Neo:6 Music	PL II Movie PL II Music			PL II Movie PL II Music DTS Neo:6 Cinema DTS Neo:6 Music	
THX	THX Cinema		THX Cinema THX Surround EX	THX Cinema	THX Cinema	
Mono Movie	●				●	●
Enhanced 7	●		●	●	●	
Orchestra	●		●	●	●	
Unplugged	●		●	●	●	
Studio-Mix	●		●	●	●	
TV Logic	●		●	●	●	
All Ch Stereo	●				●	

\* When playing sources recorded in DTS 96/24 format, “DTS 96/24 Stereo” is displayed.

#### Note:

You may not be able to select all the listening modes shown here depending on your speaker configuration or the selected input source.

# Input Setup

## Input source signals

### a. Analog/PCM

Analog sources consist of LP records, FM and AM broadcasts, cassette tapes, and the such. PCM (Pulse Code Modulation) is one form of digital audio signals and is recorded directly onto compact discs and DVDs without compression.

### b. PCM fs=96k

Digital PCM sources recorded with a sampling rate of 96 kHz.

### c. Dolby D (Dolby Digital)

Digital data with AC-3 compression and a maximum of 5.1-channel surround sound. This source signal comes from DVDs and LDs that have the  mark and therefore recorded for 5.1-channel output.

#### Dialog norm

Dialogue Normalization (Dialog Norm) is feature of Dolby Digital. When playing back software that has been encoded in Dolby Digital, sometimes you may see a brief message in the front panel display that reads Dialog Norm xdB (“x” being a numeric value). Dialogue Normalization serves to let you know if the source material has been recorded at a higher or lower level than usual. For example, if you see the message “Dialog Norm: +4” in the front panel display, to keep the overall output level constant just turn down the volume control by 4dB. In other words, the source material that you are listening to has been recorded 4dB louder than usual. If you do not see a message, then no adjustment of the volume control is necessary.

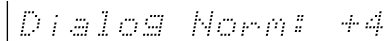

### d. DTS

DTS (Digital Theater System) is compressed digital data with a maximum 5.1-channel surround output (6.1-channel with DTS-ES Discrete sources) that allows for an extremely high-quality sound. This source signal requires a DVD player that supports DTS output and comes from DVDs, compact discs, and LDs that have the  mark.

### e. D.F. 2 ch (Digital Format 2 channel)

2-channel digital signals (not including PCM) such as Dolby Digital. DVDs or LDs recorded with 2-channel sound may be this type of input signal.

### f. D.F. Mono (Digital Format Monaural)

Monaural digital signals (not including PCM) such as Dolby Digital. DVDs or LDs recorded with monaural sound may be this type of input signal.

## Listening Modes

### Mono

This mode is for playing old movies where the sound is recorded in monaural or for playing the left and right channels of movies separately that contain different language signals. This mode also allows you to listen to the multiplexed soundtracks on DVDs, and other media that have them.

### Direct

This mode delivers pure sound with minimum sound quality adjustment and filtration. The sound recorded for the right and left front channels is output to the right and left front speakers only and not output to the subwoofer.

### Pure Audio

Same as the direct mode except that the pure audio mode also turns off the display window, turns off the power supply to the video circuitry, and minimizes the sources of noise. The result is high-fidelity music playback true to the original source.

Note that if you connect a device to the COMPONENT VIDEO INPUT 2 jacks of the TX-SR800, the relay switch doesn't activate and signals are output to the COMPONENT VIDEO OUTPUT jacks. Therefore, the display on the monitor connected to the COMPONENT VIDEO OUTPUT jacks will not disappear.

### Stereo

This mode has all input sound is output from the left and right front speakers.

The subwoofer is also used for playback.

### T-D (Theater-Dimensional)

For the best enjoyment of your home theater, it is recommended that you have front left and right speakers, a center speaker, and surround left and right speakers. However, if you only have front left and right speakers, you can enjoy multichannel audio by using this mode.

This mode controls the characteristics of the sound that reaches each ear to reproduce a multi-speaker setup. To receive the full effect, there is an optimum listening position (sweet spot). Refer to the explanation of the listening angle. In addition, if the reflective sound components are large, it may be difficult to achieve the desired result, so be sure to set up your system and listening position to minimize reflective sound.

### Dolby Pro Logic II

Opposed to Dolby Pro Logic, which had four channels (front, left, center, and surround) recorded into two channels with matrix processing and then played back in four channels, Dolby Pro Logic II uses a feedback logic circuit to have 5.1-channel surround audio (Dolby Surround, etc.) matrix-encoded into two channels and then played back in its original 5.1-channel form.

Dolby Pro Logic II provides a Movie mode designed for playing movies and a Music mode designed for listening to music. In the Movie mode, the surround channels, which used to provide monaural output over only a narrow frequency range, now provide complete stereo output over the full frequency range. The result is movie viewing with a realistic feel of movement. The Music mode uses the surround channels to provide a natural soundfield that cannot be provided with normal stereo output.

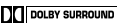
This mode can be used with VHS and DVD videos with the  mark and certain television programs. The Music mode can be used with music compact discs and other stereo sources.

# Input Setup

---

## **Dolby D (Dolby Digital)**

This mode is used for playing Dolby Digital sources.

- **Dolby Digital EX**

Enabled when playing back sources with surround tracks that were encoded using the Surround EX technology.

- **Dolby EX**

Select to achieve the same effects as Dolby Digital EX encoded sources with non-Dolby Digital sources.

## **DTS Neo:6**

This mode is for 6.1-channel playback of sources such as PCM or analog sources that have only two channels. The outputs of all six channels are a wide frequency range with a great separation between the different channels.

This mode can be set to the Cinema mode designed for playing movies and the Music mode designed for listening to music.

The Cinema mode is good for movies. The reproduced surround sound provide the same realistic feel of movement as 6.1-channel sources. This mode can be used with VHS and television programs with stereo sound.

The Music mode uses the surround channels to provide a natural sound space that cannot be provided with normal stereo output. This mode can be used with music CDs and other stereo sources.

## **DTS**

This mode is used for playing DTS source.

## **DTS-ES Discrete 6.1**

With the addition of the surround back channel, this new format has all 6.1 channels recorded independently for a completely discrete digital format. Since all channels are recorded independently, high-fidelity surround playback with the increased feeling of a separated sound space is achieved.

## **DTS-ES Matrix 6.1**

This format has the surround back channel matrix encoded and inserted into the left and right surround channels so that at playback the output for the left, right, and back surround channels are decoded using a high-precision matrix decoder.

## **DTS 96/24**

Automatically changes to this mode when playing back sources with surround tracks that were encoded using the DTS 96/24 technology.

## **THX**

This mode is for playing back sources recorded in the THX format. For the utmost in fidelity when playing back THX sources, it is also recommended to use a THX-certified speaker system.

- **THX Cinema**

This is the conventional 5.1-channel THX format. This mode should be used only when playing back sources that were mixed for playback in large movie theater environments.

- **THX Surround EX**

“THX Surround EX - Dolby Digital Surround EX” is a joint development of Dolby Laboratories and the THX division of THX Ltd.

In a movie theater, film soundtracks that have been encoded with Dolby Digital Surround EX technology are able to reproduce an extra channel which has been added during the mixing of the program. This channel, called Surround Back, places sounds behind the listener in addition to the currently available front left, front center, front right, surround right, surround left, and subwoofer channels.

This additional channel provides the opportunity for more detailed imaging behind the listener and brings more depth, spacious ambience, and sound localization than ever before.

When released to the home consumer market, movies that were created using the Dolby Digital Surround EX technology, may have a note to that effect on the packaging. A list of movies created using this technology can be found on the Dolby web site at <http://www.dolby.com>.

The TX-SR800 can play the 5.1-channel sources in THX surround EX mode, even if the source is not encoded in Dolby Digital Surround EX format. In this case, the sound actually output from the surround back channels depends on the source and may not fit your tastes.

## **Mono Movie**

This mode is suitable for playing back monaural recording such as old movie soundtracks. The center channel delivers the unprocessed original sound, whereas the other channels deliver the center-channel sound processed with the appropriate reverberation. This allows you to enjoy monaural sound with the atmosphere of a movie theater.

## **Enhanced 7**

This mode reproduces a natural surround environment by using seven speaker channels. The sound effects moving smoothly toward the surround back. This mode is good for music and TV sports programs.

## **Orchestra**

This mode is appropriate for classical and opera music. The center channel is cut and the surround channels are emphasized to widen the stereo image. It will simulate the natural reverberation that is created in large halls.

## **Unplugged**

This mode is suitable for acoustical instrumental sounds, vocals, and jazz music. By emphasizing the front stereo image, it will simulate the acoustics that you would experience in front of the stage.

## **Studio-Mix**

This mode is for rock and popular music. The lively sounds are enhanced for a powerful acoustic image that simulates the feeling of being in a club or rock concert.

## **TV Logic**

This mode gives realistic acoustics to TV programs that are aired from TV studios. It enhances the entire surround sound and clarity of the conversation.

## **All Ch Stereo**

This mode is designed for playing background music. The front, surround, and surround back channels create a stereo image that encompasses the entire area.

# Audio Adjust

## 3. Audio Adjust Setup Menu

Set the various parameters for the sound signals.

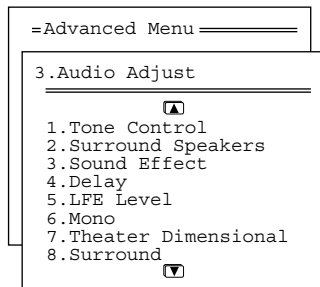

3.Audio Adjust

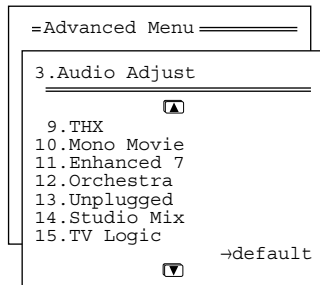

3.Audio Adjust

### 3-1. Tone Control Sub-menu

Separately adjust the bass and treble settings in two steps.

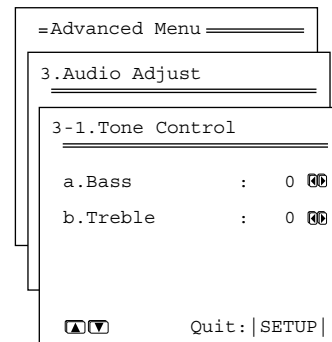

Tone Control?

Setting	Values	Initial value
a. Bass	-12 to +12	0
b. Treble	-12 to +12	0

### 3-2. Surround Speakers Sub-menu

This sub-menu allows you to decide which speakers to output to when you are playing back a 5.1-channel source with surround back speakers connected.

Setting	Values	Initial value
a. Surround Speakers	Surround L/R, Surround Back, Surr L/R + Back	Surround L/R

**Surround L/R:** Select to output the sound to the surround left and right speakers as normal and outputs nothing to the surround back speaker.

**Surround Back:** Select to output the sound to the surround back speakers and outputs nothing to the surround left and right speakers.

**Surr L/R+Back:** Select to output the sound to both the surround left and right speakers and the surround back speaker.

## Audio Adjust

### 3-3. Sound Effect Sub-menu

This sub-menu is used to turn on and off the various sound effects available with the TX-SR800.

Setting	Values	Initial value
a. Re-EQ	On, Off	Off
b. Upsampling	On, Off	Off
c. Subwoofer (Analog/PCM)	On, Off	On
d. Late Night	Off, Low, High	Off

#### a. Re-EQ

Re-EQ (re-equalization) takes the edginess or “brightness” out of your home cinema sound to compensate for the fact that sound mixed for theaters may sound too bright when played back through speakers in the home environment.

This can be set to either “On” or “Off.”

#### b. Upsampling

Upsampling processes the input digital signal, or the digital signal converted from an analog input source, and converts its digital sampling frequency to twice its current frequency for an even further detailed sound reproduction. This can be set to either “On” or “Off.” When “On” is selected, the UPSAMPLING indicator lights.

#### c. Subwoofer

When “Yes” is selected for the Subwoofer setting in the Speaker Config Sub-menu, set this to “Off” if you do not want to have sound output from the subwoofer when listening to Analog/PCM sources. If “No” is selected for the Subwoofer setting in the Speaker Config Sub-menu, this setting will not appear.

#### d. Late Night

The audio for movies made for the cinema have a large dynamic range; thus, the difference between loud noises and soft noises is great. To hear the quieter sounds such as background noises or human conversations, the movie must be played back at larger volumes. When this setting is set to “High” or “Low,” the dynamic range of the sound is narrowed down to allow you to easily hear minute sounds at low volumes. This function is especially useful if you wish to play a movie at low volumes during the nighttime.

This can be set to either “Off” or “Low,” or “High.”

#### Notes:

- The Late Night function is effective only on Dolby Digital encoded software.
- The depth of the Late Night effect is determined by Dolby Digital software. With some sources, it may produce little or no effect.

### Advanced

### 3-4. Delay Sub-menu

This sub-menu gives you various ways to adjust the timing of the audio output from the speakers to give certain soundfield effects or to adjust for unwanted asynchronous video and audio tracks.

This sub-menu does not appear if “Direct” is selected as the listening mode.

Setting	Values	Initial value
a. A/V Sync	0.0 ms to 74.0 ms	0.0 ms
Relative Delay		
b. Center	-4.0 ms to +6.0 ms	0.0 ms
c. Surr L/R	-4.0 ms to +6.0 ms	0.0 ms
d. Surr Back	-4.0 ms to +6.0 ms	0.0 ms

#### a. A/V Sync

If a digital signal processor is connected, there may be times when the audio and video from a DVD or LD player is not output in perfect sync. The result is where the sound and picture do not match and the sound is heard too early. In such a case, use this setting to properly synchronize the audio and video. This setting can be set between 0 and 74.0 ms in 0.5-ms increments. Under normal circumstances, this can left at 0 ms. If set between 24.5 and 74.0 ms, upsampling is fixed to 24.0 ms. Note that a change in the setting will not be displayed. This setting will not appear if the selected input source is set for the multichannel port.

#### Relative Delay

##### b. Center, c. Surr L/R, d. Surr Back

Besides level and delay adjustments, this setting provides the ability to change or adjust the relative speaker position to fine tune the soundfield for the listener. This is accomplished using Onkyo’s unique Enhanced Spatial Positioning Algorithm. This adjustment provides 10 milliseconds of delay for the speakers, which is equivalent to moving the speaker 10 feet (3 meters) away. This adjustment is set up to provide -4.0 or +6.0 milliseconds (-4 or +6 feet/-1.2 or +1.8 meters) of adjustment to the listener’s position.

Once the coarse adjustments (i.e., speaker level and distance adjustments) are made, the system is set up to provide a typical or broad surround environment. By adjusting the relative position of the speakers, we are able to alter the soundfield to be more spread out (deeper) or focused (shallower).

#### Note:

Surr Back will not appear if the Surr Back/Zone 2 setting in the Surr Back/Zone 2 Sub-menu of the Hardware Setup Menu is set to “Zone 2.”

**Advanced****3-5. LFE Level Sub-menu**

This sub-menu is for setting the LFE (Low Frequency Effect) levels included in Dolby Digital and DTS software.

Setting	Values	Initial value
a. Dolby Digital	$-\infty$ , -10 dB to 0 dB	0 dB
b. DTS	$-\infty$ , -10 dB to 0 dB	0 dB

**a. Dolby Digital**

The level can be adjusted to either  $-\infty$  or between -10 and 0 decibels in 1-decibel increments. For Dolby Digital input source signals, the LFE level set here is used. A setting of 0 decibels is recommended for optimum performance; however, if the source is recorded with the low frequency range too strong, lower this setting as necessary.

**b. DTS**

The level can be adjusted to either  $-\infty$  or between -10 and 0 decibels in 1-decibel increments. For DTS input source signals, the LFE level set here is used. A setting of 0 decibels is recommended for optimum performance; however, if the source is recorded with the low frequency range too strong, lower this setting as necessary.

**Advanced****3-6. Mono Sub-menu**

The settings of this sub-menu shown below are enabled when the listening mode is set to "Mono."

Setting	Values	Initial value
a. Academy Filter	On, Off	Off
b. Input Channel	Auto L+R, Left, Right	Auto L+R

**a. Academy Filter**

Older monaural film mixes relied on high-frequency rolloff in presentation to sound properly balanced, so that excessive hiss from the grain structure of the film would not be heard. The high-frequency loss was typically due to a combination of optical slit loss, electrical filters, loudspeaker response, and screen loss. Some films have been transferred to video without such a high-frequency rolloff, and thus sound overly bright and hissy.

The TX-SR800 includes this "Academy filter," which is based on contemporary playback practices for such films over wide-range systems.

This can be set to either "On" or "Off."

**b. Input Channel**

This allows you to set which input channel to use for monaural sound.

**Auto L+R:** Select this under normal circumstances. When the input source is center channel, this center channel is used as the monaural sound input channel. Otherwise, the left and right channels are mixed and the mixed signal is used as the monaural sound input channel.

**Left/Right:** You will need to select either left or right when playing a video source that contains bilingual data. In such a case, the left and right channels will contain the audio for different languages. Select the channel with the language you desire.

**Advanced****3-7. Theater Dimensional Sub-menu**

Select this to modify the Theater-Dimensional (T-D) listening modes. The settings available are shown in the table below.

Setting	Values	Initial value
a. Listening Angle	20°, 40°	40°
b. Center	On, Off	Off
c. Front Expander	On, Off	Off
d. Virtual Surr Level	-3 dB to +3 dB	0 dB
e. Dialog Enhance	On, Off	Off

**a. Listening angle**

The listening angle is the angle subtended by the front left and right speakers as seen from the listener. The processing for the virtual surround will be based on this angle. The setting of 20 and 40 degrees are only for nominal purposes, so select the setting that is closest to your actual listening angle.

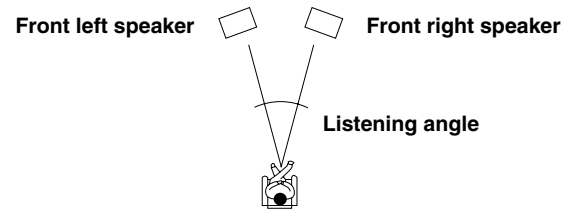
**b. Center**

In the Theater-Dimensional mode, if the speaker system has a center speaker, the center channel signal can be output from the center speaker. For instance, in systems where the front left and right speakers are small, use of the center speaker may provide a better sound space and reduce the load on the front speaker. (For the proper soundfield, it is important that the speaker levels and speaker distances among the front right, front left, and center speakers are matched. In order to ensure this, make sure that the settings in the Speaker Distance Sub-menu and Level Calibration sub-menu are set correctly.)

**On:** Select to have the center channel signal output to the center speaker.

**Off:** Select to have the center channel signal output to the front left and right speakers (Phantom Center).

**c. Front Expander**

The front expander function spreads out the stereo image in front of the listener. The created stereo image is as if the front speakers have been farther apart for the feeling of a wide sound space. This is especially useful for narrow listening angles of 20 degrees or less.

**On:** Select to turn on the front expander function to simulate a wider sound space.

**Off:** Select to turn off the front expander function for a normal sound space.

**d. Virtual Surr Level**

This setting adjusts the level of the virtual surround signal. This can be set from -3 to +3 decibels. Lowering this setting can improve the sound when the definition is unclear or when the sound feels unnatural.

**e. Dialog Enhance**

If the dialog from the center channel is difficult to hear in the Theater-Dimensional mode, use this setting to improve the clarity.

**On:** Select to enhance the vocal ranges of the center channel signal.

**Off:** Select to output the center channel signal at the regular level and frequency characteristics.

## Advanced

### 3-8. Surround Sub-menu

This sub-menu provides various settings for modifying the plain Dolby Digital, DTS, and Pro Logic II Surround listening modes. The settings that can be set are shown in the table below.

Setting	Values	Initial value
a. Surr Mode (Analog/PCM)	Pro Logic II Movie Pro Logic II Music Neo:6 Cinema Neo:6 Music	Pro Logic II Movie
b. Surr Mode (D.F.2ch)	Pro Logic II Movie Pro Logic II Music Neo:6 Cinema Neo:6 Music	Pro Logic II Movie
c. Dolby D EX (Dolby D)	Auto, On, off	On
d. DTS-ES	Auto, On, Off	Auto
<Pro Logic II Music>		
e. Panorama	Off, On	Off
f. Dimension	0, 1, 2, 3, 4, 5, 6	3
g. Center Width	0, 1, 2, 3, 4, 5, 6, 7	3
<Neo: 6 Music>		
h. Center Image	0, 1, 2, 3, 4, 5	3

#### a. Surr Mode (Analog/PCM)

Changes the surround mode for when 2-channel analog/PCM signals are input.

#### b. Surr Mode (D.F.2ch)

Changes the surround mode for when 2-channel digital signals are input.

#### c. Dolby Digital EX (Dolby D)

If you have surround back speakers connected, use this setting to select whether or not you will use Dolby EX playback.

**Auto:** When the source has an EX flag (ID signal for Surround EX), the playback is automatically changed to Dolby Digital EX. If the source has no EX flag, the playback is changed to Dolby Digital.

**On:** The playback is set to Dolby Digital EX.

**Off:** The playback is set to normal Dolby Digital.

If your surround channel is monaural or you do not have a surround channel, then the playback will be normal Dolby Digital regardless of the above setting.

You can change the Dolby Digital EX mode settings easily using the remote controller. While playing a Dolby Digital source, after selecting Dolby D for listening mode, each press of the SURROUND button on the remote controller cyclically changes the Dolby Digital EX mode in the order of "Auto," "On," and "Off."

#### d. DTS-ES

This setting selects the DTS-ES mode.

**Auto:** Select to have the listening mode change automatically to DTS-ES Discrete 6.1 or DTS-ES Matrix 6.1. If the DTS source has no DTS-ES flag, the mode is changed to DTS 5.1 when the DTS source has the DTS-ES flag (ID signal for DTS-ES).

**On:** Select to have the listening mode change automatically to DTS-ES Discrete 6.1 or DTS-ES Matrix 6.1 when the DTS source has the DTS-ES flag, and to DTS-ES Matrix 6.1 when the DTS source has no DTS-ES flag.

**Off:** Select to not use DTS-ES listening modes even when the DTS source has the DTS-ES flag. With this setting, the DTS sources are always played in DTS 5.1 mode.

#### e. Pro Logic II Music Panorama

Use this setting to extend the front stereo image to include the surround speakers for an exciting wraparound effect with side wall imaging.

**On:** Select to turn on the PL II Music Panorama mode.

**Off:** Select to turn off the PL II Music Panorama mode.

#### f. Pro Logic II Music Dimension

Use this setting to gradually adjust the soundfield forward or backward.

The setting of "3" is the normal position. Change the setting to "2" or lower to move the sound space forward and setting to "4" or higher to move the sound space backward.

If the stereo recording has excessive broadness or too strong surroundness, move the sound space forward to get the appropriate sound balance. In contrast, if the stereo recording is somewhat felt like monaural or has narrowness, move the sound space backward to get more surroundness.

#### g. Pro Logic II Music Center Width

In Pro Logic II decoding, center signals are output from the center speaker. When the center speaker is not used, the decoder will divide the center signal equally to both the front left and right speakers to create a "phantom" center sound image.

The Pro Logic II Music Center Width mode allows you to adjust from where the center sound image is heard. Using this, you can have the soundfield be heard from the center speaker only, from the front left and right speakers only (as a phantom center sound image), or from all three speakers (center, front left and right) in various level combinations. For home use, applying some width to the center signal will improve the level balance for the center and main speakers, and effect the width of the center sound image, or "weight" of the sound. Many sound recordings processed for stereo playback will be reproduced better by proper control of this setting. The recommended setting for Pro Logic II Music mode is "3." This allows you to easily distinguish the Pro Logic II Music mode from the Pro Logic II Movie mode whose setting is automatically set to "0."

#### h. Center Image

DTS Neo:6 derives a center channel from two-channel PCM and analog sources.

In cinema mode, for Lt/Rt film soundtracks, sounds steered to the center are subtracted from the left and right channels.

In music mode, the intent in the front channels is less one of steering and more one of stabilizing the front image by augmenting it with a center channel, while preserving the original perspective of the stereo mix. Therefore the derived center is never fully subtracted from the left and right channels.

Center Image is the factor controlling the amount of subtraction. It varies between 0 and 5 in steps of 1 and the default value is 3.

When Center Image=5, the factor is zero and nothing is subtracted from the left and right channels. When Center Image=0, the center channel is subtracted from the left and right channels at half level (-6 dB) for each channel. The signal level sent to the center channel output is not affected by Center Image.

This control should be set based on room layout and personal preferences. A setting of 5 allows the left and right channels to pass through unaltered from the stereo mix. A setting of 0 gives more center channel dominance, which is particularly desirable if listeners are located well off-center. At any setting, the center speaker anchors the image.

Center Image is only enabled when the listening mode is DTS Neo:6 Music.



# Audio Adjust

Advanced

## 3-9. THX Sub-menu

This sub-menu allows you to set the settings that will be enabled when the THX listening mode is selected. The settings available are shown in the table below.

Setting	Values	Initial value
a. Re-EQ (THX)	Off, On	On
b. Decoder (2 ch)	PL II Movie Neo:6 Cinema	PL II Movie
c. THX Surr EX (Dolby D)	Auto, Off, On	On
d. DTS-ES	Auto, Off, On	Auto

### a. Re-EQ (THX)

Re-EQ (re-equalization) takes the edginess or “brightness” out of your home cinema sound to compensate for the fact that sound mixed for theaters may sound too bright when played back through speakers in the home environment.

This can be set to either “On” or “Off”.

### b. Decoder (2 ch)

This setting allows you to select the decoding mode for THX processing.

**PL II:** Select for Dolby Pro Logic II Movie.

**Neo:6:** Select for DTS Neo:6 Cinema.

### c. THX Surr EX (Dolby D)

This setting allows you to set whether or not Dolby Digital sources will be played back using THX Surround EX when a surround back speaker is connected.

**Auto:** Select to automatically output sources with EX-identifying signals using THX Surround EX.

**On:** Select to output using THX Surround EX regardless of whether or not the source contains EX identifiers.

**Off:** Select not to output using THX Surround EX regardless of whether or not the source contains EX identifiers (Dolby D is used).

### Note:

THX Surr EX (Dolby D) will not appear if the Surr Back/Zone 2 setting in the Surr Back/Zone 2 Sub-menu of the Hardware Setup Menu is set to “Zone 2” and the Surr Back setting in the Speaker Config Sub-menu of Speaker Setup menu is set to “None.”

### d. DTS-ES

This setting selects the DTS-ES mode.

**Auto:** Select to have the listening mode change automatically to DTS-ES Discrete 6.1 or DTS-ES Matrix 6.1. If the DTS source has no DTS-ES flag, the mode is changed to DTS 5.1.

**On:** Select to have the listening mode change automatically to DTS-ES Discrete 6.1 or DTS-ES Matrix 6.1 when the DTS source has the DTS-ES flag, and to DTS-ES Matrix 6.1 when the DTS source has no DTS-ES flag.

**Off:** Select to not use DTS-ES listening modes even when the DTS source has the DTS-ES flag. With this setting, the DTS sources are always played in DTS 5.1 mode.

Advanced

## 3-10. 3-11. 3-12. 3-13. 3-14. 3-15.

### Mono Movie/Enhanced 7/Orchestra/Unplugged/Studio Mix /TV Logic Sub-menu

The settings of these sub-menus become effective when any of the Mono Movie, Enhanced 7, Orchestra, Unplugged, Studio-Mix, or TV Logic listening modes are selected. When one of the listening modes is selected, the settings in the sub-menu of that listening mode become enabled.

Setting	Values	Initial value
a. Front Effect	Off, On	On
b. Reverb Level	Low, Mid, High	Mid
c. Reverb Time	Short, Mid, Long	Mid

### a. Front Effect

Some live recordings contain acoustic reverberation. When you play these sources, more reverberation will be applied by the DSP, creating too much reverb effects and the sound loses frame or presence. In this case, set this setting to “Off” so that no reverberation from the DSP will be applied to the sound output from the three front channels. With this setting, the sound source is played as it is without any further reverberation.

### b. Reverb Level

This setting allows you to adjust the depth of acoustic reverberation to match the playback source material, the acoustics of your room, and such other factors.

Select from the three settings “Low,” “Mid,” and “High.”

### c. Reverb Time

Adjust the reverb time to match the source being played back and the acoustics of the room. Select from the three settings “Short,” “Mid,” and “Long.”

# Audio Adjust

## Settings possible for each listening mode (3-1, 3-2, 3-3, Sub-menu)

Setting Listening mode	3-1. Tone Control	3-2. Surround Speakers	3-3. Sound Effect			
	a. Bass b. Treble	a. Surround Speakers	a. Re-EQ	b. Upsampling* <sup>2</sup>	c. Subwoofer* <sup>2</sup>	d. Late Night* <sup>3</sup>
Mono	●		●		●	●
Direct/Pure Audio						
Stereo	●		●	●	●	●
Theater-Dimensional	●				●	●
Dolby EX	●		●			●
DTS	●	●	●			
DTS-ES Matrix 6.1	●		●			
DTS-ES Discrete 6.1	●		●			
DTS 96/24	●	●	●			
Dolby Digital	●	●	●			●
Dolby Pro Logic II	●	●	● <sup>*1</sup>	●	●	●
DTS-ES Neo:6	●		● <sup>*1</sup>		●	
THX Cinema (PLII)		●	●		●	●
THX Cinema (Neo:6)			●		●	
THX Surround EX			●			
DTS-ES THX Cinema			●			
Mono Movie	●	●			●	●
Enhanced 7	●				●	●
Orchestra	●	●			●	●
Unplugged	●	●			●	●
Studio-Mix	●	●			●	●
TV Logic	●	●			●	●
All CH Stereo	●		●		●	●

\*1 Enabled for Dolby Pro Logic II Movie and DTS Neo:6 Cinema input sources.

\*2 Takes effect when playing an analog/PCM source in any of the listening modes marked with “●.”

\*3 Takes effect when playing a Dolby Digital source in any of the listening modes marked with “●.”

# Preference

## 4. Preference Menu Advanced

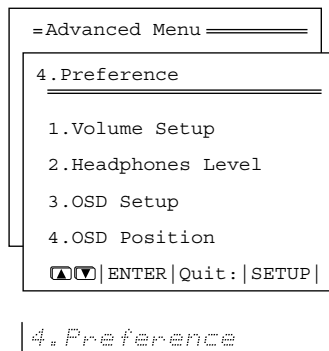

## 4-1. Volume Setup Sub-menu Advanced

This sub-menu allows you to make various settings concerning the volume control of the TX-SR800.

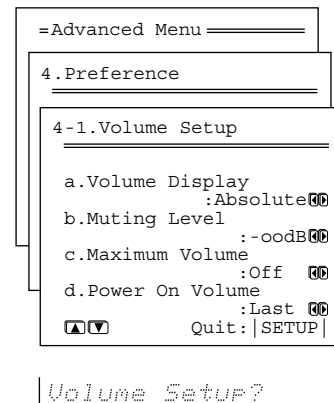

### a. Volume Display

You can choose from two ways of displaying the volume setting on screen.

**Absolute:** This displays the volume with a minimum of 0 for no sound and a maximum of 100. As a reference, the volume setting of Ref (82) is equivalent to 0 decibels for the relative display method.

**Relative:** This displays the volume as a decibel value on a scale with a designated reference point that is displayed as 0, which equals the volume setting of 82 of the absolute display method. With this display method, the minimum value is  $-\infty$ , the next highest is  $-81$ , and the maximum value is  $+18$ .

### b. Muting Level

This sets the attenuation level during playback when the MUTING button is pressed on the remote controller. This can be set to  $-\infty$ , or between  $-50$  and  $-10$  decibels in 10-decibel increments.

### c. Maximum Volume

This setting allows you to set the maximum volume that can be output with the MASTER VOLUME dial. Setting a maximum volume allows you to prevent components from being damaged by excessively loud volumes. For the absolute volume display method, this can be set between 50 and 99. For the relative volume display method, this can be set between  $-32$  and  $+17$  decibels. To not set a maximum volume, select “Off.”

### d. Power On Volume

This sets a designated volume for which the TX-SR800 will be set to every time that the power is turned on. This prevents the TX-SR800 from suddenly outputting very loud sounds if it is turned on while it is set to an extremely high volume. For the absolute volume display method, this can be set between 0–100. For the relative volume display method, this can be set between  $-\infty$ ,  $-81$  and  $+18$  decibels. To have the TX-SR800 turned on with its current volume setting, set this to “Last.”

# Preference

## 4-2. Headphones Level Sub-menu

**Advanced**

If you notice a large difference in the volume when listening to the headphones from when listening to the speakers, you can change the headphone volume level so that you do not have to make adjustments with the main volume dial each time you put on the headphones. The headphone volume can be adjusted between -12 and +12 decibels.

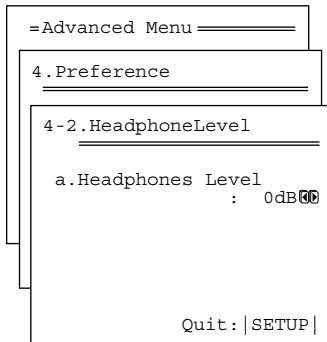

Headphones Lvl?

## 4-3. OSD Setup Sub-menu

**Advanced**

This sub-menu allows you to customize the OSD Setup Menu to display in the manner you desire.

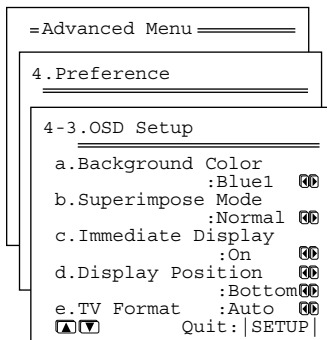

OSD Setup?

### a. Background Color

Select either Blue1, Blue2, Green1, Green2, Magenta, Red1, or Red2 as the background color when the OSD Setup Menu is displayed.

### b. Superimpose Mode

**Off:** Select to have the OSD Setup Menu displayed on the selected background color.

### Hint:

If this is set to “Off,” the background color will not be displayed even when there is no video signal input.

**Normal:** Select to have the OSD Setup Menu superimposed over the current video if one is displayed or on the selected background color if there is no video signal.

**Black:** Select to have the OSD Setup Menu displayed on a black background at all times.

### c. Immediate Display

**On:** Select to have the screen immediately display certain operations as you perform them (e.g., having the input source displayed whenever an input source selector button is pressed). The display will remain for five seconds after the operation is completed.

**Off:** Select to turn off the immediate display of operations.



### d. Display Position

Use this setting to select the position of the immediate display that appears when certain operations are performed. You can position the immediate display at any of ten different levels ranging from the top all the way to the bottom.

### e. TV Format

**(For all models other than USA and Canadian models)**

The default setting is “Auto,” which means that the television format is detected and automatically set by the TX-SR800. However, if you know the correct format, you can use this setting to choose either PAL or NTSC so that no time is wasted on detection.

## 4-4. OSD Position Sub-menu

**Advanced**

This sub-menu allows you to adjust the position of the OSD Setup Menu as it is displayed on your screen. Depending on the monitor used, there may be cases where the OSD Setup Menu is not displayed in the center and parts of the menus are cut off. To adjust the position of the OSD Setup Menu, simply press the cursor buttons to inch the menu to position you desire.

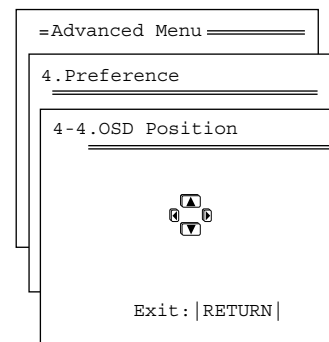

OSD Position?

# Using remote controller

## Overview

The RC-510M remote controller is a useful tool that can not only operate the TX-SR800, but also all the other components of your home theater as well. To operate any component, first press the Mode button on the remote controller that corresponds to the component that you wish to control. Then simply press the desired operation button and the component will operate accordingly.

To operate a satellite tuner, cable, VCR, or television with the remote controller, first program the signal to the button.

There are two methods. One method is selecting the name of a different brand from the table, entering the setting number listed, and calling up the pre-programming code (see page 65). The other method is sending the commands from the other brand's remote control directly into this remote controller (see page 69).

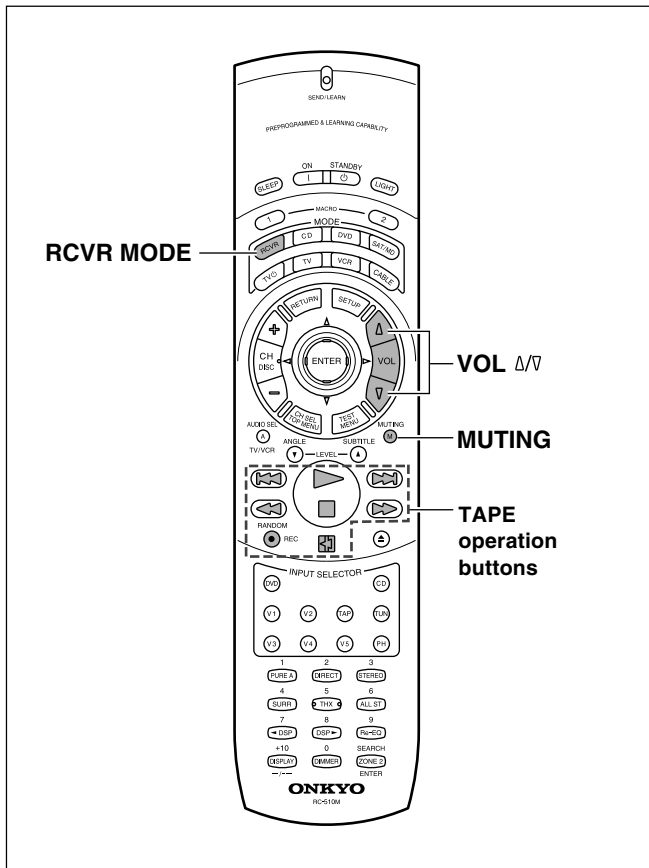

## Controlling an Onkyo cassette tape deck

The **RI** connector of the Onkyo cassette tape deck must be connected to the TX-SR800 (see page 26).

### 1. Press the RCVR MODE button.

The RCVR MODE button lights.

### 2. Press the desired operation button.

The buttons shaded in the figure to the left are the operation buttons that can be used to control an Onkyo cassette tape deck.

#### Operation buttons:

- ▷: Play
- ◻: Stop
- ◀: Rewind
- ▶: Fast forward
- ⏮: Skips to beginning of next track during playback
- ⏪: Skips to beginning of current track during playback
- REC ●**: Record/Pause
- ⏮: Reverse playback

You may also use the following buttons:

**VOL Δ/∇**: Adjusts volume at TX-SR800

**MUTING**: Activates muting function at TX-SR800

#### Note:

Even for devices with the ⏮ and ⏭ buttons, signal discrepancies may cause them not to work properly.

## Controlling an Onkyo DVD player

The **RF** connector of the Onkyo DVD player must be connected to the TX-SR800 (see page 26).

### 1. Press the DVD MODE button.

The DVD MODE button lights.

### 2. Press the desired operation button.

The buttons shaded in the figure to the left are the operation buttons that can be used to control an Onkyo DVD player.

#### Operation buttons:

**ON:** Turns DVD player on and off

**STANDBY:** Turns DVD player off (Some sets may not respond to this button. In this case, use the ON button to put the DVD player in the standby state.)

**SETUP:** Displays the OSD of the DVD player

$\Delta/\nabla/\leftarrow/\rightarrow$ : Moves cursor in the OSD Menu of the DVD player

**ENTER:** Enter button for the OSD Menu of the DVD player

**RETURN:** Return button for the OSD Menu of the DVD player

**TOP MENU or MENU:** Displays menu screens recorded on DVD media

**DISC  $\leftrightarrow$ :** Selects disc in DVD changer

**AUDIO SEL:** Selects audio or language track (if recorded on the DVD)

**ANGLE:** Selects a camera angle (if recorded on the DVD)

**SUBTITLE:** Selects subtitle language (if recorded on the DVD)

**SEARCH:** Searches for location on disc to start playback

**RANDOM:** Random playback

$\leftarrow$ : Chapter/Track down

$\rightarrow$ : Chapter/Track up

$\triangleright$ : Play

$\square$ : Stop

$\leftarrow$ : Fast reverse

$\rightarrow$ : Fast forward

$\square$ : Pause

$\blacktriangle$ : Opens/closes the disc tray

**0, 1 to 9, +10:** Numeric keys

You may also use the following buttons:

**VOL  $\Delta/\nabla$ :** Adjusts volume at TX-SR800

**MUTING:** Activates muting function at TX-SR800

#### Note:

When operating an Onkyo DVD player directly with the remote controller without connecting the **RF** terminals, pre-programming is necessary (see page 65).

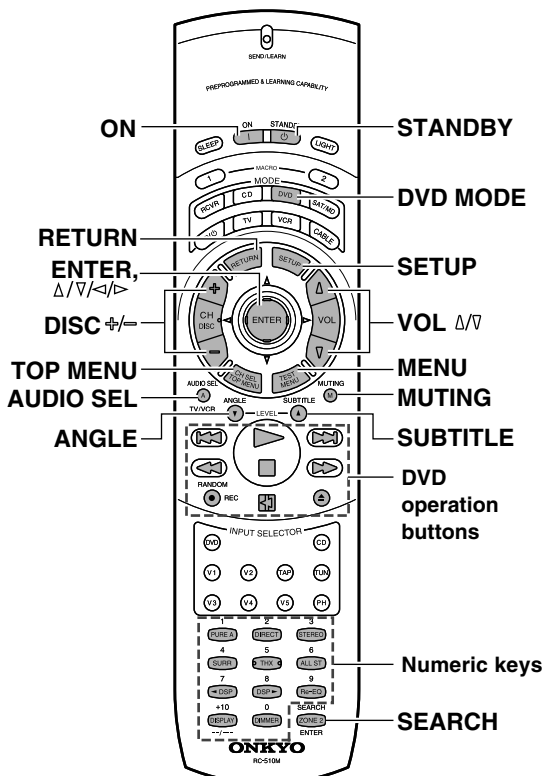

## Using remote controller

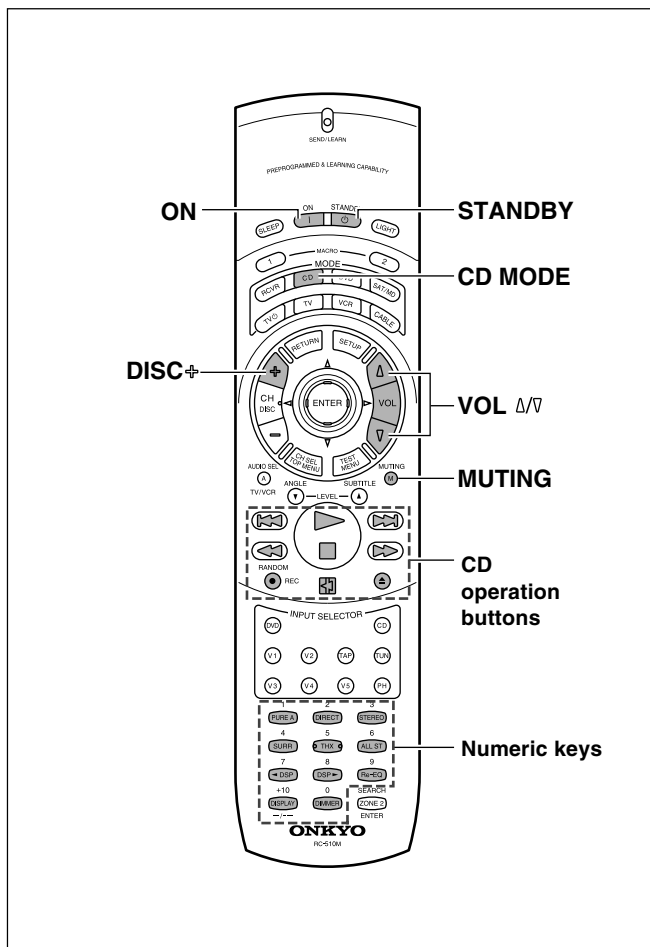

### Controlling an Onkyo CD player

The **RI** connector of the Onkyo compact disc player must be connected to the TX-SR800 (see page 26).

#### 1. Press the **CD MODE** button.

The CD MODE button lights.

#### 2. Press the **desired operation button**.

The buttons shaded in the figure to the left are the operation buttons that can be used to control an Onkyo compact disc player.

#### Operation buttons:

**ON:** Turns on and off the compact disc player (same as **STANDBY** button on the remote controller)

**DISC +:** Selects a disc in the CD changer

: Track down

: Track up

: Play

: Stop

: Skip backward

: Skip forward

: Pause

: Opens/closes disc tray

**0, 1 to 9, +10:** Numeric keys

**RANDOM:** Random playback

You may also use the following buttons:

**VOL Δ/V:** Adjusts volume at TX-SR800

**MUTING:** Activates muting function at TX-SR800

## Using remote controller

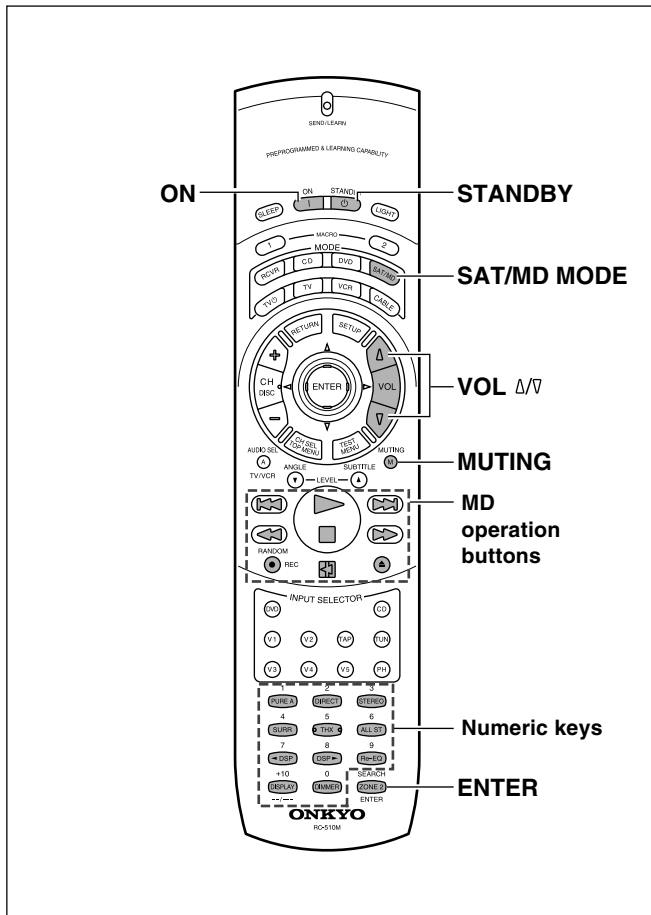

### Controlling an Onkyo MD recorder

The **RI** connector of the Onkyo MD recorder must be connected to the TX-SR800 (see page 26).

#### 1. Press the **SAT/MD MODE** button.

The SAT/MD MODE button lights.

#### 2. Press the **desired operation button**.

The buttons shaded in the figure to the left are the operation buttons that can be used to control an Onkyo MD recorder.

#### Operation buttons:

**ON**: Turns on and off MD player (same as **STANDBY** button on the remote controller)

: Track down

: Track up

: Play

: Stop

: Skip backward

: Skip forward

**REC ●**: Record

: Pause

: Eject

**1 to 9, 0, --/--**: Numeric keys

**ENTER**: Enters the settings

You may also use the following buttons:

**VOL Δ/∇**: Adjusts volume at TX-SR800

**MUTING**: Activates muting function at TX-SR800

#### Note:

The SAT/MD button is used for operating satellite tuners and Onkyo MD recorders. Be aware that if you enter the preset code for a satellite tuner as shown on page 65, then this button cannot be used to operate Onkyo MD recorders.

If this is the case, to operate an Onkyo MD recorder, you must first erase the satellite tuner code by following the directions given in "Erasing all the commands programmed under a MODE button" on page 70.



# Entering a pre-programming code

The remote controller has three learning functions. One is entering the pre-programmed code for a remote controller of another manufacturer. Another is the normal learning function that enables the remote controller to learn the codes directly from other remote controllers (see page 69). And the last is a macro learning function that enables you to program a series of operations into the remote controller so that the operations can all be performed at once by pressing one button.

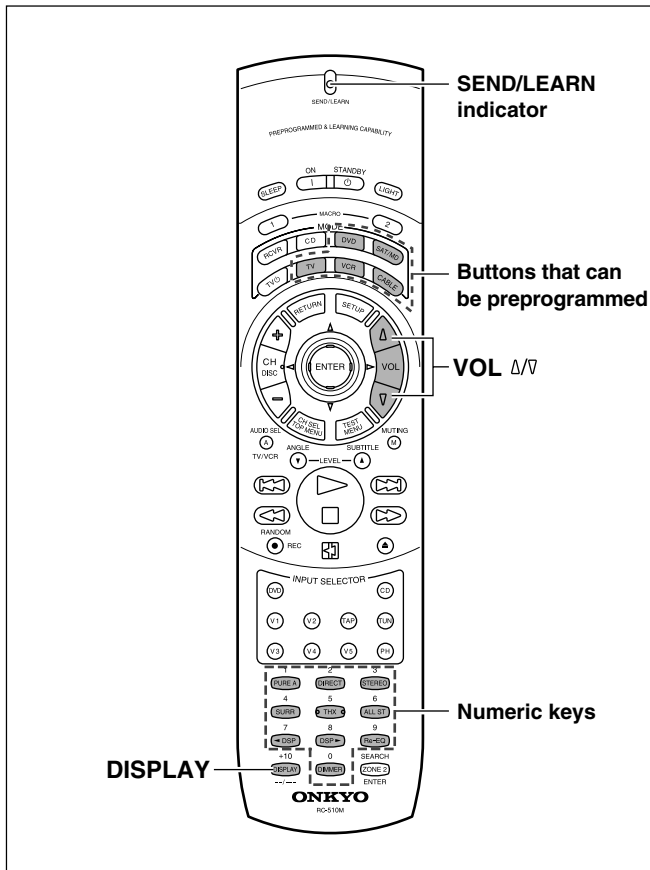

## Caution

With some brand's components, some buttons may not work correctly. In this case, program the command directly from the other remote controller normally (see page 69).

## Learning a pre-programming code

By entering a pre-programming code, you can have the RC-510M remote controller operate a component made by another manufacturer. The buttons that are used for operation are given on the next page.

1. Find the 3-digit number listed for the manufacturer name of the component that you want to operate in the table on the next page.
2. Turn on the component that you want to operate (i.e. DVD, satellite tuner, or television).
3. While holding down the MODE button on the RC-510M that you want to program, press the DISPLAY button, and then release both buttons.

The SEND/LEARN indicator lights when the MODE button is pressed and turns off when the DISPLAY button is pressed. When the indicator turns off, release both buttons. The SEND/LEARN indicator lights again.

4. Within 30 seconds, enter the 3-digit code number.

The SEND/LEARN indicator slowly flashes twice. If the SEND/LEARN indicator quickly flashes three times, then either a mistaken 3-digit code was entered or an incorrect operation was performed. If this occurs, return to step 3.

5. Press the button that you programmed and check if the system operates correctly.

- If the component does not operate properly, return to step 3 and repeat the steps above.
- If it still does not operate properly, program the command directly from the other remote controller normally (see page 69).

## When entering the code of Onkyo DVD players:

There are three SETTING numbers. Choose the SETTING number according to how you will be using the DVD player.

**No. 601/613:** These codes are for operating the Onkyo DVD player by pointing the remote controller directly at it, either because it does not have an **RI** terminal, or it does but you are not connecting it with an **RI** cable. First enter 601 and if it does not operate properly, enter 613.

**No. 600:** This code is for Onkyo DVD players that have an **RI** terminal that you are connecting to the TX-SR800 with an **RI** cable. You will then operate the DVD player by pointing the remote controller at the remote control sensor on the TX-SR800. You do not need to enter this code because it is factory preset. However, if the code has been changed to 601 or 613, then you will need to change it back to 600.

# Entering a pre-programming code

## Pre-programming codes

### Note:

If more than one code is given in the table, try each code one by one until you reach the code that works (i.e. if the first code does not work, then try the next).

### DVD

BRAND	SETTING No.
DENON	602, 609
HITACHI	603
JVC	604
KENWOOD	605
MAGNAVOX	606, 613
MARANTZ	607
MITSUBISHI	608, 613
ONKYO	600, 601, 613
PANASONIC	609
PIONEER	610
PROSCAN	611
RCA	611
SONY	612
TOSHIBA	613
YAMAHA	609, 614
ZENITH	613, 615

### SAT

BRAND	SETTING No.
ECHOSTAR	700
GENERAL INSTRUMENTS	701
HITACHI	702
HUGHES NETWORK SYSTEMS	703
PANASONIC	704
PRIMESTAR	705
PROSCAN	706, 707
RCA	706, 707
SONY	708
TOSHIBA	709

### CABLE

BRAND	SETTING No.
GENERAL INSTRUMENTS	500
GEMINI	501
HAMLIN	502, 503, 504, 505
JERROLD	500, 506, 507, 508, 509, 510, 511, 512, 513, 514
MACOM	515, 516, 517
MAGNAVOX	518
OAK	519, 520, 521
PANASONIC	522, 523
PHILIPS	524, 525, 526, 527, 528, 529
PIONEER	530, 531
SCIENTIFIC ATLANTA	532, 533, 534
SAMSUNG	535
TOCOM	536
ZENITH	537, 538

### VCR

BRAND	SETTING No.
AIWA	300, 301, 302
AKAI	303, 304, 305, 306, 307
BAIRD	308
BELL & HOWELL	309
BLAUPUNKT	310
CGM	311, 312, 313
COLTINA	314
DAEWOO	315, 316
DIGITAL	317
EMERSON	318, 319, 320, 321, 322
FENNER	323
FISHER	324, 325, 326, 327
FUJITSU GENERAL	328
FUNAI	329
GE	330, 331
GO VIDEO	332, 336, 337
GOLDSTAR	333, 334
GOODMANS	335
GRUNDIG	338
HITACHI	339, 340, 341
JVC	342, 343, 344, 345, 346, 347, 348, 349, 350
LOEWE	351, 352
MAGNAVOX	353, 354, 355
MITSUBISHI	356, 357, 358, 359, 360, 361, 362, 363, 364
NEC	365, 366, 367
NOKIA	313
NORDMENDE	368, 369, 370
OKANO	371, 372
ORION	319, 373
PANASONIC	374, 375, 376, 377, 378
PHILIPS	353, 379, 380
PHONOLA	311
PIONEER	381
RCA	382
SABA	383
SAMSUNG	384, 385, 386, 387, 388, 389, 390
SANYO	391, 392, 393
SCOTT	394
SELECO	395
SHARP	396, 397, 398, 399
SHINTOM	400
SIEMENS	401
SONY	402, 403, 404, 405, 406, 407, 408, 409, 410, 411, 412, 413
SYMPHONIC	414
TEKNIKA	414, 415
TELEFUNKEN	416, 417
TOSHIBA	418, 419, 420
WHITE WESTINGHOUSE	333
WATSON	421
ZENITH	422

### TV

BRAND	SETTING No.
AIWA	100, 101
AKAI	102, 103, 104
AUDIOSONIC	105
BELL & HOWELL	106
BLAUPUNKT	107
BRIONVEGA	108, 109
CENTURION	110
COLTINA	111, 112, 113
CORONAD	114
CROWN	115, 116
DAEWOO	117, 118, 119, 120, 121
DUAL	122
EMERSON	123, 124, 125, 126, 127
FENNER	128, 129
FERGUSON	130, 131
FISHER	132
FUNAI	133, 134, 135
FUJITSU GENERAL	136, 137, 138
GE	139, 140, 141
GOLDSTAR	142, 143
GOODMANS	144
GRUNDIG	145, 146
HITACHI	147, 148, 149, 150
HYPER	151
INNO HIT	152
IRRADIO	103
JVC	153, 154, 155, 156, 157
KENDO	158
KTV	159, 160
LUXOR	161
MAGNAVOX	162, 163
MARANTZ	164
MARK	165
MATSUI	166, 167, 168, 169
MITSUBISHI	170, 171, 172, 173
MIVAR	174, 175
NEC	176, 177
NOKIA	178, 179, 180, 181
OCEANIC	181
NORDMENDE	182, 183
OKANO	152
ORION	184, 185, 186
PANASONIC	187, 188, 189, 190
PHILIPS	152, 162, 191
PIONEER	192, 193
PROSCAN	194
QUASAR	195
RADIO SHACK	196
RCA	110, 141, 197, 198, 199, 200
SABA	182, 183, 201
SAMSUNG	202, 203, 204, 205, 206, 207, 208
SANYO	209, 210, 211, 212
SCHNEIDER	103
SEARS	213
SELECO	214, 215
SHARP	216, 217
SONY	218, 219, 220, 221, 222, 223
SYMPHONIC	224, 225
TELEFUNKEN	201, 226, 227
THOMSON	228
TOSHIBA	213, 229
UNIVERSUM	230
ZENITH	231, 232

# Operating your programmed remote controller

After entering a pre-programming by following the procedure given above, the following modes become enabled for use.

## DVD MODE (DVD Player Mode)

Operations are the same as explained on page 62.

## SAT MODE (Satellite Tuner Mode)

### 1. Press the SAT/MD MODE button.

The SAT/MD MODE button lights.

### 2. Press the desired operation button.

The buttons shaded in the figure to the left are the operation buttons that can be used to control your satellite tuner unit.

**The buttons given below have operations programmed into them.**

**ON:** Turns on and off satellite tuner unit (same as **STANDBY** button on the remote controller)

**CH +/-:** Changes selected preset channel

**Δ/∇/◀/▶:** Moves cursor

**ENTER:** Confirms selection

**MENU:** Displays menu

**0,1 to 9:** Numeric keys

**ENTER:** Confirm

You may also use the following buttons:

**VOL Δ/∇:** Adjusts the volume at the TX-SR800

**MUTING:** Activates the muting function at the TX-SR800

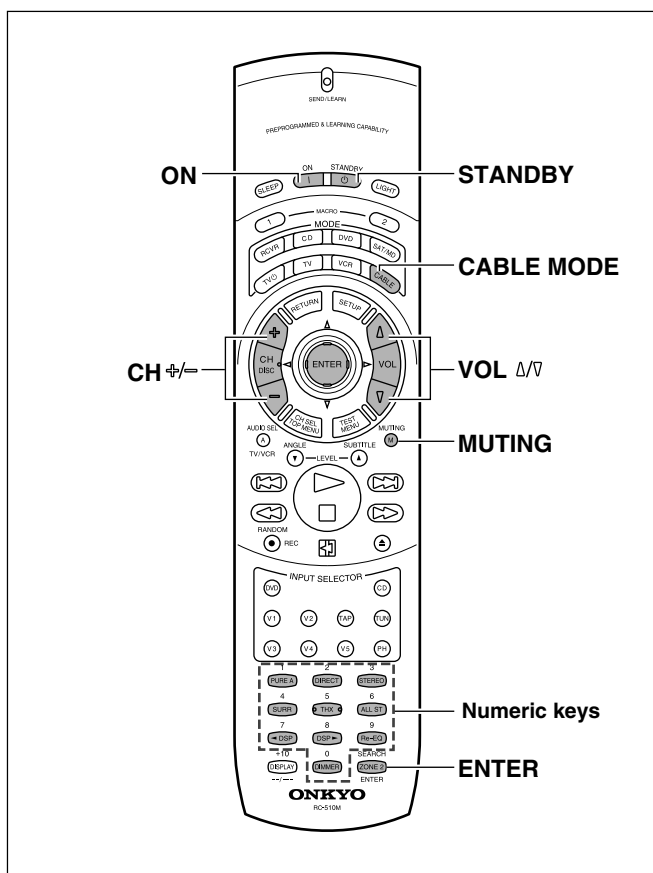
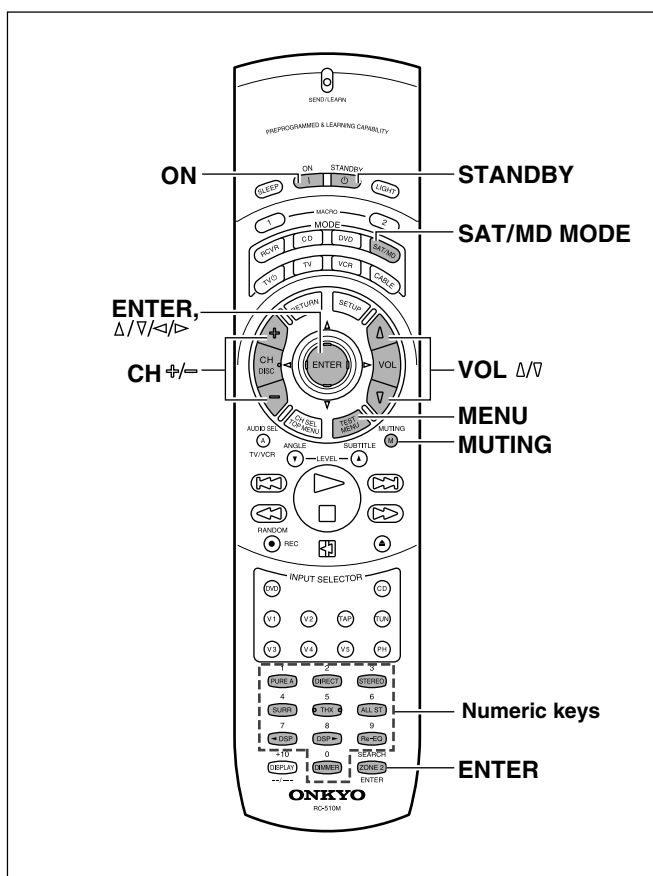

## CABLE MODE (Cable Mode)

### 1. Press the CABLE MODE button.

The CABLE button lights.

### 2. Press the desired operation button.

The buttons shaded in the figure to the left are the operation buttons that can be used to control your cable TV unit.

**The buttons given below have operations programmed into them.**

**ON:** Turns on and off cable TV unit (same as **STANDBY** button on the remote controller)

**CH +/-:** Changes selected preset channel

**0,1 to 9:** Numeric keys

**ENTER:** Confirm

You may also use the following buttons:

**VOL Δ/∇:** Adjusts the volume at the TX-SR800

**MUTING:** Activates the muting function at the TX-SR800

# Operating your programmed remote controller

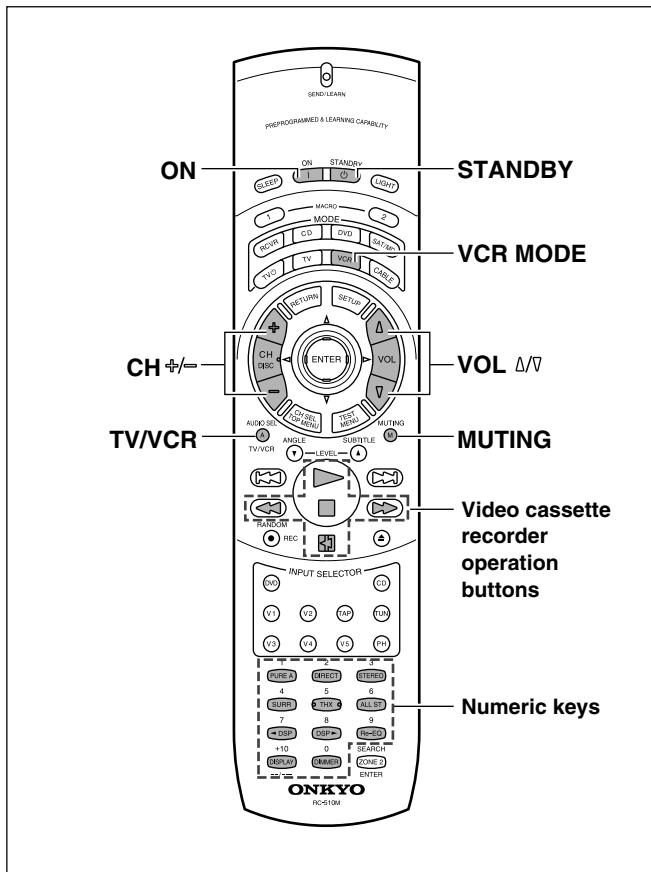

## VCR MODE (VCR Mode)

1. Press the VCR MODE button.

The VCR button lights.

2. Press the desired operation button.

The buttons shaded in the figure to the left are the operation buttons that can be used to control your VCR.

**The buttons given below have operations programmed into them.**

**ON:** Turns on and off the VCR (same as **STANDBY** button on the remote controller)

**CH +/-:** Changes selected preset channel

**TV/VCR:** Switches VCR input setting

▷: Play

□: Stop

◀◀: Rewind

▶▶: Fast Forward

⏸: Pause

**0,1 to 9, +10:** Numeric keys

You may also use the following buttons:

**VOL Δ/V:** Adjusts the volume at the TX-SR800

**MUTING:** Activates the muting function at the TX-SR800

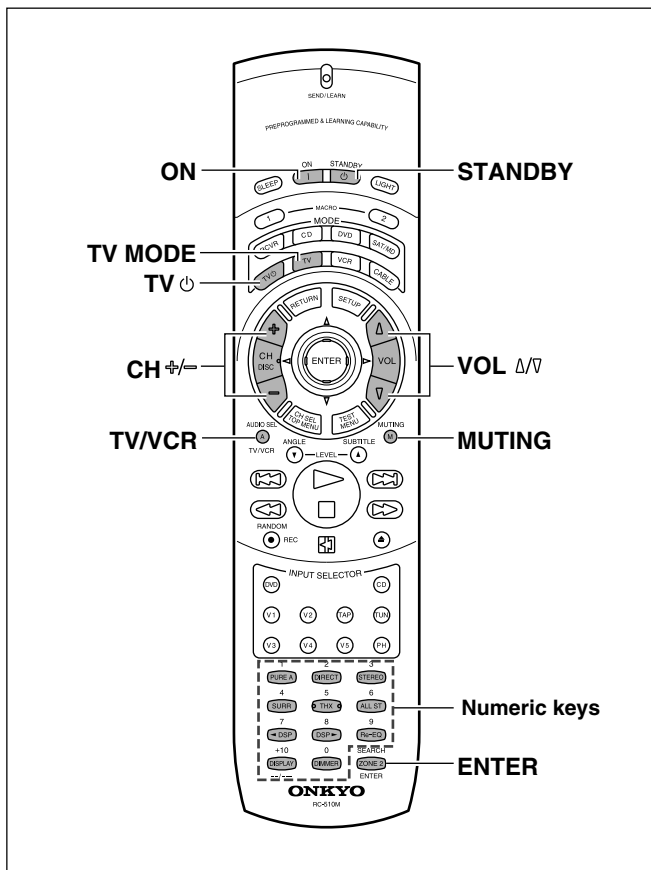

## TV MODE (TV Mode)

1. Press the TV MODE button.

The TV button lights.

2. Press the desired operation button.

The buttons shaded in the figure to the left are the operation buttons that can be used to control your television.

**The buttons given below have operations programmed into them.**

**ON:** Turns on and off the television (same as **STANDBY** button on the remote controller)

**TV:** Turns on and off the television (and switches to the TV mode)

**CH +/-:** Changes television channel

**TV/VCR:** Switches television input setting

**0,1 to 9, +10:** Numeric keys

**ENTER:** Confirm

**VOL Δ/V:** Adjusts volume at television

**MUTING:** Activates muting function at television

# Programming the commands of remote controllers for other devices into the remote controller

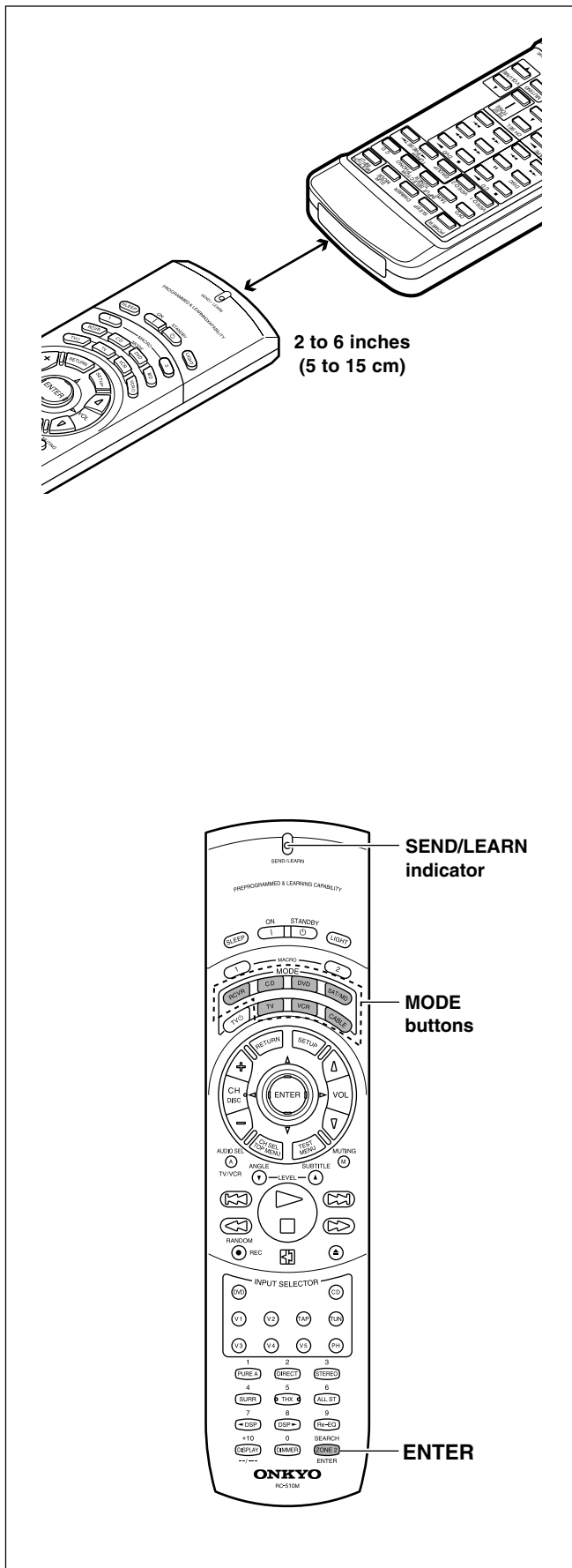

## Programming procedure

When programming the commands of another remote controller to the RC-510M remote controller, you must first decide under which MODE button you want the commands to be linked. In general, you will select the MODE button that corresponds to the component you are programming. For example, if you are programming the functions from a remote controller for a compact disc player, you would choose the CD MODE button. Then, by pressing the CD MODE button, the buttons on the RC-510M remote controller will change to the commands you program here to operate the compact disc player.

After programming which MODE button to use, you will then transfer the separate commands from the other remote controller one at a time. Each command is then programmed to a different button on the RC-510M remote controller. Any button is programmable for this step except for the eight MODE buttons (RCVR, CD, DVD, SAT/MD, TV, VCR, and CABLE), the two MACRO buttons (1 and 2), and the LIGHT button.

Even after the commands have been memorized, keep your old remote controller in a safe place. If for some reason the commands are lost (e.g., when the batteries run down), it will be necessary to memorize them once again.

1. Place the remote controller and the remote controller for the other device facing each other at a distance of 2 to 6 inches (5 to 15 cm) apart.
2. While pressing and holding down the desired MODE button on the remote controller, press the ENTER button and then release both buttons.

The SEND/LEARN indicator lights when the MODE button is pressed and turns off when the ENTER button is pressed. When the indicator turns off, release both buttons. The SEND/LEARN indicator lights again.

3. Press and release the button on the remote controller to which you want to transfer the next command.

You may select any button excluding the eleven ones indicated in the figure below. When you press the button, the SEND/LEARN indicator turns off. When you release the button, the indicator lights again.

If you press the wrong button by mistake, press that same button again. The SEND/LEARN indicator flashes twice, and the remote controller exits the programming mode.

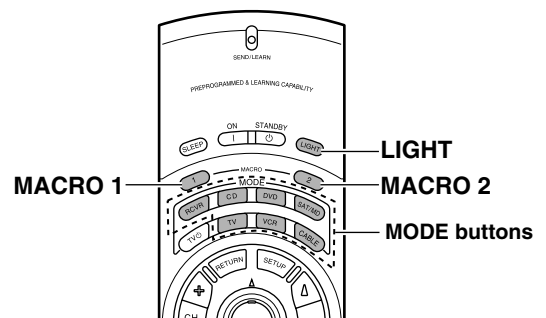

■ : Buttons that cannot be programmed.

# Programming the commands of remote controllers for other devices into the remote controller

4. **Press and hold down the button (that corresponds to the command you are programming) on the remote controller of the other device until the SEND/LEARN lamp on the remote controller flashes twice.**

After flashing twice, the SEND/LEARN indicator will light again.

5. **Repeat Steps 3 and 4 to transfer all the commands you desire from the other remote controller and program them to buttons on the remote controller under the same MODE.**

Repeat Steps 2 through 4 to program commands to a different MODE (e.g., when programming from a different remote controller).

6. **Press the MODE button that you pressed in step 2 to complete the programming.**

7. **Operate the newly programmed buttons to make sure the learning function was performed properly.**

## Notes:

- The remote controller codes for Onkyo compact disc players, cassette tape decks, DVD players, and mini disc recorder have already been programmed into buttons on the remote controller. You may, however, use these buttons to program the codes for other remote controllers. If you wish to restore the Onkyo preset codes after you program new codes, you must first erase the new codes.
- The remote controller has 357 memory slots (7 modes × 51 buttons). Some remote controllers may have more commands that can be remembered by the remote controller. In such cases, it will be necessary for you to determine which commands are more important than others.
- If the SEND/LEARN indicator quickly flashes three times and turns off, then the remote controller has exited the programming mode because either you have made a mistake during programming or a time-out has occurred because no button has been pressed. Resume from Step 2.
- If you try to program beyond the learning capacity of the remote controller, the SEND/LEARN indicator flashes six times quickly, and the remote controller exits the programming mode. Try programming under a different MODE button.
- When you want to program a command to a button to which you have already programmed a command, simply follow the same procedure given and the previous programming for that button will be overwritten.
- The remote controller uses infrared rays to send its commands, as do most other remote controllers. Though most remote controller codes can be memorized by the remote controller, be aware that some remote controllers use systems that are quite different from the remote controller and therefore may not be able to be programmed.
- Some remote controllers have a single button that performs multiple functions (for example, the function may change each time the button is pressed). If this is the case, each function must be programmed to a separate button on the remote controller.
- Once you have transferred the commands from the other remote controller, refer to the instruction manual that came with that product for instructions on how to operate that product.
- Make sure both the remote controller and the other remote controller have new batteries. If either of them has batteries that are low, you may not be able to program the commands of the other remote controller properly into the remote controller.

See page 72 for how to erase the memorized commands from all buttons.

## Erasing the programmed command from one button

You can only erase memorized commands and not preset ones.

1. **Press and hold down the MODE button for the command, press the ENTER button, and then release both buttons.**

When you press the MODE button, the SEND/LEARN indicator lights. When you press the ENTER button, the lamp turns off. When you release the buttons, the lamp lights again.

2. **Press and release the button for the command you wish to erase.**

When you press the button, the SEND/LEARN indicator turns off. When you release the button, the lamp lights again.

3. **Press and release the same button again.**

The SEND/LEARN lamp slowly flashes twice. The memorized command is erased.

## Note:

If the SEND/LEARN indicator quickly flashes three times and turns off, then the remote controller has exited the erasing mode because either you have made a mistake during erasing or a time-out has occurred because no button has been pressed. Resume from Step 1.

## Erasing all the commands programmed under a MODE button

1. **Press and hold down the desired MODE button, press the ENTER button twice, and then release both buttons.**

When you press the MODE button, the SEND/LEARN indicator lights. When you press the ENTER button, the lamp turns off. When you release the buttons, the lamp slowly flashes twice and then lights again.

2. **Press and release the same MODE button again.**

When you release the button, the SEND/LEARN indicator slowly flashes twice. This erases all the commands memorized to the MODE button.

## Notes:

- If the SEND/LEARN indicator quickly flashes three times and turns off, then the remote controller has exited the erasing mode because either you have made a mistake during erasing or a time-out has occurred because no button has been pressed. Resume from Step 1.
- If many commands have been programmed to the MODE button, then the SEND/LEARN indicator may remain lit for up to 20 seconds during Step 2. This is not a malfunction.

# Using the macro function

## What is the macro function?

A macro function enables you to program a series of button operations (up to 16) on the remote controller into a single button. The series of operations are then called a macro. For example, to play a compact disc player connected to the TX-SR800 normally, you must perform the following steps:

1. Press the RCVR MODE button.
2. Press the ON button.
3. Press the CD (INPUT SELECTOR) button.
4. Press the CD MODE button.
5. Press the playback (▷) button.

By using the macro function, you can perform the above five operations by **only pressing one button**.

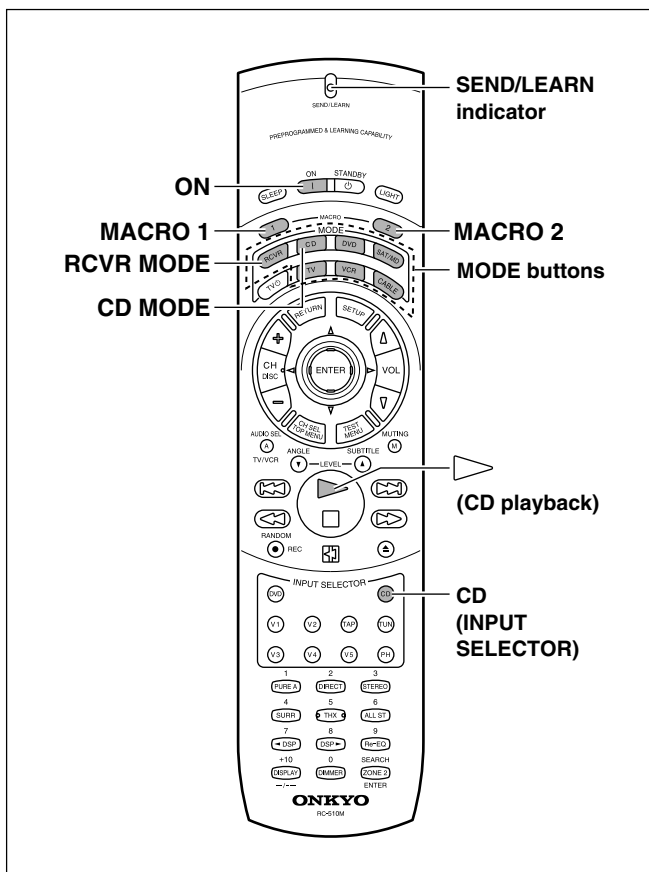

### Tips:

- If you erase or change the command of a button programmed in the macro, that operation of that button will no longer work in the macro. In this case, it will be necessary for you to reprogram the macro in order to avoid incorrect operation.
- The codes programmed into the macro will be transmitted at an interval of 0.5 seconds. However, some devices may not be able to complete one operation in 0.5 seconds and may miss the next code. In this case, after pressing one operation button, you can press the same MODE button again before pressing the next operation button to add another 0.5 seconds between the two operations.

## Programming the macro

With the macro function, you can program a series of button operations as a macro into the MACRO button so the macro can be executed with just one touch. Note that for the macro function, only one macro can be programmed. For example, to program the macro described above on this page for the MACRO button, perform the steps given below.

1. Press and hold down any one of the seven MODE buttons, press the MACRO 1 (or 2) button, and then release both buttons.

When you press the MODE button, it lights and the SEND/LEARN indicator lights. When you press the MACRO 1 (or 2) button, the indicator turns off. When you release the buttons, the indicator flashes briefly and then lights again.

2. Press the operation buttons you wish to program in order (in this case, press RCVR MODE → ON → CD (INPUT SELECTOR) → CD MODE → playback (▷) button).

When you press each button, the SEND/LEARN indicator turns off. When you release the button, the indicator lights.

3. Press the MACRO 1 (or 2) button to complete the procedure.

The SEND/LEARN indicator slowly flashes twice.

4. Check to see if the macro has been properly programmed.

### Notes:

- You may program up to 16 button operations into the macro function. If you try to program a 17th operation, it will be ignored, and programming is stopped.
- If the SEND/LEARN indicator quickly flashes three times and turns off, then the remote controller has exited the programming mode because either you have made a mistake during programming or a time-out has occurred because no button has been pressed. Resume from Step 1.

## Executing the macro

Perform the procedure below to execute the macro that you have programmed into the remote controller. After programming the macro, you should always run it at least once to make sure that it has been programmed properly.

**Point the remote controller at the TX-SR800 and press the MACRO 1 (or 2) button.**

It may take a while for the macro to finish transmitting, so be sure to continue pointing the remote controller at the device until the SEND/LEARN indicator turns off.

## Using the macro function

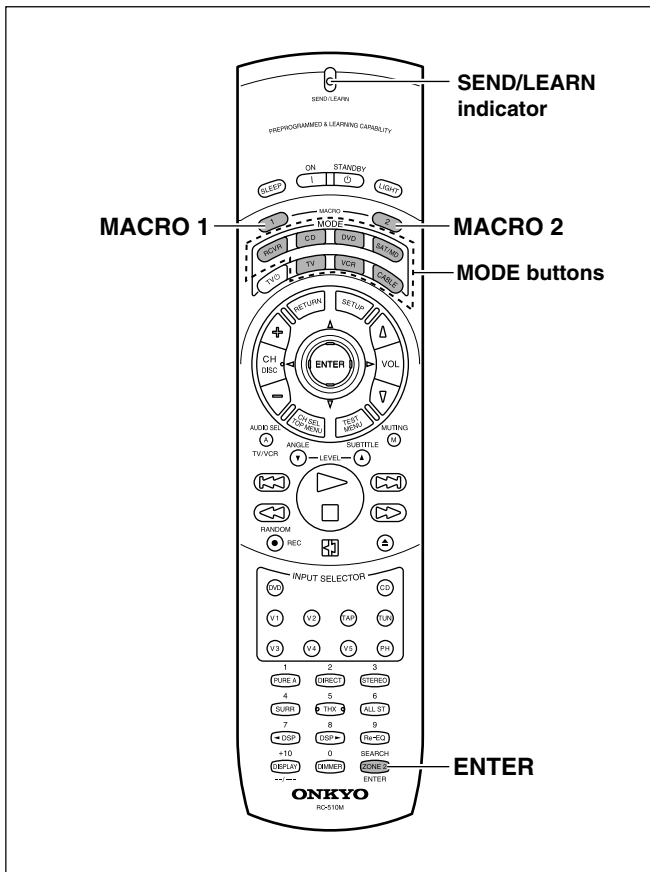

### Erasing a macro from the MACRO 1 (or 2) button

1. **Press and hold down any one of the seven MODE buttons, press the MACRO 1 (or 2) button, and then release both buttons.**

When you press the MODE button, it lights and the SEND/LEARN indicator lights. When you press the MACRO 1 (or 2) button, the indicator turns off. When you release the buttons, the indicator flashes once.

2. **Press the MACRO 1 (or 2) button again.**

The SEND/LEARN indicator slowly flashes twice. The macro programmed to the MACRO button is erased.

#### Notes:

- If the SEND/LEARN indicator quickly flashes three times and turns off, then the remote controller has exited the erasing mode because either you have made a mistake during erasing or a time-out has occurred because no button has been pressed. Resume from Step 1.
- If you press a button other than MACRO 1 (or 2) button in Step 2, then you will in effect be overwriting the previous macro with a new macro.

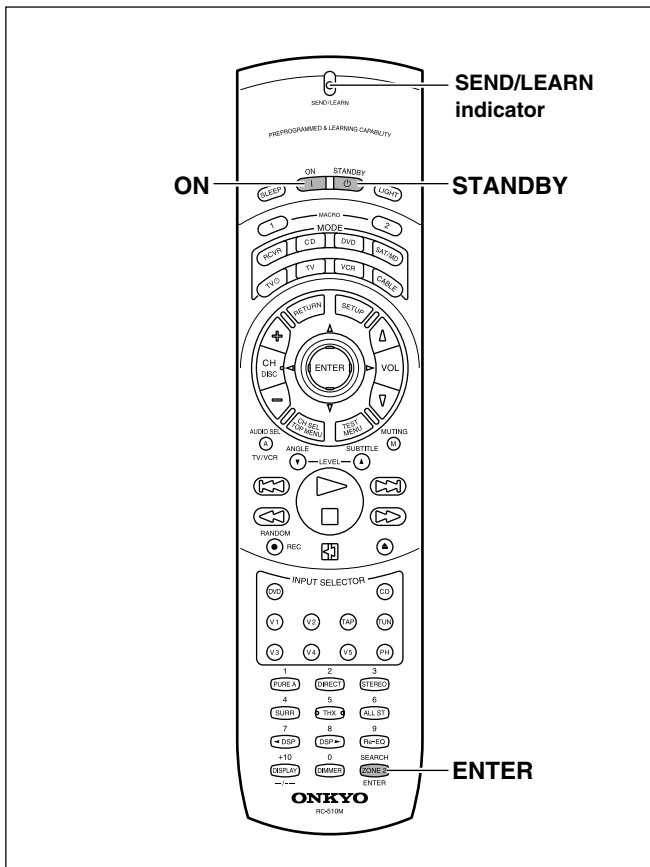

### Erasing all commands and macros that have been programmed

This procedure will erase all the commands and macros that you have programmed into the remote controller and return it to its default settings. This operation will not affect the preset settings of the remote controller.

1. **Open the battery cover and remove the batteries from the remote controller.**

2. **While pressing and holding down the ON and STANDBY buttons, re-insert the batteries in their correct orientation, and then release both buttons.**

The SEND/LEARN indicator flashes slowly.

3. **Press the ENTER button.**

The SEND/LEARN indicator lights up for about ten seconds and then turns off.

All programmed commands and macros are erased and the remote controller returns to its factory presets.

#### Notes:

- Proceed to Step 3 immediately after Step 2; otherwise, the batteries will be consumed quickly.
- If you press any button other than the ENTER button in Step 3, nothing will be erased. In this case, resume from Step 1.



# Troubleshooting guide

If a problem occurs while you are using the remote controller, first try to operate the controls on the front panel of the TX-SR800 to make sure that it is not due to a malfunction (or worn out batteries) in the remote controller.

## POWER

### No power.

- Power cord is disconnected.  
→ Connect power cord (see page 28).
- External noise is affecting the internal microcomputer.  
→ Turn off the power, wait five seconds, and then turn back on the power (see page 28).

### Power turns on but no sound.

- “Muting” is displayed.  
→ Press the MUTING button on the remote controller to turn off muting (see page 30).
- Bad connections or wiring.  
→ Check connections, speaker cables, and other wiring (see pages 15 to 27).

### Sound of playback source is not heard.

- Input selector is not set properly.  
→ Set to correct input source.
- Headphones are connected.  
→ Lower volume and then disconnect headphones.

### Power shuts off immediately after power on.

- Amplifier protection circuitry is activated.  
→ Remove the power cord from outlet immediately. Contact your Onkyo service center.

## SPEAKERS

### No sound from the center speaker, or at very low volume.

- Speaker cable is not connected.  
→ Check the connection between amplifier and speaker (see page 20, 21).
- Listening mode is set to Stereo or Direct.  
→ Set the Listening mode to any mode other than Stereo or Direct. The output to the center speaker may differ depending on the listening mode.
- Center speaker volume is set to minimum.  
→ Set the center speaker level to the appropriate volume (see page 45).
- The Center setting is set to “None.”  
→ Set the Center setting to “Large” or “Small” at Setup Menu → Speaker Setup Menu → Speaker Config Sub-menu (see page 43).

### No sound or very low volume from subwoofer.

- Subwoofer setting is set to “No.”  
→ Set the Subwoofer setting to “Yes” at Setup Menu → Speaker Setup Menu → Speaker Config Sub-menu (see pages 43, 54).
- Subwoofer volume is set to minimum.  
→ Set the subwoofer level to the appropriate volume (see page 45).

### Low frequency humming is heard.

- Not properly grounded.  
→ Check outer conductor of input plugs.
- Turntable motor is not properly grounded.  
→ Check for proper ground connection.

- Audio connection cables on the rear panel are connected incorrectly.  
→ Adjust the placement of the cable to reduce hum.

### Howling is heard when the volume is turned up.

- Turntable and speakers are located too close together.  
→ Move them farther apart.

### Rough or scratchy sound is heard. High range is not clear.

- Turntable needle is dirty or worn, or a problem exists with a connected component.  
→ Refer to the instruction of the connected components and check for problem.
- Treble control is too high.  
→ Turn treble setting down at Setup Menu → Audio Adjust Menu → Tone Control Sub-menu (see page 53).

## FM/AM TUNER

### AM stations cannot be received.

- AM loop antenna is not connected.  
→ Connect the included AM loop antenna to the AM antenna terminals (see page 22).

### Buzzing noise on AM stations (particularly noticeable at night or with weak stations).

- Noise from electrical apparatus such as fluorescent lamp.  
→ Move the AM loop antenna to different position.  
→ Set up an outdoor AM antenna (see page 23).

### Noise is heard at high-pitched sounds on AM stations.

- Noise caused by TV set.  
→ Place the AM loop antenna as far as possible from the TV.  
→ Move TX-SR800 away from TV set.

### Crackling noise on both AM and FM stations.

- Noise caused by fluorescent lamp being turned on and off.  
→ Move antenna as far as possible from the fluorescent lamp.
- Noise from automobile ignition.  
→ Install an FM outdoor antenna as far as possible from the road (see page 23).  
→ Change the position or direction of the outdoor antenna.

### Stereo indicator lights, but sound is distorted and stereo separation is bad.

- Station is too strong.  
→ Change to FM indoor antenna (see page 22).
- Multiple reflection of the radio waves because of tall buildings or mountains.  
→ Use antenna that has better directivity and orient it so distortion is least.

### Indicators for stereo reception flicker and hiss is heard on FM stations.

- Station is too weak.  
→ Install an outdoor FM antenna (see page 23).
- Stereo FM broadcasts cover only about half the distance of an ordinary broadcast.  
→ Change the position or direction of the outdoor antenna.

### No preset station is recalled.

- Memory is lost because power has been turned off for a long time.  
→ Store all stations again (see page 35).

# Troubleshooting guide

## VIDEO and AUDIO

### Desired picture does not appear.

- Improper connection.  
→ Check connections. Insert the plugs and connectors completely (see pages 16 to 19).
- Video Setup Sub-menu settings are incorrect.  
→ Check settings at Setup Menu → Input Setup Menu → Video Setup Sub-menu (see page 48).

### No OSD Menu display.

- Improper connection.  
→ Check connections (see page 17).

### Audio and video do not match.

- Improper connection.  
→ Check connections (see pages 16 to 19).
- Video Setup Sub-menu settings are incorrect.  
→ Check settings at Setup Menu → Input Setup Menu → Video Setup Sub-menu (see page 48).

### Audio is not heard or audio from different source is heard.

- Digital Setup Sub-menu settings are incorrect.  
→ Check settings at Setup Menu → Input Setup Menu → Digital Setup Sub-menu (see page 46).

### No picture appears on the TV screen (or monitor).

- TV (or monitor) is not set to receive the output signals from the receiver.  
→ Set the TV (or monitor) to the receiver input.
- Video cable is not connected securely.  
→ Check connections (see pages 16 to 19).
- Input source is connected to the COMPONENT VIDEO IN connectors.  
→ Make sure TV (or monitor) is connected to COMPONENT VIDEO OUT connectors (see page 17).

## REMOTE CONTROLLER

### Front panel controls function but remote controller controls do not.

- No batteries in remote controller.  
→ Insert batteries (see page 7).
- Batteries have worn out.  
→ Replace batteries (see page 7).
- Remote controller is not pointed at the remote sensor of the TX-SR800.  
→ Point the remote controller at the remote sensor of the TX-SR800 (see page 7).
- Remote controller is too far from the TX-SR800.  
→ Operate the remote controller within 16 feet (5 meters) (see page 7).
- Remote controller is functioning in a different mode  
→ Press the RCVR MODE button.

## OTHER

### LATE NIGHT function cannot be used.

- Playback source is not Dolby Digital encoded.  
→ Check that the DOLBY DIGITAL indicator lights up on the display.

### Re-EQ function cannot be used.

- Parameter may not be able to be set due to current listening mode.  
→ Select different listening mode (see page 58).

### Desired parameter cannot be set.

- Parameter may not be able to be set due to current listening mode.  
→ Check settings in Audio Adjust Menu (see page 58).

### Multichannel audio is not output.

- The Multichannel setting is set to “No.”  
→ Set the Multichannel setting to “Yes” at Setup Menu → Input Setup Menu → Multichannel Setup Sub-menu (see page 47).
- Input source is not connected to MULTI CHANNEL INPUT port.  
→ Check connections (see page 27).

### Components in remote zone (Zone 2) do not operate properly.

- Components are incorrectly connected.  
→ Check connections.
- Objects are interfering with remote controller signals.  
→ Move interfering objects away from path of remote controller signals.

### Sound is sometimes heard and sometimes not heard with digital sources.

- One digital input format has been specified so other digital formats are not played.  
→ Select “All” at Setup Menu → Input Setup Menu → Digital Setup Sub-menu → Digital Format (see pages 47).

### Noise during playback or skipping of the beginning sounds occurs with DTS sources, PCM sources, and other digital sources.

- When “All” is set for the digital format setting, time is required to change formats when different sources are played.  
→ Try specifying the format you are playing at Setup Menu → Input Setup Menu → Digital Setup Sub-menu → Digital Format (see pages 47).

### The unit cannot be switched to Dolby EX or DTS-ES mode.

- “Surr Back/Zone 2” is set to “Zone 2.”  
→ Change the “0. Hardware Setup → 0-2. Surr Back/Zone 2 Sub-men” setting to “Surr Back.” (See page 41)
- The “Surr Back” setting is set to “None.”  
→ Set the “Surr Back” setting to “Large” or “Small” at Setup Menu → “1. Speaker Setup Menu” → “1-1. Speaker Config Sub-menu” (see page 43).

## Troubleshooting guide

---

### If one of the messages shown below appears

#### **“Not available with headphones use”**

Operation not allowed because headphones are plugged into the TX-SR800.

#### **“Not available with Multichannel use”**

Operation not allowed while the multi-channel output is being used.

#### **“Not available in this Sp Config”**

Will not work with the current speaker configuration settings.

#### **“Not available in Zone 2 mode”**

Setting not allowed because the Zone 2 mode is turned on.

#### **“Only available with Dolby D”**

No setting other than Dolby Digital can be set.

#### **“Not available in this Listening mode”**

Will not work with the current listening mode.

#### **“Not available with this signal”**

The listening mode cannot be selected with the current input source.

#### **“Not available in PURE AUDIO mode”**

Will not work with the PURE AUDIO mode.

#### **“Surr Back/Zone 2 setting is Surr Back”**

Operation not allowed because the setting is Surr Back.

#### **“Surr Back/Zone 2 setting is Zone 2”**

Operation not allowed because the setting is Zone 2.

#### **“Not available with this Surr Back/Zone 2 setting”**

Will not work with the current setting.

#### **“Not available with Muting”**

Operation not allowed because the muting is activated.

#### **“Zone 2 is not On”**

Will not work because the Zone 2 has not been turned on.

Also refer to the respective instruction manuals of the CD player, DVD player, video cassette recorder, TV monitor, etc., that compose your entertainment system.

The TX-SR800 contains an internal microcomputer that performs high-level operations. However, on extremely rare occasions, noise or interference from an external source or static electricity may cause faulty operation. If this occurs, unplug the power cord from the wall outlet, wait five or more seconds, and then plug it back in. This should correct the situation.

- \* To reset the surround mode and other settings to the factory default settings, hold down the VIDEO 1 button with the TX-SR800 turned on and then press the STANDBY/ON button. “CLEAR” appears in the front display and the TX-SR800 enters the standby state.

# Specifications

## AMPLIFIER SECTION

Continuous average power output (FTC)

**All channels:** **100 W per channel min. RMS at 8 Ω, 2 channels driven from 20 Hz to 20 kHz with no more than 0.08% total harmonic distortion.**  
**130 W min. RMS at 6 Ω, 2 channels driven from 1 kHz with no more than 0.1% total harmonic distortion.**

Continuous power output (DIN) 135 W at 6 Ω

Maximum power output (EIAJ) 160 W at 6 Ω

Dynamic power output (stereo) 2 × 250 W at 3 Ω

2 × 210 W at 4 Ω

2 × 130 W at 8 Ω

Total harmonic distortion: 0.08% at rated power

0.08% at 1 W output

IM distortion: 0.08% at rated power

0.08% at 1 W output

Damping factor: 60 at 8 Ω

Input sensitivity and impedance

PHONO: 2.5 mV, 50 kΩ

LINE (CD, TAPE, DVD,

VIDEO 1-5): 200 mV, 50 kΩ

MULTICHANNEL INPUT

(FRONT L/C/R, SURROUND

L/R, SURROUND BACK L/R): 200 mV, 50 kΩ

(SUBWOOFER): 36 mV, 50 kΩ

COAXIAL 1, 2, 3 (DIGITAL): 0.5 V<sub>p-p</sub>, 75 Ω

DVD, VIDEO 1, 2, 3, 4, 5: 1 V<sub>p-p</sub>, 75 Ω

1 V<sub>p-p</sub>, 75 Ω (Y)

0.28 V<sub>p-p</sub>, 75 Ω (C)

COMPONENT VIDEO 1, 2: 1 V<sub>p-p</sub>, 75 Ω (Y)

0.7 V<sub>p-p</sub>, 75 Ω (PB, PR)

Output level and impedance

Rec out (TAPE, VIDEO 1, 2):

200 mV, 470 Ω

Pre out: 1 V, 470 Ω

VIDEO (VIDEO 1, 2, MONITOR

OUT, ZONE 2 OUT):

1 V<sub>p-p</sub>, 75 Ω

1 V<sub>p-p</sub>, 75 Ω (Y)

0.28 V<sub>p-p</sub>, 75 Ω (C)

COMPONENT VIDEO OUT: 1 V<sub>p-p</sub>, 75 Ω (Y)

0.7 V<sub>p-p</sub>, 75 Ω (PB, PR)

Phono overload: 120 mV RMS at 1 kHz, 0.5% T.H.D.

Frequency response: 10 Hz to 100 kHz : +1/-3 dB

(CD in Direct mode)

RIAA deviation: 20 Hz to 20 kHz : ±0.8 dB

Tone Control

Bass: ±10 dB at 50 Hz

Treble: ±10 dB at 20,000 Hz

Signal-to-noise ratio (Direct)

Phono: 80 dB (IHF A, 5 mV input)

Line: 110 dB (IHF A, 0.5 V input)

Muting: Due to setup menu

## TUNER SECTION

### FM

Tuning range

USA & Canadian models: 87.5-108.0 MHz (100-kHz steps)

Other models: 87.50-108.00 MHz (50-kHz steps)

Usable sensitivity

Mono: 11.2 dBf, 1.0 μV (75 Ω IHF)

0.9 μV (75 Ω DIN)

Stereo: 17.2 dBf, 2.0 μV (75 Ω IHF)

23 μV (75 Ω DIN)

50 dB quieting sensitivity

Mono: 17.2 dBf, 2.0 μV (75 Ω)

Stereo: 37.2 dBf, 20 μV (75 Ω)

Capture ratio: 2.0 dB

Image rejection ratio

USA & Canadian models: 40 dB

Other models: 85 dB

IF rejection ratio: 90 dB

Signal-to-noise ratio

Mono: 76 dB

Stereo: 70 dB

Alternate channel attenuation: 55 dB

Selectivity: 50 dB (DIN)

AM suppression ratio: 50 dB

Total harmonic distortion

Mono: 0.2%

Stereo: 0.3%

Frequency response: 30 Hz-15 kHz, ±1.0 dB

Stereo separation: 45 dB at 1 kHz

30 dB at 100 Hz-10 kHz

### AM

Tuning range

USA & Canadian models: 530 to 1,710 kHz (10-kHz steps)

Some Asian and Australian

models: 522 to 1,611 kHz (9-kHz steps)

Worldwide models: 522 to 1,611 kHz (9-kHz steps)

530 to 1,710 kHz (10-kHz steps)

Usable sensitivity: 30 μV

Image rejection ratio: 40 dB

IF rejection ratio: 40 dB

Signal-to-noise ratio: 40 dB

Total harmonic distortion: 0.7%

## GENERAL

Power supply

USA & Canadian models: AC 120 V, 60 Hz

Australian models: AC 230-240 V, 50 Hz

Some Asian models: AC 220-230 V, 50/60 Hz

Worldwide models: AC 220-230 and 120 V switchable,

50/60 Hz

Power consumption

USA & Canadian models: 8.1 A

Other models: 655 W

Dimensions (W × H × D): 435 × 175 × 459 mm

17-1/8" × 6-7/8" × 18-1/16"

Weight

USA & Canadian models: 35.9 lbs.

Other models: 17.3 kg

## REMOTE CONTROLLER

Transmitter: Infrared

Signal range: Approx. 16 ft., 5 meters

Power supply: Two "AA" batteries (1.5 V × 2)

Specifications and features are subject to change without notice.

## ONKYO CORPORATION

Sales & Product Planning Div. : 2-1, Nisshin-cho, Neyagawa-shi, OSAKA 572-8540, JAPAN

Tel: 072-831-8111 Fax: 072-833-5222 <http://www.onkyo-intl.com>

### ONKYO U.S.A. CORPORATION

18 Park Way, Upper Saddle River, N.J. 07458, U.S.A.

Tel: 201-785-2600 Fax: 201-785-2650 <http://www.onkyousa.com>

### ONKYO EUROPE ELECTRONICS GmbH

Liegnitzerstrasse 6, 82194 Groebenzell, GERMANY

Tel: +49-8142-4401-0 Fax: +49-8142-4401-555 <http://www.onkyo.net>

### ONKYO CHINA LIMITED

Units 2102-2107, Metroplaza Tower I, 223 Hing Fong Road, Kwai Chung,

N.T., HONG KONG Tel: 852-2429-3118 Fax: 852-2428-9039 <http://www.onkyochina.com>



## Free Manuals Download Website

<http://myh66.com>

<http://usermanuals.us>

<http://www.somanuals.com>

<http://www.4manuals.cc>

<http://www.manual-lib.com>

<http://www.404manual.com>

<http://www.luxmanual.com>

<http://aubethermostatmanual.com>

Golf course search by state

<http://golfingnear.com>

Email search by domain

<http://emailbydomain.com>

Auto manuals search

<http://auto.somanuals.com>

TV manuals search

<http://tv.somanuals.com>