

Cat. No. 16-547/630
OWNER'S MANUAL

Please read before using this equipment.

MODEL 110/MODEL 60

4-Head VHS HQ VCR
4-Head VHS HQ Hi-Fi VCR

OPTIMUS®

IMPORTANT SAFETY INSTRUCTIONS

1. **Read instructions** — All the safety and operating instructions should be read before the appliance is operated.
2. **Retain Instructions** — The safety and operating instructions should be retained for future reference.
3. **Heed Warnings** — All warnings on the appliance and in the operating instructions should be adhered to.
4. **Follow Instructions** — All operating and use instructions should be followed.
5. **Cleaning** — Unplug the VCR from the wall outlet before cleaning it. Do not use liquid cleaners or aerosol cleaners. Use a damp cloth for cleaning.
6. **Attachments** — Do not use attachments not recommended by the VCR manufacturer as they may cause hazards.
7. **Water and Moisture** — Do not use this VCR near water — for example, near a bath tub, wash bowl, kitchen sink, or laundry tub, in a wet basement, or near a swimming pool.
8. **Accessories** — Do not place this VCR on an unstable cart, stand, tripod, bracket, or table. The VCR may fall, causing serious injury to someone and serious damage to the appliance. Use only with a cart, stand, tripod, bracket, or table recommended by the manufacturer or sold with the VCR. Any mounting of the appliance should follow the manufacturer's instructions and should use a mounting accessory recommended by the manufacturer. An appliance and cart combination should be moved with care.

Quick stops, excessive force, and uneven surfaces may cause an appliance and cart combination to overturn.



9. **Ventilation** — Slots and openings in the cabinet and the back or bottom are provided for ventilation and to ensure reliable operation of the VCR and to protect it from overheating. These openings must not be blocked or covered. The openings should never be blocked by placing the VCR on a bed, sofa, rug, or other similar surface.

This VCR should never be placed near or over a radiator or heat register. This VCR should not be placed in a built-in installation such as a bookcase or rack unless proper ventilation is provided or the manufacturer's instructions have been adhered to.

10. **Power Sources** — This VCR should be operated only from the type of power source indicated on the marking label. If you are not sure of the type of power supplied to your home, consult your appliance dealer or local power company. For VCRs intended to operate from battery power or other sources, refer to the operating instructions.
11. **Grounding and Polarization** — This VCR is equipped with a polarized alternating-current line plug (a plug having one blade wider than the other). This plug will fit into the power outlet only one way. This is a safety feature. If you are unable to insert the plug fully into the outlet, try reversing the plug. If the plug should still fail to fit, contact your electrician to replace your obsolete outlet. Do not defeat the safety purpose of the polarized plug.
12. **Power-Cord Protection** — Power-supply cords should be routed so they are not likely to be walked on or pinched by items placed upon or against them, paying particular attention to cords at plugs, convenience receptacles, and the point where they exit from the appliance.
13. **Outdoor Antenna Grounding** — If an outside antenna or cable system is connected to the VCR, be sure the antenna or cable system is grounded so as to provide some protection against voltage surges and built-up static charges.

Section 810 of the National Electrical Code, ANSI/NFPA No. 70-1984, provides information with respect to proper grounding of the mast and supporting structure, grounding of the lead-in wire to an antenna discharge unit, size of grounding conductors, location of antenna-discharge unit, connection to grounding electrodes, and requirements for the grounding electrode.

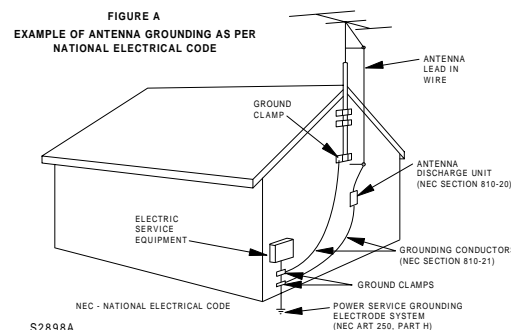

© 1996 Tandy Corporation.
All Rights Reserved.

Optimus is a registered trademark used by Tandy Corporation
RadioShack is a trademark used by Tandy Corporation.



14. **Lightning** — For added protection for this VCR receiver during a lightning storm, or when it is left unattended and unused for long periods of time, unplug it from the wall outlet and disconnect the antenna or cable system. This will prevent damage to the VCR due to lightning and power-line surges.
15. **Power Lines** — An outside antenna system should not be located in the vicinity of overhead power lines or other electric light or power circuits, or where it can fall into such power lines or circuits. When installing an outside antenna system, extreme care should be taken to keep from touching such power lines or circuits as contact with them might be fatal.
16. **Overloading** — Do not overload wall outlets and extension cords as this can result in a risk of fire or electric shock.
17. **Object and Liquid Entry** — Never push objects of any kind into this VCR through openings as they may touch dangerous voltage points or short out parts that could result in a fire or electric shock. Never spill liquid of any kind on the VCR.
18. **Servicing** — Do not attempt to service this VCR yourself as opening or removing covers may expose you to dangerous voltage or other hazards. Refer all servicing to qualified service personnel.
19. **Damage Requiring Service** — Unplug this VCR from the wall outlet and refer servicing to qualified service personnel under the following conditions:
 - When the power-supply cord or plug is damaged or frayed.
 - If liquid has been spilled or objects have fallen into the VCR.
 - If the VCR has been exposed to rain or water.
 - If the VCR does not operate normally by following the operating instructions. Adjust only those controls that are covered by the operating instructions, as improper adjustment of other controls may result in damage and will often require extensive work by a qualified technician to restore the VCR to its normal operation.
 - If the VCR has been dropped or the cabinet has been damaged.
 - When the VCR exhibits a distinct change in performance — this indicates a need for service.
20. **Replacement Parts** — When replacement parts are required, be sure the service technician has used replacement parts, specified by the manufacturer, that have the same characteristics as the original part. Unauthorized substitutions may result in fire, electric shock, injury to persons or other hazards.

21. **Safety Check** — Upon completion of any service or repairs to this VCR, ask the service technician to perform routine safety checks to determine that the VCR is in proper operating condition.
22. **Heat** — This VCR product should be situated away from heat sources such as radiators, heat registers, stoves, or other products (including amplifiers) that produce heat.

Note to the cable TV system installer:

This reminder is to call the CATV system installer's attention to Section 820-40 of the National Electrical Code, which provides guidelines for proper grounding and, in particular, specifies that the cable ground shall be connected to the grounding system of the building, as close to the point of cable entry as practical.

WARNING: To prevent fire or shock hazard, do not expose this VCR to rain or moisture.

	CAUTION RISK OF ELECTRIC SHOCK. DO NOT OPEN.	
CAUTION: TO REDUCE THE RISK OF ELECTRIC SHOCK, DO NOT REMOVE COVER OR BACK. NO USER-SERVICEABLE PARTS INSIDE. REFER SERVICING TO QUALIFIED SERVICE PERSONNEL.		



This symbol is intended to alert you to the presence of uninsulated dangerous voltage within the VCR's enclosure that might be of sufficient magnitude to constitute a risk of electric shock. Do not open the VCR's case.



This symbol is intended to inform you that important operating and maintenance instructions are included in the literature accompanying this VCR.

FEATURES

Your Optimus Model 110 4-Head VHS HQ VCR/Model 60 4-Head VHS HQ Hi-Fi Stereo VCR offers some of the most advanced features available in home video cassette recorders.

Your VCR's PLL (phase-locked loop) tuning ensures extremely accurate tuning of up to 68 VHF and UHF channels and up to 125 cable channels. The VCR's full-function universal remote control and on-screen programming make the VCR easy to use.

Your VCR offers all these features:

Note: The Model 60 includes all of the Model 110's features, but adds Hi-Fi stereo that delivers CD-quality sound for audio/video or audio-only recordings. The Model 60 also includes front panel audio/video jacks that make it easy to connect to a camcorder.

Easy-to-Use Immediate Recording — lets you start a recording immediately and have the VCR automatically stop recording after a length of time you select.

1-Month, 8-Event, Digital Timer — lets you program the VCR to make up to eight unattended recordings (daily, weekly, or one-time) within a 1-month period.

Automatic Playback/Rewind/Eject — automatically plays, rewinds, and ejects a tape.

Fast-Response System — positions the video cassette's tape next to the playback/record head for immediate playback or recording.

Real-Time Counter with Memory — displays the actual length of time a tape plays or records, and allows you to mark and return to a location on the tape.

RECORDING/PLAYBACK

26-Micron Record/Play Head — enhances the picture quality at the EP (Extended Play) playback speed.

Four Double-Azimuth Video Heads — provide superior picture quality and special effects compared with standard single-azimuth four-head VCRs.

AI (Artificial Intelligence) Video Noise Reduction System — reduces noise on the screen when playing back a worn or partially damaged tape.

Auto Tracking System — automatically adjusts tracking when you start playback.

Auto Repeat Playback — automatically rewinds the tape for repeat playback when the tape reaches the end of the tape or the recording.

TUNING

179-Channel, Digital-PLL, Cable-Compatible Tuner — lets you tune to up to 68 VHF and UHF channels and up to 125 cable channels.

Tuner Memory Programming — automatically stores all the active channels in your area into memory.

TAPE CONTROL

One-Minute Skip — lets you fast-forward the tape for exactly 1 minute to let you easily skip over commercials.

Fast-Forward/Rewind with Visual Search

Freeze-Frame/Frame Advance/Slow-Motion

Automatic Rewind

OTHER FEATURES

Multichannel Television Sound (MTS) (Model 60 only) — decodes stereo broadcasts for listening or recording. This VCR can also receive and record special audio programs (SAP) that accompany some MTS broadcasts.

Front and Rear Audio/Video Input Jacks (Model 60 only) — let you quickly connect an audio/video device such as a camcorder to the VCR without disconnecting other devices.

Trilingual On-Screen Programming — provides helpful instructions on the TV screen for setting the clock, programming timers, and starting quick timer recordings. You can select English, French, or Spanish instructions.

Universal Remote Control — lets you control your VCR, plus TVs and cable boxes produced by other manufacturers.

Memory Sentinel — protects clock settings, tuner programming information, and timer memory settings in case of a power loss. The clock continues to run for 3 minutes and tuner programming information and timer memory settings are kept for 24 hours.

Automatic/Manual Clock Setting — lets you set the VCR to automatically update its clock using EDS (Extended Data Service) signals sent by some stations. You can also manually set the clock.

Note: EDS is provided by some broadcasters and includes various types of information, including the current time. If no broadcasters in your area transmit EDS signals, you must manually set the clock.

Automatic DST (Daylight Saving Time) Adjustment — lets you set the VCR to automatically adjust the displayed time for Daylight Saving Time.

We recommend you record the VCR's model and serial number here. This information is on the VCR's back panel.

Model: _____

Serial Number _____

CONTENTS

Before You Begin	7
Accessories	7
Moisture Condensation	7
Using This Manual	7
Installation	8
Common Connections	8
Model 110 Connections	10
Home Theater Connections (Model 60 Only)	11
Camcorder Connections (Model 60 Only)	12
Connecting Power	12
VCR Setup	13
Setting the 3 CH. 4 Switch	13
Remote Control	13
Initial Set Up	14
Setting the Remote Control's Codes	19
Operation	21
Watching TV	21
Viewing a Video Tape	22
Special Functions	23
Special Displays	23
Tape Motion Controls	23
Real-Time Counter	24
Repeat Play	25
Tracking	25
Recording	26
Recording Speeds	26
Tape Selection	26
Erase Protection	26
Selecting the Signal to Record	27
Receiving/Recording Stereo/SAP Broadcasts (Model 60 Only)	27
Immediate Recording	28
Automatic Timer Recording	29
Dubbing	32
Audio-Only Recording (Model 60 Only)	32
Additional Information	33
Troubleshooting	33
Care and Maintenance	34
Specifications	36

BEFORE YOU BEGIN

ACCESSORIES

Be sure to remove these items before you store the packing material.

- Remote Control
- 75-ohm Coaxial Cable

Depending upon your audio/video system set-up, you might need additional cables or adapters. Read "Installation" on Page 8 to determine your specific needs.

MOISTURE CONDENSATION

Condensation inside the VCR can cause tape jams or video head damage. When you move the VCR from a cold area to a warmer one, let it sit for about 2 hours before you plug it in and begin operation. This allows any moisture inside the VCR to completely evaporate.

USING THIS MANUAL

This manual has these major sections:

Installation — shows you how to connect the VCR to your audio/video system.

Setup — includes procedures for preparing and using the remote control, setting the on-screen programming language, setting the channels your VCR can tune, and setting the clock.

Basic Operation — explains how to watch TV using the TV's or VCR's tuner, select channels using the VCR's tuner, and load and play a video tape.

Special Functions — describes what appears on the VCR's display and the TV screen and how to fast-forward and rewind a tape, use the VCR's special playback, display, and search features, set the tracking manually, improve playback of worn or damaged video tapes, and use skip search.

Recording — describes the different methods for recording.

Additional Information — includes a troubleshooting section, care and maintenance procedures, and the VCR's specifications.

We recommend that you read through at least "Installation" on Page 8 and "VCR Setup" on Page 13 thoroughly, to be sure you correctly install and set up your VCR.

When reading through this manual, keep the following in mind:

- Some buttons on the remote control also appear on the VCR. You can use these buttons to operate the same functions. Other procedures use only the VCR's buttons, or only the remote control's.
- Some buttons are labeled differently on the VCR and on the remote control. Since you use the remote control most often to change settings and functions, this manual only refers to the remote control's labels. But, unless otherwise noted, you can use either the remote control's or the VCR's buttons at any time.
- All buttons, switches, and jacks on the VCR and all buttons on the remote control are shown in **BOLD UPPERCASE** letters in this manual.
- Information that appears on the TV screen is shown in this typeface: **PLAY**
- Information that appears on the VCR's display is shown in this typeface: **VCR**
- The VCR displays menus and options on the TV you connect it to, and other information (such as tape motion indicators, the real-time counter, etc.) on its display.

If a menu disappears before you finish entering information, simply locate the step where you first pressed **MENU** on the remote control, then repeat that step and all steps that follow.

INSTALLATION

COMMON CONNECTIONS

Refer to the illustrations on Pages 8 and 9 for these connections.

Note: Some connections shown in this section might require additional supplies, available from your local RadioShack store.

b Connect the VCR to your TV for playback. You can connect:

- Your VCR's **OUT TO TV** jack to your TV's antenna jack, using a 75-ohm coaxial cable

Caution: Never connect the VCR's **OUT TO TV** jack to a terminal that has an antenna connected. Doing so can interfere with other receivers.

- Your VCR's **OUT TO TV** jack to your TV's separate VHF/UHF antenna jacks, using a 75-ohm coaxial cable and a VHF/UHF splitter/combiner
- Your VCR's **AUDIO/VIDEO OUT** jacks to your TV's audio/video jacks, using a stereo audio/video cable

Note: For the best quality recordings, use high-quality A/V cables to make these connections.

A Connect a signal source to the VCR for recording. You can connect (choose one):

- An outside antenna, using a 75-ohm coaxial cable, to the VCR's **IN FROM ANT** jack
- An outside antenna, using 300-ohm lead-in wire and a 300-to-75 ohm transformer, to the VCR's **IN FROM ANT** jack
- Your CATV (cable) company, using the 75-ohm coaxial cable directly from the cable company, to the VCR's **IN FROM ANT** jack

Caution: Some state laws restrict direct connections to cable wires (connections that do not go through a cable box). Check the laws in your area before you make connections.

- A cable converter box to the VCR's **IN FROM ANT** jack

Note: There are many Cable TV systems in use. If you subscribe to Cable TV service and cannot record Cable TV programs, contact your local Cable TV service provider. Most Cable TV service providers offer connection help.

Ã You can also connect an optional video source, such as a camcorder, another VCR, or a DSS system to your VCR using A/V cables. Simply connect it as shown.

Connection Notes:

- You can connect two video sources (three sources for the Model 60) directly to your VCR. To do so, you connect one source to the **AUDIO 1/VIDEO 1 IN** jacks on the back of the VCR using A/V cables and the other to the **IN FROM ANT** jack using a 75-ohm coaxial cable (and, with the Model 60, another source to the **AV2 AUDIO/VIDEO IN** jacks on the front of the VCR, see "Camcorder Connections (Model 60 Only)" on Page 12).
- You can connect additional 75-ohm coax sources to your system using a high-isolation A/B switch to switch between the sources.
- You can connect one 75-ohm coax source to more than one device using a video splitter.

Because of the complexity of the variations possible when using additional video accessories, such as video signal switches, splitters, and combiners, such configurations are not shown in this manual.

Model 60 Connections

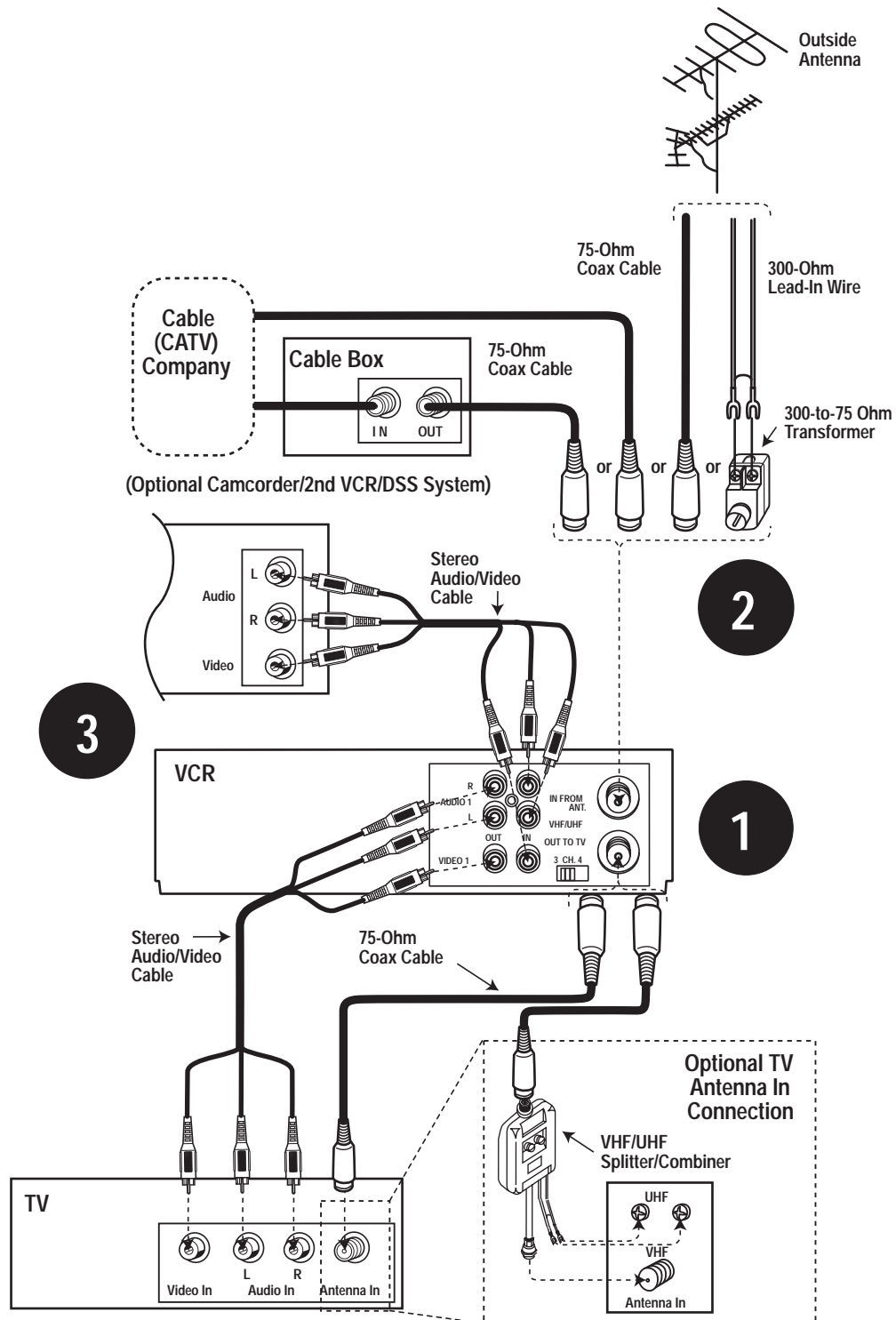

Model 110 Connections

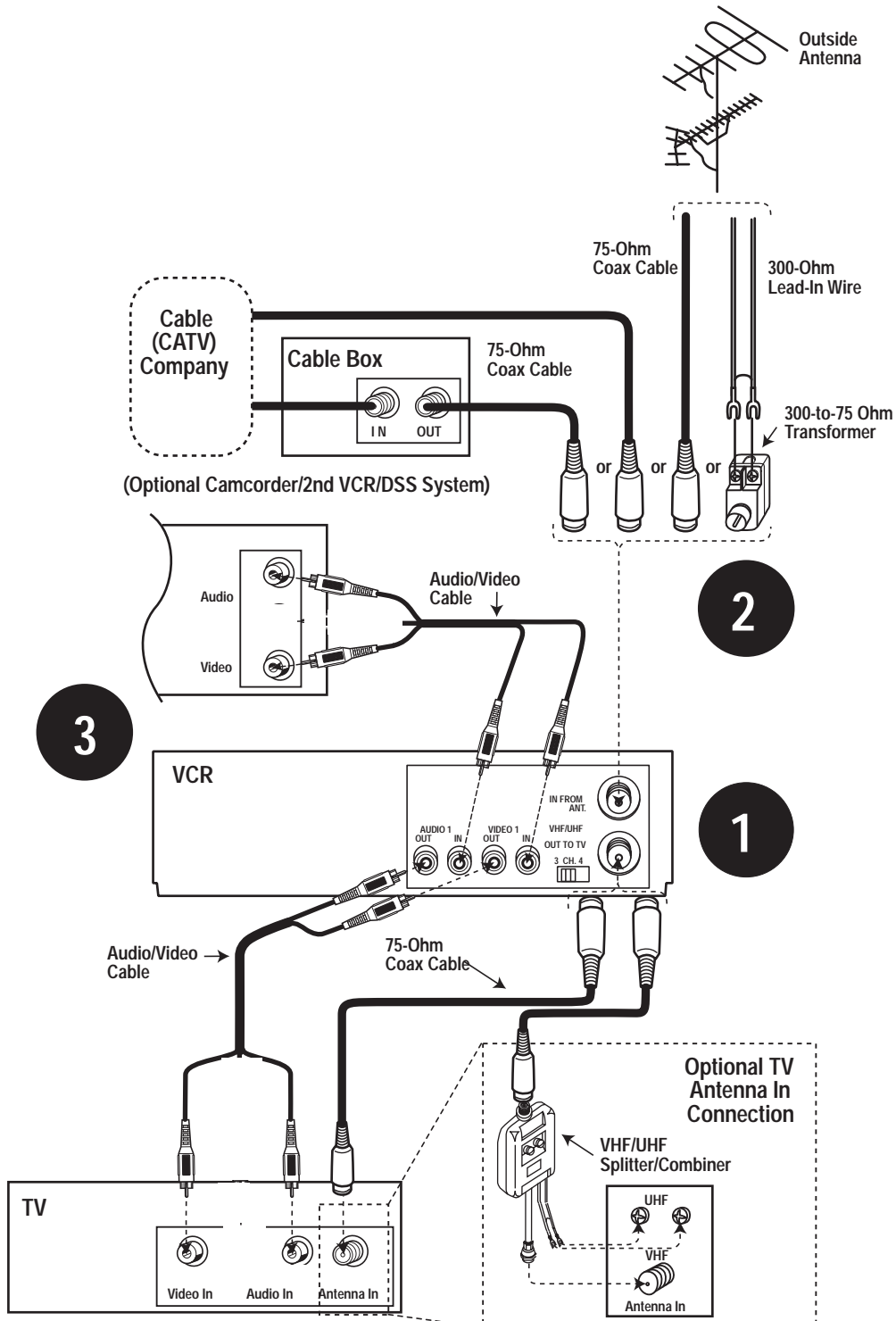

HOME THEATER CONNECTIONS (MODEL 60 ONLY)

Refer to this illustration to connect your VCR to a home theater system.

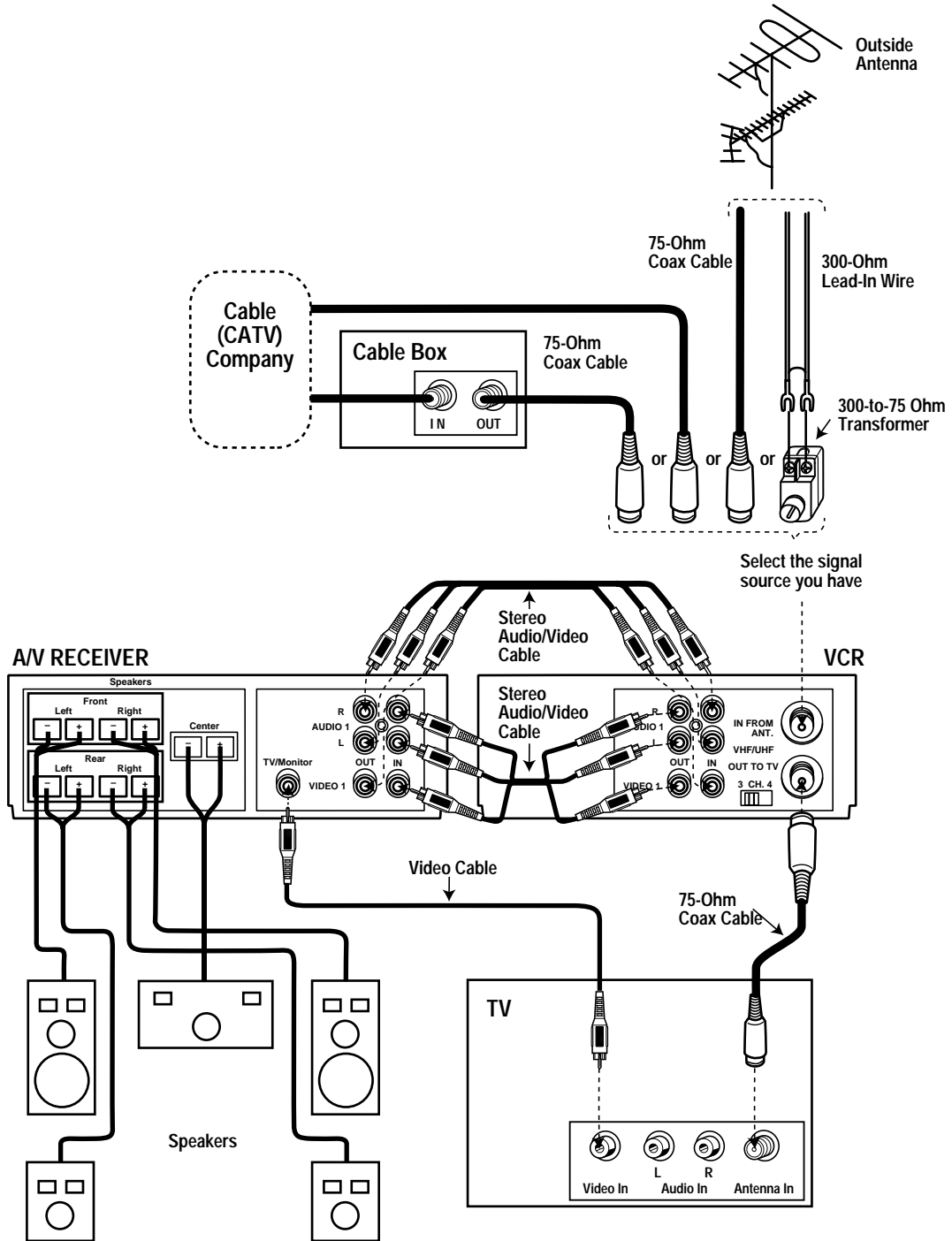

CAMCORDER CONNECTIONS (MODEL 60 ONLY)

Your Model 60 VCR has jacks on its front panel that let you easily connect a camcorder or other video source.

You need a stereo A/V cable for this connection.

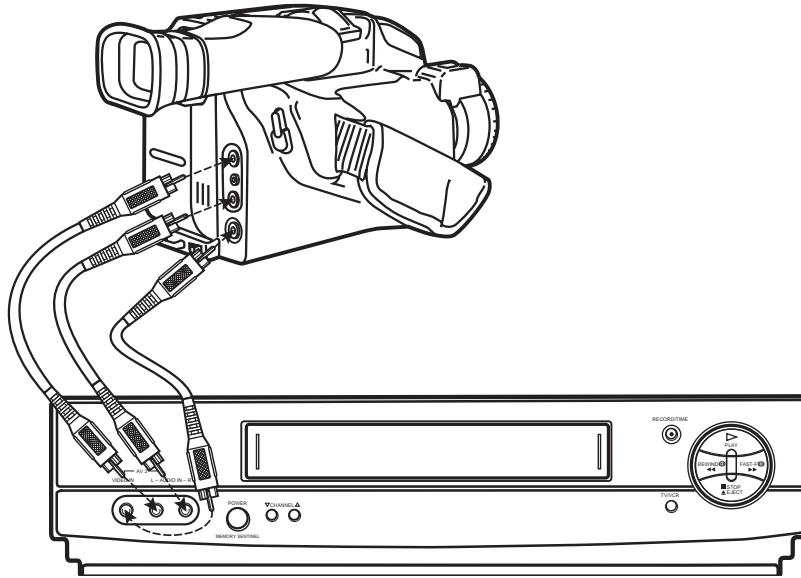

1. Insert the plugs at one end of the cable into the **AV 2 AUDIO** and **VIDEO IN** jacks on the Model 60's front panel.
2. Insert the plugs at the other end of the cable into the **AUDIO/VIDEO OUT** jacks on your camcorder or other video source. Be sure to connect Video to Video and Audio to Audio (use the plug's color codes as a guide).

CONNECTING POWER

To power the VCR, plug its power cord into a standard AC outlet. --:-- appears on the display.

Note: When you plug in the VCR for the first time or when you unplug the VCR and reconnect it (within 24 hours) or after a power failure (of less than 24 hours), the VCR starts to search for a channel that has an Extended Data Service (EDS) signal (see "Turning On Auto Clock Set" on Page 17).

VCR SETUP

SETTING THE 3 CH. 4 SWITCH

If you connected the VCR's **OUT TO TV** terminal to a TV or another VCR, set the VCR's **3 CH. 4** switch (on the back of the VCR) to **3** or **4**, whichever is not an active channel in your area.

When VCR appears on the display, the VCR sends the signal from the video source connected to its **IN FROM ANTENNA** or **AUDIO 1/VIDEO 1 IN** (or **AV2** for the Model 60) terminals to the TV on the channel you selected.

Note: The **3 CH. 4** switch has no effect on the TV when the VCR is off or if you connected a TV with separate audio/video input jacks to the VCR's **AUDIO 1/VIDEO 1 OUT** jacks.

REMOTE CONTROL

Installing the Batteries

The remote control requires two AA batteries (not supplied). For the longest operation and best performance, we recommend alkaline batteries (such as RadioShack Cat. No. 23-557).

Cautions:

- Use only fresh batteries of the required size and type.
- Never leave dead or weak batteries in the remote control. Batteries can leak chemicals that can damage your remote control.
- Dispose of dead batteries promptly and properly; do not bury or burn them.

1. Press the tab on the battery compartment cover and lift off the cover in the direction of the arrow.

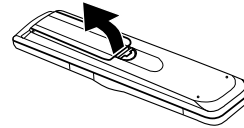

2. Put fresh batteries in the compartment, as indicated by the polarity symbols (+ and -) marked inside.

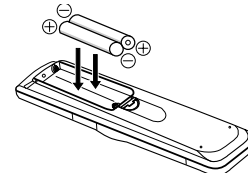

3. Replace the cover.

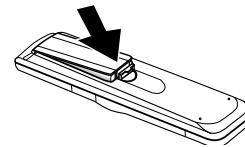

Note: If the remote control does not work or operates poorly, replace both batteries.

Using the Remote Control

To use the remote control, aim it at the front of the VCR and press the desired function buttons.

INITIAL SET UP

Setting the On-Screen Language/ Channels/Clock

When you first plug in the VCR and turn it on, or when you turn it on after a power interruption longer than 24 hours, the VCR automatically prompts you to select a language, and then automatically scans for active channels in your area and stores them. If a station in your area transmits EDS signals, the VCR automatically sets the clock.

1. Press **POWER** to turn on the VCR.
2. Turn on your TV and set it to the same channel as the VCR's **3-CH-4** switch or select its line input if you connected the VCR to the TV's audio/video input jacks. Then press **TV/VCR** so VCR appears on the VCR's display.
3. Select the on-screen instruction language: press **CHs** for English, **CHt** for Spanish, or **TV/VCR** for French.

SELECT LANGUAGE

PUSH VCR CH ▲: ENGLISH
 PULSE VCR CH ▼: ESPAÑOL
 APP. VCR/TV : FRANÇAIS

4. When the on-screen display prompts you to connect an antenna cable, press **CHs**.

CHANNEL AUTO SET

CONNECT ANTENNA CABLE
 THEN...
 PUSH VCR CH UP KEY

After you press **CHs**, the VCR scans through the channels and memorizes all the active channels in your area. When that finishes, the VCR prompts you to set the clock.

Notes:

- Your VCR protects tuner programming for up to 24 hours in case a power failure occurs or if the power cord becomes unplugged. After about 24 hours without power, the VCR loses the tuner programming.
- If you have not connected the VCR to an antenna, cable TV, or other signal source through the **IN FROM ANT** terminal, the VCR does not store any channel in memory. The VCR displays the following:

NO CH FOUND
 PLEASE CHECK ANTENNA
 CABLE CONNECTION THEN
 PUSH VCR CH UP KEY AGAIN

To skip tuner programming, press **MENU**. Then see "Manually Setting the Clock" on Page 16 to set the clock.

5. Press **MENU**. The **SET CLOCK** menu appears.

----- SET CLOCK -----

AUTO SET
 MANUAL SET

SELECT : PUSH SELECT ▲/▼
 SET : PUSH SET KEY
 END : PUSH MENU KEY

In many areas, the local Public Broadcasting Service (PBS) station broadcasts a special data signal along with its regular broadcast. This data signal can automatically set your VCR's clock to the correct time.

If your local PBS station has this signal, proceed to Step 6.

If no station broadcasts the EDS signal (or if you do not know which channel sends an EDS signal), press **SEL t** to select **MANUAL SET** and skip to Step 2 under "Manually Setting the Clock" on Page 16.

Note: Your VCR has a memory sentinel feature that protects clock settings for up to 3 minutes if a power failure occurs or if the power cord becomes unplugged. After about 3 minutes without power, the VCR loses the clock setting. If EDS is available in your area, the VCR automatically updates the clock setting according to the EDS signal when power is restored.

6. Be sure **AUTO SET** is highlighted, then press **SET**. The VCR asks if you are using a cable box.

```

----- SET CLOCK -----
      PLEASE SELECT YOUR
      CABLE BOX SET UP
      CABLE BOX->VCR->TV
      VCR->CABLE BOX->TV
SELECT : PUSH SELECT ▲/▼
SET    : PUSH SET KEY
END    : PUSH MENU KEY
  
```

- If you connected your VCR to an antenna or to cable TV without a cable box, highlight **NO** and press **SET**. The VCR prompts you to enter the local PBS channel. Use **SEL s/t** to select the channel, then press **SET**. It takes up to 10 minutes for the VCR to set the clock using the EDS signal.

```

----- SET CLOCK -----
      PLEASE SET YOUR CABLE
      BOX TO YOUR LOCAL PBS
      CHANNEL
NEXT  : PUSH SET KEY
  
```

- If you connected your VCR to a cable system with a cable box, highlight **YES** and press **SET**. The VCR asks you to select your cable system setup.

```

----- SET CLOCK -----
      PLEASE SELECT YOUR
      CABLE BOX SET UP
      CABLE BOX->VCR->TV
      VCR->CABLE BOX->TV
SELECT : PUSH SELECT ▲/▼
SET    : PUSH SET KEY
END    : PUSH MENU KEY
  
```

If you connected the cable box's output to the VCR's input:

- Highlight **CABLE BOX -> VCR -> TV**, then press **SET**.
- Set your cable box to the local PBS channel, then press **SET**.
- Use **SEL s/t** to select the cable box's output channel. If you use an audio/video connection between the cable box and VCR, select **VIDEO OUT**. Then press **SET**.

If you connected a cable box between the VCR and your TV:

- Highlight **VCR -> CABLE BOX -> TV**, then press **SET**.
- Use **SEL s/t** to select the local PBS channel, then press **SET**.

It takes up to 10 minutes for the VCR to set the clock using the EDS signal. If the VCR does not detect an EDS signal within about 30 seconds, it automatically displays the manual clock setting screen.

Manually Setting the Clock

Note: The clock must be accurately set for proper automatic timer and quick timer recording. We suggest you refer to a radio station or time/temperature service for the correct time.

If the **SET CLOCK** menu already appears on the screen, skip to Step 3.

1. Press **MENU**. Use **SEL** s/t to highlight **SET CLOCK**, then press **SET**.
2. Use **SEL** s/t to highlight **MANUAL SET**, then press **SET**.

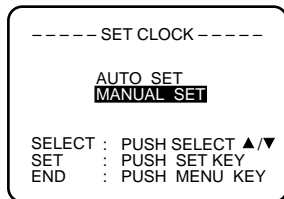

3. Use **SEL** s/t to select the correct month, then press **SET**.

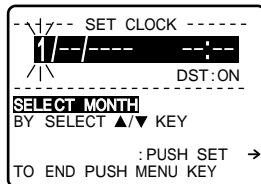

4. Use **SEL** s/t to select the correct date, then press **SET**.
5. Use **SEL** s/t to select the correct year, then press **SET**.
6. Use **SEL** s/t to select the correct hour, then press **SET**. Your VCR uses a 12-hour clock. Be sure you correctly set AM or PM.
7. Use **SEL** s/t to select a time 1 or 2 minutes after the current time, then press **SET**. (For example, if it is 42 minutes past the hour right now, enter 43 or 44 minutes now.) This gives you time to complete this procedure before starting the clock.

8. Use **SEL** s/t to set **DST** (daylight saving time) to **ON** or **OFF**.

When you set **DST** to **ON**, the VCR automatically adds 1 hour on the first Sunday in April, and subtracts 1 hour on the last Sunday in October.

9. Review the entered information.

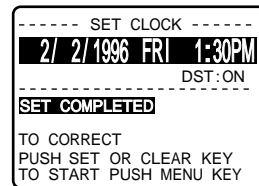

If the information is not correct, move the cursor to the wrong entry using **SET** or **CLEAR** and enter the correct information.

When the information is correct, press **MENU** twice when the time reaches the minute you set in Step 7. The clock-setting mode display changes to the normal display and the clock starts running.

Note: Seconds begin counting from 00 when you press **MENU** twice.

Adding/Erasing Channels

We recommend you check the channels the VCR automatically stored. It might have stored a distant, weak channel that you normally would not watch, or it might have missed a channel you want to store.

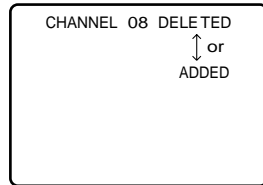

If the tuner stores a channel that you do not want, tune to that channel and press **ADD/DLT**. **CHANNEL nn DELETED** appears on the TV, and the unwanted channel is erased from the tuner's memory.

If you want to program a weak channel that automatic programming missed, enter the desired channel number using the remote control's number buttons. Then press **ADD/DLT**. **CHANNEL nn ADDED** appears on the TV, and the channel is added to the memory.

Reprogramming Tuner Memory

You might want to reprogram the VCR's tuner memory if you move or change from an antenna connection to a cable TV connection.

Follow these steps to reprogram the tuner.

1. Press **MENU** to display the main menu.
2. Use **SEL s/t** to highlight **SET UP CHANNEL**, then press **SET**.

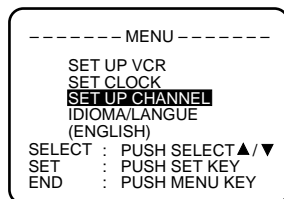

3. Press **SET** to select the broadcast system, either **TV** or **CATV**.

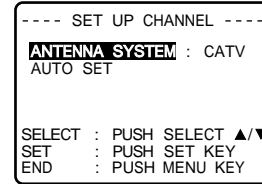

4. Press **SEL t** to highlight **AUTO SET**, then press **SET**. The VCR starts scanning for and storing active channels.

Note: To exit the programming mode, press **MENU** at any time.

Turning On Auto Clock Set

If you manually set the VCR's clock, then find that EDS is available in your area, you can turn on the auto clock set feature. This ensures that the VCR sets itself to the correct time after a power failure of less than 24 hours.

1. Press **MENU** to display the main menu.
2. Use **SEL s/t** to highlight **SET CLOCK**, then press **SET**.
3. Use **SEL s/t** to highlight **AUTO SET**, then press **SET**.

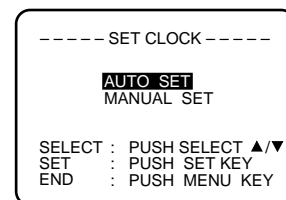

4. Follow Step 6 under "Setting the On-Screen Language/Channels/Clock" on Page 14.

Changing the On-Screen Language

You can change the on-screen programming language at any time.

1. Press **MENU** to display the main menu.
2. Use **SEL** s/t to highlight the fourth item, then press **SET**.

```

----- MENU -----
SET UP VCR
SET CLOCK
SET UP CHANNEL
IDIOMA/LANGUE
(ENGLISH)
SELECT : PUSH SELECT▲/▼
SET    : PUSH SET KEY
END    : PUSH MENU KEY
  
```

```

----- MENU -----
PREPARAR VCR
FIJAR RELOJ
FIJAR CANAL
LANGUE/LANGUAGE
(ESPANOL)
ELEGIR : PULSE SELECT▲/▼
FIJAR  : PULSE SET
TERMINAR : PULSE MENU
  
```

```

----- MENU -----
REGLAGE MAGNETOSCOPE
REGLAGE HORLOGE
REGLAGE CANAL
LANGUAGE/DIOMA
(FRANÇAIS)
SEL.   : APP. SELECT▲/▼
REGLER : APP. SET
FIN    : APP. MENU
  
```

Note: The title of the fourth item differs depending on the current language. If the current language is English, the title shows in Spanish and French (**IDIOMA/LANGUE**). If it is in French, the title shows in English and Spanish (**LANGUAGE/IDIOMA**). If it is in Spanish, the title shows in French and English (**LANGUE/LANGUAGE**).

3. Press **SET** so the desired language appears in parentheses below the title.
4. Press **MENU** to return to the normal screen.

Resetting the VCR's Memory

If at any time you want to erase all settings, including the time, local channels, and programmed events, eject any loaded tape then press and hold **PLAY** and **REW** on the VCR for at least 5 seconds. The VCR clears all settings and turns off.

The next time you turn on the VCR, it performs its initial setup sequence.

SETTING THE REMOTE CONTROL'S CODES

In addition to controlling your VCR, the remote control can operate the basic functions of your TV or cable box.

To use the remote control with your TV or cable box, follow these steps to program the remote control with the correct manufacturer's code number for the TV or cable box.

Note: Some brands have more than one code listed in the charts. If a code does not work with your TV or cable box, try another code. The listed codes might not work with all models from the listed manufacturers.

1. Find the code for your TV and cable box in the following charts.

TV BRAND	CODE
Fisher	10
GE	13
Gold Star	15, 16, 17
Hitachi	12
JVC	11
Magnavox	05
Mitsubishi	13
Panasonic	01, 02
Quasar	01, 02
RCA	03
Samsung	14
Sanyo	10
Sharp	06, 07
Sony	08
Sylvania	05
Toshiba	09
Zenith	04

CABLE BOX BRAND	CODE
Archer	01, 29, 44, 88, 91
Cableview	4, 30, 42, 44, 52, 63, 85, 88
Curtis	08, 09, 56, 61, 87, 90
Diamond	01, 29, 44, 88, 91
Drake	37
Eagle	13, 20, 22, 26, 40, 58, 62, 98
Eastern	28
GC Brand	4, 30, 42, 44, 52, 63, 85, 88
GeminiRegal	04, 85
General Electric	57
General Instruments	01, 02, 03, 04, 34, 55, 83, 85, 91, 93, 95
Hamlin	14, 15, 28, 41, 97
Hitachi	31, 79
Jerrold	01, 02, 03, 04, 34, 55, 83, 85, 91, 93, 95
Macom	31, 79
Magnavox	25, 26
Matsushita	16, 17
Movietime	32, 38, 40
Movietime	29, 32, 39, 42, 44, 88
Optimus	44, 88
Panasonic	16, 17
Philips	13, 20, 23, 24, 96
Pioneer	05, 06, 78
Pulser	4, 30, 42, 44, 52, 63, 85, 88
RadioShack	44, 88
RCA	16, 17
Realistic	44, 88

CABLE BOX BRAND	CODE
Regal	14, 41
Regency	28
Rembrandt	29, 32, 39, 42, 44, 88
Samsung	32, 40, 42, 78, 94
Scientific Atlantic	08, 09, 56, 61, 87, 90
Sheritech	27
SL Marx	32, 40, 42, 78, 94
Sprucer	16, 17
Stargate	32, 40, 42, 78, 94
Stargate	4, 30, 42, 44, 52, 63, 85, 88
Sylvania	19
Telecaption	77, 92
Televue	32, 40, 42, 78, 94
Texscan	18, 19
Tocom	01, 33, 34, 42, 48, 49, 91
Toshiba	36
Unika	01, 29, 44, 88, 91
Universal	42, 43, 44, 52, 63, 88
Viewstar	13, 20, 22, 26, 40, 58, 62, 93
Videoway	07, 23, 50
Zenith	07, 23, 50

2. While pressing and holding down **TV POWER**, enter the code number for your TV using the number buttons.

While pressing and holding down **CATV POWER**, enter the code number for your cable box using the numbered buttons.

3. Try operating your TV or cable box using the VCR's remote control (**TV POWER**, **TV CH s/t**, and **TV VOL +/-** for TV operation; **CATV POWER** and **CATV CH s/t** for cable box operation).

If the device does not function, repeat Step 2 and try other codes for the manufacturer. If it still does not function, you must use the original remote control supplied with your TV or cable box.

Notes:

- The codes you programmed might be erased if you remove the batteries from the remote control. If this happens, re-enter the codes after you replace the batteries.
- Some TVs and cable boxes might require that you manually turn on the power.
- Your TV or cable box might have functions that the remote control will not operate.

OPERATION

WATCHING TV

Using the TV's Tuner

To watch a broadcast using the TV's tuner, turn off the VCR, or press **TV/VCR** until VCR does not appear on the VCR's display.

Note: If you are using a TV/monitor connected to the VCR's **AUDIO/VIDEO OUT** jacks, be sure to set the TV/monitor to the TV mode.

The antenna or cable signals pass through the VCR unaffected, as if the antenna or cable were connected directly to the TV. Use the TV as you normally would.

Using the VCR's Tuner

1. Turn on the TV and set it to the same channel as the VCR's **3 CH. 4** switch.

Note: If you are using a TV/monitor connected to the VCR's **AUDIO/VIDEO OUT** jacks, set the TV/monitor to the video mode.

2. Press **TV/VCR** until **VCR** appears on the VCR's display.

Selecting Channels

Your VCR can receive up to 68 VHF and UHF channels, and up to 125 cable channels. The VCR displays the channels as 1–125.

Notes:

- Channels 2–13 are the same for VHF and cable TV, and cable companies usually number them as they appear on the display.
- Since cable companies sometimes designate cable channels with letters or letter-number combinations, a channel number you see on the VCR's display might differ from the channel number displayed on

your cable box. You might need to experiment to determine the proper cable channel designations for your cable system. For more information, contact your local cable company.

- Two of the cable channels are designated for audio only.

To manually select a channel, press **CH s/t**. The tuner automatically advances to the next channel stored in the tuner's memory.

Note: If you press **CH s** when the tuner is at the highest programmed channel or **CH t** when the tuner is at the lowest programmed channel, the VCR enters the audio/video mode and **L** (**L1** or **L2** on Model 60) appears on the TV (see "Selecting the Signal to Record" on Page 27). Continue to press **CH s/t** until the highest or lowest programmed channel appears.

To directly select a channel, press the number buttons on the remote control for the desired channel.

Notes:

- Precede a single-digit number with a 0 — for example 01, 02, and so on.
- To enter a three-digit number, press **100**. Then enter the second and third digits in the channel number.
- (Model 60 only) If you receive MTS stereo or SAP broadcasts, see "Receiving/Recording Stereo/SAP Broadcasts (Model 60 Only)" on Page 27.

VIEWING A VIDEO TAPE

Loading a Video Tape

1. Turn on the TV and set it to the same channel as the VCR's **3 CH. 4** switch.

Note: If you are using a TV/monitor that is connected to the VCR's **AUDIO/VIDEO OUT** jacks, set the TV/monitor to the video mode.

2. Hold the cassette with the main label facing up and the spine facing out from the VCR. Then insert the cassette into the VCR's compartment and gently push the center of its spine until the VCR draws it in.

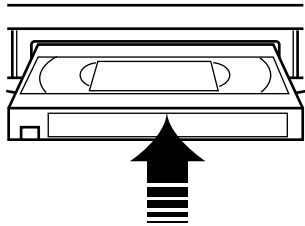

The VCR automatically turns on. If the erase-protection tab has been removed from the cassette, playback automatically begins (see "Erase Protection" on Page 26).

Caution: Never insert anything except a VHS video cassette into the cassette compartment. Anything else might damage the VCR.

Playing a Video Tape

1. Load a video tape.
2. If playback does not automatically begin, press **PLAY**. The VCR plays the tape.

Notes:

- The following screen appears when you press **PLAY**, **FF**, **REW**, or **REC/TIME** without inserting a cassette.

NO CASSETTE
PLEASE INSERT A CASSETTE

- During playback, the VCR automatically adjusts tracking, but you can manually adjust it if necessary (see "Manually Adjusting Tracking" on Page 25).
3. (Model 60 only) Follow these steps to choose the type of audio you want the Model 60 to play back.

To select the audio output option:

- a. Press **MENU**, highlight **SET UP VCR** using **SEL s/t**, then press **SET**.
- b. Highlight **SET AUDIO MODE** using **SEL s/t**, then press **SET**.
- c. Highlight **PLAY AUDIO** using **SEL s/t**, then press **SET** until the desired option — **HIFI** or **NORMAL** — appears.
- d. Repeatedly press **MENU** to return to the normal screen.

Note: If you play a tape recorded on a standard VCR, the Model 60 plays the standard audio track, regardless of the audio output setting.

4. To stop playback before the end of the tape, press **STOP**.
5. To eject the tape, press **STOP/EJECT** on the VCR.

Notes:

- If the tape reaches the end before you press **STOP**, the VCR automatically stops the tape and completely rewinds it. If the erase-protection tab has been removed, the VCR then ejects the cassette.
- When the VCR is off, you can press **STOP/EJECT** to eject a tape. The VCR ejects the tape then turns itself off.

SPECIAL FUNCTIONS

SPECIAL DISPLAYS

Blue Screen Display

The blue screen display appears when you select the VCR mode, play unrecorded portions of a tape, or when you tune to a weak TV station. The blue screen also appears if you set the VCR to the audio/video mode when the **AUDIO/VIDEO IN** jacks are not receiving any signals.

Note: The VCR does not record the blue screen.

On-Screen Display

To view your VCR's current operating mode and other information about your VCR, press **DISPLAY**. You see the broadcast type (stereo, SAP, or both — Model 60 only), current function, time, channel, counter, and tape speed on the TV screen. Press **DISPLAY** again to clear the display.

Note: You also see the remaining recording time while a timed recording is in progress (see "Immediate Recording" on Page 28).

Function Indicators

When you press a function button (such as **STOP**), the selected function indicator appears on the TV screen for about 4 seconds. When you change the channel, the new channel number appears on the TV screen for about 4 seconds.

Note: If you play back a poor quality or damaged tape, the function indicator might not appear on the VCR's display.

TAPE MOTION CONTROLS

Fast-Forward/Rewind and Visual Search

To advance the tape quickly when it is stopped, press **FAST-F**. To rewind the tape quickly when it is stopped, press **REW**. You cannot see the tape picture or hear the tape sound when you use fast-forward or rewind, but you can use the counter to locate a specific section of tape.

To use visual search, begin tape playback. Then press **FAST-F** to search forward or **REW** to search in reverse. Press **PLAY** to return to normal playback.

Notes:

- VCR must appear on the VCR's display to use visual search.
- During visual search, the sound is muted and the picture quality is lower than during normal playback. The search picture is best with tapes recorded at the SP speed.
- If you press **POWER** while a tape is rewinding, the VCR automatically turns off when rewinding is complete.

Freeze-Frame

Freeze-frame lets you stop the tape to view a single frame. Press **PAUSE/STILL** during playback to freeze the picture. Press **PAUSE** again or **PLAY** to return to normal playback.

During freeze-frame, the picture quality is lower than during normal playback. The picture quality is best with recordings made at the SP or EP speed (see "Recording Speeds" on Page 26).

Notes:

- If you leave the VCR in the freeze-frame mode for 3 minutes, the VCR stops playing the tape.
- To reduce or eliminate jitter in the freeze-frame picture, press and hold **CH** s/t until the picture is clear.

Frame Advance

During freeze-frame, you can advance the picture one frame at a time by repeatedly pressing **SLOW**. This feature works best with video cassettes recorded at the SP or EP speed. Press **PAUSE** to return to normal playback.

Slow Motion

To start slow motion playback, while a tape is playing, press **SLOW**. Press **SLOW** again or **PLAY** to return to normal playback.

Notes:

- During slow motion, the sound is muted and the picture quality is lower than during normal playback. Slow motion picture quality is best with tapes recorded at the SP or EP speed.
- If you leave the VCR in the slow-motion mode for 3 minutes, the VCR stops playing the tape.
- If the slow-motion picture is poor, press and hold **CH** s/t until the picture improves.

One Minute Skip

You can skip over unwanted material on the recorded tape, such as commercials. Press **ZERO/1MIN** during playback. The VCR fast forwards over 1 minute of recording, then resumes normal playback.

REAL-TIME COUNTER**Using the Counter**

Your VCR's counter shows how long a tape has been running. To display the counter on the TV screen, press **DISPLAY** on the remote control.

Notes:

- The real-time counter might stop if you fast-forward or rewind through a blank section on the tape. This is normal.
- You can press **COUNTER RESET** to reset the counter to **0:00:00**.

Using the Zero Search Function

You can reset the counter to **0:00:00** at any position on the tape and then return to that position.

Follow these steps to use the zero search function.

1. Press **COUNTER RESET** once so the counter appears on the TV screen.
2. Within 5 seconds, press **COUNTER RESET** again at the location you want to return to later. The counter resets to **0:00:00**.
3. When you want to return to the selected location, stop the tape, then press **ZERO/1MIN**. The tape rewinds or fast-forwards and automatically stops at the location you selected in Step 2.

Notes:

- If you rewind the tape past the zero point, the TV displays the time with a minus (-) sign.
- The counter does not work with blank tapes or blank portions of partially recorded tapes.

REPEAT PLAY

This function lets you automatically repeat playback of a tape from the beginning to the end (or to a blank part), instead of having the tape automatically rewind and eject.

1. While the tape is stopped, press **MENU** to display the main menu.
2. Press **SEL** s/t to highlight **SET UP VCR**, then press **SET**.
3. Press **SEL** s/t to highlight **REPEAT PLAY**. Then press **SET** so **ON** appears.

```

----- SET UP VCR -----
REPEAT PLAY : ON
INPUT SELECT : TUNER
SET AUDIO MODE

SELECT : PUSH SELECT▲/▼
SET : PUSH SET KEY
END : PUSH MENU KEY

```

4. Repeatedly press **MENU** to return to the normal display.
5. Press **PLAY** to start repeat playback. **REP** appears on the VCR's display.

The VCR repeats playback from the beginning to the end of the tape, or to the first unrecorded portion that is at least 30 seconds long. The TV displays **AUTO REPEAT** while the VCR rewinds the tape to the beginning.

Once you select the repeat play mode, it stays in effect even after you turn off the VCR. To turn off repeat play, select **OFF** in Step 3.

TRACKING**Digital Auto Tracking System**

The auto tracking system automatically adjusts tracking when you start playback.

When different parts of the tape are recorded at different speeds, the VCR automatically re-adjusts the tracking at the beginning of each recording. If you need to manually adjust the tracking, see "Manually Adjusting Tracking."

Manually Adjusting Tracking

If the VCR's picture is poor, press and hold down **CH** s or t to manually adjust the tracking. To return to the automatic tracking system, press **CH** s and t at the same time or turn power off then back on.

Notes:

- You might need to slightly readjust tracking for each tape you load.
- If the sound of a recording made on another VHS Hi-Fi VCR is poor, you might improve it by adjusting the tracking. If tracking is incorrect, the **HI-FI** indicator (Model 60 only) does not appear on the display.

RECORDING

There are three ways to record using your VCR — immediate recording, automatic timer recording, and dubbing.

Your VCR automatically records the audio signal and adjusts the sound level while it records.

The video cassette you use for recording must have the erase-protection tab in place. If the tab is removed, the cassette automatically ejects if you try to record on it (see “Erase Protection” on Page 26).

RECORDING SPEEDS

You can select one of three VHS recording/playback speeds: SP (standard play), LP (long play), and EP (super long play).

SP is the fastest recording speed and results in the highest quality picture. LP and EP record more slowly and use less tape, but the picture quality is not as high as a recording made at the SP speed.

TAPE SELECTION

The quality of tape you use greatly affects record/playback quality and the life of the VCR. Use only video cassettes that display the official (VHS) logo. High-grade tape has a better oxide coating that helps prevent dirty video heads and gives the best results.

Although T-160 video cassettes offer the longest recording time, they contain thinner tape that is more likely to jam. We suggest you use T-120 or shorter length tape.

The following chart shows the maximum recording times for different-length tapes at the recording speeds.

TAPE LENGTH	SP	LP	EP
T-60	1 hour (60 minutes)	2 hours (120 minutes)	3 hours (180 minutes)
T-120	2 hours (120 minutes)	4 hours (240 minutes)	6 hours (360 minutes)
T-160	2 ² / ₃ hours (160 minutes)	5 ¹ / ₃ hours (320 minutes)	8 hours (480 minutes)

ERASE PROTECTION

Video cassettes have an erase-protection tab to prevent accidental erasure of a tape. To prevent recording, break off the tab using a screwdriver. The cassette automatically ejects if you try to record on the tape.

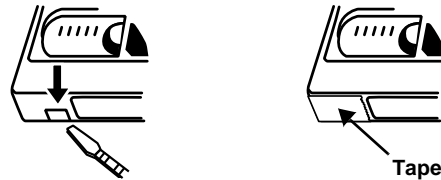

If you want to record on a video cassette that does not have the tab, put a piece of heavy plastic tape over the erase-protection tab hole.

SELECTING THE SIGNAL TO RECORD

Follow these steps to select the signal to record — from the **IN FROM ANT** jack or an audio/video source.

1. Press **MENU**. The TV displays the main menu.
2. Press **SEL** s/t to highlight **SET UP VCR**, then press **SET**. The TV displays the **SET UP VCR** menu.
3. Press **SEL** s/t to highlight **INPUT SELECT**, then press **SET** so the TV displays the desired indicator: **TUNER** to record from a source connected to the **IN FROM ANT** terminal, **L** (**L1** or **L2** for Model 60) to record from a source connected to the **AUDIO 1/VIDEO 1 IN** jacks (or **AV2** jacks on the Model 60).

Notes:

- To select **L1** (or **L2** on the Model 60), you can also press **CH** s/t to set the VCR to one channel higher than the highest channel number (or one channel lower than the lowest channel number).
- (Model 60 only) Select **L1** for recording signals from the back **AUDIO 1/VIDEO 1 IN** jacks, or **L2** for recording signals from the front **AV2** jacks.

RECEIVING/RECORDING STEREO/SAP BROADCASTS (MODEL 60 ONLY)

The Model 60 has 3 channels for audio recording — two (left and right) stereo channels on the Hi-Fi track, and one monaural channel on the standard track.

Press **DISPLAY** to display the audio programs available on the broadcast you are currently tuned to. **STEREO** and **SAP** appear when the broadcast is in stereo and accompanied by SAP. Only **STEREO** appears when the broadcast is in stereo. Only **SAP** appears when the station broadcasts only mono (monaural) and SAP signals. **MONO** appears for regular monaural broadcasts.

When the broadcast contains a SAP signal, you can choose to record the main stereo signal, the SAP signal, or a mono signal by changing the setting in the **SET UP VCR** menu.

1. Press **MENU**, highlight **SET UP VCR** using **SEL** s/t, then press **SET**.
2. Highlight **SET AUDIO MODE** using **SEL** s/t, then press **SET**.
3. Highlight **AUDIO MODE** using **SEL** s/t, then press **SET** until the desired option — **STEREO**, **SAP**, or **MONO** — appears on the screen.
4. Repeatedly press **MENU** to return to the normal screen.

IMMEDIATE RECORDING

Recording a Program as You Watch It

Follow these steps to record a program as you watch it. If you know how long the program is, you can set how long the VCR records.

Note: If you are watching the program on a TV/monitor that is connected to the VCR's **AUDIO/VIDEO OUT** jacks, set the TV/monitor to the video mode and skip Steps 2 and 3.

1. Turn on the VCR and the TV.
 2. Set the TV's tuner to the same channel as the VCR's **3 CH. 4** switch.
 3. Press **TV/VCR** until the VCR displays VCR.
 4. Insert a blank cassette, or one that you want to record over, into the VCR.
 5. Press **SPEED** on the remote control until the TV displays the desired recording speed (**SP**, **LP**, or **EP**).
 6. Select the signal to record (see "Selecting the Signal to Record" on Page 27).
 7. (Model 60 only) Set the audio recording mode to the desired setting. See "Receiving/Recording Stereo/SAP Broadcasts (Model 60 Only)" on Page 27.
 8. Press **REC/TIME** on the remote control, or **REC/TIME** and **PLAY** at the same time on the VCR. The VCR starts to record and the TV screen shows **TO SET SPECIFIC REC TIME PLEASE PUSH REC KEY**.
- Note:** To record without a set duration, just skip Step 9. The VCR begins to record.
9. Press **REC/TIME** again. The TV displays the recording length. Repeatedly press **REC/TIME** to advance the timer to the desired recording length. The recording length advances in 30-minute increments up to 2 hours, then 1-hour increments up to 4 hours.

Notes:

- To ensure that you record all the desired program, set the recording length longer than the program length.
 - To display the remaining recording time, press **DISPLAY** during a timed recording.
 - To temporarily stop the tape during a recording, press **PAUSE/STILL**. Press **PAUSE/STILL** again to resume recording. If you leave the VCR paused for 3 minutes, the VCR automatically stops.
 - If the cassette's erase protection tab has been removed, the screen shows **CHECK CASSETTE RECORD TAB** and ejects the cassette. Use another cassette, or place a piece of heavy plastic tape over the erase protection tab hole.
10. Press **STOP** to stop recording before the set time.

Recording One Program While You Watch Another

1. Follow Steps 1-9 of "Recording a Program as You Watch It."
2. Press **TV/VCR** until VCR disappears from the VCR's display.

Note: If you are watching the program on a TV/monitor that is connected to the VCR's **AUDIO/VIDEO OUT** jacks, set the TV/monitor to the TV mode.

3. Set the TV tuner to the channel you want to watch.
4. Press **STOP** to stop recording before the set time.

AUTOMATIC TIMER RECORDING

The VCR's automatic timer lets you program it to select an input source, start recording from that source at a time you set, then stop recording at a time you set. You can set up to eight program timers to record any combination of weekly, daily, or one-time events.

You can set the VCR to record at any time on a specific day within a 1-month period, at the same time Monday through Friday (DAILY), or at the same time on the same day every week (WEEKLY).

Notes:

- The VCR can record only one broadcast at a time. If you program the VCR's timer to record broadcasts on different channels that start at the same time, the VCR only records the program that has the lowest program number.
- If two timer programs overlap, the one that starts first has priority. The VCR begins recording the second program after the first program ends.
- The VCR must be off at the programmed time for it to make an automatic timer recording.
- If there is a power failure of more than 3 minutes during a timer recording, the recording does not resume after power is restored.
- If there is a power failure of more than 3 minutes before a programmed start time, the VCR loses the clock setting and therefore does not start automatic timer recording. However, if you have an EDS channel in your area and set the VCR to automatically set the clock from the EDS signal, the clock is reset within 10 minutes after power is restored, and the VCR records at the programmed time(s).

Setting the Program Timer

Note: To program the timers, you can use the VCR's front panel buttons instead of the remote control. Use **PLAY** as **SEL s**, **REW** as **SEL t**, and **FF** as **SET**.

1. Turn on the VCR and the TV.

Note: If you use a TV/monitor that is connected to the VCR's **AUDIO/VIDEO OUT** jacks, set it to the video mode and skip Steps 2 and 3.

2. Set the TV to the same channel as the VCR's **3 CH. 4** switch.
3. Press **TV/VCR** until the VCR displays VCR.
4. (Model 60 only) Set the audio recording mode to the desired setting. See "Receiving/Recording Stereo/SAP Broadcasts (Model 60 Only)" on Page 27.
5. Insert a blank cassette, or one that you want to record over, into the VCR.
6. Press **PROG** on the remote control. The TV displays the timer setting menu.

Note: If the clock is not set, the screen shows **PLEASE SET CLOCK BEFORE PROGRAMMING** and then goes to the clock-setting screen. Set the clock as described under "Manually Setting the Clock" on Page 16.

7. If you have already entered a program(s), the current settings for the first four programs appear on the display. Press **SEL s/t** to select an empty program number, then press **SET**. The TV displays the program menu.



If you have not yet entered any programs, the TV displays the program entry menu when you press **PROG**.

8. Use **SEL** s/t to select the date when you want to record.

To record a program at the same time on the same day every week, press either button until the TV displays **WEEKLY** and the desired day of the week.

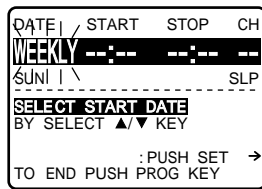

To record a program at the same time Monday through Friday, press either button until the TV displays **DAILY MON-FRI**.

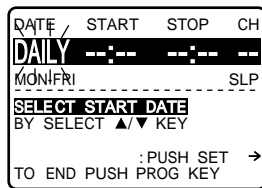

To record a program at a set time today, press either button until the TV displays **TODAY** and today's date.

To record a program at a specific time and date, press **SEL** s/t to select the specific date.

Press **SET** to enter your selection.

9. Use **SEL** s/t to select the start hour. When the correct hour appears, press **SET**. Then use **SEL** s/t to select the minute, and press **SET**.
10. Repeat Step 9 to set the end time.
11. Use **SEL** s/t to select the channel.

To record from a source connected to the **AUDIO 1/VIDEO 1 IN** (or **AV2** for the Model 60) jacks, press **SEL** s/t until the TV displays **L** (**L1** or **L2** on the Model 60).

12. Use **SEL** s/t to select the tape speed (**SP**, **LP**, or **EP**).

13. Double-check all the set information.

- If the information is correct, press **PROG**.
- If an entry is not correct, press **SET** or **CLEAR** to move the cursor to the wrong entry, enter the correct information, then press **PROG**.

Note: The TV displays **PROGRAM IS INCOMPLETE** if you did not correctly enter a timer program before pressing **PROG**. Check and correct the program, then press **PROG** again.

The TV displays the timer program settings. To enter more programs, use **SEL** s/t to select another program number and repeat Steps 7–13.

14. Press **PROG** again. The TV briefly displays **TURN VCR OFF FOR TIMER RECORDING**.
15. Press **POWER** to turn off the VCR. The VCR displays **TIMER**.

Notes:

- Be sure that the VCR displays **TIMER** when you turn it off. If it does not appear, check your programming.
- If you insert a cassette with its erase-protection tab removed and set the VCR's timer, the VCR ejects the cassette and flashes **TIMER** on the display.
- If you set up the VCR to record a cable program through a cable box, be sure to leave the cable box turned on and tuned to the desired station before the timer program starts.
- You can manually turn on and operate the VCR before the set times, but the VCR starts an automatic timer recording only if the power is off at the set start time.

Monitoring an Automatic Timer Recording

1. Turn on the TV and set it to the same channel as the VCR's **3 CH. 4** switch.

Note: If you are using a TV/monitor that is connected to the VCR's **AUDIO/VIDEO OUT** jacks, set the TV/monitor to the video mode.

2. Press **TV/VCR** until the VCR displays VCR.

Checking/Changing Program Timers

1. Turn on the TV and set it to the same channel as the VCR's **3 CH. 4** switch.

Note: If you are using a TV/monitor that is connected to the VCR's **AUDIO/VIDEO OUT** jacks, set the TV/monitor to the video mode.

2. Turn on the VCR and press **TV/VCR** until the VCR displays VCR.
3. Press **PROG**. The TV displays the first four programs.

P	DT	STRAT	STOP	CH	SPD
1	DAY	9:00A	12:00A	08	SP
2	8	10:00P	12:00P	125	SLP
3	10	8:00P	9:00P	10	SP
4	SU	9:00P	10:00P	L	SLP

SELECT 1-8 : PUSH ▲/▼ KEY
 ENTER : PUSH SET KEY
 CANCEL : PUSH CLEAR KEY
 END : PUSH PROG KEY

4. Select the program you want to change using **SEL** s/t, then press **SET**.
5. Follow Steps 8–12 under “Setting the Program Timer” on Page 29 to correct the entry you want.
6. After checking or correcting a program, press **PROG** again, then turn off the VCR.

Clearing a Program Timer

If the timer recording has not yet started:

1. Follow Steps 1–3 under “Checking/Changing Program Timers.”
2. Highlight the program you want to clear, then press **CLEAR**.
3. Press **PROG** to return to the normal screen.

Turn off the VCR if you still have at least one timer program entered.

If a timer recording is in progress:

1. Press **POWER** to stop timer recording. The TV displays **TO CANCEL TIMER REC PUSH POWER THEN STOP KEY** if are watching the signal from the VCR.
2. Within 10 seconds, press **STOP**. **TIMER** disappears from the VCR's display.

DUBBING

The process of recording from one audio/video device to another is called dubbing.

An audio/video device where a signal originates is called the dubbing source. You can use another VCR, camcorder, satellite receiver, or other device with A/V outputs as the dubbing source, connect the dubbing source and the VCR, then use your VCR to record the signal from the dubbing source.

Or, you can use this VCR as the dubbing source for another VCR. See "Installation" for the various possible connections.

Notes:

- Always use video-quality shielded cables with phono-type connectors to connect the device to the VCR. Do not use standard audio patch cords.
- Most material performed in public, such as concerts, plays, and movies, or distributed on prerecorded video tapes is copyrighted. The unauthorized recording or duplication of copyrighted material is a violation of the copyright laws of most countries and such duplication may result in fines, imprisonment, or both. Note, however, that in the United States, it is not a violation of U.S. copyright laws for a consumer to record a broadcast television program for private (in-home) viewing.

To dub a tape, start the program playing on the dubbing source (see that device's instructions) and start recording on the recording VCR, following its recording instructions.

AUDIO-ONLY RECORDING (MODEL 60 ONLY)

Because of the superior quality of VHS Hi-Fi audio recordings, you might want to use your VCR as an audio-only recorder. You can also make live recordings by connecting a pre-amplifier or mixer to the VCR's **AUDIO IN** jacks. Simply select the line input and record as usual.

Caution: Do not directly connect a microphone to the VCR.

Note: For the best audio fidelity, we recommend you use high-quality video tape (such as Cat. No. 44-410) to make audio-only recordings.

ADDITIONAL INFORMATION

TROUBLESHOOTING

If you follow the instructions in this manual and still have trouble operating your VCR, refer to the following troubleshooting chart.

PROBLEM	POSSIBLE SOLUTION
No power.	The power cord is not connected. Plug the power cord into an AC outlet.
Cannot make a timer recording.	<ul style="list-style-type: none"> The program timer is not set or is set incorrectly. Check the program timer. The power is on. Turn off the power.
Cannot record.	The erase-protection tab is missing. Place a piece of tape over the tab hole.
Picture is poor on playback.	<ul style="list-style-type: none"> The TV's channel selector is not set to the proper channel. Set the TV to Channel 3 or 4. The TV's fine tuning is not set correctly. Fine tune your TV. Audio/video connections are incorrect. Check all connections.
The playback picture is distorted.	<ul style="list-style-type: none"> The video heads are dirty. See "Cleaning the Video Heads" on Page 35. Tracking is not properly adjusted. Adjust the tracking.
No picture on playback.	<ul style="list-style-type: none"> The TV is not set to the proper channel. Set it to Channel 3 or 4 or to its audio/video input if you connected it to the VCR's AUDIO/VIDEO OUT jacks. Audio/video connections are incorrect. Check all connections.
Remote control buttons do not work when the power is on and a cassette is inserted.	<ul style="list-style-type: none"> The remote control's batteries might be weak. Replace the batteries. Something is blocking the path from the remote control to the VCR. Bright light is shining on the VCR's remote control sensor window. Come closer to the VCR, or change the VCR's location.
Cannot see broadcast TV programs using the VCR's tuner.	<ul style="list-style-type: none"> TV/VCR is not set correctly. Press TV/VCR so the VCR displays VCR. Audio/video connections are incorrect. Check all connections.
Cannot record from the input jacks.	<ul style="list-style-type: none"> Connections are incorrect. Use shielded audio/video cables with phono-type connectors to connect the source to the VCR's input jacks. INPUT is not set correctly. Select L (L1 or L2 for the Model 60).
No stereo sound for a stereo recording (Model 60 only).	<ul style="list-style-type: none"> You have not connected the VCR's AUDIO OUT jacks to a stereo system or stereo TV. Connect the jacks to a stereo output. The audio out setting is not correctly set. Set it to STEREO. The tracking is not properly adjusted. Adjust the tracking.

CARE AND MAINTENANCE

Your Optimus Model 110 4-Head VHS HQ VCR/Model 60 4-Head VHS HQ Stereo Hi-Fi VCR is an example of superior design and craftsmanship. The following suggestions will help you care for the VCR so you can enjoy it for years.



Keep the VCR dry. If it gets wet, wipe it dry immediately. Liquids might contain minerals that can corrode the electronic circuits.



Use and store the VCR only in normal temperature environments. Temperature extremes can shorten the life of electronic devices and distort or melt plastic parts.



Keep the VCR away from dust and dirt, which can cause premature wear of parts.



Handle the VCR gently and carefully. Dropping it can damage circuit boards and cases and can cause the VCR to work improperly.



Use only fresh batteries of the required size and type. Old batteries can leak chemicals that damage your VCR remote control's electronic parts.



Wipe the VCR with a damp cloth occasionally to keep it looking new. Do not use harsh chemicals, cleaning solvents, or strong detergents to clean the VCR.

Modifying or tampering with the VCR's internal components can cause a malfunction and might invalidate your VCR's warranty (and void your FCC authorization to operate it). If your VCR is not performing as it should, take it to your local RadioShack store for assistance.

Servicing Your VCR

There are no user-serviceable parts inside your VCR. If you encounter a problem that you cannot correct using this manual and its troubleshooting guide, take the VCR to your local RadioShack store for assistance.

Cleaning the Video Heads

Dirty video heads can cause the playback picture to become blurred even though the audio signal is clear. Video head cleaning kits are available from your local RadioShack store. Clean the heads only when picture quality is affected.

Serious problems require cleaning by a trained technician. For more head cleaning information, contact your local RadioShack store.

Storing Your Video Cassettes

Unless you are making an automatic timer recording, eject and store the cassette before you turn off the VCR. This helps protect the cassette and the VCR's internal mechanisms.

Place your video cassettes in their protective boxes and store them in a cool, dry, dust-free environment. Store the cassettes on end, not on their sides, to prevent improper settling of the cassette's spools.

Note: Tape can become wound too tightly around the cassette's spools after many playings. This can make the cassette improperly load and automatically eject when you insert it. On most cassettes there is a brake-release plunger on the bottom center of the cassette. Use the tip of a pen or pencil to press the plunger. This loosens the tape.

SPECIFICATIONS

Television System	NTSC Standard Color Signal
Recording System.....	Four-Head Double Azimuth
Tape Width	1/2 Inch
Tape Speed:	
SP.....	1.31 Inch/second (33.35 mm/s)
LP	0.65 Inch/second (16.67 mm/s)
EP.....	0.43 Inch/second (11.12 mm/s)
Tuner Channels:	
VHF	2-13
UHF	14-69
CATV	125
RF Converter	Built-in VHF Converter
Converter Output	Channel 3 or 4
Terminals:	
Antenna Input	VHF/UHF: F Type
Antenna Output	VHF/UHF: F Type
Video Input/Output.....	Phono Connector
Audio Input/Output.....	Phono Connector
Video Output Level	1.0 V _{p-p}
Video Output Impedance	75 Ω
Audio Output Level	-8 dBV
Audio Output Impedance	1 kΩ
Video Input Level	0.5-2.0 V _{p-p}
Video Input Impedance	50 kΩ
Audio Input Level	-10 dBV
Audio Input Impedance	47 kΩ
Video S/N Ratio (weighted):	
SP.....	42 dB
EP.....	40 dB
Audio S/N Ratio:	
Regular Audio (weighted)	
SP.....	43 dB
EP.....	40 dB
Hi-Fi Audio (Model 60 only): (Dynamic Range):	
SP.....	More than 90 dB
LP	More than 90 dB
EP.....	More than 90 dB

Frequency Response:

Regular Audio

SP 80 Hz–10 kHz

EP 80 Hz–5 kHz

Hi-Fi Audio (Model 60 only) In All Modes 20 Hz–20kHz

Power Requirement 120 V, 60 Hz

Power Consumption

Model 110 18 Watts

Model 60 23 Watts

Dimensions (H x W x D) 3¹/₂ × 14³/₁₆ × 11¹/₄ Inches (8.9 × 36 × 28.5 cm)

Weight:

Model 110 7 lbs, 15 oz (3.6 kg)

Model 60 8 lbs, 3 oz (3.7 kg)

Specifications are typical; individual units may vary. Specifications are subject to change and improvement without notice.



NOTES

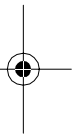
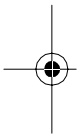

RadioShack Limited Warranty

This product is warranted against defects for 90 days from date of purchase from RadioShack company-owned stores and authorized RadioShack franchisees and dealers. Within this period, we will repair it without charge for parts and labor. Simply **bring your RadioShack sales slip** as proof of purchase date to any RadioShack store. Warranty does not cover transportation costs. Nor does it cover a product subjected to misuse or accidental damage.

EXCEPT AS PROVIDED HEREIN, RadioShack MAKES NO EXPRESS WARRANTIES AND ANY IMPLIED WARRANTIES ARE LIMITED IN DURATION TO THE DURATION OF THE WRITTEN LIMITED WARRANTIES CONTAINED HEREIN. Some states do not permit limitation or exclusion of implied warranties; therefore, the aforesaid limitation(s) or exclusion(s) may not apply to the purchaser.

This warranty gives you specific legal rights and you may also have other rights which vary from state to state.

We Service What We Sell

10/95

RadioShack
A Division of Tandy Corporation
Fort Worth, Texas 76102

7A6

TINS-2860AJZZ
Printed in Malaysia

Free Manuals Download Website

<http://myh66.com>

<http://usermanuals.us>

<http://www.somanuals.com>

<http://www.4manuals.cc>

<http://www.manual-lib.com>

<http://www.404manual.com>

<http://www.luxmanual.com>

<http://aubethermostatmanual.com>

Golf course search by state

<http://golfingnear.com>

Email search by domain

<http://emailbydomain.com>

Auto manuals search

<http://auto.somanuals.com>

TV manuals search

<http://tv.somanuals.com>