

OPTIMUS®

Please read before using this equipment.

SCP-101

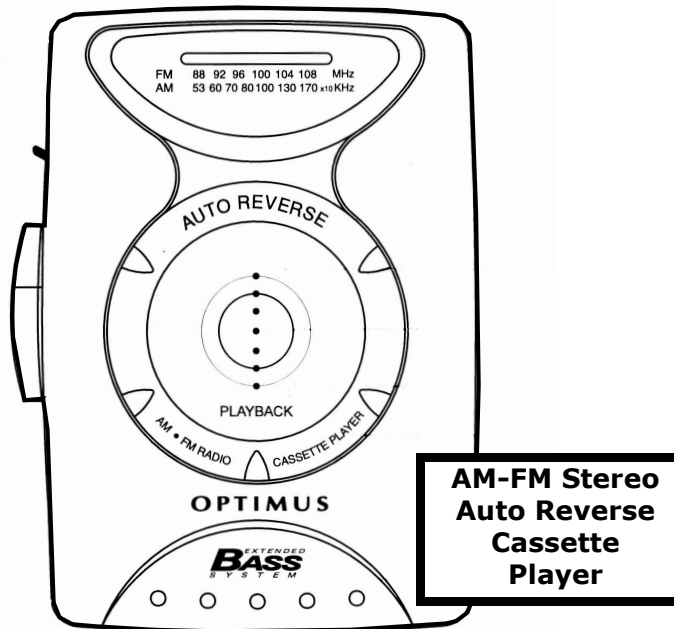

OWNER'S MANUAL

FEATURES

Your Optimus SCP-101 AM-FM Stereo Cassette Player is lightweight, compact in size, convenient for carrying anywhere, and easy to operate. It delivers excellent sound through your stereo headphones or speakers and includes these features:

Auto Reverse — automatically and continuously plays the second side of a tape when the first side ends.

Extended Bass System — provides richer, fuller bass.

Full Scale Dial Pointer Tuning — lets you quickly find your favorite station.

Three Power Sources — let you power the SCP-101 from AA batteries (not supplied), standard AC power (requires an AC adapter, not supplied), or vehicle DC power (requires a DC adapter, not supplied).

Removable Belt Clip — lets you take the SCP-101 anywhere you go.

Note: Your Optimus SCP-101 requires either external speakers or headphones (neither supplied) for listening.

© 1999 Tandy Corporation.
All Rights Reserved.
RadioShack, Optimus, and Adaptaplug are
registered trademarks used by Tandy Corporation.

CONTENTS

Preparation	4
Connecting Power	4
Using Internal Batteries	4
Using AC Power	6
Using Vehicle Battery Power	7
Connecting Headphones/Speakers	9
Listening Safely	10
Traffic Safety	10
Using the Belt Clip	11
Radio Operation	12
Cassette Player Operation	13
Playing a Cassette Tape	13
Using Fast Forward/Rewind	15
Tape Tips	16
Storing Cassette Tapes	16
Restoring Tape Tension and Sound Quality	16
Care and Maintenance	17
Cleaning the Tape-Handling Parts	17
FCC Information	19
Specifications	20

PREPARATION

CONNECTING POWER

The SCP-101 operates from any of these power sources:

- internal batteries (not supplied)
- standard AC power (using an optional AC adapter)
- vehicle battery power (using an optional DC adapter)

Using Internal Batteries

Your SCP-101 requires two AA batteries (not supplied for power. For the best performance and longest life, we recommend RadioShack alkaline batteries.

Cautions:

- Use only fresh batteries of the required size and recommended type.
- Do not mix old and new batteries, different types of batteries (standard, alkaline, or rechargeable) or rechargeable batteries of different capacities.

Follow these steps to install batteries.

1. Press and slide the battery compartment cover in the direction of the arrow until it stops.

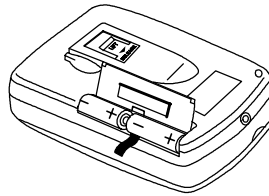

2. Lift the curved edge of the cover.

Caution: The battery compartment cover is hinged and cannot be removed.

3. Place the batteries in the compartment and on top of the attached ribbon, as indicated by the polarity symbols (+ and -) marked on outside the compartment.
4. Close the cover.

When the sound gets distorted or weak, or the SCP-101 stops operating properly, replace the batteries.

Warning: Dispose of old batteries promptly and properly. Do not burn or bury them.

Caution: If you do not plan to use the SCP-101 with batteries for a week or more, or if you plan to use only stan-

standard AC or vehicle power, remove the batteries. Batteries can leak chemicals that can destroy electronic parts.

USING AC POWER

You can power the SCP-101 using a 3V, 300-mA AC adapter and a size H Adaptaplug® (neither supplied). Both are available at your local RadioShack store.

Cautions:



You must use a Class 2 power source that supplies 3V DC and delivers at least 300 mA. Its center tip must be set to positive and its plug must fit the SCP-101's **DC 3V** jack. Using an adapter that does not meet these specifications could damage the SCP-101 or the adapter.

- Always connect the AC adapter to the SCP-101 before you connect it to AC power. When you finish, disconnect the adapter from AC power before you disconnect it from the SCP-101.

Follow these steps to power the SCP-101 from standard AC power.

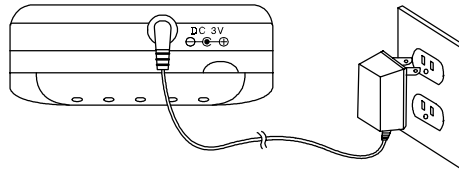

1. If the adapter has a voltage switch, set the switch to 3V.
2. Insert the Adaptaplug into the adapter's cord so it reads TIP +.
3. Insert the Adaptaplug into the SCP-101's **DC 3V** jack.
4. Plug the adapter into a standard AC outlet.

Note: Connecting an adapter to the SCP-101's **DC 3V** jack disconnects the internal batteries.

USING VEHICLE BATTERY POWER

You can power the SCP-101 from a vehicle's 12V power source (such as cigarette-lighter socket) using a 3V, 300-mA DC adapter and a size H Adaptaplug (neither supplied). Both are available at your local RadioShack store.

Cautions:



You must use a power source that supplies 3V DC and delivers at least 300 mA. Its center tip must be set to positive and its plug must fit the SCP-101's **DC 3V** jack. Using an adapter that does not meet these specifications could damage the SCP-101 or the adapter.

- Always connect the DC adapter to the SCP-101 before you connect it to the power source. When you finish, disconnect the adapter from the power source before you disconnect it from the SCP-101.

Follow these steps to power the SCP-101 from DC power.

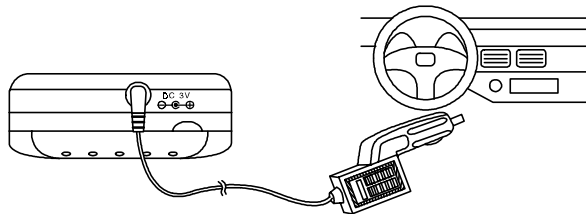

1. If the adapter has a voltage switch, set the switch to 3V.
2. Insert the Adaptaplug into the adapter's cord so it reads TIP+.

3. Insert the Adaptaplug into the SCP-101's **DC 3V** jack.

Note: Connecting an adapter to the SCP-101's **DC 3V** jack disconnects the internal batteries.

4. Plug the other end of the DC adapter into the vehicle's cigarette-lighter socket.

CONNECTING HEADPHONES/ SPEAKERS

To listen to the SCP-101, connect stereo headphones or amplified speakers (neither supplied) equipped with a 1/8-inch (3.5-mm) stereo plug to **PHONES**. Your local RadioShack store sells a wide variety of stereo headphones and amplified speakers.

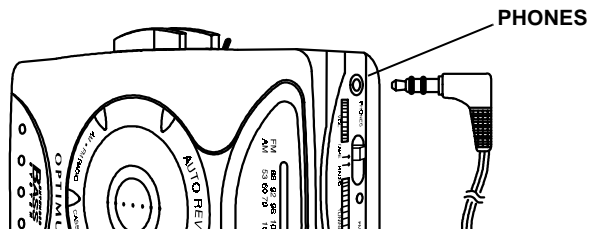



Listening Safely

To protect your hearing, follow these guidelines when you use headphones.

- Set the volume to the lowest setting before you begin listening. After you begin listening, adjust the volume to a comfortable level.
- Do not listen at extremely high volume levels. Extended high-volume listening can lead to permanent hearing loss.
- Once you set the volume, do not increase it. Over time your ears adapt to the volume level, so a volume level that does not cause discomfort might still damage your hearing.

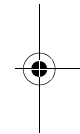
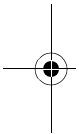

Traffic Safety

- Do not wear headphones while operating a motor vehicle or riding a bicycle. This can cause a traffic hazard and could be illegal in some areas.
- Even though some headphones are designed to let you hear outside sounds when you listen at normal volume levels, they still can present a traffic hazard.

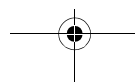

USING THE BELT CLIP

For hands-free carrying, install the supplied belt clip.

To install the belt clip, place it below and between the two guides on the back of the player. Then slide the clip in the opposite direction of the arrow until it snaps into place.

To remove the belt clip, lift the tab at the point marked **LIFT**, then slide the clip in the direction of the arrow.

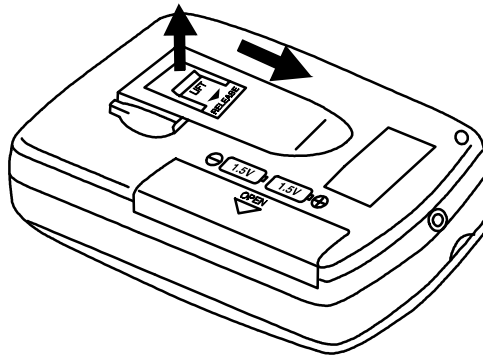

RADIO OPERATION

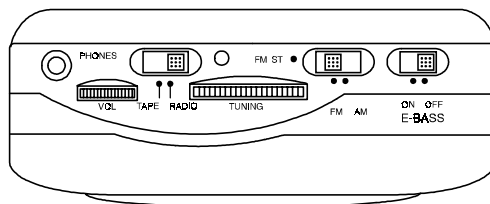

Follow these steps to set up, tune and play the radio.

1. Connect either headphones or amplified speakers to **PHONES**.
2. Set **TAPE/RADIO** to **RADIO**.
3. Set **FM ST/FM/AM** to the desired band.
4. Adjust **VOL** to the desired listening level.
5. Turn **TUNING** to select the station.

Notes:

- If you set the radio to **FMST**, FM ST (FM Stereo) lights when you receive a stereo FM broadcast.
 - To improve the reception of a weak FM station, set **FM ST/FM/AM** to **FM**. The signal changes from stereo to monaural, and reception generally improves.
 - Set **E-BASS** to **ON** for an enhanced bass effect. Set it to **OFF** for normal bass sound.
6. To turn off the radio, set **TAPE/RADIO** to **TAPE**.

CASSETTE PLAYER OPERATION

PLAYING A CASSETTE TAPE

Note: A cardboard tab in the cassette compartment protects the tape-handling parts during shipping. Remove the tab before you insert a cassette tape.

Follow these steps to play a cassette tape.

1. Connect either headphones or amplified speakers to **PHONES**.
2. Take up any slack in the tape by turning the cassette's hub with a pencil. Do not touch the exposed tape.

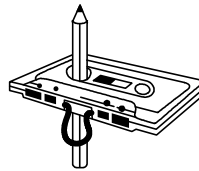

3. Lift open the cassette compartment door.

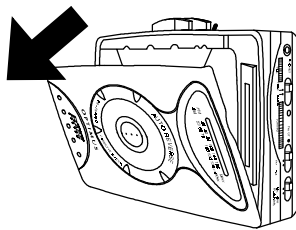

4. Insert the cassette tape into the cassette guides with the open edge facing up.

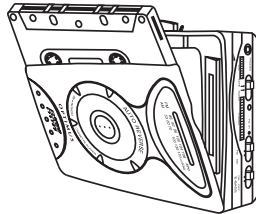

5. Close the compartment door.
6. Set **TAPE/RADIO** to **TAPE**.
7. Press ◀▶ . The tape begins play.

Note: When the tape finishes playing side one, it automatically reverses direction and plays side two. To manually change the tape direction, slide **DIRECTION** to its other position.

8. Adjust **VOL.** to the desired listening level.

Note: Set **E-BASS** to **ON** for an enhanced bass effect. Set it to **OFF** for normal bass sound.

9. To stop playback, press ■.

USING FAST FORWARD/REWIND

To fast forward the tape, press ►► in the same direction as the tape is playing.

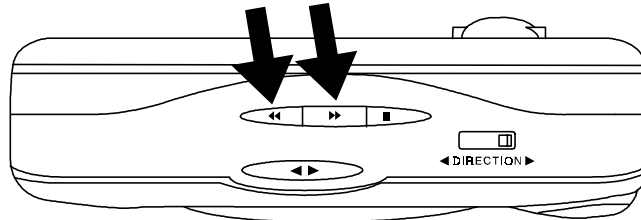

To rewind the tape, press ◀◀ in the opposite direction of play.

To stop the tape, press ■.



TAPE TIPS

STORING CASSETTE TAPES

Do not expose cassette tapes to high temperatures, high humidity, dust or dirt, or motors, transformers, or other sources of strong magnetic fields.

RESTORING TAPE TENSION AND SOUND QUALITY

After you play a cassette tape several times, the tape might become tightly wound on the reels. This can cause playback sound quality to deteriorate.

To restore the sound quality, fast forward the tape from the beginning to the end of one side, then completely rewind it. Then loosen the tape reels by gently tapping each side of the cassette's outer shell on a flat surface.

Caution: Be careful not to damage the cassette when tapping it. Do not touch the exposed tape or allow any sharp objects near the cassette.

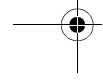
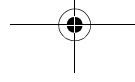
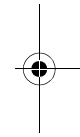
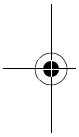

CARE AND MAINTENANCE

Your Optimus SCP-101 AM-FM Stereo Cassette Player is an example of superior design and craftsmanship. The following suggestions will help you care for the SCP-101 so you can enjoy it for years.

- Keep the SCP-101 dry. If it gets wet, wipe it dry immediately.
- Use and store the SCP-101 only in normal temperature environments.
- Handle the SCP-101 gently and carefully. Don't drop it.
- Keep the SCP-101 away from dust and dirt.
- Wipe the SCP-101 with a damp cloth occasionally to keep it looking new.

Modifying or tampering with the SCP-101's internal components can cause a malfunction and might invalidate its warranty. If your SCP-101 is not performing as it should, take it to your local RadioShack store for assistance.

CLEANING THE TAPE-HANDLING PARTS

Dirt, dust, or particles of the tape's coating can accumulate on the tape head and other parts that the tape touches. This can greatly reduce the SCP-101's performance.

After every 20 hours of tape player operation, follow these steps to clean the tape-handling parts or use a RadioShack cassette deck cleaning kit.

1. Remove the batteries and disconnect any other power source.
2. Open the cassette compartment door, remove any cassette tape inside and set **TAPE/ RADIO** to **TAPE**.
3. Press ◀▶ to expose the tape head.
4. Use a cotton swab dipped in tape head-cleaning solution or denatured alcohol to gently clean the capstans, tape guides, pinch rollers, and tape head.

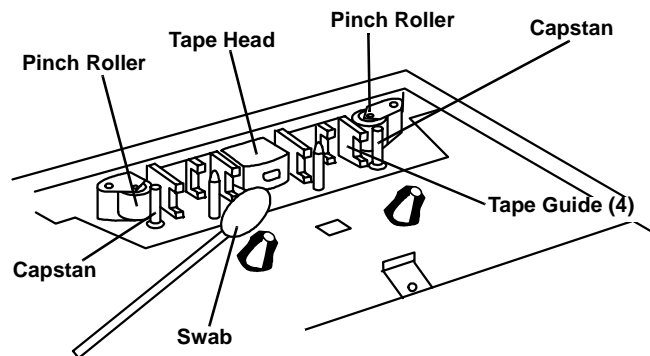

5. When you finish cleaning, press ■ and close the compartment door, then reconnect power.

FCC INFORMATION

The SCP-101 complies with the limits for a Class B digital device as specified in Part 15 of *FCC Rules*. These limits provide reasonable protection against radio and TV interference in a residential area. However, your SCP-101 might cause TV or radio interference even when it is operating properly. To see if your SCP-101 is causing the interference, turn it off. If the interference goes away, your SCP-101 is causing it. To eliminate interference, try the following:

- Increase the distance between the SCP-101 and the radio or TV.
- Use outlets on different electrical circuits for the SCP-101 and the radio or TV.

Consult your local RadioShack store if the problem still exists.

SPECIFICATIONS

RADIO

Frequency Range:

FM..... 88–108 MHz

AM..... 530–1710 kHz

Antennas:

FM..... Headphone or Speaker Wire

AM..... Bar Coil

CASSETTE PLAYER

Tape System 4-Track, 2-Channel Stereo

Frequency Response 125Hz–6,000 KHz

Wow and Flutter 0.4%

Tape Speed 1⁷/₈ Inches per Second

Signal-to-Noise Ratio 40 dB

GENERAL

Power Output 10mW into 32 ohms
32ohms/1KHz/3% THD

Power Requirements..... 3 Volts DC,
Two AA Batteries
3 Volt AC Adapter (optional)
3 Volt DC Adapter (optional)

Typical Battery Life (with Alkaline Batteries) 14 Hours

Dimensions (max)..... 4.96 × 3.68 × 1.63 Inches
(126 × 93.6 × 41.35mm)

Weight (without batteries) 6.5 oz
(185 g)

Specifications are typical; individual units might vary.
Specifications are subject to change and improvement
without notice.

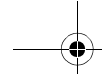

NOTES

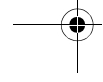
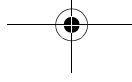
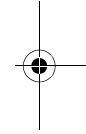
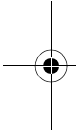

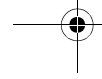
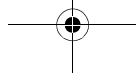
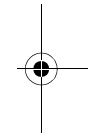
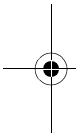
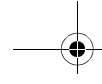

Limited Ninety-Day Warranty

This product is warranted by RadioShack against manufacturing defects in material and workmanship under normal use for ninety (90) days from the date of purchase from RadioShack company-owned stores and authorized RadioShack franchisees and dealers. EXCEPT AS PROVIDED HEREIN, RadioShack MAKES NO EXPRESS WARRANTIES AND ANY IMPLIED WARRANTIES, INCLUDING THOSE OF MERCHANTABILITY AND FITNESS FOR A PARTICULAR PURPOSE, ARE LIMITED IN DURATION TO THE DURATION OF THE WRITTEN LIMITED WARRANTIES CONTAINED HEREIN. EXCEPT AS PROVIDED HEREIN, RadioShack SHALL HAVE NO LIABILITY OR RESPONSIBILITY TO CUSTOMER OR ANY OTHER PERSON OR ENTITY WITH RESPECT TO ANY LIABILITY, LOSS OR DAMAGE CAUSED DIRECTLY OR INDIRECTLY BY USE OR PERFORMANCE OF THE PRODUCT OR ARISING OUT OF ANY BREACH OF THIS WARRANTY, INCLUDING, BUT NOT LIMITED TO, ANY DAMAGES RESULTING FROM INCONVENIENCE, LOSS OF TIME, DATA, PROPERTY, REVENUE, OR PROFIT OR ANY INDIRECT, SPECIAL, INCIDENTAL, OR CONSEQUENTIAL DAMAGES, EVEN IF RadioShack HAS BEEN ADVISED OF THE POSSIBILITY OF SUCH DAMAGES.

Some states do not allow the limitations on how long an implied warranty lasts or the exclusion of incidental or consequential damages, so the above limitations or exclusions may not apply to you.

In the event of a product defect during the warranty period, take the product and the RadioShack sales receipt as proof of purchase date to any RadioShack store. RadioShack will, at its option, unless otherwise provided by law: (a) correct the defect by product repair without charge for parts and labor; (b) replace the product with one of the same or similar design; or (c) refund the purchase price. All replaced parts and products, and products on which a refund is made, become the property of RadioShack. New or reconditioned parts and products may be used in the performance of warranty service. Repaired or replaced parts and products are warranted for the remainder of the original warranty period. You will be charged for repair or replacement of the product made after the expiration of the warranty period.

This warranty does not cover: (a) damage or failure caused by or attributable to acts of God, abuse, accident, misuse, improper or abnormal usage, failure to follow instructions, improper installation or maintenance, alteration, lightning or other incidence of excess voltage or current; (b) any repairs other than those provided by a RadioShack Authorized Service Facility; (c) consumables such as fuses or batteries; (d) cosmetic damage; (e) transportation, shipping or insurance costs; or (f) costs of product removal, installation, set-up service adjustment or reinstallation.

This warranty gives you specific legal rights, and you may also have other rights which vary from state to state.

RadioShack Customer Relations, 200 Taylor Street, 6th Floor, Fort Worth, TX 76102

We Service What We Sell

04/99

07A99

Printed in Hong Kong
Cat. No. 14-1253

Free Manuals Download Website

<http://myh66.com>

<http://usermanuals.us>

<http://www.somanuals.com>

<http://www.4manuals.cc>

<http://www.manual-lib.com>

<http://www.404manual.com>

<http://www.luxmanual.com>

<http://aubethermostatmanual.com>

Golf course search by state

<http://golfingnear.com>

Email search by domain

<http://emailbydomain.com>

Auto manuals search

<http://auto.somanuals.com>

TV manuals search

<http://tv.somanuals.com>