

Cat. No. 42-4041  
**OWNER'S MANUAL**

Please read before using this equipment.

# Electronic Keyboard

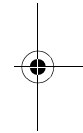
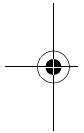

**MD-1200**

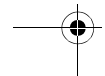
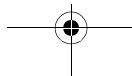

**OPTIMUS®**



**WARNING:** To reduce the risk of fire or shock hazard, do not expose this product to rain or moisture.

	<b>CAUTION</b> RISK OF ELECTRIC SHOCK. DO NOT OPEN.	
<b>CAUTION:</b> TO REDUCE THE RISK OF ELECTRIC SHOCK, DO NOT REMOVE COVER OR BACK. NO USER-SERVICEABLE PARTS INSIDE. REFER SERVICING TO QUALIFIED PERSONNEL.		



This symbol is intended to alert you to the presence of uninsulated dangerous voltage within the product's enclosure that might be of sufficient magnitude to constitute a risk of electric shock. Do not open the product's case.



This symbol is intended to inform you that important operating and maintenance instructions are included in the literature accompanying this product.

## THE FCC WANTS YOU TO KNOW

This keyboard complies with the limits for a Class B digital device as specified in Part 15 of *FCC Rules*. These limits provide reasonable protection against radio and TV interference in a residential area. However, your keyboard might cause TV or radio interference even when it is operating properly. To eliminate interference, you can try one or both of these corrective measures:

- increase the distance between the keyboard and the radio or TV
- use outlets on different electrical circuits for the keyboard and the radio or TV

Consult your local RadioShack store if the problem still exists.

We recommend you write your MD-1200's serial number here. The number is on the bottom of the MD-1200.

Serial Number \_\_\_\_\_

© 1999 Tandy Corporation.  
All Rights Reserved.  
Optimus and RadioShack are registered trademarks used by Tandy Corporation.

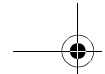

## FEATURES

---



Your Optimus MD-1200 Electronic Keyboard is a state-of-the-art musical instrument that offers you a vast array of sounds. You can choose from 200 different musical instruments or sound effects and 100 rhythms, as well as automatic accompaniments and percussion sounds.

The MD-1200 also includes a MIDI feature (Musical Instrument Digital Interface), which lets you connect it to other MIDI-equipped musical instruments or devices — even your personal computer! This versatile keyboard can provide hours of fun and is ideal for anyone who wants to make music, from the beginner to the experienced musician.

**Note:** The MD-1200 conforms to most, but not all, General MIDI specifications. Therefore, you might experience some incompatibility when using the MD-1200 with another General MIDI device. For more information, see “Using MIDI” on Page 41.

Your MD-1200's features include:

**61 Full-Size Keys with Touch Response** — the keyboard's volume varies in response to the force of your touch, just like an acoustic piano or organ, so you can add emotion to your music.

**Backlit Liquid Crystal Display** — shows the notes and chords as you play them, along with the current tone, rhythm, and tempo. The built-in backlight makes it easy to read the display even in darkness.

**24-Note Polyphonic Sound** — lets you play and hear up to 24 notes at the same time, so you can play or create almost any type of music.

**Memory** — lets you set the MD-1200 to record up to 2 songs, 6 tracks, and 5,200 notes. The recording remains stored even while the keyboard is off.

**Pitch Bender Wheel** — lets you bend a note by altering its pitch to create realistic effects for reed instrument or guitar tones.

**200 Tones** — let you set your MD-1200 to sound like anything from a harpsichord to a honky-tonk piano. You can even create your own tones with the custom tone synthesizer feature.

**100 Auto-Rhythms** — provide a steady beat for many styles of music, from rumba to rock.

**Headphones/Output Jack** — lets you connect headphones so you can play without disturbing others, or an external amplifier so you can play for a crowd (neither supplied).

**Assignable Jack** — lets you connect a sustain pedal (not supplied) to the MD-1200 so you can sustain or soften your keyboard's sound, or start/stop an auto-rhythm.

**100 Free Sessions** — let you set the MD-1200 to automatically play an accompaniment consisting of a prerecorded chord progression with a matching rhythm.

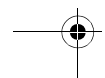
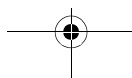
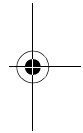
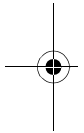



---

**Synthesizer Function** — lets you create up to 32 of your own original tones.

**Tune Function** — lets you adjust the pitch of your keyboard so you can play in tune with other instruments.

**Transpose Function** — lets you instantly change the key of music, even when you are playing.

**Tempo Control** — lets you speed up or slow down the tempo of any selected music pattern.

**Fill-In Rhythm** — lets you insert a short variation into any auto-rhythm.

**Auto Accompaniment** — lets you automatically play a preset harmonic pattern to match the selected auto-rhythm.

**Reverb** — lets you add depth and space to the sound.

**Layer Function** — lets you set the keyboard to play two different tones at the same time, giving your music a “layered” effect.

**Split Function** — lets you use different sounds for the low-end and high-end keys.

**Mixer Function** — lets you make the MD-1200 sound multiple tones for auto accompaniment, memory playback, or to play MIDI data received from another MIDI device.

**Automatic Intro/Ending Rhythm** — lets you set the MD-1200 to automatically add a 3- to 8-measure introduction or 3- to 8-measure ending to the selected auto-rhythm.

**Drum Pads** — play drum sounds regardless of the keyboard's tone setting.

**Two Built-In Speakers** — let you hear the sound you create.

**Two Power Options** — let you power the keyboard from internal batteries (not supplied) or standard AC power (with an optional adapter), so you can make music almost anywhere.

**Notes:**

- If the keyboard is left in one place for a very long time, its feet could mar your furniture's finish. We recommend you place the feet on felt cloth pads to protect your furniture or use a keyboard stand, available at your local RadioShack store.
- This Owner's Manual explains how to use this electronic keyboard. It does not teach music.

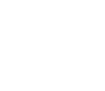
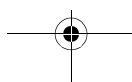
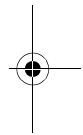
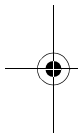

# CONTENTS

---

<b>Preparation .....</b>	<b>7</b>
Connecting Power .....	7
Using Batteries .....	7
Using AC Power .....	8
Connecting Headphones .....	8
Listening Safely .....	8
Connecting an External Amplifier .....	9
Using the Music Stand .....	9
<b>Operation .....</b>	<b>10</b>
Basic Operation .....	10
Playing the Demonstration Tunes .....	10
Using the Preset Tones .....	11
Using the Drum Pads .....	13
Using Reverb .....	13
Using Split .....	13
Using Layer .....	14
Using Split and Layer Together .....	14
Using the Preset Auto-Rhythms .....	15
Selecting/Playing an Auto-Rhythm .....	15
Using SYNCHRO .....	16
Using INTRO .....	17
Using FILL-IN .....	17
Using VARIATION .....	17
Using ENDING .....	17
Using Auto-Accompaniment .....	17
Adjusting the Accompaniment Volume .....	18
Concert Chord .....	19
Standard Fingering .....	20
Full-Range Chords .....	21
Using FREE SESSION .....	21
Using the Mixer .....	22
Editing the Status of a Channel .....	23
Editing the Parameter .....	24
Using the Custom Tone Synthesizer .....	24
Understanding 1DCO and 2DCO Tones .....	25
Creating and Storing a User Tone .....	25
Hints on Creating a User Tone .....	28
Deleting a User Tone .....	28

<b>Special Features .....</b>	<b>29</b>
Changing Keys .....	29
Tuning the Keyboard .....	29
Using Touch Response .....	30
Changing Auto Power Off .....	30
Using Pitch Bend .....	30
Setting the Pitch Bend Range .....	31
Using a Sustain Pedal .....	31
<b>Using the Memory .....</b>	<b>32</b>
Real-Time Recording .....	32
Playing Back from Memory .....	34
Step Recording .....	35
Specifying Chords in the Normal Mode .....	36
Specifying the Length of a Note .....	36
Correcting Mistakes .....	37
Recording Multiple Tracks .....	37
Real-Time Recording .....	37
Step Recording .....	38
Changing the Navigation Track .....	39
Editing Memory Contents .....	39
Editing Techniques and Display Contents .....	40
Deleting Individual Data .....	40
Deleting All Data in a Specific Track .....	40
<b>Using MIDI .....</b>	<b>41</b>
About MIDI .....	41
Making the MIDI Connections .....	41
MIDI Data .....	42
Changing MIDI Settings .....	44
Dumping/Importing Data .....	45
Dumping Data .....	45
Importing Data .....	46
Notes About the MIDI Implementation Chart .....	46
<b>Troubleshooting .....</b>	<b>48</b>
<b>Care and Maintenance .....</b>	<b>49</b>
<b>Specifications .....</b>	<b>50</b>
<b>Appendix .....</b>	<b>52</b>
Note Table .....	52
Free Session Chord Progression Chart .....	54
Drum Assignment List .....	56
Fingered Chord Chart .....	57
<b>MIDI Implementation Chart .....</b>	<b>58</b>

## PREPARATION

**Note:** To connect a MIDI device, see “Making the MIDI Connections” on Page 41. To connect a sustain pedal, see “Using a Sustain Pedal” on Page 31.

## CONNECTING POWER

You can power your MD-1200 from either:

- internal batteries (see “Using Batteries”)
- standard AC power using an optional AC adapter (see “Using AC Power” on Page 8)

### Notes:

- Connecting an AC adapter automatically disconnects internal batteries.
- Always disconnect the adapter when you finish using the MD-1200.
- Disconnecting the keyboard’s power clears the control settings, memory contents, and user tones (see “Using the Custom Tone Synthesizer” on Page 24 and “Using the Memory” on Page 32).

## Using Batteries

Your MD-1200 can use six D batteries (not supplied) for power. For the best performance and longest life, we recommend RadioShack alkaline batteries.

### Cautions:

- Use only fresh batteries of the required size and recommended type.
- If you do not plan to use the MD-1200 with batteries for a week or more, or if you will be using only AC power, remove the batteries.
- Do not mix old and new batteries, different types of batteries (standard, alkaline, or rechargeable), or rechargeable batteries of different capacities.

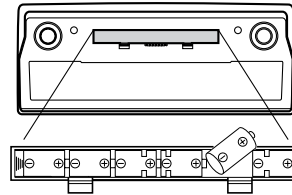

1. Press the tabs on the battery compartment cover, then pull up to remove the cover.
2. Put the batteries in the compartment as indicated by the polarity symbols (+ and -) marked beside the compartment.
3. Replace the cover.

If the MD-1200 sounds weak or does not work properly, replace all six batteries.

**Warning:** Dispose of old batteries promptly and properly. Do not burn or bury them.

**Caution:** Always remove old or weak batteries; batteries can leak chemicals that can destroy electronic parts.

## Using AC Power

You can power your MD-1200 from standard AC power using a 9-volt AC adapter (not supplied) and a Size M Adaptaplug.

### Cautions:



You must use a Class 2 power source that supplies 9 volts DC and delivers at least 800 mA. Its center tip must be set to negative and its plug must fit the MD-1200's **DC 9V** jack. Using an adapter that does not meet these specifications could damage the MD-1200 or the adapter.

- Always press **POWER** to turn off the keyboard before you connect or disconnect the adapter.
- Always plug the AC adapter into the MD-1200 before you plug it into the AC outlet. Always unplug the AC adapter from the AC outlet before you unplug it from the MD-1200.

Follow these steps to power your MD-1200 from AC power.

1. Insert the adapter's barrel plug into the **DC 9V** jack on the back of the MD-1200.
2. Plug the adapter into a standard AC outlet.

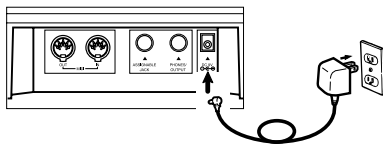

## CONNECTING HEADPHONES

To listen to your MD-1200 without disturbing others, you can connect a pair of 1/4-inch (6.35-mm) plug stereo headphones (not supplied). Your local RadioShack store sells a wide selection of headphones.

To connect a pair of headphones, insert the headphones' 1/4-inch (6.35-mm) plug into the **PHONES/OUTPUT** jack on the back of the keyboard.

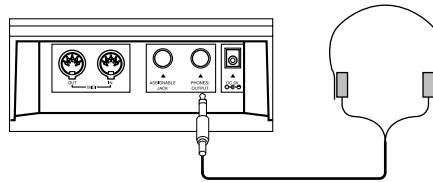

**Note:** Connecting headphones disconnects the MD-1200's built-in speakers.

## Listening Safely

To protect your hearing, follow these guidelines when you use headphones.

- Set the volume to the lowest setting before you begin listening. After you begin listening, adjust the volume to a comfortable level.
- Do not listen at extremely high volume levels. Extended high-volume listening can lead to permanent hearing loss.



- Once you set the volume, do not increase it. Over time, your ears adapt to the volume level, so a volume level that does not cause discomfort might still damage your hearing.

## CONNECTING AN EXTERNAL AMPLIFIER

To amplify your MD-1200's sound, you can connect it to an external amplifier (not supplied) using an audio cable (not supplied) with a 1/4-inch (6.35-mm) plug.

To connect an external amplifier to your keyboard, insert the cable's 1/4-inch (6.35-mm) plug into the **PHONES/OUTPUT** jack on the back of the keyboard, and connect the cable's other end to the amplifier's input jack(s) (such as AUX IN or TAPE IN).

Your local RadioShack store sells a full line of amplifiers, speakers, and connection cables.

## USING THE MUSIC STAND

To easily view sheet music while playing your keyboard, insert the supplied music stand into the slot on the top back panel.

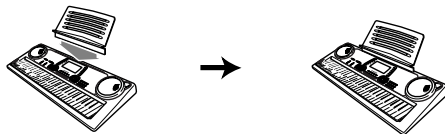

## OPERATION

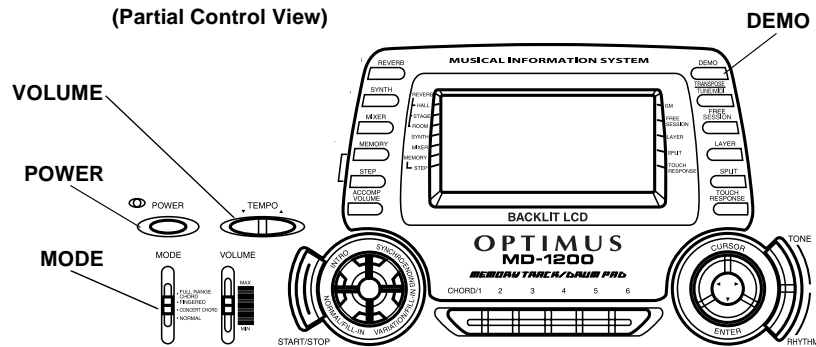

### BASIC OPERATION

1. Slide **VOLUME** to **MIN** (minimum).

**Important:** To prevent hearing damage, always set the MD-1200's volume to **MIN** before you turn it on.

2. To turn on the MD-1200, press **POWER**. The **POWER** indicator lights and the display turns on.

**Note:** To save power, the keyboard automatically turns off after about 6 minutes if you do not press a key. To turn the keyboard on again, press **POWER**. To cancel the auto power off feature, see "Changing Auto Power Off" on Page 30.

3. Slide **MODE** to **NORMAL**.
4. Slide **VOLUME** toward **MAX** slightly and begin playing the keyboard.

**Notes:**

- The MD-1200 automatically selects the tone **GND PIANO** (No. 000) when you first turn the power on. Each time you turn it on after that, it recalls the last selected tone. To select a different tone,

see "Using the Preset Tones" on Page 11.

- To select an auto-rhythm, see "Using the Preset Auto-Rhythms" on Page 15.
  - To play auto accompaniment, see "Using Auto-Accompaniment" on Page 17.
5. Slide **VOLUME** toward **MAX** to increase the sound level or **MIN** to decrease it.
  6. To turn off the MD-1200, press **POWER**. The red **POWER** indicator and the keyboard's display turn off.

### PLAYING THE DEMONSTRATION TUNES

To showcase its sounds, your MD-1200 can play two pre-programmed demonstration tunes. To start the demonstration, press **DEMO**. The MD-1200 plays the first demonstration tune (No. 0). To select the other tune, press **+** or **-** on the keypad. The selected tune's number appears, and the tune plays.

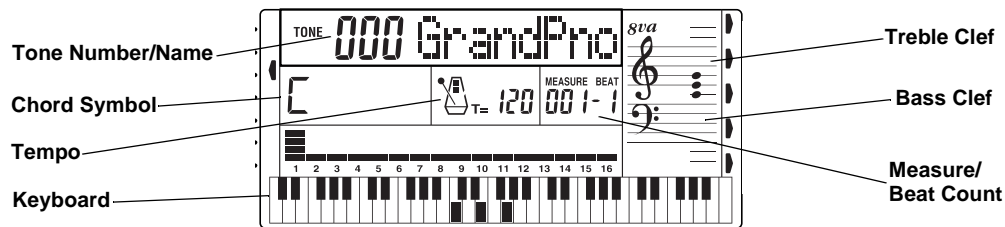

The *tone number and name* appear at the top of the display. The middle row shows the *chord symbol*, the *tempo* in beats per minute, the *number of the measure playing* and the *beat count* in each measure. The *treble and bass clefs* to the right of the display show the notes as they play. The bar graph shows the *sound level* on each of the 16 channels (see "Using the Mixer" on Page 22). The *keyboard* at the bottom of the display shows the location of the keys being pressed.

## USING THE PRESET TONES

Your MD-1200 can sound like 200 different musical instruments or sound effects. The name and three-digit number of each preset tone is listed on the MD-1200's top panel.

### Notes:

- The MD-1200 has 24-note (maximum) polyphonic sound. This means that you can play up to 24 different notes at the same time with most of the keyboard's preset tones. Many of the keyboard's preset

tones, however, are capable of only 12-note polyphony.

- Most tones on this keyboard have been recorded and processed using a technique called *digital sampling*. To ensure a high level of tonal quality, samples are taken in the low, mid, and high ranges and then combined. You might notice very slight differences in volume or sound quality for some tones when you play them at different positions on the keyboard. This is an unavoidable result of multiple sampling and is normal.

Follow these steps to select and play a preset tone.

1. Press **TONE**. **TONE** and the current tone's number appear.

**Note:** The MD-1200 automatically selects the tone GRAND PIANO (No. 000) the first time you turn on power.

2. To play a different tone, choose a preset tone from the 200 TONES list and enter its three-digit number on the keypad. For example, to select ELEC PIANO 1, press **0 0 4**. As you press the keys, the selected digits appear.

**Notes:**

- You can select the next highest or lowest numbered tone by simply pressing + or – on the keypad.
- The names of tone numbers 000–127 are marked to the right of the MD-1200's display. The names for tone numbers 128–167 appear in the table below. Memory locations 168–199 are reserved for custom tones that you create (see “Using the Custom Tone Synthesizer” on Page 24).

No.	Tone
128	SYNTH PAD 1
129	SYNTH PAD 2
130	TOUCH STRINGS
131	DO AHH
132	STRINGS HIT
133	VIBES PIANO
134	SAW SYNTH
135	TOUCH BASS
136	STRINGS PIANO
137	E. PIANO STRINGS
138	STEREO PIANO
139	12 STR GUITAR
140	BRASS FALL
141	BASS SLIDE
142	FEEDBACK GT
143	PIANO → STRINGS
144	ECHO ORGAN
145	ROTARY ORGAN
146	CHORUSED EP
147	STRINGS GT
148	PAD ENS 1

No.	Tone
149	PAD ENS 2
150	SEQUENCE 1
151	SEQUENCE 2
152	SYNTH PAD 3
153	SYNTH PAD 4
154	SYNTH PAD 5
155	SYNTH PAD 6
156	SYNTH PAD 7
157	SYNTH PAD 8
158	REVERSE ECHO
159	FAST TREMOLO
160–167	DRUM SET 1–8

- When you select one of the drum sets (tone numbers 160–167), each key plays a different percussion sound. See “Drum Assignment List” on Page 56.
  - The drum set sounds change when you change the rhythm number, play back data stored in memory, or receive MIDI program change data.
  - Tone numbers 168–199 are the user tone area. See “Using the Custom Tone Synthesizer” on Page 24.
3. Play the keyboard to hear the selected tone.
  4. Adjust the volume to the desired level.

To select a different tone, while **TONE** appears, simply enter the desired tone number.

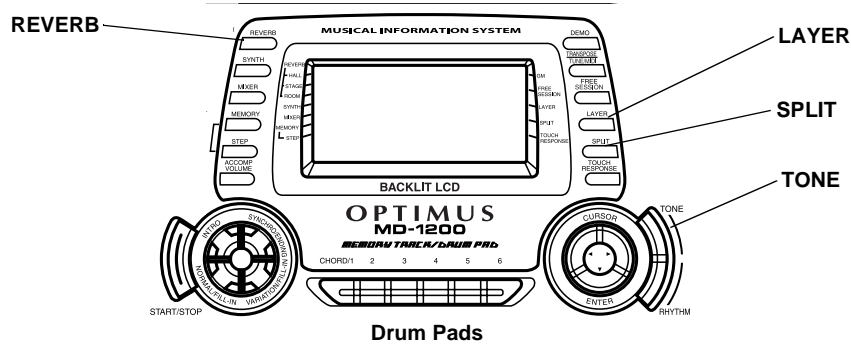

## USING THE DRUM PADS

The MD-1200 has six drum pads that you can use to play percussion sounds independent of the keyboard keys. Simply tap on a drum pad to play the percussion sound currently assigned to it.

To change the drum pad sounds, use the mixer function to change the tone assigned to Channel 10. See “Using the Mixer” on Page 22.

## USING REVERB

The REVERB feature creates ambiance effects by causing the sound to linger and reverberate. Press **REVERB** so the indicator appears next to the type of reverb you want.

**HALL** — creates a concert hall effect.

**STAGE** — creates the acoustics of a small club.

**ROOM** — adds the acoustics of a studio.

To turn off REVERB, press **REVERB** so no indicator appears on the display.

## USING SPLIT

The MD-1200’s SPLIT feature lets you play two different tones on opposite ends of the keyboard, so the low-end keys play one tone, and the high-end keys play another.

Follow these steps to use SPLIT.

1. Press **TONE**.
2. Enter the three-digit number for the tone you want the high-end keys to play.
3. Press **SPLIT**. The SPLIT indicator appears.
4. Enter the three-digit number for the tone you want the low-end keys to play.
5. Hold down **SPLIT**, and press the key where you want the high-end tones to begin. The selected key’s name appears on the display.

For example, if you set the split point to be F below middle C, **F3** appears.

**Note:** You can change the split point at any time.

6. Play both the low and high-end keys to hear the selected split tones.

To select a different low-end tone, enter the three-digit number for the new low-end tone while the **SPLIT** indicator is on the display.

To select a different high-end tone, press **SPLIT** to turn off its indicator, then enter the three-digit number for the new high-end tone. Then press **SPLIT** again so the **SPLIT** indicator appears.

To cancel **SPLIT** play, press **SPLIT** again so its indicator turns off.

**Notes:**

- If **SPLIT** is on when you turn off the keyboard, **SPLIT** will still be on the next time you turn on the keyboard.
- When you turn on **SPLIT**, the last selected settings appear.

## USING LAYER

The MD-1200 lets you set the keyboard to play two different preset tones at the same time, creating a “layered effect” when you press one key.

**Note:** The first tone you select when using **LAYER** is called the *base tone* and the second tone is called the *layer tone*.

1. Press **TONE**.
2. Enter the three-digit number for the base tone.
3. Press **LAYER**. The **LAYER** indicator appears.
4. Enter the three-digit number for the layer tone.
5. Play the keyboard to hear the selected layered tones.

To select a different layer tone, enter the three-digit number for the new layer tone while the **LAYER** indicator is on the display.

To select a different base tone, press **LAYER** to turn off its indicator, then enter the three-digit number for the new base tone. Then press **LAYER** again so the **LAYER** indicator appears.

To cancel **LAYER**, press **LAYER** again so its indicator turns off.

**Notes:**

- If **LAYER** is on when you turn off the keyboard, **LAYER** will still be on the next time you turn on the keyboard.
- When you turn on **LAYER**, the previous tone settings appear.

## USING SPLIT AND LAYER TOGETHER

You can combine the **SPLIT** and **LAYER** features, so you can play one layered combination of tones on the low-end keys and another on the high-end keys.

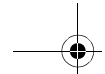

1. If the **SPLIT** or **LAYER** indicator is on, press **SPLIT** or **LAYER** to turn it off.
2. Enter the number for the high-end base tone on the keypad.
3. Press **SPLIT** so the **SPLIT** indicator appears.
4. Enter the number for the low-end base tone.
5. Press **SPLIT** so the **SPLIT** indicator disappears.
6. Press **LAYER** so the **LAYER** indicator appears.
7. Enter the number of the layered tone for the high-end keys.
8. Press **SPLIT**. The **SPLIT** indicator appears.
9. Enter the number of the layered tone for the low-end keys.
10. If desired, hold down **SPLIT** and press the key where you want the high-end tones to begin.
11. Play the keyboard to hear the selected tones.

To cancel the **SPLIT/LAYER** combination, press each button so both the **SPLIT** and **LAYER** indicators disappear.

## USING THE PRESET AUTO-RHYTHMS

Your MD-1200 has 100 preset auto-rhythms that provide a steady beat for your music. The name and two-digit

number of each preset auto-rhythm is marked to the left of the MD-1200's display.

You can play a preset auto-rhythm on the MD-1200 in any of these ways:

- Select and play a rhythm. See "Selecting/Playing an Auto-Rhythm."
- Synchronize the start of a rhythm with your music. See "Using SYNCHRO" on Page 16.
- Start a rhythm with a special introduction. See "Using INTRO" on Page 17.
- Stop a rhythm with a special ending. See "Using ENDING" on Page 17.
- Briefly vary the pattern of a rhythm. See "Using FILL-IN" on Page 17.
- Play an alternate version (variation) of a rhythm. See "Using VARIATION" on Page 17.

### Selecting/Playing an Auto-Rhythm

1. Press **RHYTHM**. **RHYTHM** and the name and number of the current auto-rhythm appear on the display.

**Note:** The MD-1200 automatically selects the rhythm CLUB POP (No. 00) the first time you turn it on. Each time you turn it on after that, it recalls the last selected rhythm.

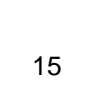
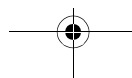
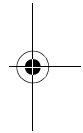
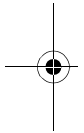

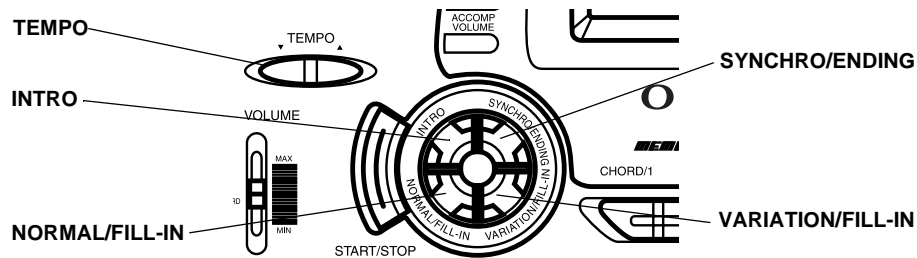

- To select a different rhythm, choose an auto-rhythm from the 100 RHYTHMS list and enter its two-digit number on the keypad. For example, to select 8 BEAT BALLAD 2 (No. 05), press **0** then **5**.

**Note:** You can select the next highest or lowest numbered auto-rhythm by simply pressing **+** or **-** on the keypad.

- Set **MODE** to **NORMAL**. Then press **START/STOP** to start the selected auto-rhythm.
- Adjust the volume to the desired level.
- To change the auto-rhythm speed, press **TEMPO ▲** or **▼**. The current tempo setting appears on the display.

#### Notes:

- You can adjust the tempo to play an auto-rhythm from 40 to 255 beats per minute.
- To quickly slow down or speed up the tempo, hold down **TEMPO ▲** or **▼**.

- You can also adjust the tempo by first pressing **TEMPO ▲** or **▼**, then entering the desired number of beats per minute in three digits (040 to 255), or by holding down **+** or **-** on the keypad.
- To reset the tempo to its default (original) speed, press **TEMPO ▲** or **▼** at the same time.

To select a different rhythm, repeat Steps 1 and 2.

To stop the auto-rhythm, press **START/STOP**.

## Using SYNCHRO

The MD-1200's **SYNCHRO** feature lets you synchronize the start of an auto-rhythm with the beginning of your music.

After you select and enter an auto-rhythm, press **SYNCHRO/ENDING**, then begin playing the keyboard. The rhythm automatically starts to play when you press any key within the first 1½ octaves of the lower end of the keyboard (the first 18 keys from the left).



## Using INTRO

The MD-1200's INTRO feature lets you start the selected auto-rhythm with a light, 3- to 8-measure introduction that blends easily into the selected rhythm.

To start a rhythm with an introduction, select and enter the rhythm, then press **INTRO**. The introduction plays, then the selected auto-rhythm automatically starts.

## Using FILL-IN

The FILL-IN feature lets you insert a short (1- to 2-measure) fill-in segment of a selected auto-rhythm.

To insert the fill-in segment, press and release **NORMAL/FILL-IN** while the auto-rhythm is playing. The MD-1200 inserts a 1- to 2-measure variation in the rhythm, then the original rhythm automatically resumes.

## Using VARIATION

Each of the MD-1200's 100 preset auto-rhythms has a built-in variation (alternate) to its normal beat pattern. The variation differs slightly from the normal rhythm, so it is almost like having two rhythms in one!

To play the alternate rhythm, press **VARIATION/FILL-IN**. The variation plays continuously at the selected tempo.

To insert the fill-in segment in the alternate rhythm, press **VARIATION/FILL-IN**.

The keyboard adds a 1- to 2-measure variation in the rhythm.

To return to the normal rhythm, press **NORMAL/FILL-IN**.

To stop the auto-rhythm, press **START/STOP**.

## Using ENDING

To end the selected rhythm with a special 3- to 8-measure flourish, press **SYNCHRO/ENDING** while the auto-rhythm is playing, about 3–8 measures before you want the rhythm to end. The MD-1200 plays a special ending, then automatically stops the rhythm.

## USING AUTO-ACCOMPANIMENT

The 18 keys on the left side of the keyboard with note labels above them are called *accompaniment keys*.

You can set the MD-1200 to play three different types of auto accompaniment.

**Concert Chord** — lets you play chords on the accompaniment keys using chord formations of from one to four notes. The number of keys you press determines the type of chord that plays.

**Standard Fingering** — lets you play chords on the accompaniment keys using standard chord formations of three or four notes (see "Standard Fingering" on Page 20).

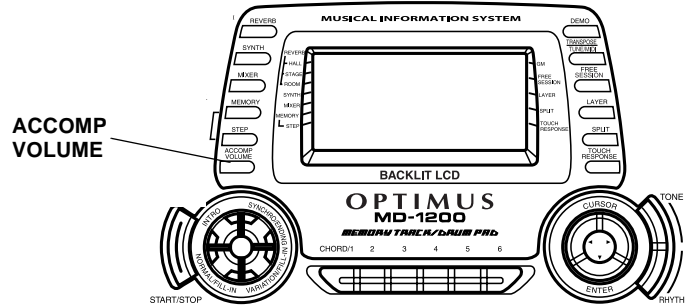

**Free Session** — lets you play the melody using the entire keyboard while the MD-1200 plays accompaniment based on your auto-rhythm selection (see “Using FREE SESSION” on Page 21).

**Notes:**

- After you press the auto accompaniment keys when using concert chord or standard fingering, the MD-1200 plays the same chord until you press other accompaniment keys to play a different chord or you press **START/ STOP**.
- You can use the MD-1200's rhythm controls (**INTRO**, **NORMAL/FILL-IN**, **VARIATION/FILL-IN**, and **SYNCHRO/ ENDING**) with all three types of auto accompaniment.

### Adjusting the Accompaniment Volume

The MD-1200 lets you adjust the volume of your accompaniment separately from the overall volume of the keyboard.

1. Press **ACCOMP VOLUME**. The three-digit number of the last selected accompaniment volume appears on the display.
2. Within 5 seconds, enter a number from **0 0 0** (softest) to **1 2 7** (loudest) on the keypad. The numbers appear on the display as you press the keys.

To select the next highest or lowest accompaniment volume number, you can also press **+** or **-** after pressing **ACCOMP VOLUME**. Hold down **+** or **-** to quickly increase or decrease the accompaniment volume.

To reset the accompaniment volume to its default value of 87, press **ACCOMP VOLUME** then press **+** and **-** at the same time.

**Note:** The auto-accompaniment patterns consist of four parts: chord 1, chord 2, bass, and rhythm. You can delete any of the parts by using the mixer function. See “Using the Mixer” on Page 22.

## Concert Chord

The concert chord method lets beginning keyboard players easily select and play a chord.

The number of accompaniment keys you press determines the type of chord that plays. This table shows the type of chord that plays when you press one, two, three, or four accompaniment keys at the same time.

Number of Keys Pressed	Chord Type
	Major
	Minor (m)
	Dominant Seventh (7)
	Minor Seventh (m7)

The lowest note you play determines the key of the chord. For example, if the lowest note is C, the keyboard plays a C chord.

**Note:** You can play any labeled note(s) to the right of the lowest note in the chord to produce a minor, a dominant seventh, or minor seventh chord.

Follow these steps to start concert chord auto accompaniment.

1. Set **MODE** to **CONCERT CHORD**.
2. Select and enter an auto-rhythm.
3. To start the auto-rhythm before the auto accompaniment, press **START/STOP** or **INTRO**.

To synchronize the start of the selected auto-rhythm with your accompaniment, press **SYNCHRO/ENDING**.





4. Begin the accompaniment by pressing the desired accompaniment key(s).

To play a melody along with the accompaniment, press any key(s) to the right of the accompaniment keys.

5. To change chords without interrupting the rhythm, simply press the auto accompaniment key(s) required to form the new chord.
6. To stop accompaniment and the auto-rhythm, press **START/STOP**.

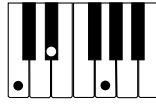
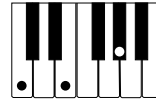
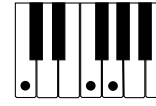
## Standard Fingering

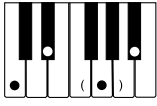
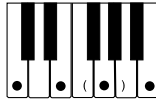
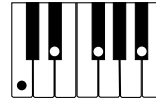
The standard fingering method uses standard formations of three or four notes, and lets the experienced musician play a wider variety of accompaniment chords. You can play these 15 chord types on your MD-1200, in any key, using the standard fingering method.

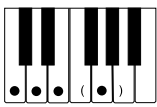
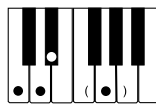
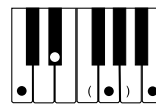
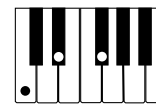
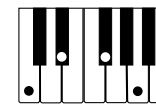
 Major (M)	 Minor (m)	 Augmented (aug)	 Suspended 4th (sus4)	 Dominant 7th (7)
 Minor 7th (m7)	 Major 7th (M7)	 Minor Half-Diminished (m7 <sup>5</sup> )	 Major Half-Diminished (7 <sup>5</sup> )	 Dominant Suspended 4th (7sus4)
 Major 9th (add9)	 Minor 9th (madd9)	 Minor/Major 7th (mM7)	 Diminished	 Diminished 7th (dim7)

### Notes:

- To produce a simple variation of a 7, m7, M7, mM7, add9, or madd9 chord, you can omit the finger positions shown in parentheses (on the keys).
- When producing an aug, 7-5, or dim7 chord, the lowest note you play determines the root of the chord. Be sure that your fingering correctly defines the root you want.
- The diagrams above show only one possible fingering position for each chord. It is possible to play a chord using several different positions. For example, these three fingering positions produce the same C chord.

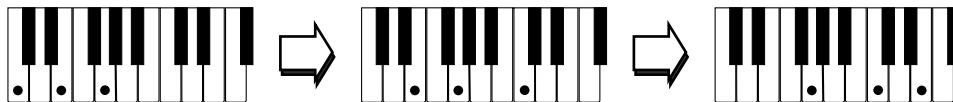

Follow these steps to start standard fingering auto accompaniment.

1. Set **MODE** to **FINGERED**.
2. Select and enter an auto-rhythm. (See "Selecting/Playing an Auto-Rhythm" on Page 15.)
3. To start the auto-rhythm before your auto accompaniment, press **START/STOP** or **INTRO**.

To synchronize the start of the selected auto-rhythm with your accompaniment, press **SYNCHRO/ENDING**.

4. Begin the accompaniment at the desired interval by pressing at least three accompaniment keys to play the desired chord.

To play a melody along with the accompaniment, press any key(s) to the right of the accompaniment keys.

5. To change chords without interrupting the rhythm, simply press the auto accompaniment keys required to form the new chord.
6. To stop accompaniment and the auto-rhythm, press **START/STOP**.

### Full-Range Chords

While the easy random and standard fingering methods limit chord formations to the accompaniment keys, the full-range chord method lets you play chords of any type using any of the MD-1200's keys.

Set **MODE** to **FULL RANGE CHORD** and follow the steps under "Standard Fingering." If you press three or more keys anywhere on the keyboard that form a chord, the MD-1200 plays that chord. The MD-1200 responds with melody sounds if you press fewer than three keys.

#### Notes:

- In the full-range chord mode, the MD-1200 recognizes these 23 chords in addition to the 15 chords in the standard fingering mode (examples show C as the base note):

C6	Cm6	C6/9	C/C	D/C	E/C
F/C	G/C	A/C	B/C	BCm/ C	Dm/C
Fm/C	Gm/C	Am/C	Bm/C	Dm7- 5/	C
A7/C	F7/C	Fm7/ C	Gm7/ C	Aadd9/C	

- When the composite notes of a chord are more than five notes apart, the lowest sound becomes the base note.

### Using FREE SESSION

The MD-1200 lets you set the keyboard to play an automatic accompaniment (based on your auto-rhythm selection) while you play the melody using a tone you select. Refer to the "Free Session Chord Progression Chart" on Page 54 for the chord progression, tempo, and tone associated with each auto-rhythm.

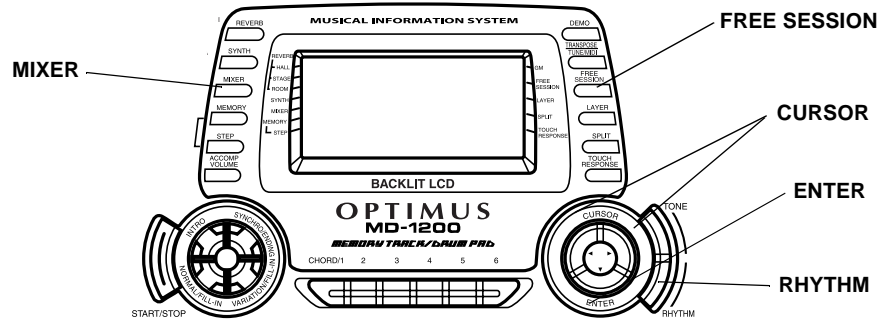

Follow these steps to use the keyboard's free session feature.

1. Press **RHYTHM**.
2. Select and enter an auto-rhythm.
3. Press **TONE**.
4. Select and enter the desired tone for the melody. You can use any of the preset and custom tone features, as well as the preset auto-rhythm features.
5. Press **FREE SESSION**. The **FREE SESSION** indicator, the auto-accompaniment tone name and number, and the tempo appear.
6. To start the free session accompaniment, press the accompaniment key for the root of the first chord. For example, if the tune you are going to play is in G, press the key for G on the accompaniment keyboard.

**Note:** Pressing **START/STOP** also starts the free session, but the root key is automatically set to C.

To start the free session accompaniment with a short introduction, press **INTRO**.

To synchronize the start of the free session accompaniment with the start of your melody, press **SYNCHRO/ENDING**.

7. Adjust **TEMPO** and **VOLUME** to the desired levels.
8. Play your melody using the entire keyboard.
9. To stop the free session accompaniment, press **START/STOP**.

To end the free session accompaniment with a short automatic ending, press **SYNCHRO/ENDING**.

## USING THE MIXER

The MD-1200 plays multiple parts at the same time during auto accompaniment, or memory playback, or when receiving MIDI data, in up to 16 separate channels. You can control the on/off setting, volume, and parameters of each of the keyboard's channels just as you would with a sound mixer.

This chart shows the parts assigned to each channel.

Channel	Part
1	Main tone
2	Layered tone
3	Split tone
4	Layered/split tone
5	These channels only produce sound when they receive MIDI signals
6	
7	Auto accompaniment chord part 1
8	Auto accompaniment chord part 2
9	Auto accompaniment bass part
10	Auto accompaniment rhythm part, drum pad
11	Memory Track 1
12	Memory Track 2
13	Memory Track 3
14	Memory Track 4
15	Memory Track 5
16	Memory Track 6

#### Notes:

- Normally, keyboard play is assigned to Channel 1 and the drum pads are assigned to Channel 10. When you use auto accompaniment, each part is assigned to Channels 7–10.

- When you use the MD-1200 as the sound source for another MIDI device, all 16 channels are assigned musical instrument parts (Channel 10 is reserved for drum parts only, per MIDI standard).
- The mixer settings also affect the corresponding MIDI output.

### Editing the Status of a Channel

You can edit the status (on, off, solo) of a channel to delete a specific part or to play a specific part by itself.

Follow these steps to edit the status of a channel.

1. Press **MIXER**. The MIXER indicator appears and the last selected channel appears on the display.
2. Use + or – on the keypad to select the channel you want to edit.
3. Press ◀ or ▶ to display the current status of the channel — **on**, **oFF**, or **SoL** (solo).
4. Use + or – to select the status you want.

**on** (default): Turns on the current channel. A bar appears at the bottom of the level meter for the selected channel.

**oFF**: Turns off the current channel. The bar at the bottom of the level meter disappears.

**SoL**: Turns the current channel on and all the other channels off. A bar appears over only the current channel.

- To edit other channels, press ◀ or ▶ to return to the channel selection screen and repeat Steps 2–4.

To exit the edit mode, press **MIXER**. The display shows the performance status of the channels as edited.

### Editing the Parameter

You can change the settings of six parameters such as tone, volume, and pan (relative position of the tone between the left and right speaker channels) for the selected channel.

Follow these steps to edit the parameters.

- Select the channel you want to edit as described in Steps 1 and 2 of “Editing the Status of a Channel” on Page 23.
- Press ▼ (**ENTER**) to enter the parameter edit mode.
- Repeatedly press ◀ or ▶ (**CURSOR**) to select the parameter you want to change.

**Program Change Number (000 to 199)** — sets the tone assigned to the channel.

**Note:** Channel 10 is reserved for percussion, so only tone numbers 160 (DRUM SET1) through 167 (DRUM SET 8) can be set for Channel 10.

**Volume (000 to 127)** — controls the volume of the selected channel.

**Pan (000 to 127)** — controls the pan. 000 is fully left, 64 is the center position, and 127 is fully right.

**Fine Tune (-50 to +50)** — fine tunes the pitch of the selected channel in cent units. A cent is one hundredth of a semitone. There are 12 semitones per octave.

**C (Coarse) Tune (-12 to +12)** — coarsely tunes the pitch of the selected channel in semitone units.

**Express (Expression) (000 to 127)** — controls the volume of the selected channel. Similar to the volume setting, this is often used to control crescendo/decrescendo.

- Use the number buttons or + or – to change the parameter setting.
- To edit other channels, press ▼ to return to the channel selection display, select the channel, then repeat Steps 2–4.
- To exit the parameter edit mode, press **MIXER**.

## USING THE CUSTOM TONE SYNTHESIZER

The MD-1200's custom tone synthesizer lets you create up to 32 of your own original tones. To create a “user” tone, you simply select one of the keyboard's 200 preset tones, change its parameters, then store the new tone in any memory location from 168–199. You select and use a user tone the same as a preset tone.



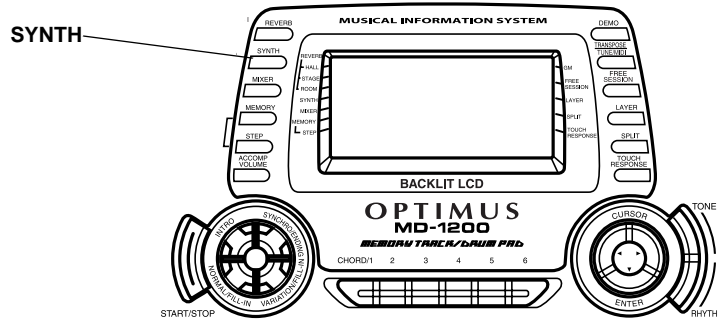

### Notes:

- You cannot use tones 160–167 (drum set tones) as base tones.
- The preset tone you use as the basis for a user tone is not changed.
- The tone locations 168–199 are not empty (before you store user tones there). They initially contain duplicate versions of tone numbers 128–159. The user tone you store in any of those locations replaces the existing tone. If you delete a user tone, the keyboard automatically restores the initial, duplicate tone there.

The parameters you can change are divided into four groups. For the details of each parameter, see “Creating and Storing a User Tone.”

- **Tone Characteristic Waveform** — PCM Set
- **Volume Characteristic** — Amp Envelope Set
- **Tone Pitch** — Pitch and Pitch Envelope Set

- **Tone Characteristic** — Attack Rate, Release Rate, Level, Touch Sensitivity, and Pan

### Understanding 1DCO and 2DCO Tones

A Digital Controlled Oscillator (DCO) controls the sound output of a digital signal. Some of the MD-1200's built-in tones are simple tones (1DCO), and some are layered tones (2DCO). When you select a 2DCO tone as the basis for creating a user tone, you need to change the parameters of both tones.

When you select a layered tone, **dCo1** appears on the display, indicating that this is the first tone of a layered tone.

### Creating and Storing a User Tone

Follow these steps to create and store your own tone. (Refer to “Hints on Creating a User Tone” on Page 28.)

**Notes:**

- A new or revised user tone replaces the existing user tone.
  - Layer, split, auto accompaniment, demo tune play, and MIDI functions are all disabled while the keyboard is in the Custom Tone Synthesizer mode.
1. Select the preset tone (except 160–167) you want to use as a basis for your user tone.
  2. Press **SYNTH**. The keyboard enters the Custom Tone Synthesizer mode and the first parameter (**PCM Set**) appears on the display. The display also shows whether the tone you selected is a **DCO1 O2** tone (if it is a layered tone).
- Note:** To cancel the save operation at any time, press **SYNTH** or **TONE** twice.
3. Repeatedly press ◀ or ▶ to display the parameter you want to change.

**PCM Set (0 to 173)** — Determines the characteristic of a tone by changing its digitally sampled waveform.

**Amp Envelope Set (Amp.Set) (0 to 137)** — Selects the volume envelopes. 000 to 048 set volume envelopes for a decaying note (how fast or slow the sound diminishes). 049 to 137 set volume envelopes that sustain the note.

**Attack Rate (Atk Rate) (1 to 127)**

— Sets the speed of the attack (the period from when you press a key to when the tone reaches its maximum volume). The greater the value, the quicker the attack. Use this parameter to make fine adjustments to the tone characteristics of the amp envelope.

**Release Rate (Rel.Rate) (1 to 127)**

— Controls the speed of a tone release (the period from when you release a key to when the tone stops sounding). The greater the value, the quicker the release. Use this parameter to make fine adjustments to the tone characteristics of the amp envelope.

**Pitch Envelope Set (PitchSet) (0 to 49)**

— Selects the pitch envelopes. 00 specifies no change, a value from 01 to 19 changes the vibrato, and a value from 20 to 49 changes a parameter other than the vibrato.

**Pitch (Pitch) (-64 to +63)**

— Controls the overall pitch of the tone. A positive value increases the pitch, a negative value lowers it. A setting of zero sets the pitch to the standard setting for the selected tone.

**Level (Level) (0 to 127)**

— Controls the overall volume of the tone. The greater the value, the greater the volume. Setting a level of zero means that the tone does not sound at all.

**Touch Sensitivity (TchSense)**

**(-64 to +63)** — Controls changes in the volume of the tone depending on how hard you strike the keys. You can specify more volume for stronger striking and less volume for lighter striking, or you can specify 00 to set the same volume regardless of how hard you strike the keys.

**Pan (Pan) (-64 to +63)** — Controls the relative position of the tone between the left and right speaker channels. A greater positive value moves the center point further to the right, a negative value moves it to the left.

- Use + or - to change the parameter's setting. You can also use the number buttons to directly enter a value for the parameter.

**Notes:**

- If you want to change another parameter, repeat Steps 3 and 4.
- If you selected a layered preset tone, press ▼ to recall the DCO2 parameters (d Co2 appears), and repeat Steps 3 and 4 to set the parameters. Press TONE again to return to the DCO1 parameters.

- Press **SYNTH. Save?** appears.

To store the settings, press ▼ to display the tone number where you want to save the user tone.

To exit the Custom Tone Synthesizer mode without storing a new tone, press ►. The display changes to **Cancel?** Press TONE to cancel.

- Press + or - until the tone number you want appears on the display. If you do not want to assign a name, skip to Step 10.

- To give a name to your tone, press ►. The first character of the tone name flashes.

- Repeatedly press + or - until the first character of the new name appears on the display.

- Press ► to move to the next character position. Repeat Steps 8 and 9 to enter the rest of the characters in the new name.

**Note:** Press ◀ to change the tone number (the name of the tone returns to its preset name).

- Press ▼ to save the user tone. **Save OK** appears briefly and the keyboard exits the Custom Tone Synthesizer mode.



---

## Hints on Creating a User Tone

- Use a preset tone that is similar to the one you are trying to create. When you already have a general idea of the tone you are trying to create, it is a good idea to start with a similar preset tone. If you want to use a layered tone, start out with a 2DCO tone.
- Determine the most important parameter. The PCM Set and Amp Envelope Set parameters are the major factors that determine the overall tone characteristic. Start out by setting these two parameters to get the general sound you want, and then set the other parameters to add the finishing touches.
- Experiment with different settings. There are no real rules about what a tone should sound like. Let your imagination run free and experiment with different combinations. You might be surprised at what you can achieve!

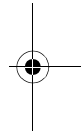
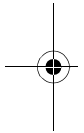

## Deleting a User Tone

To delete an existing user tone, follow Steps 1–5 of “Creating and Storing a User Tone” on Page 25. When **SAVE ?** appears in Step 5, press **▶** twice. The display changes to **Delete?** Press **TONE** to delete. The parameters of the default tone for that number are restored.

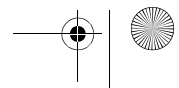
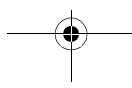

## SPECIAL FEATURES

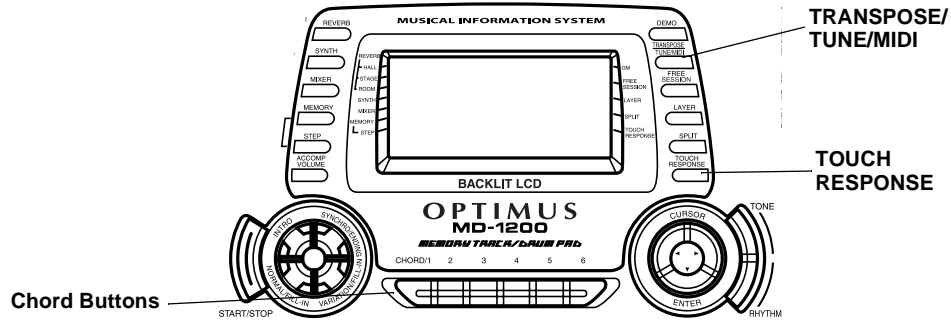

### CHANGING KEYS

The MD-1200 automatically selects the key of middle C each time you turn it on. For added flexibility as you play, the MD-1200 lets you change (transpose) the musical key.

Follow these steps to change keys.

1. Repeatedly press **TRANSPOSE/TUNE/MIDI** until **00 Trans** appears on the display.

**Note:** The number on the display is the number of semitones to which the keyboard is set, compared to its default key. You can transpose the key up or down 12 semitones (one octave).

2. Within 5 seconds, press **+** or **-** to raise or lower the key. Each time you press the key, the number on the display increases or decreases by 1 (semitone).

#### Notes:

- The MD-1200 automatically resets the key to the default value of 0

(middle C) each time you turn off the keyboard.

- The transpose setting also affects memory playback (see “Playing Back from Memory” on Page 34) and auto accompaniment.

### TUNING THE KEYBOARD

Although your MD-1200 never goes out of tune, it does let you adjust its pitch to match other instruments or musical recordings.

**Note:** You cannot adjust the keyboard's pitch while the demonstration songs are playing.

1. Repeatedly press **TRANSPOSE/TUNE/MIDI** until **00 TRANS** appears.
2. Press **◀** or **▶** so **00 TUNE** appears.

**Note:** The number on the display is the number of *cents* to which the keyboard is currently tuned, compared to its default pitch. A cent is one hundredth of a semitone. You can tune the keyboard up or down 50 cents (a half semitone).

3. Within 5 seconds, press **+** or **-** to raise or lower the keyboard's pitch. Each time you press the key, the number on the display increases or decreases by 1 (cent).

**Notes:**

- The MD-1200 automatically resets the tuning pitch to the default value of 00 (cents) each time you turn off the keyboard.
- Memory playback uses the pitch with which the memorized tune was recorded.
- Auto accompaniment uses the currently set pitch.

## USING TOUCH RESPONSE

The MD-1200 has a touch response feature that lets you adjust the volume of your music's tone based on how hard you strike the key(s), so you can add emotion to your music.

To turn off this feature, press **TOUCH RESPONSE** so its indicator disappears.

To turn on touch response again, press **TOUCH RESPONSE** so its indicator appears.

**Notes:**

- The touch response setting does not affect auto accompaniment or received MIDI data.
- The MIDI data sent out from the MD-1200 is affected by the touch response setting.

## CHANGING AUTO POWER OFF

When you operate the MD-1200 with battery power, the keyboard automatically shuts off after about 6 minutes if you do not press a key. Press **POWER** again to turn power back on.

To have the keyboard not automatically turn off during a session, turn the keyboard on while holding down **TONE**.

The next time you turn the MD-1200 off then back on again, it automatically turns off after about 6 minutes.

## USING PITCH BEND

**PITCH BEND** lets you bend a note by altering its pitch. It helps to create realistic effects for saxophone, other reed instruments, and guitar tones.

Follow these steps to use **PITCH BEND**.

1. Select a tone.
2. While holding down a keyboard key, rotate and hold **PITCH BEND**. The pitch of the tone slides smoothly up or down.

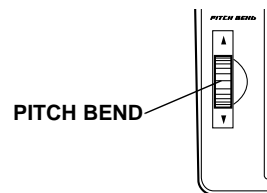

3. Release **PITCH BEND** to return to the original pitch.

## Setting the Pitch Bend Range

You can adjust the bend range of pitch controls from 1 to 12 semitones.

**Note:** The keyboard automatically selects a bend range of 2 semitones the first time you turn it on after connecting power. Each time you turn it on after that, it recalls the last selected bend range.

Follow these steps to adjust the pitch bend range.

1. Repeatedly press **TRANSPOSE/TUNE/MIDI** until a number and **Bend** appear on the display.
2. Within 5 seconds, press **+** or **-** on the keypad until the pitch bend range you want appears on the display, or enter a number from 01–12.

## USING A SUSTAIN PEDAL

For added flexibility and control as you make music, you can connect a sustain pedal (not supplied), available through your local RadioShack store. A sustain pedal lets you sustain or soften the keyboard's sound, and even start or stop an auto-rhythm.

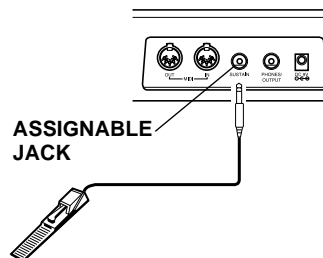

To connect a sustain pedal to your MD-1200, insert the plug on the pedal's cord into **ASSIGNABLE JACK** on the back of the keyboard.

You can adjust the MD-1200's assignable jack to these settings when you use a sustain pedal.

Setting	Description
<b>SUS</b> (Sustain)	Causes one or more notes to linger after they are played
<b>SoS</b> (Sostenuto)	Similar to SUS, but only sustains one note at a time
<b>SFt</b> (Soft)	Softens the sound
<b>rHy</b> (Rhythm)	Starts or stops the selected auto-rhythm

Follow these steps to change the assignable jack's setting.

1. Repeatedly press **TRANSPOSE/TUNE/MIDI** until **Bend** appears. Then press **▶** until the assignable jack's current setting and **Jack** appear on the display.
2. Within 5 seconds, press **+** or **-** until the desired setting (**SUS**, **SoS**, **SFt**, or **rHy**) appears.

Press the sustain pedal as you play to hear the desired sound or to start/stop the selected auto-rhythm.

## USING THE MEMORY

The MD-1200 lets you record up to two separate songs in memory for later playback. You can use either of two methods to record a song — *real-time recording* (you record as you play) or *step recording* (you enter notes and chords one-by-one).

You can record on each of the MD-1200's six tracks separately. Besides notes, each track can have its own tone number. Then, when you play back the tracks together, it sounds like an entire six-piece band. Also, you can use different mixer settings for each track.

Track 1 is the main track, and you can use it to record auto accompaniment and drum pad sounds, as well as keyboard play. Tracks 2 through 6 are melody tracks, and you can use these for recording a secondary melody that includes keyboard play and the drum pad.

Because each track is independent of the others, you only need to re-record a single track if you make a mistake while recording on it.

### REAL-TIME RECORDING

With real-time recording, the notes are recorded as you play them on the keyboard. Before you start, read these tips.

- To record without an auto-rhythm, skip Step 5 of "Real-Time Recording." Recording starts when you press a key.
- To start recording with synchro start, press **SYNCHRO/ENDING** instead of **START/STOP** in Step 5 of "Real-Time Recording." Recording starts when you play a note or a chord on the accompaniment keys.
- To record using an intro, ending, or fill-in, use **INTRO**, **SYNCHRO/ENDING**, **NORMAL/FILL-IN**, or **VARIATION/FILL-IN** as you normally would.
- To synchro start auto accompaniment with an intro pattern, press **SYNCHRO/ENDING** and then **INTRO** instead of **START/STOP** in Step 5 of "Real-Time Recording." Recording starts with the intro pattern when you play a note or a chord on the accompaniment keys.
- To start auto accompaniment during a recording, press **SYNCHRO/ENDING** instead of **START/STOP** in Step 5. Play the melody keys to start recording. When you reach the point where you want accompaniment to start, play a chord on the accompaniment keys.
- To record while using free session, between Step 4 and 5 of "Real-Time Recording," press **FREE SESSION**. This makes the entire keyboard a melody keyboard, regardless of the **MODE** setting. See the "Free Session Chord Progression Chart" on Page 54.



- Pressing **FREE SESSION** while recording with a free session accompaniment turns off the accompaniment; however, the keyboard continues playing the last chord played before **FREE SESSION** was turned off. You can change the chord by specifying a different one using the appropriate method (Fingered, Concert Chord, etc.) as determined by the **MODE** setting.

Follow these steps to record as you play.

1. Repeatedly press **MEMORY** until **Rec. No.** appears.

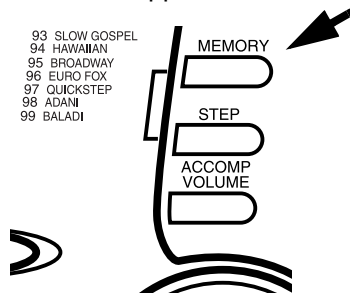

**Note:** **MEMORY** is a three-way switch. When you press it once, the keyboard enters the memory playback mode. When you press it again, it enters the memory record mode. When you press the button a third time, it turns off the memory function.

2. Within 5 seconds, press **+** or **-** (or **0** or **1**) to select a song number.
3. Press **CHORD/1** to select Track 1.

While the keyboard is in memory record mode, the level meters for channels 11 through 16 correspond

to memory tracks 1 through 6. When all four bars are lit, that channel has something in memory: if only one bar is lit, that track is empty.

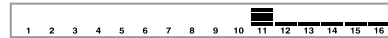

4. If desired, you can change these settings:
  - tone number
  - rhythm number
  - tempo
  - **MODE**

**Note:** Do not change the tempo unless you already know the desired tempo. Pressing **START/STOP** to hear the tempo causes recording to begin.

5. Press **START/STOP** to start recording.
6. Play the keyboard.
 

You can also record auto accompaniment chords, the drum pad, pitch bender, and pedal operations.
7. Press **START/STOP** to end recording.

If you make a mistake, press **START/STOP** to stop recording and begin again from Step 1, or you can edit the contents. See "Editing Memory Contents" on Page 39.

**Note:** Press **▼** after you select Track 1 in Step 3 to use the drum pads. That way, you can also start recording by playing a drum pad.

This data is stored on Track 1 along with the the notes you played:

- tone number
- rhythm number
- rhythm controller (**INTRO**, **NORMAL/FILL-IN**, etc.) operations
- pitch bender operations
- pedal operations
- drum pad operations

See “Recording Multiple Tracks” on Page 37 to record on the other five tracks.

**Notes:**

- When you record on a track that contains data, the new recording replaces the previous recording.
- The touch response setting (on/off) is not recorded. However, the strength of the strike is recorded.
- Channel 1 mixer parameters are automatically recorded to Track 1.
- The memory can store a total of about 5,200 notes. If the remaining memory is less than 100 notes, the measure and beat numbers flash on the display. When memory becomes full, recording automatically stops (and auto-accompaniment or rhythm stops playing, if used).

- Memory contents are saved as long as power is supplied to the keyboard. Unplugging the adapter without batteries or with weak batteries erases the memory. To prevent data loss, connect an adapter before replacing the batteries.
- Turning off the keyboard while recording erases the contents of the track you were recording.
- You can transfer memory contents to another MIDI device. See “Dumping/Importing Data” on Page 45.

## PLAYING BACK FROM MEMORY

1. Press **MEMORY** until **Play No.** appears.
2. Within 5 seconds, use **+** or **-** (or **0** or **1**) to select a song number.
3. Within 5 seconds, press **START/STOP** to play back the song you selected. You can use **TEMPO** to adjust the playback tempo.
4. Press **START/STOP** again to stop playback.

**Notes:**

- You can use layer and/or split during memory playback.
- You can change the rhythm during playback.
- Pressing **START/STOP** during the song restarts the song from the beginning.

- You can set the volume and pan position of the playback tracks using the mixer. This setting data is output through **MIDI OUT**.
- The entire keyboard functions as a melody keyboard during playback, regardless of the **MODE** setting.

## STEP RECORDING

With step recording, you can record a chord progression one chord at a time. Before you start, read these tips. (If you want to record one note at a time, refer to "Recording Multiple Tracks" on Page 37.)

- To start accompaniment with an intro pattern, press **INTRO** after **SYNCHRO/ENDING** in Step 6 of "Step Recording."
- To switch to a rhythm variation, press **VARIATION/FILL-IN** immediately before entering the chord in Step 6 of "Step Recording."
- To insert an ending or fill in, press **SYNCHRO/ENDING** or **NORMAL/FILL-IN** (**VARIATION/FILL-IN** for variation rhythm) immediately before entering the chord in Step 6 of "Step Recording."
- To step-record chords without a rhythm, skip Step 5 of "Step Recording." The chord of the specified length is recorded. A rest can be specified there, so you can create an original chord pattern.
- To add chord accompaniment during rhythm play, enter rests from the beginning of the recording up to where you want accompaniment to start. Then enter only the chords (no rests).

Follow these steps to record chords with step recording.

1. Press **MEMORY** until **REC.No.** appears.
2. Within 5 seconds, use **+** or **-** to select a song number.
3. Press **CHORD/1** to select Track 1.
4. If desired, you can change these settings:
  - rhythm number
  - tempo
  - **MODE**
5. Press **STEP** to start recording.
6. Press **SYNCHRO/ENDING**, then play a chord.
  - Use the chord play method determined by the current **MODE** setting (Fingered, Concert Chord, Full Range Chord, or Normal).
  - When **MODE** is set to **NORMAL**, specify the chord using the root keys and chord-type keys. See "Specifying Chords in the Normal Mode" on Page 36.
7. Use the number buttons to specify the length of the chord. See "Specifying the Length of a Note" on Page 36.
8. For each additional chord you want to enter, play the chord and use the number buttons to specify its length.

9. When you finish recording, press **MEMORY**, **STEP**, or **START/ STOP**.

To play back the song, press **START/ STOP**.

**Notes:**

- To correct entry mistakes, see “Editing Memory Contents” on Page 39.
- When you record on a track that already contains data, the keyboard automatically locates the end of the previous recording — measure, beat, or clock ( $1/48$  of a beat) — and adds your new entry to it.
- You can enter a 0 (a rest) in Step 6, but the rest is ignored when the accompaniment plays.
- This data is stored on Track 1, along with the notes you played:
  - rhythm number
  - **INTRO**, **SYNCHRO/ENDING**, **NORMAL/FILL-IN**, and **VARIATION/FILL-IN** operations

See “Recording Multiple Tracks” on Page 37 to record on the other five tracks.

### Specifying Chords in the Normal Mode

To enter chords when **MODE** is set to **NORMAL** during step recording, you need to specify them using a method other than Concert Chord or Fingered. That way, you can enter 18 chord types using only two keys.

While holding down the desired chord root key, press the chord key to specify the chord.

The root and chord types are labeled above each key. The chord root letter and type of chord also appear on the display as you play a chord.

### Specifying the Length of a Note

During step recording, use the number buttons (or + or -) to specify the length of each note.

Use numbers **1** through **6** to specify whole notes (**1**), half notes (**2**), quarter notes (**3**), eighth notes (**4**), 16th notes (**5**), and 32nd notes (**6**).

Hold down **7** (dot) or **9** (triplicate), then press **1** through **6** to enter the lengths of the notes.

To enter a tie, press **8** and enter the first then the second notes.

To enter a rest, press **0** then use numbers **1** through **9** to specify the length of the rest.

## Correcting Mistakes

Before finishing your step recording entry, you can move the entry point back to correct the data you entered. However, this operation deletes all data after the point where you make corrections.

1. Before you press **MEMORY**, **STEP**, or **START/STOP** to end recording, press **◀**. This moves the entry point back one "space."

The data recorded at the current entry point appears on the display.

2. While monitoring the data on the display, press **◀** or **▶** to move the entry point to the data you want to change.
3. Press **+** and **-** at the same time. **Rewrite?** appears on the display.
4. Press **▼** to clear all data after the current entry point.
5. Press **◀**, **▶**, **+**, or **-** to cancel the rewrite operation. After that, you can press **◀** or **▶** to move the entry point to another location if you want.

**Note:** **TrackEnd** appears on the display if you press **▶** at the end of the recording.

## RECORDING MULTIPLE TRACKS

In addition to Track 1, where you record auto accompaniment as well as keyboard play, there are five other melody tracks that you can use to record melody parts only. You can record different

tones on these tracks and build a full ensemble of instruments.

You can play back what you already recorded on Track 1 (or any other track) while you record on Tracks 2–6.

## Real-Time Recording

1. Repeatedly press **MEMORY** until **Rec. No.** appears.
2. Within 5 seconds, use **+** or **-** to select a song number.
3. Press the desired **MEMORY TRACK** button (**2–6**) to select the track you want to record on.
 

**Note:** Check the display for Channels 11–16 to see which memory tracks contain data and which are empty.
4. If desired, you can change these settings:
  - tone number
  - tempo (to a tempo that is easy for you to follow)
5. Press **START/STOP** to start recording. The contents of any tracks already recorded start to play.
6. Play on the keyboard what you want to record on the selected track.

7. Press **START/STOP** to end recording.

This data is stored on the selected track in addition to the notes you played:

- tone number
- optional pedal operations
- pitch bender operations
- drum pad operations

### Step Recording

1. Repeatedly press **MEMORY** until **Rec. No.** appears.
2. Within 5 seconds, use **+** or **-** to select a song number.
3. Press the desired **MEMORY TRACK** button (**2-6**) to select the track you want to record on.
4. Change the tone, if desired.
5. Press **STEP** to start recording.
6. Use the keyboard or **+** or **-** to enter notes, or **0** to enter rests.
  - When you enter the note using the keyboard with touch response turned on, the key pressure is also recorded.
  - You can also enter the chords using the keyboard.
  - When you use **+** or **-** to enter a note, a staff on the display shows the note you enter.
  - To delete a rest entry, press **0** again.

7. Use **1-9** to enter the length of the note or rest.

8. Repeat Steps 5 and 6 to enter more notes.

9. Press **MEMORY**, **STEP**, or **START/STOP** to end recording.

#### Notes:

- If you make a mistake, see “Correcting Mistakes” on Page 37.
- When you record on a track that already contains data, the keyboard automatically locates the end of the previous recording — measure, beat, or clock ( $1/48$  of a beat) — and appends your new entry from there.
- To record a drum pad part, play a drum pad in Step 5.
- During recording on Tracks 2 through 6, the entire keyboard functions as a melody keyboard, regardless of the current **MODE** setting.
- This data is stored on the selected track in addition to the notes you played:
  - tone number
  - drum pad operations
- You can turn off a specific track during playback by using the mixer function (see “Using the Mixer” on Page 22).

## Changing the Navigation Track

After you record, the display shows the contents of the last recorded or edited track. To display a different track, repeatedly press **TRANSPOSE/TUNE/MIDI** until **Bend** appears, then press **▶** until **Navi. Tr.** appears. Then press **+** or **-** until the track you want appears on the display.

## EDITING MEMORY CONTENTS

You can recall and change individual notes and parameter settings (such as tone number) in memory contents.

Follow these steps to edit memory contents.

1. Repeatedly press **MEMORY** until **Play No.** appears.
2. Within 5 seconds, use **+** or **-** to select a song number.
3. Press **STEP**.
4. Use the **MEMORY TRACK/DRUM PAD** buttons to select the track you want to edit.
5. Repeatedly press **◀** or **▶** to move to the entry point you want to change.

You can change the parameter that is flashing on the display. To change a different parameter, press **▼** so the parameter you want to edit starts flashing.

Make the desired changes to the selected parameter.

The actual procedures you use to change a parameter depend on the type of data it contains. See “Editing Techniques and Display Contents” on Page 40.

### Notes:

- Do not change a note identical to the preceding or succeeding note. Doing so might alter the length of the note and you will have to re-record the entire track.
  - When you change note, key pressure, chord, or drum pad data, the keyboard sounds the new setting so you can hear what it sounds like.
6. Repeat Steps 5 and 6 to edit other parameters.
  7. Press **MEMORY**, **STEP**, or **START/STOP** when you are finished.

### Notes:

- When you interrupt playback of a song and immediately start an editing operation, the entry point (or point of interruption) appears on the editing screen.
- The only parameters that can be edited for Tracks 2–6 are notes, chords, tone, rhythm, key pressure, and drum pad.
- You cannot add data to a recording.
- You cannot move portions of a recording to a different location within the recording.
- You cannot change note lengths.

## Editing Techniques and Display Contents

**Key Pressure (Velocity)** — Use the keyboard, number buttons, or + and – to adjust the key pressure. To change the key pressure using the keyboard, be sure to turn on touch response.

**Pitch** — Enter a new note on the keyboard or use + or – to change to the next higher or lower note. The keyboard and the staff on the display show your new entry.

**Chord** — Use the appropriate chord fingering method as determined by the **MODE** setting.

**Tone Number/Rhythm Number** — Use the number buttons or + or –.

**Rhythm Controller (INTRO, NORMAL/FILL-IN, VARIATION/FILL-IN, SYNCHRO/ENDING)/Drum Pad** — Press the button for the function you want to change to.

## Deleting Individual Data

1. Follow Steps 1–5 under “Editing Memory Contents” on Page 39.
2. Press + and – at the same time. **DataDel?** appears.
3. Press ▼ to delete the selected data.

Or press ◀ or ▶ (or + or –) to cancel the procedure without deleting anything.

## Deleting All Data in a Specific Track

1. Press **MEMORY** until **Rec. No.** appears. Within 5 seconds, use + or – to select a song number.
2. Hold down **MEMORY** until **Tr.Del.?** appears.
3. Within 5 seconds, press the **MEMORY TRACK** number (2–6) for the track(s) you want to delete.
  - You can specify more than one track by pressing more than one button.
  - To deselect a track, simply press its button again.

The track contents indicator(s) for the selected track flash(es).

4. To delete the data in the selected track(s), press ▼. The keyboard goes into playback standby mode.

To exit the track deletion procedure without changing any data, press **MEMORY**.

### Notes:

- You cannot change the song number after **Tr.Del.?** appears.
- You cannot select a track that does not contain any recorded data.



## USING MIDI

Your MD-1200 includes a feature called *MIDI* (Musical Instrument Digital Interface) — the universal standard for sending and receiving performance data between all types of electronic musical instruments, regardless of manufacturer.

Using MIDI, you can play music on your MD-1200 and another instrument at the same time while pressing the keys on only one, record your music to a sequencer, acquire a wider selection of preset tones from a sound module, and much more.

### ABOUT MIDI

Every MIDI-equipped instrument has MIDI OUT and IN terminals, and some also have a MIDI THRU terminal. Each of these terminals serves a different purpose.

MIDI OUT sends MIDI data to (“talks to”) the other MIDI instrument(s).

MIDI IN receives (“listens to”) MIDI data sent by the other MIDI instrument(s).

MIDI THRU lets you connect (“network”) additional MIDI instruments, and sends along to other MIDI devices a copy of all data it receives through its MIDI IN terminal.

The cable that connects MIDI devices does not actually carry sound between them, like a speaker wire carries sound from a receiver to a speaker. Instead, MIDI-equipped devices talk to each other in digital codes (instructions). One MIDI device sends digital instructions representing exactly what is being played on it. The other MIDI device receives and translates those instructions, then produces (or records) the sound exactly as it was played on the first device.

### MAKING THE MIDI CONNECTIONS

Your MD-1200 has **MIDI OUT** and **IN** terminals. To connect your MD-1200 to another MIDI-equipped device, you must use a MIDI cable, available at your local RadioShack store.

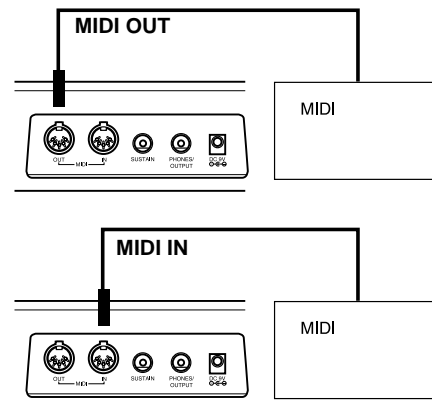

**Cautions:**

- Always turn off power to your MD-1200 and the other MIDI device before you connect or disconnect MIDI cables.
- As you make the cable connections, be sure to align the MIDI cable pins with the matching holes on the MIDI OUT and IN terminals. If you have trouble plugging in the cable, do not force it! You might damage the plug or the instrument.

To send MIDI data from your keyboard, use a MIDI cable to connect the MD-1200's **MIDI OUT** terminal to the other device's MIDI IN terminal.

To receive MIDI data on your keyboard, use a MIDI cable to connect the MD-1200's **MIDI IN** terminal to the other device's MIDI OUT terminal.

**Note:** You do not need to make both connections if you are only either sending or receiving.

**MIDI DATA**

Your MD-1200 can send and receive several different types of MIDI data. The MD-1200's tones, rhythms, and other types of MIDI data are sent automatically as you play.

**Notes:**

- The MD-1200's demonstration tunes cannot be sent as MIDI data.

- For detailed specifications of the MIDI function, see the "MIDI Implementation Chart" on Page 58.

**Note On/Off** specifies which keys are pressed (Note On) or released (Note Off). Also includes how loud a note is played as a value from 0 to 127.

**Notes:**

- The pitch of a note depends on the tone that is being used, as shown in the "Note Table" on Page 52.
- If the keyboard receives a "request" to play notes outside of its range (higher or lower), it automatically selects the same note in the nearest octave.

**Program Change** specifies the tone.

**Pitch Bend** supplies pitch bend information. A Pitch Bend operation on this keyboard changes the pitch of the built-in sound source and sends a Pitch Bend message through the **MIDI OUT** terminal.

**Control Change** adds effects such as vibrato and volume changes applied during keyboard play. The message includes a control number (the effect type) and a control value (the on/off and depth of the effect).

Here is the data that can be sent and received with this keyboard and the corresponding control number.

Effect	Control Number
Bank Select	0, 32
Volume	7
Pan	10
Expression	11
Hold1 (Sustain)	64
Sostenuto	66
Soft Pedal	67
RPN (Registered Parameter Number)	100/101
Data Entry	6/38

Use the Bank Select setting to select the MD-1200's tone groups to be changed by the Program Number message.

- Bank 0 — 0 to 127 (General MIDI tones)
- Bank 1 — 128 to 159 (synthesized tones)
- Bank 2 — 160 to 167 (drum sets)
- Bank 3 — 168 to 199 (user tones)

Just before sending a Program Change message, send two Control Change messages with this data to the MD-1200:

- Control Number = 0, Control Value = <bank number>
- Control Number = 32, Control Value = 0

For example, to select tone number 190 (user tone number 22), enter:

- Control Number = 0, Control Value = 3 (bank number for user tone)
- Control Number = 32, Control Value = 0
- Program Change = 22 (22nd tone in bank 3)

**Note:** Channel 10 is reserved for drum sounds only, so it is not necessary to send bank select data when changing tones.

RPN is used when combining multiple control changes. RPN (100 and 101) selects the parameter to control, and Data Entry (6 and 38) sets the contents of the parameter. On the MD-1200, RPN is used to set pitch bend range, transpose, and tune control from an external MIDI device.

**All Sound Off** forces all sound on the current channel to turn off, regardless of how the sound is being produced.

**All Notes Off** turns off all note data sent from an external device on the channel. The notes being sustained by the pedal continue to sound until the next pedal off signal is received.

**Reset All Controllers** initializes pitch bend and all other control changes.

**System Exclusive** controls fine tone adjustments unique to a particular system. Basically, the system exclusives are unique to a particular system; however, there are “universal” system exclusives that are common among devices produced by individual manufacturers.

These are the system exclusive messages supported by this keyboard.

- **GM Mode On** (**[F0][7E][7F][09][01][F7]**) — used to turn on the MD-1200's GM mode from an external MIDI device.

**Notes:**

- GM (General MIDI) is a standard list of specifications that allows music created on one MIDI device to sound the same when played on another MIDI device. This keyboard's GM mode incorporates most of these specifications.
- This message takes more time to process than other messages; when you program GM Mode On in the sequencer, leave at least a 100 msec pause before the next message.
- **GM Mode Off** (**[F0][7E][7F][09][02][F7]**) — used to turn off the MD-1200's GM mode.
- **Reverb Change** (**[F0][44][0E][09][yy][F7]**) — switches the keyboard's

reverb function. yy determines the type of reverberation effect.

yy Value	Reverb
00	Room
01	Stage
02	Hall
0F	Off

**Note:** The contents of the System Exclusive message affect the entire keyboard. Other messages affect only the current MIDI channel.

## CHANGING MIDI SETTINGS

The MD-1200 lets you change a number of MIDI parameters, including turning General MIDI mode on/off and selecting a MIDI channel.

Follow these steps to change MIDI parameters.

1. Repeatedly press **TRANPOSE/TUNE/MIDI** until **OFF GM Mode** appears.
2. Within 5 seconds, repeatedly press **◀** or **▶** to select the parameter you want to change.

**GM Mode** on/off (Default: Off): set to **on** when you want to have the keyboard receive GM data from another MIDI device. Turning GM mode on automatically turns **CHORD** off, since GM mode and MIDI In Chord Judge cannot be used at the same time.

Set to **oFF** to turn GM mode off. The tone, volume and other parameter settings of each channel are initialized. When playing received MIDI data, bass tones are lowered one octave and the piccolo tone is raised one octave.

**Keybd Ch** (Keyboard Basic Channel) (Default: 01): sets the channel for sending MIDI data to an external device.

**Chord** (MIDI In Chord Judge) (Default: Off): when set to on, the keyboard determines basic channel note data as auto accompaniment chords per the current chord fingering method. Turning GM mode on automatically turns **Chord** off, since GM mode and MIDI In Chord Judge cannot be used at the same time.

**Local** (Local Control) (Default: On): set to on to send data simultaneously to the keyboard's speakers and as MIDI data. Set to **oFF** to send data only as MIDI data (the speakers on the keyboard remain silent).

**AccompOut** (Accompaniment Out) (Default: Off): set to on to send auto accompaniment as MIDI data. Set to **oFF** to turn it off.

3. Within 5 seconds, use **+** or **-** to change the setting of the parameter.

## DUMPING/IMPORTING DATA

The MD-1200's internal data, including data recorded to memory and synthesizer data, can be sent and received in bulk as MIDI exclusive data through the MIDI terminals. Thus, you can use a computer or other MIDI device as an external storage device.

First make connections from the **MIDI IN** and **MIDI OUT** terminals to an external device using MIDI cables.

**Note:** Some software does not support MIDI exclusive data.

### Dumping Data

Follow these steps to dump data from the keyboard to an external device.

1. Put the other device in its receive standby mode.
 

See the owner's manual that comes with the receiving device for details.
2. Repeatedly press **TRANPOSE/TUNE/MIDI** on the MD-1200 until the display shows **BulkSnd?**.
3. Within 5 seconds, press **▼** to start data send. Sending appears. The MD-1200 automatically exits the data transfer mode after all the data is sent.

## Importing Data

Follow these steps to import dumped data from another device.

1. Repeatedly press **TRANPOSE/TUNE/MIDI** so the display shows **BulkSnd?**.
2. Within 5 seconds repeatedly press **◀** or **▶** so the display shows **BulkRcv?**.
3. Within 5 seconds, press **▼** to prepare the keyboard to receive data.
4. Start the send operation on the sending device. See the owner's manual that comes with the connected device for details. The MD-1200 automatically exits the data transfer mode after all the data is received.

## NOTES ABOUT THE MIDI IMPLEMENTATION CHART

The "MIDI Implementation Chart" on Page 58 illustrates the details of the MD-1200's MIDI function. An O in the chart means that the MD-1200 has this feature; X means it does not have this feature. This section explains what the MD-1200 can do.

**Basic Channel** — MIDI uses up to 16 channels to exchange data. As in a TV broadcast, different channels send different data.

**Mode** — The chart shows that Mode 3 is OMNI OFF, POLY. This means the MD-1200 sends and receives polyphonic data on only one channel at a time.

**Note Number** — This number represents each key of the keyboard. The lowest number (0) is five octaves below middle C. Since the MD-1200's lowest note is two octaves below middle C and the highest is three octaves above middle C, your keyboard can send a note number between 36 and 96. But, it can receive all 0 through 127 note numbers, so those keys outside the MD-1200's key range are interpreted as notes inside the key range.

**Velocity** — This number shows how fast the key was pressed, or how loud the note should sound. 1 is the lowest velocity, pianissimo; 127 is the loudest, fortissimo. 0 means the key is released.

**9n** — This means that the Note On message is 9 hexadecimal, and n is the channel number.

For example, if you select Channel 16 and press Key D in mezzo-piano, 9E (E is 15 in hexadecimal; note that Channel 1 is 0 in MIDI data) is first sent from MIDI OUT, then 3D (decimal 61) is sent as the key number, finally 21 (decimal 33) is sent as velocity.

**Pitch Bender** — The MD-1200 sends and receives pitch bending signals.



---

**Control Change** — This feature sends data on various controllers, each having its own number. For the details of each parameter, see “MIDI Data” on Page 42.

**Program Change** — This feature changes the preset sounds. Each sound number corresponds to a program number between 0 and 127.

**System Exclusive** — This feature sends special signals unique to the MD-1200. For details, see “MIDI Data” on Page 42.

**System Real Time** — “Clock” is like a metronome to send the synchronizing signal.

System real time commands send three kinds of signals — *start* tells the keyboard to start playing from the beginning, *stop* tells all the synchronized instruments to stop playing, and *continue* is similar to start, but it signals the music to begin at whatever point it was last stopped.

**All Notes Off** — This feature is a kind of panic button: it stops the sounds currently playing. The MD-1200 only receives this message.

**Active Sensing** — This means the MD-1200’s sound turns off in the event the connection cable to **MIDI IN** terminal is accidentally disconnected.

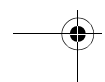
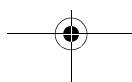
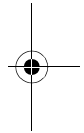
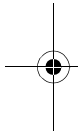

## TROUBLESHOOTING

If the MD-1200 is not performing as it should, these suggestions might help. If you still cannot solve the problem, take the keyboard to your local RadioShack store for assistance.

Trouble	Possible Cause	Remedy	
No sound, even if keys are pressed.	The keyboard has turned off automatically.	Turn <b>POWER</b> on again.	
	Volume is turned down.	Turn up the volume.	
	Headphones are connected.	Disconnect headphones.	
	Power supply problem.		Make sure the batteries are facing correctly to match the marked polarity (+/-).
			Replace the batteries with fresh ones.
			Connect the AC adapter properly.
You are pressing too few accompaniment keys while <b>MODE</b> is set to <b>FINGERED</b> .		Set <b>MODE</b> to <b>NORMAL</b> or <b>CONCERT CHORD</b> .	
		Press 3 or 4 keys to form a chord while <b>MODE</b> is set to <b>FINGERED</b> .	
No sound when connected to an external amplifier.	Volume is turned down.	Turn up the volume on the keyboard and amplifier.	
	Defective connection cord.	Replace the connection cord.	



## CARE AND MAINTENANCE

---

Your Optimus MD-1200 Electronic Keyboard is an example of superior design and craftsmanship. The following suggestions will help you care for your MD-1200 so you can enjoy it for years.



Keep the MD-1200 dry. If it gets wet, wipe it dry immediately. Liquids might contain minerals that can corrode the electronic circuits.



Use and store the MD-1200 only in normal temperature environments. Temperature extremes can shorten the life of electronic devices, damage batteries, and distort or melt plastic parts.



Keep the MD-1200 away from dust and dirt, which can cause premature wear of parts.



Handle the MD-1200 gently and carefully. Dropping it can damage circuit boards and cases and can cause the MD-1200 to work improperly.



Use only fresh batteries of the required size and recommended type. Batteries can leak chemicals that damage your MD-1200's electronic parts.



Wipe the MD-1200 with a damp cloth occasionally to keep it looking new. Do not use harsh chemicals, cleaning solvents, or strong detergents to clean the MD-1200.

Modifying or tampering with the MD-1200's internal components can cause a malfunction and might invalidate its warranty. If your MD-1200 is not performing as it should, take it to your local RadioShack store for assistance.



# SPECIFICATIONS

Number of Keys .....	61
Drum Pads .....	6
Polyphonic Sound .....	24-note (Max.)
Preset Tones .....	200 (128 General MIDI, 32 synthesized, 32 user, 8 drum sets) with Layer and Split
Rhythm Instrument Tones .....	61
Digital Effects .....	3 reverb types (HALL, STAGE, ROOM)
Demo Tunes .....	2

## Auto Accompaniment

Rhythm Patterns .....	100
Tempo .....	Variable (216 steps, 40 to 255)
Chords .....	3 fingering methods (Concert Chord, Fingered, Full Range)
Rhythm Controller: Start/Stop, Intro, Normal/Fill-In, Variation/Fill-In, Synchro/Ending	
Accompaniment Volume .....	0 to 127 (128 steps)
Free Session .....	100 patterns (auto accompaniment in accordance with selected chord progression)

## Memory Function

Songs .....	2
Recording Tracks .....	6 (2 through 6 are melody tracks)
Recording Methods .....	Real-time, Step
Memory Capacity .....	Approximately 5,200 notes (total for two songs)
Edit Function .....	Equipped

## Custom Tone Synthesizer Function

Parameters .....	PCM set, amp envelope set, attack rate, release rate, pitch envelope set, pitch, level, touch sense, pan
------------------	---

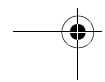
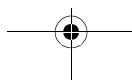



### Mixer Function

Channels .....	16
Parameters .....	Program change number, volume, expression, pan, coarse tuning, fine tuning, on/off/solo
MIDI .....	16 multi-timbre receive, GM Level 1 standard
Transpose .....	-12 semitones to +12 semitones
Tuning .....	Adjustable A4 = 440 Hz ±50 cents
Pitch Bend Range .....	12 semitones up and down
Built-In Speakers .....	12 cm × 2

### Terminals

MIDI Terminals .....	IN, OUT
Assignable Terminal .....	1/4-Inch Phone Jack (sustain, sostenuto, soft, rhythm start/stop)
Power Supply .....	9V DC Jack
Headphones Stereo Standard Jack .....	Output Impedance: 150 Ohms Output Voltage: 3.5 V (RMS) MAX at 47K ohm load
Power Sources .....	DC: 6 D batteries AC: 9V with AC adapter
Power Consumption .....	7.7 W
Dimensions (HWD) .....	5 <sup>15</sup> / <sub>16</sub> × 37 <sup>7</sup> / <sub>16</sub> × 14 <sup>13</sup> / <sub>16</sub> Inches (15.2 × 94.5 × 37.6 cm)
Weight (Without Batteries) .....	12 lbs (5.5 kg)
Included Accessory .....	Sheet Music Stand

Specifications are typical; individual units might vary. Specifications are subject to change and improvement without notice.

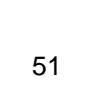
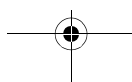

# APPENDIX

## NOTE TABLE

(1)	(2)	(3)	(4)	(5)	(1)	(2)	(3)	(4)	(5)	(1)	(2)	(3)	(4)	(5)	(1)	(2)	(3)	(4)	(5)
000	24	1	A	A0 - C8	010	12	2	A	C4 - C6	020	24	1	A	C2 - C7	030	24	1	A	E2 - D6
001	24	1	A	A0 - C8	011	24	1	A	F3 - F6	021	12	2	A	F3 - F6	031	24	1	A	E2 - D6
002	12	2	A	A0 - C8	012	24	1	A	C3 - C6	022	24	1	A	C4 - C6	032	24	1	B	E1 - G3
003	12	2	A	A0 - C8	013	24	1	A	F4 - C7	023	12	2	A	F3 - F6	033	24	1	B	E1 - G3
004	24	1	A	E1 - G7	014	24	1	A	C4 - F5	024	24	1	A	E2 - C6	034	24	1	B	E1 - G3
005	24	1	A	E1 - G7	015	12	2	A	C4 - C6	025	24	1	A	E2 - C6	035	24	1	B	E1 - G3
006	24	1	A	F2 - F6	016	12	2	A	C2 - C7	026	24	1	A	E2 - D6	036	24	1	B	E1 - G3
007	24	1	A	C2 - C7	017	12	2	A	C2 - C7	027	24	1	A	E2 - D6	037	24	1	B	E1 - G3
008	24	1	A	C4 - C8	018	12	2	A	C2 - C7	028	24	1	A	E2 - D6	038	24	1	B	E1 - G3
009	24	1	A	C5 - C8	019	12	2	A	A0 - C8	029	24	1	A	E2 - D6	039	24	1	B	E1 - G3
(1)	(2)	(3)	(4)	(5)	(1)	(2)	(3)	(4)	(5)	(1)	(2)	(3)	(4)	(5)	(1)	(2)	(3)	(4)	(5)
040	24	1	A	G3 - C7	050	24	1	A	C2 - C7	060	12	2	A	F2 - F5	070	24	1	B	A#1 - C5
041	24	1	A	C3 - C6	051	12	2	A	C2 - C7	061	24	1	A	C2 - C7	071	24	1	A	D3 - G6
042	24	1	A	C2 - C5	052	24	1	A	C3 - G5	062	12	2	A	C2 - C7	072	24	1	C	D5 - C8
043	24	1	B	E1 - G3	053	24	1	A	C3 - G5	063	12	2	A	C2 - C7	073	24	1	A	C4 - C7
044	24	1	A	E1 - C7	054	12	2	A	C3 - C6	064	24	1	A	F#3 - D#5	074	24	1	A	C4 - C7
045	24	1	A	E1 - C7	055	12	2	A	C3 - C5	065	24	1	A	C#3 - G#5	075	24	1	A	C4 - C7
046	24	1	A	B0 - G7	056	24	1	A	A#3 - A#6	066	24	1	A	F#2 - D#5	076	12	2	A	C4 - C7
047	24	1	B	C2 - A3	057	24	1	A	A#1 - D#5	067	24	1	B	C#2 - G#4	077	24	1	A	G3 - C6
048	24	1	A	E1 - C7	058	24	1	B	F1 - G3	068	24	1	A	A#3 - G6	078	24	1	A	C4 - C7
049	24	1	A	E1 - C7	059	24	1	A	A#3 - A#5	069	24	1	A	E3 - A5	079	24	1	A	C4 - C6
(1)	(2)	(3)	(4)	(5)	(1)	(2)	(3)	(4)	(5)	(1)	(2)	(3)	(4)	(5)	(1)	(2)	(3)	(4)	(5)
080	12	2	A	A0 - C8	090	12	2	A	C2 - C7	100	12	2	A	C2 - C7	110	12	2	A	G3 - C7
081	12	2	A	A0 - C8	091	12	2	A	C2 - C7	101	12	2	A	C2 - C7	111	24	1	A	C3 - C5
082	12	2	A	C2 - C7	092	12	2	A	C2 - C7	102	12	2	A	C2 - C7	112	24	1	A	C5 - C6
083	12	2	A	C2 - C7	093	12	2	A	C2 - C7	103	12	2	A	C2 - C7	113	24	1	A	C4 - C5
084	12	2	A	C2 - C7	094	12	2	A	C2 - C7	104	24	1	A	C3 - F5	114	12	2	A	E3 - E5
085	12	2	A	C2 - C7	095	12	2	A	C2 - C7	105	24	1	A	C3 - C6	115	24	1	D	C4 - C5
086	12	2	A	C2 - C7	096	12	2	A	C2 - C7	106	24	1	A	D3 - G5	116	24	1	D	C4 - C5
087	12	2	A	A0 - C8	097	12	2	A	C2 - C7	107	24	1	A	G3 - C6	117	24	1	D	C4 - C5
088	12	2	A	C2 - C7	098	12	2	A	C2 - C7	108	24	1	A	C3 - G5	118	12	2	D	C4 - C5
089	24	1	A	C2 - C7	099	12	2	A	C2 - C7	109	12	2	A	C2 - F5	119	24	1	D	C4 - C5
(1)	(2)	(3)	(4)	(5)															
120	24	1	D	C4 - C5															
121	24	1	A	C4 - C5															
122	12	2	D	C4 - C5															
123	24	1	D	C4 - C5															
124	24	1	D	C4 - C5															
125	24	1	D	C4 - C5															
126	12	2	D	C4 - C5															
127	24	1	D	C4 - C5															

**Legend:**

1. Tone number
2. Maximum polyphony
3. Digital Controlled Oscillator
4. Range type
5. Recommended sound range for General MIDI

\* Tones without scale

\* The following shows maximum polyphone for synthesized tones 128 through 159:

141 BASS SLIDE: 24 notes

Other tones: 12 notes

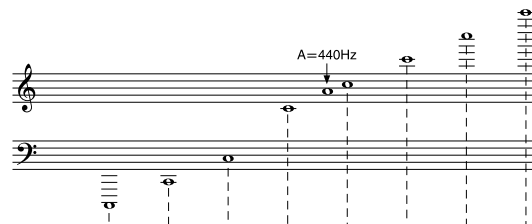

Range Type	C-1	C0	C1	C2	C3	C4	C5	C6	C7	G7	C8	C9	G9	
<b>A</b> (Standard type)														
<b>B</b> (Low pitch instruments)														
<b>C</b> ("072 PICCOLO" only)														
<b>D</b> (Sound Effect)	No scale for tones.													



.....Range of keyboard play



.....Playable range (Transpose, when receiving MIDI data)



.....Range in which same note is played in nearest octave as a result of transpose and MIDI data receive operation. (Transpose, when receiving MIDI data)

# FREE SESSION CHORD PROGRESSION CHART

NO.	RHYTHM NAME	TEMPO	TOINE	CHORD PROGRESSION
<b>POP I</b>				
00	CLUB POP	110	18	Cm7   Fm7   Gr   Cm7   Cm7   Fm7   Dm7   Cm7
01	EURO POP	130	82	Cm7   Fm7   B7   E7   Cm7   Fm7   B7   Gr
02	90'S POP	128	65	C   Em   F   Dm   G   C   Em   F   Gsus4   G
03	8 BEAT	120	00	C   Cm7   Am7   C   F   C   Dm7   Gr
04	8 BEAT BALLAD 1	74	73	Cm7   Em7   Fm7   Em   Asus4   Dm7   Gsus4   G   Am   Dm7   Gr
05	8 BEAT BALLAD 2	61	61	C   Dm7   Am7   Em   Dm7   C   Dm7   Em   F   Gsus4
06	60'S 2 BEAT	96	61	C   Dm7   Am7   Em   Dm7   C   Dm7   Em   F   Gsus4
07	16 BEAT	110	26	Cm   Cm7   Fm7   B7   Em7   Am7   Fm7   Gsus4   G
08	16 BEAT BALLAD	68	75	C   Cm7   Am7   C   F   Fm7   Dm7   F   G   Gr   Em   Dm7   Gr   C   F   G   Dm7   Gr
09	16 BEAT SHUFFLE	100	83	C   C   Cm7   Dm7   Em7/2   Dm7   Fm7   Em7   Dm7   C   C   F/4   C   C   F/4
<b>POP II</b>				
10	POP 1	110	27	C   Cm7   Am7   Cm7   Cm7   Am7   Dm7   Dm7   Fm7   Cm7   Am7   Dm7   Dm7   Gr
11	POP 2	130	18	C   F   C   C   C   F   G   G   C   F   C   C   B7   F   C   C
12	70'S ROCK 1	140	66	C   Em   F   G   C
13	POP BALLAD	68	85	C   G   F   G   C
14	16 BEAT SOUL	130	53	Cm7   Cm7   Cm7   Cm7   Gm7   Gm7   Cm7   Cm7   Am7   Cm7   Am7   Am7   Gsus4   G
15	SOUL POP	95	18	Cm7   Cm7   Cm7   Gm7   Gm7   Cm7   Am7   Am7   Cm7   Am7   Am7   Am7   Gsus4   G
16	WORLD POP	108	64	Cm7   Bm7   Am7   Dm7   G
17	FUSION SHUFFLE	88	85	C   Am7   Dm7   Gsus4   G
18	60'S BALLAD	156	04	C   Gsus4   A   Dm7   G   F   Em   Am   Dm7   Gr
19	70'S R&B BALLAD	60	64	C   Bm7   E7   Am7   Gm7   C   F5   F#m7   G/4   Ar   D7   Gr   E7   Ar   C   Bm7   E7   Am7   Gm7   C   F5   F#m7   G/4   Ar   D7   Gr   C   Gaus4
<b>TRAP/POP</b>				
20	TRAP HOP	88	64	C   G   Am   Em   F   C   F   G
21	TRAP HOP	88	91	Cm   Dm   Cm   Gm   Gr
22	TECHNO 1	140	86	Cm   E7   Ar   Gr
23	TECHNO 2	136	85	C   Fm7   C   Fm7   Dm7   Fm7   C   Fm7
24	FUNKY GROOVE	112	66	Csus4   C7   Csus4   B7   Csus4   C7
25	DRUM & BASS	84	64	Am   Fm   Am   Fm   Am   Fm   Dm7   Gsus4
26	RAVE	132	80	C   C   Ar   B7
27	TRANCE	122	80	C   C   Ar   B7
28	DISCO	120	48	C   C   Am   Am   F5   F5   Gsus4   Gr
29	FUNK	104	66	C   C   C   C   F   F   C   C   G   G   C   C
<b>ROCK I</b>				
30	AMERICAN ROCK	96	85	C   C   Am   Am   F   F   C   C
31	ROCK	110	30	C   G   Am   F   C   G   F   C
32	70'S ROCK 2	120	28	C   B7   F   C
33	HUFF ROCK	132	28	C   C   C   F   C   C   F   C   G   C   C
34	POP ROCK	150	28	C   B7   C   C   B7   C   C   F   C   G   C   C
35	POP ROCK	150	28	C   Am   C   Am   Dm7   Dm7   Gsus4   Gr
36	SLOW ROCK	120	18	C   Am   Fm7   Dm7   Gr
37	SLOW ROCK 1	72	30	C   Am   Dm   Gr   Em   Am   Dm   Gr
38	SLOW ROCK 2	72	18	C   9/4   Am   Em7/4   F   F/4   G   C   G
39	ROCK WALTZ	96	48	C   C   F   G   F   G   C   C   C   C7   F   G   F/4   9/4   C   Gsus4
<b>ROCK II</b>				
40	BIG BAND ROCK	110	65	Cm   Gm   Ar   Fm   Cm   Gm   Ar   Fm   E7   Ar   E7   Ar   Dm7   Gr
41	SHUFFLE ROCK	130	01	C   C   C   C   F7   C   C   Gr   Fr   Fr   C   C   C   C   G
42	OLDIES POP	144	67	C   Am   F   G
43	OLDIES SHUFFLE	120	88	C   C   C   Cm7   Dm7   Gr   Dm7   Gr   C   C   Cm7   Dm7   Gr   C   C   Cm7   Dm7   Gr   C   C   F/4
44	BOOGIE-WOOGIE	156	59	C   C   C   C   F   F   C   C   Dm   G   C   C
45	50'S ROCK	168	66	C   C   C   C   Gr   F   F   C   C   G   Fr   C7
46	TWIST	150	66	C   C   C   C   F   F   C   C   G   Fr   C7
47	NEW ORLEANS R&B	156	86	C7   C7   C7   C7   Fr   Fr   C7   C7   Fr   C7   C7
48	CHICAGO BLUES	126	28	C   C   C   F   F   C   C   G   F   C   C
49	R&B	126	18	C7   C7   C7   C7   Fr   Fr   C7   C7   Fr   C7   C7

No.	RHYTHM NAME	TEMPO	TOPE	TONE
50	BIG BAND 1	140	57	C   Am   Dm   Gr   Faug   Am   C7   F   Fms   C   Am   Dm   G
51	BIG BAND 2	156	71	CmFr   CmFr   CmFr   AmFr   DmFr   Gr   DmFr   DmFr   DmFr   1/2   G7   CmFr   C6
52	SWING 1	122	57	C   CmFr   AmFr   C   F   FmFr   DmFr   F   G   Gr   Emr   Amr   DmFr   G   C   C
53	SWING 2	156	57	C   Er   Ar   Ar   DmFr   Gr   C   Ar   Dr   Gr
54	SLOW SWING	84	59	C   AmFr   DmFr   C   AmFr   DmFr   Gr   C   Emr3   F6   Fms   Emr   Er7   DmFr   Gr   C   Amr   DmFr   Gr   C   Emr3   F6   Fms   1/2   Gr   C
55	ORCH SWING	90	48	C   CmFr   AmFr   C   DmFr   Emr   FmFr   DmFr   G
56	WALTZ	156	48	C7   Gr   C7   C7   F   C   Gr   C7
57	WALTZ VOICES	156	53	F   C   Gr   C7
58	WALTZ	156	53	F   C   Gr   C7
59	ACID WALTZ	96	67	Cm   GmFr   Cm   GmFr   Fm   GmFr   Cm   GmFr
59	WALTZ	166	11	C   Emr3   Er   Amr   Ar7   GmFr   C7   FmFr   FmFr   B7   EmFr   Emr   Ar7   CmFr   DmFr   Gr   Emr   Er7   DmFr   Gr
<b>EUROPEAN</b>				
60	POLKA 1	118	71	C   C   C   Gr   Gr   Gr   C   F   C   F   C   C   Gr   Gr   C   C
61	POLKA 2	120	71	C   Dm   Gr   C   F   C   Dr   Gr
62	MARCH 1	110	71	C   C7   F   Gr   C   Gr   C   C7   F   Gr   C
63	MARCH 2	122	72	C   C   F   C   Gr   C   Dr   Gr   C   C   F   C   F   Fm   1/2   Am   1/2   Dr   Gr   C
64	MARCH 3	120	56	C   C   F   F   C   C   G   C   C   C   C   F   Fm   C   G   C   Gr
65	WALTZ	90	00	C   CmFr   AmFr   C   DmFr   Gr   Faug   AmFr   FmFr3   FmFr   G   C   Gr
66	FRENCH WALTZ	170	21	C   Dm   Em   F   C   C   F   C   C   F   Fm   C   C   C   G
67	BALLROOM WALTZ	84	71	CmFr   Emr   DmFr   G   CmFr   Amr   DmFr   Gr
68	WIENNESE WALTZ	156	48	C   C   C   C   C   C   Dm   Dm   Dm   Gr   Dm   G   C   C
69	TANGO	125	40	Cm   CmFr   CmFr   AmFr3   Fms   Gr   Cm   Gr
<b>LATINI</b>				
70	BOSSA NOVA 1	140	73	C   C   D7   D7   DmFr   C7   C   C
71	BOSSA NOVA 2	150	24	CmFr   CmFr   FmFr   Emr   DmFr   Gr
72	SAMBA 1	96	61	C   C   Dm   Gr   Dm   Gr   C   Dm   C   Dm   C   C
73	SAMBA 2	100	56	Cm   Gm   Cm   Gm   Cm   Gm   Fm   Gm   Cm
74	BEGUINE	98	48	C   C   C   C   G   C   C   F   Fm   C   C   G   G   C   C
75	WAMBO	100	13	C   F   Dm   Gr
76	RHUMBA	120	48	C   C   DmFr   DmFr   Gr   Gr   C   C
77	CHA-CHA-CHA	120	96	CmFr   F7   DmFr   Gr   CmFr   F7   BmFr   BmFr
78	WERENGUE	124	61	CmFr   F7   BmFr   GmFr   CmFr   F7   BmFr   BmFr
79	BOLETO	90	48	CmFr   F7   BmFr   B7
<b>MIXT VARIOUS I</b>				
80	SALSA	96	56	C   G7   Gr   C   Ar   Dm   Gr   C
81	BEGGAE	120	07	Cm   Gm
82	PUNTA	115	01	C   C   C   Gr   Gr   Gr   Gr   C   C   C   C   C   C   C
83	CUMBIA	105	13	C   Gr   Gr   C   F   C   Gr   C
84	PASODOBLE	125	59	C   C   C   C
85	RUMBA CATALANA	115	56	C   C   C   Gr   G   G   G   C   C   C   C   C
86	SEVILLANA	180	25	C   C   C   G   F   G   C   C
87	SKA	132	16	C   DmFr   Gr   C
88	TEX-MEX	120	21	C   Gr   Gr   C
89	TOWNSHIP	124	61	C   F   G   F
<b>VARIOUS II</b>				
90	COUNTRY	100	40	C   F   C   G   C   F   C   G   C
91	BLUEGRASS	108	40	C   F   C   G   C   F   C   G   C
92	FAST GOSPEL	112	18	C   F   C   G   C   F   C   G   C
93	SLOW GOSPEL	116	18	C   F   C   G   C   F   C   G   C
94	HAWAIIAN	113	99	C   C   F   F   F   G   Gr   C   Gr
95	BROADWAY	140	48	C   C   Gm   DmFr   Gr   DmFr   C   C   C7   F   F   C   G7   C
96	EURO FOX	135	56	C   Am   DmFr   Gr   Faug   Am   GmFr   CmFr   Fms   C   Am   DmFr   Gr
97	QUICKSTEP	200	17	C   F   C   Gr   C   F   C   G   C
98	ADANI	170	70	C   C   C   F   C   C   G   C
99	BALAUJ	120	16	C   C   C   G   G   C   C   C7   G

## DRUM ASSIGNMENT LIST

Key/Note number	Drumset 1 STANDARD SET	Drumset 2 ROOM SET	Drumset 3 POWER SET	Drumset 4 VOICE SET	Drumset 5 SYNTH SET	Drumset 6 JAZZ SET	Drumset 7 BRUSH SET	Drumset 8 ORCHESTRA SET
E1 28	HIGH C	---	---	---	---	---	---	ORCHESTRA SET
F1 29	SCRATCH PULL	---	---	---	---	---	---	CONCERT SNARE
F#1 30	STICKS	---	---	---	---	---	---	PEDAL HH/HAT
A1 31	SQUARE CLICK	---	---	---	---	---	---	OPEN HH/HAT
A1 33	METRONOME CLICK	---	---	---	---	---	---	RIDE CYMBAL 1
B1 35	ACOUSTIC BASS DRUM	POWER BASS DRUM 2	POWER BASS DRUM 2	SYNTH BASS DRUM 1	SYNTH BASS DRUM 2	JAZZ BASS DRUM 2	JAZZ BASS DRUM 2	JAZZ BASS DRUM 1
C2 36	ACOUSTIC SNARE	POWER BASS DRUM 1	POWER BASS DRUM 1	SYNTH BASS DRUM 1	SYNTH BASS DRUM 1	JAZZ BASS DRUM 1	JAZZ BASS DRUM 1	CONCERT BASS DRUM
C#2 37	SIDE STICK	ROOM SNARE 1	POWER SNARE 1	VOICE SNARE	SYNTH SNARE 1	JAZZ SNARE 1	BRUSH TAP	CONCERT SNARE
D2 38	ACOUSTIC SNARE 2	ROOM SNARE 2	POWER SNARE 2	SYNTH SNARE 1	SYNTH SNARE 2	JAZZ SNARE 2	BRUSH SWIRL	CASIANETS
E2 40	LOW FLOOR TOM	ROOM LOW FLOOR TOM	ROOM LOW FLOOR TOM	SYNTH LOW FLOOR TOM	SYNTH LOW FLOOR TOM	---	---	CONCERT SNARE
F2 41	CLOSED HH/HAT	ROOM HIGH FLOOR TOM	ROOM HIGH FLOOR TOM	VOICE CLOSED HH/HAT	SYNTH CLOSED HH/HAT 1	---	---	TIMPAN F
G2 43	HIGH FLOOR TOM	ROOM LOW FLOOR TOM	ROOM HIGH FLOOR TOM	SYNTH HIGH FLOOR TOM	SYNTH HIGH FLOOR TOM	---	---	TIMPAN G
A2 44	PEDAL HH/HAT	ROOM LOW TOM	ROOM LOW TOM	VOICE PEDAL HH/HAT	SYNTH CLOSED HH/HAT 2	---	---	TIMPAN A
B2 47	OPEN HH/HAT	ROOM LOW MID TOM	ROOM LOW TOM	SYNTH LOW TOM	SYNTH LOW TOM	---	---	TIMPAN B
B2 48	LOW MID TOM	ROOM LOW MID TOM	ROOM LOW MID TOM	SYNTH LOW MID TOM	SYNTH LOW MID TOM	---	---	TIMPAN C
C3 48	HIGH MID TOM	ROOM HIGH MID TOM	ROOM HIGH MID TOM	SYNTH HIGH MID TOM	SYNTH HIGH MID TOM	---	---	TIMPAN D
C#3 49	CRASH CYMBAL 1	ROOM HIGH TOM	ROOM HIGH TOM	SYNTH CYMBAL	SYNTH CYMBAL	---	---	TIMPAN E
D3 50	HIGH TOM	ROOM HIGH TOM	ROOM HIGH TOM	SYNTH HIGH TOM	SYNTH HIGH TOM	---	---	TIMPAN E
E3 52	RIDE CYMBAL 1	---	---	---	---	---	---	TIMPAN F
F3 53	CHINESE CYMBAL	---	---	---	---	---	---	---
F#3 54	TAMBOURINE	---	---	---	---	---	---	---
G3 55	CHINESE CYMBAL	---	---	---	---	---	---	---
A3 56	CRASH CYMBAL 2	---	---	---	---	---	---	---
A3 57	CRASH CYMBAL 2	---	---	---	---	---	---	---
B3 59	VBRA-SLAP	---	---	---	---	---	---	---
B3 59	RIDE CYMBAL 2	---	---	---	---	---	---	CONCERT CYMBAL 2
C4 60	HIGH BONGO	---	---	---	---	---	---	---
C#4 61	LOW BONGO	---	---	---	---	---	---	---
D4 62	MUTE HIGH CONGA	---	---	---	---	---	---	---
E4 64	OPEN HIGH CONGA	---	---	---	---	---	---	---
F4 65	LOW CONGA	---	---	---	---	---	---	---
F#4 66	HIGH CONGA	---	---	---	---	---	---	---
G4 67	LOW TAMBALS	---	---	---	---	---	---	---
A4 68	HIGH AGOGO	---	---	---	---	---	---	---
A4 69	LOW AGOGO	---	---	---	---	---	---	---
B4 70	CABASA	---	---	---	---	---	---	---
B4 71	MARACAS	---	---	---	---	---	---	---
C5 72	SHORT WHISTLE	---	---	---	---	---	---	---
C5 72	LONG WHISTLE	---	---	---	---	---	---	---
D5 74	SHORT GUIRO	---	---	---	---	---	---	---
E5 76	CLAVES	---	---	---	---	---	---	---
E5 76	CLAVES	---	---	---	---	---	---	---
F5 77	HIGH WOOD BLOCK	---	---	---	---	---	---	---
F#5 78	LOW WOOD BLOCK	---	---	---	---	---	---	---
G5 79	MUTE CUICA	---	---	---	---	---	---	---
A5 81	OPEN CUICA	---	---	---	---	---	---	---
A5 81	MUTE TRIANGLE	---	---	---	---	---	---	---
B5 83	OPEN TRIANGLE	---	---	---	---	---	---	---
B5 83	SHAKER	---	---	---	---	---	---	---
C6 84	BELL TREE	---	---	---	---	---	---	---
C6 84	BELL TREE	---	---	---	---	---	---	---
D6 86	CASTANETS	---	---	---	---	---	---	---
D6 86	CASTANETS	---	---	---	---	---	---	---
E6 88	MUTE SURDO	---	---	---	---	---	---	---
E6 88	MUTE SURDO	---	---	---	---	---	---	---
E6 88	OPEN SURDO	---	---	---	---	---	---	---
E6 88	APPLAUSE	---	---	---	---	---	---	---



## FINGERED CHORD CHART

Chord Type Root	M	m	7	m7	dim7	M7	m7 <sup>b</sup> 5	dim	aug	sus4	7sus4	madd9	mM7	7 <sup>b</sup> 5	add9
C															
C <sup>♯</sup> /D <sup>♭</sup>															
D															
D <sup>♯</sup> /E <sup>♭</sup>															
E															
F															
F <sup>♯</sup> /G <sup>♭</sup>															
G															
G <sup>♯</sup> /A <sup>♭</sup>															
A															
A <sup>♯</sup> /B <sup>♭</sup>															
B															

# MIDI IMPLEMENTATION CHART

FUNCTION		TRANSMITTED	RECOGNIZED	REMARKS
Basic Channel	Default Changed	1-16 <sup>*1</sup> 1-16	1-16 1-16	<sup>*1</sup> Held in memory with power supplied
Mode	Default Messages Altered	Mode 3 X *****	Mode 3 X *****	
Note Number:	True voice	24-96 *****	0-127 1-108 <sup>*2</sup>	<sup>*2</sup> See "Note Table" on Page 52
Velocity	Note ON Note OFF	O 9nH v=1-127 X 9nH v=0	O 9nH v=1-127 X 9nH v=0, 8nH v=XX	XX=no relation
After Touch	Keys Channels	X X	X O	
Pitch Bender		O	O <sup>*3</sup>	
Control Change	0, 32 1 6, 38 7 10 11 64 66 67 100, 101 120 121	O X O <sup>*4</sup> O O O O <sup>*5</sup> O <sup>*5</sup> O <sup>*5</sup> O <sup>*4</sup> X X	O O <sup>*3</sup> O <sup>*4</sup> O O O O O O <sup>*4</sup> O O	Bank Select Modulation Data entry Volume Pan Expression Hold 1 Sostenuto Soft pedal RPN LSB, MSB All sound off Reset all controller
Program Change:	True #	O 0-99 *****	O 0-127 *****	
System Exclusive		O <sup>*6</sup>	O <sup>*6</sup>	
System Common	: Song Pos : Song Sel : Tune	X X X	X X X	
System Real Time	: Clock : Commands	O O	X X	
Aux Messages	: Local ON/OFF : All notes OFF : Active Sense : Reset	X X X X	X O O X	

Remarks

- <sup>\*3</sup> Modulation and after touch for each channel are the same effect.
- <sup>\*4</sup> Pitch bend sense, fine tune, coarse tune send/receive, and RPN Null receive
- <sup>\*5</sup> In accordance with assignable jack setting
- <sup>\*6</sup> GM on/off GM ON:[F0][7E][7F][09][01][F7]  
GM OFF: [F0][7E][7F][09][02][F7]  
Reverb change [F0][44][0E][09][XX][F7] XX=00: ROOM, 01: STAGE, 02: HALL, 0F: OFF  
Bulk dump [F0] [44][0E][01] [0L<sub>0</sub>][0H<sub>0</sub>]...[0L<sub>127</sub>][0H<sub>127</sub>] [0L<sub>CS</sub>][0H<sub>CS</sub>] [F7] × 255 Block  
ID Number Data (128 × 2 = 256 Bytes) Checksum (1 × 2 = 2 bytes)

Mode 1: OMNI ON, POLY  
Mode 2: OMNI ON, MONO

Mode 3: OMNI OFF, POLY  
Mode 4: OMNI OFF, MONO

O: Yes  
X: No

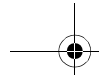

# NOTES

---

---

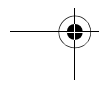
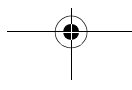
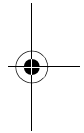
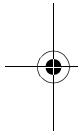



### Limited One-Year Warranty

This product is warranted by RadioShack against manufacturing defects in material and workmanship under normal use for one (1) year from the date of purchase from RadioShack company-owned stores and authorized RadioShack franchisees and dealers. EXCEPT AS PROVIDED HEREIN, RadioShack MAKES NO EXPRESS WARRANTIES AND ANY IMPLIED WARRANTIES, INCLUDING THOSE OF MERCHANTABILITY AND FITNESS FOR A PARTICULAR PURPOSE, ARE LIMITED IN DURATION TO THE DURATION OF THE WRITTEN LIMITED WARRANTIES CONTAINED HEREIN. EXCEPT AS PROVIDED HEREIN, RadioShack SHALL HAVE NO LIABILITY OR RESPONSIBILITY TO CUSTOMER OR ANY OTHER PERSON OR ENTITY WITH RESPECT TO ANY LIABILITY, LOSS OR DAMAGE CAUSED DIRECTLY OR INDIRECTLY BY USE OR PERFORMANCE OF THE PRODUCT OR ARISING OUT OF ANY BREACH OF THIS WARRANTY, INCLUDING, BUT NOT LIMITED TO, ANY DAMAGES RESULTING FROM INCONVENIENCE, LOSS OF TIME, DATA, PROPERTY, REVENUE, OR PROFIT OR ANY INDIRECT, SPECIAL, INCIDENTAL, OR CONSEQUENTIAL DAMAGES, EVEN IF RadioShack HAS BEEN ADVISED OF THE POSSIBILITY OF SUCH DAMAGES.

Some states do not allow the limitations on how long an implied warranty lasts or the exclusion of incidental or consequential damages, so the above limitations or exclusions may not apply to you.

In the event of a product defect during the warranty period, take the product and the RadioShack sales receipt as proof of purchase date to any RadioShack store. RadioShack will, at its option, unless otherwise provided by law: (a) correct the defect by product repair without charge for parts and labor; (b) replace the product with one of the same or similar design; or (c) refund the purchase price. All replaced parts and products, and products on which a refund is made, become the property of RadioShack. New or reconditioned parts and products may be used in the performance of warranty service. Repaired or replaced parts and products are warranted for the remainder of the original warranty period. You will be charged for repair or replacement of the product made after the expiration of the warranty period.

This warranty does not cover: (a) damage or failure caused by or attributable to acts of God, abuse, accident, misuse, improper or abnormal usage, failure to follow instructions, improper installation or maintenance, alteration, lightning or other incidence of excess voltage or current; (b) any repairs other than those provided by a RadioShack Authorized Service Facility; (c) consumables such as fuses or batteries; (d) cosmetic damage; (e) transportation, shipping or insurance costs; or (f) costs of product removal, installation, set-up service adjustment or reinstallation.

This warranty gives you specific legal rights, and you may also have other rights which vary from state to state.

RadioShack Customer Relations, 200 Taylor Street, 6th Floor, Fort Worth, TX 76102

*We Service What We Sell*

04/99

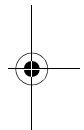
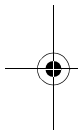

**RadioShack**  
A Division of Tandy Corporation  
Fort Worth, Texas 76102

08A99

Printed in the USA

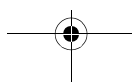
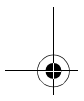

## Free Manuals Download Website

<http://myh66.com>

<http://usermanuals.us>

<http://www.somanuals.com>

<http://www.4manuals.cc>

<http://www.manual-lib.com>

<http://www.404manual.com>

<http://www.luxmanual.com>

<http://aubethermostatmanual.com>

Golf course search by state

<http://golfingnear.com>

Email search by domain

<http://emailbydomain.com>

Auto manuals search

<http://auto.somanuals.com>

TV manuals search

<http://tv.somanuals.com>