

# CRS-101

## INFRARED WIRELESS MICROPHONE SYSTEM

### INSTALLATION INSTRUCTIONS

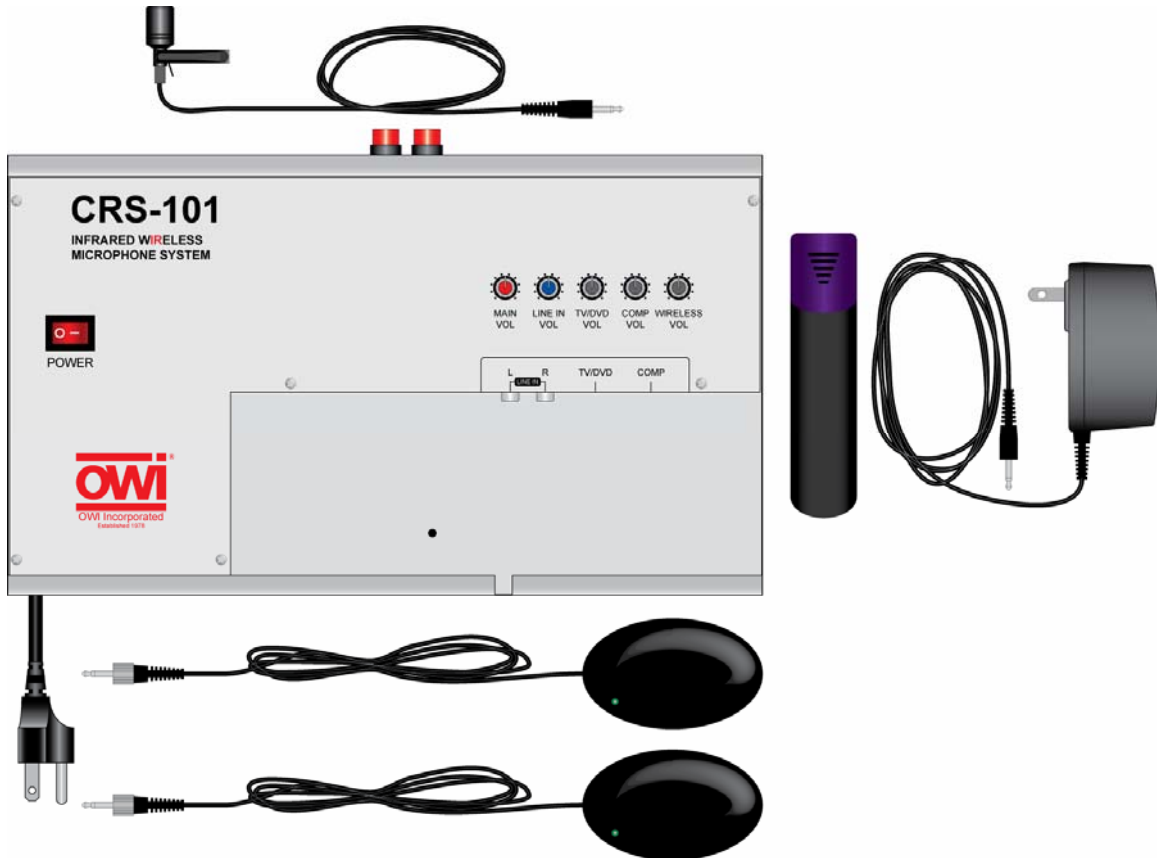



**This package contains the ff:**

- 1 each . . . . . CRS-CASE - MIXER/AMPLIFIER**
- 2 each . . . . . CRS-IRS - IR SENSORS**
- 1 each . . . . . CRS-PMIC - PENDANT MICROPHONE**
- 1 each . . . . . CRS-PENCH - PENDANT CHARGER**
- 1 each . . . . . CRS-PBAT3.7 - PENDANT MICROPHONE BATTERY**
- 1 each . . . . . CRS-LMIC - LAPEL MICROPHONE**

**Optional Accessories (Sold Separately)**

- 1 each . . . . . CRS-HSMIC - HEADSET MICROPHONE**
- 1 each . . . . . CRS-HHMIC - HANDHELD MICROPHONE**
- 1 each . . . . . CRS-HHBAT2.4 - HANDHELD MICROPHONE BATTERY**
- 1 each . . . . . CRS-HHMCS - HANDHELD MICROPHONE CHARGER**

# SAFETY INSTRUCTIONS



**CAUTION: TO REDUCE THE RISK OF ELECTRIC SHOCK,  
DO NOT REMOVE COVER (OR BACK)  
NO USER-SERVICEABLE PARTS INSIDE  
REFER SERVICING TO QUALIFIED SERVICE PERSONNEL**



The lightning flash with arrowhead symbol, within an equilateral triangle, is intended to alert the user to the presence of un-insulated "dangerous voltage" within the product's enclosure that may be of sufficient magnitude to constitute a risk of electric shock to persons.



The exclamation point within an equilateral triangle is intended to alert the user to the presence of important operating and maintenance (servicing) instructions in the literature accompanying the appliance.

**WARNING: TO REDUCE THE RISK OF FIRE OR ELECTRIC SHOCK, DO NOT EXPOSE THIS APPLIANCE TO RAIN OR MOISTURE**



**WARNING  
MOVE WITH CARE**

Read all of these instructions before operating and save instructions for later use.

1. **Read Instructions** – All the safety and operating instructions should be read before the appliance is operated.
2. **Retain Instructions** – The safety and operating instructions should be retained for future reference.
3. **Heed Warnings** – All warnings on the appliance and in the instructions should be adhered to.
4. **Follow Instructions** – All operating and use instructions should be followed.
5. **Water and Moisture** – The appliance should not be used near water – for example, near a bathtub, washbowl, kitchen sink, laundry tub, in a wet basement or near a swimming pool.
6. **Carts and Stands** – The appliance should be used only with a cart or stand that is recommended by the manufacturer. An appliance and cart combination should be moved with care. Quick stops, excessive force, and uneven surfaces may cause the appliance and cart combination to overturn.
7. **Wall or Ceiling Mounting** – The appliance should be mounted to a wall or ceiling only as recommended by the manufacturer.
8. **Ventilation** – The appliance should be situated so that its location or position does not interfere with its proper ventilation. For example, the appliance should not be situated on a bed, sofa, rug, or similar surface that may block the ventilation openings; or, placed in a built-in installation, such as a bookcase or cabinet that may impede the flow of air through the ventilation openings.
9. **Heat** – The appliance should be situated away from heat sources such as radiators, heat registers, stoves, or other appliances (including amplifiers) that produce heat.
10. **Power Sources** – The appliance should be connected to a power supply only of the type described in the operating instructions or as marked on the appliance.
11. **Grounding or Polarization** – Precautions should be taken so that the grounding or polarization means of an appliance is not defeated.
12. **Power-Cord Protection** – Power-supply cords should be routed so that they are not likely to be walked on or pinched by items placed upon or against them, paying particular attention to cords at plugs, convenience receptacles, and at the point where they exit from the appliance.
13. **Cleaning** – The appliance should be cleaned only as recommended by the manufacturer.
14. **Power Lines** – An outdoor antenna should be located away from the power lines.
15. **Nonuse Periods** – The power cord of the appliance should be unplugged from the outlet when left unused for a long period of time.
16. **Object and Liquid Entry** – Care should be taken so that objects do not fall and liquids are not spilled into the enclosure through openings.
17. **Damage Requiring Service** – The appliance should be serviced by qualified service personnel when:
  - A. The power-supply cord or the plug has been damaged; or
  - B. Objects have fallen, or liquid has spilled into the appliance; or
  - C. The appliance has been exposed to rain; or
  - D. The appliance does not appear to operate normally or exhibits a marked change in performance; or
  - E. The appliance has been dropped or the enclosure damaged.
18. **Servicing** – The user should not attempt to service the appliance beyond that described in the operating instructions. All other servicing should be referred to qualified service personnel.

## **INTRODUCTION**

Congratulations and thank you for purchasing the OWI CRS-101 Infrared Wireless Microphone System. This compact system is suitable for Classrooms, Training rooms, Conference rooms and for Public speaking.

The CRS System is an Infrared (IR) Wireless system that allows the speaker the freedom to move about the room without the restriction of a microphone cable. The two included CRS-IRS IR Sensors allow use of several options of microphones.

The CRS-CASE is an amplified audio mixer that provides inputs for infrared wireless microphones, two unbalanced mono 1/4" phone jacks and a stereo RCA line level audio source. The internal amplifier is a clean, powerful 30 watts per channel in a dual mono configuration (i.e. the system outputs the same mono signal to up to two speakers).

The CRS-HHMIC Wireless Microphone (optional) is a HAND-HELD IR WIRELESS MICROPHONE. This option can be used by the speaker for presentation or can be passed around the classroom or audience to allow questions to be clearly heard by all.

The CRS-PMIC is a combination IR Wireless PENDANT MICROPHONE AND BATTERY CHARGER. It gets clipped onto a coat or shirt pocket, or hung around the presenter's neck on a lanyard and is then used as a wireless microphone allowing for a hands free presentation.

The CRS-PMIC also features a MIC Input that connects to either of the also included CRS-LMIC LAPEL MICROPHONE or optional CRS-HSMIC HEADSET MICROPHONE. These two ultra-sensitive mics provide additional options for hands-free presentations.

The IR Wireless Microphones are similar to 'normal' mics in how they detect speech, but rather than directly connecting to a PA or other amplifier, they convert the audio signals into very strong IR pulses (invisible light pulses) that are 'seen' by the IR Sensors. The Sensors receive these pulses and output electrical pulses to the CRS-CASE, where the electrical pulses are converted back to audio signals, amplified and output to the speakers.

IR is invisible light and IR systems typically require a direct line-of-sight from the transmitter (microphone) to the receiver (IR Sensors) to operate. The CRS-101 was designed with ultra-high output IR circuitry that allows the IR pulses output from the microphones to reflect off ceiling, wall and hard floor surfaces. The IR Sensors are designed to 'see' IR from any direction, allowing uninterrupted presentations.

The CRS-101 System is easy to install and operate. Once set up, it will be ready for class every day. One important point: Just as students need sleep to re-charge, the microphone batteries need to be kept at peak performance levels as well, so it is important to re-charge the batteries before each use.

When not in use, the CRS-CASE provides a secure, locking storage space for the Pendant, Lapel and Headset Microphones, so they will never get misplaced.

The CRS-101 when combined with OWI's P5278 Bookshelf or IC5 or IC6 in-ceiling speakers help create professional easy to hear presentations of both spoken content and audio from external sources such as CD/DVD players, Computers, Cable, Satellite, VCR, etc.

OWI CRS-101 Infrared Wireless Microphone System. Always at the head of the class.

## CRS-CASE FEATURES

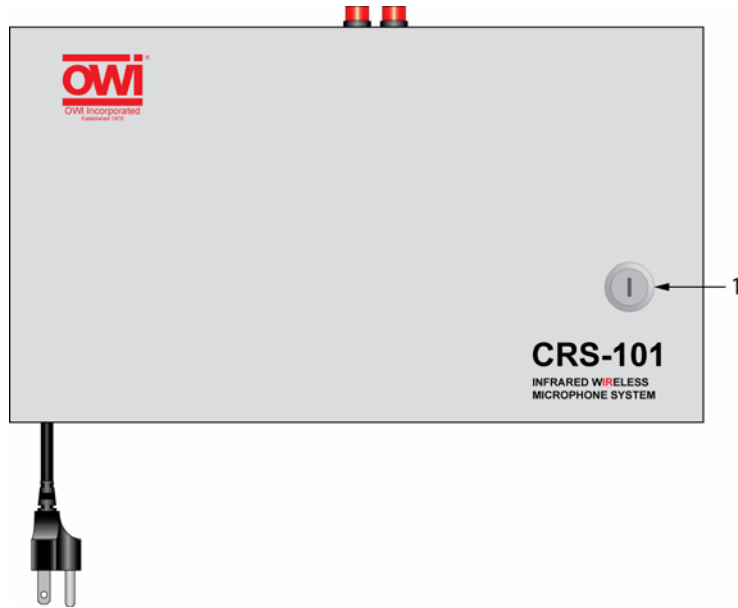

Figure 1. CRS-CASE Top View - Door Closed

### CRS-CASE CABINET FEATURES

1. **DOOR LOCK** – Locks the **CRS-CASE Door** to keep unauthorized fingers off the system controls and settings. Also allows safe storage of the **Pendant, Headset and Lapel Microphones**.

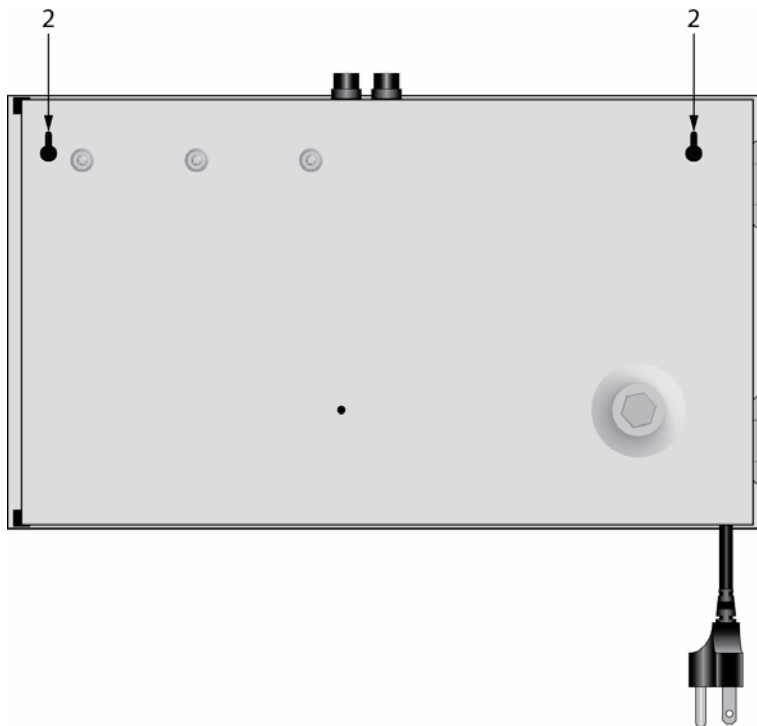

Figure 2. CRS-CASE Bottom View

2. **MOUNTING KEYHOLES** – Two screw keyholes for securing the **CRS-CASE** to a wall or shelf.

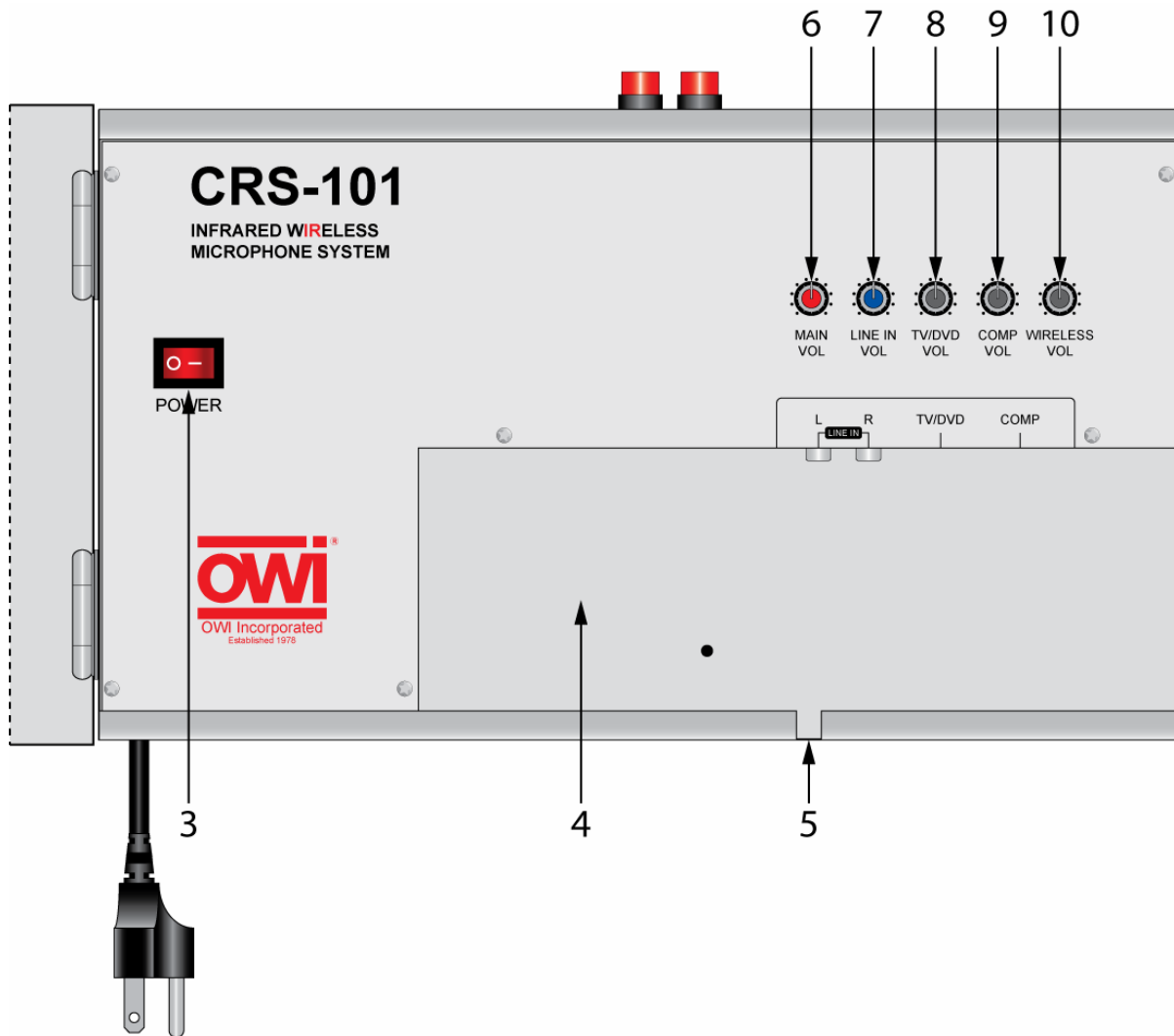

Figure 3. CRS-CASE Front Panel

### CRS-CASE FRONT PANEL FEATURES

The CRS-CASE Front Panel features all of the controls for the CRS-101 System.

3. **POWER SWITCH** – One, two position toggle switch turns the power mains to the **CRS-CASE ON/OFF**.
4. **STORAGE SPACE** – Internal compartment allows safe storage of the **Pendant, Headset and Lapel Microphones**.
5. **WIRE ACCESS** – Space in the **CRS-CASE** cabinet allows connection to an external audio source and two wired microphones, with the door closed.
6. **MAIN VOL** – One, rotary potentiometer sets the master volume output of the overall ‘mix’ of the **Line and Microphone Inputs** to the **Speakers**.
7. **LINE IN VOL** – One, rotary potentiometer sets the output level of the **Line In Source** relative to the other **Inputs**.
8. **TV/DVD VOL** – One, rotary potentiometer sets the output level of the **TV/DVD** relative to the other **Inputs**.
9. **COMP VOL** – One, rotary potentiometer sets the output level of a **COMPUter** relative to the other **Inputs**.
10. **WIRELESS VOL** – One, rotary potentiometer sets the output level of the **IR Wireless Microphones** relative to the other **Inputs**.

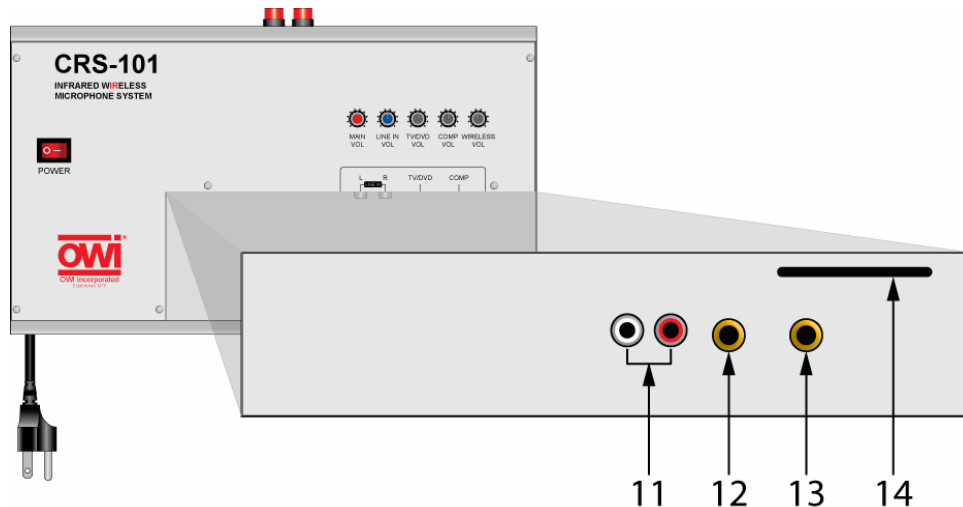

Figure 4. CRS-CASE Inside Panel

#### CRS-CASE INSIDE PANEL FEATURES

An external audio source such as a CD/DVD Player, computer, projector, cable, satellite, etc and standard unbalanced, low impedance wired microphones can be connected to the Inside Panel.

11. **LINE IN** – Two, RCA Jacks connect to the **L & R line-level audio outputs** on a stereo audio source.  
**NOTE:** The CRS will output BOTH channels to BOTH Speakers (mono). Use either channel for a mono source.
12. **TV/DVD** – One, mono 1/4" phone jack (6.33mm standard plug), connects to a DVD Player or TV/Projector, using a stereo male RCA to mono male 1/4" phone adaptor. (The TV/DVD Input can be adapted to any line level audio device. Connections may vary by device.)
13. **COMP** – One, mono 1/4" phone jack, (6.33mm standard plug), connects to a Computer using a stereo male 3.5mm mini to mono 1/4" male phone adaptor. (Can be adapted to any line level audio device. Connections may vary by device.)
14. **DOOR LOCK SLOT** – Opening in the CRS chassis secures the lock blade when door is locked.

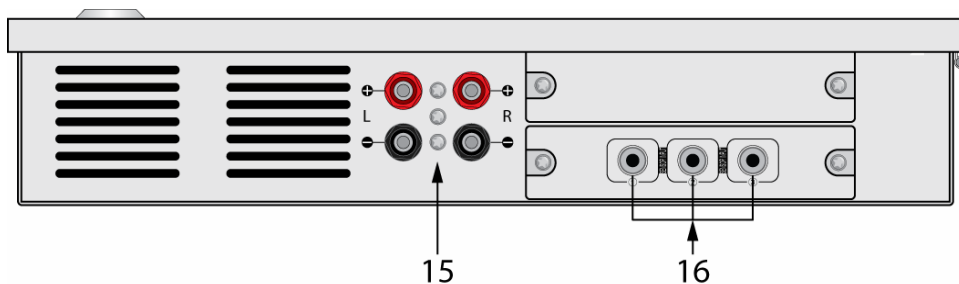
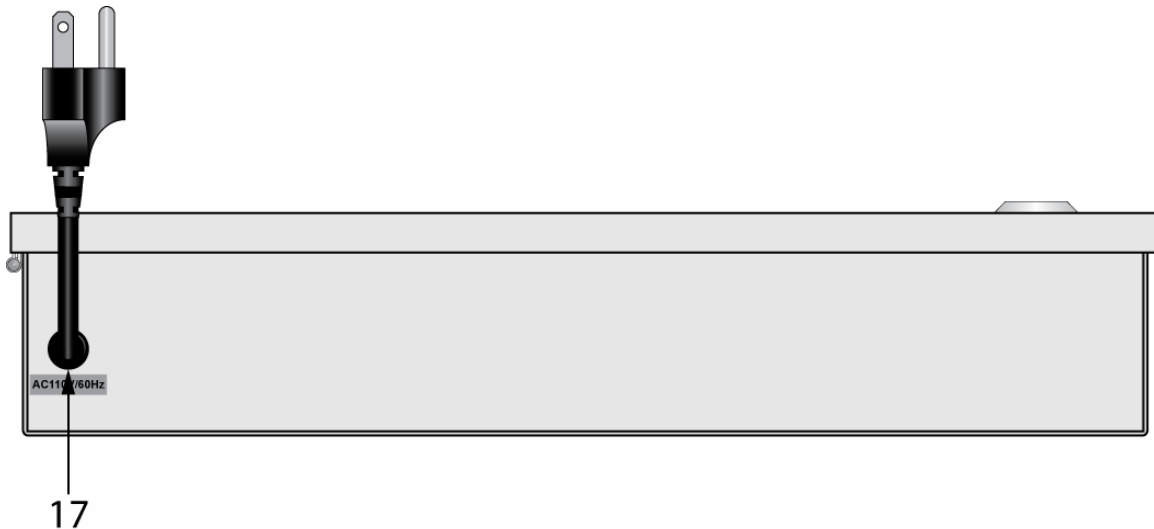

Figure 5. CRS-CASE Top Side Panel

#### CRS-CASE TOP SIDE PANEL FEATURES

The IR Sensors and Speakers get connected to the Side Panel

15. **SPEAKER TERMINALS** – Two pair, five-way binding posts, connect to classroom speakers. (OWI Models P5278, IC5 or IC6 suggested.)  
**NOTE:** Both speakers output the same audio signal, (mono). The CRS-101 is not a stereo audio system.
16. **IR SENSOR JACKS** – Three, 3.5mm mini jacks connect to the **CRS-IRS IR Sensors** for input of IR pulses (audio signals) from the **Headset, Lapel, Pendant** or **Handheld Microphones**. Use any two of the three inputs with the included IR Sensors.



**Figure 6. CRS-CASE Bottom Side Panel**

**CRS-CASE BOTTOM SIDE PANEL FEATURES**

- 17. AC POWER CORD** – One, three prong AC cord connects to a standard 110VAC/60Hz outlet. Provides AC power to the CRS-101.

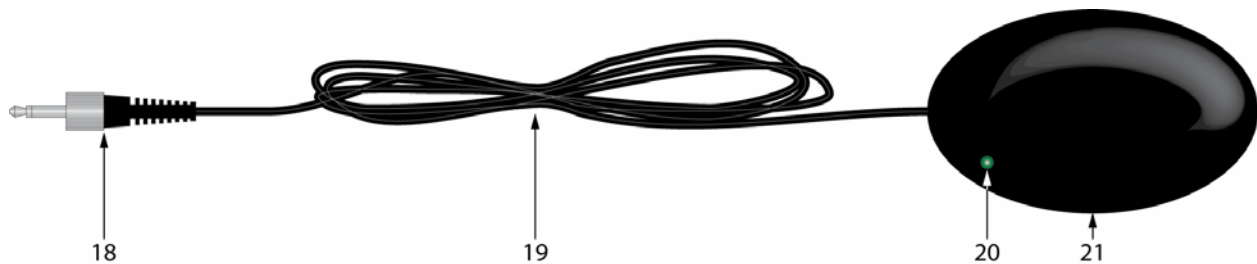

**Figure 7. CRS-IRS IR Sensor**

**CRS-IRS IR SENSOR FEATURES**

- 18. MINI PLUG** – One, 3.5mm mini plug connects to one of the three **IR Sensor Jacks** on the **CRS-CASE Side Panel**.
- 19. CABLE** – 50' cable allows the **IR Sensors** to be positioned away from the **CRS-CASE** for optimum coverage for reception of IR pulses from the **CRS IR Microphones**.
- 20. ON LED** – One, LED illuminates green to indicate that the **CRS System** is **ON** and the **IR Sensors** are connected and active.
- 21. IR SENSOR** – Senses the IR pulses output from the **CRS IR Microphones**. Must be positioned to have clear 'line-of-sight' to the classroom and any location that the **CRS Microphones** may be used. The **IR Sensor** senses IR in an omni-directional pattern (140° off-axis) and will also sense IR reflected off the ceiling, wall and hard floor surfaces. It has a range of 66 feet.





**Figure 8. CRS-HHMIC Hand Held Microphone (Optional)**

#### **CRS-HHMIC HAND HELD MICROPHONE FEATURES (Optional)**

The HHMIC Hand Held Microphone is an optional accessory that can be used for presentations or can be passed around the room for Q&A so everyone in the room can clearly hear questions from the class or audience.

**NOTE 1:** The **CRS-HHMIC** is an optional accessory and must be purchased separate from the **CRS-101**.

**NOTE 2:** The **CRS-HHMCs Charger** is also an optional accessory and is purchased separate from *both* the **CRS-101** and **CRS-HHMIC**.

**22. ON LED** – One LED illuminates green to indicate that the **microphone** is ON.

**23. ON/OFF SWITCH** – Turns the **microphone** ON/OFF.

**24. IR OUTPUT ARRAY** – High output IR LED's output audio as infrared pulses in an omni-directional pattern that are received by the **CRS-IRS IR Sensors**. The **IR Sensors** output electrical DC pulses to the **CRS-CASE** which converts them back to audio signals, amplifies them and outputs the audio to the **Speakers**.

**25. CHARGER CONTACTS** – These contacts charge the microphone's re-chargeable battery when inserted into the **CRS-HHMCs Hand Held Microphone Charger**.

**NOTE:** The **CRS-HHMCs Charger** is also an optional accessory and is purchased separate from *both* the **CRS-101** and **CRS-HHMIC**.

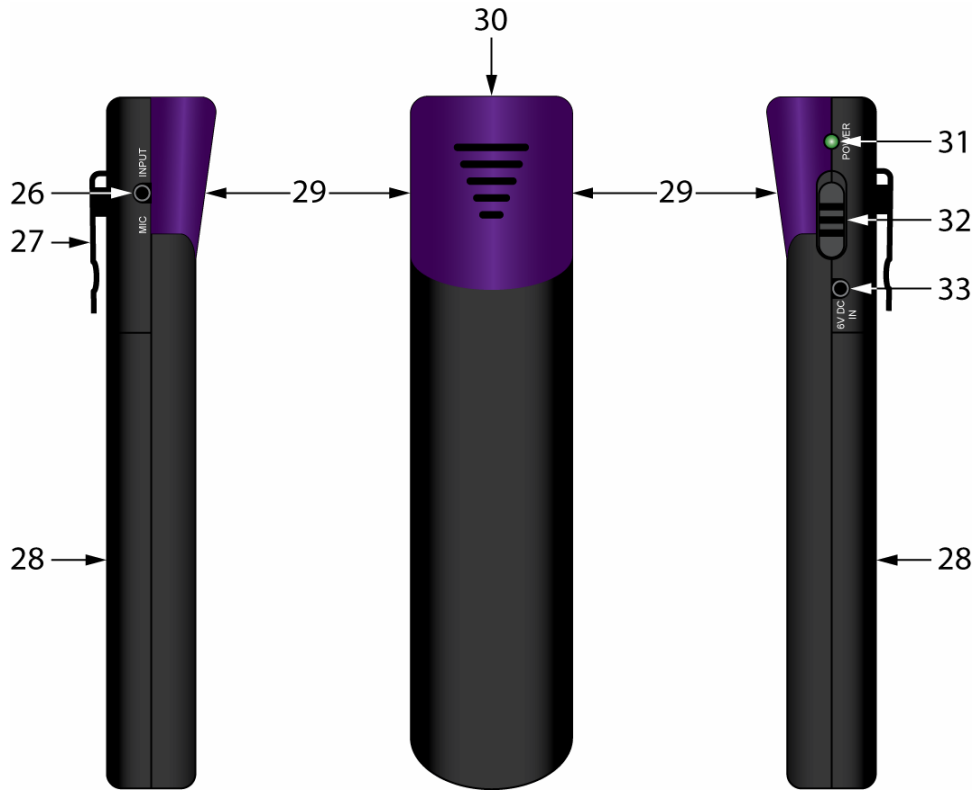

Figure 9. CRS-PMIC Pendant Mic/Charger

#### CRS-PMIC PENDANT MIC/CHARGER FEATURES

The CRS-PMIC Pendant Microphone can be used as a wireless microphone itself or as an IR Transmitter when used with the Lapel or Headset Mics.

- 26. **MIC INPUT** – One, 3.5mm mini jack connects to the mini plug on either the **CRS Lapel Mic** or **Headset Mic**. When either is connected to this jack, it overrides the **Pendant Microphone**, so only the **Lapel Mic** or **Headset Mic** will be active.
- 27. **CLIP** – Clips the **Pendant Mic** on to the included **lanyard** or a coat or shirt pocket for use as a hands free microphone.
- 28. **BATTERY DOOR** – Removable battery door for access to the AA re-chargeable Lithium battery. A regular alkaline battery can be used if necessary, but will not last as long as the Lithium (approx. 4 hours).  
**NOTE: THE PENDANT IS ALSO A CHARGER. DO NOT CONNECT THE CHARGER POWER SUPPLY WHEN USING NON-RECHARGEABLE BATTERIES!**
- 29. **IR OUTPUT ARRAY** – High output IR LED's output audio as infrared pulses in an omni-directional pattern that are received by the **CRS-IRS IR Sensors**. The **IR Sensors** output electrical DC pulses to the **CRS-CASE** which converts them back to audio signals, amplifies them and outputs the audio to the **Speakers**.
- 30. **MICROPHONE** – The **Pendant Microphone** is located at the top of the Pendant.
- 31. **ON LED** – One LED illuminates green to indicate that the microphone is ON.
- 32. **ON/OFF SWITCH** – Turns the **Pendant** ON/OFF.
- 33. **6V DC IN** – One 3.5mm mini jack connects to the included **CRS-PENCH Charger Power Supply** for re-charging the Lithium battery. (Charging Time: 3 Hours).  
**NOTE: THE PENDANT IS ALSO A CHARGER. DO NOT CONNECT THE CHARGER POWER SUPPLY WHEN USING NON-RECHARGEABLE BATTERIES!**

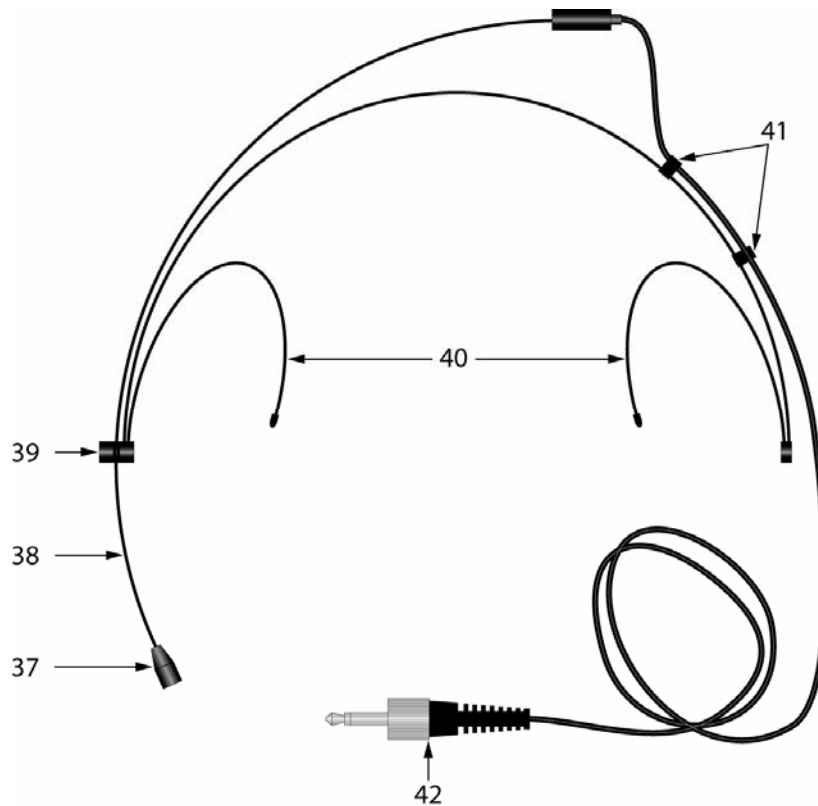

Figure 10. CRS-LMIC Lapel Mic

#### CRS-LMIC LAPEL MIC FEATURES

The CRS-LMIC Lapel Microphone is used with the Pendant Mic for inconspicuous hands-free presentations.

- 34. **MICROPHONE** – Detects audible sound such as voice. Should be positioned as close to the speaker's mouth as possible.
- 35. **LAPEL CLIP** – Attaches the **Lapel Microphone** to a jacket lapel, shirt or blouse.
- 36. **MINI PLUG** - Connects to the **MIC Input** on the **CRS-PMIC Pendant**. High output IR LED's on the **Pendant** output audio as infrared pulses in an omni-directional pattern that are received by the **CRS-IRS IR Sensors**. The IR Sensors electrical DC pulses to the **CRS-CASE** which converts them back to audio signals, amplifies them and outputs the audio to the **Speakers**.  
**NOTE:** When connected, the **Lapel Mic** overrides the **Pendant Microphone**, so only the **Lapel Mic** will be active.



**Figure 11. CRS-HSMIC Headset Mic (Optional)**

**CRS-HSMIC HEADSET MIC FEATURES (Optional)**

The CRS-HSMIC Lapel Microphone is used with the Pendant Mic and is another option for hands-free presentations.

**NOTE:** The **CRS-HSMIC** is an optional accessory and must be purchased separate from the **CRS-101**.

- 37. MICROPHONE** – Detects audible sound such as voice. Should be positioned as close to the speaker’s mouth as possible.
- 38. MIC BOOM** – Adjustable mic boom allows the microphone to be set to the optimum position. The **Boom** will extend out from the **Headset** by carefully pulling the **Boom**, *not the microphone*, from the **Boom Hinge**. The **Boom** can also be swiveled into position by carefully turning the **Boom** at the **Boom Hinge**. Push the **Wire Clips** *toward* the **Boom Hinge** to create slack in the wire *before* adjusting. Try not to flex or strain the wire connection at the end of the boom more than necessary to avoid damaging the wire.
- 39. BOOM HINGE** – Allows positioning the **microphone** as described in **Item 38** above.
- 40. EAR CLIPS** – Secures the **Headset** by wrapping the ear clips around the user’s ears.
- 41. WIRE CLIPS** – Secure the **Headset Wires** to the **Headset**.
- 42. MINI PLUG** – Connects to the **MIC Input** on the **CRS-PMIC Pendant**. High output IR LED’s on the **Pendant** output audio as infrared pulses in an omni-directional pattern that are received by the **CRS-IRS IR Sensors**. The IR Sensors output DC electrical pulses to the **CRS-CASE** which converts them back to audio signals, amplifies them and outputs the audio to the **Speakers**.  
**NOTE:** When connected the **Headset Mic** overrides the **Pendant Microphone**, so only the **Headset Mic** will be active.

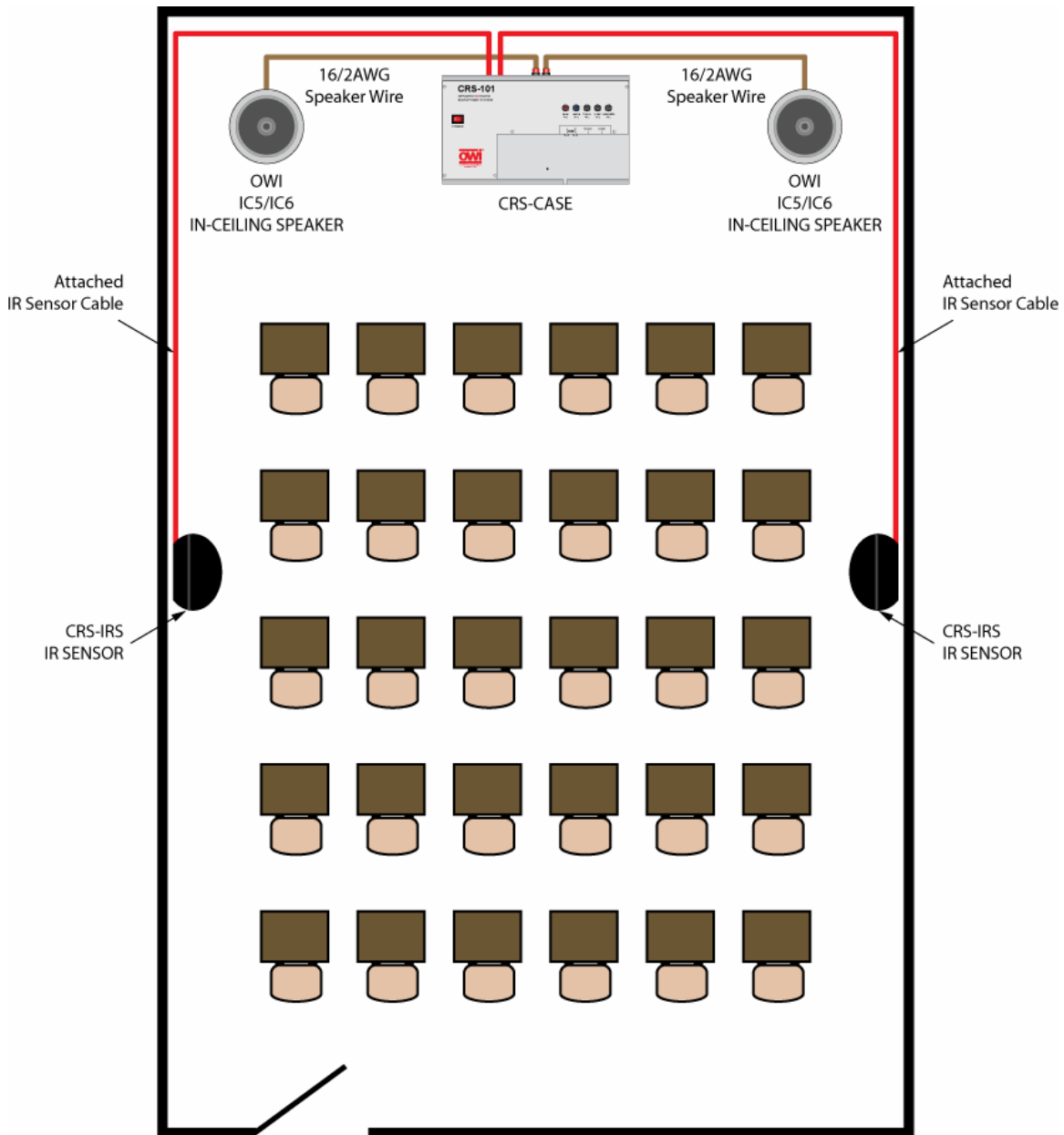

Figure 12. Typical Classroom Application

## INSTALLATION

### CRS-CASE

The CRS-CASE can be wall or shelf mounted. It should be located in a central location that allows the **IR Sensors** to be equally spread in the classroom for optimum visibility to the **microphones**. Consideration should also be given to locating the **CRS-CASE** in close proximity to any **audio source** that will be connected to the **Line In**, such as a CD/DVD Player, Projector, Computer, VCR, Cable, Satellite, etc. It should be installed in a location free from moisture or humidity. The location should also be easily accessible for operation.

### Wall Mount

The **CRS-CASE** has two screw keyholes on the **Bottom Panel** that allow it to be secured to a wall or cabinet. (**Figure 2**) Whenever possible, the screws for the keyholes should be secured to a wood panel instead of drywall to avoid having the screws work loose over time after repeated use of the CRS. If use of a wood panel is not possible or desirable, use **screw anchors** to secure the mounting screws to the drywall. There is an additional, smaller screw hole in the **CRS-CASE Storage Space** that can also be used for added stability. Leave enough space above the unit (3" minimum) for **Speaker** and **IR Sensor** connections and the **Power Cord**. **DO NOT BLOCK THE AMPLIFIER VENTS**.

1. Using two **1x6 Drywall Screws**, or similar, space the screws 12 1/8" apart, on a level line.
2. Tighten the screws until they protrude just over 1/16" (the thickness of the metal cabinet) from the wall surface.
3. Position the **CRS-CASE** so the wide opening of the **keyholes** aligns with the **screw heads**.
4. Push the **CRS-CASE** toward the wall surface and then carefully pull it down until the screws 'lock' into the narrow gap of the keyholes. Be careful to not pull the screws out of the wall.
5. Secure the **CRS-CASE** with a third screw through the **hole** in the **Storage Space**.

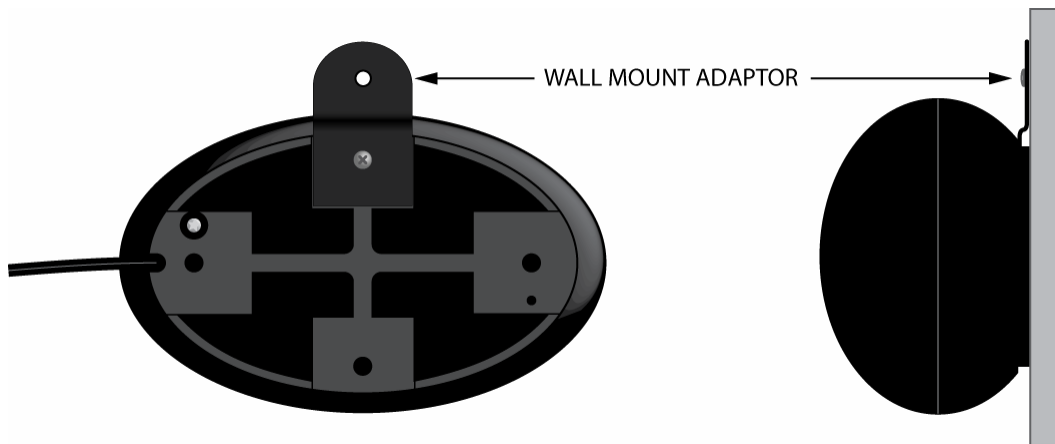
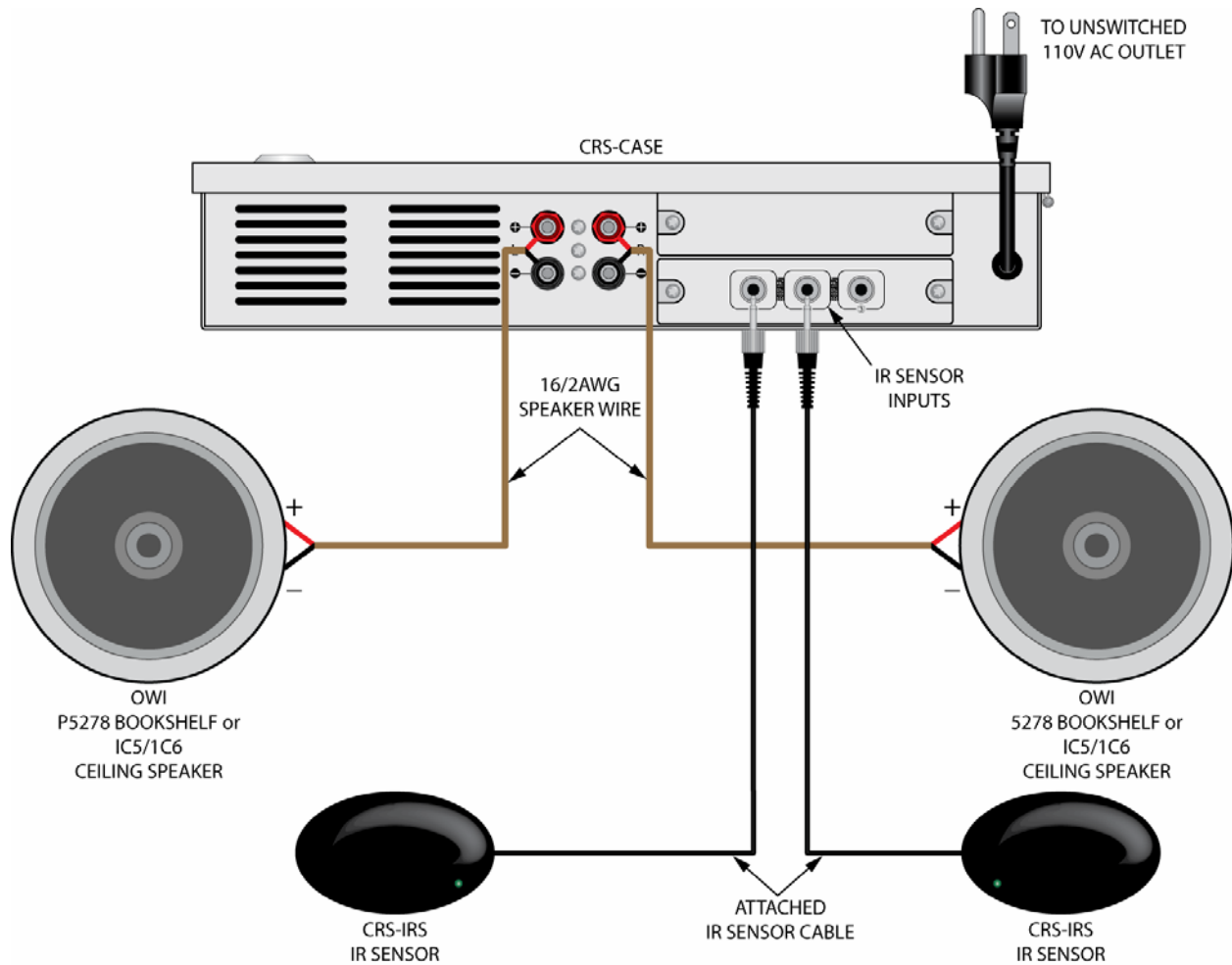

Figure 13. IR Sensor Wall Mount Adaptor

### CRS-IRS IR SENSORS

The **CRS Microphones** output **IR Pulses** that are invisible light pulses. Ideally, the **IR Sensors** should be 'line-of-sight' to the **microphones**. The microphones output very strong IR pulses that will reflect off wall, ceiling and hard floor surfaces and are then 'seen' by the sensors which enhances system performance when a microphone is moving around a classroom. The IR Sensors should be installed on wall surfaces as high up the wall as possible (in a normal ceiling room) and one should be installed on *each side* of the room for best coverage.

1. Attach the **Wall-Mount Adaptor** to the **CRS-IRS** as shown in **Figure 13**.
2. Mount the **CRS-IRS** as high on the wall as possible, but at least seven feet, so people walking past or standing in front of the sensor will not block the line-of-sight to the microphones.
3. Pull **CRS-IRS Wire** to **CRS-CASE** location.



**Figure 14. Typical CRS System Connections**

## CONNECTIONS

The CRS-101 System requires only a few simple connections and sets up in minutes. The only required connections are the **IR Sensors**, **Speakers** and **Power Cord**. Connecting an optional audio source such as a CD/DVD Player, VCR, Computer, Projector, Cable, Satellite, etc is also simple using standard RCA-audio patch cables.

### IR Sensors

1. Connect the **CRS-IRS IR Sensor mini plugs** to any two of the three **IR Sensor Inputs** on the **CRS-CASE Side Panel**.

### Speakers

1. Strip approximately  $\frac{1}{4}$ " off each lead and twist the ends so there are no loose strands that can cause shorts. The recommended speaker wire size is 14 to 16 gauge.
2. Connect to the appropriate + and – Speaker Terminal. Maintain polarity from the speaker.  
**NOTE:** Though the CRS has Left and Right Line Inputs, the Speaker Outputs are mono, so **BOTH** channels will be output from **BOTH** speakers.

### Line In

1. Connect the **left and right line level audio outputs** of an **audio source** to the **L and R Inputs** on the **CRS-CASE** using a stereo RCA-RCA patch cable with gold ends.  
**NOTE:** Though the CRS has Left and Right Inputs, the Speaker Outputs are mono, so BOTH channels will be output from BOTH speakers.
2. Feed the audio patch cable through the **Wire Access** in the **CRS-CASE Cabinet** to allow connection with the door closed.

### TV/DVD

1. Connect the **left and right line level outputs** of a **TV/Projector** or **DVD Player** using a **stereo male RCA to stereo male ¼" phone adapter**.  
**NOTE:** The **TV/DVD Input** can be adapted to any line level audio device. Connections may vary by device.

### COMP

1. Connect the **line level audio output** of a **Computer** (stereo 3.5mm mini jack typical) using a **stereo male 3.5mm mini plug to stereo male ¼" phone adapter**.  
**NOTE:** The **COMP Input** can be adapted to any line level audio device. Connections may vary by device.

### AC Power Cord

1. Connect to an unswitched 110V AC outlet.

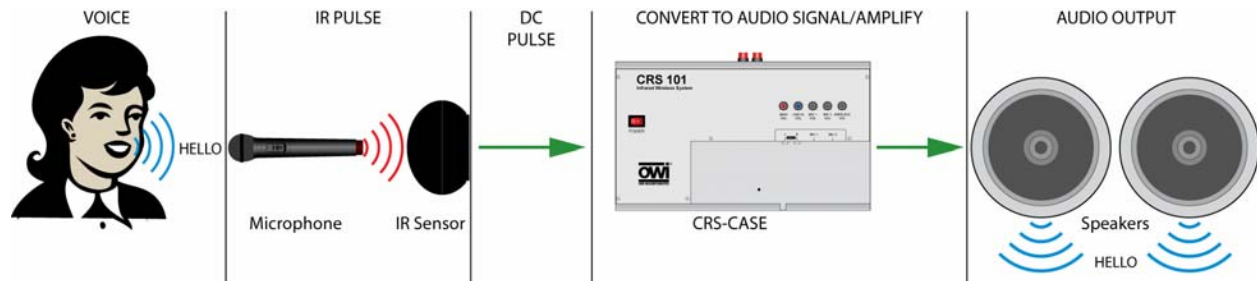

Figure 15. CRS-101 System Signal Path



## OPERATION

1. IF TURNING THE SYSTEM ON FOR THE FIRST TIME, turn the **VOL Knobs** all the way down (full counterclockwise).
2. With all system connections confirmed, press the **Power Switch** to turn the system **ON**.
3. If using the **Lapel** or **Headset Mic**, connect to the **Pendant** as shown in **Figure 16**. Be sure the **Pendant** is pointing toward the **IR Sensors** so the **IR Pulses** from the **Pendant** will be 'seen' by the **IR Sensors**.
4. Turn the **Hand Held Microphone** (or **Pendant**) **ON**.
5. Set the **MAIN VOL Knob** on the **CRS-CASE** to **12 o'clock**.
6. Slowly raise the **WIRELESS VOL** level until the output from the **Speakers** is set to the desired level. If feedback occurs (audio squeal from the speakers) lower the **WIRELESS VOL** level or move the **microphone** away from the **speaker**.
7. Repeat **Step 6** for any **audio device(s)** connected to **LINE IN**, **TV/DVD** and **COMP**, and adjust the **LINE IN**, **TV/DVD** and **COMP** levels as needed.
8. Confirm the *relative volume* of the **microphone(s)** to the **audio device(s)** and adjust if necessary. (The audio from the **microphone(s)** should be heard *above* the audio from the **device(s)** connected to **LINE IN**, **TV/DVD** and **COMP**.)
9. Adjust the **MAIN VOL** as appropriate so the **microphone(s)** and **audio device(s)** can be clearly heard throughout the entire room. (Set to the highest comfortable listening level to avoid listener fatigue.)
10. When finished using the system, turn the **microphones OFF** and turn the **CRS-CASE POWER Switch OFF**. Do not change the Volume settings. They will now be set for typical use in that room and should not need further adjustment.

## BATTERIES

Be sure to charge the batteries before each use.

**Hand Held Microphone recharge time:** approximately 4 hours.

**Pendant recharge time:** approximately 3 hours.

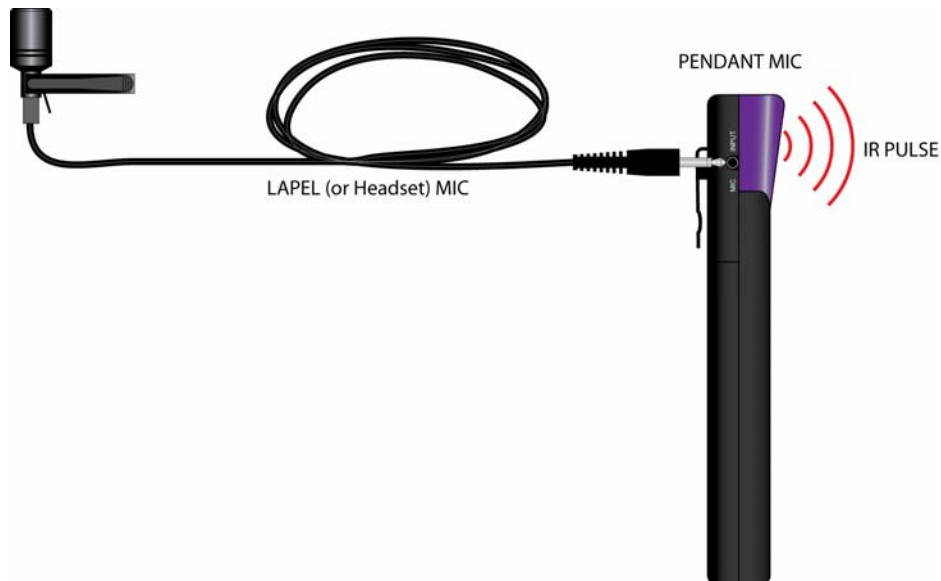

**Figure 16. Using the Lapel Mic and Pendant**

## SPECIFICATIONS

### CRS-CASE MIXER/AMPLIFIER

<b>IR Carrier Frequency</b>	2.06MHz and 2.56MHz
<b>Deviation Range</b>	± 40kHz
<b>Input Sensitivity</b>	
LINE	150mV
TV/DVD (Unbalanced Line Mono)	150mV
COMP (Unbalanced Line Mono)	150mV
<b>Signal to Noise</b>	
LINE	≥70dB
TV/DVD (Unbalanced Line Mono)	≥70dB
COMP (Unbalanced Line Mono)	≥70dB
WIRELESS MIC	≥100dB
<b>THD</b>	<0.5% @ 1KHz
<b>Frequency Response</b>	60Hz-14KHz ±3dB
<b>Output Power</b>	2-30W (Max)
<b>Voltage</b>	110V AC / 60Hz
<b>Input Impedance</b>	
LINE	47 KΩ
TV/DVD (Unbalanced Line Mono)	47 KΩ
COMP (Unbalanced Line Mono)	47 KΩ
<b>Power Consumption (max)</b>	70W
<b>Dimensions</b>	14.7W x 8.1H x 2.6D inches (372.2 x 204.2 x 65.5mm)
<b>Weight</b>	4.74lbs (2.15kg)
<b>Color</b>	Cream

### CRS-IRS IR SENSORS

<b>Carrier Frequency</b>	2.06MHz or 2.56MHz
<b>Off Axis Performance</b>	140°
<b>Range</b>	66 feet (20mm)
<b>Dimensions</b>	3.25W x 2H x 1.25D inches (82.55 x 50.8 x 31.75mm)

### **CRS-PMIC PENDANT MICROPHONE**

<b>Polar Pattern</b>	Unidirectional Electret Condenser Microphone
<b>IR Carrier Frequency</b>	2.06MHz or 2.56MHz
<b>Battery</b>	3.7V 800MAh AA Lithium
<b>Dimensions H x W x D</b>	4.7 x 1.3 x 0.7 inches (120 x 34 x 18 mm)
<b>Weight (with battery)</b>	0.13lbs (.57kg)

### **CRS-PENCH PENDANT CHARGER**

<b>Input Voltage</b>	110V AC / 60Hz
<b>Output Voltage</b>	6V DC
<b>Output Current</b>	1000mA

### **CRS-LMIC LAPEL MICROPHONE**

<b>Pattern</b>	Cardioid Directional
<b>Frequency Response</b>	55Hz-17KHz $\pm$ 2dB
<b>Sensitivity</b>	47 dB $\pm$ 2dB (1KHz, 0dB = 1v/Pa)
<b>Output Impedance</b>	2.2k $\Omega$
<b>Signal To Noise</b>	60dB
<b>Power</b>	5V DC
<b>Power Consumption</b>	0.5mA (Max)
<b>Cable Length</b>	40 inches (1.016m)
<b>Accessory</b>	Windscreen

### **CRS-HSMIC HEADSET MICROPHONE**

<b>Element</b>	Permanently Polarized Condenser
<b>Pattern</b>	Cardioid
<b>Frequency Response</b>	100Hz-17KHz
<b>Sensitivity</b>	-44dB (6.3mV) 1V @1 Pa
<b>Max Input Sound Level</b>	120dB 1KHz @1% THD
<b>Signal To Noise</b>	60dB 1KHZ @ 1 Pa

<b>Battery Current/Life</b>	0.1mA @ 5V
<b>Voltage</b>	2.5-11V DC
<b>Cable Length</b>	40 inches (1.016m)
<b>Weight</b>	0.04 lbs (0.02kg)
<b>Dimensions</b>	
Headset	6.1 inches (155 mm)
Microphone	0.20 inches (5.1 mm)
Body	6.7 inches (170 mm)
<b>Accessory</b>	HM-008 Windscreen

#### **CRS-HHMC HANDHELD MICROPHONE**

<b>Polar Pattern</b>	Uni-directional Dynamic
<b>Carrier Frequency</b>	2.06MHz and 2.56MHz
<b>Battery</b>	2.4V NiMH 2400MAh approx 7 hours (low output); 4 Hours (high output)
<b>Dimensions</b>	1.9 x 9.5 inches (50 x 240mm)
<b>Weight (with Battery)</b>	.6lbs (.25kg)
<b>Color</b>	Black

#### **CRS-HHMCS HANDHELD MICROPHONE CHARGER**

<b>Charge Mode</b>	Pulsed Fast Charge
<b>Power</b>	110V AC / 60Hz
<b>Charging Power</b>	3.8V DC @ 400mA x 2
<b>Charge Time</b>	3 hours
<b>Dimensions</b>	5.71W x 2.6D x 4.13H inches (145 x 65 x 105mm)
<b>Color</b>	Black



**17141 Kingsview Avenue  
Carson, CA 90746-1207  
Telephone: 310.515.1900  
Fax: 310.515.1606  
Web: [www.owi-inc.com](http://www.owi-inc.com)  
©2008 OWI Incorporated**

## Free Manuals Download Website

<http://myh66.com>

<http://usermanuals.us>

<http://www.somanuals.com>

<http://www.4manuals.cc>

<http://www.manual-lib.com>

<http://www.404manual.com>

<http://www.luxmanual.com>

<http://aubethermostatmanual.com>

Golf course search by state

<http://golfingnear.com>

Email search by domain

<http://emailbydomain.com>

Auto manuals search

<http://auto.somanuals.com>

TV manuals search

<http://tv.somanuals.com>